Foreword

Thank you for purchasing the YOKOGAWA Hybrid Recorder DR130, DR231 or DR241. This User's Manual contains useful information regarding the instrument's functions and operating procedures, as well as precautions that should be observed during use. To ensure proper use of the instrument, please read this manual thoroughly before operating the instrument. Keep the manual in a safe place for quick reference whenever a question arises. The following manual is provided with the instrument in addition to this manual if communication is specified.

Manual Name	Manual No.
DR130/DR231/DR232/DR241/DR242 Communication Interface	IMDR231-11E

Notes

- DARWIN is a system comprising a number of data-acquisition equipment components. In the course of system growth, new models, software and optional features are added to the family to enhance the systems expandability and flexibility. You can check the versions of your equipment and software by referring to the style number (Sn) and release number (Rn) respectively which are shown on the nameplate of the main unit.
When configuring a system, you must confirm that the style number of each component unit and software meets the following requirement:
the release number of a dedicated software package must be the same or higher than the style number of the main unit or subunit where the package is installed and where it performs control. Any equipment/software not meeting these requirements might have incompatible areas with your system configuration.
In this manual, equipment of style S8 is explained.
For unsupported functions as classified by the style number, see the next page.
- The contents of this manual are subject to change without prior notice as a result of improvements in the instrument's performance and functions.
- Every effort has been made in the preparation of this manual to ensure the accuracy of its contents. However, should you have any questions or find any errors, please contact your nearest YOKOGAWA representative as listed on the back cover of this manual.
- Copying or reproduction of all or any part of the contents of this manual without YOKOGAWA's permission is strictly prohibited.

Trademarks

MS-DOS and Windows are registered trademarks of Microsoft Corporation.
IBM is a registered trademark of International Business Machines Corporation.

Revisions

1st Edition: January 1996
2nd Edition: March 1996
3rd Edition: June 1996
4th Edition: September 1996
5th Edition: March 1997
6th Edition: September 1997
7th Edition: November 1998
8th Edition: June 2000
9th Edition: October 2000

Unsupported Functions As Classified by the Style Number

The following functions are not available for style number S1

- Computation function (including remote RJC)
- Saving and reading of measured data, computed data and set-up data (FDD function)
- Summer/Winter time
- RS-422-A/RS-485 communication module
- Report function
- Ethernet module
- Measurement of active power and apparent power on ch3 to ch6 for power monitor modules
- Flag (for /M1 option)
- Group reset (for /M1 option)

The following functions are not available for style number S2

- Summer/Winter time
- RS-422-A/RS-485 communication module
- Report function
- Ethernet module
- Measurement of active power and apparent power on ch3 to ch6 for power monitor modules
- Flag (for /M1 option)
- Group reset (for /M1 option)

The following functions are not available for style number S3

- Report function
- Ethernet module
- Measurement of active power and apparent power on ch3 to ch6 for power monitor modules
- Flag (for /M1 option)
- Group reset (for /M1 option)

The following functions are not available for style number S4

- Report function
- Ethernet module
- Measurement of active power and apparent power on ch3 to ch6 for power monitor modules
- Flag (for /M1 option)
- Group reset (for /M1 option)

The following functions are not available for style number S5

- Ethernet module
- Measurement of active power and apparent power on ch3 to ch6 for power monitor modules
- Flag (for /M1 option)
- Group reset (for /M1 option)

Products with style number S5 and S6 are not sold.

Checking the Contents of the Package

Unpack the box and check the contents before operating the instrument. In case the wrong instrument or accessories have been delivered, or if some accessories are not present, or if they seem abnormal, contact the dealer from which you purchased them. Furthermore, please contact a Yokogawa representative to order any of parts as follows.

Main Unit DR130/DR231/DR241

Check that the model and suffix code given on the name plate are according to your order.

Model and Suffix Codes

Model	Suffix Code	Description
DR130	Hybrid recorder, portable model
DR231	Hybrid recorder, desktop model
DR241	Hybrid recorder, panel-mounted model
Memory	-0	No memory
	-1	3.5inch floppy disk drive
Software	0	Without data acquisition software
	2	With data acquisition software
Input Channel	-1	10ch
	-2	20ch
	-3	30ch (for DR231/DR241 only)
Input Type	1	Universal input, screw terminal
	2	Universal input, clamp terminal
	3	DCV/TC/DI input, screw terminal
	4	DCV/TC/DI input, clamp terminal
Power Supply	-1	100-240VAC
	-2	12-28VDC (for DR241 only)
Power Cord	D	3-pin inlet w/UL, CSA cable* (Part No. A1006WD)
	F	3-pin inlet w/VDE cable* (Part No. A1009WD)
	R	3-pin inlet w/SAA cable* (Part No. A1024WD)
	S	3-pin inlet w/BS cable* (Part No. A1023WD)
	W	3-pin inlet with screw conversion terminal**
	Y	3-pin inlet with screw conversion terminal**
		* For DR130/DR231 only
		** For DR241 only
Options	/M1 ..	Mathematical Func.
	/M3 ..	Report Func.
	/C1 ...	GP-IB interface
	/C2 ...	RS-232-C interface (/C1, /C2, /C3, and /C7 cannot be specified together)
	/C3 ...	RS-422-A/RS-485 interface (/C1, /C2, /C3, and /C7 cannot be specified together)
	/C7 ...	Ethernet interface (/C1, /C2, /C3, and /C7 cannot be specified together)
	/A4 ...	Alarm module (10 make contacts)
	/R1 ...	DI/DO interface
	/H1 ...	Internal illumination (for DR231/DR241 only)
	/H5 ...	Carrying handle (for DR231 only)
	/D2 ...	deg F Display
	/L1 ...	Summer/winter time
	/N7 ...	Power Monitor module (single phase use)
/N8 ...	Power Monitor module (three phase use)	
/P6 ...	DC Power supply (for DR130/DR231 only)	

NO. (Instrument Number), Style number (equipment) and Release number (software package)

Please refer to these numbers when contacting the dealer.

Modules

Check that the model code given on the name plate is according to your order. Note that the input modules at the DR130/DR231/DR241 are fixed and cannot be moved.

Model Codes

Description

10-channel universal input module, screw terminal
20-channel universal input module, screw terminal
30-channel universal input module, screw terminal

10-channel universal input module, clamp terminal
20-channel universal input module, clamp terminal
30-channel universal input module, clamp terminal

10-channel DCV/TC/DI input module, screw terminal
20-channel DCV/TC/DI input module, screw terminal
30-channel DCV/TC/DI input module, screw terminal

10-channel DCV/TC/DI input module, clamp terminal
20-channel DCV/TC/DI input module, clamp terminal
30-channel DCV/TC/DI input module, clamp terminal

Power monitor module, single-phase use
Power monitor module, three-phase use

Optional Modules

Check that the model code given on the name plate is according to your order. Note that the modules at the rear of the main unit are fixed and cannot be moved.

Model Codes

Description

DI/DO module, screw terminal

Alarm module (10 make contacts), screw terminal

GP-IB module
RS-232-C module, D-sub terminal
RS-422-A/RS-485 module

Standard Accessories

Name	Part No.	Q'ty	Presence/Absence			Description
			DR130	DR231	DR241	
1. Power cord	see page 3	1	✓	✓		
2. Fuse	A1350EF	1	✓	✓	△	Timelag 2.5A 250V, in case of DR130/231 located in fuse holder, when power supply is -1
	A1354EF	1	△	△	△	Timelag 6.3A 250V, when power supply is -2 or option /P6 is specified
3. DC power terminal connector	A1105JC	1	△	△		(only when /P6 is specified)
4. Ribbon cassette	B9627AZ	1	✓	✓	✓	10 colors
5. Chart paper	B9627AY	1		✓	✓	Recording width 250 mm, length 30 m, grid 25 mm
	B9855AY	1	✓			Recording width 150 mm, length 20 m, grid 10 mm
6. Mounting brackets	B9900CW	1 × 2			✓	
7. User's Manual	IMDR231-01E	1	✓	✓	✓	this manual
	IMDR231-11E	1	△	△	△	Communication Interface manual (only when /C1, /C2, /C3, or /C7 are specified)
	IMDP12013-61E		△	△	△	Data conversion software manual (comes with models with whose software code is "2")
8. Data acquisition software DAQ 32	DP120-13	1	△	△	△	Software compatible with Windows 95/98 and Windows NT (comes with models whose software code is "2")

△: Provided depending on the specifications.

1. One of these power cord types is supplied according to the instrument's suffix code

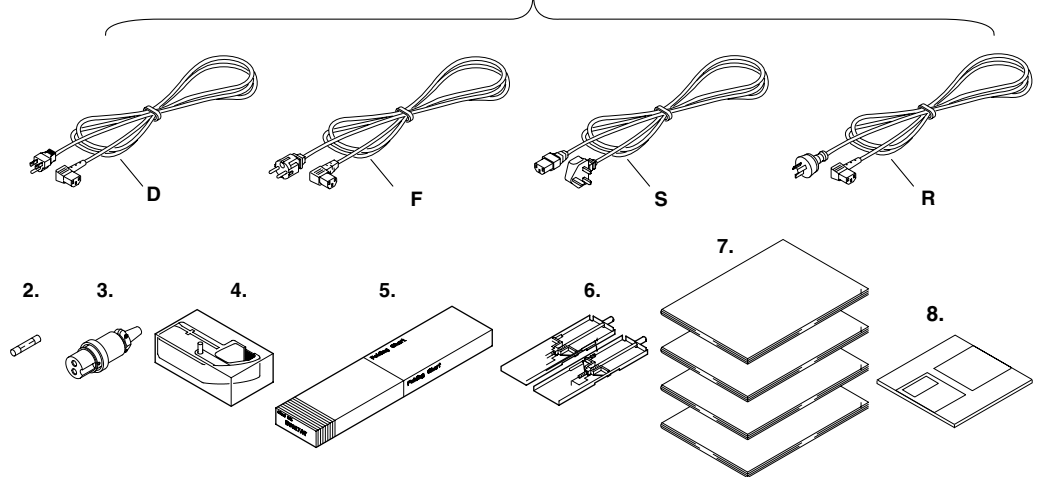

Optional Accessories

Name	Model	Description
Shunt resistance	DV300-011	10 Ω , for screw
Shunt resistance	DV300-012	10 Ω , for clamp
Shunt resistance	DV300-101	100 Ω , for screw
Shunt resistance	DV300-102	100 Ω , for clamp
Shunt resistance	DV300-251	250 Ω , for screw
Shunt resistance	DV300-252	250 Ω , for clamp
Rack mount kit	DV400-013	for DR231
Rack mount kit	DV400-015	for DR130

Optional Software

Name	Model	Description
DAQ 32	DP120-13	Windows 95/98 and Windows NT
DAQ 32 Plus	DP320-13	Windows 95/98 and Windows NT

Spares







Name	Model	Min. Q'ty	Description
Ribbon cassette	B9627AZ	1	10 colors
Chart paper	B9627RY	10	Recording width 250mm length 30 m, grid 10mm (for DR231/DR241)
	B9627AY	10	Recording width 250mm length 30 m, grid 25mm (for DR231/DR241)
	B9855AY	10	Recording width 150mm length 20 m, grid 10mm (for DR130)

Safety Precautions

This instrument is an IEC safety class I instrument (provided with terminal for protective grounding).

The following general safety precautions must be observed during all phases of operation, service and repair of this instrument. If this instrument is used in a manner not specified in this manual, the protection provided by this instrument may be impaired. Also, YOKOGAWA Electric Corporation assumes no liability for the customer's failure to comply with these requirements.

The following symbols are used on this instrument.

	To avoid injury, death of personnel or damage to the instrument, the operator must refer to an explanation in the User's Manual or Service Manual.		Function grounding terminal. This terminal should not be used as a "Protective grounding terminal".
	Protective grounding terminal.		Alternating current.
			ON(power).
			OFF(power).

Make sure to comply with the following safety precautions. Noncompliance might result in injury, death of personnel or damage to the instrument.

WARNING

Power Supply

Ensure the source voltage matches the voltage of the power supply before turning ON the power.

Power Cord and Plug

To prevent an electric shock or fire, be sure to use the power cord supplied by YOKOGAWA. The main power plug must be plugged in an outlet with protective grounding terminal. Do not invalidate protection by using an extension cord without protective grounding.

Protective Grounding

Make sure to connect the protective grounding to prevent an electric shock before turning ON the power.

Necessity of Protective Grounding

Never cut off the internal or external protective grounding wire or disconnect the wiring of protective grounding terminal. Doing so poses a potential shock hazard.

Defect of Protective Grounding and Fuse

Do not operate the instrument when protective grounding or fuse might be defective.

Do not Operate in an Explosive Atmosphere

Do not operate the instrument in the presence of flammable liquids or vapors. Operation of any electrical instrument in such an environment constitutes a safety hazard.

Fuse

To prevent a fire, make sure to use fuses with specified standard (current, voltage, type). Before replacing the fuse, turn OFF the power and disconnect the power source. Do not use a different fuse or short-circuit the fuse holder.

Do not Remove any Covers

There are some areas with high voltages. Do not remove any cover if the power supply is connected. The cover should be removed by qualified personnel only.

External Connection

To ground securely, connect the protective grounding before connecting to measurement or control unit.

How to Use this Manual

This User's Manual consists of the following fourteen chapters.

Chapter	Title	Description
Chapter 1	System Configuration	Explains the position of the DR within DARWIN, its configuration, etc..
Chapter 2	Functions	Explains the functions of the DR. Operating procedures are not explained here.
Chapter 3	Installation and Wiring	Describes cautions for use, explains how to install and wire the DR, the power cord, how to switch ON/OFF the DR, how to set the date/time, explains the noise filter, etc..
Chapter 4	Setting the Monitor Mode Display	Explains the display in the monitor mode.
Chapter 5	Setting the Input Type/Recording Span/Linear Scaling	Explains the operations when setting the input type, recording span and linear scaling function.
Chapter 6	Setting the Recording Conditions	Explains the operations when setting recording conditions such as the recording mode, channels, recording interval, chart speed, recording span, and recording format.
Chapter 7	Executing Recording	Explains how to start and stop recording.
Chapter 8	Setting, Displaying and Recording Alarms	Explains how to set an alarm and what to do when an alarm occurs.
Chapter 9	Event/Action Function and Other Functions	Explains how to operate the event/action function, how to copy recording information, how to reset alarms, how to reset the timer, how to use the key-lock, and how to use the external in-/output function.
Chapter 10	Basic Settings (SET UP)	Explains functions which usually do not need to be changed, and how to set these.
Chapter 11	Saving/Reading Measured, Computed and Set-up Data disk	Explains how to save measured data, computed data and set-up data to the internal RAM disk or floppy and read them into the instrument.
Chapter 12	Executing Computation (Available with the /M1 Model)	Explains the computation function (optional).
Chapter 13	Trouble-Shooting and Maintenance	Explains maintenance procedures, error messages and calibration procedures.
Chapter 14	Specifications	Explains specifications for all features of DR.
Index		Gives the index in main menu and alphabetic order.

Conventions Used in this Manual

Used Symbols

The following symbol marks are used to attract the operator's attention.



Affixed to the DR130/231/241, indicating that for safety, the operator should refer to the appropriate User's Manual. For a list of the User's Manuals, refer to page 1.

WARNING

Describes precautions that should be observed to prevent the danger of injury or death to the user.

CAUTION

Describes precautions that should be observed to prevent damage to the DR130/231/241.

Note

Provides information that is important for proper operation of the DR130/231/241.

Relevant Keys

Indicates the relevant panel keys and indicators to carry out the operation.

Operating Procedure

The procedure is explained by a flow diagram. For the meaning of each operation, refer to the example below. The operating procedures are given with the assumption that you are not familiar with the operation. Thus, it may not be necessary to carry out all the steps when changing settings.

Explanation

Describes settings and restrictions relating to the operation.

Contents

Foreword	1
Checking the Contents of the Package	3
Safety Precautions	7
How to Use this Manual	8
Conventions Used in this Manual	9
List of Menus and Set-up Data	14
Chapter 1 System Configuration	
1.1 About DARWIN.....	1-1
1.2 Names of Parts.....	1-2
1.3 Floppy Disk.....	1-5
Chapter 2 Functions	
2.1 Display Functions.....	2-1
2.2 Measurement Input Functions.....	2-3
2.3 Recording Functions.....	2-5
2.4 Alarm Function.....	2-14
2.5 Standard Computation Functions.....	2-17
2.6 Other Functions.....	2-18
Chapter 3 Installation and Wiring	
3.1 General Precautions for Installation.....	3-1
3.2 How to Install.....	3-2
3.3 Installing the Chart and Ribbon Cassette.....	3-6
△ 3.4 Connecting the Interface Cables.....	3-11
△ 3.5 Connecting the Signal Lines.....	3-16
△ 3.6 Connecting the Power Cable and Turning the Power ON/OFF.....	3-21
3.7 Setting the Date and Time.....	3-25
3.8 Countering Noise.....	3-26
Chapter 4 Setting the Monitor Mode Display	
4.1 Using the AUTO Mode.....	4-1
4.2 Using the MANUAL Display.....	4-4
4.3 Using the PAGE Display.....	4-6
4.4 Using the ALARM SEARCH Display.....	4-7
4.5 Using the BARGRAPH Display.....	4-9
4.6 Using the ALARM STATUS Display.....	4-10
4.7 Using the RELAY STATUS Display.....	4-11
4.8 Using the CLOCK (Date & Time) Display.....	4-13
Chapter 5 Setting the Input Type/Recording Span/Linear Scalling	
5.1 Setting the Type of Input and Recording Span.....	5-1
5.2 Setting Linear Scalling and the Recording Span.....	5-4
5.3 Configuring the Input Range and Recording Span or the Linear Scalling of a Power Monitoring Channel.....	5-6

1

2

3

4

5

6

7

8

9

10

11

12

13

14

Index

Chapter 6 Setting the Recording Conditions

6.1 Setting the Recording Mode/Engineering Unit/Recording Channel and Recording Interval 6-1

6.2 Setting the Chart Speed 6-4

6.3 Setting Recording Zones and Partially Expanded Recording 6-6

6.4 Setting Tag, Digital Printout and Manual Printout 6-8

6.5 Setting the Alarm Printout 6-10

6.6 Setting Scale Printout, List Printout and List Format 6-12

6.7 Entering Messages, Headers and Title 6-14

6.8 Setting Match Time, Moving Average, Interpolation and Groups 6-16

Chapter 7 Executing Recording

7.1 Starting Dot Printing, Digital Printing and Printing in Logging Mode 7-1

7.2 Starting Manual Printing, List Printing and Header Printing 7-2

7.3 Starting Message Printing 7-3

7.4 Printing Set-up Lists 7-4

Chapter 8 Setting Displaying and Recording Alarms

8.1 Setting Alarms and Relays (including internal switches) 8-1

8.2 Alarm Display and Printing 8-4

Chapter 9 Event/Action Function and Other Functions

9.1 Setting Event/Action Functions 9-1

9.2 Copying 9-12

9.3 Alarm Acknowledgment, Alarm Reset, Timer Reset, Computation, Keylock, and Message Printout 9-14

9.4 Clearing Alarm/Message Buffers, and Displaying and Initializing Module/Communications Information 9-16

9.5 Fail/Chart End Output, and Remote Control Signal Input 9-18

9.6 Summer/Winter Time 9-19

Chapter 10 Basic Settings (SET-UP)

10.1 Selecting Adjustment of Dot-Printing Position or Scan Interval 10-1

10.2 Setting Recording Format 10-3

10.3 Select Alarm Interval/Hysteresis/Hold/A/D Converter Integration Time/Filter 10-7

10.4 Setting Operation Mode of Relay/Internal Switch 10-9

10.5 Setting Burn-out/Reference Junction Compensation 10-12

10.6 Setting Recording Colors 10-14

10.7 Setting Key Lock 10-15

10.8 Setting FUNC/FUNC3 Menu 10-17

10.9 Setting SET/SET3 Menu 10-20

10.10 Selecting Display Update Interval, Registering SET UP Menu, and Terminating SET UP Menu .. 10-24

10.11 Selecting the temperature unit from °C or °F (option) 10-25

10.12 Working with the Report Function 10-27

Chapter 11 Saving/Reading Measured, Computed and Set-up Data

11.1 Saving Measured and Computed Data 11-1

11.2 Reading Measured and Computed Data 11-7

11.3 Saving Set-up Data 11-11

11.4 Reading Set-up Data 11-13

11.5 Copying a Data File 11-16

11.6 Copying in ASCII Format 11-18

11.7 Deleting a Data File 11-21

11.8 Displaying RAM Disk and Floppy Disk Information 11-22

11.9 Initializing the RAM Disk 11-24

11.10 Formatting a Floppy Disk 11-25

Chapter 12 Executing Computation (Available with the /M1 Model)

12.1 Overview of the Computation Function 12-1

12.2 Setting a Computation Equation 12-4

12.3 Setting a Constant 12-7

12.4 Starting/Stopping Computation 12-8

12.5 Setting Actions to be Carried out in Case of Computation Error and Setting the Time Axis for TLOG
SUM 12-12

Chapter 13 Trouble-shooting and Maintenance

13.1 Periodic Maintenance and Recommended Parts Replacement Period 13-1

13.2 Replacing the Fuse 13-2

13.3 Troubleshooting 13-4

13.4 Error Codes 13-5

13.5 Calibration 13-7

Chapter 14 Specifications

14.1 Specifications of DR130/DR231/DR241 (Style S8) 14-1

14.2 Specifications of Optional Functions 14-16

14.3 Dimensional Drawings 14-20

INDEX

1

2

3

4

5

6

7

8

9

10

11

12

13

14

Index

List of Menus and Set-up Data

The following is a list of set-up data, procedures to switch to different setting modes, and setting menu.

Measurement Condition Settings

Parameters	Procedure	Selecting menu	Reference
Input type, span, linear scaling* ¹	RANGE key	001-01:VOLT/2V	Chapter 5
Units	SET key* ²	SET=UNIT	Section 6.1
Moving average	Press the SET key for about three seconds* ²	SET=MOVE AVE	Section 6.8
Measurement cycle* ¹	Turn ON power while pressing the DISP key	SET UP= SCAN INTVL	Section 10.1
A/D integration time* ¹	Turn ON power while pressing the DISP key	SET UP=A/D INTG	Section 10.3
Filter* ¹	Turn ON power while pressing the DISP key	SET UP=FILTER	Section 10.3

*1: Make sure that the total number of setting changes, including calibrations, does not surpass 100000.

*2: Procedure varies according to the menu configuration of the SET key (see section 10.9).

Chart Speed Settings

Parameters	Procedure	Selecting menu	Reference
Chart speed 1	CHART key	CHART	Section 6.2
Chart speed 2	Press the SET key for about three seconds*	SET=CHART2	Section 6.2

*: Procedure varies according to the menu configuration of the SET key (see section 10.9).

Recording Settings

Parameters	Procedure	Selecting menu	Reference
Logging/Analog trend switch, dot-printing cycle	SET key*	SET=SYSTEM	Section 6.1
Recording channel	SET key*	SET=TREND	Section 6.1
Recording zone	Press the SET key for about three seconds*	SET=ZONE	Section 6.3
Partial compression	Press the SET key for about three seconds*	SET=PERTIAL	Section 6.3
Tag	Press the SET key for about three seconds*	SET=TAG	Section 6.4
Channel to digital print, number of rows to print	Press the SET key for about three seconds*	SET=DIGITAL PR	Section 6.4
Channel to manual print	Press the SET key for about three seconds*	SET=MANUAL PR	Section 6.4
Alarm print	Press the SET key for about three seconds*	SET=ALARM PR	Section 6.5
Channel to print scale values	Press the SET key for about three seconds*	SET=SCALE PR	Section 6.6
Channel to list print	Press the SET key for about three seconds*	SET=LIST PR	Section 6.6
Items to list print	Press the SET key for about three seconds*	SET=LIST FMT	Section 6.6
Message	Press the SET key for about three seconds*	SET=MESSAGE	Section 6.7
Header	Press the SET key for about three seconds*	SET=HEADER	Section 6.7
Title	Press the SET key for about three seconds*	SET=TITLE	Section 6.7
Interpolation	Press the SET key for about three seconds*	SET=INTERPOL	Section 6.8
Adjust dot-printing position	Turn ON power while pressing the DISP key	SET UP=PRN ADJ	Section 10.1
Recording format	Turn ON power while pressing the DISP key	SET UP=RECORD	Section 10.2
Dot-print color	Turn ON power while pressing the DISP key	SET UP=COLOR	Section 10.6

*: Procedure varies according to the menu configuration of the SET key (see section 10.9).

Display Settings

Parameters	Procedure	Selecting menu	Reference
Switch display	DISP key and MODE key	-----	Chapter 4
Display update interval	Turn ON power while pressing the DISP key	SET UP=DISPLAY	Section 10.10

Alarm Settings

Parameters	Procedure	Selecting menu	Reference
Alarm, alarm output relay	ALARM key	001-01:1/OFF	Section 8.1
Alarm interval/hysteresis/hold	Turn ON power while pressing the DISP key	SET UP=ALARM	Section 10.3
Execute alarm acknowledge	FUNC key*	ALARM ACK	Section 9.3
Reset alarm	FUNC key*	ALARM RST	Section 9.3
Clear alarm buffer	Press the FUNC key for about three seconds*	ALM BUF CLEAR	Section 9.4

*: Procedure varies according to the menu configuration of the FUNC key (see section 10.8).

Computation Settings

Parameters	Procedure	Selecting menu	Reference
Computation equation	SET key*	SET=MATH	Section 12.2
Constant	SET key*	SET=CONST	Section 12.3
Perform computation	FUNC key**	MATH START	Section 12.4
Clear measured data and perform computation	FUNC key**	MATH CLR START	Section 12.4
Stop computation	FUNC key**	MATH STOP	Section 12.4
Clear incomplete measurement status	FUNC key**	MATH ACK	Section 12.4
Handling of computation error/time axis setting of TLOG SUM	Turn ON power while pressing the DISP key	SET UP=MATH	Section 12.5

*: Procedure varies according to the menu configuration of the SET key (see section 10.9).

** : Procedure varies according to the menu configuration of the FUNC key (see section 10.8).

Settings for Saving/Loading Measured/Setup Data (Floppy Disk)

Parameters	Procedure	Selecting menu	Reference
Save/Load measured data	SET key*	SET=MEMORY	Section 11.1, 11.2
Save/Load set-up data of SET mode	SET key*	SET=FLOPPY	Section 11.3, 11.4
Copy measured data between built-in RAM disk and floppy disk	SET key*	SET=MEMORY	Section 11.5
Convert data and copy	SET key*	SET=MEMORY	Section 11.6
Initialize built-in RAM disk	SET key*	SET=MEMORY	Section 11.9
Initialize floppy disk	SET key*	SET=MEMORY	Section 11.10
Save/Load set-up data of SET UP mode	Turn ON power while pressing the DISP key	SET UP=FLOPPY	Section 11.3, 11.4

*: Procedure varies according to the menu configuration of the SET key (see section 10.9).

Perform Printing

Parameters	Procedure	Selecting menu	Reference
Perform manual print	PRINT key	MAN PR START	Section 7.2
Perform list print	PRINT key	LIST START	Section 7.2
Perform header print	PRINT key	HEADER START	Section 7.2
Perform message print	FUNC key*	MSG PRINT	Section 7.3
Perform setup list print	Press the FUNC key for about three seconds*	S/U LIST START	Section 7.4

*: Procedure varies according to the menu configuration of the FUNC key (see section 10.8).

Other Settings

Parameters	Procedure	Selecting menu	Reference
Timer	SET key*	SET=TIMER	Section 6.1
Event/Action	SET key*	SET=LOGIC	Section 9.1
Copy between channels	SET key*	SET=COPY	Section 9.2
Match time	Press the SET key for about three seconds*	SET=MATCH TIME	Section 6.8
Group	Press the SET key for about three seconds*	SET=GROUP	Section 6.8
Relay, internal switch operation mode	Turn ON power while pressing the DISP key	SET UP=RELAY	Section 10.4
Burnout	Turn ON power while pressing the DISP key	SET UP=BURN OUT	Section 10.5
Reference junction compensation	Turn ON power while pressing the DISP key	SET UP=RJC	Section 10.5
Key lock	Turn ON power while pressing the DISP key	SET UP=LOCK	Section 10.7
Menu configuration of FUNC key	Turn ON power while pressing the DISP key	SET UP=FUNC PARM	Section 10.8
Menu configuration of SET key	Turn ON power while pressing the DISP key	SET UP=SET PARM	Section 10.9
Report function	Turn ON power while pressing the DISP key	SET UP=REPORT	Section 10.12
Reset timer	FUNC key**	TIMER RESET	Section 9.3
Lock keys	FUNC key**	KEY LOCK ON	Section 9.3
Start report	FUNC key**	REPORT START	Section 10.12
Stop report	FUNC key**	REPORT STOP	Section 10.12
Start report print	FUNC key**	REPORT RECALL START	Section 10.12
Stop report print	FUNC key**	REPORT PRINT START	Section 10.12
Clear message buffer	Press the FUNC key for about three seconds**	MSG BUF CLEAR	Section 9.4
Display module settings	Press the FUNC key for about three seconds**	MODULE INF	Section 9.4
Display communication settings	Press the FUNC key for about three seconds**	COMM INF	Section 9.4
Initialize setting information	Press the FUNC key for about three seconds**	RAM INIT	Section 9.4

*: Procedure varies according to the menu configuration of the SET key (see section 10.9).

** : Procedure varies according to the menu configuration of the FUNC key (see section 10.8).

1.1 About DARWIN

What is DARWIN?

Created from a completely new concept that is based on modular architecture, this group of next generation data acquisition systems is called **DARWIN (Data Acquisition and Recording Windows)**.

Today many data acquisition networks are increasingly being linked together. More than ever before, large volume, high speed, accurate, easy-to-use communication functions are essential in many disciplines.

In the world of measurement and control where the number of measurement points has increased sharply, the ability to acquire information from a large number of points easily and economically is crucial. Interfacing to a personal computer allows simplified utilization of the information while improving quality and efficiency.

DARWIN is based on a unique, new concept to meet these needs. The art of measurement is revolutionized by **DARWIN** which integrates functions of conventional recording and data logging.

Most existing data acquisition equipment has been the all-in-one type in which the measurement section and display/recording section are contained in one box. While this simplifies operation on the one hand, it is difficult to adapt to changes in the measurement environment and also makes expansion difficult.

DARWIN uses a data acquisition engine and remote I/O modules which are completely separate from each other. It is an entirely new product line which quickly and flexibly copes with various restrictive conditions and changes in specifications.

Supported by a personal computer, a whole line-up can be created starting with the data acquisition systems DA series which performs data logging. For example, using a printer as the output device, the equipment becomes a hybrid recorder (DR series).

Three models are available in the DR series: the DR130, DR230 and DR240. The DR130 is a portable hybrid recorder, the DR230 is a desk-top hybrid recorder, and the DR240 is a panel-mount hybrid recorder (component type).

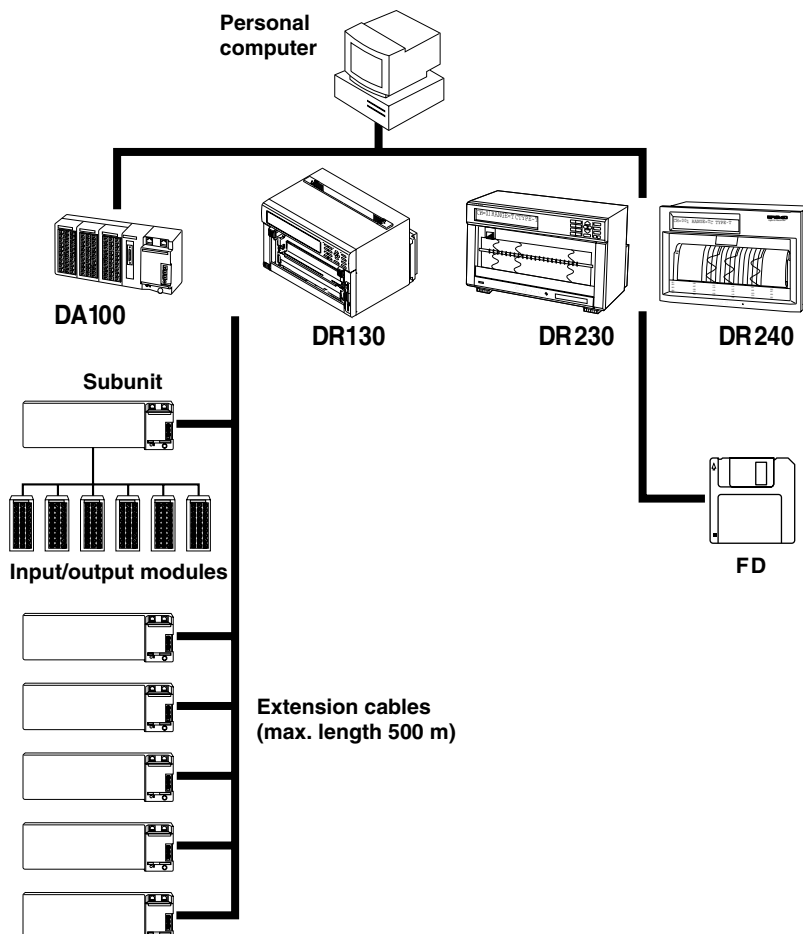

1.2 Names of Parts

DR130 Portable hybrid recorder

Front

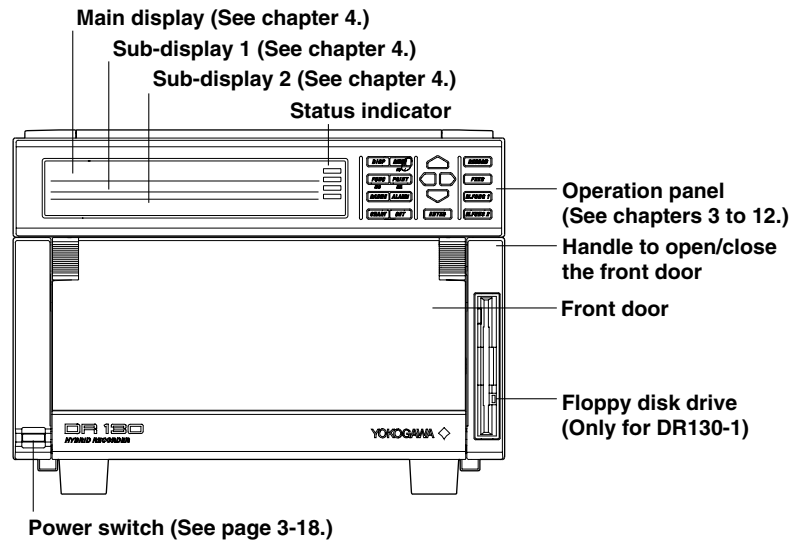

Rear (Example of DR130 with 20 input channels)
AC power supply model

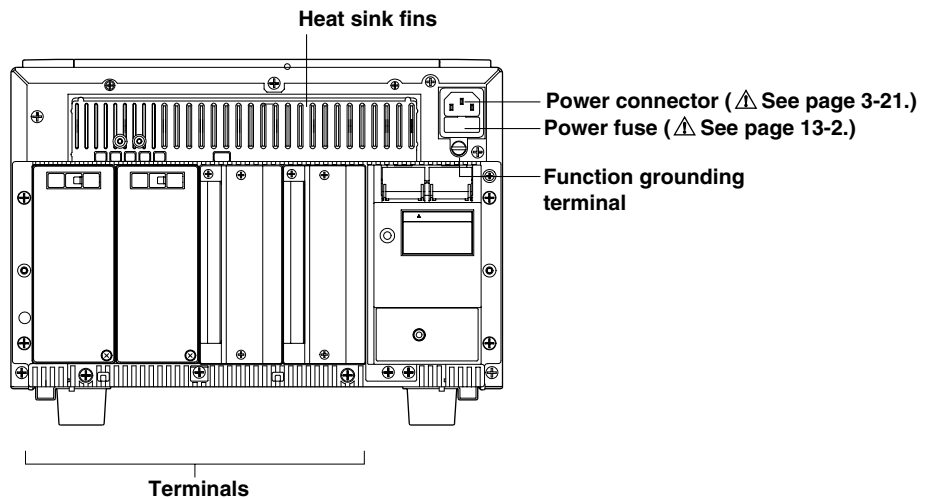

DC power supply model

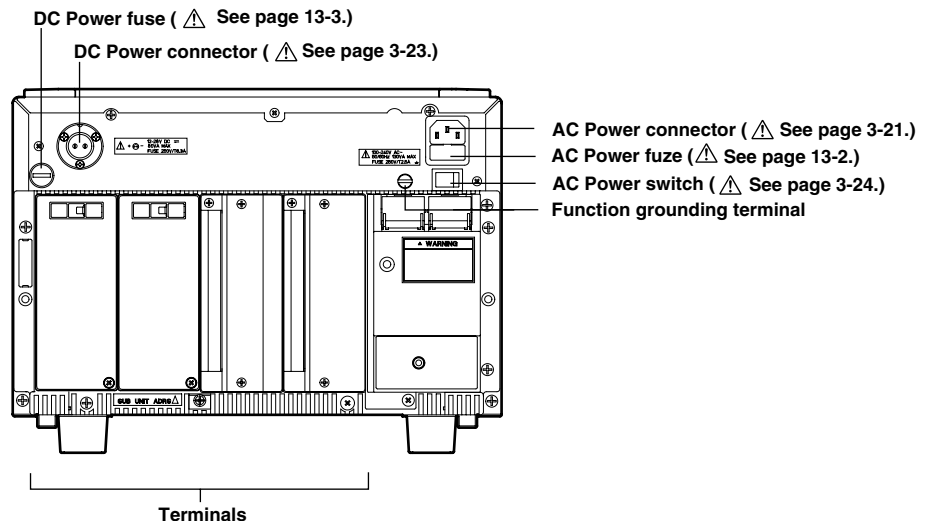

DR231 Desk-top hybrid recorder

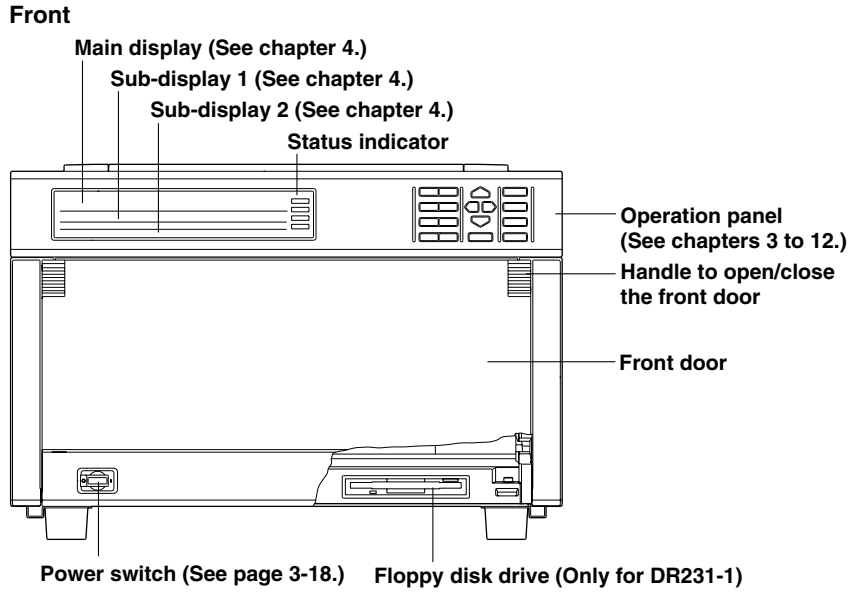

**Rear (Example of DR231 with 30 input channels)
 AC power supply model**

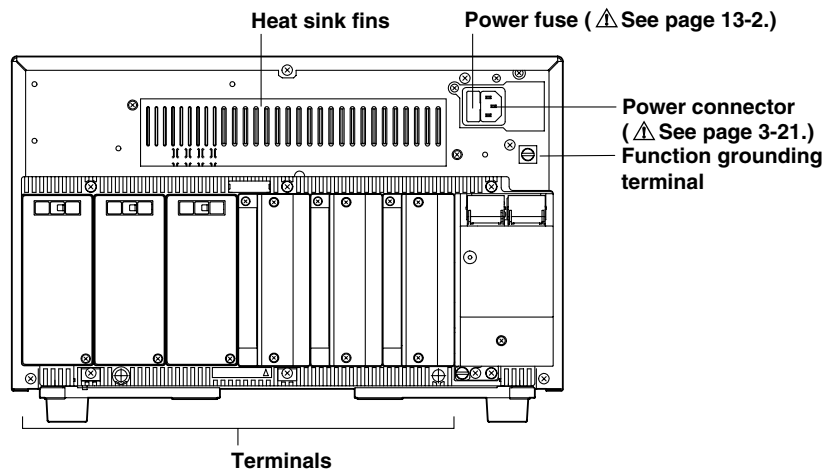

DC power supply model

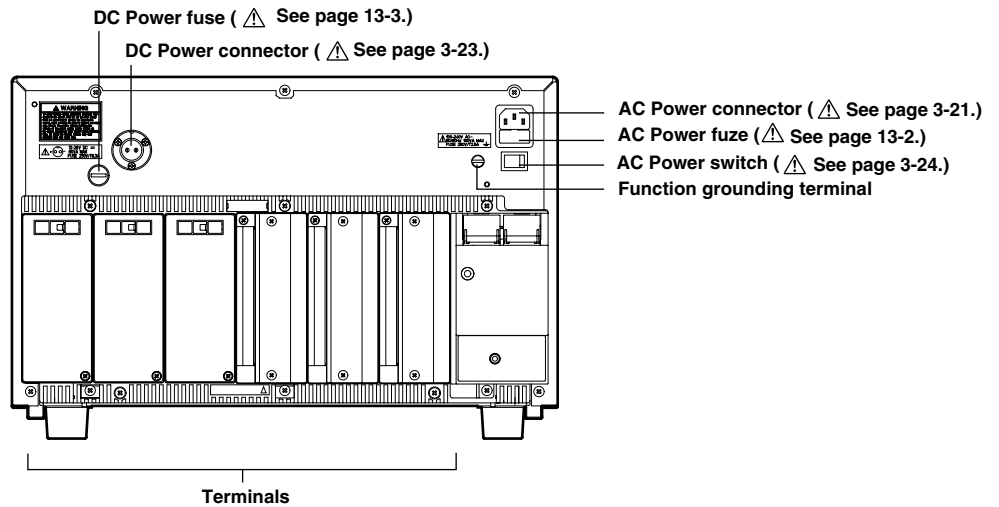

DR241 Panel-mount hybrid recorder (component type)

Front

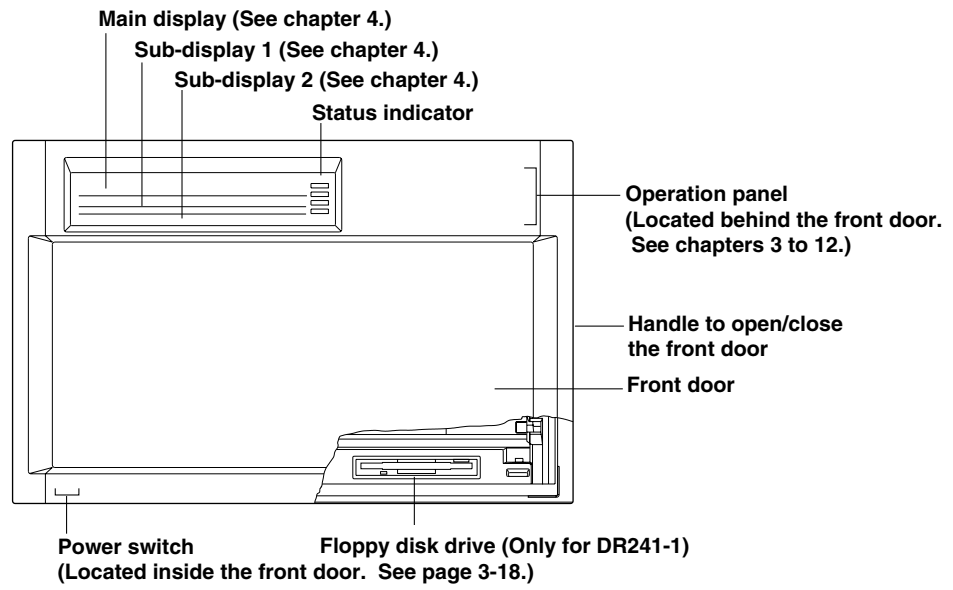

Rear (Example of DR241 with 30 input channels)

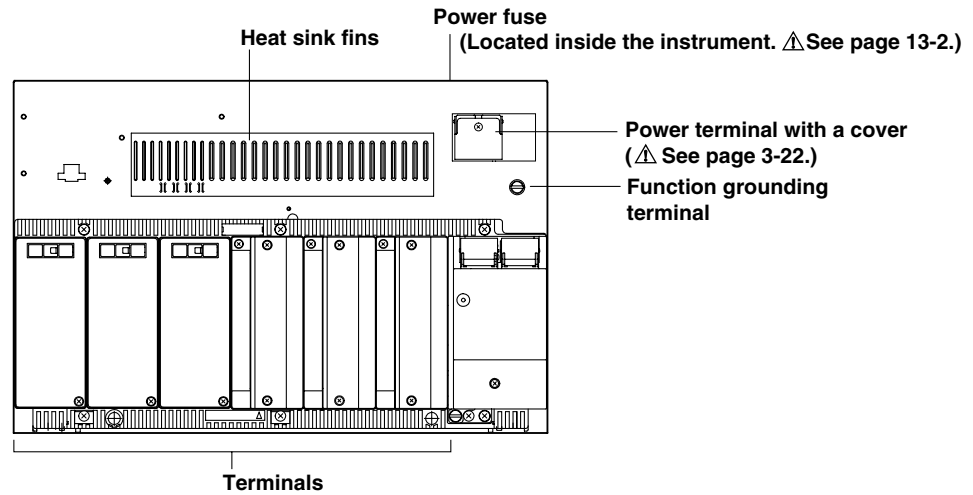

DR231 Desk-top hybrid recorder

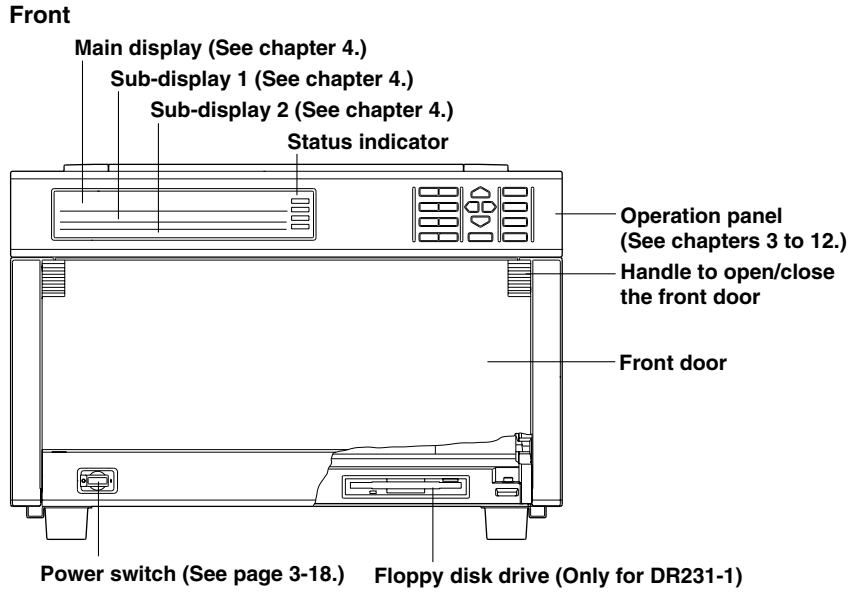

**Rear (Example of DR231 with 30 input channels)
 AC power supply model**

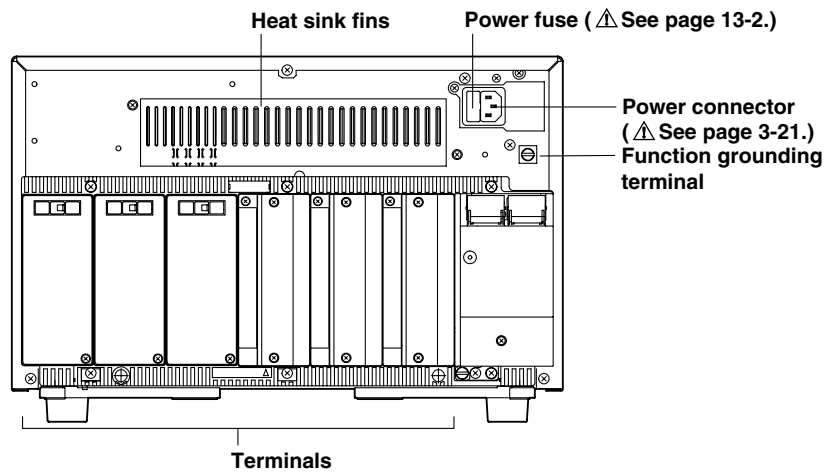

DC power supply model

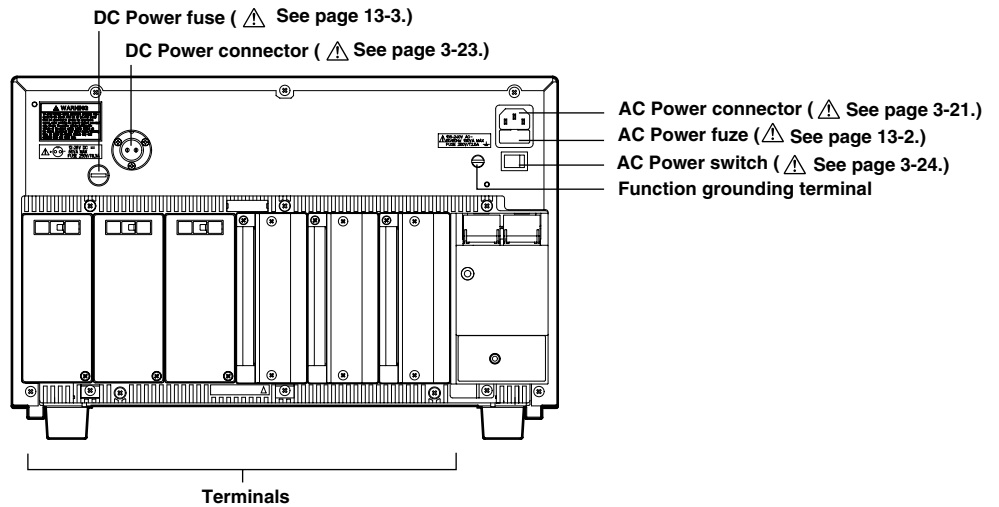

2.1 Display Functions

The inter-active front panel display consists of three rows. The first row is the main display, and the second and third row are sub-display 1 and 2 respectively.

Monitor Mode and Status Display

Monitor Mode

- **Auto Mode**

This mode can be set for the main display, sub-display 1 and sub-display 2. Measurement values of all channels will be consecutively displayed with update interval.

- **Manual Mode**

This mode can be set for the main display, sub-display 1 and sub-display 2. Measurement values of a single channel will be displayed. The display update interval is the same as the measurement interval (refer to page 2-4).

- **Page Mode**

This mode can be set for the main display. When choosing this display, the measurement values of 5 consecutive channels will be displayed as a page using also sub-display 1 and 2. The display update interval is the same as the measurement interval (refer to page 2-4).

- **Alarm Search Mode**

This mode can be set for the main display, sub-display 1 and sub-display 2. Channels at which an alarm occurred will be searched for and their measurement values displayed. The display update interval is 2 seconds.

- **Bargraph Mode**

This mode can be set for sub-display 1. Measurement values which are shown on the main display will be shown as a bargraph. The display update interval is the same as the interval of the main display.

- **Alarm Status Mode**

This mode can be set for sub-display 1 and 2. The display will show per channel whether or not an alarm occurred (refer to page 2-14). On one display the alarm status of a maximum of 30 channels can be monitored (depending on the number of input channels). The display update interval is 0.5 seconds.

- **Relay Status Mode**

This mode can be set for sub-display 1 and 2. The display will show the operating status of internal switches/alarm output relays (refer to page 2-14). On one display a maximum of 30 relay statuses can be monitored. The display update interval is 1 second.

- **Clock Mode**

This mode can only be set for sub-display 2. The current date and time are shown.

- **Displaying the Selected Mode**

To the right of sub-display 1 the currently selected mode is shown for a specific display.

Status Display

Indicators at the right side of the display will light up to show that recording is in progress (refer to page 2-5), alarms are occurring (refer to page 2-14), keys are locked (refer to page 2-18) and chart needs to be replaced (refer to page 2-19).

Remote/Local Status Display

The status of remote/local control will be shown on sub-display 2. Keys cannot be operated in remote control.

Display for Setting the Type of Input, Computation and Recording Conditions

Menus for setting each of the following functions will be displayed.

- measurement input functions (refer to page 2-3)
- recording functions (refer to page 2-5)
- alarm functions (refer to page 2-14)
- computation functions (refer to page 2-17)
- event/action function, key-lock function and external in/output function (refer to page 2-18, 19)

Display for Setting Fundamental Functions

Menus for performing fundamental settings will be displayed.

2.2 Measurement Input Functions

Input Type

DC Voltage

Measurements can be done after selecting the measurement range per channel. The minimum range is 20mV, the maximum range is 50V.

Thermocouple

Measurements can be done after selecting the type of thermocouple per channel. The available types are R, S, B, K, E, J, T, L, U, N, W and KPsAU7FE.

Reference Junction Compensation (RJC) can be set to either use Internal RJC (INT) or External RJC (EXT) per channel.

Burnout function can be set OFF per channel or it can be selected in which direction the trend line will move if burnout occurs (right or left)

Resistance Temperature Detector

Measurements can be done after selecting the type of resistance temperature detector (RTD) per channel. The available 17 types are Pt100(1mA), Pt100(2mA), JPt100(1mA), JPt100(2mA), Pt50(2mA), Ni100(1mA)SAMA, Ni100(1mA)DIN, Ni120(1mA), J263*B, Cu10GE, Cu10L&N, Cu10WEED, Cu10BAILEY, Pt100 (1mA) high resolution, Pt100 (2mA) high resolution, JPt100 (1mA) high resolution and JPt100 (2mA) high resolution.

Contact Input

The type of contact input can be selected from voltage level input or contact input, and recording can be set ON or OFF per channel. In case of the voltage level input a voltage level up to 2.4V results in recording OFF, whereas a voltage level of 2.4V or more results in recording ON.

AC Voltage/Current

The effective voltage, effective current, active power, reactive power, apparent power, frequency, power factor and phase angle can be measured. The measuring range is common to all terminals. The input terminals of the module with this input mode are not consistent with a setup screen in terms of the channel number.

Skipping Input Channels

This function allows skipping measurement, recording and display of channels you are not using. Measurement, recording and display will not be done for the skipped channels.

Reference Junction Compensation (RJC)

This function is to be used when measuring temperatures using thermocouples. The voltage generated by a thermocouple depends on the temperature of the spot of measurement and the reference junction temperature. Reference junction compensation is a function which compensates the temperature at the side of the measurement instrument to 0 degrees C.

To compensate for the environmental temperature an internal circuit can be selected, or compensation by a fixed compensation voltage value (external) can be set.

Scan Interval

- The duration of time (one scan) in which the measurement of all channels is carried out, is called the scan interval.
- This interval can be set to any value from 2 to 60s, and this range is the same for the 10ch, 20ch and 30ch model.

A/D Integration Time

This instrument measures the input signal after putting it through an A/D converter. In order to minimize the noise imposed on the input signal, specific integration times exist.

The integration time can be selected from 20ms (50Hz), 16.7ms (60Hz) and 100ms (10Hz).

When "AUTO" is selected, the integration time will be automatically decided according to the 50/60Hz frequency of the power supply.

AUTO does not function if the instrument is a DC power supply model (Selecting "AUTO" will set the A/D integration time to 20 ms (50 Hz)). If you are using the instrument on a 60-Hz power supply, set the A/D integration time to 16.7 ms (60Hz).

Input Filter

A filter can be set ON/OFF to reduce normal mode noise. Effects on normal mode noise are as follows depending on the filter being ON/OFF (theoretical values).

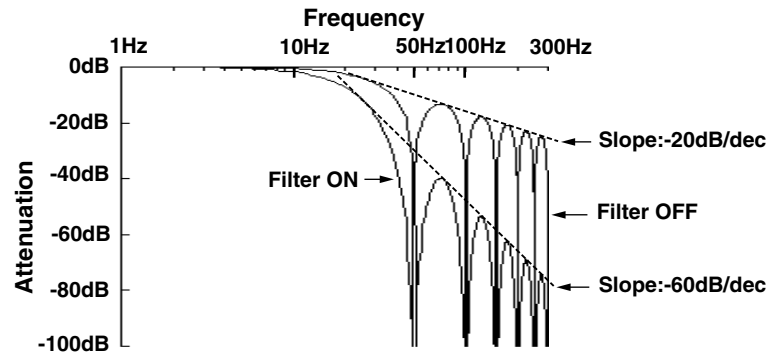

2.3 Recording Functions

Chart Speed

The speed at which the chart moves when performing trend recording can be selected from any value between 1 to 1500mm/h.

Two types of chart speeds can be set. When you are not using the Event/Action function, which will be described later on in this manual, chart speed 1 will be valid. When the Event/Action function is being used, you can select whether chart speed 1 will change to speed 2 according to the event status.

Recording Mode

Two types of recording modes are available; analog trend and logging mode. The default setting is analog trend mode.

Analog Trend Mode (refer to the next page for a recording example)

Trend Recording (Dot recording)

The recording principle is that, according to measurement data and recording conditions, the correct position on the chart will be decided and on that position the dot will be printed. Trend recording conditions consist of the following.

- chart speed
- channels to be recorded
- recording color (refer to page 2-9)
- recording interval (refer to page 2-9)
- recording span (refer to page 2-10)
- recording zone (refer to page 2-10)
- partially expanded recording (refer to page 2-11)
- interpolation function (refer to page 2-11)

Digital Printout

Measurement data will be printed as numerical values. Digital printout conditions consist of the following.

- channels to be recorded
- recording interval (refer to page 2-9)
- the number of channels to be recorded on the same line (refer to page 2-8)

Logging Mode

In this mode measurement data are only printed as numerical values. Logging recording conditions consist of the following.

- channels to be recorded
- the recording direction (vertical or horizontal)
- recording interval (refer to page 2-9)

Recording Example for DR231/DR241

The numbers in parentheses refer to reference pages.

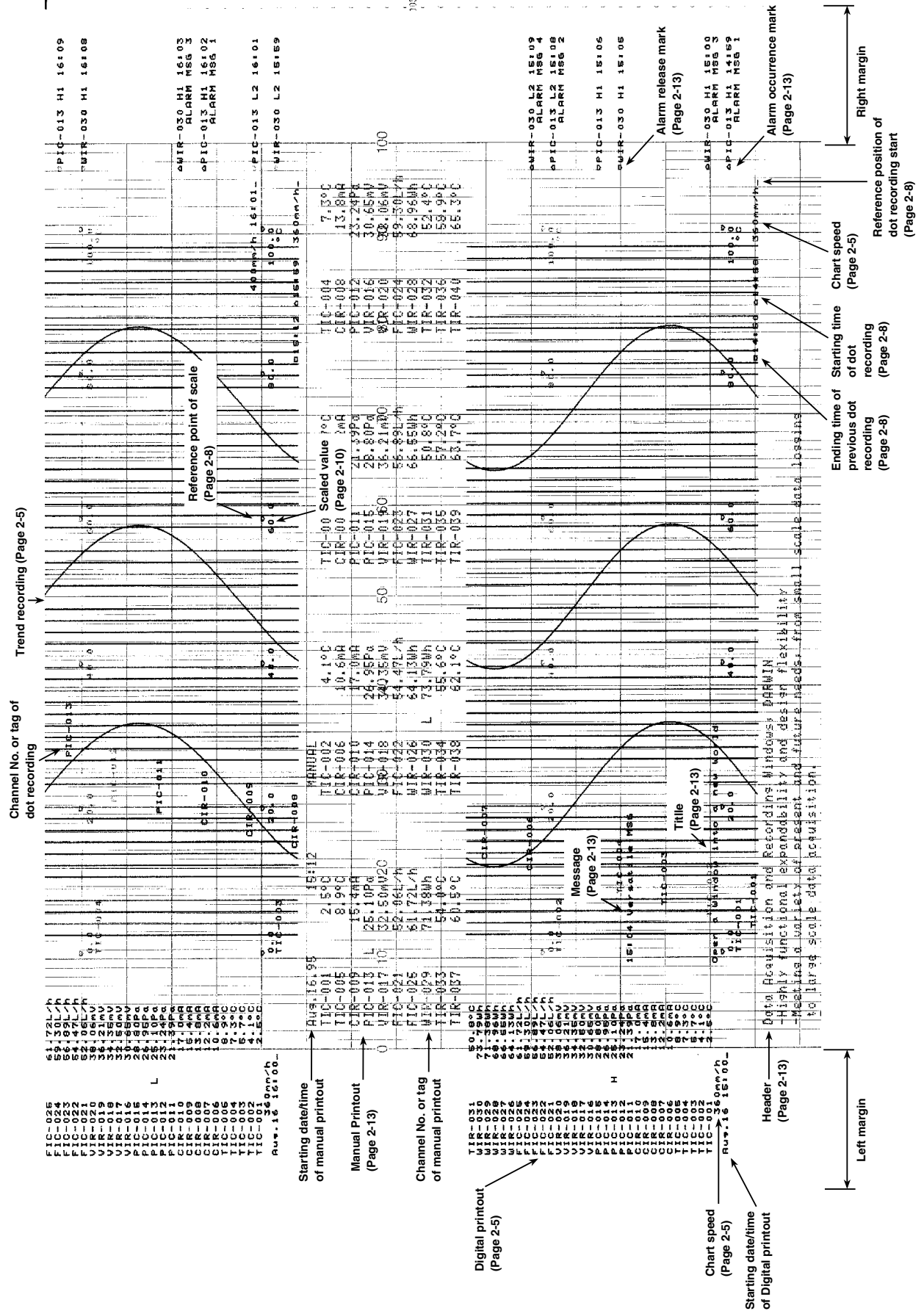

Recording Colors

The color of trend recordings can be selected per channel. The colors which can be selected are black, purple, red-purple, navy blue, red, blue, brown, green, orange and yellowish green. The recording color of the numerical values in the logging mode is purple only.

Recording Interval

The time during which one scan of trend recording or numerical printout is carried out is called the recording interval.

Recording interval for trend recording

This recording interval can be selected from AUTO or FIX.

- **AUTO**

The recording interval is decided automatically depending on the measurement (scan) interval and chart speed in order prevent the dots from overlapping. However, in cases where this calculation would render the recording interval smaller than the scan interval, the recording interval will equal the scan interval.

Recording interval = Scan interval × N

where N is an integer satisfying $N \leq 720 / (\text{scan interval} \times \text{chart speed})$. 720 is fixed.

Example: when scan interval is 2s; chart speed is 100mm/h

then $N \leq 720 / (2 \times 100) = 3.6$

The closest matching integer is 3.

Accordingly, the recording interval becomes $2 \times 3 = 6\text{s}$.

- **FIX**

Recording is carried out at an interval which is the same as the scan interval (2 to 60s) regardless of the chart speed.

Recording interval for digital printouts

This recording interval can be selected from MULTIPLE or SINGLE

- **MULTIPLE**

Six preset recording intervals (Timer 1 to 6) can be set and a recording interval can be selected per channel. The timer setting can be selected from relative and absolute.

- Relative time: Time will be counted from the point of turning the power switch ON or of resetting the timer. Each time the preset length of time is reached (and thus when time is up), recording will start.
- Absolute time: A reference time is set, and from that time recording will start at preset time intervals (each time when time is up).

- **SINGLE**

The logging interval is decided automatically depending on the chart speed and the number of columns for digital printouts.

Recording interval in logging mode

This recording interval can be selected from MULTIPLE or SINGLE

- **MULTIPLE**

Same as for the analog trend mode

- **SINGLE**

From the above mentioned six preset recording intervals, the interval set as Timer 1 will become the recording interval.

Resetting the Recording Interval (Timer Reset)

This function will reset the elapsed time of the above mentioned MULTIPLE recording interval to zero. Usually recording will start according to the recording intervals, but when you reset the elapsed time using this function, the results are the same as for time-up.

Recording Span

The maximum value and the minimum value of the measurement range are decided when setting the type of input. The difference between the minimum value and maximum value which will be recorded within this measurement range, is called the recording span. The value on the left and right side of the recording are called the left span and right span respectively.

Starting/Stopping Recording

Usually starting/stopping movement of the chart and trend recording is carried out by pressing the appropriate key on the operation panel. But movement of the chart and trend recording can also be started/stopped upon alarm occurrence or by remote control (event/action function).

Recording Method of Trend Recording

Chart movement can start by either key operation or event/action function and selected channels will thus be recorded as trend recording.

Normal Recording

Selected channels will all be recorded regardless of the below mentioned occurrence/release of alarms or group settings. Recording will start when the chart starts moving.

Trend Recording upon Alarm Occurrence

- **Trigger Recording**

All channels where an alarm occurred will be recorded. Even when the alarm is released, recording will continue.

- **Level Recording**

All channels where an alarm occurred will be recorded. When the alarm is released, recording will stop.

Group Trend Recording

Channels can be clustered in a group, and only those channels will be recorded.

Recording Zone

The recording span of measurement values on the chart is called recording zone. For each channel you can set between what locations on the chart the measurement values will be recorded.

It is possible to assign zones so that the analog trend recordings of each individual channel will not overlap. This setting is only valid for trend recordings in the analog trend mode. The default setting is the full recording width of 150mm for the DR130 or 250mm for the DR231/DR241.

The left and right boundary of the recording zone (left position and right position respectively) correspond to respectively the left and right span of the recording span.

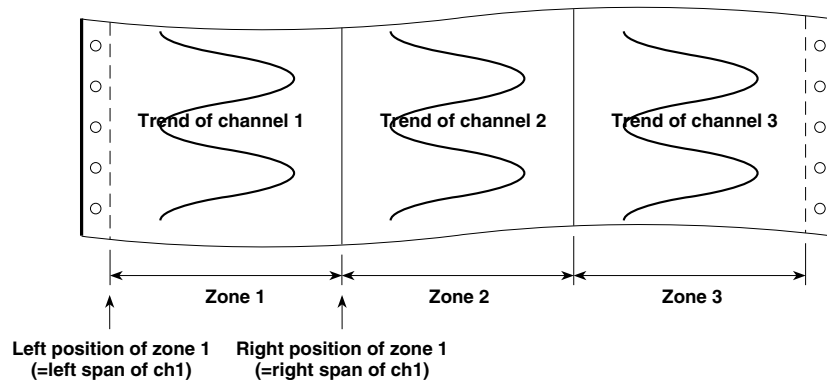

Scale Values

Scale values are used to mark the divisions of zones and three different scale format can be selected.

Partially Expanded Recording

When carrying out trend recording, partially expanded recording enables you to compress a part of the recording span in order to examine the expanded (other) part of the span in more detail. The left boundary of the recording span being 0%, and the right boundary of the recording span being 100%, a segment of the recording span can be compressed. The following example shows a situation where 25% of the recording span has been compressed. The points A, B, C, D, E and F before compression correspond to the points A', B', C', D', E' and F' in the figure after compression. The 25% left of the boundary shows -6 to 0V, whereas the 75% right of the boundary shows 0 to 6V.

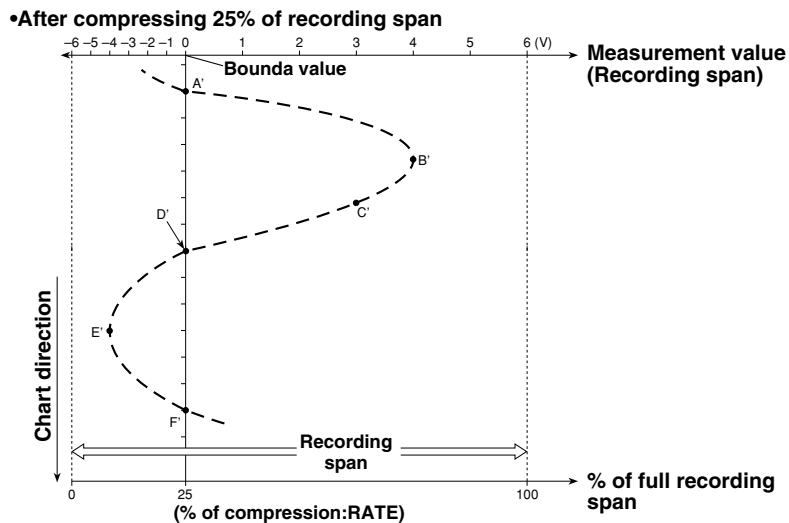
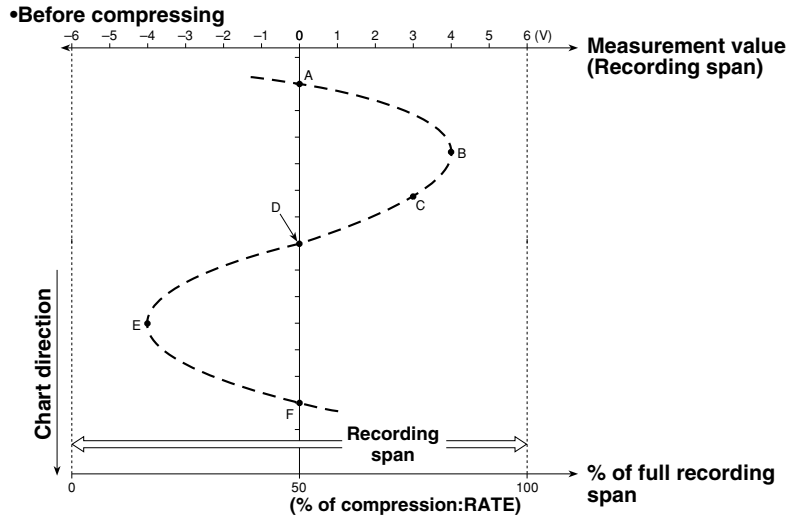

Interpolation Function

When carrying out trend recording and a measurement value differs greatly from the previous one, the track of the recording changes stepwise in the dot printing. In cases like this, interpolation will be carried out on the horizontal line to connect the two divergent trend tracks. When the horizontal lines of several channels are to be recorded on exactly the same location, only the recording color with the higher priority will be used. The priority of recording colors is black > purple > red-purple > navy blue > red > blue > brown > green > orange > yellowish green, which means that black has the highest priority. In the figure below a recording example is given of a horizontal line in the colors black, red and yellowish green. In the area where red and yellowish green overlap (labeled as a), only red dots will be recorded, and in the area where black, red and yellowish green overlap (labeled as b), only black dots will be recorded. However, at the locations where the recordings diverge after connecting a horizontal line, all recording colors will be recorded.

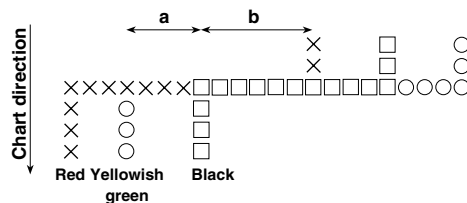

Manual Printout

One scan of measurement values of selected channels will be recorded as digital values together with the date and time. This printout can be executed by key operation or by event/action function (refer to page 2-18). Refer to page 2-6, 2-7 for a recording example.

Header Printout

For the header, you can print as many as 60 characters each on 5 lines (DR130) or as many as 80 characters each on 5 lines (DR231/241) and its recording can be executed by key operation.

Additional Printouts

While recording analog trends it is possible to have engineering units, tags, scales, alarm, title, messages, etc. printed along with the measurement values and the date/time.

- Engineering units; these will be printed in combination with the linear scaling function (refer to page 2-17)
- Channel No. or tag; a preset tag can be printed for each channel; the selection whether to print the channel No. or the tag (refer to page 2-8) can also be done
- Scale printout; values corresponding to the scales will be printed (refer to page 2-10)
- Alarm printout; alarm information (refer to page 2-16) will be printed upon occurrence (or release) of an alarm. You can also set a message to appear upon occurrence of an alarm
- Title printout; A title of up to 32 characters can be printed. Furthermore, the title can be set to be printed at regular intervals (refer to title pitch on page 2-8)
- Message printout; Recording of messages of up to 16 characters can be executed by key operation or event/action function. Time will also be printed together with the message. Up to 20 different messages can be entered.

Set-Up List Printout

Each item as described in Ch. 10 will be printed.

Match Time Function

You can preset a time when you want recording to start/stop using the event/action function (refer to page 2-18). When this time is reached, recording in the analog trend or logging mode will start/stop.

2.4 Alarm Function

This function will show an alarm on the display or generate an alarm output signal with /A4 or /R1 option when the measurement conditions of a channel exceed/fall below preset values. Up to four alarms can be set for each channel.

Type of Alarms

Six types of alarms are available, namely high limit alarm, low limit alarm, high limit on rate-of-change, low limit on rate-of-change, difference high limit and difference low limit.

Interval for Rate-of-Change Alarms

In case of high/low limit on rate-of-change alarms, variation is measured over a preset interval, and if the variation exceeds a preset value, an alarm occurs. This interval can be set and applies to all channels.

•High limit on rate-of-change

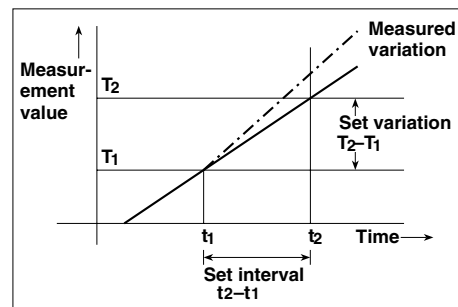

•Low limit on rate-of-change

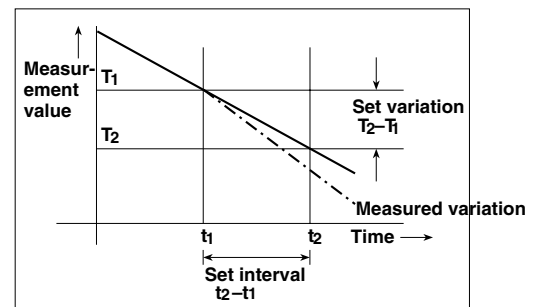

Alarm Hysteresis

You can set the width between the value of alarm occurrence and its release. This setting prevents frequent alarm occurrences/releases in an unstable environment. Hysteresis values can be set in the 0-1% percentage range of the recording span. The hysteresis setting is used for high and low limit alarms.

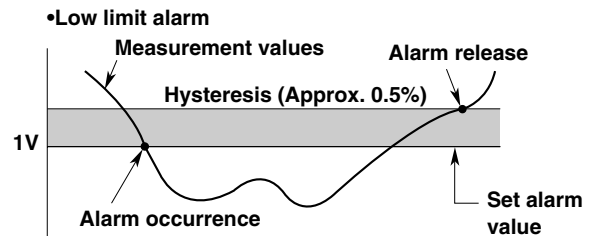
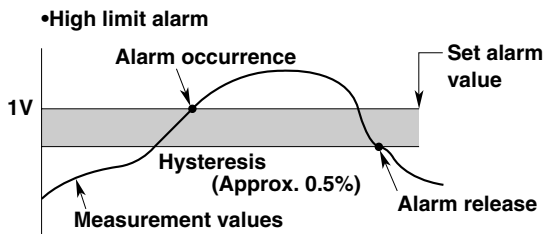

Internal Switches

Sixty internal switches are provided which can be operated upon alarm occurrences. These switches are only for internal operations and are used in combination with the event/action function (refer to page 2-18).

Alarm Output Relays

If both /A4-option and /R1-option are installed, twelve alarm output relays are provided for external output.

Operation Mode

Energizing/De-energizing Setting

The alarm output relays can be selected to be energized or de-energized on alarm occurrence. Using de-energizing, the alarm output relay will be activated when the power drops in the same way as when an alarm occurs. This setting can be done for each relay individually.

Relay contacts in case of energizing

A-contact

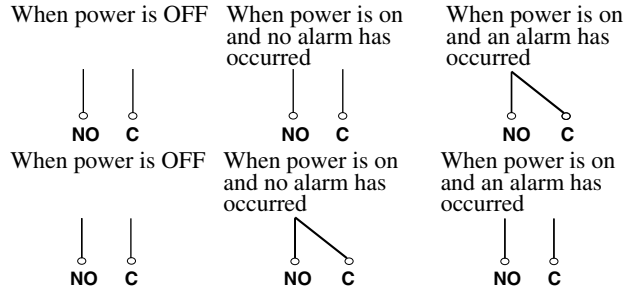

C-contact

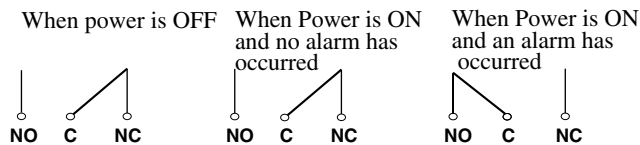

Relay contacts in case of de-energizing

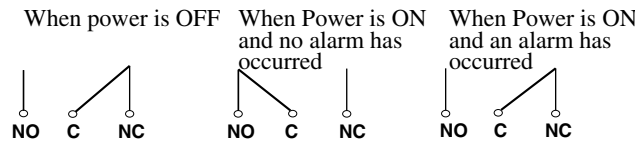

AND/OR Setting

When a group of alarms share the same internal switch or alarm output relay, you can select how the internal switches/alarm output relays will be operated.

AND: will be operated when all alarms are occurring;

OR: will be operated when at least one alarm is occurring.

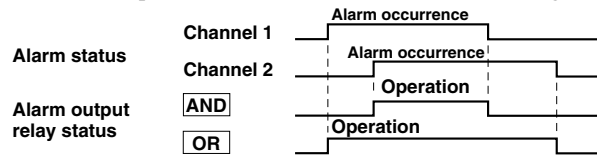

HOLD/NON-HOLD Setting

You can select whether to hold the operating status of operated internal switches or alarm output relays. This setting applies to both the internal switches and the alarm output relays.

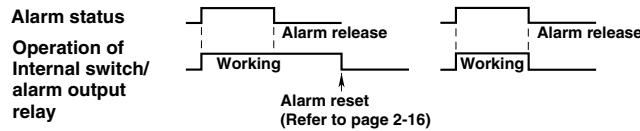

Reflashing Alarm Setting

When several alarms share the same alarm output relay, you can select this setting which results in a short de-operation of the relay when a second alarm occurs.

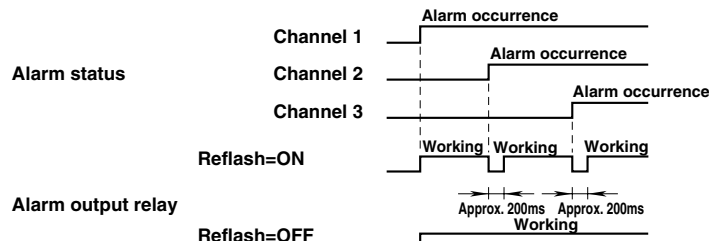

Recording Alarm Information

Analog Trend Mode

When an alarm occurs (or releases), the occurrence/release mark, message, channel No. or tag and time of occurrence/release will be printed on the right side of the chart.

Logging Mode

- If an alarm occurs, the type of alarm will be printed together with the measured value.
- If an alarm occurs (or is canceled), the alarm occurrence/cancellation mark, channel No./TAG, the type of alarm, time when the alarm occurs/cancels, and messages are printed after all the measured values.

Displaying Alarm Information

Alarm Indicator

- **“ALARM” Indicator**

When at least one alarm occurs, the “ALARM” indicator at the right of the display will light.

- **Display per Channel**

In sub-display 1 or 2, the alarm statuses of a maximum of 30 channels (according to the specifications) can be displayed (refer to page 2-1). Besides, when the measurement value of a channel where an alarm occurred is being displayed, the type of alarm will appear between the channel number and the measurement value.

Channel No.	Type of alarm	Measurement value
001	H	10.000mV

Alarm Display Hold Function

This function allows the alarm display to remain even when the alarm has already been released. This function can be selected ON or OFF and applies to all alarms. When the function is set to ON, if an alarm occurs, the alarm display flashes.

Alarm Acknowledge Function

This function only resets the display and therefore allows you to verify the current alarm status on the display. When the alarm display hold function is ON, selecting the ALARM ACK menu results the alarm display changing from flashing to lit and will turn off when the alarm is released. This setting applies to all alarms.

Alarm Reset

You can reset the internal switches and alarm output relays and the corresponding displays. The previously mentioned alarm acknowledge function has the same function as resetting the alarm display here. Resetting the internal switches and alarm output relays when the relay hold function is set to ON has the following affects and depends on the alarm status.

- when alarms occur continuously, the internal switches/alarm output relays will turn to their non-operative status for a short period but soon change into their operation status.
- when alarms are released, the internal switches/alarm output relays turn to their non-operative status.

2.5 Standard Computation Functions

Standard computations such as difference between channels and linear scaling can be set with measurement input settings. A moving average computation is also available.

Difference between Channels

This function computes the difference between the measurement values of a selected channel (=reference channel) and any other channel (=destination channel). This can be applied to each channel and the computation formula is as follows.

Result of difference between channels computation = measurement value of destination channel — measurement values of reference channel

Linear Scaling

This function changes the left and right span of the recording span to left and right scale values which are converted to a different physical quantity. This can be applied to each channel and a different engineering unit can be entered for display and printouts.

Example where voltage values are converted into linear scaling values

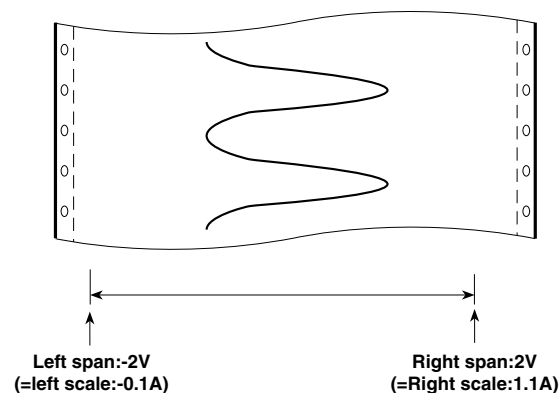

Moving Average

This function computes a moving average over a preset number (K) of measurement values. This function is useful for displaying and recording of unsteady measurement values. The computation formula is as follows.

$$D_m = (M_{m-(K-1)} + M_{m-(K-2)} + \dots + M_{m-2} + M_{m-1} + M_m) / K$$

where

- D_m : "m"th average value
- $M_{m-(K-1)}$: the measurement value of the "K-1"th measurement before the "m"th measurement
- $M_{m-(K-2)}$: the measurement value of the "K-2"th measurement before the "m"th measurement
- ⋮
- M_{m-2} : the measurement value of the second last measurement before the "m"th measurement
- M_{m-1} : the measurement value of the last measurement before the "m"th measurement
- M_m : the measurement value of the "m"th measurement
- K : number of samples, and an integer ranging from 2 to 64

At the first computation, the measurement value of the first measurement will be multiplied by the number of samples, after which the average will be taken. The measurement values of the second and later measurements will replace these in turn, after which the average will be computed each time.

2.6 Other Functions

Event/Action Function

Following the occurrence of an event such as remote control signal (12), alarm, internal switch, chart end signal, timer, match time or key operation, any of the following actions can occur.

- **Alarm acknowledge**
(refer to page 2-16)
- **Alarm reset**
(refer to page 2-16)
- **Timer reset**
(refer to page 2-9)
- **Recording start/stop**
According to the recording mode and recording format, recording will start/stop
- **Manual printout**
(refer to page 2-13)
- **Digital printout**
(refer to page 2-6, 2-7)
- **Message printout**
(refer to page 2-13)
- **Message display**
A preset message will be displayed on the main display
- **Change of chart speed/recording interval**
Chart speed 1 and recording interval 1 will change to chart speed 2 and recording interval 2, and analog trend and logging recording will be carried out. Usually recording will be carried out using chart speed 1 (set at the menu displayed after having pressed the CHART key) and with recording interval 1 (set at the menu displayed after having pressed the SET key at a touch). Upon the occurrence of an event, recording will be carried out using chart speed 2 and with recording interval 2 (set at the menu displayed after having pressed the SET key for three seconds).
- **Group trend recording**
(refer to page 2-10)
- **Saving and reading of measured data, computed data and set-up data**
This function is available if the instrument is equipped with a floppy disk drive. This function enables saving of data to the internal RAM disk or floppy disk and reading of data into the instrument.
- **Starting/stopping of computation, reset, clear, and group reset**
This function is available if the instrument is equipped with the computation function or equipped with a floppy disk drive. This function enables starting and stopping of computation.
- **Flag**
Valid only for models with mathematical option (/M1.)
Set the flag to 1.

Key-Lock Function

This function prevents alterations by careless key operations. When the key-lock function is activated, the indicator "KEYLOCK" at the right side of the display will be lit. All key operations, except power ON/OFF, DISP/MODE key and the cursor, will then be disabled. However, you can preset whether RECORD/FEED/PRINT/FUNC/M.FUNC1 and M.FUNC2 keys will remain operable even after key-lock has been set. Furthermore, when activating or releasing the key-lock, a menu for password verification appears to prevent the key-lock to be used by unauthorized operators.

External Input/Output Function (Option)

Alarm Output

When /A4 option is installed ten external output relays (make contact) can be used, whereas with /R1 option is installed, two external output relays (transfer contact) can be used. These relays will be operated when an alarm occurs. For details concerning their settings and their relation with alarms, refer to page 2-15, 2-16.

Fail Output

When /R1 option is installed, one external output relay (transfer contact) is used for fail output. This relay will change to the de-energized status when a failure of the recorder occurs.

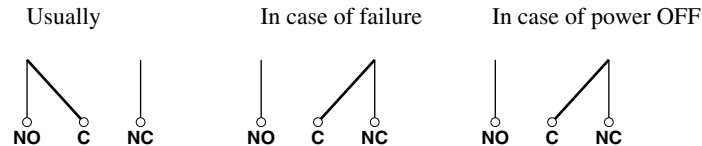
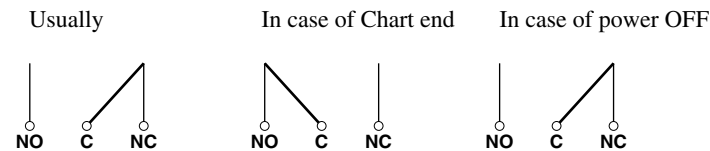

Chart End Output

When /R1 option is installed, one external output relay (transfer contact) is used for chart end output. When the chart has only 2cm or less paper, the “CHART” indicator at the right of the display will light, and recording will stop. The relay will change to the energized status.



Controlling Recording Functions by Remote Control

The recording functions can be controlled by the input of up to 12 contact signals when /R1 option is installed. You can choose one of the following operations for each of the 12 signals. The remote control function can be one of the events of the event/action function described on the previous page.

- Alarm acknowledge
- Alarm reset
- Timer reset
- Recording start/stop
- Manual printout
- Digital printout
- Message printout
- Message display
- Change of chart speed/recording interval
- Group trend recording
- Starting/stopping/clearing/resetting computation
- Saving/reading measured/computed data, reading set-up data

Communication Interface (Option)

Either the GP-IB interface, RS-232-C interface, RS-422-A/RS-485 interface, or ethernet is available as an option and should be specified at the time of ordering. For details regarding operation and commands, refer to IMDR231-11E.

Internal Illumination (Option)

Clear internal illumination for easy distinction of traces is available as an option. Internal illumination will be provided when the power is turned ON.

Carrying Handle (Option)

A carrying handle is available as an option for the stand-alone model DR231 for making transport of the instrument easier.

FDD (DR130-1, DR231-1, DR241-1)

This function enables saving/reading of measured data, computed data and set-up data for SET mode to/from the internal RAM disk, and saving/reading of set-up data for SET and SETUP modes to/from a floppy disk.

This also allows you to use events provided by the event/action function as a trigger to save/retrieve measured/computed data to/from the internal RAM or retrieve set-up data when an event takes place.

Computation Function (Option)

This function is available if the instrument is equipped with the computation function (/M model). This function executes the following computations, and displays and records the results.

Four arithmetical operations (addition, subtraction, multiplication, division), square root, absolute values, common logarithm, natural logarithm, power, logical product, logical sum, exclusive OR, logical negation, statistical operation, relational operation

Up to 30 channels can be used for computation. It is also possible to use the event/action function to start/stop computation or clear data for computation channels. Furthermore, up to 4 levels of alarm (upper-limit alarm, lower-limit alarm) can be set for computation channels.

RRJC (Remote RJC, available if the instrument is equipped with the optional MATH function)

In cases where the object is located in distance for temperature measurement using thermocouples, the temperature of the object can be measured without using a number of expensive thermocouples if a junction terminal is installed near the object. This method requires the object to be connected to the terminal via a thermocouple, and the terminal to this instrument via copper lead wires. Furthermore, the junction terminal needs to be connected to an input terminal of this instrument via a thermocouple. The temperature of the junction terminal is then measured to carry out compensation for the reference contact point used for measurement of temperature of the object, then finally temperature of the object is measured.

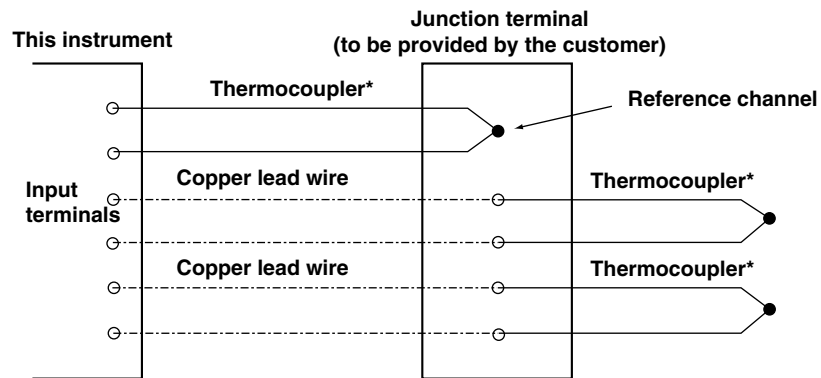

* Thermocouples of the same type must be used

Computing & Report Function (Option)

This function can print the results of a statistical calculation of data on a specified channel (measurement or computation channel), in a format predetermined for a preset time, date or month, or send out the results to a communication line. The types of computations are averaging (mean value, maximum and minimum), instantaneous value calculation and summation (sum, cumulative sum).

3.1 General Precautions for Installation

Safety Precautions

Read the safety precautions

Make sure to read the safety precautions described on page 4 before using the instrument for the first time.

Do not remove any covers from the instrument

For internal inspection or adjustment, contact your nearest sales representative. Addresses may be found on the back cover of this manual.

In case of malfunctioning

Never continue to use the instrument if there are any symptoms of malfunctioning such as unusual sounds, smell or smoke coming from the instrument. Immediately turn OFF the power and unplug the power cord. When using an adapter for direct wiring to the power supply, immediately turn OFF the power supply. Also disconnect the power to the equipment under measurement. Contact your sales representative or nearest service center. Addresses may be found on the back cover of this manual.

Power cable

Nothing should be placed on the power cable; it should also be kept away from any heat sources. When unplugging the power cable from the outlet, never pull the cord itself. Always hold the plug and pull it. If the power cable is damaged, contact your dealer for replacement. Refer to page 2 for the part number when placing an order.

General Handling Precautions

Never place anything on top of the instrument

Never place another instrument or any objects containing water on top of the instrument. Otherwise a failure may occur.

When moving the instrument

First turn off the power of the equipment being measured and disconnect the measurement leadwires and the communication cable. Then turn the power switch of this instrument OFF and unplug the power cable from the outlet. When carrying the instrument, securely hold the instrument with both arms and take care not to drop it.

Ventilation openings

Do not block the ventilation openings in order not to raise the internal temperature.

Electrically charged objects

Don't bring electrically charged objects near the input terminals. The internal circuitry might be damaged.

Chemicals

Do not pour volatile agents on the case nor leave the case in contact with rubber or PVC products for a long period. The case is made of a thermoplastic resin, so take care not to let anything hot such as a soldering iron touch the case.

Cleaning

When cleaning the case or any other part of the instrument, first remove the power cord from the receptacle (and in case of direct connection, disconnect the power lines). Do not use volatile chemicals since this might result in dis-coloring etc. Always use a dry, soft cloth for cleaning.

When not using the instrument for a long time

When the instrument is not being used for an extensive period of time, unplug the power cord from the outlet (when using an adapter for direct wiring to the power supply, disconnect the power cord from the outlet).

3.2 How to Install

Installation Conditions

The instrument must be installed in a location where the following conditions are met.

Ambient temperature and humidity

- Ambient temperature: 0 to 50°C (5° to 45°C, when the recorder includes a floppy disk drive)
- Ambient humidity: 20 to 80%RH for 0 to 40°C, 10 to 50%RH for 40 to 50°C

However, no condensation should be present.

- Installation location: Room
- Installation height: Altitude up to 2,000 m

Note

Internal condensation may occur if the instrument is moved to another place where both the ambient temperature and humidity are higher, or if the temperature changes rapidly. In case of thermocouple input, this might result in erroneous measurements. In those cases, allow the instrument to achieve equilibrium with its new environment for at least one hour before starting operation.

Never install the instrument in any of the following locations:

- in direct sunlight or near heat sources;
- where an excessive amount of soot, steam, dust or corrosive gases are present;
- near strong magnetic field sources;
- near high voltage equipment or power lines;
- where the level of mechanical vibrations is high;
- in an unstable place.

Installation Method

DR130/DR231

Can be used on a desk-top, installed on the floor, or rack-mounted. Always install the instrument vertically.

• Desk-top or floor installation

Install the instrument vertically on a horizontal flat floor as shown below.

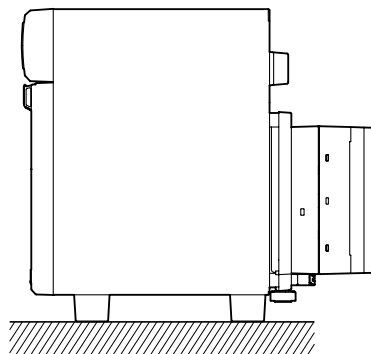

• Rack mounting

The following fitting can be supplied for rack mounting.

Name	Model	Description
Rack mount fitting	DV400-013	Conforming to ANSI/EIA, for DR231
Rack mount fitting	DV400-015	Conforming to ANSI/EIA, for DR130

- External dimensions and rack mounting dimensions for the DR130 and DR231 are shown below.
- To install the rack mount fitting on the instrument, remove the screws at the right and left forward of the instrument and use the mounting screws attached to the rack mount fitting. Be careful that right and left screws have different lengths. The screw at the right when facing the front of the instrument is M4 of 20 mm long and the left screw is M4 of 16 mm long. Appropriate tightening torque is 1.4 to 1.5 N·m (14 to 15 kgf·cm).
- If another instrument is to be mounted under this instrument in an ANSI/EIA rack, remove the prong or brackets designated with 1 and 2 in the figure below because they may interfere with both instruments.

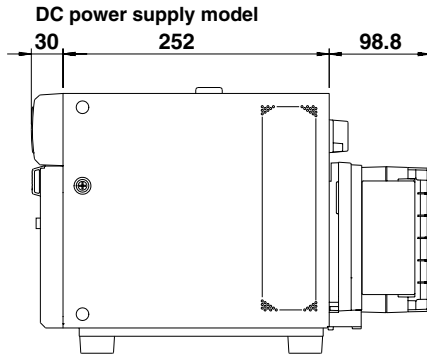
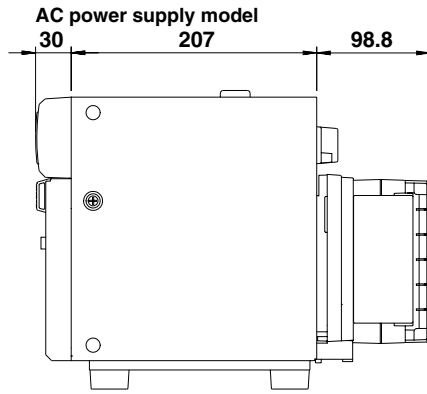
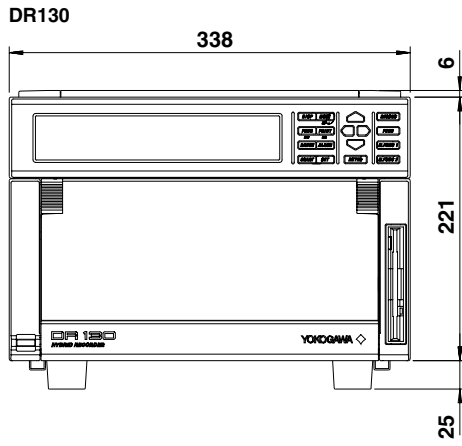

Rack Mounting Dimensions

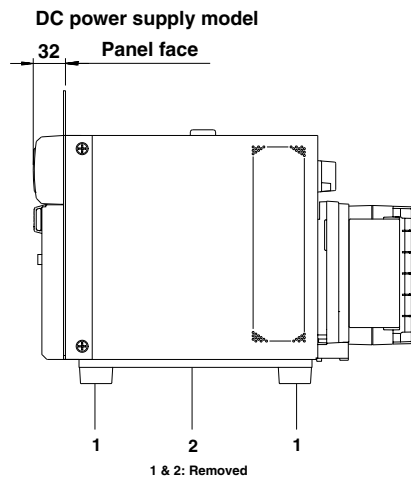
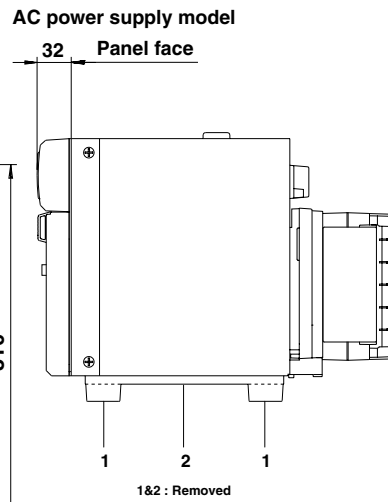
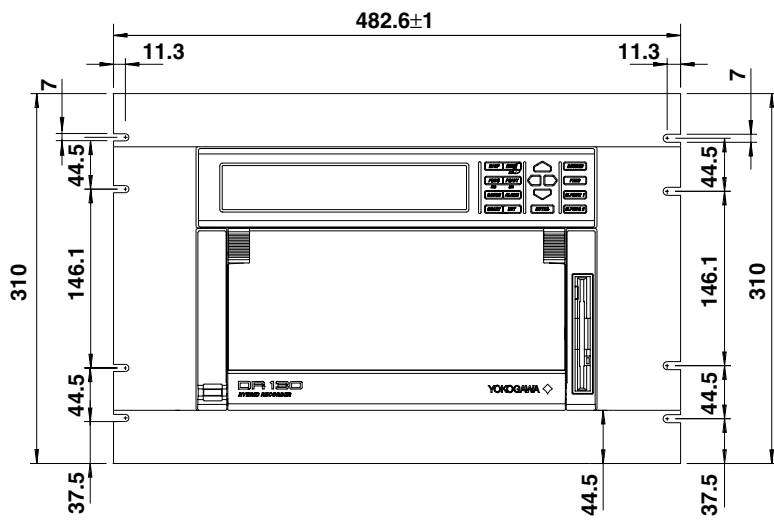

DR231

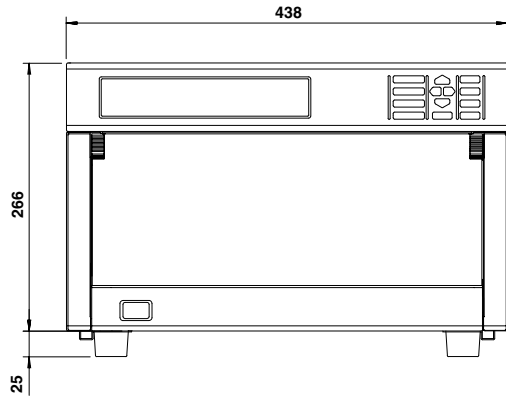

AC power supply model

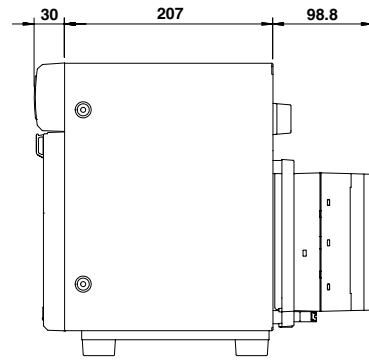

DC power supply model

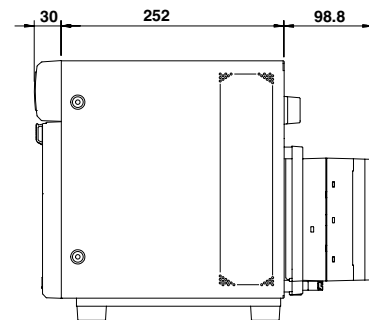

Rack Mounting Dimensions

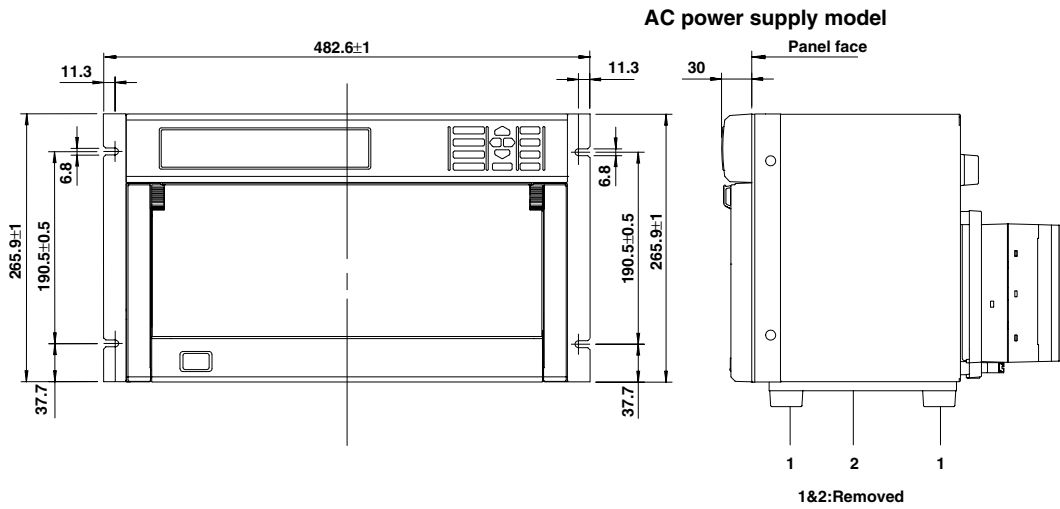

DC power supply model

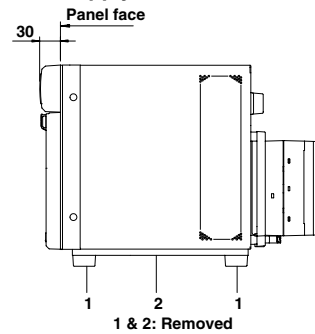

DR241

• Panel mounting

Use steel plates 3 mm thick or more for panel mounting.

The external and panel cutting dimensions for the DR241 are shown below. The panel cutting dimensions include the cutting interval for multiple mounting on the same panel.

The DR241 weighs about 16 kg, so a shelf should be provided to support the DR241 behind the panel.

Insert the instrument from the front face of the panel.

Insert the blocks of the mounting brackets as accessories into the rectangular holes (after removing seals) on right and left sides of the instrument, push the brackets toward the rear, and engage the blocks with rectangular holes.

When a screw attached on each bracket is turned clockwise, the entire brackets are pushed against the panel rear. Tighten the screws to securely fix the instrument to the panel. Proper screw-tightening torque is 0.8 to 1.2 N·m (8 to 12 kgf·cm).

The brackets can be used for panels of 3 to 26 mm thick.

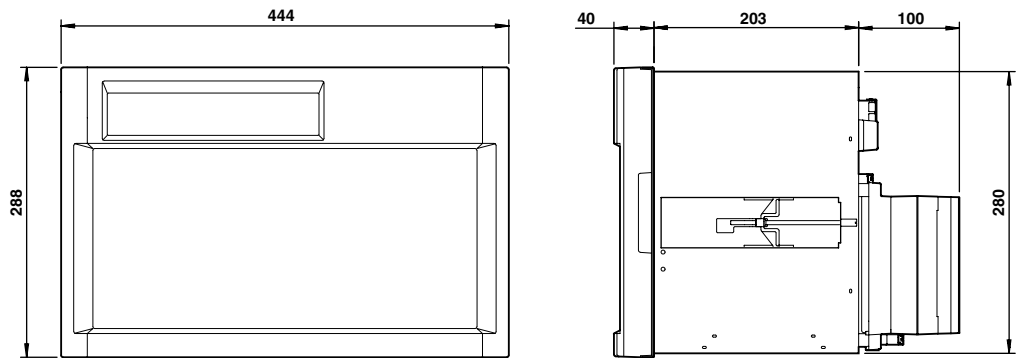

Panel cutting dimension

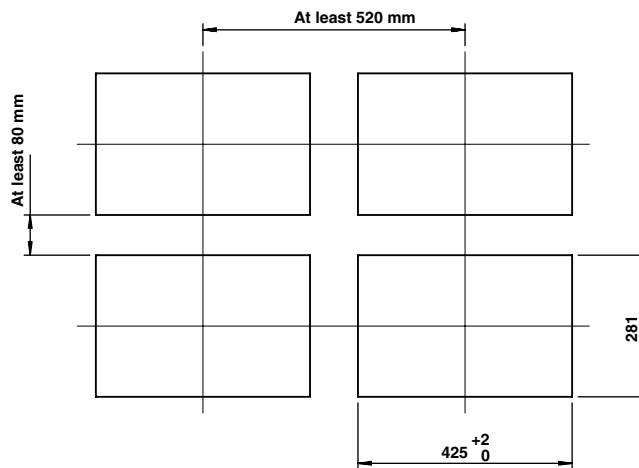

3.3 Installing the Chart and Ribbon Cassette

Installing the Chart

Preparing the Chart

1. To prevent double feed of the folded chart, sufficiently ruffle and fan the chart on both folded side ends.

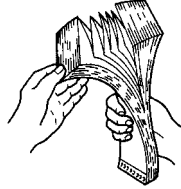

Note

- Use chart papers specified by Yokogawa (part number: B9855AY for DR130, B9627RY or B9627AY for DR231/DR241). Using chart papers other than those specified may cause problems such as large recording errors or the paper getting caught under the sprocket.

Preparing the Chart Cassette

2. Open the front door and draw out the chart cassette from inside of the main unit by pulling forward the chart cassette pressers while simultaneously pushing them (both right and left pressers) toward the center.

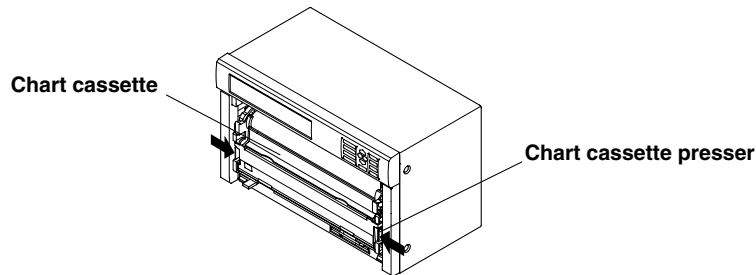

3. Open the chart pressure plate 1 by pulling the right and left lever of the chart pressure plate 1.

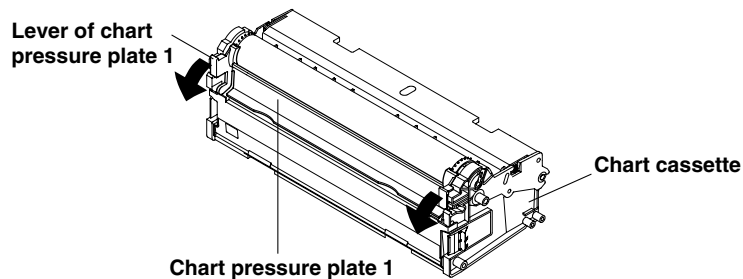

4. Open upward the chart pressure plate 2 by simultaneously pushing the right and left latch release buttons of the chart pressure plate 2.

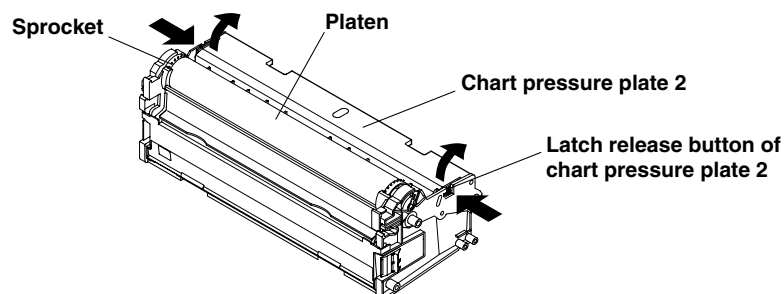

Loading the Chart Paper

5. Place the chart paper in the chart storage housing, and move the paper to the left. Position the chart so that its round perforations are on the left and the recording surface faces upward when the chart paper is wound around the platen.

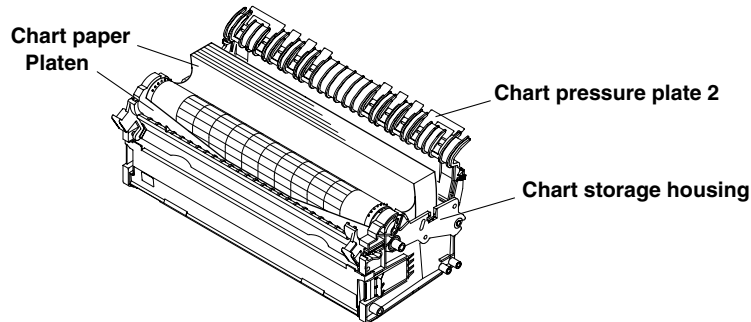

6. Pass the chart paper through the gap between the chart pressure plate 1 and the platen.

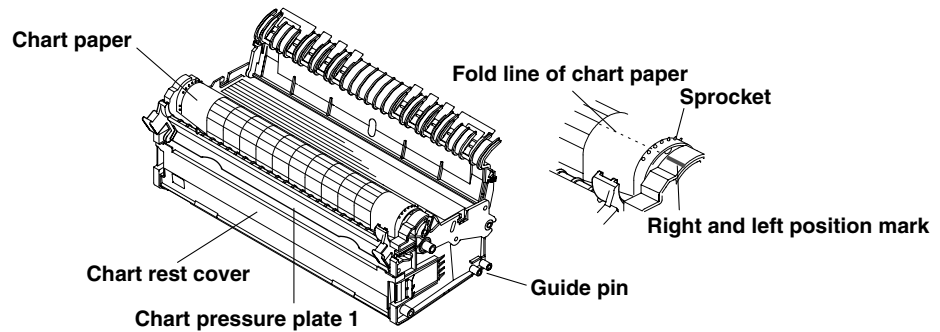

7. Align the right and left chart paper perforations. Set the chart paper so that the right and left marks of the sprockets and the fold line are aligned.
8. Close the chart pressure plate 1 until it latches. Confirm that the horizontal lines of the chart paper are parallel with the horizontal line of the chart pressure plate 1. If they are not parallel, open the chart pressure plate 1 and align the right and left perforations again.
9. Close the chart pressure plate 2.
Press lightly on chart pressure plate 2 until it latches securely.
10. Fitting the guide pin of the chart cassette in the main unit guide groove, place the chart cassette on the bottom of the main unit and slide the cassette deep inside the main unit until the latch engages.
11. Turn on the power of the main unit and feed the chart paper by pressing the FEED key on the operation panel. Feed the chart paper by three folds or more to the chart paper rest and check that the paper is fed properly. Check this in the same way when the chart paper is fed manually without recording. If the chart paper is not fed properly, repeat the procedure from step 2. For details of turning the power on, see page 3-23.
12. When the chart paper approaches the end, the words "RENEW CHART" in an scarlet strip on the paper appear. Prepare a new set of chart paper.
13. When the letters "CHART" in the status indicator in the display light, it indicates that the paper has run out. Replace the chart with a new one according to the above procedure.

* To remove the chart paper from the chart rest, open the chart rest cover and take out the paper.

Loading the Ribbon Cassette

Preliminary Preparation

- If the carriage to which the ribbon cassette is to be mounted is located near the right end, turn off the power and bring the carriage to a location near the left end by turning the screw shaft, then load the ribbon cassette.
- Set the RECORD key on the operation panel to OFF and set all the recording actions for the event/action functions (see page 9-1) to OFF so that recording does not start while loading the ribbon cassette. If applicable, turn off the power.

Note

Do not perform recording without the chart cassette loaded, otherwise the platen may be scratched or the chart paper may break.

Load the Ribbon Cassette into the DR130/DR231

1. Open the front door and remove the chart cassette from the main unit.
2. Press the red lever at the bottom of the carriage. The ribbon cassette holder moves to the right.

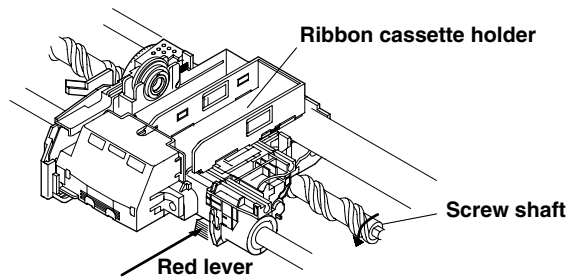

3. Touch the ribbon cassette holder with a finger and tilt the housing downward.
4. Turn the ribbon cassette rotating knob in the direction of the arrow (counterclockwise) to take up the ribbon slack.

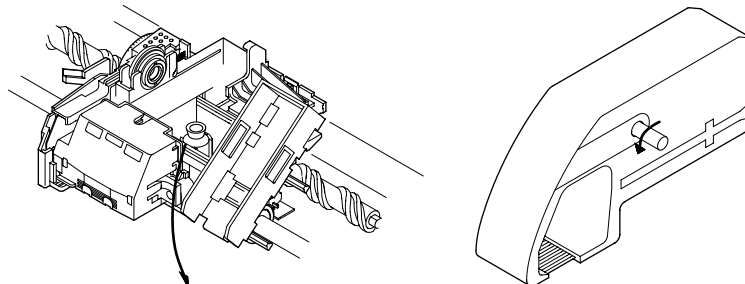

5. Fit the projection of the housing into the slot of the ribbon cassette and insert the cassette fully into the holder.
6. Bring up the front part of the cassette until it latches and make sure it is horizontal.

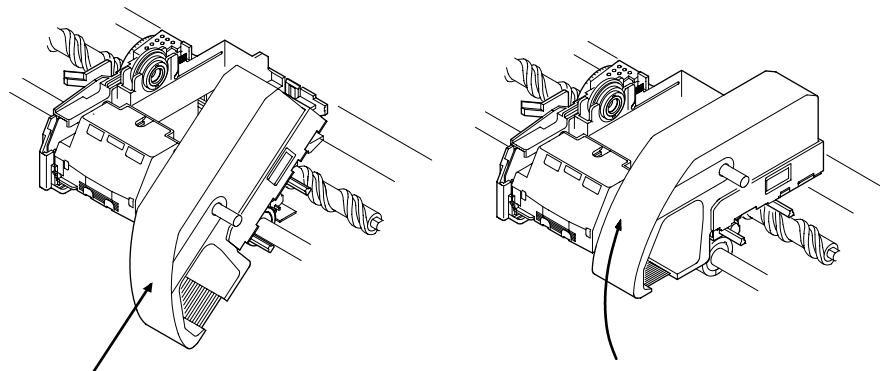

7. Push the ribbon cassette to the left until the latch engages. Check that the three white lines of the printer head are not visible when viewed from the front. If the white lines can be seen, the ribbon cassette is not properly loaded. Push the cassette to the left again.

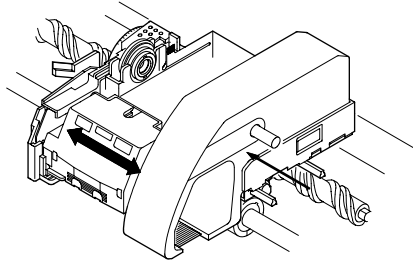

8. Turn the ribbon cassette rotating knob once more in the direction of the arrow (counterclockwise) to take up the ribbon slack.
9. Return the chart cassette to the main unit.
10. Feed the chart paper by pressing the FEED key on the operation panel to prevent a delay in starting the chart paper feed.

Note

- Check that the ribbon cassette is properly loaded in the carriage.
- If a ribbon cassette is used for a long time, the ribbon may become wavy and move out of the dot printing range of the printer head. If this happens, replace the ribbon with a new one.

Load the Ribbon Cassette into the DR241

1. Open the front door and open the display door. The ribbon cassette can be loaded without removing the chart cassette from the main unit.
2. When the chart cassette is removed, press the red lever 1 at the bottom of the carriage. When the chart cassette is not removed, pull forward the red lever 2, then the ribbon cassette holder moves to the right.

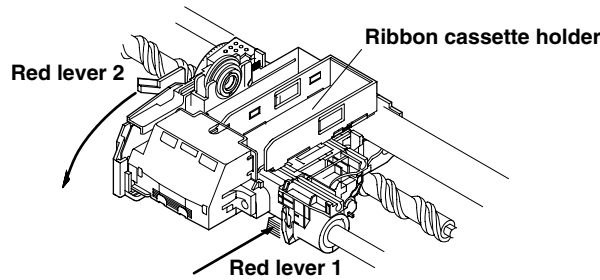

3. Turn the ribbon cassette rotating knob in the direction of the arrow (counterclockwise) to take up the ribbon slack.
4. Fit the projection of the holder into the slot of the ribbon cassette and insert the cassette fully into the holder.

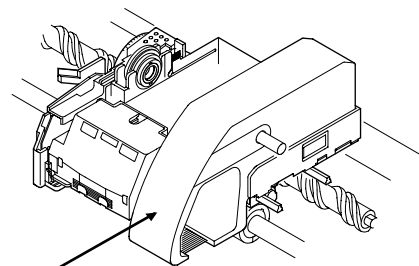
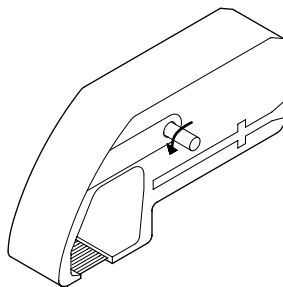

3.3 Installing the Chart and Ribbon Cassette

5. Push the ribbon cassette to the left until the latch engages. Check that the three white lines of the printer head are not visible when viewed from the front. If the white lines can be seen, the ribbon cassette is not properly loaded. Push the cassette to the left again.

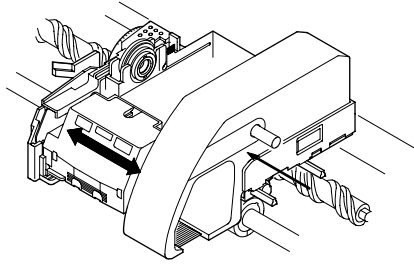

6. Turn the ribbon cassette rotating knob once more in the direction of the arrow (counterclockwise) to take up the ribbon slack.
7. Feed the chart paper by pressing the FEED key on the operation panel to prevent a delay in starting the chart paper feed.

Note

- Check that the ribbon cassette is properly loaded in the carriage.
 - If a ribbon cassette is used for a long time, the ribbon may become wavy and move out of the dot printing range of the printer head. If this happens, replace the ribbon with a new one.
-

3.4 Connecting the Interface Cables

When connecting a personal computer to the instrument via a communication interface, observe the following:

GP-IB

The GP-IB connector of the GP-IB communication module is a 24-pin connector of IEEE St'd 488-1978. Only use cables that conform to IEEE St'd 488-1978 as a communication cable.

Connection Procedure

Connect the cable as shown in the figure below.

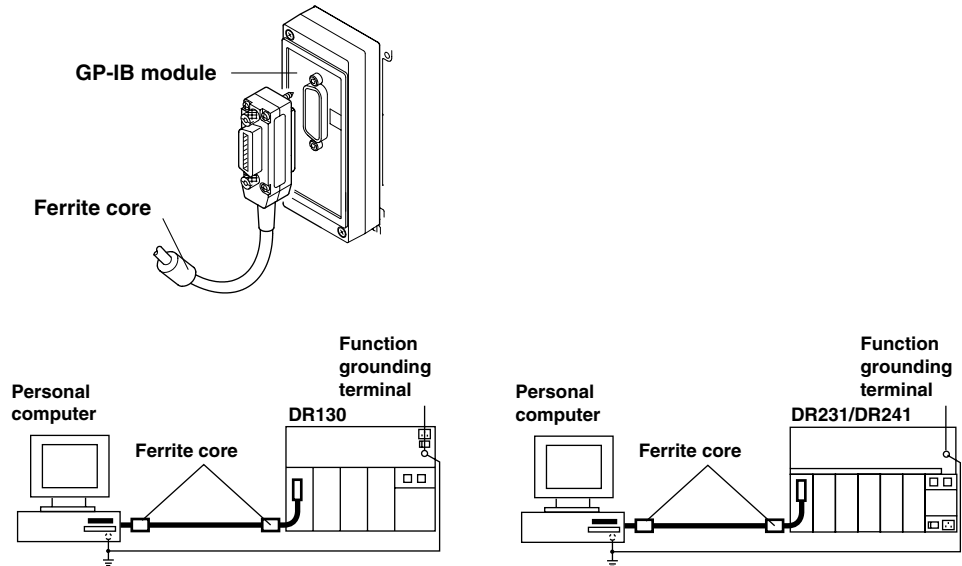

- When connecting the cable, take note of the following.
- To reduce noise, use two ferrite cores (e.g., ZCAT 3035-1330 from TDK) at both ends of the interface cable as shown above.
- Securely tighten the screws which fasten the GP-IB cable connector.
- If more than one equipment is connected, the same addresses cannot be assigned to different equipment.
- Use only cables of 2 m or less to interconnect each equipment.

How to Assign an Address

The address can be assigned easily by turning the rotary dipswitch as shown in the figure below. Any address can be set from "0" to "15"; the characters "A" to "F" on the dipswitch correspond to the address "10" to "15" respectively.

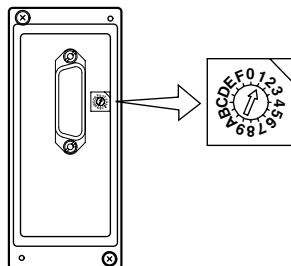

RS-232-C

Communication Settings

Communication parameters are set using the three switches located on the RS-232-C modules.

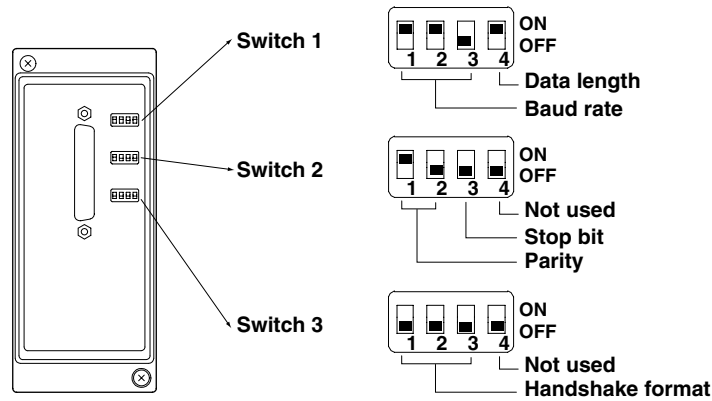

Switch 1 and No.4 of switch 2

Baudrate	dipswitch	No.1	No.2	No.3	No.4 (Switch 2)
150		OFF	OFF	OFF	OFF
300		OFF	OFF	ON	OFF
600		OFF	ON	OFF	OFF
1200		OFF	ON	ON	OFF
2400		ON	OFF	OFF	OFF
4800		ON	OFF	ON	OFF
9600		ON	ON	OFF	OFF
19200		ON	ON	ON	OFF
38400		OFF	OFF	OFF	ON

←initial value

Data length	dipswitch	No.4
7 bits		OFF
8 bits		ON

←initial value

Switch 2

Parity	dipswitch	No.1	No.2
NONE		OFF	OFF
ODD		OFF	ON
EVEN		ON	OFF

←initial value

Stop bit	dipswitch	No.3
1		OFF
2		ON

←initial value

Switch 3

Handshake format	dipswitch	No.1	No.2	No.3
no handshake		OFF	OFF	OFF
XON-DTR*		OFF	OFF	ON
XON-RTS*		OFF	ON	OFF
CTS-DTR		OFF	ON	ON
CTS-RTS		ON	OFF	OFF

←initial value

*: When the baud rate is set to 38400, there is no handshake.

Connecting the RS-232-C Cable

For details on connecting the RS-232-C connector of the RS-232-C communication interface module to a personal computer, see IM DR231-11E, "DR231/DR232/DR241/DR242 Communication Interface User's Manual."



CAUTION

When (dis)connecting the RS-232-C cable, turn OFF the power of both the personal computer and the instrument. If the power is not turned OFF, malfunctions may occur and the internal circuitry may be damaged.

Note

To reduce noise, use ferrite cores (e.g., ZCAT 3035-1330 from TDK) for the interface cable as shown below. Two ferrite cores should be installed near both ends of the interface cable. If the noise is particularly bad, use several ferrite cores in series. Use a shielded cable for the interface cable and make a one-point grounding at the ground terminal of this instrument together with the functional-ground terminal of the personal computer.

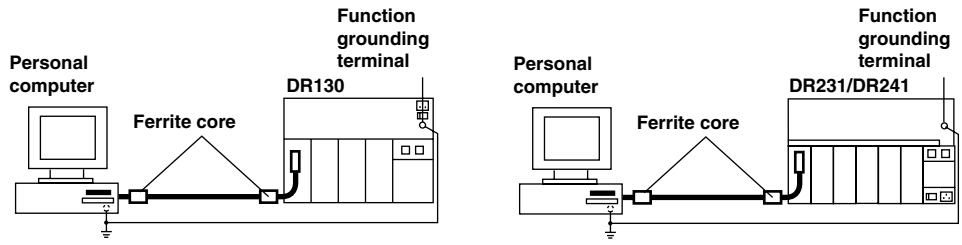

RS-422-A/RS-485

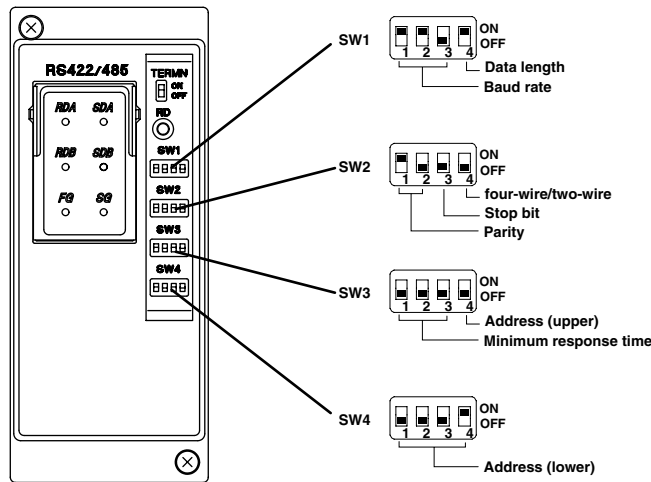

Baud rate (No.1 to 3 of SW1)

Baud rate	No.1	No.2	No.3
300	OFF	OFF	ON
600	OFF	ON	OFF
1200	OFF	ON	ON
2400	ON	OFF	OFF
4800	ON	OFF	ON
9600	ON	ON	OFF
19200	ON	ON	ON
38400	OFF	OFF	OFF

←Default Setting

Data length (No.4 of SW1)

Data length	No.4
7	OFF
8	ON

←Default Setting

3.4 Connecting the Interface Cables

Parity (No.1 to 2 of SW2)

Parity	No.1	No.2	
None	OFF	OFF	
ODD	OFF	ON	
EVEN	ON	OFF	←Default Setting

Stop bit (No.3 of SW2)

Stop bit	No.3	
1	OFF	←Default Setting
2	ON	

Switch between four-wire/two-wire systems (No.4 of SW2)

four-wire/two-wire	No.4	
four-wire	OFF	←Default Setting
two-wire	ON	

Minimum response time (No.1 to 3 of SW3)

Minimum response time	No.1	No.2	No.3	
0ms	OFF	OFF	OFF	←Default Setting
10ms	OFF	OFF	ON	
20ms	OFF	ON	OFF	
50ms	OFF	ON	ON	
100ms	ON	OFF	OFF	

Address (No.4 of SW3 and No.1 to 4 of SW4)

Address	No.4(SW3)	No.1(SW4)	No.2(SW4)	No.3(SW4)	No.4(SW4)	
1	OFF	OFF	OFF	OFF	ON	←Default Setting
2	OFF	OFF	OFF	ON	OFF	
3	OFF	OFF	OFF	ON	ON	
4	OFF	OFF	ON	OFF	OFF	
5	OFF	OFF	ON	OFF	ON	
6	OFF	OFF	ON	ON	OFF	
7	OFF	OFF	ON	ON	ON	
8	OFF	ON	OFF	OFF	OFF	
9	OFF	ON	OFF	OFF	ON	
10	OFF	ON	OFF	ON	OFF	
11	OFF	ON	OFF	ON	ON	
12	OFF	ON	ON	OFF	OFF	
13	OFF	ON	ON	OFF	ON	
14	OFF	ON	ON	ON	OFF	
15	OFF	ON	ON	ON	ON	
16	ON	OFF	OFF	OFF	OFF	
17	ON	OFF	OFF	OFF	ON	
18	ON	OFF	OFF	ON	OFF	
19	ON	OFF	OFF	ON	ON	
20	ON	OFF	ON	OFF	OFF	
21	ON	OFF	ON	OFF	ON	
22	ON	OFF	ON	ON	OFF	
23	ON	OFF	ON	ON	ON	
24	ON	ON	OFF	OFF	OFF	
25	ON	ON	OFF	OFF	ON	
26	ON	ON	OFF	ON	OFF	
27	ON	ON	OFF	ON	ON	
28	ON	ON	ON	OFF	OFF	
29	ON	ON	ON	OFF	ON	
30	ON	ON	ON	ON	OFF	
31	ON	ON	ON	ON	ON	

For details on connectin the RS-422-A/RS-485 connector of the RS-422-A/RS-485 communication interface module to a personal computer, see IM DR231-11E, “DR231/DR232/DR241/DR242 Communication Interface User’s Manual.”

CAUTION

When (dis) connecting the RS-422-A/RS-485 cable, turn OFF the power of both the personal computer and the instrument. If the power is not turned OFF, malfunctions may occur and the internal circuitry may be damaged.

Ethernet

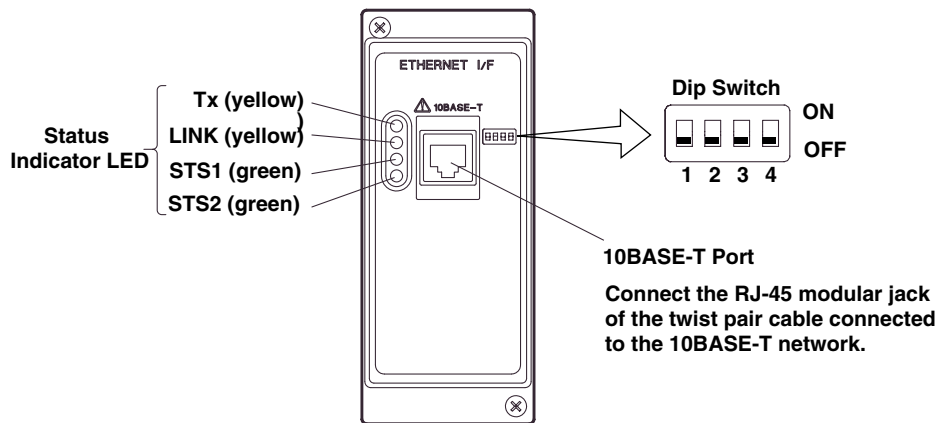

You can select the following three modes by setting the dip switch.

Configuration mode: A mode in which the IP address, subnet mask, and default gateway are set for the DR.

Test mode: A mode in which the condition of the physical connection is tested.

Communication mode: A mode in which the DR is connected to the network to carry out communication. Use this mode to read in the DR measurement data with the PC.

In addition, you can turn ON/OFF the Keepalive function.

Mode Setting

Mode	Switch 1	Switch 2
Configuration mode	ON	OFF
Test mode	OFF	ON
Communication mode	OFF	OFF ←Default Setting

Do not set both dip switches, 1 and 2, to ON.

Keepalive Setting

Keepalive	Switch 3
Enable	ON ←Default Setting
Disable	OFF

Keepalive is a function supported by TCP. It sends packets at constant time intervals and automatically disconnects when there is no corresponding response. This instrument sends packets at 30-second time intervals. If a response is not received, it sends 4 more packets at one-second intervals. If a response is still not received, the connection is dropped.

Have dip switch 4 turned OFF.

3.5 Connecting the Signal Lines



WARNING

- To prevent electric shock always make sure that the power supply is turned OFF before connecting.
- When 30VAC or 60VDC and more is applied to the output terminal of the alarm module or the output terminal of the DI/DO module, use double-insulated wires (withstand voltage performance: more than 2300VAC) for those wires which apply 30VAC or 60VDC and more. All other wires can be basic-insulated (withstand voltage performance: more than 1350VAC). Furthermore, use “crimp-on” lugs (for 4mm screws) with insulation sleeves for connecting to the screw terminal. Make sure that the crimp-on tool must be one specified by the crimp-on lugs manufacture, and that the crimp-on lugs and tool must be matched to the wire size. To prevent electric shock, do not touch the terminal after wiring and make sure to re-apply the cover.



CAUTION

- Do not apply an input voltage exceeding the following levels to each terminal of each module. Otherwise, the internal circuits may be damaged.
Allowable input voltage
Universal or DCV/TC/DI input module
2 VDC range or less, RTD, TC and DI(CONT) : ± 10 VDC
6 to 20 VDC range, DI(LEVEL) : ± 60 VDC
DI/DO module : -2 to 7 VDC
Max. common mode noise voltage
Universal or DCV/TC/DI input modules : 250 VACrms (50/60 Hz)
- Output contact rating for DI/DO or Alarm input modules is 250 VDC/0.1 A (resistive load), 250 VAC/2 A (resistive load), 30 VDC/2 A (resistive load).
- The overvoltage category of each input module is CAT II (IEC 1010).
- When connecting to a clamp terminal, use a signal conductor with the following cross-sectional width:

Solid conductor	0.14 to 2.5 mm ²
Stranded conductor	0.14 to 1.5 mm ²
AWG	26 to 14

- 1 Check that the power switch of this instrument is turned off.
- 2 Remove the terminal cover. (the figure below shows DU100-11.)

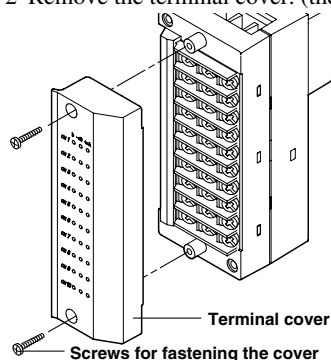

- 3 Fasten the signal wires to the terminals as shown in the figure on the next page.
- 4 Re-apply the terminal cover and fasten the screws.

Note

Make sure that the equipment connected to the signal in-/output conforms IEC (CSA) 950 or IEC (CSA) 1010. Also, make sure to use cables that conform to IEC (CSA) standards.

In case you are using an internal RJC in case of thermocouple input, the following considerations are necessary to stabilize the temperature at the terminals. Always make sure to re-apply the terminal cover; The thermal capacity of the wiring should be small (cross sectional area of less than 0.5mm²); Minimize outside temperature fluctuations as much as possible.

To prevent noise, make sure to ground each unit at the grounding function terminal (below the power switch) together at one point.

Refrain from wiring the input signals parallel. However, if you do, then the following considerations are necessary. Ground all equipment at the same point; Do not turn the power of other equipment ON/OFF during operation; Do not use the burnout function.

Wiring Input Signal Lines (Universal and DCV/TC/DI input modules)

Terminals

Screw type terminal

- + — DC voltage • TC • contact

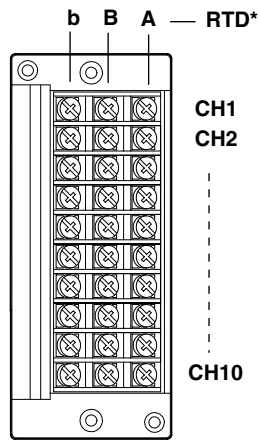

Clamp type terminal

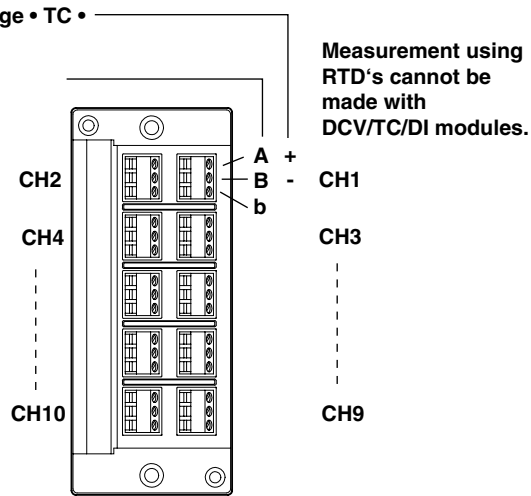

Wiring Diagram

DC voltage input/DI input (contact)

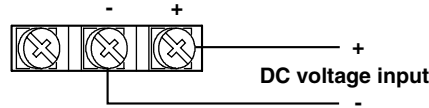

DC input

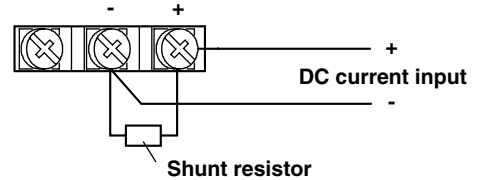

Note: For 4 to 20mA input, shunt resistance value should be 250Ω ±0.1%

TC input

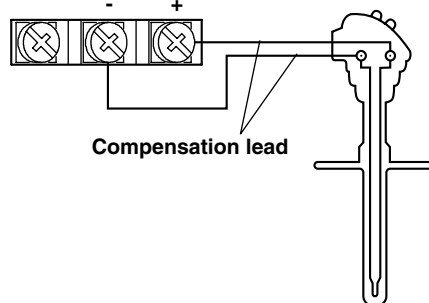

RTD input

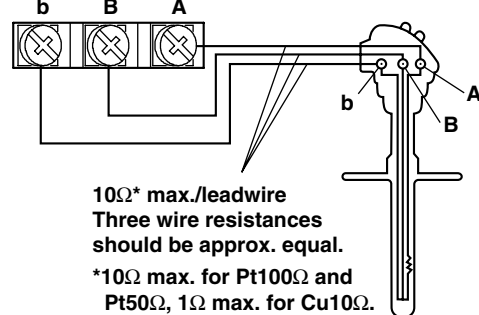

Wiring Output Signal and Remote Control Signal Lines (DI/DO and Alarm modules)

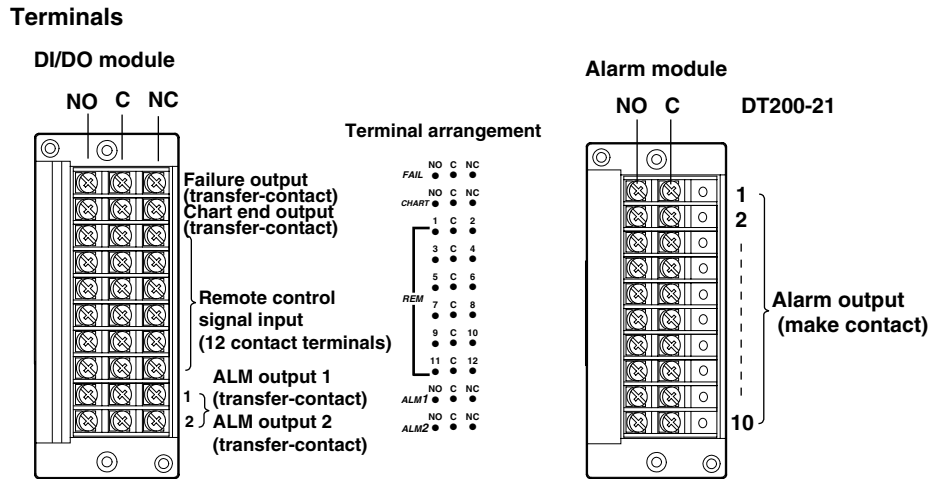

Wiring AC Input Signal Lines (Power Monitor Module)

WARNING

- For hazard prevention, ALWAYS provide protective grounding before connecting measuring leadwires.
- When connecting any object being measured, ALWAYS turn off the power to the object. It is extremely dangerous to connect or disconnect interconnecting leadwires with the power to the object left on.
- Exercise utmost care to avoid connecting any current-mode circuit to a voltage-input terminal or any voltage-mode circuit to a current-input terminal. Wrong connection may result in damage to the circuit or equipment being measured or the DR232 or DR242 recorder itself, as well as bodily injury.
- Fuses are not built into voltage- and current-input terminals. ALWAYS install a fuse on the interconnecting leadwire. Use a fuse that will not permit the voltage or current being measured to exceed the maximum ratings of an AC input module.
The maximum voltage and current that can continuously be imposed on an AC input module are as follows:
Voltage: 250 Vrms; current: 5 Arms
- To avoid electrical shock, ALWAYS attach the terminal cover in place after the completion of wiring to the terminals so that the terminals cannot be accidentally touched.

CAUTION

- In wiring, use double-insulated leadwires that have sufficient withstanding-voltage and current-carrying-capacity margins against the voltage and current being measured and meet the ratings at which they are used.
- ALWAYS clamp measuring leadwires with the wire clips to prevent the wires from being disconnected from their terminals. As the measuring leadwires, use wires 0.2 to 2.5 mm² (AWG14 to 25) thick so they can be fastened securely with the wire clips.
- The power monitor module is a product belonging to Installation (Over-voltage) Category CAT II.

Diagram of Terminal Block

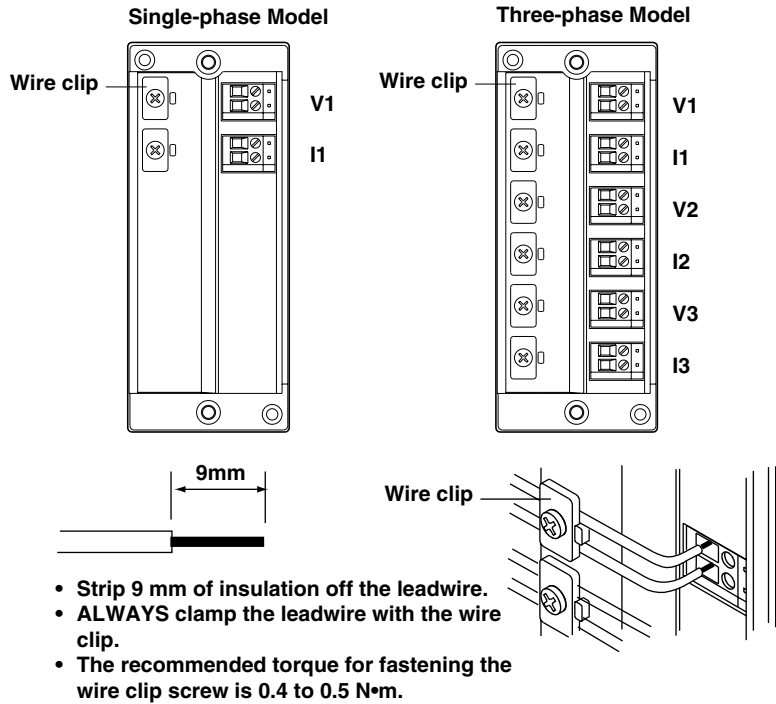

Wiring Diagrams

• Single-phase Two-wire Configuration

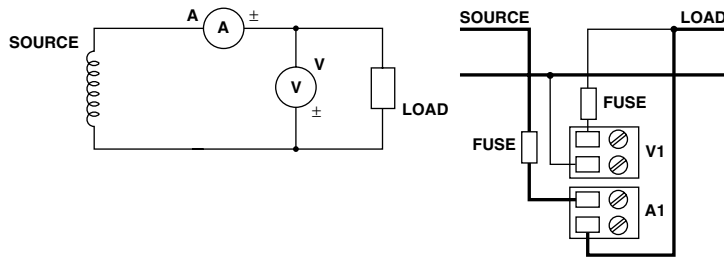

• Single-phase Three-wire Configuration (power monitor modules for three-phase use only)

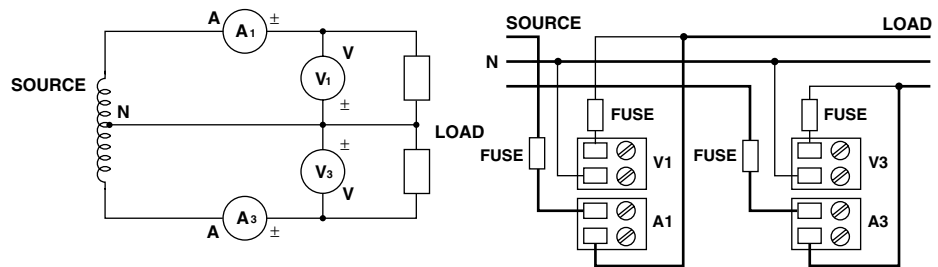

• Three-phase Three-wire Configuration (dual-current/dual-voltage measurement; power monitor modules for three-phase use only)

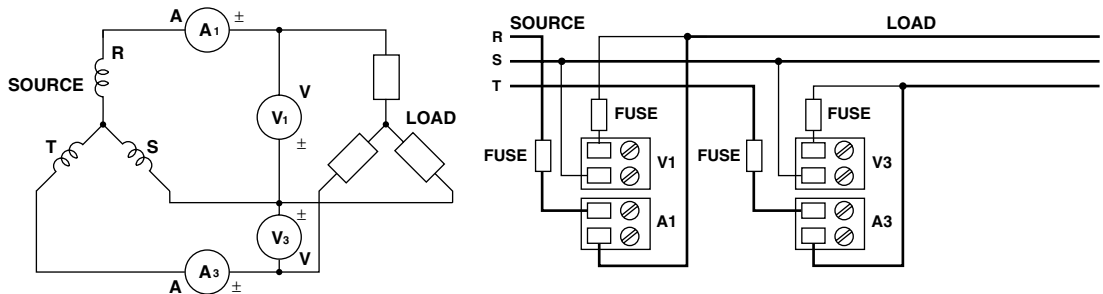

3.5 Connecting the Signal Lines

- **Three-phase Three-wire Configuration (triple-current/triple-voltage measurement; power monitor modules for three-phase use only)**

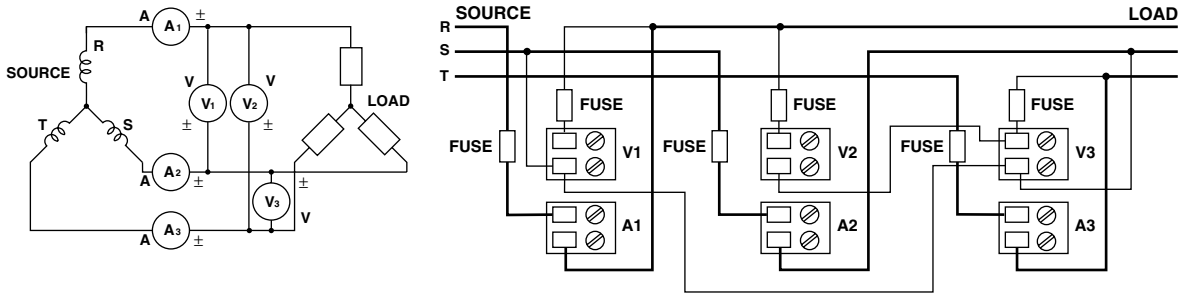

- **Three-phase Four-wire Configuration (power monitor modules for three-phase use only)**

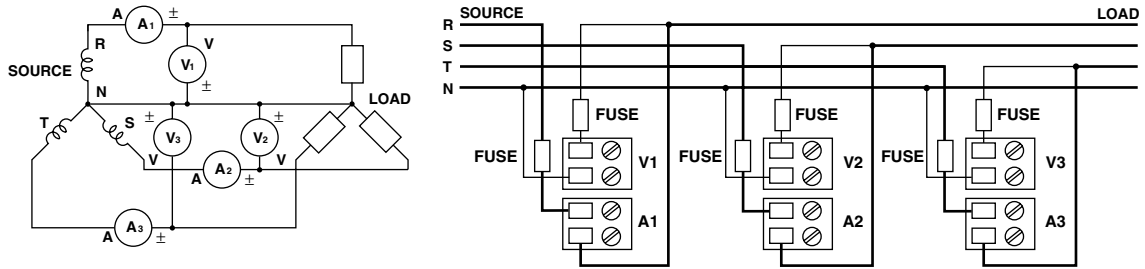

3.6 Connecting the Power Cable and Turning the Power ON/OFF

DR130/DR231 (when using the accessory power cable)

Follow the warnings below to avoid electric shock or damaging the instrument.



WARNING

- Connect the power cable only after confirming that the voltage of the power supply matches the rated electric power voltage for this instrument.
- Connect the power cable after checking that the power switch of this instrument is turned off.
- To prevent electric shock or fire, always use the power cable supplied by Yokogawa.
- Always use protective grounding to prevent electric shock. Connect the power cable of the instrument to a three-pole power outlet which has a protective ground terminal. Do not use the function grounding terminal (⊥ marked terminal) under the power connecting part as the protective ground terminal.
- Never use an extension cord that does not have protective grounding, otherwise the protection feature will be negated.

Connecting Procedure

1. Check that the power switch is turned off.
2. Connect the plug of the accessory power cable to the power connector.
3. Plug the other end of the power cable into a power outlet that satisfies the following conditions:

For models with AC power supply

Rated supply voltage: 100 to 240 V AC (free power supply),
operating voltage: 90 to 250 V AC

Rated supply voltage frequency: 50/60 Hz

Power consumption: About 130 VA max.

Use a three-pole power outlet provided with a protective ground terminal.

For models with /P6 option

Rated supply voltage: 100 to 240 V AC (100/200 V auto switch),
operating voltage: 90 to 132/180 to 250 V AC

Rated supply voltage frequency: 50/60 Hz

Power consumption: About 130 VA max.

Use a three-pole outlet provided with a protective ground terminal.

DR130

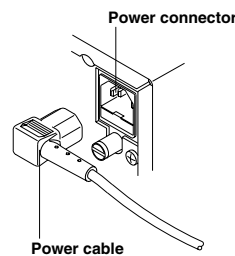

DR130 with /P6 option

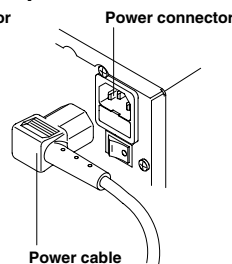

DR231

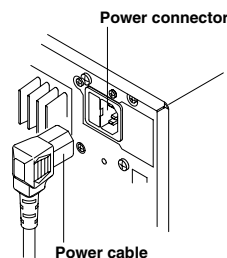

DR231 with /P6 option

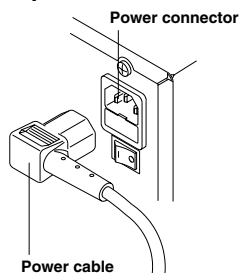

DR241 (when connecting wires to screw terminals)

Follow the warnings below to avoid electric shock or damaging the instrument.



WARNING

- Connect the power wires after checking that the power supply is turned off to prevent electric shock.
- To prevent fire, use 600 V PVC insulated wire (AWG18) for both power and ground wiring (cross section of 0.83 mm² or thicker, anti-galvanic corrosion finish, insulation thickness more than 0.8 mm, insulation resistance more than 50 MΩ/km at 20°C, approved EN60 320 (VDE0625)) for AC power, or equivalent cables. Also use wires with cross sectional area of 0.3 mm² (AWG22) or more for DC power.
- Before turning on the power, always ground the protective ground terminal so that the grounding resistance is 100 Ω or less. Do not use the function grounding terminal (marked terminal) under the power connecting part as the protective grounding terminal.
- For AC power and ground wiring, use “crimp on” lugs (for 4mm screws) with insulation sleeves. Make sure that the crimp-on tool must be one specified by the crimp-on lugs manufacture, and that the crimp-on lugs and tool must be matched to the wire size.
- To prevent electric shock, do not touch the terminals after wiring.
- Make sure to apply a power switch in the power supply cord with the following characteristics:
 - rated power current > 3 A
 - rated rush current > 90 A

• Connecting procedure for AC power supply

1. Check that the power switch is turned off.
2. Remove the cover protecting the power terminals.
3. Connect the power supply wires and the protecting ground wire to the power terminals.
4. Replace the cover.

Rated supply voltage: 100 to 240 V AC (free power supply),
operating supply voltage: 90 to 250 V AC

Rated supply voltage frequency: 50/60 Hz

Power consumption: About 130 VA max.

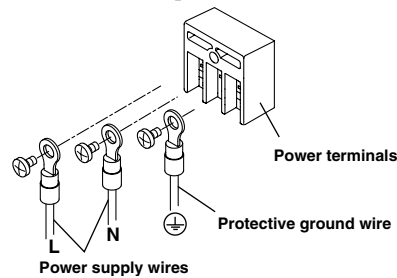

• **Connecting procedure for DC power supply**

1. Check that the power switch is turned off.
2. Remove the cover protecting the power terminals.
3. Connect the power supply wires and the function ground wire to the power terminals.
4. Replace the cover.

Rated supply voltage: 12 to 28 V DC,
 operating supply voltage: 10 to 32 V DC
 Power consumption: About 80 VA max.

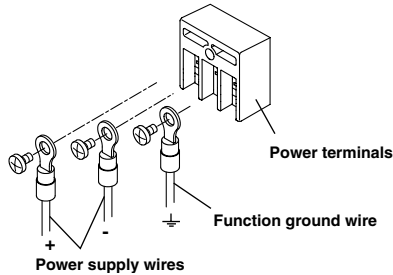

• **DR130/DR231 (when using the DC power supply connector)**

Follow the warnings below to avoid electric shock or damaging the instrument.



WARNING

- Connect the power wires after checking that the power is turned off to prevent electric shock.
- To prevent fire, use wires with cross sectional area of 0.3 mm² (22AWG) or more.

1. Check that the power switch is turned off.
2. Connect the power supply wires and the DC power supply connector (standard accessories, part number:A1105JC). For the power supply wires, use wires 0.3 mm² (AWG22) thick.

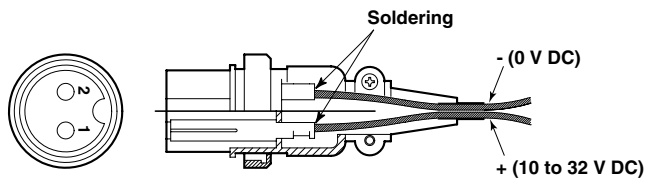

Rated supply voltage: 12 to 28 V DC,
 operating supply voltage: 10 to 32 V AC
 Power consumption: About 80 VA max.

DR130

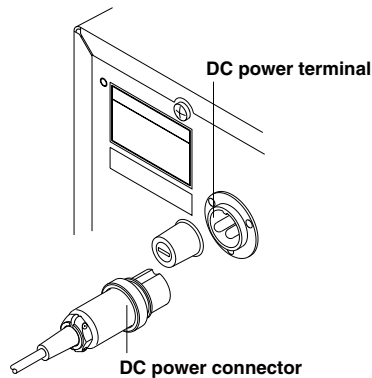

DR231

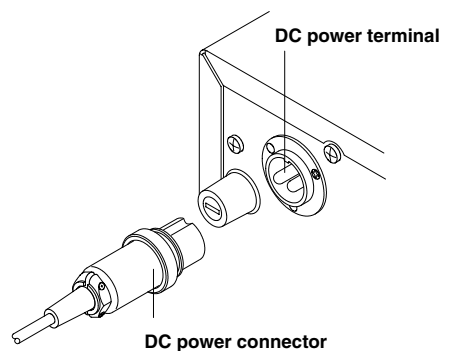

Turning Power ON/OFF

The power switch is a push-button; the power is turned on when pressed once and turned off when pressed again.

DR130

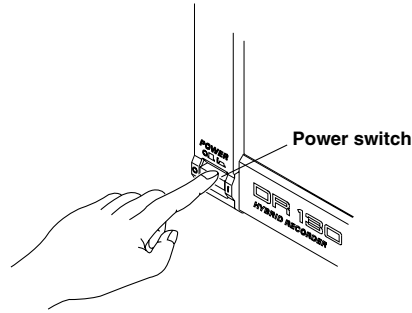

DR231/DR241

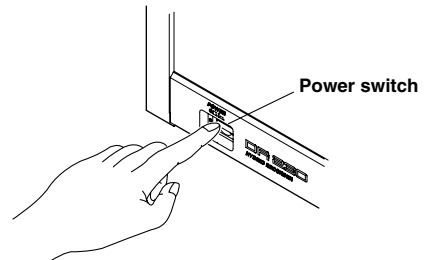

Note

- Before turning the power on, check that each unit is properly mounted and the power cable is correctly connected.
- If nothing appears on the display when the power switch is turned on, turn off the power and check the following:
 - Is the power cable properly connected?
 - Is the supply voltage within the range noted on the previous page?
 - Is the power fuse blown (see page 13-2)?
If the problem still cannot be fixed, there may be an equipment problem; please contact your nearest sales representative. Addresses may be found on the back cover of this manual.
- The device takes about 30 minutes to warm up.
- The service life of the lithium battery used to save the settings is about 10 years at an ambient temperature of 23°C. If the settings cannot be held because the lithium battery has run down, please contact your nearest sales representative. Addresses may be found on the back cover of this manual.

Turning AC Power ON/OFF

When using the AC power supply on the DR130/DR231 with /P6 option, turn on the AC power switch on the upper right section of the rear panel. Pressing “I” turns the power on. Pressing “O” turns the power off. To stop using the AC power supply, turn off the AC power switch.

DR130

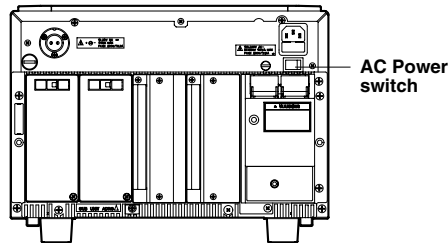

DR231

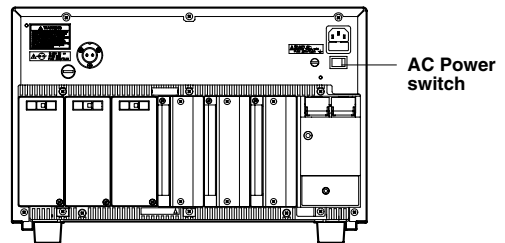

Note

- AC power will operate as long as the AC power switch is on, even if the main switch is turned off. If you are not going to use the instrument for a long time, turn off the AC power switch.

3.7 Setting the Date and Time

Relevant Keys

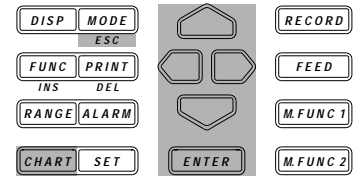
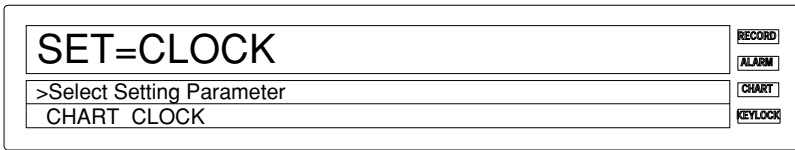

Operating Procedure

- Press the CHART key to display the CHART menu.
- Set and select using or .
- To escape while using a single menu, press the MODE(ESC) key. The menu returns to the first menu to which the single menu belongs. Note that newly selected or set items will be canceled.
- When the device displays that setting is completed, the newly set or selected details are fixed.

(Main menu)

SET=

CLOCK

(Lower menu)

ENTER → 96/01/01 03:36:23 ENTER

>Set Date & Time YY/MM/DD HH:MM:SS

↓
*** SET OK***

ESC

Explanation

Setting the Date and Time

Set them in the order of year/month/day, hour:minutes:seconds.

- Year: Specify the lower two digits of the year. Example: 1996 → 96, 2000 → 00
- Month, day: Use two digits for each.
- Hour: 00 to 23

Press the ENTER key at the set time to make it effective.

Note

The date and time settings are backed up by the lithium battery in the main unit.

3.8 Countering Noise

Types and Features of Noise Sources

Commercial Power Supply

It is necessary to consider both 50 and 60Hz as noise components. It is important to note that a power supply line in which a thyristor or inverter is incorporated functions not only as an “energy surplus line”, but also as a “supply surplus line”.

Thyristor (SCR)

A thyristor is used to control power through ON/OFF modulation of commercial power by controlling the phase angle.

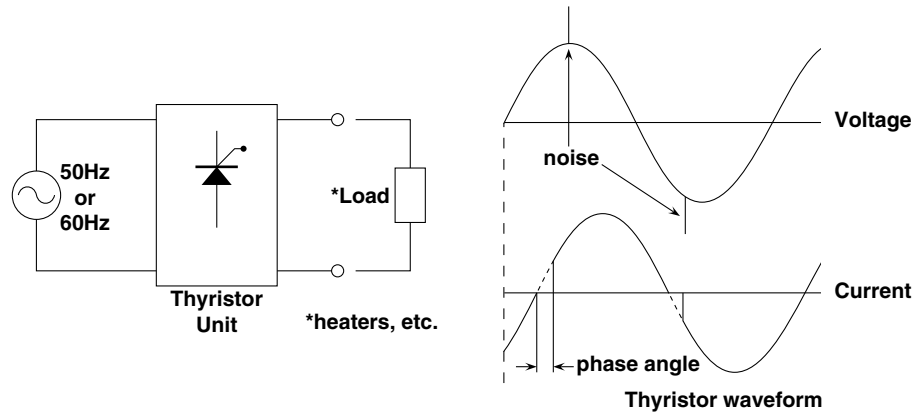

When the thyristor turns ON or OFF, a pulse noise is superimposed on commercial power supply, and its pulse width is approximately $1\mu\text{s}$. Accordingly, thyristor noise can be defined as follows.

- thyristor noise = commercial power supply + pulse noise

Inverter

Commercial power supply is converted to direct current by a rectifier (sometimes the thyristor is used as the rectifier to stabilize direct current) and then modulated by a switching transistor and finally converted into alternating current at the desired frequency (from tens to hundreds of Hz) to drive a motor, for example. If the load to be driven is a fluorescent lamp, the frequency is tens of kHz. Accordingly, inverter noise can be defined as follows.

Inverter noise = commercial power supply + pulse noise (high density) + variable low frequency noise

Since the density of pulse noise is high compared to that of a thyristor and in addition, there is variable frequency noise, it is difficult to consider a countermeasure for inverter noise.

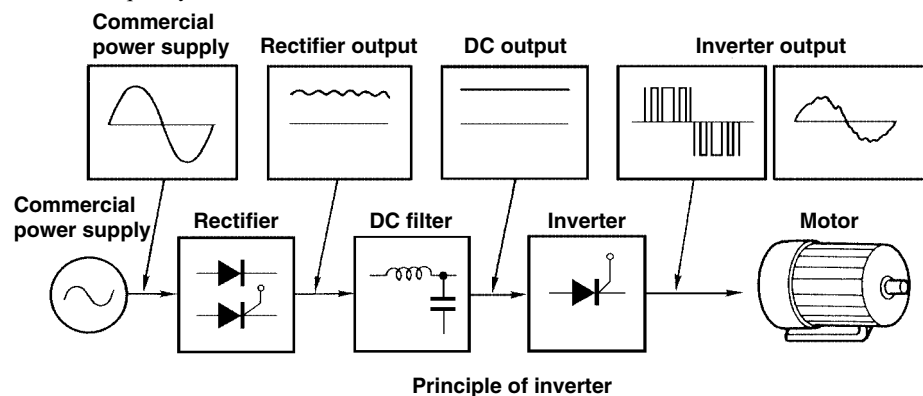

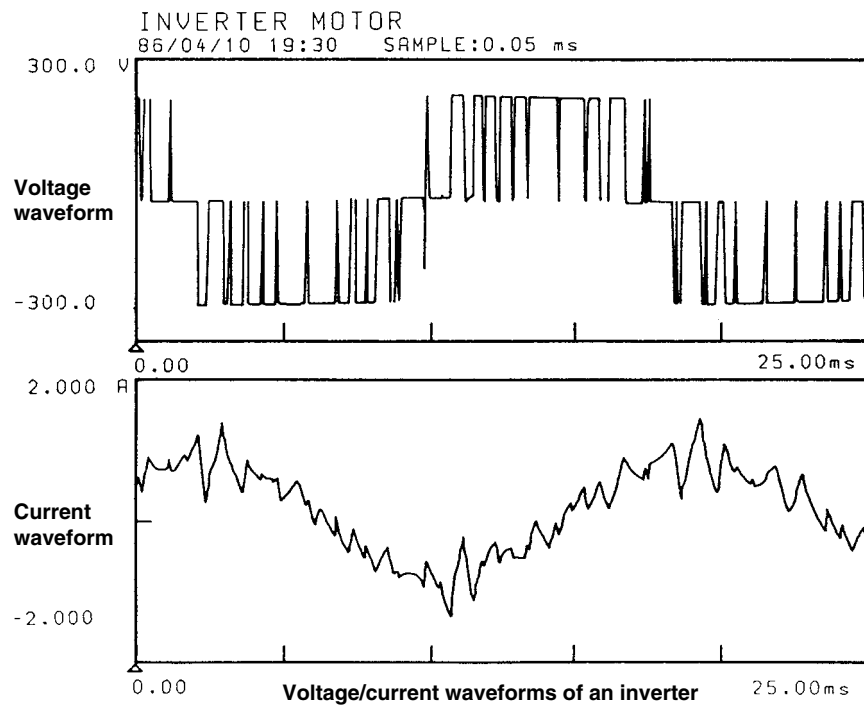

Relay

A relay is frequently used to amplify alarm and temperature controller outputs. However, since a counter-electromotive force (counter e.m.f.) is produced by coil inductance when the relay is turned off and the e.m.f. becomes noise, care must be taken. Due to chattering at the relay contact, tens to hundreds of kHz noise occurs mainly in bursts. Thus, the noise energy often becomes high.

Transceiver

In large-scale plants, transceivers are often used for communications between the field and the control room. Although W/G of the Japanese Electric Measuring Instruments Manufacturers Association recommends to use transceivers covering a wave band of 27MHz, smaller-sized transceivers for the 140 or 470MHz wave band are often used.

Noise Simulator

To test the immunity to pulse noise (mainly thyristor noise), a noise simulator is often used. A test noise of approximately 1kV for 0.8 μ s is used synchronously with the power supply frequency. Since data acquisition equipment is often used for measurements of equipment subjected to the pulse noise test, the influence of noise must be considered.

Propagation of Noise

• Noise is propagated in the following three ways.

- Conduction: noise is conducted through a power line, input wiring, etc.
- Electrostatic induction: noise leaks through capacitances between wires and instruments.
- Electromagnetic induction: a loop in the input line, etc. induces an AC voltage by detecting the AC magnetic field.

In real applications, the above three propagation paths are not independent of each other. Their combination propagates noise to the equipment and causes problems.

• Examples of noise propagated through each of these paths are given below.

- Conduction: inverter noise, relay noise, thyristor noise, and noise caused by surface temperature measurement of a power transistor, etc.
- Electrostatic induction: commercial power supply noise such as the hum of audio equipment, relay noise, etc.
- Electromagnetic induction: magnetic leakage flux from a power transformer or motor, magnetic field from a high-frequency induction furnace, the rotating magnetic field of a power generator (Cu10 Ω), etc.

The figure on the next page shows the propagation paths using practical examples.

Example of a high-frequency induction furnace

* Due to electromagnetic induction, current i flows through the conductor, creating joule heat which heats the furnace.
 $J=i^2r$

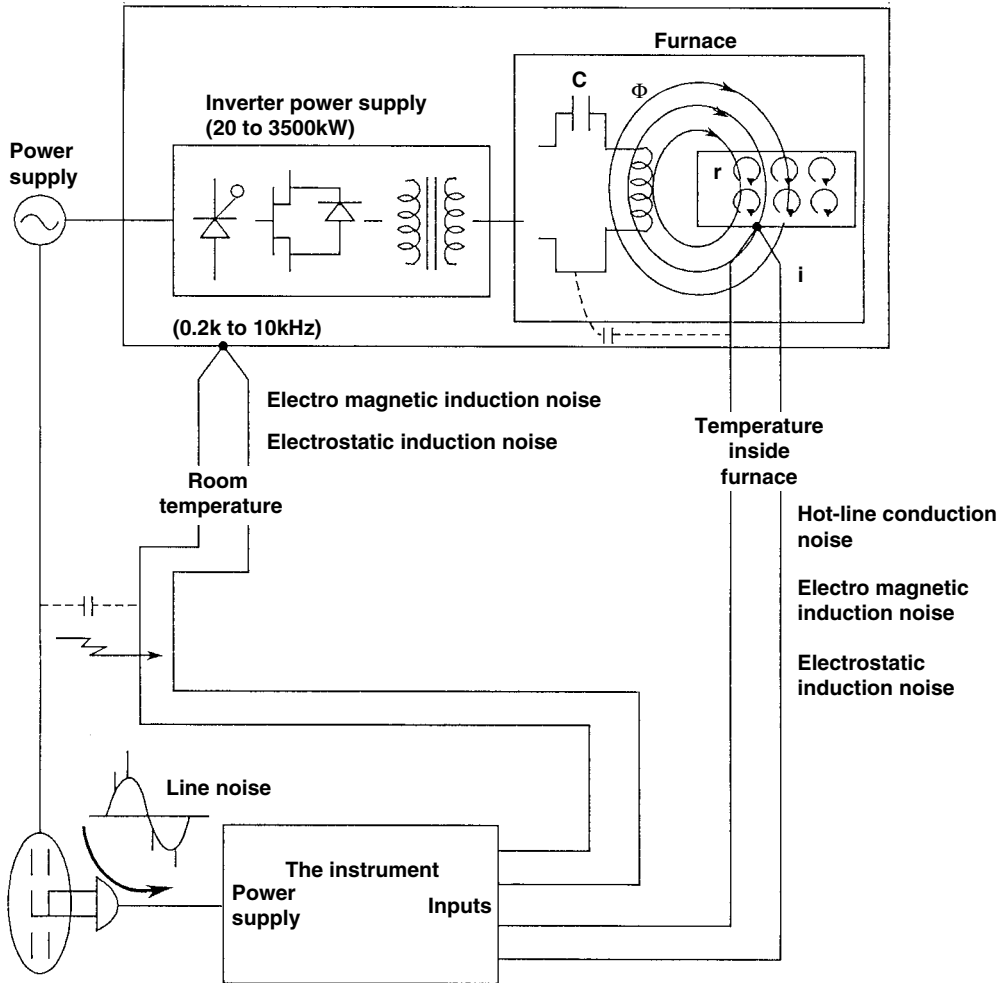

Basics of Anti-Noise Measures (part 1)

Common Mode Noise and Normal Mode Noise

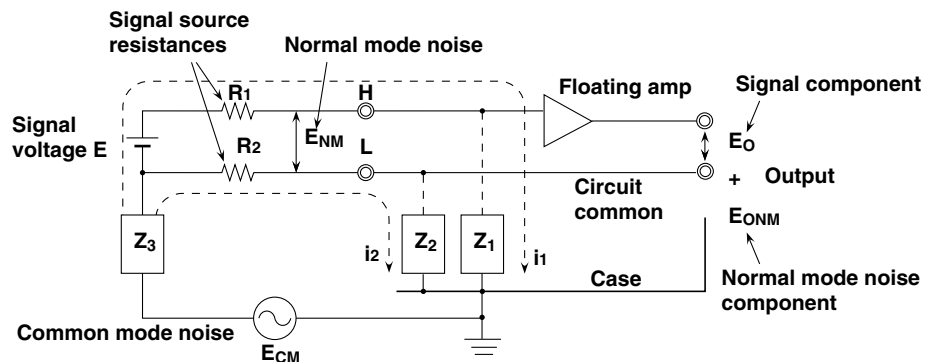

Common Mode Noise (E_{CM})

Noise generated between the signal source and the ground of a measuring instrument. Since it is applied to both the H and L input terminals in phase with one another, it is also called in-phase voltage.

Normal Mode Noise (E_{NM})

This is an unfavorable noise that is superimposed on a signal voltage. Since it is a voltage between the H and L terminals, it is also called the line voltage, or since it is a voltage in series with the signal voltage, it is sometimes called the series mode voltage.

In the figure on the previous page, due to common mode voltage E_{CM} , noise currents i_1 and i_2 flow through the impedance to grounds Z_1 and Z_2 and coupling impedance Z_3 , resulting in the generation of normal mode noise E_{NM} between input terminals H and L. Like this, common mode noise is converted to normal mode noise. The amp is equipped with a built-in filter and in case of output E_O the normal mode noise will be eliminated. This rate of conversion is called the common mode rejection ratio and expressed by the following equation.

- Common mode rejection ratio (**CMRR**) = $20 \text{Log} \frac{E_O}{E_{CM}}$ (dB)

Since the actual CMRR is expressed using the ratio of an error component output caused by common mode noise to common mode noise, it contains the normal mode rejection ratio (NMRR) expressed by the following equation.

- Normal mode rejection ratio (**NMRR**) = $20 \text{Log} \frac{E_O}{E_{NM}}$ (dB)

The NMRR is a value that shows the ability to reject the output error (normal mode noise component: E_{NM}) by normal mode noise. Thus, this is also a very important value which shows the resistance-to-noise characteristics of the measuring instrument.

Basics of Anti-Noise Measures (part 2)

Decreasing and Increasing Impedance

As described in the previous section, conversion of common mode noise into normal mode noise causes an error in the measured output. In other words, prevention of such a conversion is the key to anti-noise measures. As can be understood from the previous section, it is important to take the following measures to reduce normal mode noise.

- reduce the wiring resistances R_1 and R_2 , including the resistance of the wires.
- increase the coupling impedance of common mode voltage E_{CM} .

These are called the decrease and increase of impedance as basics of anti-noise measures.

In the above discussions, anti-noise measures have been described on the assumption that common mode noise has already been given. In real applications, common mode noise often occurs owing to grounding resistance as shown in the figure below.

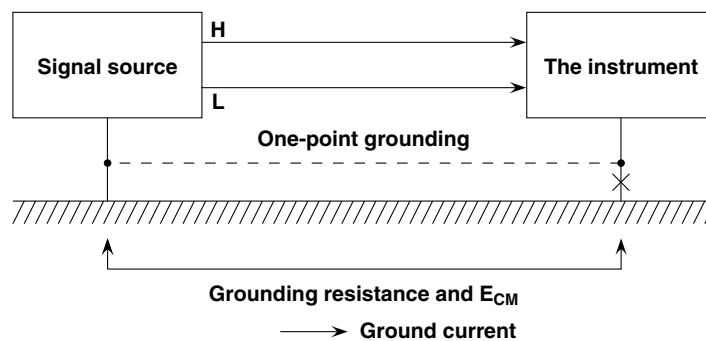

In such a case, perform one-point grounding as indicated by the dotted line, as an extreme example of decreasing impedance, to equalize the potentials of the signal source and the instrument. Rejecting common mode noise in this way is the basics of anti-noise measures.

Anti-Noise Measures in the Instrument Itself

Pulse width modulation type A/D converter (PWM type A/D)

This instrument uses a feedback pulse width modulation type A/D converter and has the following features:

- Linearity and stability are good because of the feedback effect.
- Integration type A/D converter ensures excellent noise suppression.

If the integration time is equal to the noise period, the positive and negative sides of the shaded part in the figure below cancel each other out and thus the average value becomes zero.

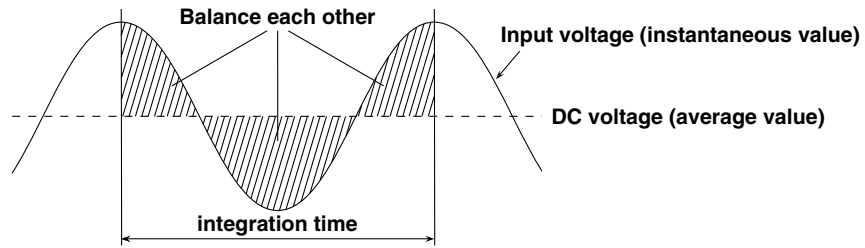

Normally, an integration time of 20ms (50Hz) or 16.7ms (60Hz) is selected depending on the commercial power supply frequencies. A 100-ms integration mode is added to the instrument to achieve superior noise rejection. However, when using the 100ms setting, the smallest measurement interval is longer than in case of the 20ms or 16.7ms setting. The integration effect enables the PWM A/D converter to perform the following two functions.

- Rejection of frequency determined by the reciprocal of the integration time and frequencies which are whole multiples of that frequency;
- First-order lag filter provided with cut-off frequency proportional to the reciprocal of the integration time.

The following table compares the integration times of 16.7ms, 20ms and 100ms.

Integration time	Rejection frequency	Cut-off frequency	Remarks
16.7ms	$n \times 60\text{Hz}$	approx. 19Hz	for 60Hz
20.0ms	$n \times 50\text{Hz}$	approx. 16Hz	for 50Hz
100.0ms	$n \times 10\text{Hz}$	approx. 3.2Hz	for both 50Hz/60Hz

$n=1,2,3\dots$

As shown in the table, the merit of 100.0-ms integration is not only that it applies to both 50 and 60Hz, but also that it provides a low cut-off frequency as the first-order lag filter and improves the noise rejection ability.

The following figure shows the calculation values of the NMRR for three integration times and an example of actual measurement of the NMRR for a 100-ms integration signal.

- Calculated values of NMRR
- Example of actual measurement of NMRR (100ms)

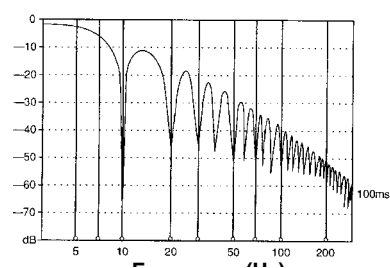
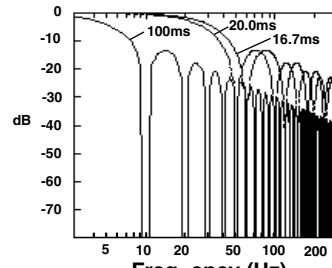

Noise Filter

This instrument is equipped with a low-pass filter (cutoff-frequency of 10Hz (for both 50/60 Hz), 50Hz,60Hz) which functions as a way of noise rejection. Also exponential averaging functions as a noise filter.

Anti-Noise Measures: Applications

Practical Measures

- **Reducing noise itself**

The basics of this practical measures dictates using the instrument in conditions where noise is suppressed as much as possible.

- for power lines: an increase of impedance;
Separate the power lines for noise source equipment (inverter, thyristor, etc.) from those for the measuring instrument.

- for input lines: an increase of impedance;
Always separate the input line from the noise source lines (power and alarm lines).
Step 1 : Install a separator.

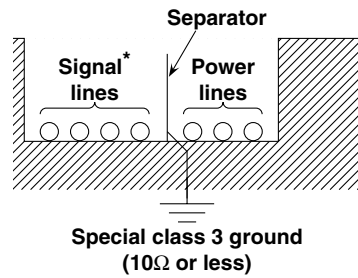

- Step 2 : Keep the signal cables at least 15cm above the power lines using a bracket.
If the power lines are not shielded, the operating voltage is 220V or less, and the operating current is 10A or more, the distance between the signal cables and power cords must be 60cm or more.

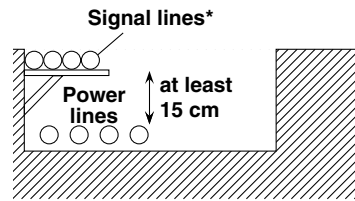

- Step 3 : Leave a clearance of at least 15 cm between the signal lines and power lines.
If the power lines are not shielded, the operating voltage is 220V or less, and the operating current is 10A or more, the distance between the signal cables and power cords must be 60cm or more.

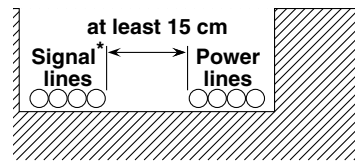

- Step 4 : Lay the signal lines at right angles to the power lines.
If the power lines are not shielded, separate the signal lines and power lines where they cross using steel sheeting at least 1.6mm thick.

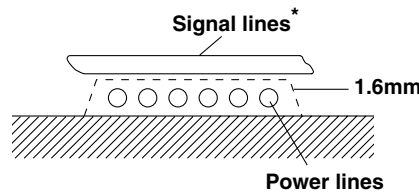

* Separate analog signal lines and communication cables in the same manner as from power cords.

- **When there is influence from a magnetic or electrical field: an increase of impedance**

Step 1 : Keep the noise source as far away as possible.

$$\text{Magnetic field strength } H = \frac{I}{2\pi r} = \frac{2,400}{6} = 400 \text{ [A/m]}$$

Example

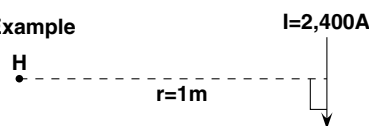

The influence of the external magnetic field on the measuring instrument: 400A/m or less.

Step 2 : Change the position of the noise source.

A) Leakage magnetic flux of transformer:

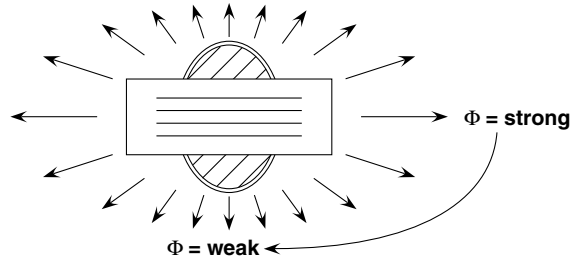

Move the instrument to a location where the influence from magnetic flux is weak.

B) Sparks

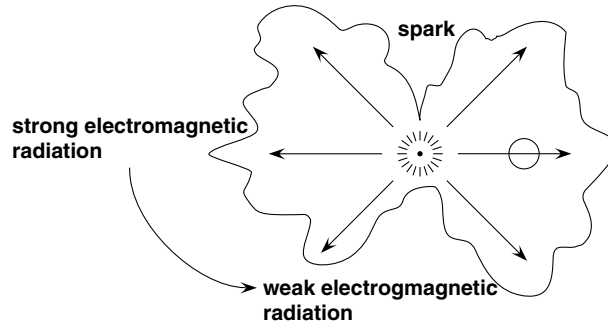

Move the instrument to a location where the influence from electromagnetic radiation is weak.

• **Grounding: a decrease of impedance**

The grounding method is the point of common mode noise suppression.

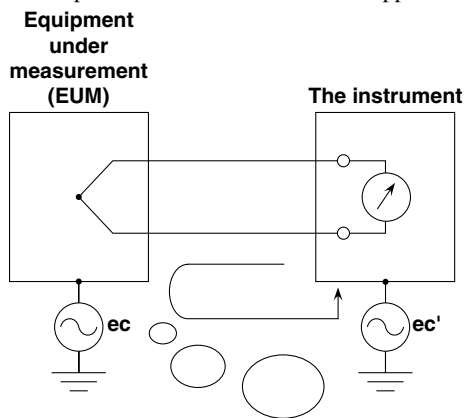

The difference in the potential to the ground between EUM and the instrument may cause a ground current, resulting in noise.

Equalize the potentials to the ground so that the common mode noise becomes zero.

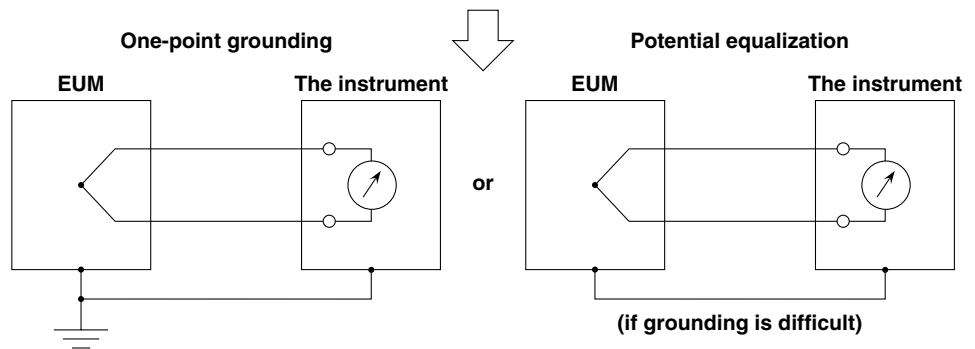

The basic means to obtain stable measurement is to set the circuit potential with proper grounding. Thus, potential equalization is the means to be adopted only when grounding is impossible.

• **Shielded and twisted pair (prevention of electromagnetic coupling): an increase of impedance**

If it is difficult to keep the noise source away from the measuring instrument due to space limitations, the use of a shielded twisted pair is effective.

- electrostatic coupling can be completely cut off by shielding;
- for a magnetic field, shielding with a magnetic material (iron, permalloy, etc.) can be employed. However, there are many restrictions on this use and perfect shielding is impossible. Therefore, use of a twisted pair is preferable.

Voltage e_m induced by the coil is proportional to the area of the coil.

=> The smaller the area of the coil becomes, the smaller the noise becomes.

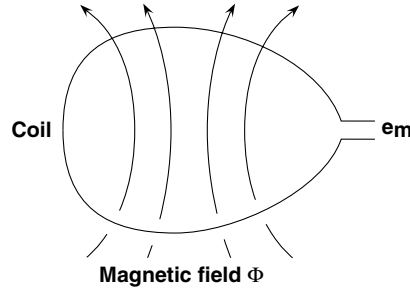

If the directions of coils 1 and 2 are reversed by twisting, as shown, if the areas of the two coils are equal, the induced voltages of the coils offset each other and total induced voltage e_m becomes zero.

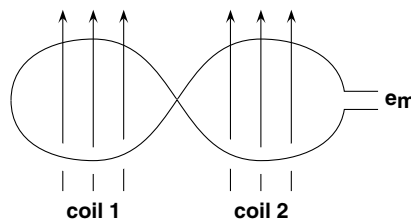

The above two principles are combined as a twisted pair.

Even though a shielded twisted pair is used, a proper grounding method is still important.

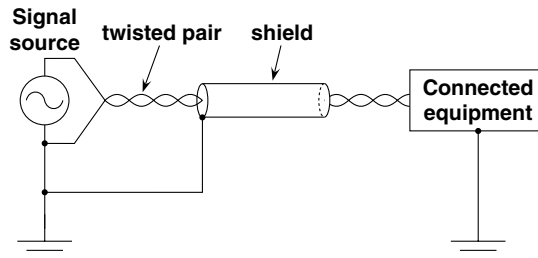

If the signal source is not grounded

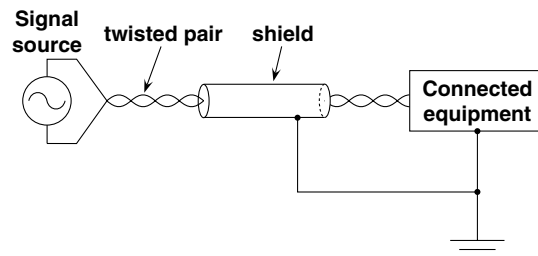

Ground the signal cable shields collectively but separately from the power line ground. If the separation of grounds is impossible, use the guard terminal.

- Insertion of noise filter and noise killer

If the influence from noise cannot be eliminated by the methods described before, use noise filter or noise killer.

Power line noise rejection

Step 1 : Insert an isolation transformer into the power line.

Increasing impedance to high frequency

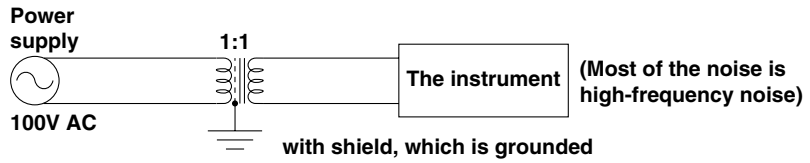

Step 2 : Insert a power line noise filter (available on the market)

High frequency noise is divided by decreasing impedance to ground through C and increasing impedance through L.

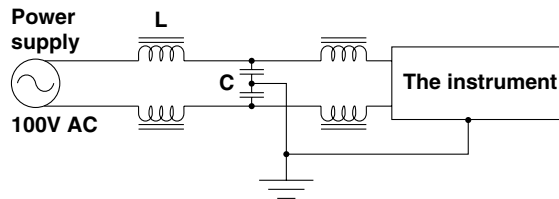

Note 1: Ground the noise filter and the recorder in common.

Note 2: Since insertion of a noise filter increases the by-pass current (regarded as leakage current), make sure that the leakage current is within the specified value.

- When the noise contains wide frequency components

While one-point grounding is effective at a low frequency, it sometimes forms a loop and has an adverse effect on a high frequency.

Ex: Connecting a power meter and The instrument grounded at one point to an inverter

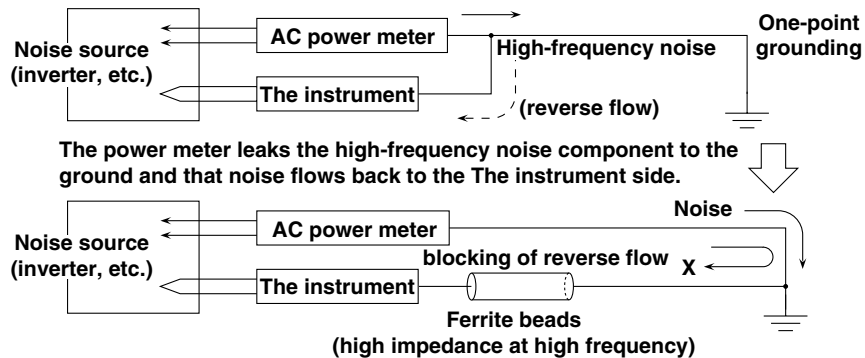

Reverse flow of high-frequency to the The instrument is thus suppressed.

- Input noise rejection

If input noise cannot be rejected by means of one-point grounding or 100-ms integration, insert capacitor or ferrite beads as they are effective in rejecting pulse noise.

Step 1 : Connect a capacitor between the L input and ground.

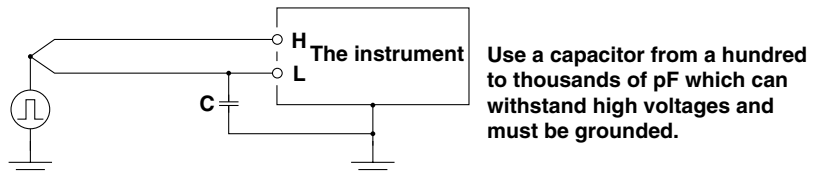

Step 2 : Rejection of pulse noise when grounding is impossible.

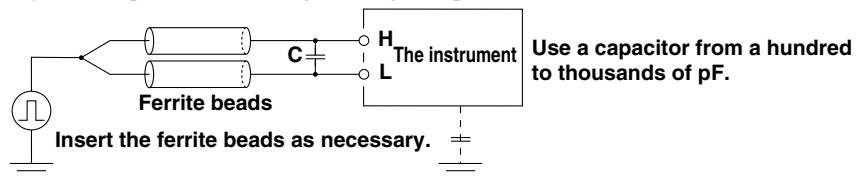

- Relay noise suppression

<DC relay>

- To prevent noise and protect the contact, connect the diode to the relay coil terminal directly.
- In addition to the above measure, reduce the rated voltage of the relay circuit as much as possible for higher reliability.
- It is necessary to choose a diode that matches the relay. Generally, a diode whose rated rectifying current is at least three times the current flowing through the relay coil must be used. And the rated reverse voltage must be at least three times the operating voltage.

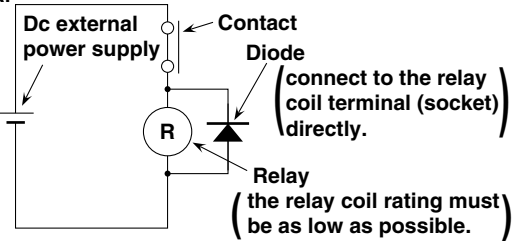

(Note) Across the relay or solenoid coil, a counter-electromotive force is produced by an inductive load. This phenomenon may damage the contact or, as the noise source, cause a malfunctioning of the equipment, and have an unfavorable effect on the entire system.

<AC relay>

- If a relay contact is connected to the input of the system components, apply the measure shown in the figure at the right to the relay coil. Otherwise, a counter-electromotive force produced across the coil may be induced on the contact side through the relay's internal coupling or coupling between the lines, and may cause a malfunctioning of the equipment.

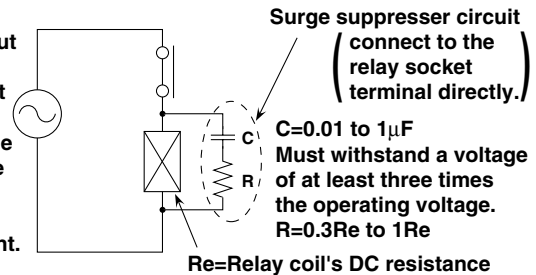

- Others (isolation from noise source: for hot line measurement)

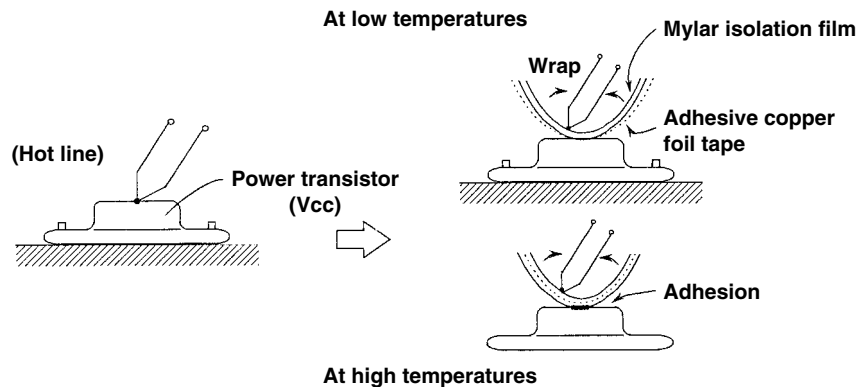

Anti-Noise Measures for PC Connection

When connecting the The instrument to a PC, it is recommended to apply ferrite cores (e.g. ZCAT3035-1303 from TDK) to the interface cable as a noise countering measure. Apply a ferrite core on both sides of the cable as shown below, when the noise persists, apply more ferrite cores.

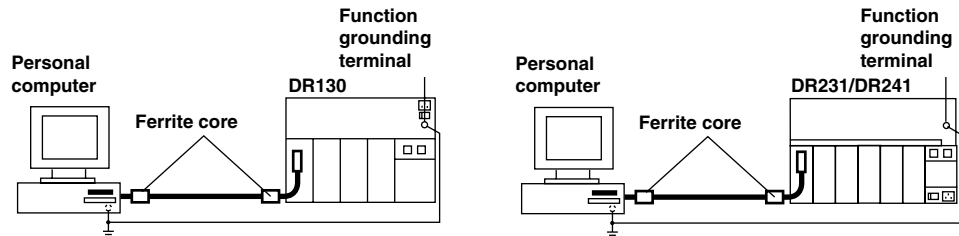

4.1 Using the AUTO Mode

Explanation

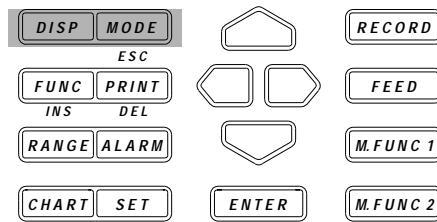

Operating Procedure

AUTO Mode for the Main Display

- 1 Select the main display using the DISP key. Direct the arrow mark on the Sub-display upward.
- 2 Select "AUT" using the MODE key.

Sub-display 1

003	0.0045V	004	0.0931V	▲AUT
-----	---------	-----	---------	------

AUTO Mode for Sub-display 1

- 1 Select sub-display 1 using the DISP key. Direct the arrow mark on the Sub-display leftward.
- 2 Select "AUT" using the MODE key.

Sub-display 1

004	0.0926V	005	0.0824V	◀AUT
-----	---------	-----	---------	------

AUTO Mode for Sub-display 2

- 1 Select sub-display 2 using the DISP key. Direct the arrow mark on the Sub-display downward.
- 2 Select "AUT" using the MODE key.

Sub-display 1

005	0.8210V	006	0.0095V	▼AUT
-----	---------	-----	---------	------

Explanation

AUTO Mode for the Main Display

• **Channel No.**

The first seven characters are used. The first three characters are used to display the channel number. The first character always displays “0”. “A” will be displayed in the case of optional computation channels.

If you selected TAG at the channel No./TAG setting in the set-up mode (refer to 10.2 on page 10-4), the assigned tag will appear for each channel.

- The first 7 characters of the TAG setting will be displayed;
- If the TAG setting consists of only spaces, the channel number will be displayed instead;
- If the first character of the TAG setting is a space, the 2nd to 8th character will be displayed.

• **Difference between Channels (delta)**

One character is used to let you know that difference between channels (delta) is displayed. However, it will not be displayed in the case of optional computation channels.

Only if you selected the difference between channels (delta) as the input type, “d” will be displayed here.

• **Alarms**

Two characters are used for displaying alarms. One character is used in the case of optional computation channels.

When an alarm occurs, the kind of alarm will be displayed. When in one channel several alarms occur at the same time, the priority of display becomes H > L > dH > dL > RH > RL. For details on H, L, dH, dL, RH and RL alarms, refer to page 8-2.

• **Measurement Values**

Seven characters are used for displaying the measurement values. The decimal point uses up one character. Nine characters is used in the case of optional computation channels.

When a measurement value does not reach the following value, “-*****” will be displayed.

- DC voltage: a minimum value of the measuring range – (max. value – min. value) × 0.05
- TC/RTD: min. value of the measurement range –10°C
- Linear scaling: –32000, or a minimum value of the recording span – (max. value – min. value) × 0.05

When a measurement value exceeds the following value, “+*****” will be displayed.

- DC voltage: a maximum value of the measuring range + (max. value – min. value) × 0.05
- TC/RTD: min. value of the measurement range +10°C
- Linear scaling: +32000, or a maximum value of the recording span + (max. value – min. value) × 0.05

If the input module is not connected properly, “XXXXXX” will be displayed.

While waiting for an input signal “OOOOOO” will be displayed.

• **Engineering Units**

If the channel number has been selected to appear on the display, six characters are used for displaying engineering units. If TAG has been selected to appear on the display, only three characters are used for displaying units. Only the first three characters of the unit setting will then be displayed, even if the first character of the unit setting is a space.

When “XXXXXX” or “OOOOOO” are displayed as measurement value, no engineering unit will be displayed.

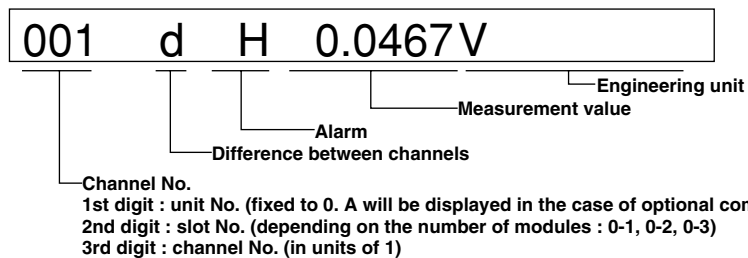

• **Others**

If you selected “SKIP” as the input type, that channel will not be displayed.

When the input type of all channels is set to “SKIP”, “***ALL SKIP***” will be displayed.

AUTO Mode for Sub-display 1

Data of two channels are displayed here simultaneously.

- **Channel No., Difference between Channels (delta), Alarms, Measurement Values**

Same as for the main display.

- **Engineering Units**

If the channel number has been selected to appear on the display, the first four characters of the unit setting are used for displaying engineering units. If TAG has been selected to appear on the display or when “XXXXXX” or “OOOOOO” are displayed as measurement value, no engineering unit will be displayed.

- **Selected Display Mode (refer to page 4-1 for procedure)**

This only appears on sub-display 1 when monitoring. The arrow shows to which display the display mode refers.

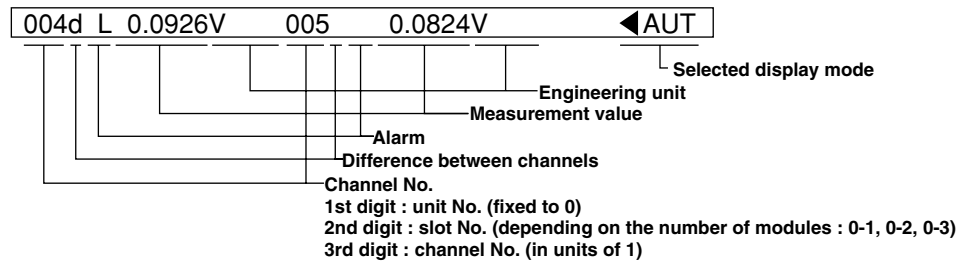

- **Others**

Same as for the main unit.

AUTO Mode for Sub-display 2

Data of two channels are displayed here simultaneously.

- **Channel No., Difference between Channels (delta), Alarms, Measurement Values, Engineering Units and Selected Display Mode**

Same as for the sub-display 1.

- **Others**

Same as for the sub-display 1.

Points to Note when Using the AUTO Mode

- When all three displays are set to AUTO mode, the main display will start displaying data of the channel with the smallest channel number, on sub-display 1 data of the next two channels will be displayed, while on sub-display 2 data of the next two channels will be displayed. When the data are updated, the display will be replaced with data of the next, consecutive, channel.
- When the input type of all channels is set to “SKIP”, then depending on the display settings as described below, “***ALL SKIP***” will be displayed.
 - When the main display is set to AUTO mode, then this will be displayed on the main display, regardless of the settings of sub-display 1 and 2.
 - When sub-display 1 is set to AUTO mode, and the main display is set to any other mode than AUTO, then this will be displayed on sub-display 1, regardless the setting of sub-display 2.
 - When sub-display 2 is set to AUTO mode, and the main display is set to any other mode than AUTO, and sub-display 1 to any other mode than AUTO, then this will be displayed on sub-display 2.
- When on any of the main, sub-display 1 or sub-display 2 “***ALL SKIP***” appears, other displays which may have been set to AUTO will turn blank. Only the selected display mode on sub-display 1 and the status display will appear.

4.2 Using the MANUAL Display

Relevant Keys

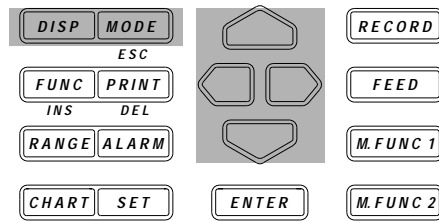

Operating Procedure

MANUAL Display for the Main Display

- 1 Select the main display using the DISP key.
- 2 Select "MAN" using the MODE key.

Sub-display 1

002	0.0034V	003	0.0920V	▲MAN
-----	---------	-----	---------	------

- 3 Select the required channel using the keys.

Main display

001	0.0057V
-----	---------

MANUAL Display for Sub-display 1

- 1 Select sub-display 1 using the DISP key.
- 2 Select "MAN" using the MODE key.

Sub-display 1

002	0.0422V	003	0.0726V	◀MAN
-----	---------	-----	---------	------

- 3 Select the right or left channel using the keys. A dash [—] will appear below the unit number of the selected channel.
- 4 Select the required channel using the keys.

Sub-display 1

006	0.0892V	003	0.0726V	◀MAN
-----	---------	-----	---------	------

MANUAL Display for Sub-display 2

- 1 Select sub-display 2 using the DISP key.
- 2 Select "MAN" using the MODE key.

Sub-display 1

005	0.0931V	006	0.0092V	▼MAN
-----	---------	-----	---------	------

- 3 Select the right or left channel using the keys. A dash [—] will appear below the unit number of the selected channel.
- 4 Select the required channel using the keys.

Sub-display 2

009	1.0075V	008	0.0154V
-----	---------	-----	---------

Explanation**MANUAL Display for the Main Display****• Channel No., Difference between Channels (delta) and Alarms**

Same as for the AUTO mode (refer to page 4-2).

• Measurement Values

Same as for the AUTO mode (refer to page 4-2), except for the following.

When the input type of the channel is set to “SKIP”, then “SKIP” will be displayed.

When the channel other than the channel of the input module is selected, “- - - - -” appears.

• Engineering Units

Same as for the AUTO mode (refer to page 4-2), except for the following.

When the input type of the channel is set to “SKIP”, then no engineering unit will be displayed.

MANUAL Display for the Sub-display 1 and 2

Data of two channels are displayed here simultaneously on each display.

• Channel No., Difference between Channels (delta), Alarms and Selected Display Mode

Same as for the AUTO mode (refer to page 4-3).

• Measurement Values

Same as for the AUTO mode (refer to page 4-3), except for the following.

When the input type of the channel is set to “SKIP”, then “SKIP” will be displayed.

When the channel other than the channel of the input module is selected, “- - - - -” appears.

• Engineering Units

Same as for the AUTO mode (refer to page 4-3), except for the following.

When the input type of the channel is set to “SKIP”, then no engineering unit will be displayed.

4.3 Using the PAGE Display

Relevant Keys

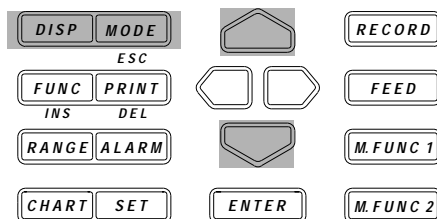

Operating Procedure

- 1 Select the main display using the DISP key.
- 2 Select "PGE" using the MODE key.

Sub-display 1

002	0.1936V	003	0.0995V	▲PGE
-----	---------	-----	---------	------

- 3 Select the required set of five channels (page) using the keys.

Display

006	0.0173V			
007	0.0197V	008	0.0074V	▲PGE
009	0.0162V	010	0.0102V	

Explanation

PAGE Display for the Main Display

When this display is selected, the measurement values of five consecutive channels will be displayed using sub-display 1 and 2 also.

- **Channel No., Difference between Channels (delta) and Alarms**
Same as for the AUTO mode (refer to page 4-2).
- **Measurement Values**
Same as for the AUTO mode (refer to page 4-2), except for the following.
When the input type of the channel is set to "SKIP", then "SKIP" will be displayed.
When the channel other than the channel of the input module is selected, "- - - - -" appears.
- **Engineering Units**
Same as for the AUTO mode (refer to page 4-2), except for the following.
When the input type of the channel is set to "SKIP", then no engineering unit will be displayed.

PAGE Display for the Sub-display 1 and 2

In combination with the page display of the main display, data of two channels are displayed here simultaneously on each display. Other display modes cannot be selected.

- **Channel No., Difference between Channels (delta), Alarms and Selected Display Mode**
Same as for the AUTO mode (refer to page 4-3).
- **Measurement Values**
Same as for the AUTO mode (refer to page 4-3), except for the following.
When the input type of the channel is set to "SKIP", then "SKIP" will be displayed.
When the channel other than the channel of the input module is selected, "- - - - -" appears.
- **Engineering Units**
Same as for the AUTO mode (refer to page 4-3), except for the following.
When the input type of the channel is set to "SKIP", then no engineering unit will be displayed.

4.4 Using the ALARM SEARCH Display

Relevant Keys

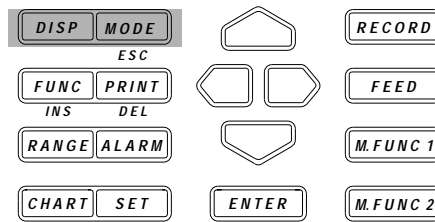

Operating Procedure

ALARM SEARCH Display for the Main Display

- 1 Select the main display using the DISP key.
- 2 Select "SER" using the MODE key.

Sub-display 1

003 0.0054V 004 0.0319V ▲SER

ALARM SEARCH Display for Sub-display 1

- 1 Select sub-display 1 using the DISP key.
- 2 Select "SER" using the MODE key.

Sub-display 1

004 H 0.0269V 005 RH 0.0248V ◀SER

ALARM SEARCH Display for Sub-display 2

- 1 Select sub-display 2 using the DISP key.
- 2 Select "SER" using the MODE key.

Sub-display 1

005 0.2108V 006 0.0951V ▼SER

Explanation

ALARM SEARCH Display for the Main Display

Only the channels in which an alarm occurred, will be displayed. When an alarm occurs in several channels, the channels will be displayed consecutively.

- **Channel No., Difference between Channels (delta), Alarms, Measurement Values and Engineering Units**

Same as for the AUTO mode (refer to page 4-2).

- **Others**

When the input types of all channels are set to "SKIP" or no alarms occur, "***NO ALARM***" will be displayed.

ALARM SEARCH Display for the Sub-display 1 and 2

Only the channels in which an alarm occurred, will be displayed. Two channels will be displayed on each sub-display.

- **Channel No., Difference between Channels (delta), Alarms, Measurement Values, Engineering Units and Selected Display Mode**

Same as for the AUTO mode (refer to page 4-3).

Points to Note when Using the ALARM SEARCH Display

- When all three displays are set to ALARM SEARCH display, the main display will start displaying data of the channel with the smallest channel number, on sub-display 1 data of the next two channels will be displayed, while on sub-display 2 data of the next two channels will be displayed. When the data are updated, the display will be replaced with data of the next, consecutive, channel.
- When the input type of all channels is set to “SKIP”, then depending on the display settings as described below, “***NO ALARM***” will be displayed.
 - When the main display is set to ALARM SEARCH display, then this will be displayed on the main display, regardless the settings of sub-display 1 and 2.
 - When sub-display 1 is set to ALARM SEARCH display, and the main display is set to any other mode than ALARM SEARCH, then this will be displayed on sub-display 1, regardless the setting of sub-display 2.
 - When sub-display 2 is set to ALARM SEARCH display, and the main display is set to any other mode than ALARM SEARCH, and sub-display 1 to any other mode than ALARM SEARCH, then this will be displayed on sub-display 2.
- When on any of the main, sub-display1 or sub-display 2 “***NO ALARM***” appears, other displays which may have been set to ALARM SEARCH will turn blank. Only the selected display mode on sub-display 1 and the status display on sub-display 2 will appear.

4.5 Using the BARGRAPH Display

Relevant Keys

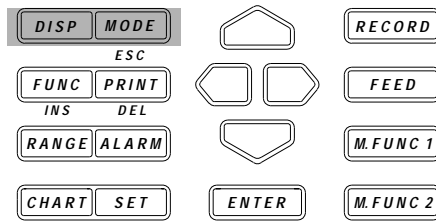

Operating Procedure

- 1 Select the sub-display 1 using the DISP key.
- 2 Select "BAR" using the MODE key.

Display

003	0.0172V
- 1.5000>	< 2.0000 ◀BAR
004 0.0153V	005 0.0123V

Explanation

Bargraph Display

Sub-display 1 can be turned into a bargraph display.

The measurement data on the main display are displayed as a bargraph on sub-display 1. The bargraph shows a graph corresponding to the measurement value, showing the recording span divided into 40 equal parts. The left side of the bargraph shows the left span, the right side of the bargraph shows the right span. When you are using the linear scaling function, the left and right side of the bargraph show the left scaling and right scaling value respectively. Engineering units are not displayed.

When the main display shows "SKIP", "***ALL SKIP***", "NO ALARM", "OOOOOO", "XXXXXX", or "-----" the bargraph will not appear. Only the selected display mode will appear.

4.6 Using the ALARM STATUS Display

Relevant Keys

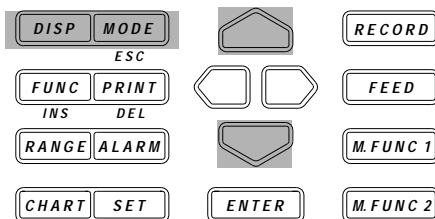

Operating Procedure

ALARM STATUS Display for Sub-display 1

- 1 Select the sub-display 1 using the DISP key.
- 2 Select "ALM" using the MODE key.

Sub-display 1

001□□□□□□□□ □□□□□□□□ □□□□□□□□◀ALM

- 3 Select the range to be displayed in blocks of 10 channels.

Sub-display 1

011□□□□□□□□ □□□□□□□□ ◀ALM

ALARM STATUS Display for Sub-display 2

- 1 Select the sub-display 2 using the DISP key.
- 2 Select "ALM" using the MODE key.

Sub-display 1 and 2

001□□□□□□□□ □□□□□□□□ □□□□□□□□▼ALM
001□□□□□□□□ □□□□□□□□ □□□□□□□□

- 3 Select the range to be displayed in blocks of 10 channels.

Sub-display 1 and 2

001□□□□□□□□ □□□□□□□□ □□□□□□□□▼ALM
011□□□□□□□□ □□□□□□□□

Explanation

Alarm Status Display

The status of alarms can be displayed on sub-display 1 and 2. On each sub-display the alarms of maximum 30 channels can be monitored which also depends on the number of input channels. The display shows "□" for channels where no alarm has occurred, and shows "■" for channels where an alarm has occurred. The relation between the alarm status display and channel number is as shown below. The first character of the setting is always "0".

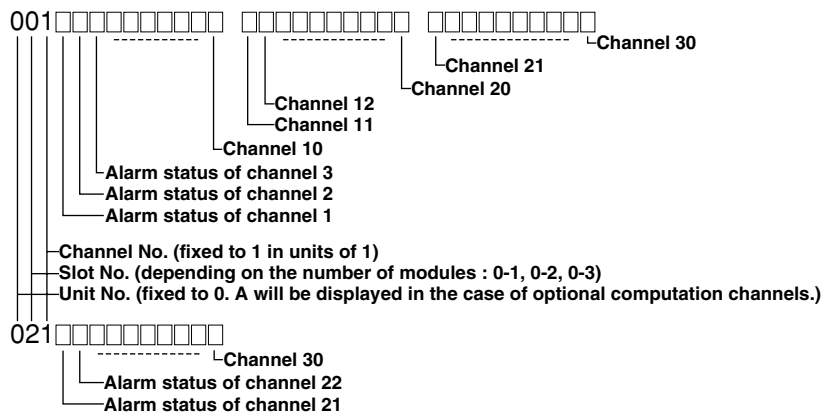

Relation between the Relay Status and Internal Switch

If the relay status of the internal switches is being displayed, an “S” will be displayed as the first character. The next two characters show the number of the internal switch which corresponds to the first batch of the display and range from 01 to 51. There are 60 internal switches.

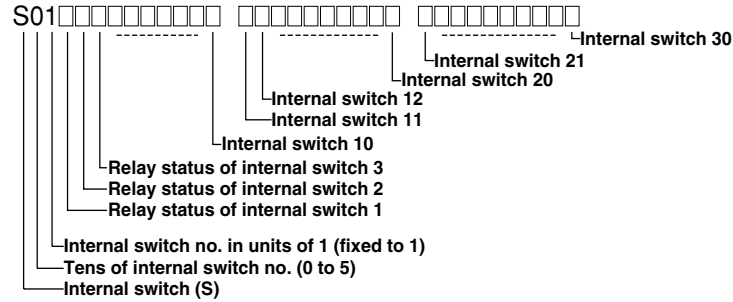

Relation between the Relay Status and Alarm Output Relay (optional)

If the relay status of the alarm output relays is being displayed, a “0” will be displayed as the first character. The next character shows the slot number at which the alarm module (/A4 option) or DI/DO module (/R1 option) is connected. This number depends on the number of input channels and whether or not the communication interface option is present.

The display of the relay status for the alarm output relays depends on the installed options and is as follows.

- When the alarm module is installed (/A4 option), 10 indicators are reserved for “□” or “■” display.
- When the DI/DO module is installed (/R1 option), 10 indicators are reserved for “□” or “■” display, although the alarm output relays correspond to the first two indicators on the left, whereas the other eight indicators are not used.
- When both the alarm module and the DI/DO module are connected, 20 indicators are reserved for “□” or “■” display. The left 10 indicators are used for displaying the status of alarm output relays for the alarm module, whereas the right 10 indicators are used for displaying the status of the alarm output relays for the DI/DO module. In this case the first two indicators of the second batch correspond to the alarm output relays, whereas the other eight are not used.

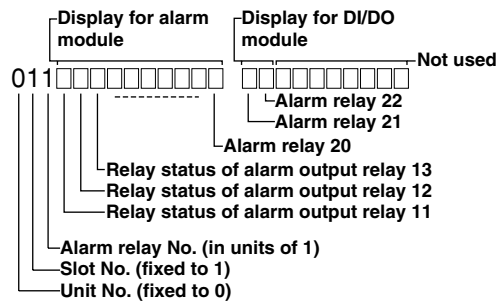

4.8 Using the CLOCK (Date & Time) Display

Relevant Keys

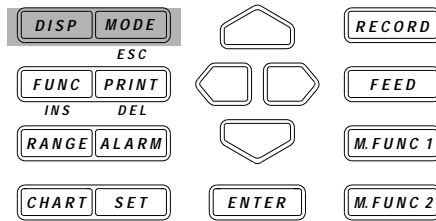

Operating Procedure

- 1 Select the sub-display 2 using the DISP key.
- 2 Select "CLK" using the MODE key.

Sub-display 1 and 2

005	0.8210V	006	0.0095V	▼CLK
Dec. 30. 95 13:16:19				

Explanation

Clock Display

The date and time can be displayed on sub-display 2.

According to the set time in 3.7 "Setting the Date and Time" (see to page 3-19), the current date and time can be displayed.

The display shows the month, day, year and hour, minute, second in this sequence.

5.1 Setting the Type of Input and Recording Span

Relevant Keys

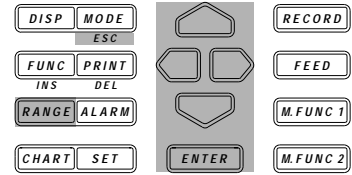
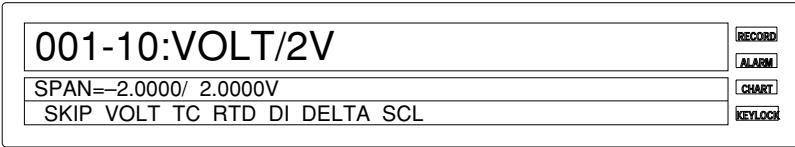

Operating Procedure

- Press the RANGE key to enter the RANGE menu.
- Select/set using the \triangle ∇ keys.
- To escape from a lower menu, press the MODE (ESC) key. Its main menu will appear, although new settings/selections will not be kept.
- New settings/selections will be kept when you reach the final display of that setting.

(Main menu)

001-01:VOLT/2V ∇

>Select Channel No.

001-01:VOLT/2V ∇

>Select Channel No.

(Lower menu)

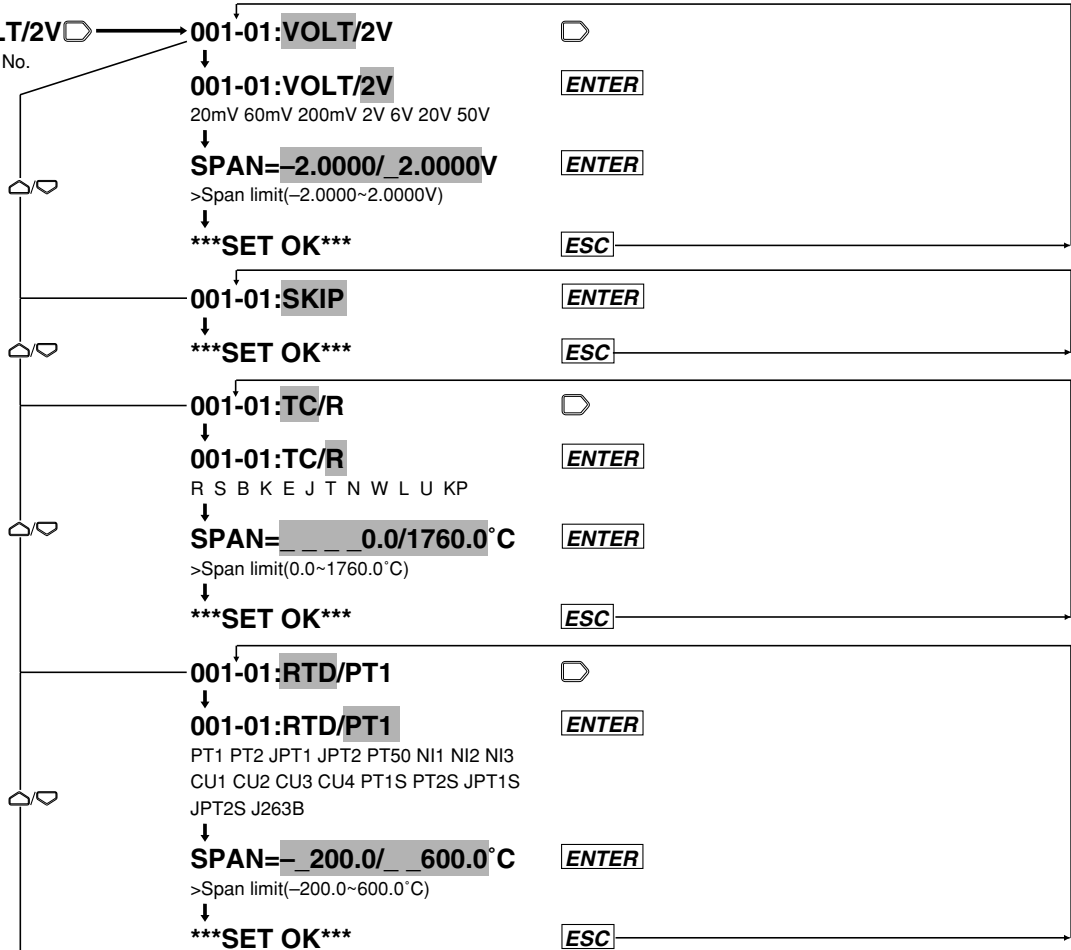

To the next page



Explanation

Setting the Channel No.

This setting specifies the channels to which the type of input and recording span applies. You can set a range of channels by specifying the first (begin) and the last channel (end).

First Channel No. (Begin)

The first three characters on the main display show the number of the first channel to which settings apply.

Default is "001", and the first character is always "0". The setting ranges from 001 to the maximum number of input channels of your unit (010 for 10 input channels; 020 for 20 input channels; 030 for 30 input channels).

Last Channel No. (End)

The two characters following the first channel number show the number of the last channel to which settings apply.

Default is "01". The setting ranges from 01 to the maximum number of input channels of your unit. The number of the last channel cannot be smaller than the number of the first channel. When both channel numbers are equal, settings will only apply to that particular channel. When you have set the first channel number and you move the cursor to the last channel setting, the channel number of the first channel setting will appear here.

Selecting the Type of Input

The following types of input can be selected. The default setting is VOLT.

- SKIP
Measurement, recording and display (except for page display) will not be carried out. Measurement, recording and display will be carried out for the next channel whose input type is not set to SKIP.
- VOLT (DC voltage)
This input type can be selected from 20mV, 60mV, 200mV, 2V, 6V, 20V and 50V. Refer to chapter 14 for the measurement range of each setting. The default setting is 2V.
- TC (thermocouple)
This input type can be selected from R, S, B, K, E, J, T, N, W, L, U and KP (KPvsAU7Fe). Refer to chapter 14 for the measurement range of each setting. The default setting is R.
- RTD (resistance temperature detector)
This input type can be selected from PT1 (Pt100 1mA), PT2 (Pt100 2mA), JPT1 (JPt100 1mA), JPT2 (JPt100 2mA), PT50 (Pt50 2mA), NI1 (Ni100 1mA SAMA), NI2 (Ni100 1mA DIN), NI3 (Ni120 1mA), CU1 (Cu10 GE), CU2 (Cu10 L&N), CU3 (Cu10 WEED), CU4 (Cu10 BAILEY), PT1S (Pt100 1mA high resolution), PT2S (Pt100 2mA high resolution), JPT1S (JPt100 1mA high resolution), JPT2S (JPt100 2mA high resolution) and J263B (J263*B). Refer to chapter 14 for the measurement range of each setting. The default setting is PT1.
- DI (voltage level: LEVL; contact:CONT)
This input type can be selected from LEVL and CONT.
In case of LEVL, a voltage of less than approx. 2.4 V will be recognized as “0 (OFF)”, whereas a voltage of approx. 2.4V or more (max. allowable voltage is up to ± 60 VDC) will be recognized as “1 (ON)”.
In case of CONT, an open, externally connected contact to which no voltage is applied, will be recognized as “0 (OFF)”, whereas a closed contact will be recognized as “1 (ON)”.
The default setting is LEVL.
- DELTA (difference between channels)
Destination channels should lie within the first channel No. to the last channel No. range. The number of the reference channel should be lower than the number of the destination channels. The default setting for the reference channel is 01. The type of input and the measuring range in the destination channel are the same as for the reference channel. After setting the DELTA (difference between channels), if you attempted to change the type of input and the measuring range, setting the difference between channels is released, thereby the type of input and the measuring range in the destination channel are returned to their original settings, and the recording span is returned to its initial value.
- RRJC (Remote RJC, available if the instrument is equipped with the optional MATH function)
Reference channel (RJC): Within the setting range of reference channel No.
TC (thermocouple) must be selected as the type of input to the reference channel.
If the channel No. or type of input for the reference channel, or the type of thermocouple is changed, the alarm and partial compression recording functions will be turned OFF.
If the type of input for the reference channel or the type of thermocouple is changed, the RRJC settings will be cleared and the type of input and measuring range for the reference channel will be set to the one which was in effect before the change was made. The recording span will be set to the initial value of the measuring range.

Setting the Recording Span

The measurement range is decided according to the type of input. The recording left and right span must lie within the measurement range. However, the recording span is 0 to 1 for the DI input type. The value on the left side of the SPAN menu shows the left span, and the value on the right side of the SPAN menu shows the right span.

For the remote RJC, the setting range for recording span is the same as that for the reference channel.

5.2 Setting Linear Scaling and the Recording Span

Relevant Keys

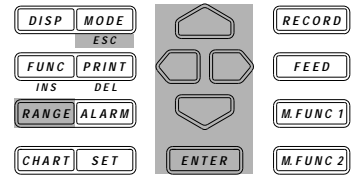
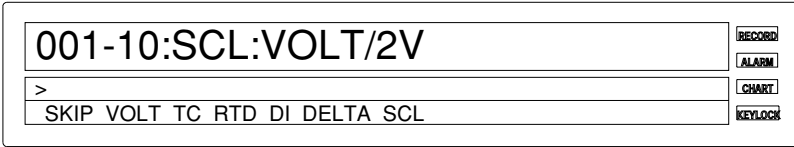

Operating Procedure

- Press the RANGE key to enter the RANGE menu.
- Select/set **█** using the **◀ ▶** keys.
- To escape from a lower menu, press the MODE (ESC) key. Its main menu will appear, although new settings/selections will not be kept.
- New settings/selections will be kept when you reach the final display of that setting.

(Main menu)

001-01:VOLT/2V ◻

>Select Channel No.

001-01:VOLT/2V ◻

>Select Channel No.

(Lower menu)

001-01:VOLT/2V

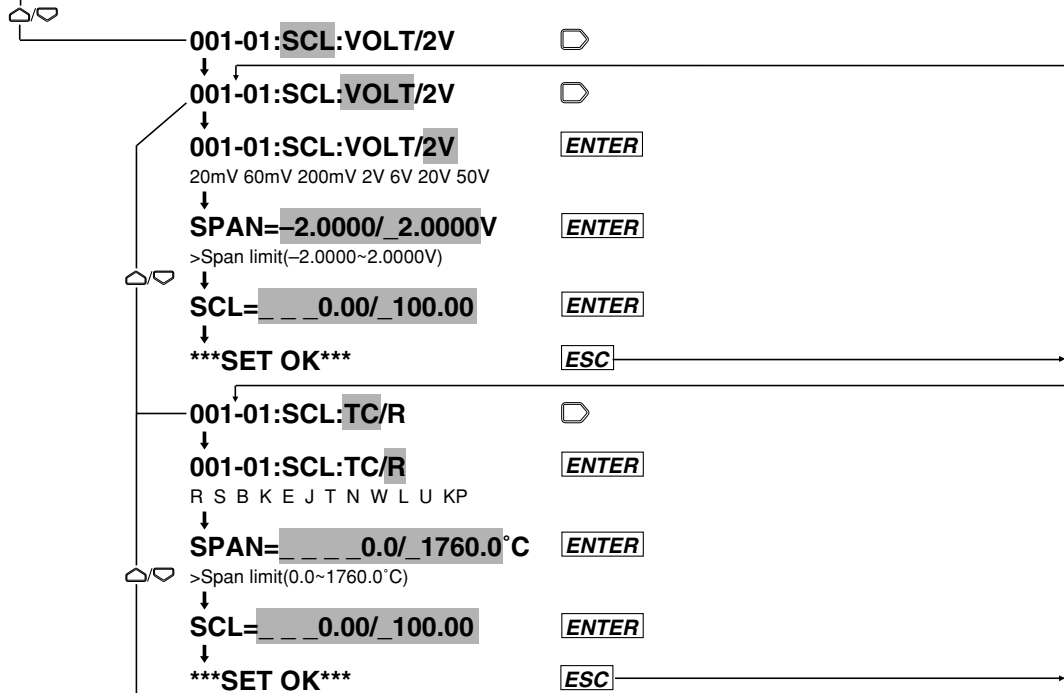

To the next page

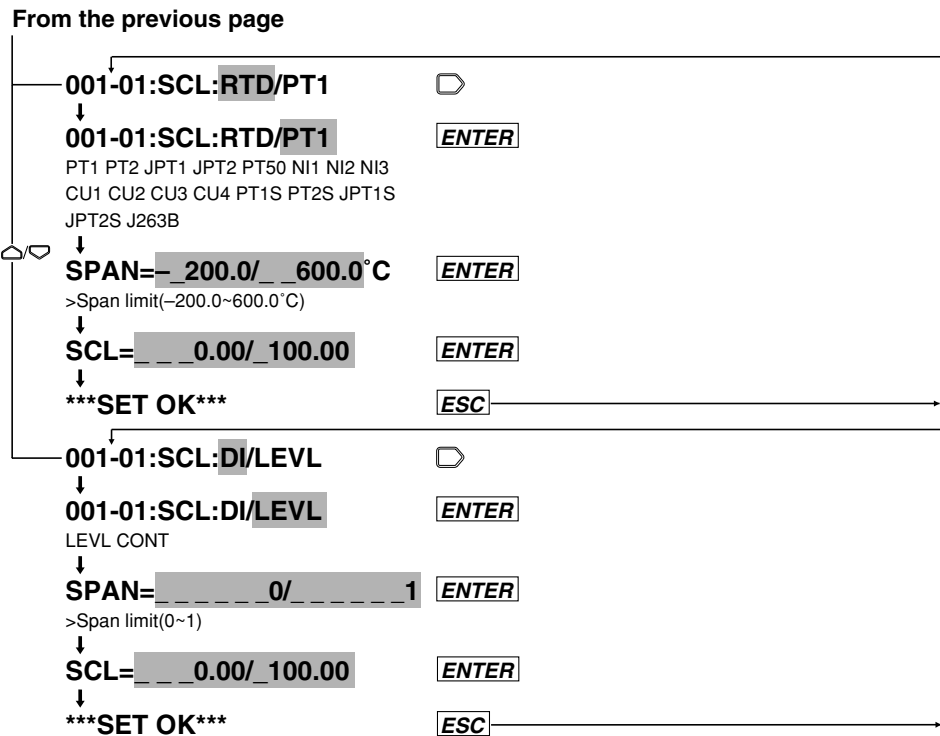

Explanation

The setting of the channel number is the same as explained in 5.1 on page 5-2. The following explanation assumes that you already carried out the channel setting and that you selected “SCL” as the input type.

Selecting the Input Type for Linear Scaling

The input type can be selected from the following. The default setting is VOLT.

- VOLT (DC voltage)
Refer to page 5-3.
- TC (thermocouple)
Refer to page 5-3.
- RTD (resistance temperature detector)
Refer to page 5-3.
- DI (contact)
Refer to page 5-3.

Setting the Recording Span

Refer to page 5-3.

Setting the Scaling Values (SCL)

The left scaling and right scaling values are set following the left and right span values of the span menu. The value on the left side of the SCL menu shows the left scaling value, and the value on the right side of the SCL menu shows the right scaling menu. The setting ranges from -30000 to 30000.

The decimal point can be set in any position of the scale as shown below. Set it when the left scale is set.

"□.□□□□," "□□.□□□□," "□□□.□□□□," "□□□□.□□□□," or "□□□□□□□□."

- The default settings are 0.00 for the left span and 100.00 for the right span.
- For details on setting the engineering units for linear scaling, refer to page 6-2.

5.3 Configuring the Input Range and Recording Span or the Linear Scaling of a Power Monitoring Channel

Relevant Keys

001-01:AC/1Ph3W		RECORD
RNG=250-5A/ V1	002:VA1	ALARM
SPAN= - 1250 / 1250W		CHART
		KEYLOCK

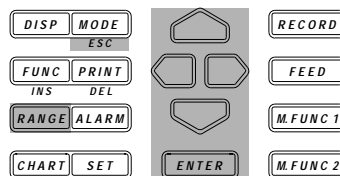

Operating Procedure

- Press the RANGE key to enter the RANGE menu.
- Using and , select and/or enter a value for each of the shaded fields shown below.
- To exit any of the following menu items during the procedure, press the MODE (ESC) key. This returns to the first item of the menu. Note, however, that your new settings and selections are canceled.
- Reaching the step showing the message “***SET OK***” confirms the latest settings/ selections.

Setting the Measuring Range and Recording Span

(Main menu item)

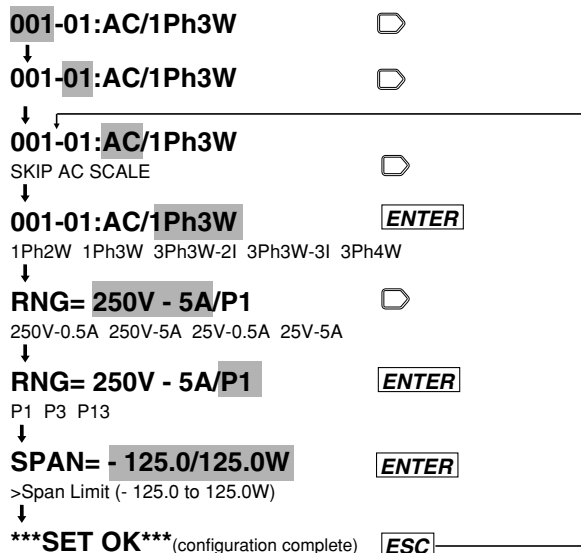

Setting Linear Scaling

(Main menu item)

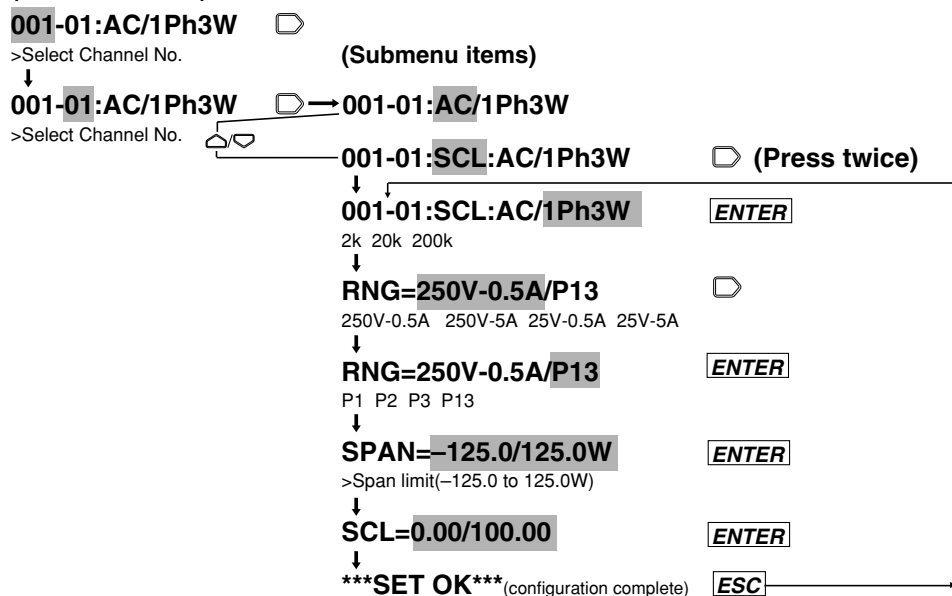

Explanation

Setting the Channel Number

This procedure sets the channel number for which you want to show and record the values of a parameter selected from the effective voltage, effective current, active power, reactive power, apparent power, frequency, power factor and phase angle which were calculated using the measured data. Therefore, it does not correlate with the terminals of an input module. In this procedure, determine from which channel (starting channel) to which channel (ending channel) you want to include in your configuration.

Starting Channel Number

The first three digits on the main display constitute the starting channel number.

- The first digit is the unit number. The second digit denotes the module number (slot number).
- The configurable range depends on the location where the power monitor module is connected. See page 3-8 for more information.

Ending Channel Number

The two digits that follow the starting channel number constitute the ending channel number.

Normally, the starting channel number and the ending channel number should be the same. If you want to skip any consecutive number of channels, enter the range of those channel numbers.

- When you move the cursor from the starting to the ending channel number, the ending channel number becomes the same as the last two digits of the starting channel number.

Setting the Wiring Method

Select from the following methods:

- Single-phase two-wire (1Ph2W)
- Single-phase three-wire (1Ph3W; three-wire input modules only)
- Three-phase three-wire 2 Voltage 2 Current (3Ph3W-2I; three-wire input modules only)
- Three-phase three-wire 3 Voltage 3 Current (3 Ph3W-3I; three-wire input module only)
- Three-phase four-wire (3Ph4W; three-wire input modules only)

Setting the Input Range

Select from the following ranges:

- 250V-0.5A 250V-5A
- 25V-0.5A 25V-5A

This setting is common to all channels. Any change to this setting also changes the settings of the rest of the channels. Impose a voltage or current signal to the input module within the limits you set here.

Setting the Parameter Being Shown and Recorded

A power monitor module measures the voltage or current through the respective channels. The values that are shown and recorded are not those of the voltage and current being actually measured through each channel but the values of the parameters you set here.

A combination of parameters being measured is fixed for each group of channels 1-2, 3-4 and 5-6 within the same module. For example, setting channel 1 to P1 (active power 1) sets channel 2 to VA1 (apparent power 1). In addition, the configurable parameters being measured varies depending on the wiring method selected. See the lists on the next page for more information.

The respective mnemonics in the lists should be interpreted as noted below:

- | | |
|--------------------------------------|---|
| Vi (i=1, 2, 3) : effective voltage | Ii (i=1, 2, 3) : effective current |
| V13 : (V1+V3)/2 | I13 : (I1+I3)/2 |
| V0 : (V1+V2+V3)/3 | I0 : (I1+I2+I3)/3 |
| Pi (i=1, 2, 3) : active power | Var _i (i=1, 2, 3) : reactive power |
| P13 : P1+P3 | Var13 : PF1+PF3 |
| P0 : P1+P2+P3 | Var 0 : Var1+Var2+Var3 |
| VAi (i=1, 2, 3) : apparent power | PFi (i=1, 2, 3) : power factor |
| VA13 : VA1+VA3 | PF13 : P13/(P13 ² +Var13 ²) ^{1/2} =P13/VA13 |
| VA0 : VA1+VA2+VA3 | PF0 : P0/(P0 ² +Var0 ²) ^{1/2} =P0/VA0 |
| PHi (i=1, 2, 3) : phase | FREQ : frequency |
| PH13 : tan ⁻¹ (Var13/P13) | |
| PH0 : tan ⁻¹ (Var0/P0) | |

5.3 Configuring the Input Range and Recording Span or the Linear Scaling of a Power Monitoring Channel

Single-phase two-wire configuration

CH1	CH2	CH3	CH4	CH5	CH6
P1	VA1	V1	I1	PF1	PH1
				Var1	PF1
				FREQ	V1

Select from these combinations.

Single-phase three-wire/three-phase three-wire configurations
(dual-voltage, dual-current; modules for three-phase use only)

CH1	CH2	CH3	CH4	CH5	CH6
P1	VA1	V1	I1	PF1	PH1
P3	VA3	V3	I3	PF3	PH3
P13	VA13			PF13	PH13
				V1	I1
				V3	I3
				V13	I13
				FREQ	V1
				Var1	PF1
				Var3	PF3
				Var13	PF13

Select from these combinations.

Three-phase three-wire configuration
(triple-voltage, triple-current; modules for three-phase use only)

CH1	CH2	CH3	CH4	CH5	CH6
P1	VA1	V1	I1	PF1	PH1
P2	VA2	V2	I2	PF2	PH2
P3	VA3	V3	I3	PF3	PH3
P13	VA13			PF13	PH13
				V1	I1
				V2	I2
				V3	I3
				V13	I13
				FREQ	V1
				Var1	PF1
				Var2	PF2
				Var3	PF3
				Var13	PF13

Select from either of the two groups of combinations.

V0	I0	V1	I1	V1	I1
V1	I1	V2	I2	V2	I2
V2	I2	V3	I3	V3	I3
V3	I3				

Three-phase four-wire configuration
(modules for three-phase use only)

CH1	CH2	CH3	CH4	CH5	CH6
P0	VA0	V1	I1	PF0	PH0
P1	VA1	V2	I2	PF1	PH1
P2	VA2	V3	I3	PF2	PH2
P3	VA3	P0	VA0	PF3	PH3
		P1	VA1	V1	I1
		P2	VA2	V2	I2
		P3	VA3	V3	I3
				FREQ	V1
				Var0	PF0
				Var1	PF1
				Var2	PF2
				Var3	PF3
				P0	VA0
				P1	VA1
				P2	VA2
				P3	VA3

Select from either of the two groups of combinations.

V0	I0	V1	I1	V1	I1
V1	I1	V2	I2	V2	I2
V2	I2	V3	I3	V3	I3
V3	I3				

Setting the Recording Span (SPAN)

Set the left and right spans within the limits of an input range. In the SPAN menu item, the left-hand value is the left span and the right-hand value the right span. Set the recording span within the measuring range. The measurable limits vary depending on the measuring range you select, as shown below.

	25V-0.5A	25V-5A	250V-0.5A	250V-5A
Effective voltage Vi (i=1,2,3,13,0)	0.00 to 25.00V rms	0.00 to 25.00V rms	0.0 to 250.0V rms	0.0 to 250.0V rms
Effective current Ii (i=1,2,3,13,0)	0.0000 to 0.5000A rms	0.000 to 5.000A rms	0.0000 to 0.5000A rms	0.000 to 5.000A rms
Active power P1,P2,P3	-12.50 to 12.50W	-125.0 to 125.0W	-125.0 to 125.0W	-1250 to 1250W
Active power P13	-25.00 to 25.00W	-250.0 to 250.0W	-250.0 to 250.0W	-2500 to 2500W
Active power P0	-37.50 to 37.50W	-375.0 to 375.0W	-375.0 to 375.0W	-3750 to 3750W
Apparent power VA1,VA2,VA3	0.00 to 12.50VA	0.0 to 125.0VA	0.0 to 125.0VA	0 to 1250VA
Apparent power VA13	0.00 to 25.00VA	0.0 to 250.0VA	0.0 to 250.0VA	0 to 2500VA
Apparent power VA0	0.00 to 37.50VA	0.0 to 375.0VA	0.0 to 375.0VA	0 to 3750VA
Reactive power Var1,Var2,Var3	0.00 to 12.50Var	0.0 to 125.0Var	0.0 to 125.0Var	0 to 1250Var
Reactive power Var13	0.00 to 25.00Var	0.0 to 250.0Var	0.0 to 250.0Var	0 to 2500Var
Reactive power Var0	0.00 to 37.50Var	0.0 to 375.0Var	0.0 to 375.0Var	0 to 3750Var
Power factor PFI(i=1,2,3,13,0)	-1.00 to 1.00	-1.00 to 1.00	-1.00 to 1.00	-1.00 to 1.00
Phase PHI(i=1,2,3,13,0)	-80.0 to 80.0deg	-80.0 to 80.0deg	-80.0 to 80.0deg	-80.0 to 80.0deg
Frequency FREQ	45.00 to 65.00Hz	45.00 to 65.00Hz	45.00 to 65.00Hz	45.00 to 65.00Hz

Precautions in Measurement

- Input the voltage or current being measured at a level between 10% and 100% of the measuring range. The DR recorder bases its calculations of all other parameters on the frequency of V1. Extra care must therefore be taken when setting the input level of V1. If the input level fails to fall within the given limits, there is no guarantee that the measurement of any other parameters will be reliable.

From the previous page

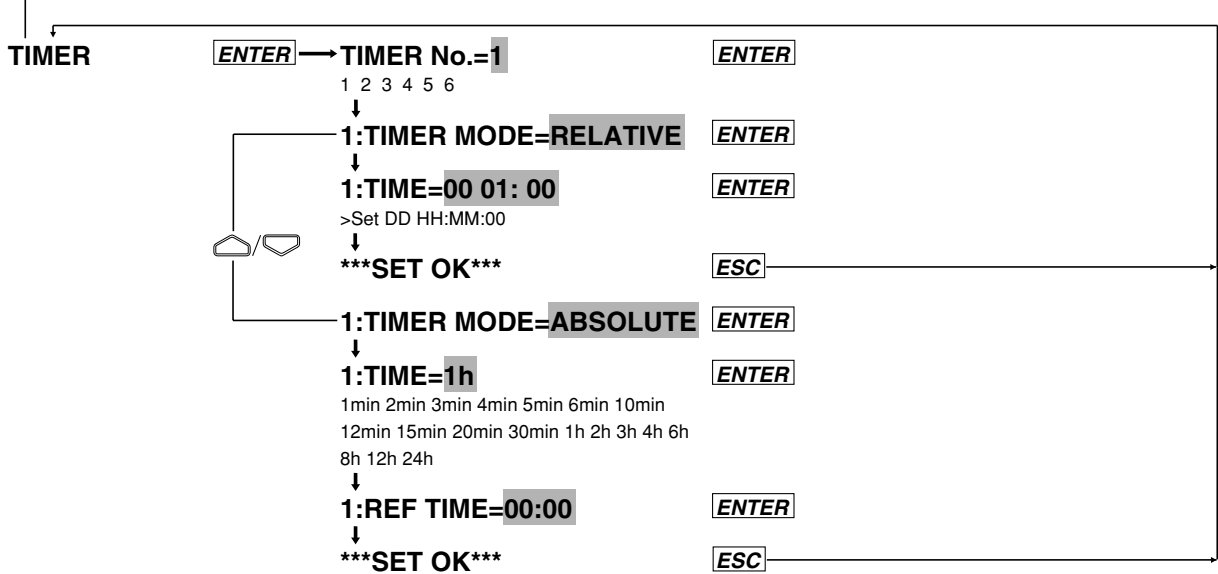

Explanation

Recording Mode (SYSTEM)

The following types of recording mode can be selected. The default is TREND.

- LOGGING (LOGGING MODE); measurement values will be printed out as digital values.
- TREND (ANALOG TREND MODE); measurement values will be recorded as analog trends (trend recording) and printed out as digital values.
- Selecting the recording interval

This setting can only be done for the TREND mode, and its default setting is AUTO.

FIX: recording takes place at intervals equal to the measurement period (scan interval) intervals

AUTO: recording takes place at intervals automatically decided by measurement interval and chart speed.

Engineering Unit (UNIT)

An engineering unit of up to six characters can be assigned to each channel. The default setting is all spaces.

The characters/numbers can be selected by cursor from the displayed row on sub-display 1. An engineering unit can only be assigned to channels to which linear scaling is applied. For details concerning entering characters/numbers, refer to page 6-15.

If the instrument is equipped with the optional computation function or floppy disk drive, make sure that channel Nos. are set between A01 and A30 when specifying the measurement units for computation channels.

Setting the Channels to be Recorded (TREND)

Trend recording

Recording can be set ON/OFF per channel. The default setting is ON.

ON: recording will take place;

OFF: recording will not take place.

The display will show “■” for channels set to ON, and “□” for channels set to OFF. Refer to page 4-10 on which channel is being displayed.

If you are installing optional computation channels, channel Nos. must be set to A01 to A30.

Digital Printout in the Analog Trend Mode

Refer to 6.4 Setting Tag, Digital Printout and Manual Printout on page 6-9.

Setting the Recording Interval (TIMER) of the Digital Printout for the Logging and Analog Trend Mode

- **TIMER No.**

You can set up to six recording intervals. A recording interval can be set for each channel individually. Refer to 6.4 on page 6-9 for details.

- **TIME MODE**

The following two modes can be selected. The default is RELATIVE.

- **RELATIVE**; the number of days/hours/minutes can be set to any value between 00 days 00 hours 01 minute to 31 days 23 hours and 59 minutes, in one-minute steps. The default setting is 00 days, 01 hours and 00 minutes.

- **ABSOLUTE**; the time interval can be selected from the following settings. The default setting is 1h.

1min, 2min, 3min, 4min, 5min, 6min, 10min, 12min, 15min, 20min, 30min, 1h, 2h, 3h, 4h, 6h, 8h, 12h, and 24h.

The reference time is set by the hour and minutes. The default value is 00 hrs, 00 min.

6.2 Setting the Chart Speed

Relevant Keys

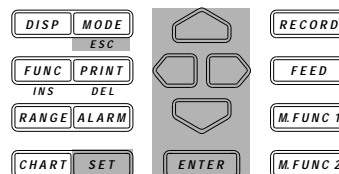
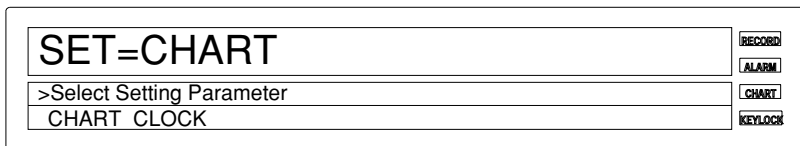

Operating Procedure

Setting Chart Speed 1

- Press the CHART key to enter the SET menu.
- Select/set **100** using the keys.
- To escape from a lower menu, press the MODE (ESC) key. Its main menu will appear, although new settings/selections will not be kept.
- New settings/selections will be kept when you reach the final display of that setting.

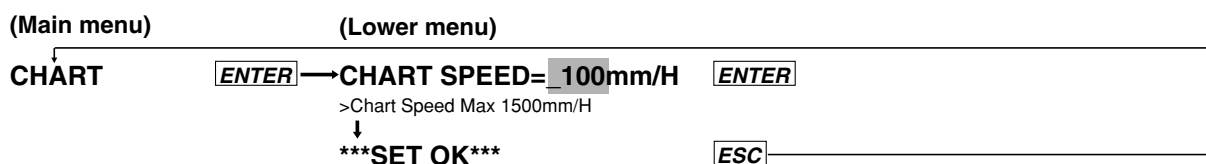

Setting Chart Speed 2

- Press the SET key for three seconds to enter the SET3 menu.
- Select/set **100** using the keys.
- To escape from a lower menu, press the MODE (ESC) key. Its main menu will appear, although new settings/selections will not be kept.
- New settings/selections will be kept when you reach the final display of that setting.

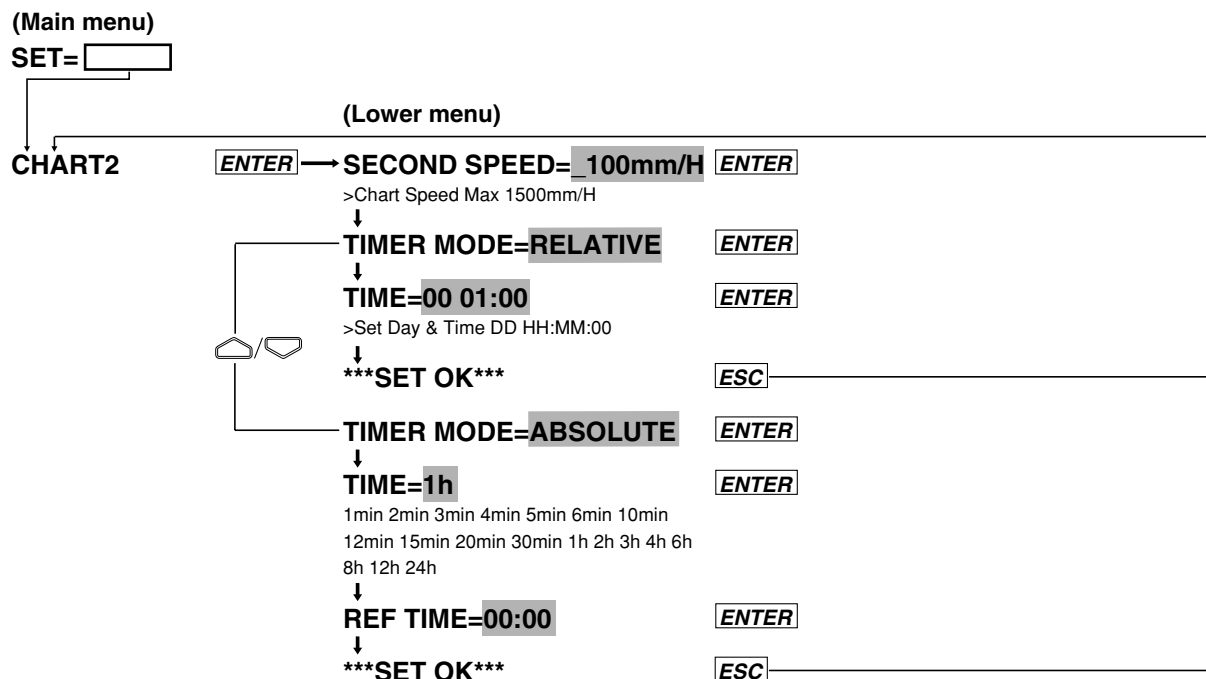

Explanation**Chart Speed 1 (CHART)**

This setting specifies the chart speed of ordinary trend recordings. The setting ranges from 1 to 1500mm/h, in 1 mm steps. The default setting is 100mm/h.

- Depending on the chart speed, the items channel number/TAG, digital printout, and alarm/scale/message may not be included in your printout. See the table below for details.

Chart speed	Channel No./TAG	Digital print out	Alarm/scale/message
1 to 9mm/h	Record enabled	Record disabled	Record enabled
10 to 1500mm/h	Record enabled	Record enabled	Record enabled

Chart Speed 2 (CHART2)

This setting consists of a chart speed and recording interval. Depending on the Event/Action function (refer to 9.1 on page 9-1), the chart speed and recording interval will change into chart speed 2 and its corresponding interval.

- Chart speed 2 setting
This setting is the same as for chart speed 1, and its default setting is 100mm/h.
- Recording interval
This setting specifies the recording interval for the logging mode. One type of recording interval can be set. The setting is done the same way as described on page 6-3, although only one type can be set.

6.3 Setting Recording Zones and Partially Expanded Recording

Relevant Keys

SET=ZONE	RECORD
>Select Setting Parameter	ALARM
CHART2 ZONE PARTIAL TAG DIGITAL PR MAN↑	CHART
	KEYLOCK

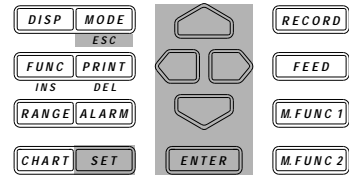

Operating Procedure

- Press the SET key for three seconds to enter the SET3 menu.
- Select/set using the keys.
- To escape from a lower menu, press the MODE (ESC) key. Its main menu will appear, although new settings/selections will not be kept.
- New settings/selections will be kept when you reach the final display of that setting.

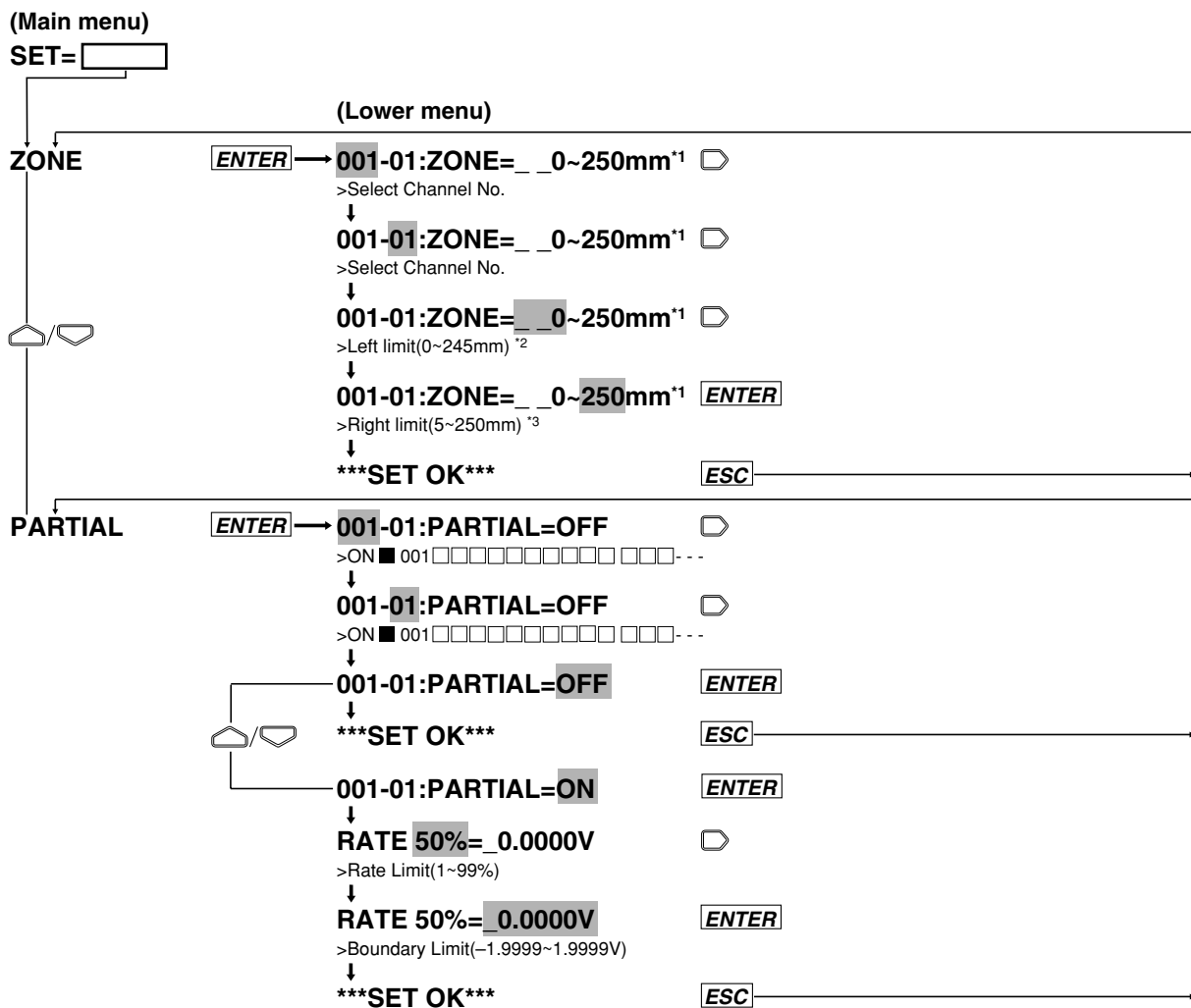

- *1: For Model DR130, indicated as "001-01 : ZONE = __ 0-150 mm."
 *2: For Model DR130, indicated as "> Left limit (0-145 mm)."
 *3: For Model DR130, indicated as "> Right limit (5-150 mm)."

Explanation**Setting Recording Zones (ZONE)**

This setting specifies the recording zones for each channel. The set left and right position of the zone correspond to the left and right span set at the SPAN menu (recording span). The left value of the ZONE menu corresponds to the value of the left position of the zone, whereas the right value of the ZONE menu corresponds to the value of the right position of the zone.

A zone can be set in 1-mm steps and must be within the range of dot-printed recording. The configurable ranges of the left and right stops of a zone and their defaults are as follows:

	<u>Left Stop (Default)</u>	<u>Right Stop (Default)</u>
DR130	0 to 145 mm (0 mm)	5 to 150 mm (150 mm)
DR231/241	0 to 245 mm (0 mm)	5 to 250 mm (250 mm)

The right stop must be set to be at least 5 mm larger than that of the left stop. No decimal points are allowed.

If the instrument is equipped with the optional computation function or floppy disk drive, this setting can also be made for computation channels A01 to A30.

Partially Expanded Recording (PARTIAL)

This setting specifies whether to carry out partially expanded recording, and if so, which percentage of the recording span will be compressed and the corresponding boundary value. If the instrument is equipped with the optional computation function or floppy disk drive, this setting can also be made for computation channels A01 to A30.

- **Selecting Partial Recording ON/OFF**

ON: Partial recording will be carried out;

OFF: Partial recording will not be carried out.

The default setting is OFF.

- **Specifying the Compressed Part and Boundary Value**

RATE

This setting specifies which percentage (1 to 99%) of the full recording span will be compressed. The default value is 50%.

Boundary value

This setting specifies the boundary value which corresponds to the previous set compressed part. The setting lies within the recording span, but when linear scaling is being used, the setting lies within the left/right scale range. The default value is 0.

Note

If boundary values are to be set for succeeding channels, the decimal point is handled as shown below.

If succeeding channels are set, the decimal point position of boundary values when the measurement range for each channel setting is different, is that determined for each corresponding range. As a result, it exceeds the measurable range, an error occurs.

For example, if channels whose measurement ranges are 20 mV, 2 V, and type T thermocouple are set and the boundary value is set to 10000, the following applies:

The boundary value of the channel whose measurement range is 20 mV: 10.000 mV;

The boundary value of the channel whose measurement range is 2 V: 1.0000 V; and

The boundary value of the channel whose measurement range is type T thermocouple: 1000.0°C

As the measurement range of type T thermocouple is -200.0 to 400.0°C, an error occurs for this channel.

For decimal point positions for each measurement range, see Chapter 14, "Specifications."

- **Points to Note when Using Partially Expanded Recording**

- Partial recording cannot be carried out if the input type of the computation channels is SKIP or DI or if the computation channels are OFF.
- Partially expanded settings will be automatically canceled when either of the following changes occur.
 - the input type has been changed;
 - the measurement range has been changed;
 - the recording span has been changed;
 - linear scaling settings have been changed;
 - the reference channel for difference between channels has been changed.

Explanation**Tag Setting**

A tag of up to 16 characters can be assigned to each channel. If the instrument is equipped with the optional computation function or floppy disk drive, this setting can also be made for computation channels A01 to A30. The characters/numbers for the tag can be selected by cursor from the displayed row on sub-display 1. For details on the number of characters which will be printed, refer to 10.2 on page 10-4. For details on the number of characters which will be displayed, refer to 4.1 on page 4-2. To select whether the tag or channel number are displayed/printed, refer to 10.2 on page 10-4. The default settings are all spaces. For details concerning entering characters/numbers, refer to page 6-15.

Digital Printout Setting (DIGITAL PR)

This setting can be selected for each channel from the following. This setting applies to the digital print of the analog mode and logging mode. The default setting is ON.

OFF: Digital printout will not be carried out for this channel;

ON: Digital printout will be carried out for this channel.

The recording interval can be selected from the following. For details on LOG INTERVAL, refer to 10.2, page 10-6.

If the instrument is equipped with the optional computation function or floppy disk drive, this setting can also be made for computation channels A01 to A30.

When LOG INTERVAL is set to SINGLE:

The recording interval is decided automatically, depending on the chart speed, and the columns of channels to be printed.

When LOG INTERVAL is set to MULTIPLE:

The recording interval can be selected from six timer settings. The default value is 1. For details on the timer setting, refer to 6.1, page 6-3.

Columns Selecting

Refer to 10.2, page 10-5.

Manual Printout Setting (MANUAL PR)

This setting can be selected from the following.

The default setting is ON. If the instrument is equipped with the optional computation function or floppy disk drive, this setting can also be made for computation channels A01 to A30.

OFF: Manual printout will not be carried out for this channel;

ON: Manual printout will be carried out for this channel.

6.5 Setting the Alarm Printout

Relevant Keys

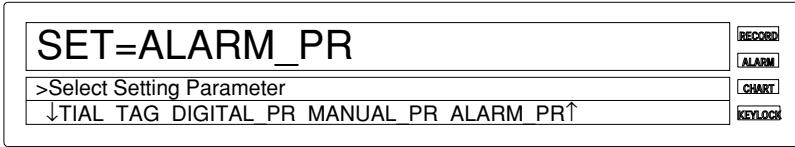

Operating Procedure

- Press the SET key for three seconds to enter the SET3 menu.
- Select/set **■** using the keys.
- To escape from a lower menu, press the MODE (ESC) key. Its main menu will appear, although new settings/selections will not be kept.
- New settings/selections will be kept when you reach the final display of that setting.

(Main menu)

SET=

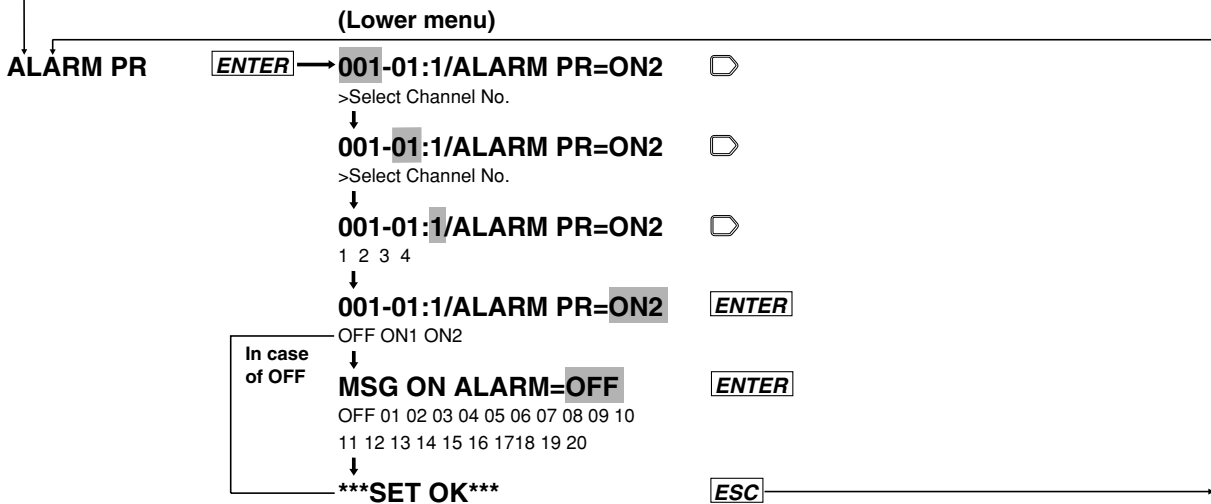

Explanation**Selecting the Alarm Items**

Although up to four alarm headings can be set per channel, this setting specifies the number of the heading which will be printed. The default setting is 1.

If the instrument is equipped with the optional computation function or floppy disk drive, alarm items can also be set for computation channels A01 to A30.

The setting can be selected from 1, 2, 3 or 4. All four headings can be assigned to one single channel. For details on alarm settings, refer to 8.1, page 8-1.

Selecting the Alarm Printout (ALARM PR)

This setting can be selected from the following. The default setting is ON2.

OFF: Alarm printout will not be carried out;

ON1: Alarms will only be printed out on occurrence.

The alarm occurrence mark, channel No. or tag, type of alarm, alarm heading or time of occurrence will be printed with trend recordings.

ON2: Alarms will both be printed out on occurrence and release.

The alarm occurrence/release mark, channel No. or tag, type of alarm, alarm heading or time of occurrence/release will be printed with trend recordings.

Alarm Printout Buffer**• Analog Trend Mode**

Up to 30 alarm occurrences/releases can be stored in memory.

- Information on more than 30 alarm occurrences/releases will be discarded.
- After one alarm printout, 29 alarm occurrences/releases are stored and another alarm occurrence/release can then be stored.
- If 31 alarm occurrences/releases (exceeding the allowed number of 30) are entered, an asterisk (*) will be printed at the top of the alarm message when 30 alarm printouts are executed.
- The alarm buffer clear function is available for canceling the stored alarm printout information (see page 9-17).

• Logging Mode

Up to 10 alarm occurrences/releases can be stored in memory.

- Information on more than 10 alarm occurrences/releases will be discarded.
- If 11 alarm occurrences/releases (exceeding the allowed number of 10) are entered, an asterisk (*) will be printed at the top of the alarm message when 10 alarm printouts are executed.
- The alarm buffer clear function is available for canceling the stored alarm printout information (see page 9-17).

Selecting a Message Printout

This setting specifies whether to print a message on alarm occurrence, and if so, which message will be printed. The default setting is OFF.

OFF: No message will be printed.

Message No.

This setting can be selected from 01, 02, 03, 04, 05, 06, 07, 08, 09, 10, 11, 12, 13, 14, 15, 16, 17, 18, 19 and 20. When a message No. has been selected where no message has been entered, printout will not be carried out.

For details on setting messages, refer to 6.7 on page 6-15.

6.6 Setting Scale Printout, List Printout and List Format

Relevant Keys

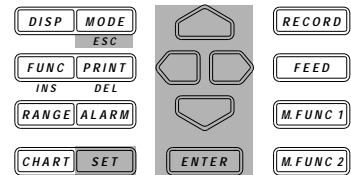
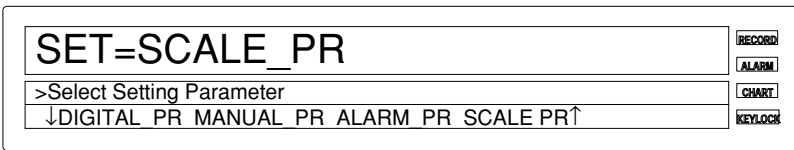

Operating Procedure

- Press the SET key for three seconds to enter the SET3 menu.
- Select/set using the keys.
- To escape from a lower menu, press the MODE (ESC) key. Its main menu will appear, although new settings/selections will not be kept.
- New settings/selections will be kept when you reach the final display of that setting.

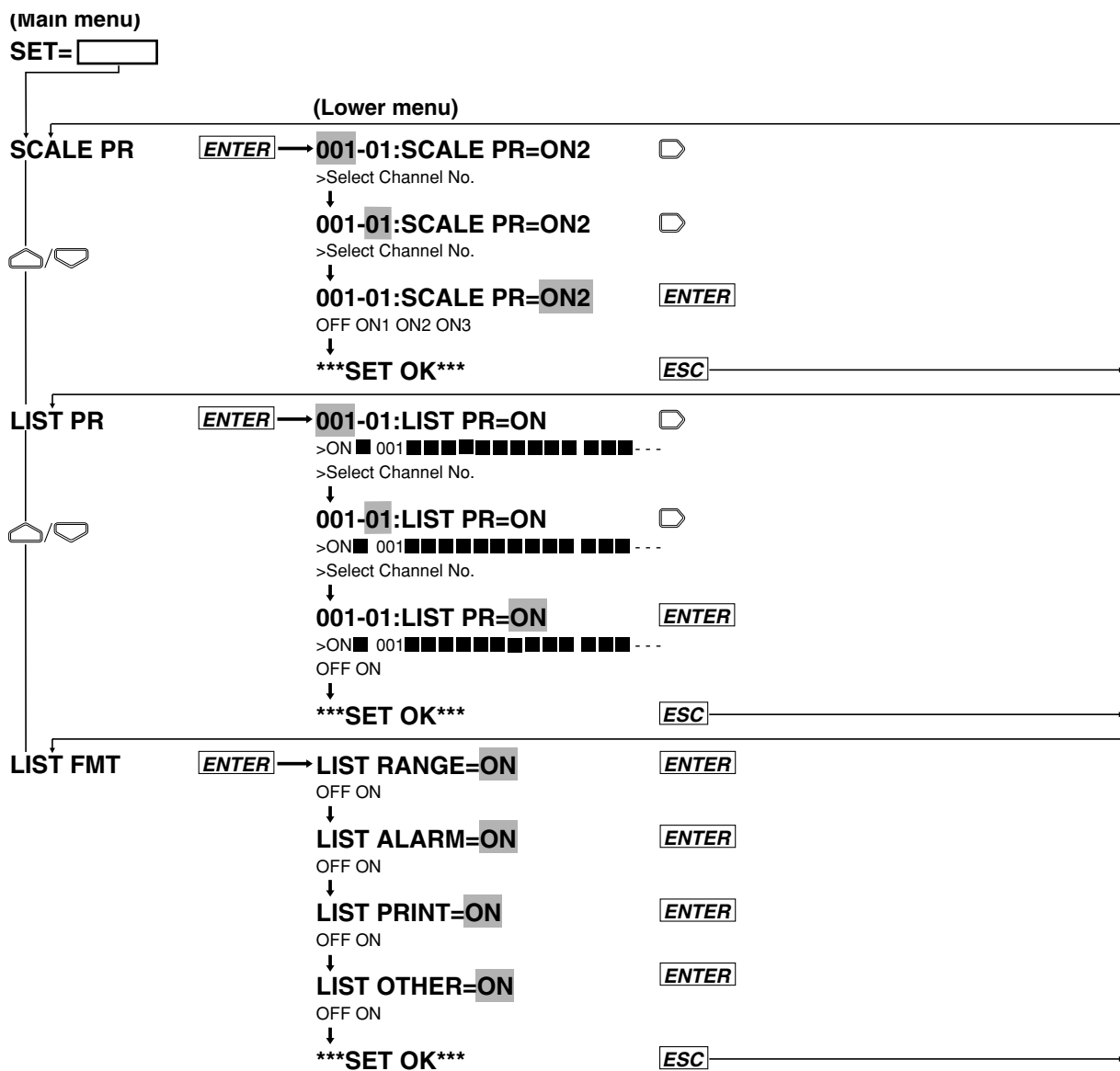

Explanation**Scale Printout (SCALE PR)**

This setting can be assigned to each channel individually. The scaled values will be printed out with trend recordings. This printout will not occur when a zone of 49mm or less is set. The scaled values of the following channels will be printed. For example, when the recording zone of ch. 1 is set to 49mm, and of ch. 2 is 150mm, the scaled values of ch. 2 will be printed at the position of ch. 1. The default setting is ON2. If the instrument is equipped with the optional computation function or floppy disk drive, this setting can also be made for computation channels A01 to A30.

- **When Partial Expanded Recording is OFF**

OFF: Scaled values will not be printed.

ON1:

- when the recording zone is 150mm or more: scaled values at each 20%-interval of the recording span will be printed at positions at 20%-intervals of the zone.
- when the recording zone is 50mm to 149mm: scaled values at 0% and 100% of the recording span will be printed at 0% and 100% positions of the zone.

ON2:

Scaled values at 0% and 100% of the recording span will be printed at 0% and 100% positions of the zone.

ON3:

- when the recording zone is 100mm or more: scaled values at 0%, 50% and 100% of the recording span will be printed at 0%, 50% and 100% positions of the zone.
- when the recording zone is 50mm to 99mm: scaled values at 0% and 100% of the recording span will be printed at 0% and 100% positions of the zone.

- **When Partial Expanded Recording is ON**

OFF: Scaled values will not be printed.

ON1/ON2/ON3:

- when the recording zone is 100mm or more: scaled values at 0%, 100% of the recording span and at the boundary value will be printed at 0%, 100% and boundary value positions of the zone.
- when the recording zone is 50mm to 99mm: scaled values at 0% and 100% of the recording span will be printed at 0% and 100% positions of the zone.

List Printout (LIST PR)

This setting can be assigned to each channel individually. The default setting is ON. Starting a list printout can be done at the PRINT menu (refer to 7.2 on page 7-2). If the instrument is equipped with the optional computation function or floppy disk drive, this setting can also be made for computation channels A01 to A30.

OFF: List printout will not be printed.

ON: Setting information per channel will be printed.

Setting the List Format (LIST FMT)

This setting specifies which setting information will be printed out in case of list printouts. Each of the following lists can be selected ON or OFF, and the default setting is ON.

LIST RANGE (information about the setting range)

Information about settings related to tags, type of input, recording span, linear scaling and computation equation.

LIST ALARM (information about the alarm settings)

Alarm settings

LIST PRINT (information about the printing settings)

Information about settings related to analog trend recording, digital printout, interpolation, recording zones, partial expanded recording, recording interval of digital printouts for logging mode and analog mode, moving average, scaled values, alarm printout, manual printout and data saving ON/OFF.

LIST OTHER (information about other settings)

Information about settings related to match time, groups, headers, messages, event/action function, list format and computation constant.

Information which always be included in a list printout, regardless of the above settings, are title, measurement interval, recording interval (trend), chart speeds 1 and 2, recording mode and time.

6.7 Entering Messages, Headers and Title

Relevant Keys

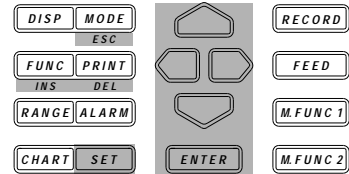
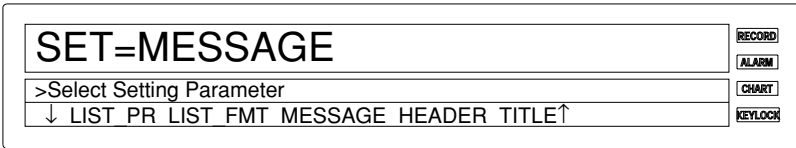

Operating Procedure

- Press the SET key for three seconds to enter the SET3 menu.
- Select/set **■** using the **⏪** **⏩** keys.
- To escape from a lower menu, press the MODE (ESC) key. Its main menu will appear, although new settings/selections will not be kept.
- New settings/selections will be kept when you reach the final display of that setting.

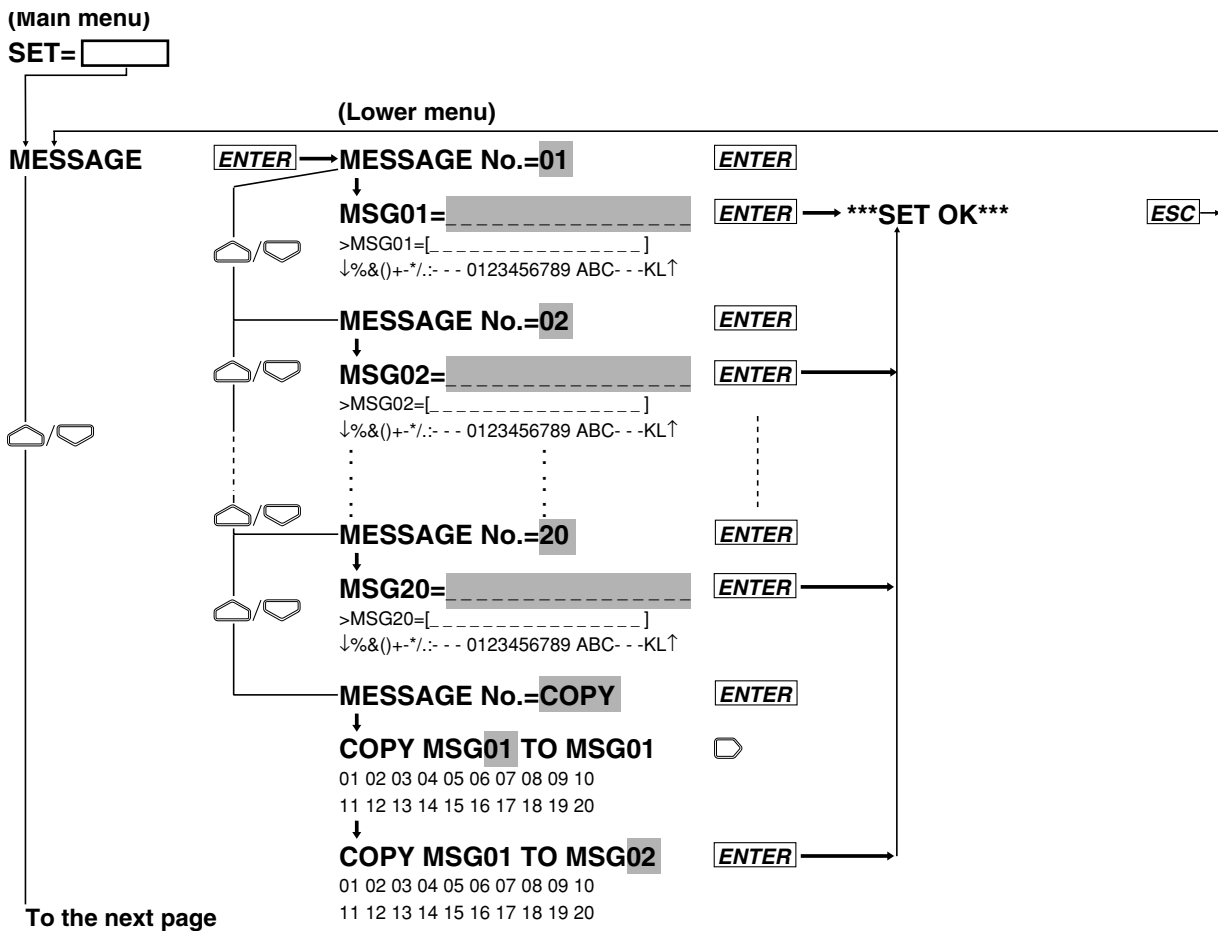

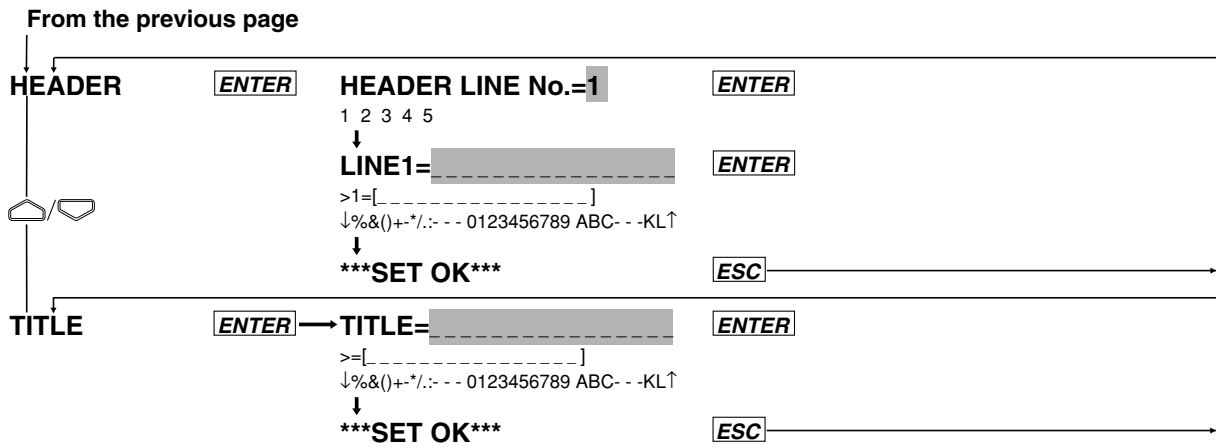

Explanation

Entering a Message

MESSAGE No. (selection of the message No.)

Up to 20 messages can be entered.

MSG01 to 20 (entering the message)

The message contents can be entered here using up to 16 characters. Characters and numerals can be selected from the menu. The default setting is all spaces.

COPY (copying messages)

The contents of an entered message (message No. at the left side of the setting) can be copied to another message number (at the right side of the setting). You cannot copy to the same message number.

Printing out a message

A message can be printed out on the occurrence of an alarm (refer to 6.5 on page 6-11 for details), using the FUNC menu (refer to 7.3 on page 7-3 for details), or using the event/action function (refer to 9.1 on page 9-1 for details).

Displaying a message

A message can be displayed on the main display using the even/action function.

Entering a Header

HEADER LINE No. (selection of the header line)

One header can consist of up to five lines.

LINE 1 to 5 (entering one line of the header)

The header contents can be entered here using up to 60 characters for each line (for DR130) or 80 characters for each line (for DR231/DR241), and thus up to 300 characters (for DR130) or 400 characters (for DR231/DR241) for the entire header. Characters and numerals can be selected from the menu. The default setting is all spaces.

Entering a Title

One title can be set. The configurable number of characters is 1 to 32. Characters and numerals can be selected from the menu. The default setting is all spaces.

Inserting/Deleting a Character or Numeral

Press the PRINT(DEL) key to delete a set character or numeral. The digit at the location of the cursor will be deleted.

Press the FUNC(INS) key to insert a character or numeral. The digit at the location of the cursor will become a space, while all the characters/numeral at the right side of the cursor will move one digit to the right.

Explanation**Setting the Match Time**

MATCH TIME No. (selection of the match time number)

Three kinds of match times can be set.

TIME

Any time between 00 days, 00 hrs., 00 min. and 31 days, 23 hrs, 59 min. can be set in 1-minute units. The default setting is 01 days 00 hrs 00 min.

If 00 is set to day (DD), HH: MM every day shows the set time. If day (DD) is set to a value other than 00, HH:MM on DD day every month shows the set time. DD, HH, and MM give the set numeric values respectively.

The match time setting is used with the event/action function. Refer to 9.1 on page 9-1 for details.

Moving Average (MOVE AVE)

This setting can be set for each channel individually. The number of samples used for the moving average can be set from 2 to 64. The default value is 0, which means that no moving average is carried out. The result of the moving average is being displayed/printed.

Interpolation (INTERPOL)

This setting can be set for each channel individually. If the instrument is equipped with the optional computation function or floppy disk drive, this setting can also be made for computation channels A01 to A30. The default setting is OFF.

OFF: no interpolation will be carried out.

ON: interpolation will be carried out according to the priority of recording colors. The priority of recording colors is black > purple > redish purple > navy blue > red > blue > brown > green > orange > yellowish green.

Group setting (GROUP)

- GROUP No. (selection of the group number)

Up to seven groups can be set.

- G01 to G07

This setting specifies which channel numbers will be included in one group. A “,” is used for entering a single channel, while a “-” can be used to enter a range of channels. Setting the same channel two or more times in one group causes an error. For example, setting channel numbers such as "G01 = 003, 001-009" results in an error because channel number 003 is repeated. The default setting is 001.

- The group setting is used with the event/action function. Refer to 9.1 on page 9-1 for details.

7.1 Starting Dot Printing, Digital Printing and Printing in Logging Mode

Relevant Keys

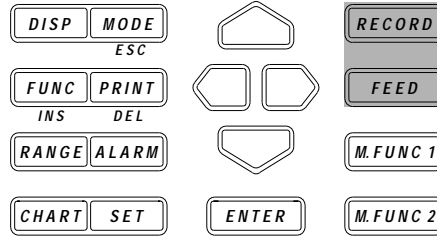
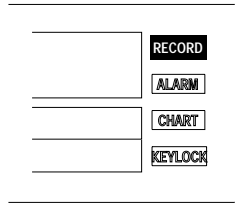

Operating Procedure

To start recording

Press the RECORD key. The status display [RECORD] lights.

To stop recording

Press the RECORD key once again. The status display [RECORD] turns off.

To feed the recording paper

Press the FEED key.

Explanation

Starting dot printing, digital printing, and recording in logging mode

- See Chapter 6, "Setting."
- Event/action functions can also be used to perform the above printing and recording (see Page 9-1).

Feeding the recording paper

Press the FEED key to feed the recording paper. Even if the FEED key is pressed while recording, the paper is fed without stopping the recording.

Notes on starting recording

The carriage will stop temporarily at the left or right side for each line as shown below.

• When printing in logging mode or manual printing:

Printing direction	Channel no./TAG selection	Temporary stop (in seconds)
Horizontal	Channel	4 (0)
	TAG of 7 to 8 characters	3 (1)
	TAG of 9 to 16 characters	5 (2)
Vertical	Channel	2 (0)
	TAG of 7 to 16 characters	3 (0)

The values in () are for the DR130.

• List printing

Temporary stop: For 0.5 seconds

Note

In the case of the DR130, the carriage does not come to a pause in manual or list printing.

7.2 Starting Manual Printing, List Printing and Header Printing

Relevant Keys

MAN_PR_START	RECORD
>Enter & Print Start/Stop	ALARM
MAN_PR_START LIST START HEADER_START	CHART
	KEYLOCK

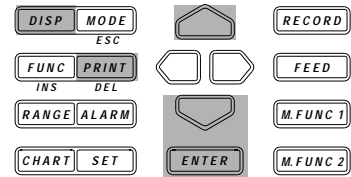

Operating Procedure

- Press the PRINT key to enter the PRINT menu.
- To display the print menu from the RANGE, ALARM, CHART or SET(SET3) menu, press the DISP key.

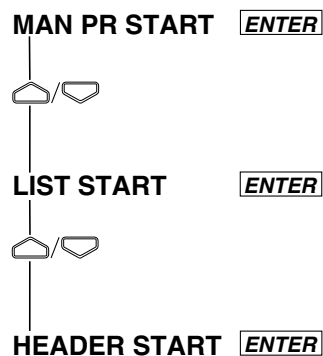

Explanation

Starting the manual print (MAN PR START)

- Press the ENTER key to start manual printing.
- After printing starts, the operation display mode appears.
- During manual printing, the menu displays [MAN PR STOP].
- During manual printing, enter the PRINT menu again and select [MAN PR STOP]. Then press the ENTER key to stop the manual printing.
- After manual printing terminates or stops, the display returns to [MAN PR START].

Starting the list print (LIST START)

- Press the ENTER key to start list printing. For details on setting the time for temporarily stopping printing, see the previous page.
- After list printing starts, the operation display mode appears.
- During list printing, the menu displays [LIST STOP].
- During list printing, if the PRINT menu is displayed to select the [LIST STOP] and the ENTER key is then pressed, the list printing stops.
- After list printing terminates or stops, the display returns to [LIST START].

Starting the header print (HEADER START)

- To start the header print, press the ENTER key.
- After header printing starts, the operation display mode appears.
- During header printing, the [HEADER STOP] menu appears.
- During header printing, if the PRINT menu is displayed to select the [HEADER STOP] and the ENTER key is then pressed, the header printing stops.
- After header printing terminates or stops, the display returns to [HEADER START].

Notes on starting the above menus

- If the above menus are executed, analog trend recording will stop. After returning from the menus, analog trend recording resumes.
- While the above menus are being executed, if any other menu is selected, the previous menu is first executed and the later menu is then executed.
- See Chapter 6 for details on setting the above menus.

7.3 Starting Message Printing

Relevant Keys

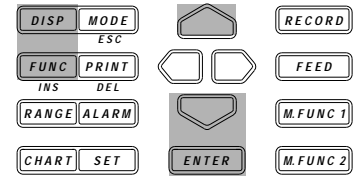
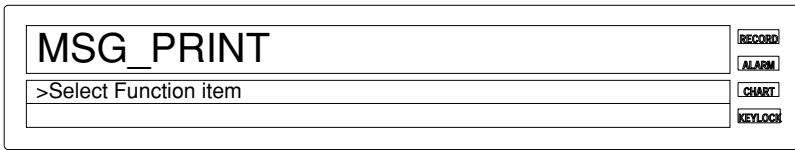

Operating Procedure

- Press the FUNC key to enter the FUNC menu.
- To display the print menu from the RANGE, ALARM, CHART or SET(SET3) menu, press the DISP key.
- Select / set using the keys.
- To escape from a lower menu, press the MODE (ESC) key. Its main menu will appear, although new settings / selections will not be kept.

(Main menu)



MSG PRINT

(Lower menu)



PRINT MESSAGE No.=01



Explanation

Starting message printing (MSG PRINT)

- Select a message number from 01 to 20. For details on how to set the message, see Section 6.7, “Entering Messages, Headers and Titles” on page 6-15.
- While the instrument is recording, if the ENTER key is pressed, messages are printed.
- If an alarm occurs, messages are also printed. See Section 6.5, “Setting the Alarm Printout” on page 6-11.

Message printout buffer

• Analog trend

Up to 10 message printouts can be stored in memory.

- Information exceeding 10 message printouts will be discarded.
- After one message printout, 9 are stored and another printout message can then be stored.
- If 11 message printouts (exceeding the allowed number of 10) are entered, an asterisk (*) will be printed at the top of the message when 10 message printouts are executed.
- The message buffer clear function is available for canceling stored printout messages (see page 9-17).

• Logging mode

Up to 5 message printouts can be stored in memory.

- Information exceeding 5 message printouts will be discarded.
- If 6 message printouts (exceeding the allowed number of 5) are entered, an asterisk (*) will be printed at the top of the message when 5 message printouts are executed.
- The message buffer clear function is available for canceling stored printout messages (see page 9-17).

7.4 Printing Set-up Lists

Relevant Keys

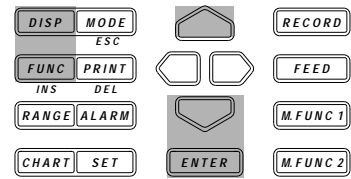
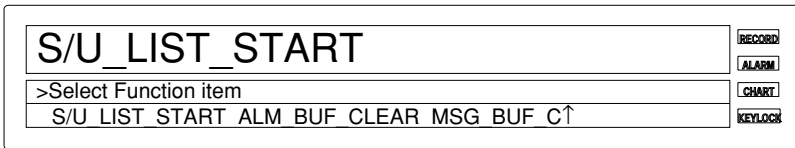

Operating Procedure

- Press the FUNC key for three seconds to enter the FUNC3 menu.

S/U LIST START **ENTER**



Explanation

Printing the set-up list (S/U LIST START)

Prints a list of the settings made in the SETUP menu. For details of the settings and their values, see Chapter 10.

- Press the ENTER key to start printing the set-up list.
- After printing starts, the operation display mode appears.
- During list printing, the [S/U LIST STOP] menu appears.
- During list printing, if the FUNC3 menu is displayed to select the [S/U LIST STOP] and the ENTER key is then pressed, the list printing stops.
- After the list print terminates or stops, the display returns to the [S/U LIST START].
- If the setup list printing starts, analog trend recording will stop. After the printing is completed, analog trend recording resumes.

8.1 Setting Alarms and Relays (including internal switches)

Relevant Keys

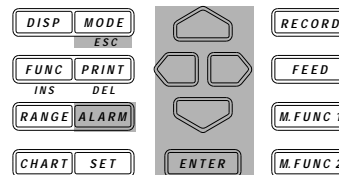
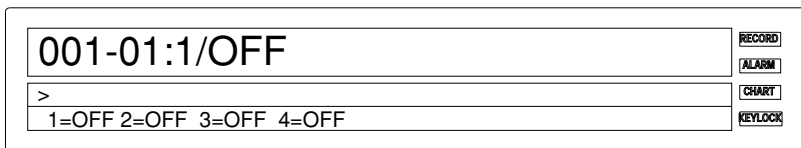

Operating Procedure

- Press the ALARM key to enter the ALARM menu.
- Select / set using the keys.
- To escape from a lower menu, press the MODE (ESC) key. Its main menu will appear, although new settings / selections will not be kept.
- New settings/selections will be kept when you reach the final display of that setting.

(Main menu)

001-01:1/OFF

>Select Channel No.

001-01:1/OFF

>Select Channel No.

001-01:1/OFF

1 2 3 4

(Lower menu)

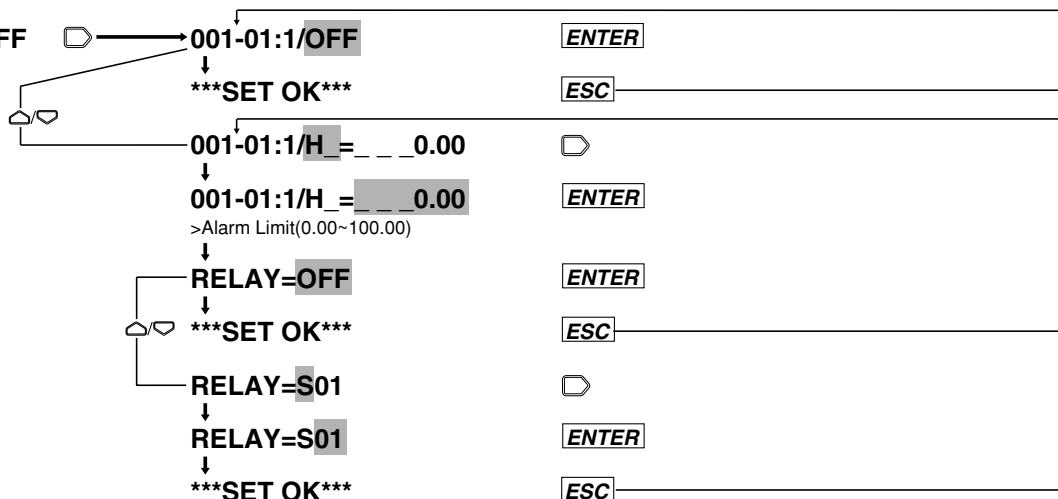

Explanation

Selecting channel Nos.

Channels Nos. A01 to A30 are available for computation channels (optional).

Selecting the alarm item number

Set the alarm item number for each channel as follows:

- Select any number from among 1, 2, 3, and 4.
- Alarm numbers 1 to 4 can be set for one channel.
- For details on setting the alarm printout, see Section 6.5, “Setting the Alarm Printout” on page 6-10.

Note

- If SKIP is selected for the input type or if the computation channels are OFF, alarms cannot be set.
- If the following cases, the alarm is set to OFF:
 - If the input type or measuring range in the related channel is changed,
 - If computation channels are turned ON/OFF or the computation equation is changed.
 - If the recording span for the linear scaling, or linear scaling values is changed, or
 - If the standard channel for differential computation between channels is changed.
- Setting the alarm or relay (including internal switches) gives more functions to this recorder. For details, see Section 9.1, “Setting Event and Action Functions” on page 9-1.

Selecting the type of alarm

- Select an alarm type for each alarm number from among the following:
 - OFF (default set): No alarm is set.
 - H: Upper-limit alarm. An alarm occurs when the measured value exceeds the upper-limit alarm setpoint.
 - L: Lower-limit alarm. An alarm occurs when the measured value exceeds the lower-limit alarm setpoint.
 - RH: Rate-of-change upper-limit alarm. An alarm occurs when the measured value changes in the increasing direction within a certain time (rate-of-change alarm interval) and exceeds the upper-limit alarm setpoint.
 - RL: Rate-of-change lower-limit alarm. An alarm occurs when the measured value changes in the decreasing direction within a certain time (rate-of-change alarm interval) and exceeds the lower-limit alarm setpoint.
 - dH: An alarm occurs when the difference between two channels exceeds the alarm setpoint. This only applies to a channel for which interchannel differential computation is selected, and can be set as a type of alarm.
 - dL: An alarm occurs when the difference between two channels exceeds the lower-limit alarm setpoint. This only applies to a channel for which interchannel differential computation is selected, and can be set as a type of alarm.
- For details on the rate-of-change alarm interval setting or other basic alarm settings, see Section 10.3, “Select Alarm Interval/Hysteresis/Hold A/D Converter Integration timer/Filter” on page 10-8.
- For details on interchannel differential computation, see Section 5.1, “Setting the Type of Input and Recording Span” on page 5-3.
- Only H (upper-limit alarm) and L (lower-limit alarm) are available for computation channels.

Setting alarm values

Set one alarm value for each alarm number within the following range, depending on the type of input. The default value is 0 (zero).

- H and L
 - VOLT, TC, RTD, DI, and DELTA: Within the measuring range in the related channel. DI can be set to either 0 or 1.
 - SCALE: Within a linear scaling value.
 - Computation channel: Within the range specified by the computation function
- RH and RL
 - VOLT, TC, RTD, DI, and DELTA: Within 1 to [maximum measuring range minus minimum measuring range] in the related channel. For example, set 30000 (without using a decimal point) if the maximum value exceeds 30000. DI can be set to only 1.
 - SCALE: Set 1 to 30000 without using a decimal point.
- dH and dL
 - When the standard channel uses VOLT: Within the measuring range.
 - When the standard channel uses other than VOLT: [maximum measuring range minus minimum measuring range] to - [maximum measuring range minus minimum measuring range]
- For the type of input, see Section 5.1, “Setting the Type of Input and Recording Span” on page 5-3.

Note

When setting alarm values in continuous channels, use the decimal point as follows:

The decimal point of an alarm value when the continuous channels have different measuring ranges should be in the position determined by the individual measuring range. If the decimal point is outside the measuring range, an error occurs. For example, if channels with measuring ranges 20 mV and 2 V, and a type T thermocouple channel, are all set to an alarm value of 10000, then the alarm values in the respective channels are as follows:

10.000 mV in the 20 mV measuring range channel

1.0000 V in 2 V measuring range channel

1000.0°C in the type T thermocouple channel

A type T thermocouple has a measuring range from -200.0 to 400.0°C, so an error results. For details on the decimal point positions in individual measuring ranges, see Chapter 14, “Specifications.”

Setting Relays (Internal Switches)

Set which alarm output relay or internal switch should be triggered when an alarm occurs:

- Select the desired alarm output relay or internal switch from among the following. The default setting is OFF.
 - OFF: Alarm output relays and internal switches remain OFF.
 - S01 to S60: 60 internal switches are provided.
 - 0N1 to 0(N + 1)0: /A4 option. N = Slot number for an alarm module. Ten relays are provided.
 - 0M1 to 0M2: /R1 option. M = Slot number for a DI/DO module. Two relays are provided.
 - For the model with both /A4 and /R1 options, both the above can be selected simultaneously.
- Multiple alarm setpoints can be set for one alarm output relay or internal switch.
- The operation mode in the alarm output relay or internal switch can be set when an alarm occurs. For details, see Section 10.4, “Setting Operation Mode of Relay/Internal switch” on page 10-9.
- When the alarm module on the DI/DO modules are not recognized as system modules, the relay is set to OFF. For the system recognition, see page 9-17.

8.2 Alarm Display and Printing

Relevant Keys

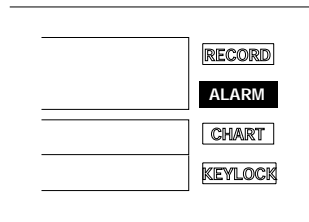

Explanation

Alarm display

- When an alarm status is detected and an alarm is issued, the [ALARM] lights.
- To display the alarm status for each channel, see Section 4.4, “Using the ALARM SEARCH Display” on page 4-7 or Section 4.6, “Using the ALARM STATUS Display” on page 4-10.
- To display the alarm output relay or internal switch status, see Section 4.7, “Using the RELAY STATUS Display” on page 4-11.
- If an alarm occurs while the alarm display hold (ALARM HOLD) is ON (because the alarm has already been triggered), the [ALARM] and alarm status displays flash. Even after the alarm status is released, the displays still flash.
- When the alarm status hold function is ON, use the alarm acknowledge function to determine the current status of the alarm. To do this, display the FUNC menu, select [ALARM-ACK], then press the ENTER key to use the alarm acknowledge function. For details, see Section 2.4, “Alarm Function” on page 2-16.

Alarm printing

For details on setting the alarm printing, see Section 6.5, “Setting the Alarm Printout” on page 6-10. The alarms are printed after making this setting.

Alarm reset

This function is selected from the FUNC menu when the relay hold function (see page 10-11) is activated. To use the alarm reset function, select [ALARM RST], then press the ENTER key to use the alarm reset function. For details on the alarm reset, see Section 2.4, “Alarm Function” on page 2-16.

9.1 Setting Event/Action Functions

Relevant Keys

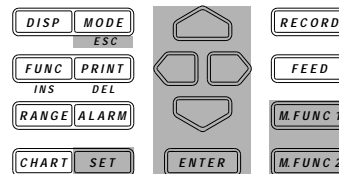
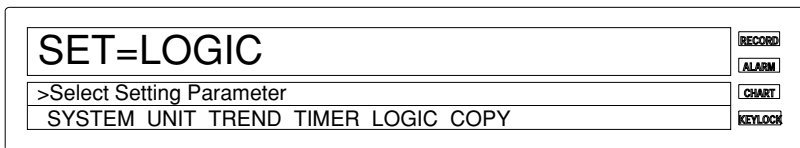

Operating Procedure

- Press the SET key to enter the SET menu.
- Select/set using the keys.
- To escape from a lower menu, press the MODE (ESC) key. Its main menu will appear, although new settings/selections will not be kept.
- New settings/selections will be kept when you reach the final display of that setting.

Selection of the logic box and event [NONE]

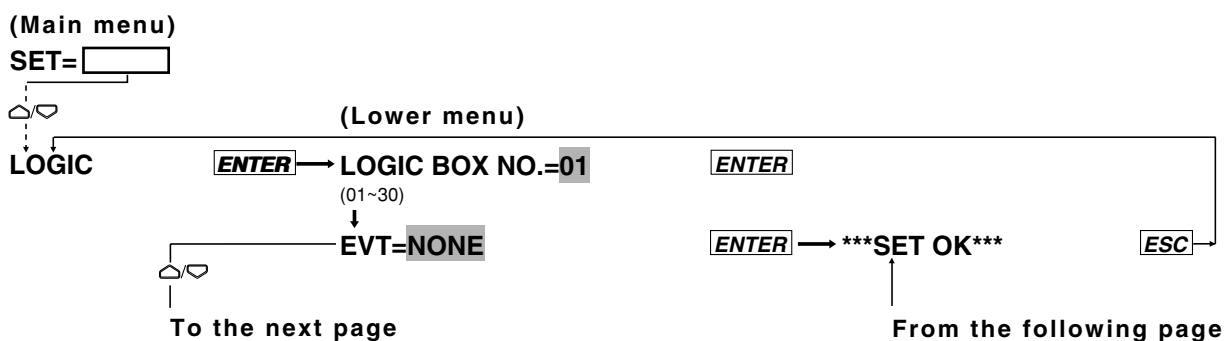

Selection of event (REMOTE)/actions

The [REMOTE] menu is displayed only with /R1 option.

The [MATH] menu is displayed only with the DR130-1/DR231-1/DR241-1 and models with the /M1 option.

The [MEMRY] and [FLOPY] menus are displayed only with the DR130-1/DR231-1/DR241-1.

The [REPORT] menu is displayed only with /M3 option.

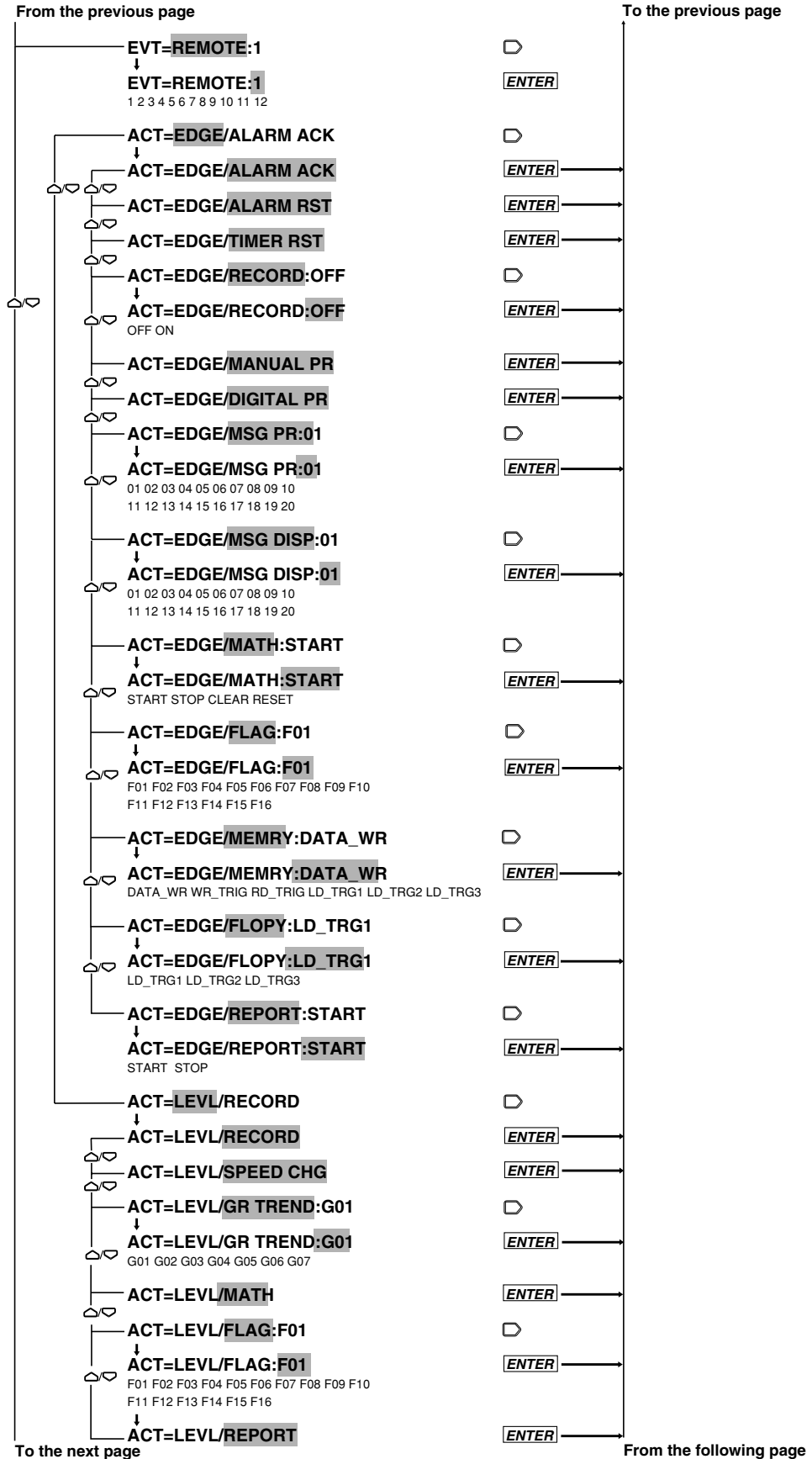

Selection of event (ALARM)/actions

The [MATH] menu is displayed only with the DR130-1/DR231-1/DR241-1 and models with the /M1 option.

The [MEMRY] and [FLOPY] menus are displayed only with the DR130-1/DR231-1/DR241-1.

The [REPORT] menu is displayed only with /M3 option.

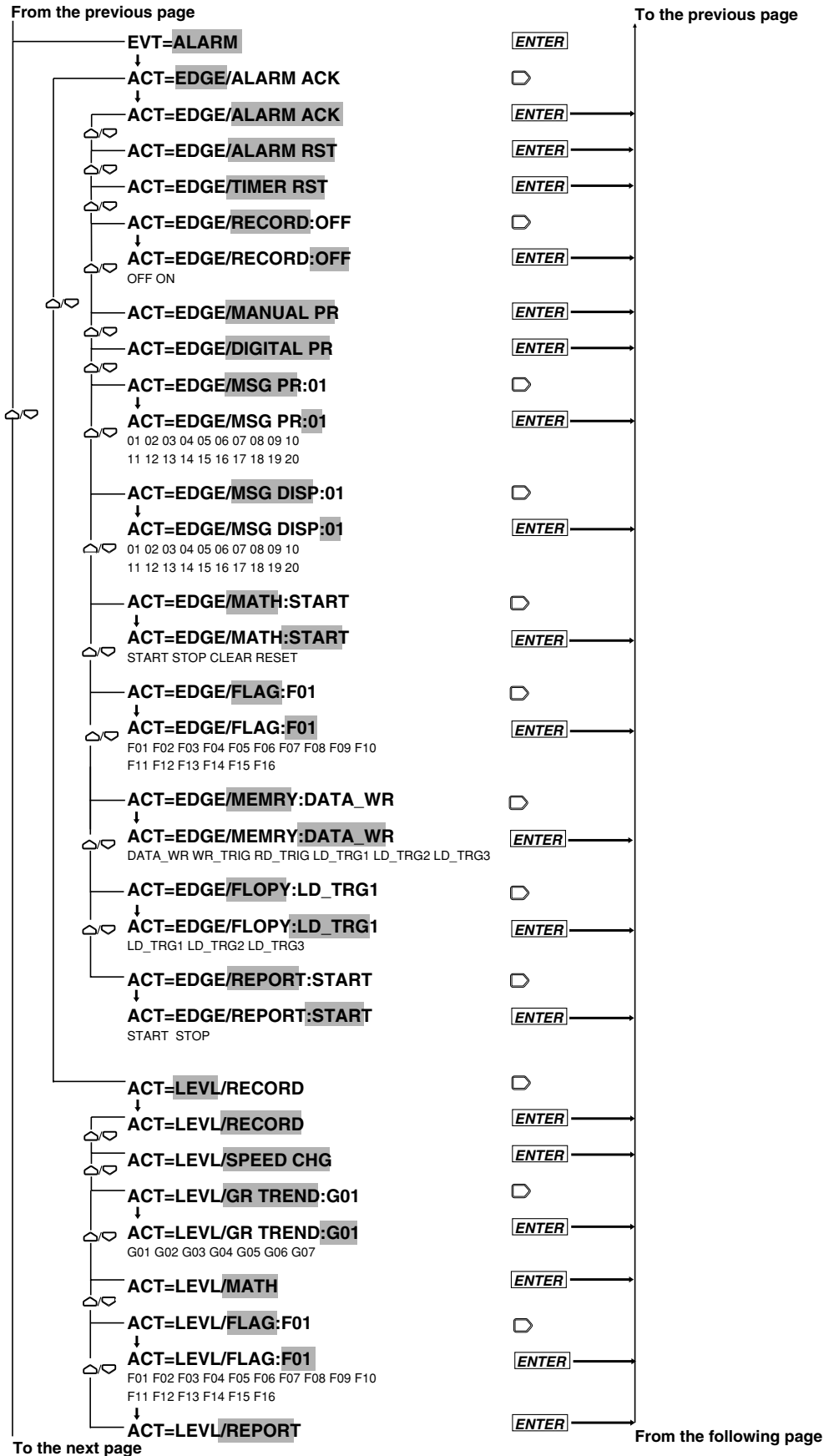

Selection of event (RELAY)/actions

The [MATH] menu is displayed only with the DR130-1/DR231-1/DR241-1 and models with the /M1 option.

The [MEMRY] and [FLOPY] menus are displayed only with the DR130-1/DR231-1/DR241-1.

The [REPORT] menu is displayed only with /M3 option.

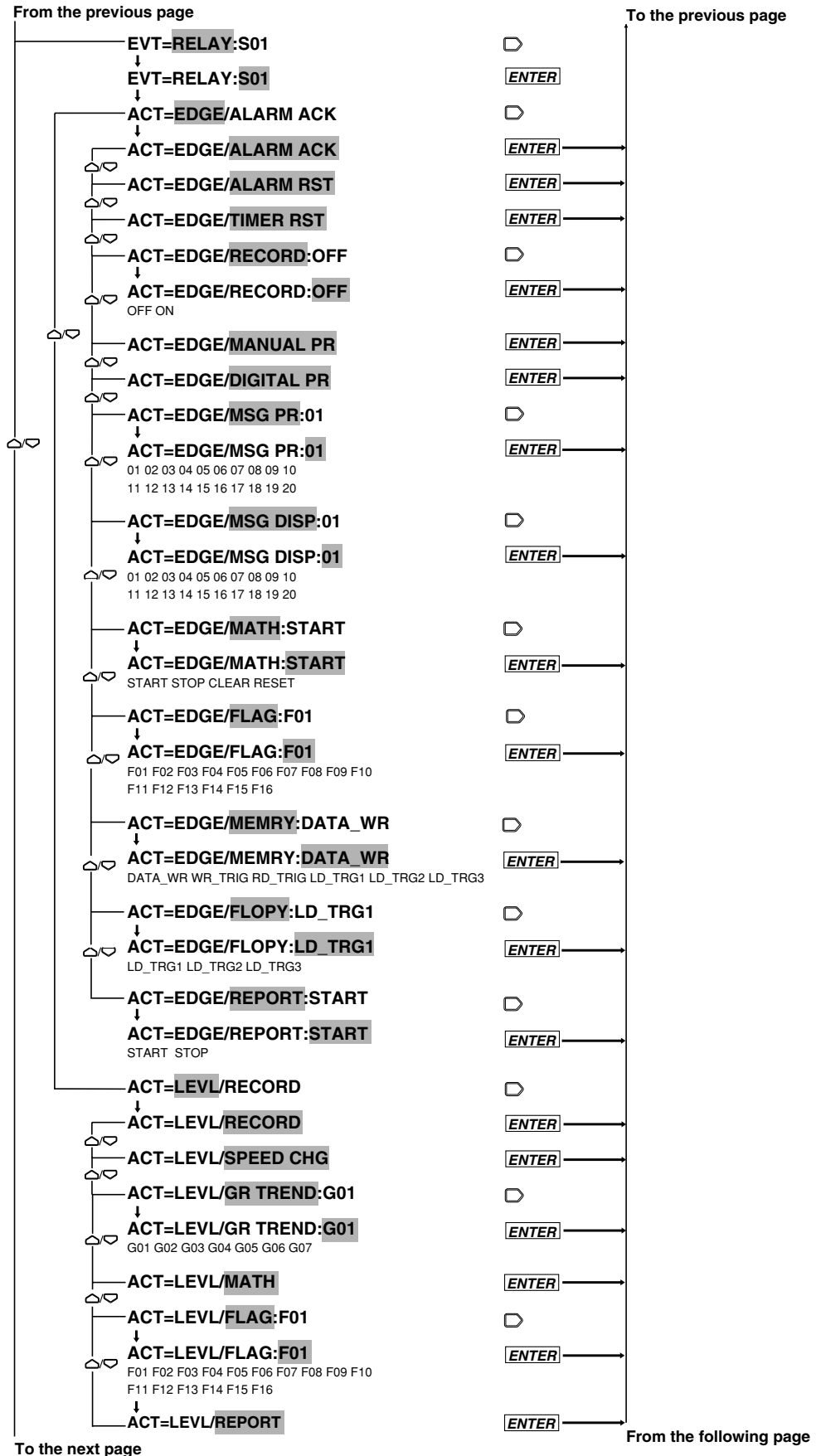

Selection of event (CHART END)/actions

The [MATH] menu is displayed only with the DR130-1/DR231-1/DR241-1 and models with the /M1 option.

The [MEMRY] and [FLOPY] menus are displayed only with the DR130-1/DR231-1/DR241-1.

The [REPORT] menu is displayed only with /M3 option.

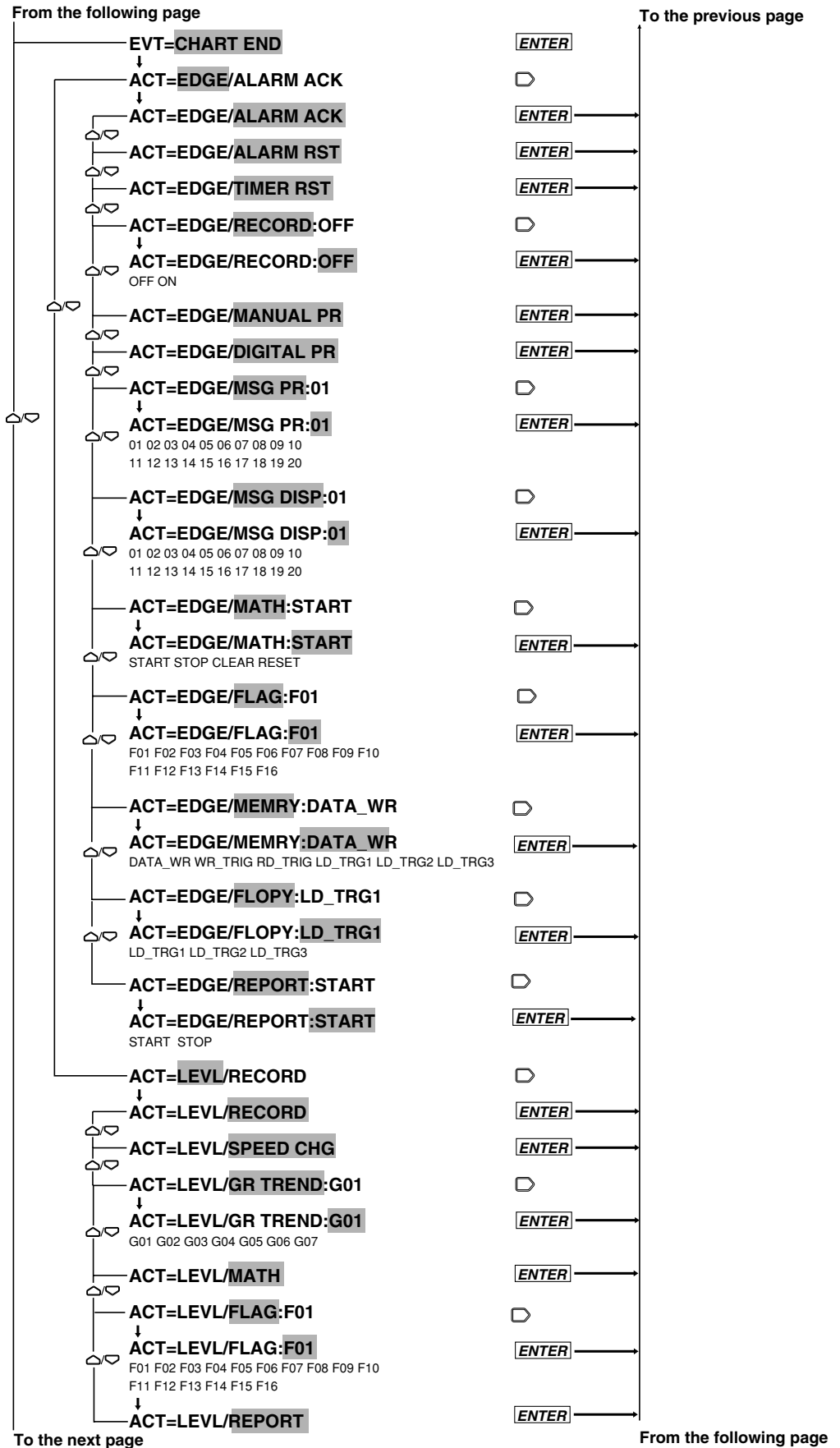

Selection of event (TIMER)/actions

The [MATH] menu is displayed only with the DR130-1/DR231-1/DR241-1 and models with the /M1 option.

The [REPORT] and [FLOPY] menus are displayed only with the DR130-1/DR231-1/DR241-1.

The [REPORT] menu is displayed only with /M3 option.

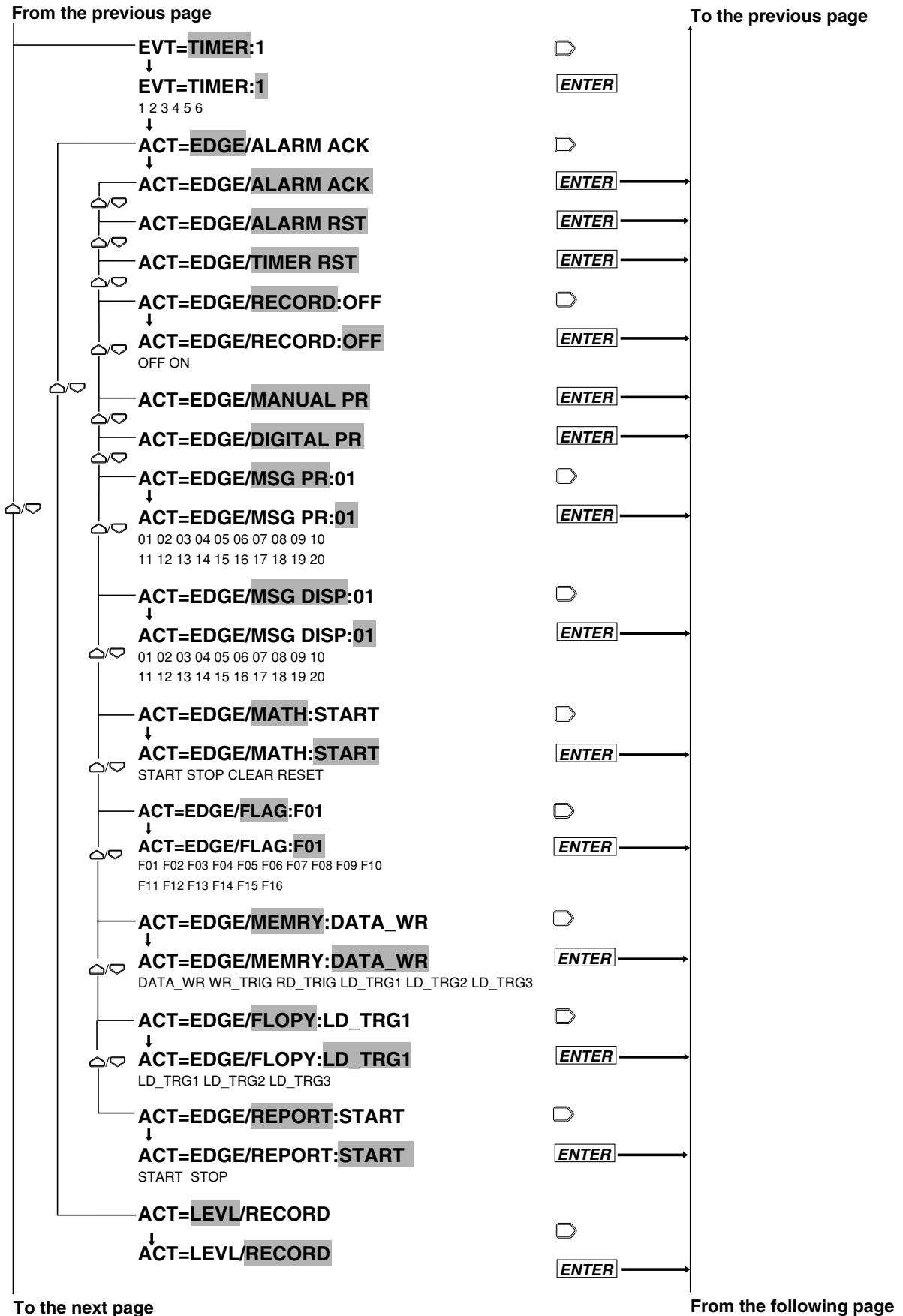

Selection of Event (MFUNC KEY)/actions

The [MATH] menu is displayed only with the DR130-1/DR231-1/DR241-1 and models with the /M1 option.

The [MEMRY] and [FLOPY] menus are displayed only with the DR130-1/DR231-1/DR241-1.

The [REPORT] menu is displayed only with /M3 option.

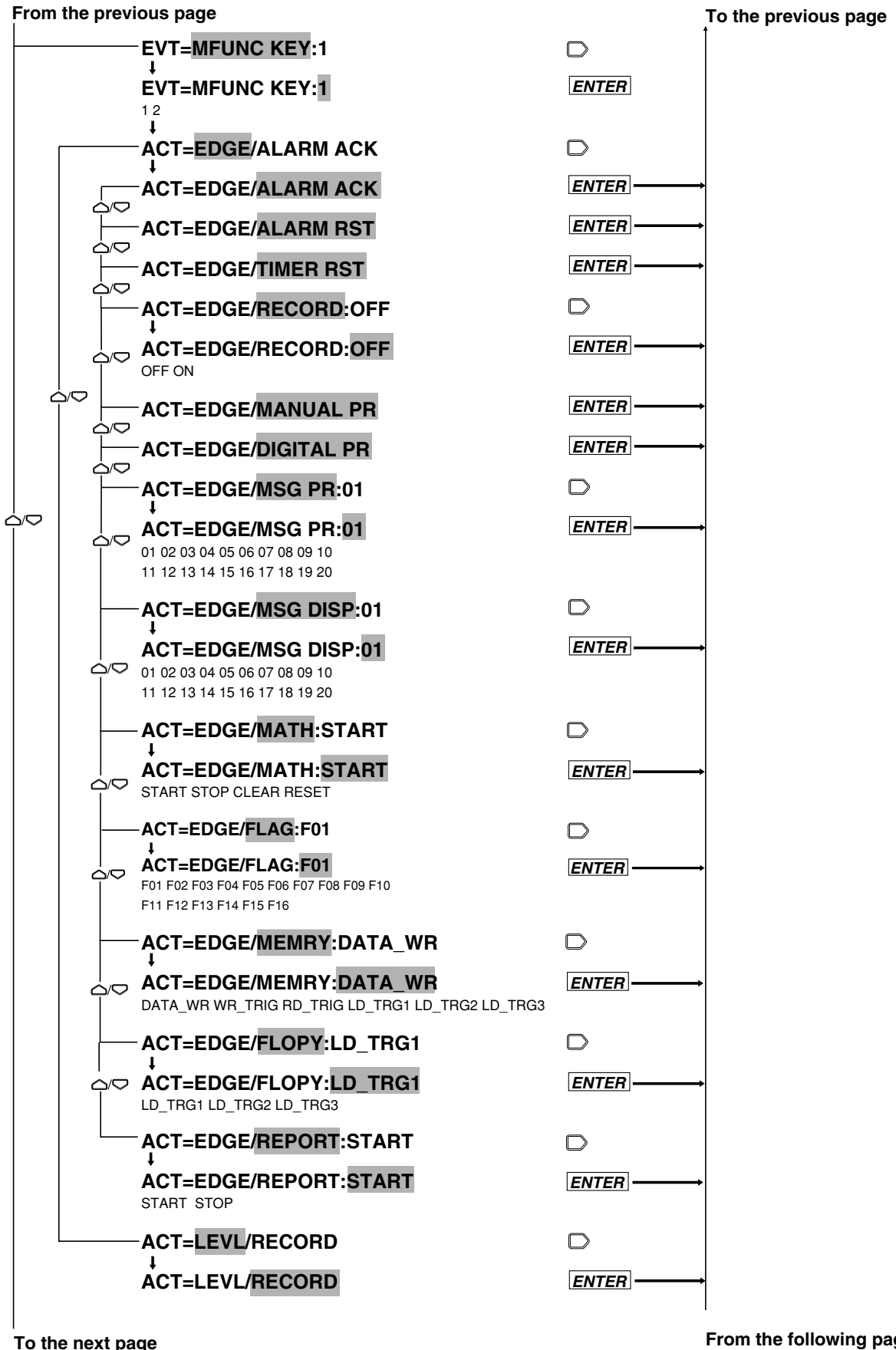

Selection of event (MATCH TIME)/actions

The [MATH] menu is displayed only with the DR130-1/DR231-1/DR241-1 and models with the /M1 option.

The [MEMRY] and [FLOPY] menus are displayed only with the DR130-1/DR231-1/DR241-1.

The [REPORT] menu is displayed only with /M3 option.

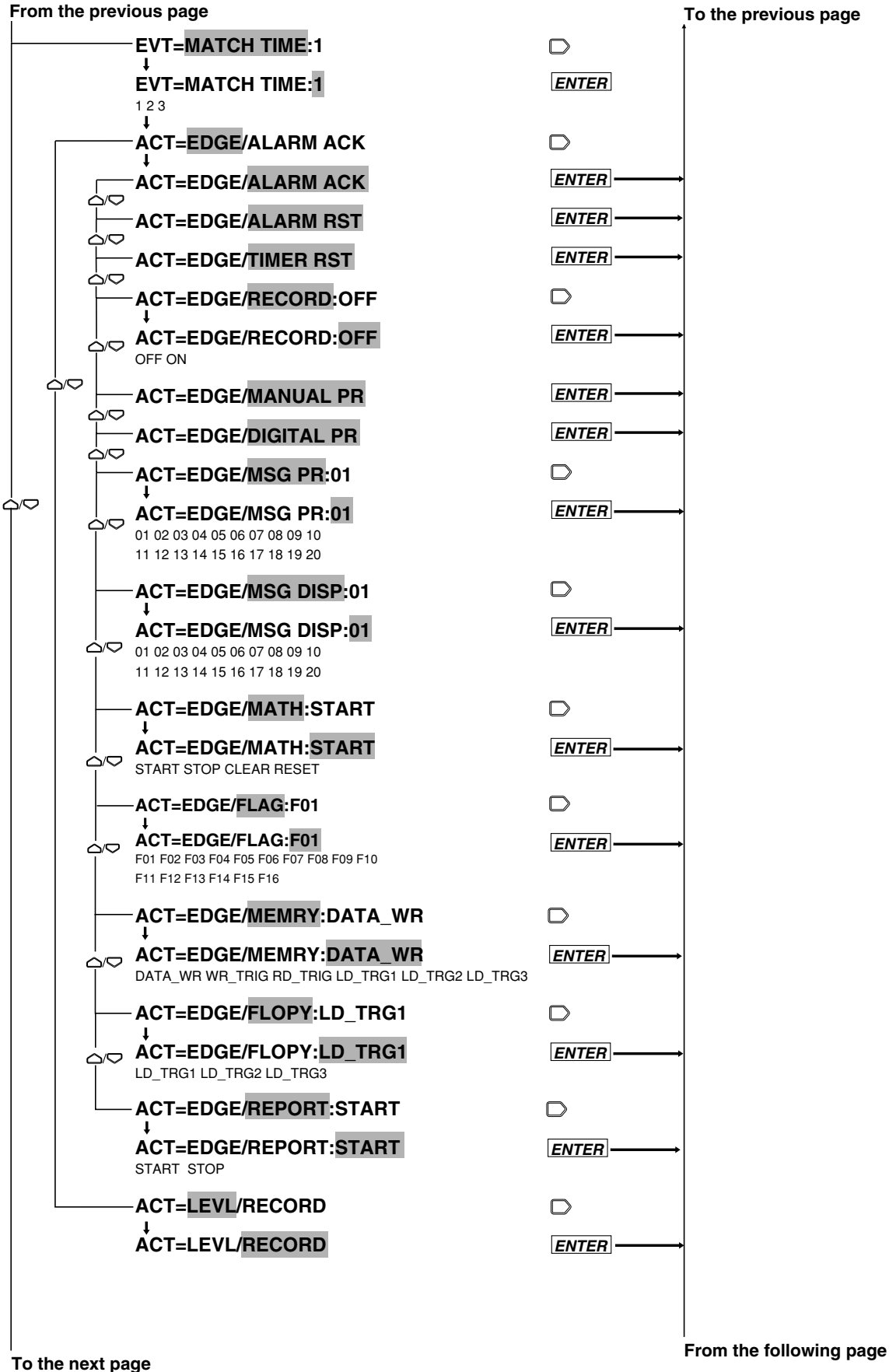

Explanation

When an event is detected, this menu allows you to set and execute a certain action.

Selection of logic (LOGIC) box number

- Select a box number from among 01 to 30 for storing a combination logic from events to actions.
- Select the same number as the box number already indicating events and actions, and set an event and action to overwrite the logic number.

Selection of events (EVT)

Select any event from among the following:

- NONE — releases the event/action setting.
- REMOTE
 - This menu is displayed only with /R1 option.
 - When a remote control signal is applied, the action is executed.
 - There are 12 control signals available. Select any control signal from these numbers for event setting. Remote control signal terminal numbers are applicable for this selection. See page 3-15 for the remote control terminal numbers.
- ALARM

If an alarm occurs, the action is executed. See Section 8.1, “Setting Alarms and Relays (including internal switches),” on page 8-1 for setting alarms.
- RELAY

If the selected internal switch or relay is operating, the action is executed. When the alarm module or the DI/DO modules are not recognized as system modules (see page 9-17), the relay is set to OFF. See Section 8.1, “Setting Alarms and Relays (including internal switches),” on page 8-1 for setting internal switches and relays.
- CHART END

When the end of the chart is detected, the action is executed.
- TIMER
 - If the selected timer’s set time is up, the action is executed. Six timers are available. Select any from among these timers. See Section 6.1, “Setting the Recording Mode/Engineering Unit/Recording Channels/Recording Interval,” on page 6-3 for the timer setting provided earlier in this manual.
 - In combination with the level action, the action is repeated alternately between executing and stopping each time the timer’s set time is up.
- MFUNC KEY
 - When the M.FUNC key on the operation panel is pressed, the action is executed. Select either M.FUNC 1 or M.FUNC 2.
 - In combination with the level action, the action is repeated alternately between executing and stopping each time the M.FUNC key is pressed.
- MATCH TIME
 - When the set time is reached, the action is executed.
 - There are three types of applicable MATCH TIMES. Select any of them. For details, see Section 6.8, “Setting Match Time, Moving Average, Interpolation and Groups,” on page 6-17 provided earlier in this manual.
 - In combination with the level action, the corresponding action is repeated alternately between executing and stopping for each set time.

Selecting edge or level action

- Edge action (EDGE)

This action is executed when an event is detected.
- Level action (LEVEL)

This action is executed when an event is detected. When an event is released, this action will be canceled.

Selection of actions

An action that can be selected varies depending on the events and edge or level action. See the individual procedures. The following describe all actions available.

- **ALARM ACK**
This allows alarm acknowledgment. For the applicable functions, see Section 2.4, “Alarm Function,” on page 2-16.
- **ALARM RST**
This resets alarms. When the “RELAY” is selected for an event, this function cannot be selected. For the applicable functions, see Section 2.4, “Alarm Function,” on page 2-16.
- **TIMER RST**
This resets timers. For the applicable functions, see Section 2.3, “Recording Functions,” on page 2-9.
- **RECORD**
 - **ON:** Starts recording. The recording format is set individually. For details, see Section 10.2, “Setting Recording Format,” on page 10-3.
 - **OFF:** Stops recording. The level action does not include record ON/OFF functions.
 - When the level action is set, the ON/OFF functions using the RECORD key are disabled.
 - The edge and level actions cannot be set simultaneously.
For the level action, only one action is available.
- **MANUAL PR**
This enables manual printing. For applicable functions, see Section 2.3, “Recording Functions,” on page 2-13.
- **DIGITAL PR**
 - Digital printing starts in the analog trend mode. The recording intervals depend on the timer setting (see Section 2-9). When the event/action functions are set, normal digital print functions are disabled.
 - Only one function can be set in the event/action functions.
- **MSG PR**
 - Prints messages. For details, see Section 7.3, “Starting Message Printing,” on page 7-3.
 - Select any message from the corresponding codes 01 to 20.
- **MSG DISP**
 - Displays messages. For details, see Section 7.3, “Starting Message Printing,” on page 7-3.
 - Select any message from the corresponding codes 01 to 20.
 - To cancel the message display, press any key.
- **SPEED CHG**
 - Changes chart speed 1 to chart speed 2. When the recording interval is set to automatic (page 6-2), the recording interval is also changed. When the event is released, the chart speed and recording interval return to their original positions.
 - Only one function can be set in the event/action functions.
- **GR TREND**
 - This executes the recording in a channel in which the group setting (page 6-17) has already been made. For this, set the dot-recording (see on page 10-14) to “GROUP” and start recording by key operations following the “RECORD” given above.
 - Select any group from G01 to G07.
 - Only one identical group can be set in the event/action functions.

Note

- If Chart End appears, counter-actions such as RECORD ON are not executed.
 - Actions such as RECORD or SPEED CHG may operate later than an event occurrence. For example, with RECORD set in the action setting, if an alarm occurs, the measured values in that condition are not recorded. This is because recording operations are delayed due to an action operation.
-

- MATH (available if the instrument is equipped with the MATH function or floppy disk drive)
 - START: Starts computation.
 - STOP: Stops computation.
 - RESET: Resets computation channel data at the end of completion of the first computation in case an event takes place.
 - CLEAR: Resets computation channel data immediately in case an event takes place.
 - RST_G01 to RESET_G07: Resets the computing channel data registered in the specified group number to 0. This is invalid for measuring channels. The timing for resetting the data is as follows.

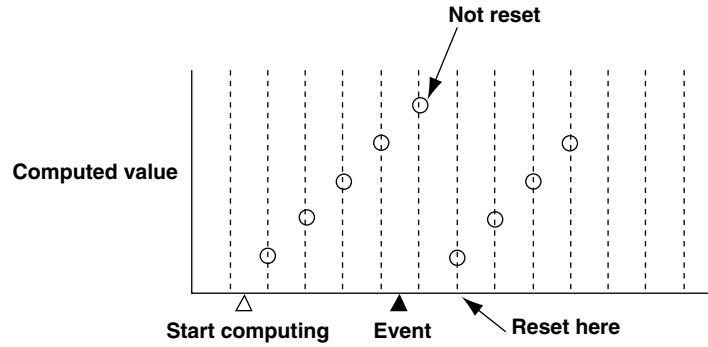

- If MATH is selected as a level action, computation will be carried out while an event is present. Computation will stop when the event is cleared.
- When the level action is set, the start/stop/clear & start computation using using the M. FUNC key are disable.
- The edge and level actions cannot be set simultaneously. For the level action, only one action is available.
- MEMORY (available with the DR130-1/DR231-1/DR241-1 equipped with the floppy disk drive)
 - DATA_WR: saves one data item to the specified data length each time an event occurs.
 - WR_TRIG: saves measured/computed data on the built-in RAM disk.
 - RD_TRIG: reads measured/computed data from the built-in RAM disk.
 - LD_TRG1 to 3: reads setup data from the built-in RAM disk.
- FLOPY (available only when provided with the "/M1" option or a floppy disk drive):
 - LD_TRG1 to 3: reads setup data from the floppy disk.
- FLAG (only for /M1 optional model)
 - F01 to 16: Set the flag number (F01 to F16) to 1. F01 to F16 are normally 0. Flags can be placed in computing equations to hold the computed result using a certain event as a trigger, or reset to 0.
- REPORT (available if the instrument is equipped with the REPORT function.)
 - START (Edge action): Starts making up a report.
 - STOP (Edge action): Stops making up a report.
 - REPORT (Level action): Starts/stops making up a report.

Note

- If, in the SETUP mode, the report function is set to OFF for all data items, you cannot select the action item REPORT.

9.2 Copying

Relevant Keys

SET=	RECORD
COPY	ALARM
>Select Setting Parameter	CHART
SYSTEM UNIT TREND TIMER LOGIC COPY	KEYLOCK

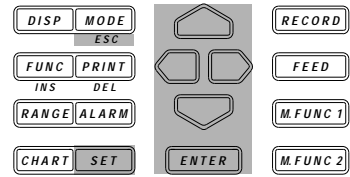

Operating Procedure

- Press the SET key to enter the SET menu.
- Select/set **█** using the keys.
- To escape from a lower menu, press the MODE (ESC) key. Its main menu will appear, although new settings/selections will not be kept.
- New settings/selections will be kept when you reach the final display of that setting.

(Main menu)

SET=



COPY

(Lower menu)

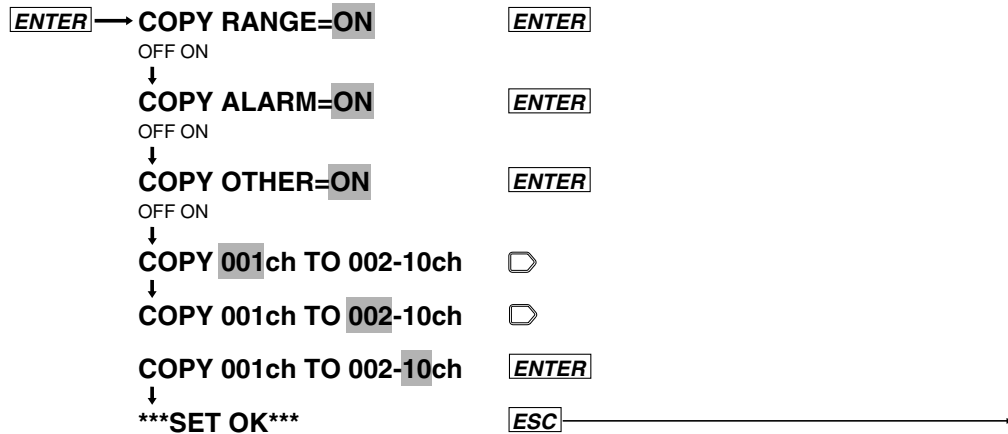

Explanation**Selecting range copying (COPY RANGE)**

- ON: Copies the type of input, measuring ranges, recording spans, linear scaling, engineering units, and tags set.
- OFF: The copying of ranges is disabled.

Selecting alarm copying

- ON: Copies the type of alarm, alarm values, and relay (internal switch) setting.
- OFF: The copying of alarms is disabled.

Selecting copying of other items (COPY OTHER)

- ON: Copies setting recording zones, partial compressions, dot-recording ON/OFF, digital printing ON/OFF, manual printing ON/OFF, alarm printout ON1/ON2/OFF, scale-value printout ON1/ON2/ON3/OFF, list-printout ON/OFF, average numbers in moving averages and interpolation ON/OFF.
- OFF: The copying of other items is disabled.

Setting a copy-source channel

Sets a copy-source channel with up to three characters. For details on these characters, see Section 4-1, "Using Auto Mode," on page 4-2.

Setting a destination channel to be copied

Sets a channel to which the setting data in the source channel are copied.

- When the COPY RANGE, COPY ALARM and COPY OTHER are set to ON, individual set data are copied.
- For the setting of a destination channel number, see Section 5.1, "Setting the Type of Input and Recording Span," on page 5-2.

Setting a computation channel to be copied

Copies the following settings.

Range copy ON : Computation equation, unit, tag

Alarm copy ON : Alarm

Other copy ON : Zone, partial, trend ON/OFF, digital print ON/OFF, scale print ON/OFF, manual print ON/OFF, alarm print ON/OFF, list print ON/OFF, linear interpolation

9.3 Alarm Acknowledgment, Alarm Reset, Timer Reset, Computation, Keylock, and Message Printout

Relevant Keys

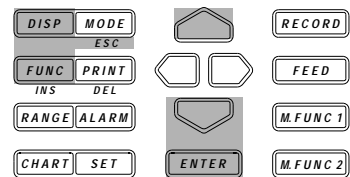
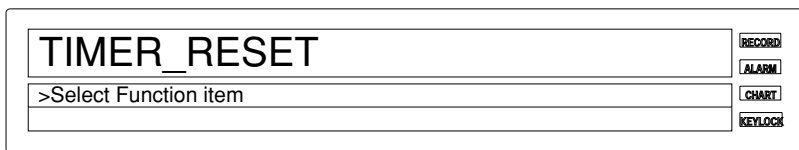

Operating Procedure

- Press the FUNC key to enter the FUNC menu.
- To enter the FUNC menu from the RANGE, ALARM, CHART or SET (SET3) menu, press the DISP key.
- Select/set using the keys.
- To escape from a lower menu, press the MODE (ESC) key. Its main menu will appear, although new settings/selections will not be kept.
- There may be some menus that are not displayed due to the basic settings as described in Chapter 10.

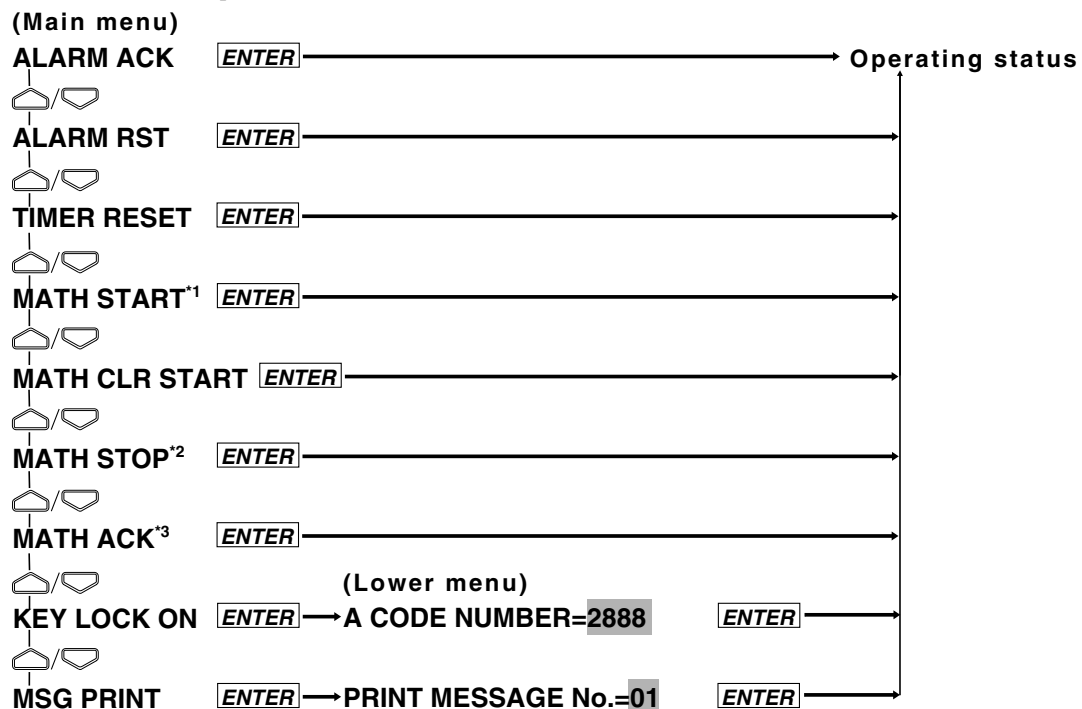

*1: Displayed when computation is not in progress.

*2: Displayed when computation is in progress.

*3: Displayed when incomplete measurement occurs while computation is in progress.

Note

- If MATH is selected as a level action, MATH START, MATH CLR START and MATH STOP will not be displayed.
- The displayed information varies depending on the settings given in Section 10.8, "Setting FUNC/FUNC3 Menu." The flow of operation shown above is the one given when the recorder is in the default state.

Explanation

Any of the following functions are executed by pressing the ENTER key. After that, the recorder returns to the operation mode.

Alarm acknowledgment (ALARM ACK)

- When the alarm display hold (ALARM HOLD), on page 10-8 is set to ON, the alarm acknowledgment menu appears.
- For the alarm display hold functions, see Section 2.4, “Alarm Function,” on page 2-16.

Alarm reset (ALARM RST)

- When the relay hold function (on page 10-11) is set to ON, the alarm reset menu appears.
- For the alarm reset functions, see Section 2.4, “Alarm Function,” on page 2-16.

Timer reset (TIMER RESET)

- For the timer reset functions, see Section 2.3, “Recording Functions,” on page 2-9.

Computation start (MATH START)

- Starts computation. For details, refer to Chapter 12, “Executing Computation”.

Computation clear start (MATH CLR START)

- Clears computation results then re-starts computation.

Computation stop (MATH STOP)

- Stops computation.

Clearing Incomplete Measurement Status (MATH ACK)

- Clears the status indication displayed due to incomplete measurement which occurred during computation.

Keylock function (KEY LOCK ON)

- For the keylock functions, see Section 2.6, “Other Functions,” on page 2-18.
- The KEY LOCK ON is displayed after selecting the keylock (see page 10-16).
- Enter a password (A CODE NUMBER) and then press the ENTER key to actuate the keylock functions. The KEY LOCK OFF menu then appears.
- Enter the FUNC menu, select KEY LOCK OFF and then enter a password (A CODE NUMBER). Press the ENTER key to release the keylock functions. The menu returns to KEY LOCK ON.
- To set a password, see page 10-16.
- When the keylock functions are actuated, the “KEYLOCK” lights up.

Message printout (MSG PRINT)

- Prints out messages. For details, see Section 7.3, “Starting Message Printing,” on page 7-3.
- Select a message from the corresponding code 01 to 20.

9.4 Clearing Alarm/Message Buffers, and Displaying and Initializing Module/Communications Information

Relevant Keys

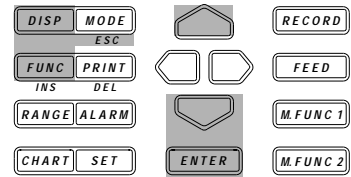
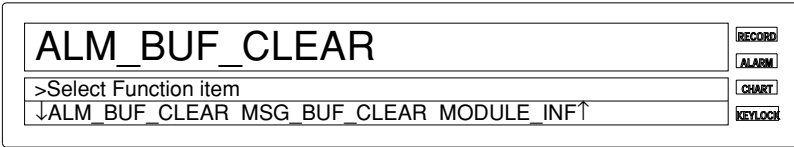

Operating Procedure

- Press the FUNC key for three seconds to enter the FUNC3 menu.
- To enter the FUNC menu from the RANGE, ALARM, CHART or SET (SET3) menu, press the DISP key.
- Select/set using the keys.
- To escape from a lower menu, press the MODE (ESC) key. Its main menu will appear, although new settings/selections will not be kept.
- There may be some menus that are not displayed due to basic settings as described in Chapter 10.

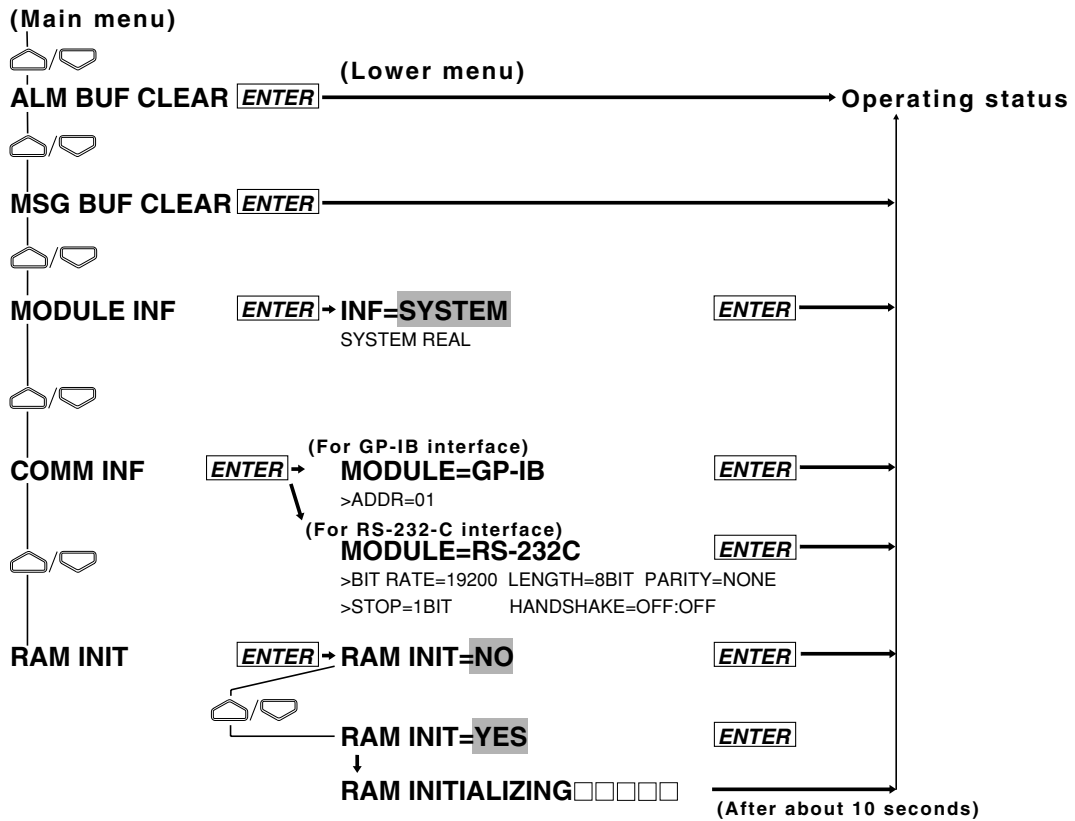

Note

- The displayed information varies depending on the settings given in Section 10.8, "Setting FUNC/ FUNC3 Menu." The flow of operation shown above is the one given when the recorder is in the default state.

Explanation

Any of the following functions are executed and displayed by pressing the ENTER key, the last key of the lower menu. After that, the recorder returns to the operation mode.

Clearing the alarm buffer (ALM BUF CLEAR)

Cancels all information in the alarm buffer; see page 6-11.

Clearing the message buffer (MSG BUF CLEAR)

Cancels all information in the message buffer; see page 7-3.

Displaying information set in the modules (MODULE INF)

Displays the information in the module installed in the slot.

- **SYSTEM:** Displays the information recognized as the system module.
- **REAL:** Displays the real module information when the recognized system module is replaced by another one or removed.
- If the SYSTEM or REAL module has displayed different information and if the recorder is still used, an operation error may occur or the recorder may display measured values incorrectly. If such problems develop, contact your nearest sales representative. Addresses may be found on the back cover of this manual.
- The information on individual modules is displayed as follows:

Module	Display	ID inside the display ()	Description
Input module	INPUT	00 to 3F	
DI/DO module	REMOTE	57	With /R1 option
Alarm module	RELAY	5C to 5F	With /A4 option
Communication module	COMM	48 to 4F	With/communication option
		Module not installed	----- FF Invalid module
installed	=====	FE	
Module error	XXXXXX	Displays error code (80 to FF).	

Displaying communications information (COMM INF)

When the communication module is recognized as a system module, communications information is displayed. For details on the communication information, see Section 3-4, “Connecting the Interface Cables,” on page 3-11 or the separate DR130/DR231/DR232/DR241/DR242 Communication Interface User’s Manual (IM DR231-11E).

Initialization (RAM INIT)

This initializes information other than the basic information set in Chapter 10 or calibration set in Chapter 11. For details on initial setting, see the appropriate sections and explanations. All the files in the internal RAM disk will be lost when the RAM is initialized.

- **NO:** Initialization not executed
- **YES:** Initializes the information. It takes about ten seconds to initialize the information.

9.5 Fail/Chart End Output, and Remote Control Signal Input

Function

See Section 2.6, "Other Functions," on page 2-19.

Connections and Notice

See Section 3.5, "Connecting the Signal Lines," on page 3-16.

9.6 Summer/Winter Time

Relevant Keys

SET=DST	RECORD
>Select Setting Parameter	ALARM
SYSTEM UNIT TREND TIMER LOGIC DST COPY	CHART
	KEYLOCK

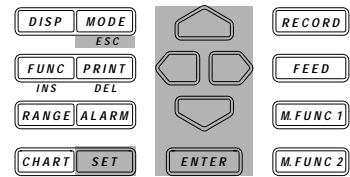

Operating Procedure

- Press the SET key to enter the SET menu.
- Select/set using the keys.
- To escape from a lower menu, press the MODE (ESC) key. Its main menu will appear, although new settings/selections will not be kept.
- New settings/selections will be kept when you reach the final display of that setting.

(Main menu)

SET=

DST

(Lower menu)

ENTER → SET TIME=SUMMER **ENTER**

SUMMER WINTER

↓
SUMMER=96/05/01 00 **ENTER**

>Set Data & Time YY/MM/DD HH:00:00

↓
*****SET OK***** **ESC**

Explanation

Using this function the DR will automatically change its date and time to the summer time or winter time when appropriate.

If you specify SUMMER, the time will be adjusted to one hour later when the specified date and time is reached.

If you specify WINTER, the time will be adjusted to one hour earlier when the specified date and time is reached.

When the set time is reached, the setting will return to its initial value of 50/01/01 00.

The value of the years are as follows : 00 to 49 stand for the year 2000 to 2049, whereas 50 to 99 stand for the years 1950 to 1999.

Explanation

In the [PRN ADJ] menu, three lines are dot-printed according to the left and right movements of the carriage.

Adjustment of Dot-printing Shift (HYS)

Dots are printed in a line along the length of the chart almost in the middle following the right and left movements of the carriage. If these dots shift either to the left or the right, make a straight line by adjusting the HYS setting.

- The setting range is -50 to 50.
- The set value 1 corresponds to about 0.1 mm of the dot-printing position.

Adjustment of Zero Position (ZERO)

If a line composed of printed dots shifts from the scale line at the left end of the chart, have the line of dots just overlap the scale end line by adjusting the ZERO setting.

- The setting range is 1 to 500.
- The set value 1 corresponds to about 0.1 mm of the dot-printing position.

Adjustment of Full-scale Position (FULL)

If a line composed of printed dots shifts from the scale line at the right end of the chart, have the line of dots just overlap the scale end line by adjusting the FULL setting.

- The configurable range is as follows:
 - DR130: 1400-1600
 - DR231/241: 2400-2600
- The set value 1 corresponds to about 0.1 mm of the dot-printing position.

Selection of Scan Interval (SCAN INTVL)

- Select 2, 3, 4, 5, 6, 10, 12, 15, 20, 30 and 60 seconds as the interval.
- The default setting is 2 seconds.
- The shortest selectable scan interval varies with the setting of the number of input channels, A/D converter integration time, or filter ON/OFF. For details, see chapter 12.

Note

- In order to make the set or selected contents effective, the contents must be registered. For details, see page 10-24.
 - To return from the SET UP menu to the operation display mode, select END in the main menu. For details, see page 10-24.
-

10.2 Setting Recording Format

Relevant Keys

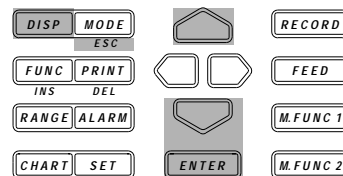
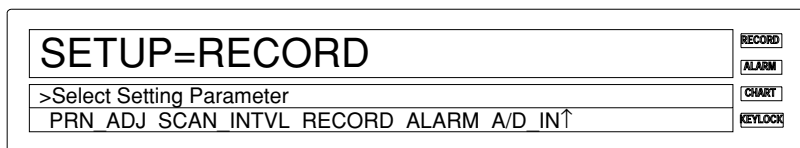

Operating Procedure

- Enter the SET UP menu in the following procedure:
 1. When the display presents the operation display mode or a menu other than the SET UP menu, first turn off the power switch.
 2. Turn the switch back on while pressing the DISP key and continue pressing the DISP key for about 5 seconds.
- Select/set **RECORD** using the keys.
- To escape from a lower menu, press the MODE (ESC) key. Its main menu will appear, although new settings/selections will not be kept.
- New settings/selections will be kept when you reach the final display of that setting.

(Main menu)

SET UP=



RECORD

(Lower menu)

ENTER → CH OR TAG=CHANNEL **ENTER**

CHANNEL TAG

↓
TAG PRINT LEN=7 **ENTER**
7 8 9 10 11 12 13 14 15 16

↓
TREND MODE=NORMAL **ENTER**
NORMAL ALARM1 ALARM2 GROUP

↓
SPEED CHANGE PR=ON **ENTER**
OFF ON

↓
ON/OFF MARK PR=ON **ENTER**
OFF ON

↓
DIGITAL PR CLMN=1 **ENTER**
1 2 3 4*

↓
CHANNEL PITCH=5.0mm **ENTER**
OFF 5.0mm 12.5mm

↓
TITLE PITCH=1500mm **ENTER**
OFF 600mm 1500mm

↓
SCALE TIC PR=OFF **ENTER**
OFF ON

↓
LOG FORMAT=HORIZON **ENTER**
HORIZON VERTICAL

↓
LOG INTERVAL=SINGLE **ENTER**
SINGLE MULTIPLE

↓
RECORD SET **ESC**

* For the DR130, indicated as "1 2."

Explanation

Selection of Channel Number or Tag (CH OR TAG)

Select the call name for printing or displaying the measured values of either CHANNEL or TAG.

- Select either CHANNEL or TAG. However, if the TAG setting includes all spaces (vacant), the channel is printed or displayed regardless of selection.
- The default setting is CHANNEL.
- For the TAG setting, see Section 6.4, "Setting Tag, Digital Printout and Manual Printout."

Selection of Number of TAG Printing Characters(TAG PRINT LEN)

- Select 7, 8, 9, 10, 11, 12, 13, 14, 15 or 16.
 - The default setting is 7.
 - If the number of printing characters is less than the set TAG set in sect. 6.4. Only the number selected here will be printed.
- For the number of characters when displaying, see chapter 4.

Selection of Dot-printing Recording System(TREND MODE)

Select it from the following systems. The default setting is NORMAL. To practically record it, the RECORD must be turned on. Channels to be recorded are those selected to be ON in "Setting the Channels to be Recorded, Trend Recording" on page 6-2.

- NORMAL:
 - Records all channels to be recorded.
- ALARM1:
 - Records only those channels in which alarms are generated.
 - Continues recording even if the alarm is reset.
- ALARM2:
 - Records only the channels in which alarms are generated.
 - Stops recording when the alarm is reset.
- GROUP:
 - Records the channels which are set into a group (see page 6-16).
 - Recording can be done only if "GR TREND" is set in the event/action function.

Selection of Printing When Chart Speed Is Changed (SPEED CHANGE PR)

When the chart speed is changed in dot-recording, select whether to print with the changed chart speed or not.

- OFF: does not print.
- ON: prints.
- The default setting is ON.

Selection of Printing Record-Start/Stop Time (ON/OFF MARK PR)

In trend recording, select whether the record-start/stop time is printed or not.

- OFF: not printed.
- ON: printed.
- The default setting is ON.

Selection of Number of Columns for Digital Printing (DIGITAL PR CLMN)

Select to print measured values for the number of channels in a horizontal line.

DR130:

- Select either 1 or 2 columns.
- The default setting is 1.
- If TAG is defined using 8 or more characters, the recorder prints for the option "1 column."

DR231/241:

- Select 1, 2, 3, or 4.
- The default setting is 1.
- If TAG has been selected in selecting the channel number/TAG, choice is 1, 2, or 3 when the TAG name consists of 8 characters or more.
- If TAG uses 16 characters, the TAG entry is limited to two columns.

Selection of Channel Number Printing Pitch (CHANNEL PITCH)

In trend recording, select how many millimeters are taken as the channel number printing interval.

When TAG has been selected in channel number/TAG selection, the TAG corresponding to the channel number is printed.

- OFF: not printed.
- 5.0 mm: printed every 5.0 mm.
- 12.5 mm: printed every 12.5 mm.
- The default setting is 5.0 mm.

Selection of Title Printing Pitch (TITLE PITCH)

In trend recording, select how many millimeters are taken as the title printing interval. For setting a title, see Section 6.7, "Entering Messages, Headers and Title" (page 6-15).

- OFF: not printed.
- 600 mm: printed every 600 mm.
- 1500 mm: printed every 1500 mm.
- The default setting is 1500 mm.

Selection of Scale Check Mark Printing (SCALE TIC PR)

In trend recording, select whether a tic mark indicating the scale mark positions is printed or not.

For setting the scale mark printing, see Section 6.6, "Setting Scale Printout, List Printout and List Format" (page 6-13).

- OFF: not printed
- ON: printed
- The default setting is OFF.

Selection of Horizontal or Vertical Printing (LOG FORMAT)

In logging mode, select either horizontal or vertical printing of the channel number/TAG. For examples of printing, see Section 2.3, "Recording Functions" (page 2-8).

- HORIZON: printed horizontally.
- VERTICAL: printed vertically
- The default setting is HORIZON.

Selection of Recording Interval in Digital Printing/ Logging Mode (LOG INTERVAL)

Select recording of the channel number/TAG and measured values whether at one interval or at a selected interval for each channel from the 6 timers. For the setting of the timer, see Section 6.1, "Setting the Recording Mode/Engineering Unit/Recording Channel and Recording Interval" (page 6-3), and for the selection of the timer for each channel, see Section 6.4, "Setting Tag, Digital Printout and Manual Printout" (page 6-9).

- **SINGLE:**
 - Digital print: The interval is determined by the chart speed and the number of columns to be printed. See the table in chapter 14 (page 14-4).
 - Logging mode: interval for timer No. 1
- **MULTIPLE:** intervals selected for each channel from 6 kinds of timers for either Digital printing or the Logging mode.
- The default setting is SINGLE.

Note

- In order to make the set or selected contents effective, the contents must be registered. For details, see page 10-24.
 - To return from the SET UP menu to the operation display mode, select END in the main menu. For details, see page 10-24.
-

10.3 Select Alarm Interval/Hysteresis/Hold/A/D Converter Integration Time/Filter

Relevant Keys

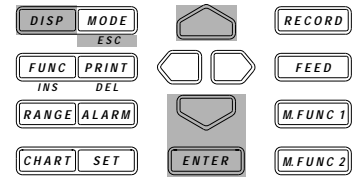
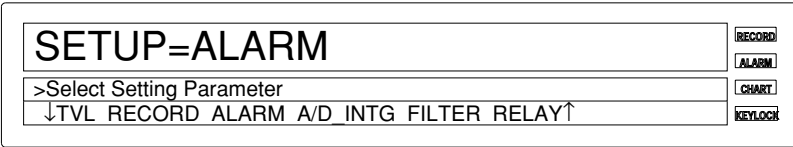

Operating Procedure

- Enter the SET UP menu in the following procedure:
 1. When the display presents the operation display mode or a menu other than the SET UP menu, first turn off the power switch.
 2. Turn the switch back on while pressing the DISP key and continue pressing the DISP key for about 5 seconds.
- Select/set using the keys.
- To escape from a lower menu, press the MODE (ESC) key. Its main menu will appear, although new settings/selections will not be kept.
- New settings/selections will be kept when you reach the final display of that setting.

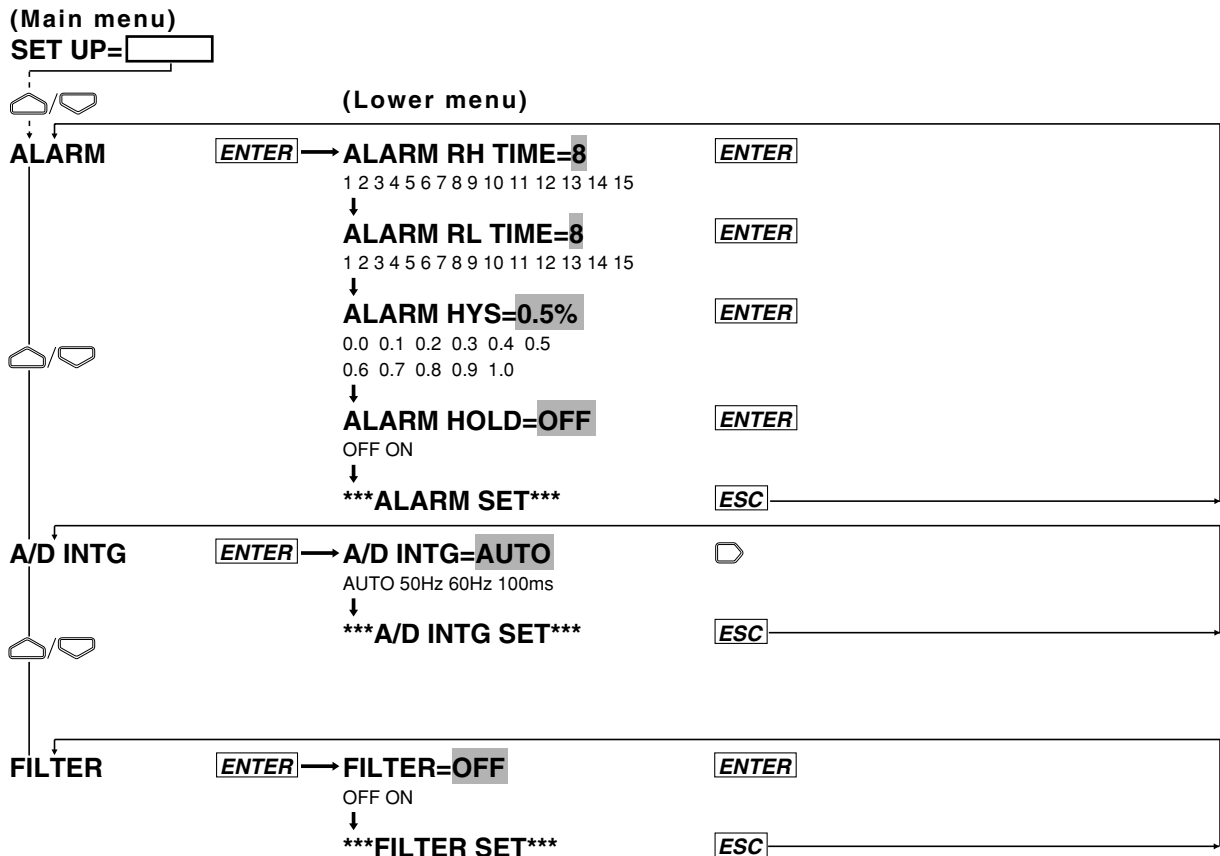

Explanation

Selection of Interval for High Limit of Rate-Of-Change Alarm (ALARM RH TIME)

Set the number of measurement repeats in “Interval = measurement interval x measurement repeats.”

- Select 1, 2, 3, 4, 5, 6, 7, 8, 9, 10, 11, 12, 13, 14, or 15.
- The default setting is 8.

Selection of Interval for Low Limit of Rate-Of-Change Alarm (ALARM RL TIME)

- The same selection method as the above.

Selection of Alarm Hysteresis (ALARM HYS)

Applied to high/low limit alarm.

- Select 0.0, 0.1, 0.2, 0.3, 0.4, 0.5, 0.6, 0.7, 0.8, 0.9 or 1.0%.
- The default setting is 0.5%.

Selection of Alarm Display Hold (ALARM HOLD)

Select whether the alarm display is held or not when the alarm is reset.

- OFF: hold
- ON: not hold
- The default setting is OFF.

Selection of A/D Converter Integration Time (A/D INTG)

Select the A/D converter integration time. Select it from the following:

- AUTO: the frequency of 50/60 Hz is automatically switched corresponding to the power frequency of this instrument. However, AUTO does not function when using DC power supply. Selecting AUTO will set the A/D integration time to 50 Hz (20 ms).
- 50 Hz: the integration time is set to 20 ms (50 Hz).
- 60 Hz: the integration time is set to 16.7 ms (60 Hz).
- 100 ms: the integration time is set to 100 ms (10 Hz)
- The default setting is AUTO. If the model is a DR130/DR231 with /P6 option or a DR241 with -2 power supply voltage specification, it is set to a default value of 50 Hz (20 ms). If you are using the instrument on a 60-Hz power supply, change the A/D integration time to 60 Hz (16.7 ms).

Selection of Filter (FILTER)

Select whether the input filter is operated or not. Select it from the following:

- OFF: Not operated
- ON: Operated
- The default setting is OFF.

Note

- In order to make the set or selected contents effective, the contents must be registered. For details, see page 10-24.
 - To return from the SET UP menu to the operation display mode, select END in the main menu. For details, see page 10-24.
-

10.4 Setting Operation Mode of Relay/Internal Switch

Relevant Keys

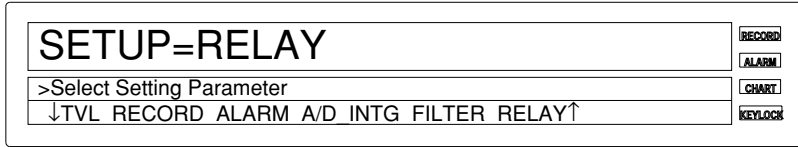

Operating Procedure

- Enter the SET UP menu in the following procedure:
 1. When the display presents the operation display mode or a menu other than the SET UP menu, first turn off the power switch.
 2. Turn the switch back on while pressing the DISP key and continue pressing the DISP key for about 5 seconds.
- Select/set **[]** using the **[]** keys.
- To escape from a lower menu, press the MODE (ESC) key. Its main menu will appear, although new settings/selections will not be kept.
- New settings/selections will be kept when you reach the final display of that setting.

(Main menu)

SET UP= []

[]
[]
RELAY

(Lower menu)

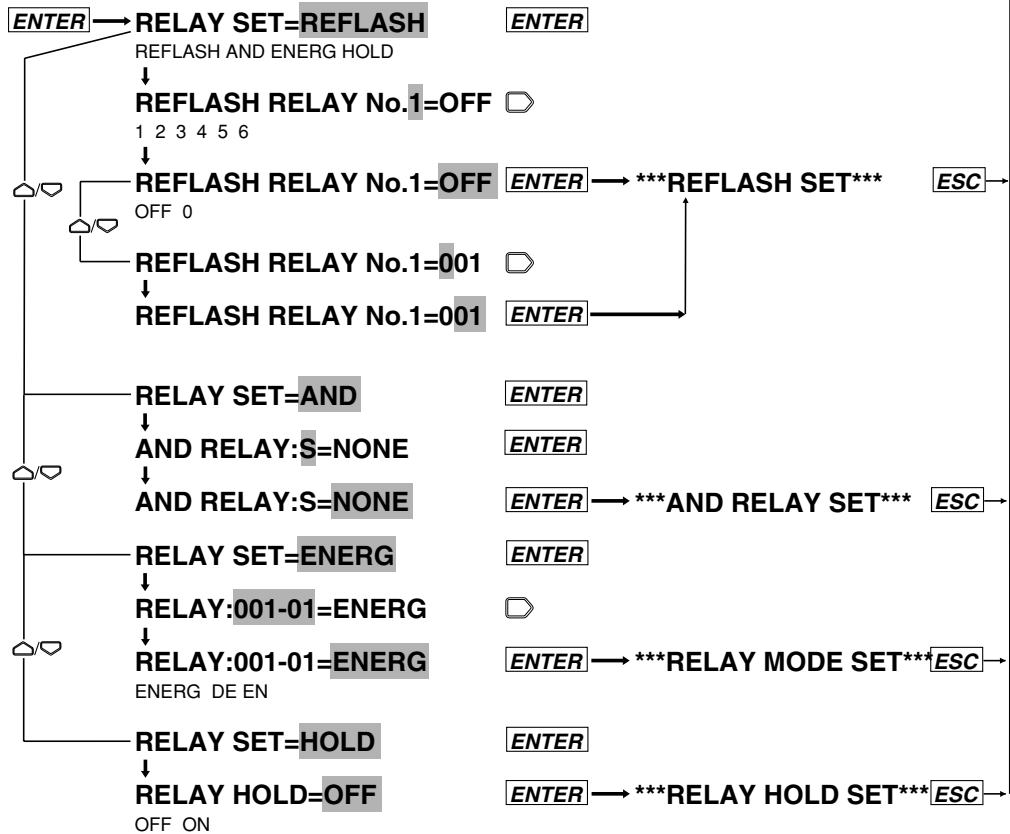

Explanation

The following operation mode is set to the alarm output relays and the internal switches. There are menus which cannot be displayed unless the alarm module (/A4 option) or the DI/DO module (/R1 option) is mounted. Also, there are menus which cannot be set to the internal switches.

Setting Re-failure or Re-alarm (REFLASH)

This is a menu for the /A4 option or /R1 option. Setting for the internal switches cannot be done. REFLASH setting is available for up to six relays.

- **Selection of REFLASH number**

Select from 1 to 6.

- **Setting of REFLASH relay**

- OFF: not set.
- Setting with numerals for 3 characters:
 - The first character is the unit number.
 - For the second and third characters, a number from 01 to 60 can be set but the effective setting range is as shown in the following examples: (Check which slot the alarm module or the DI/DO module is mounted in using the model number of modules mounted (see page 3-15) and their mounted positions. Slot numbers are set in the order of slot 0, slot 1,as viewed facing the rear.)

Ex. 1: When the alarm module is mounted in slot 3: 31 to 40

Ex. 2: The DI/DO module is mounted in slot4: 41 to 42

- The default setting is OFF.

Setting AND/OR (AND)

This can be set either to the relays or the internal switches. However, the relay setting can be made when the /A4 option or /R1 option is selected.

- **Selection of Internal Switch/Relay**

- S: internal switch is set.
- O: relay is set.
- The default setting is S.

- **Setting AND/OR**

The relays or the internal switches are set to AND in up to the set range and set to OR in the range exceeding the set range.

- For internal switches: set from 01-01 to 01-60.
- For the /A4 option:01-01 to 01-60 can be displayed. However, if this option is installed in slot 4, 01-41 to 01-50 is the effective setting range.
- For the R1 option: 01-01 to 01-60 can be displayed. However, if this option is installed in slot 5, 01-51 to 01-52 is the effective setting range.
- For the /A4 and /R1 option:01-01 to 01-60 can be displayed. However, if the /A4 and /R1 options are installed in slots 4 and 5 respectively, 01-41 to 01-52 is the effective setting range.
- In either case above, if all are to be set to OR or reset, set "NONE."
- The default setting is NONE.

Setting Energizing/Deenergizing (ENERG)

This is a menu displayed for the /A4 option or /R1 option. The internal switches cannot be set.

- **Relay Setting**

Set the object relays from one number relay (first relay) to another number relay (end relay). Set it under the condition that the first relay number \leq end relay number.

- First relay number:
 - The first character is a unit number.
 - For the second and third characters, a number from 01 to 60 can be set but the effective setting range is as shown in the following examples: (Check which slot the alarm module or the DI/DO module is mounted in using its mounted position. Slot numbers are set in the order of slot 0, slot 1, as viewed facing the rear.)
 - Ex. 1: When the alarm module is mounted in slot 3: 31 to 40
 - Ex. 2: The DI/DO module is mounted in slot4: 41 to 42
- End relay number: The same settings of the second or third characters in the first relay number.
- The default setting is 001-01.

- **Selection of energizing/deenergizing**

- ENERG: energizing
- DE EN: deenergizing
- The default setting is ENERG.

Setting Relay Hold (HOLD)

This is a menu displayed for the /A4 option or /R1 option. However, the internal switches are set simultaneously with relays.

- OFF: No relays/internal switches hold.
- ON: all relays/internal switches hold.
- The default setting is OFF.

Note

- In order to make the set or selected contents effective, the contents must be registered. For details, see page 10-24.
- To return from the SET UP menu to the operation display mode, select END in the main menu. For details, see page 10-24.

10.5 Setting Burn-out/Reference Junction Compensation

Relevant Keys

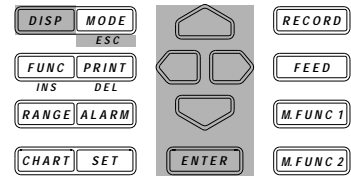
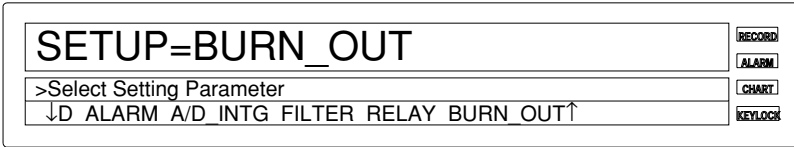

Operating Procedure

- Enter the SET UP menu in the following procedure:
 1. When the display presents the operation display mode or a menu other than the SET UP menu, first turn off the power switch.
 2. Turn the switch back on while pressing the DISP key and continue pressing the DISP key for about 5 seconds.
- Select/set **█** using the keys.
- To escape from a lower menu, press the MODE (ESC) key. Its main menu will appear, although new settings/selections will not be kept.
- New settings/selections will be kept when you reach the final display of that setting.

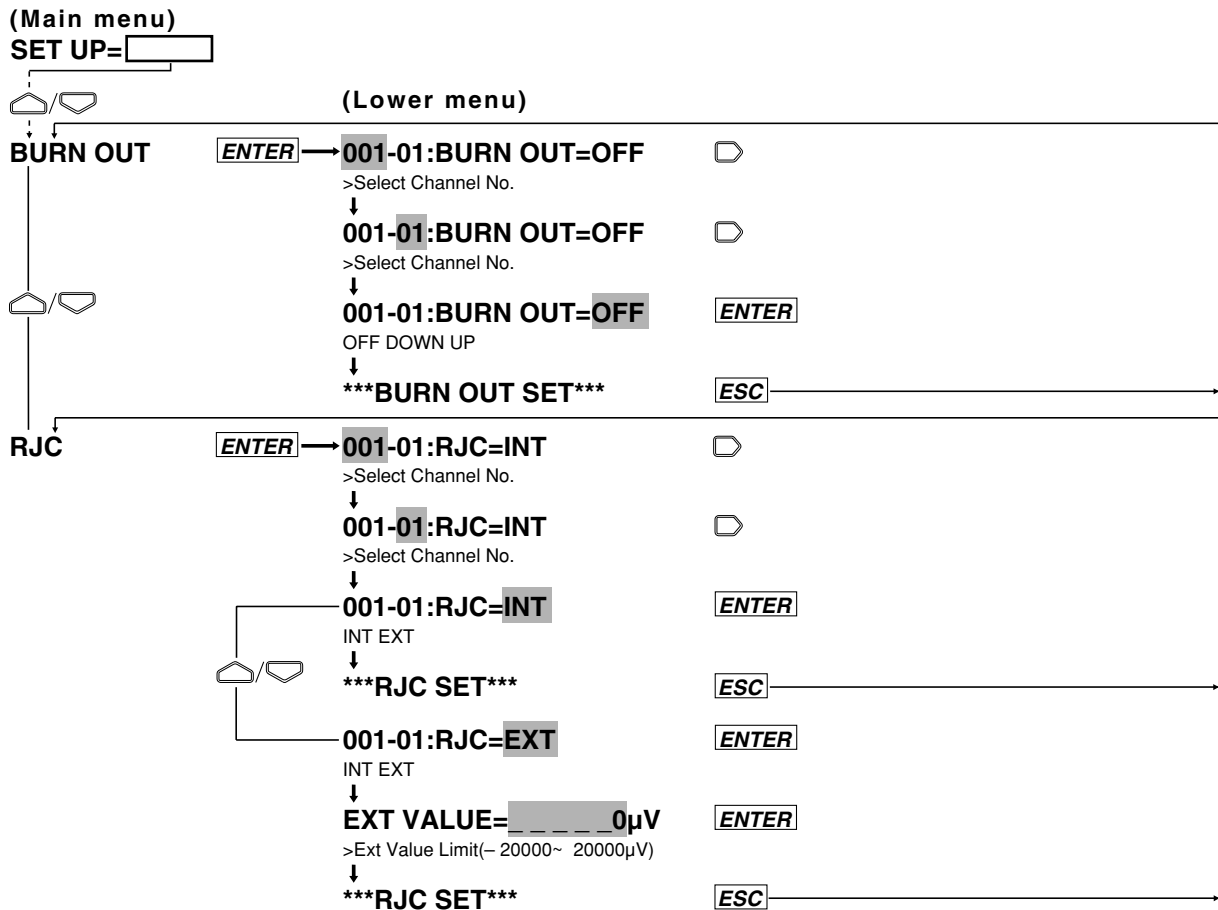

Explanation**Setting Burn-out (BURN OUT)**

Set the dot-printing position when burn-out occurs for each channel.

- OFF: the burn-out function is not actuated.
- DOWN: a dot is printed at the end of chart width on the minimum value setting side of the recording span.
- UP: Dot is printed at the end of chart width on the maximum value setting side of the recording span.
- The default setting is OFF.

Setting Reference Junction Compensation (RJC)

Set either the internal or the external compensation for each channel.

- INT: internal compensation is performed.
- EXT: external compensation is performed. For external compensation, set the voltage to be compensated.
Voltage to be externally compensated: set in the range of -20000 to 20000 mV.
- The default setting is INT.

Note

- In order to make the set or selected contents effective, the contents must be registered. For details, see page 10-24.
- To return from the SET UP menu to the operation display mode, select END in the main menu. For details, see page 10-24.

10.6 Setting Recording Colors

Relevant Keys

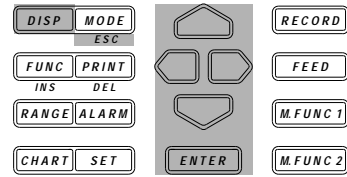
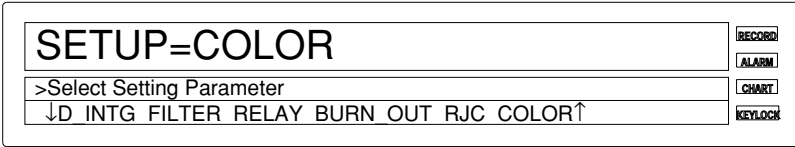

Operating Procedure

- Enter the SET UP menu in the following procedure:
 1. When the display presents the operation display mode or a menu other than the SET UP menu, first turn off the power switch.
 2. Turn the switch back on while pressing the DISP key and continue pressing the DISP key for about 5 seconds.
- Select/set using the keys.
- To escape from a lower menu, press the MODE (ESC) key. Its main menu will appear, although new settings/selections will not be kept.
- New settings/selections will be kept when you reach the final display of that setting.

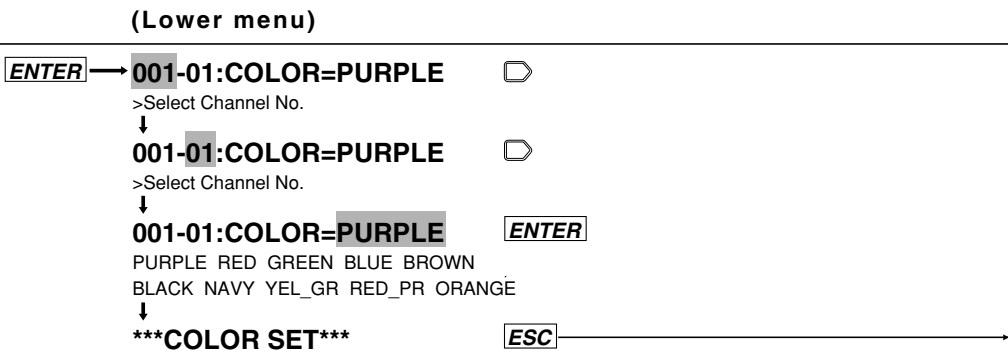
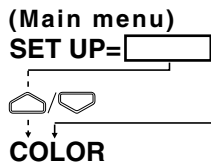

Explanation

Setting Recording Color

Set the recording colors for each channel. This setting can also be made for optional computation channels.

- Select a color from the following ten colors:
PURPLE, RED, GREEN, BLUE, BROWN, BLACK, NAVY (navy blue), YEL_GR (yellowish green), RED_PR (red-purple), and ORANGE
- The default setting is PURPLE for channel 1, RED for channel 2, GREEN for channel 3, BLUE for channel 4, BROWN for channel 5, BLACK for channel 6, NAVY for channel 7, YEL_GR for channel 8, RED_PR for channel 9, and ORANGE for channel 0.

Enter a unit number and a slot number in the two boxes .

Note

- In order to make the set or selected contents effective, the contents must be registered. For details, see page 10-24.
- To return from the SET UP menu to the operation display mode, select END in the main menu. For details, see page 10-24.

10.7 Setting Key Lock

Relevant Keys

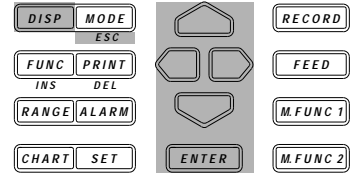
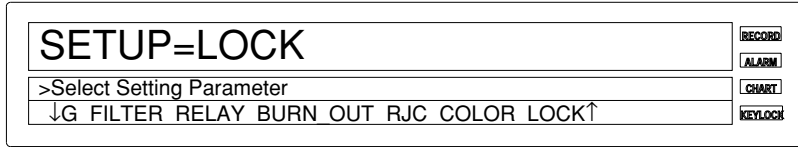

Operating Procedure

- Enter the SET UP menu in the following procedure:
 1. When the display presents the operation display mode or a menu other than the SET UP menu, first turn off the power switch.
 2. Turn the switch back on while pressing the DISP key and continue pressing the DISP key for about 5 seconds.
- Select/set [] using the [] [] keys.
- To escape from a lower menu, press the MODE (ESC) key. Its main menu will appear, although new settings/selections will not be kept.
- New settings/selections will be kept when you reach the final display of that setting.

(Main menu)

SET UP= []

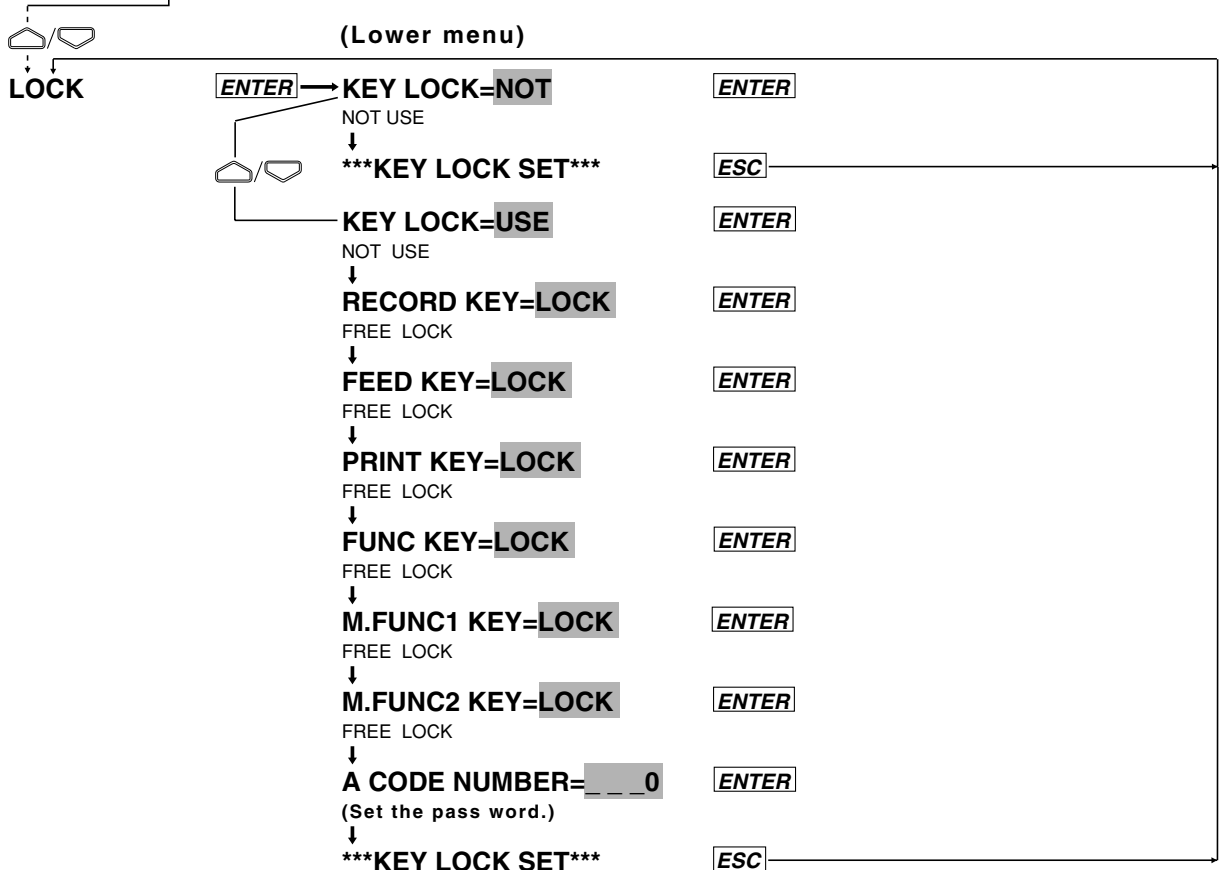

Explanation

Selection of Use or Nonuse of Key Lock

Select whether the key lock function is used or not used.

- NOT: the key lock function cannot be used.
- USE: the key lock function can be used. The menu “KEY LOCK ON” is displayed in the FUNC menu and key lock can be executed. For details, see Section 9.3, “Alarm Acknowledgment, Alarm Reset, Timer Reset, Keylock, and Message Printout” (page 9-15).
- The default setting is NOT.

Selection of Making Key Lock Ineffective

Even if key lock is executed, the turning on/off of the power switch, DISP/MODE key operation and cursor key operation are effective. Other than the above, whether operation of the following keys is made effective or locked can be selected.

- Selectable keys
RECORD, FEED, PRINT, FUNC, M.FUNC1, and M.FUNC2
- Choice
 - FREE: made effective.
 - LOCK: locked.
 - The default setting is LOCK.

Setting Password (A CODE NUMBER)

Set a password for executing/resetting key lock.

- Can be set in the range of 0 to 9999.
- The default setting is 0.

Note

- In order to make the set or selected contents effective, the contents must be registered. For details, see page 10-24.
 - To return from the SET UP menu to the operation display mode, select END in the main menu. For details, see page 10-24.
-

10.8 Setting FUNC/FUNC3 Menu

Relevant Keys

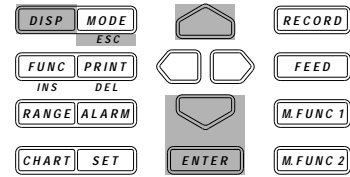
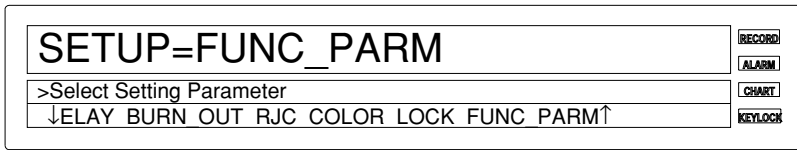

Operating Procedure

- Enter the SET UP menu in the following procedure:
 - When the display presents the operation display mode or a menu other than the SET UP menu, first turn off the power switch.
 - Turn the switch back on while pressing the DISP key and continue pressing the DISP key for about 5 seconds.
- Select/set using the keys.
- To escape from a lower menu, press the MODE (ESC) key. Its main menu will appear, although new settings/selections will not be kept.
- New settings/selections will be kept when you reach the final display of that setting.

(Main menu)

SET UP=

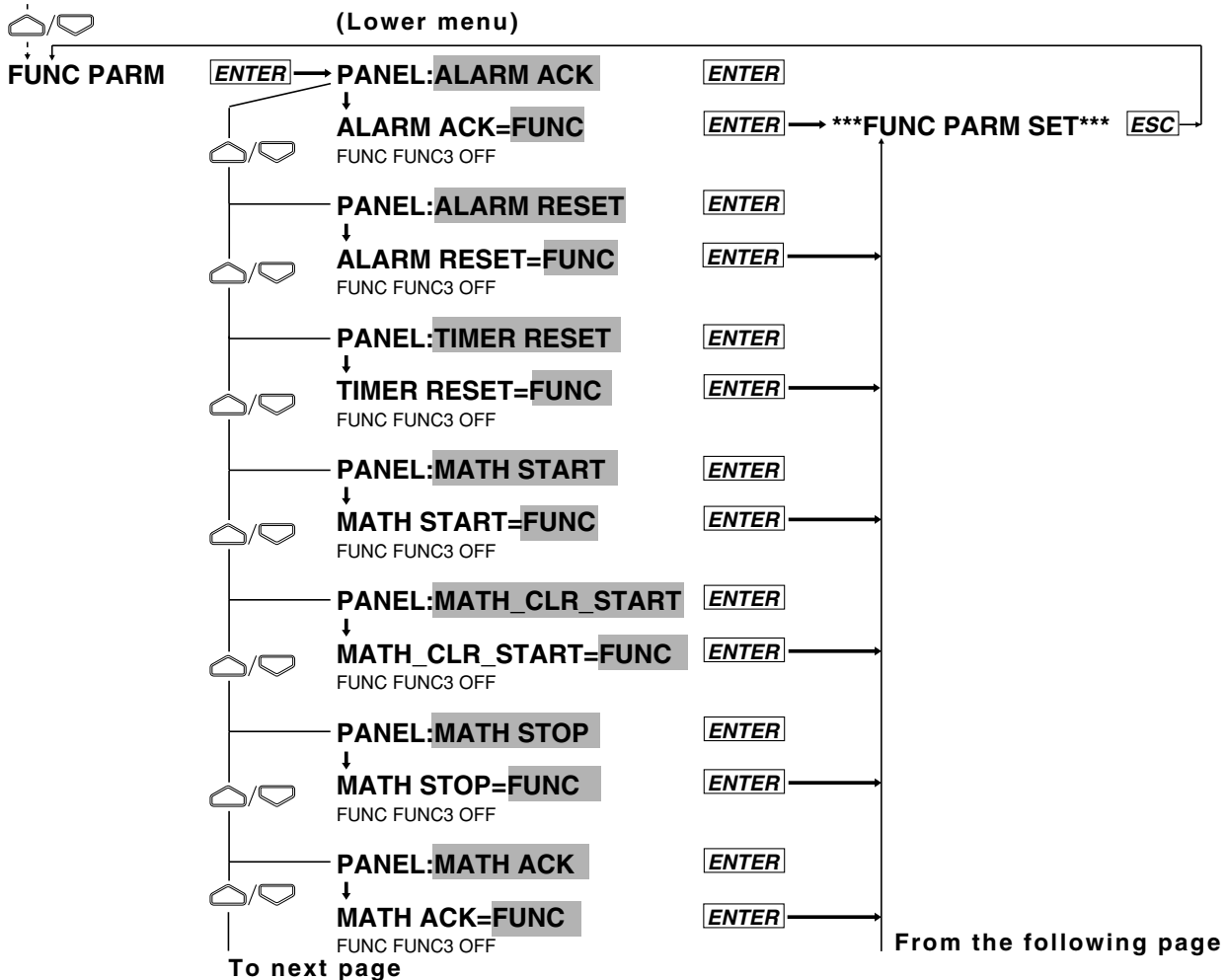

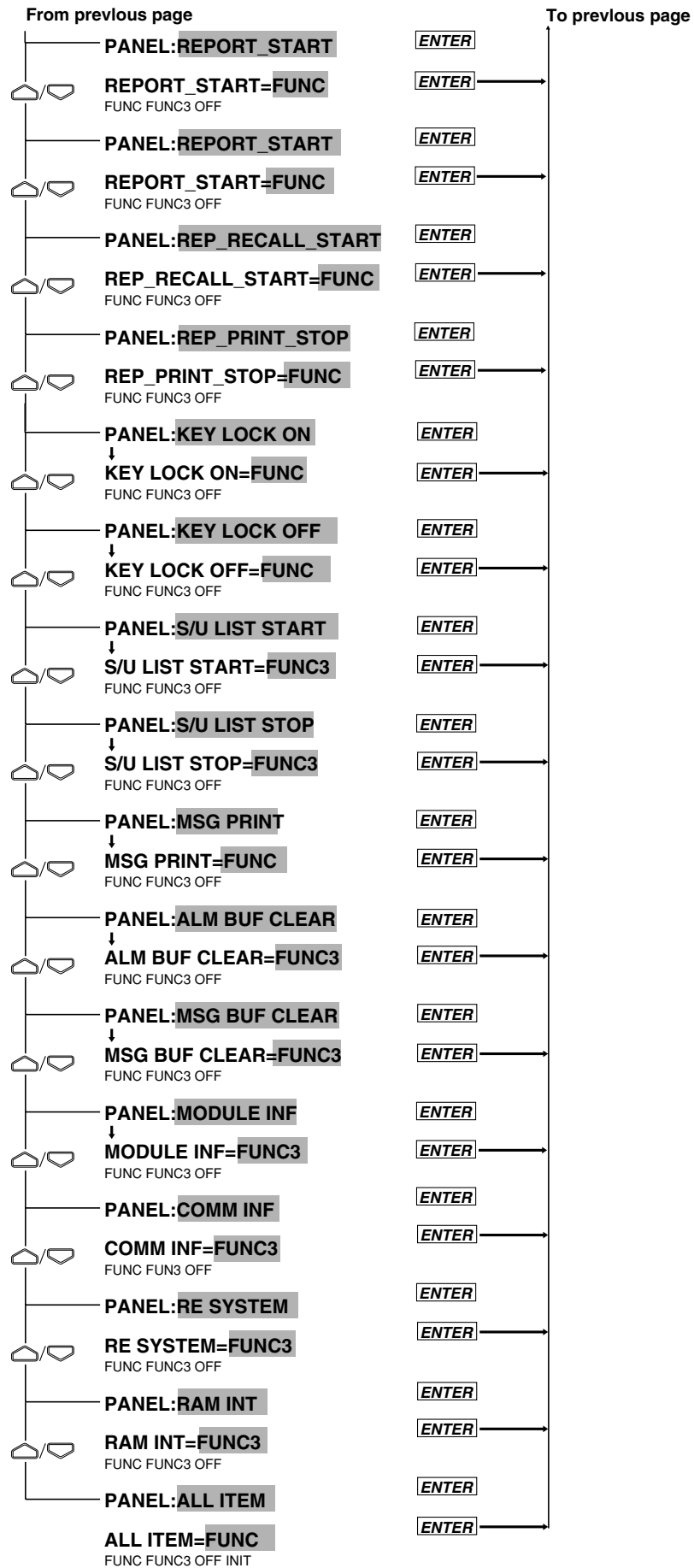

Explanation**Setting FUNC/FUNC3 (FUNC PARM)**

Select the menu to be displayed by pressing the FUNC key whether in the FUNC menu or the FUNC3 menu. The FUNC menu is displayed by pressing the FUNC key at a touch and the FUNC3 menu is displayed by pressing the FUNC key for about 3 seconds continuously.

- Select any of the following:
 - FUNC: displayed in the FUNC menu.
 - FUNC3: displayed in the FUNC3 menu.
 - OFF: not displayed in either menu.
- The default setting is as shown in the operating procedure diagram on pages 10-17 and 10-18.
- The last operation menu, "PANEL:ALL ITEM" is the menu that globally set all menus. However, the selection of "INIT" selects the default setting.
- The "COMM INF" menu is displayed for instruments with the communication option.

Note

- In order to make the set or selected contents effective, the contents must be registered. For details, see page 10-24.
- To return from the SET UP menu to the operation display mode, select END in the main menu. For details, see page 10-24.

10.9 Setting SET/SET3 Menu

Relevant Keys

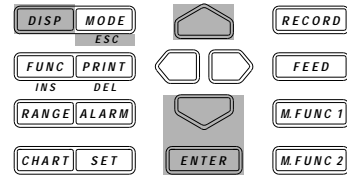
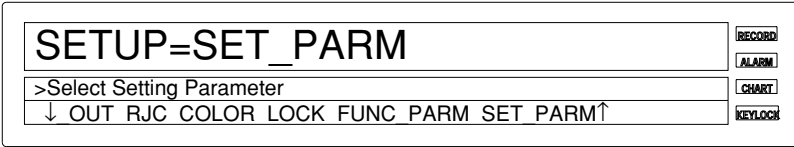

Operating Procedure

- Enter the SET UP menu in the following procedure:
 1. When the display presents the operation display mode or a menu other than the SET UP menu, first turn off the power switch.
 2. Turn the switch back on while pressing the DISP key and continue pressing the DISP key for about 5 seconds.
- Select/set using the keys.
- To escape from a lower menu, press the MODE (ESC) key. Its main menu will appear, although new settings/selections will not be kept.
- New settings/selections will be kept when you reach the final display of that setting.

(Main menu)

SET UP=

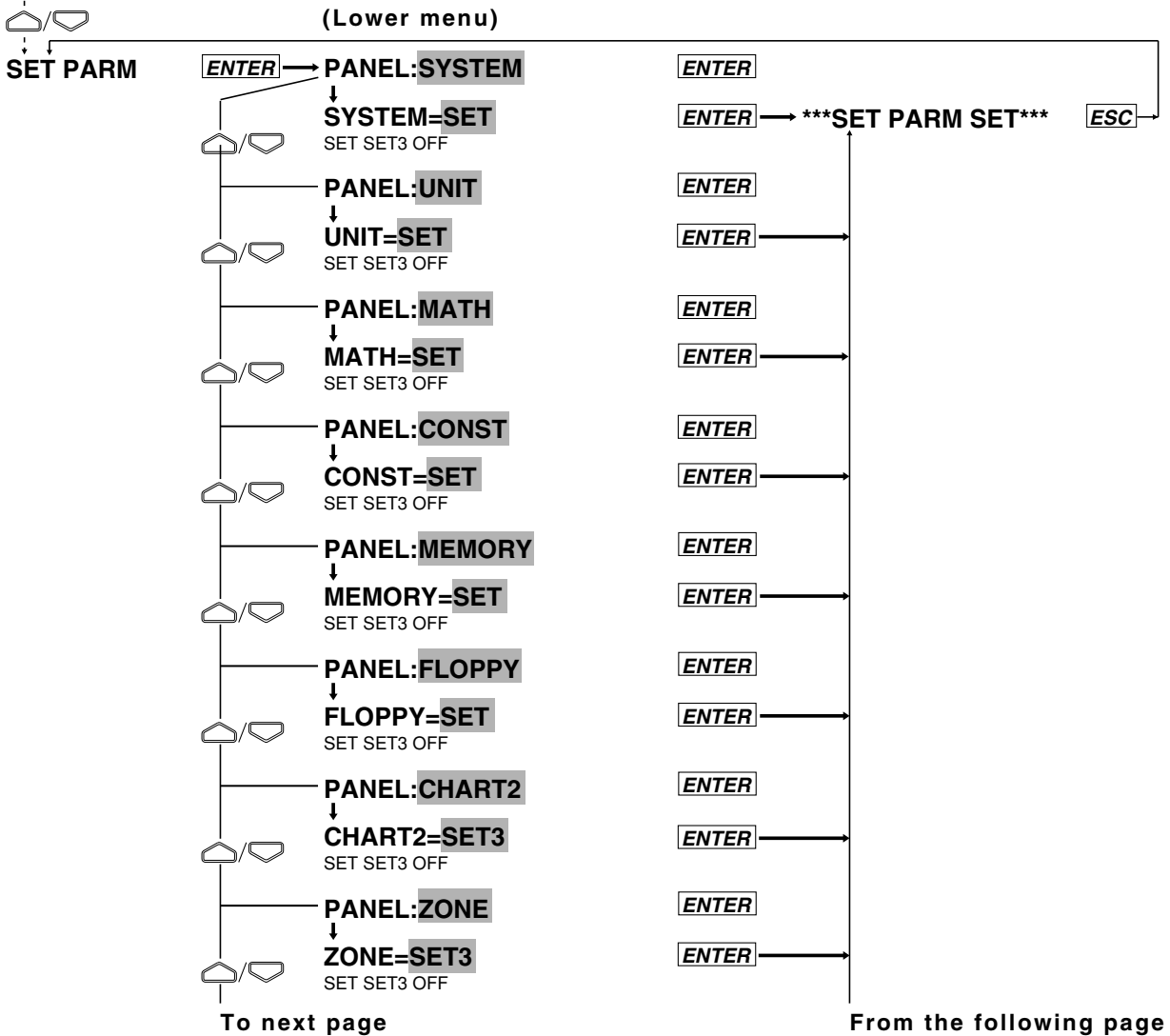

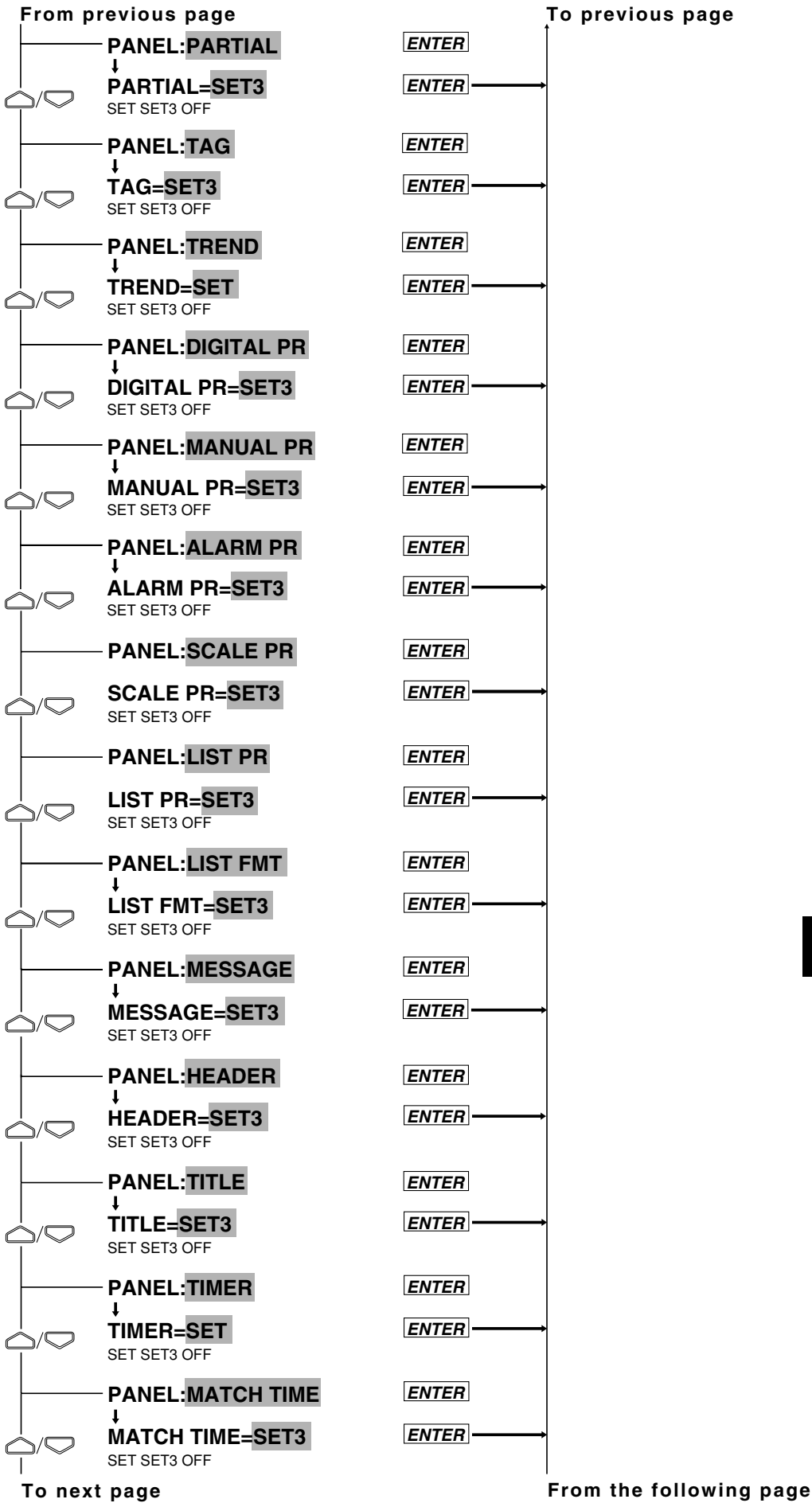

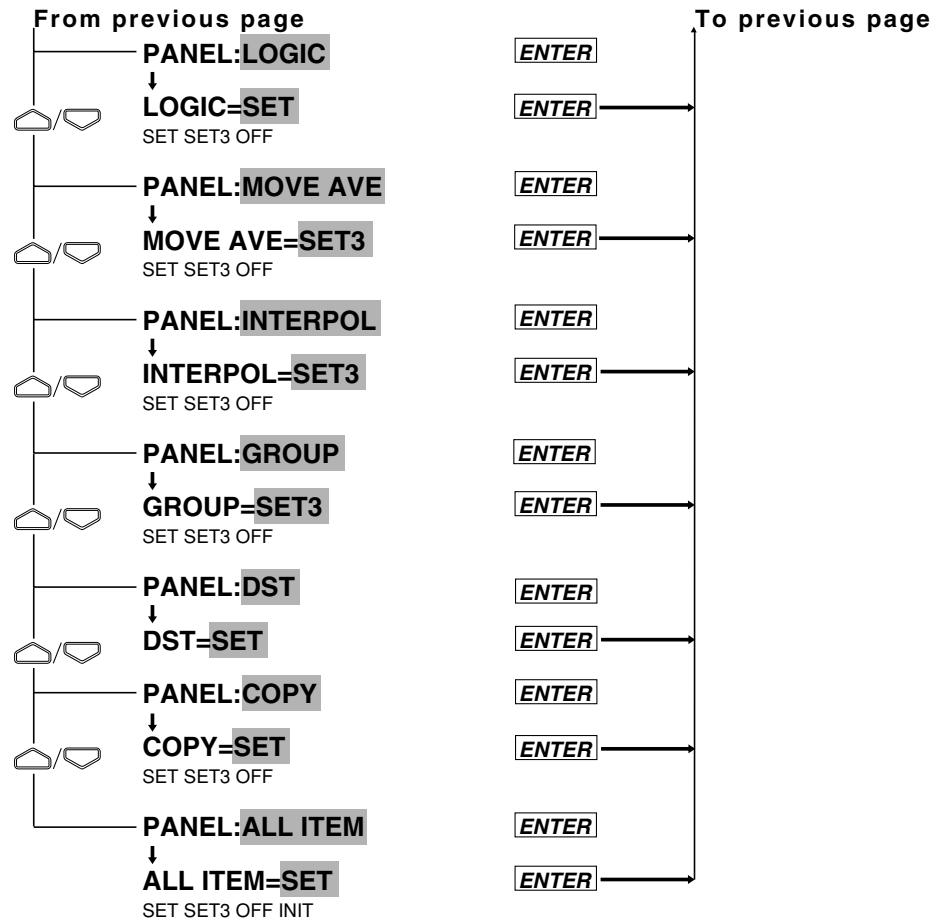

Explanation**Setting SET/SET3 (SET PARM)**

Select the menu to be displayed by pressing the SET key whether in the SET menu or the SET3 menu. The SET menu is displayed by pressing the SET key at a touch and the SET3 menu is displayed by pressing the SET key for about 3 seconds continuously.

- Select any of the following:
 - SET: displayed in the SET menu.
 - SET3: displayed in the SET3 menu.
 - OFF: not displayed in either menu.
- The default setting is as shown in the operating procedure diagram on pages 10-20 and 10-21.
- The last operation menu, "PANEL:ALL ITEM," is the menu that globally set all menus. However, the selection of "INIT" selects the default setting.

Note

- In order to make the set or selected contents effective, the contents must be registered. For details, see page 10-24.
- To return from the SET UP menu to the operation display mode, select END in the main menu. For details, see page 10-24

10.10 Selecting Display Update Interval, Registering SET UP Menu, and Terminating SET UP Menu

Relevant Keys

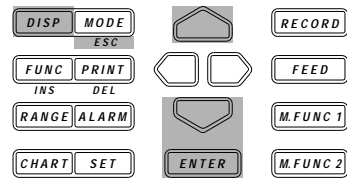
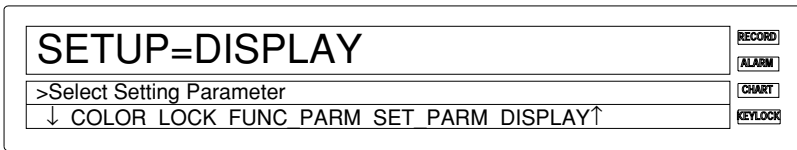

Operating Procedure

- Enter the SET UP menu in the following procedure:
 1. When the display presents the operation display mode or a menu other than the SET UP menu, first turn off the power switch.
 2. Turn the switch back on while pressing the DISP key and continue pressing the DISP key for about 5 seconds.
- Select/set using the keys.
- To escape from a lower menu, press the MODE (ESC) key. Its main menu will appear, although new settings/selections will not be kept.
- New settings/selections will be kept when you reach the final display of that setting.

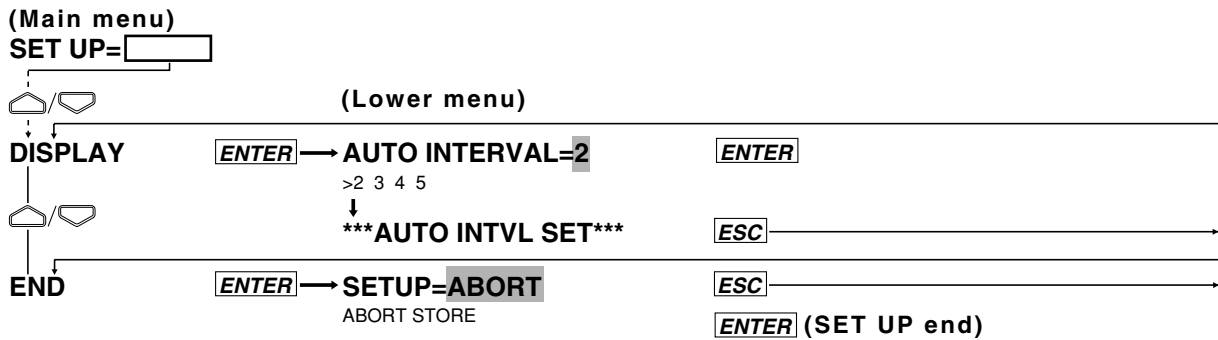

Explanation

Selection of Display Update Period (DISPLAY)

Select the display update interval when the operation display mode in the display is AUTO.

- Select 2, 3, 4, or 5 seconds.
- The default setting is 2 seconds.

Registration/Abortion of Setting/Selection Details and Termination of SET UP menu (END)

In order to make the details set/selected in the SET UP menu effective, a registering operation is necessary. In contrast, the status can also be brought to that before setting/selection (abort) without registration. Terminate the SET UP menu after registering or aborting operation.

- ABORT: Registration is aborted and the SET UP menu is terminated.
- STORE: After registration, the SET UP menu is terminated.
- The default setting is ABORT.

Select the END menu, then press the ENTER key.

The operation display mode is reached about 10 seconds after pressing the ENTER key.

10.11 Selecting the temperature unit from °C or °F (option)

Relevant Keys

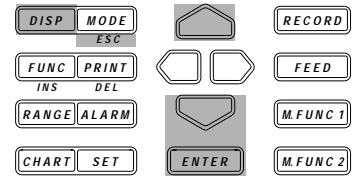
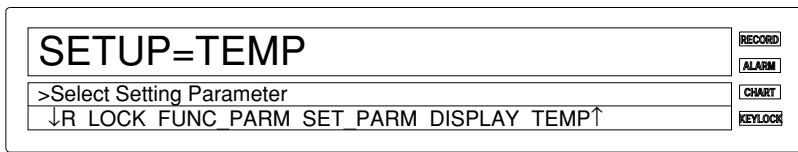

Operating Procedure

- Enter the SET UP menu in the following procedure:
 1. When the display presents the operation display mode or a menu other than the SET UP menu, first turn off the power switch.
 2. Turn the switch back on while pressing the DISP key and continue pressing the DISP key for about 5 seconds.
- Select/set using the keys.
- To escape from a lower menu, press the MODE (ESC) key. The main menu will appear, although new settings/selections will not be kept.
- New settings/selections will be saved when you reach the final display of that setting.

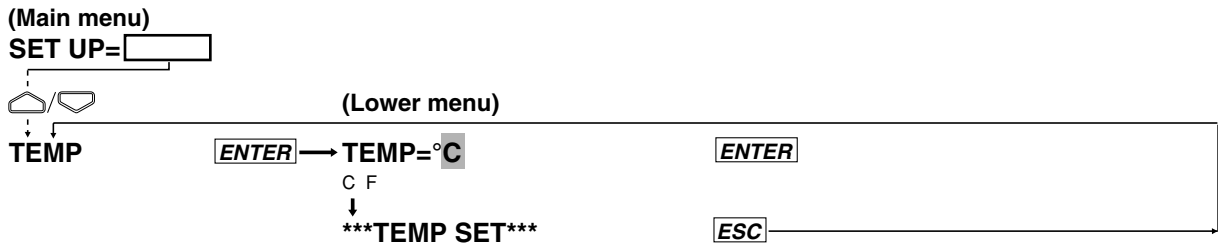

Selecting the temperature unit (TEMP)

The temperature unit can be selected from the following;

- °C which is the initial value, or
- °F

Note

- In the User's manual all functions and operations are explained using the °C unit. When using the °F unit, replace the °C unit with the °F unit. For the measurement range/measurement accuracy and maximum resolution in case of using the °F range, refer to the following table as a replacement of the one on page 14-2.
- Measurement range: Refer to the following table;
- Measurement accuracy/maximum resolution: Replace the values using the following formula
 $^{\circ}\text{F} = (^{\circ}\text{C value} \times 9/5) + 32$
- When changing the temperature unit as described above, other settings will be initialized at the same time and therefore, all settings need to be done again. This initialization will be the same initialization as described on page 9-17.
- In order to make the set or selected contents effective, the contents must be registered. For details, see page 10-24.
- To return from the SET UP menu to the operation display mode, select END in the main menu. For details, see page 10-24.

Measurement ranges for temperature measurements when using the unit °F

Input	Type	Measurement Range
TC (Note that accuracy of reference junction compensation is not considered.)	R *1	32 to 3200°F
	S *1	32 to 3200°F
	B *1	32 to 3308°F
	K *1	-328 to 2498°F
	E *1	-328.0 to 1472.0°F
	J *1	-328.0 to 2012.0°F
	T *1	-328.0 to 752.0°F
	L *2	-328.0 to 1652.0°F
	U *2	-328.0 to 752.0°F
	N *3	32 to 2372°F
	W *4	32 to 4199°F
RTD	KPvsAu7Fe	0.0 to 300.0K
	Pt100(1mA) *5	-328.0 to 1112.0°F
	Pt100(2mA) *5	-328.0 to 482.0°F
	JPt100(1mA) *5	-328.0 to 1022.0°F
	JPt100(2mA) *5	-328.0 to 482.0°F
	Pt50(2mA) *5	-328.0 to 1022.0°F
	Ni100(1mA) *6	-328.0 to 482.0°F
	SAMA	
	Ni100(1mA)DIN *6	-76.0 to 356.0°F
	Ni120(1mA) *7	-94.0 to 392.0°F
	J263*B	0.0 to 300.0K
	Cu10 GE *8	-328.0 to 572.0°F
	Cu10 L&N *8	
Cu10 WEED *8		
Cu10 BAILEY *8		
High resolution RTD	Pt100(1mA) *5	-220.0 to 302.0°F
	Pt100(2mA) *5	-94.0 to 158.0°F
	JPt100(1mA) *5	-220.0 to 302.0°F
	JPt100(2mA) *5	-94.0 to 158.0°F

*1 :R, S, B, K, E, J, T :ANSI, IEC 584, DIN IEC 584, JIS C 1602-1981

*2 :L :Fe-CuNi, DIN43710, U :Cu-CuNi, DIN 43710

*3 :N :Nicrosil-Nisil, IEC 584, DIN IEC 584

*4 :W :W.5%RE-W.26%Re (Hoskins Mfg Co)

*5 :Pt50 :JIS C 1604-1981, JIS C 1606-1986

Pt100 :JIS C 1604-1989, JIS C 1606-1989, IEC 751, DIN IEC 751

JPt100 :JIS C 1604-1981, JIS C 1606-1989

*6 :SAMA/DIN

*7 :McGRAW EDISON COMPANY

*8 :Ranges to which accuracy applies :

Cu10 GE :-119.9 to 338.0°F, Cu10 L&N :-103.0 to 302.0°F,

Cu10 WEED :-4.0 to 482.0°F, Cu10 BAILEY :-4.0 to 482.0°F

10.12 Working with the Report Function

Relevant Keys

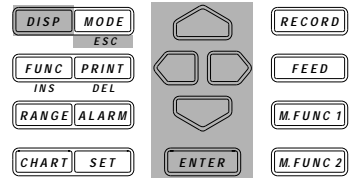
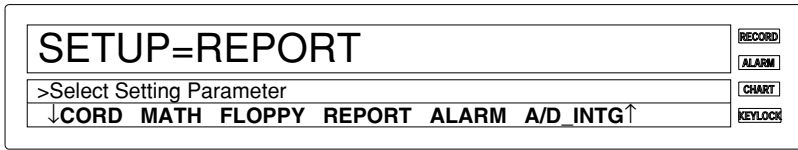

Operating Procedure

- To enter the SETUP menu, follow the steps below:
 - If the DR recorder is in the OPERATION/DISPLAY mode or shows a menu other than the SETUP menu, turn off the power switch once.
 - Turn on the power switch while pressing down the DISP key, and then keep holding the key down for approximately five seconds.
- Using and , select and/or enter a value for each of the shaded fields shown below.
- To exit any of the following menu items during the procedure, press the MODE (ESC) key. This returns to the first item of the menu. Note however that your new settings and selections are canceled.
- Reaching the step showing the message “***REPORT SET***” or “***REPORT CH SET***” confirms the latest settings/selections.

Sending the Instantaneous Value and Average to a Report Output

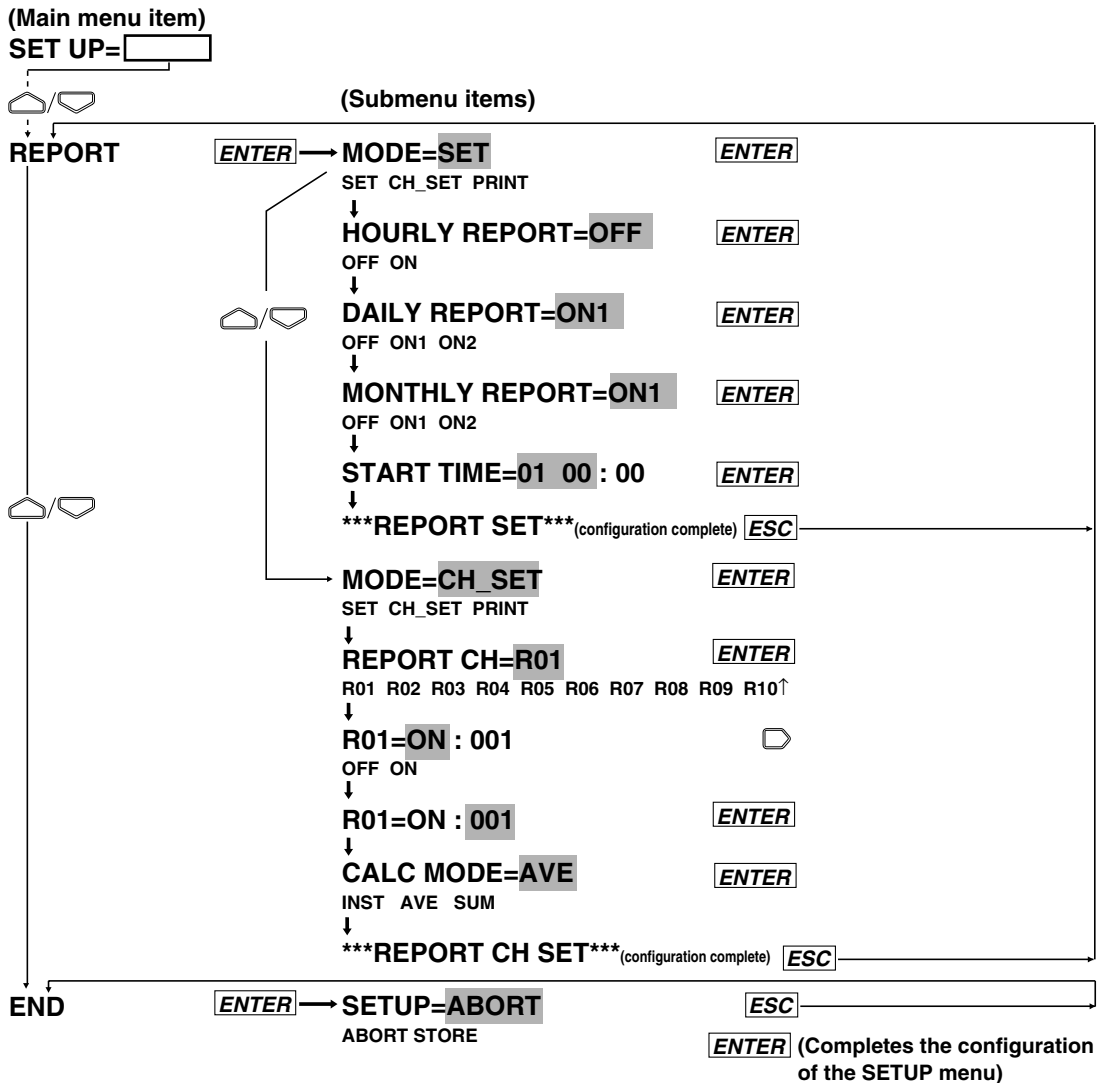

Sending the Sum to a Report Output

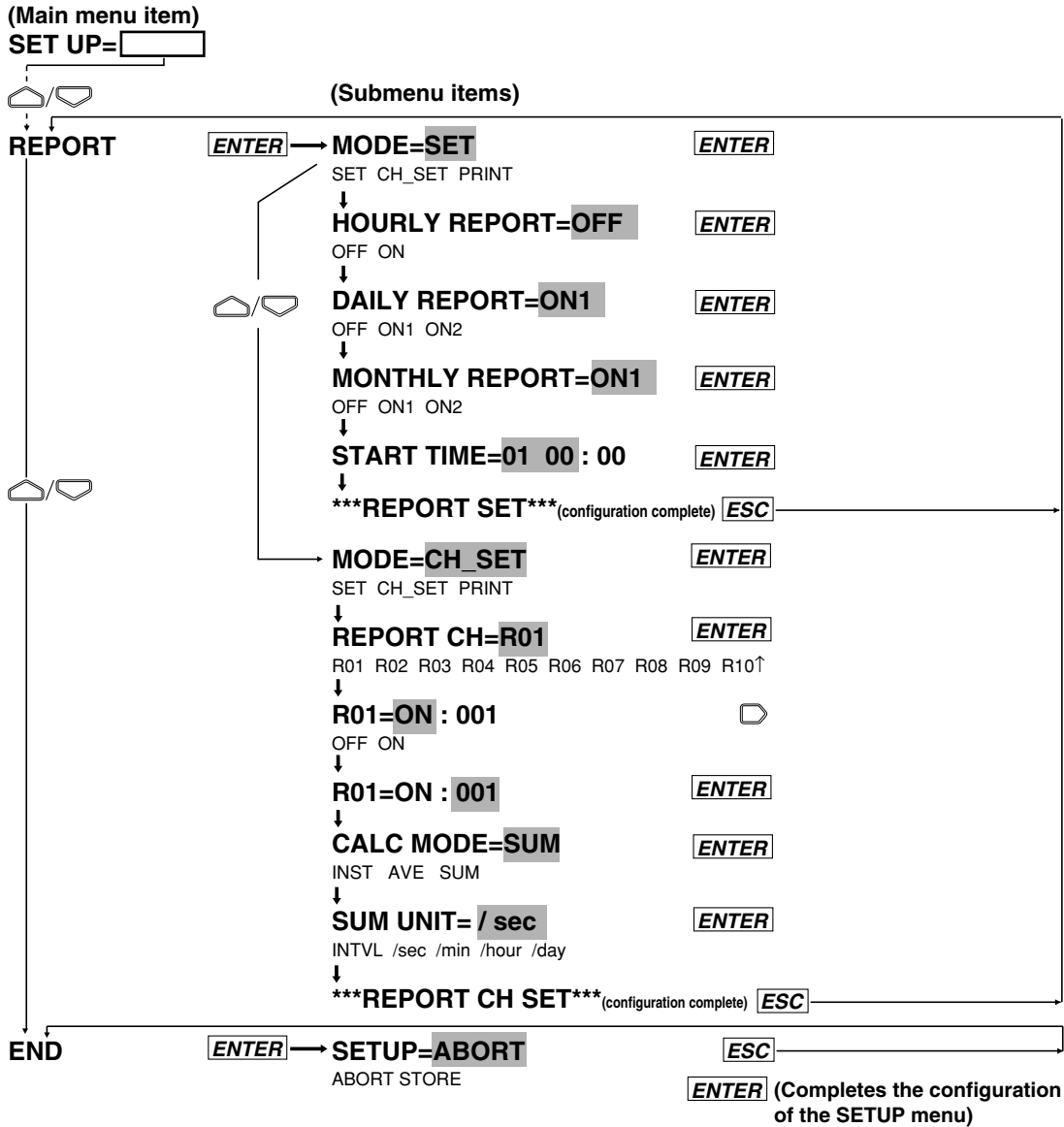

Printing Reports

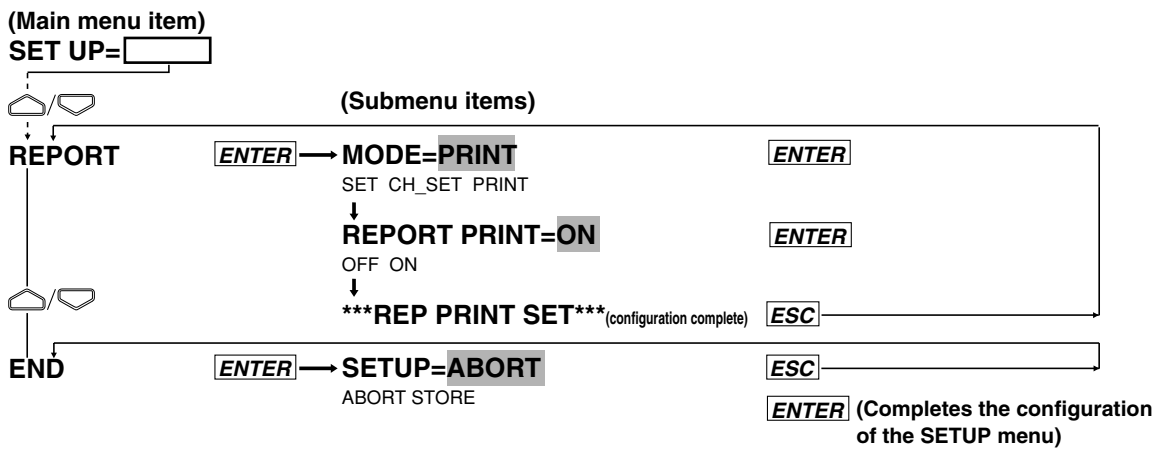

Explanation

The DR recorder calculates and processes an hour's, day's or month's worth of measurement or computation data into instantaneous values, averages and/or sums to print the results in a predetermined format at a preset time. The results can be delivered using the communication function or printed on a recording chart. For more information on output using the communication function, see the separate DR130/DR231/DR232/DR241/DR242 Communication Interface User's Manual (IM DR231-11E).

You select from the choices in the FUNC menu, which opens when you press the FUNC key, to start/stop report making or print reports. You can also start/stop report making using the event/action functions. Reports come in the following three types.

Type	Intervals Between Making Reports	Data Item for Computing
Hourly report	Every hour (1:00, 2:00 . . . , 23:00, 24:00)	An hour's average, maximum and minimum An hour's sum and cumulative sum Instantaneous value at the time of making the report
Daily report	Every other day (preset time)	A day's average, maximum and minimum A day's sum and cumulative sum Instantaneous value at the time of making the report
Monthly report	Every other month (preset time)	A month's average, maximum and minimum A month's sum and cumulative sum Instantaneous value at the time of making the report

On/Off of Hourly, Daily and Monthly Report Making

Configure the on's and off's of hourly, daily and monthly report making, separately. You can set hourly, daily and monthly report making all to "on" at the same time. In addition, you can set daily and monthly reports to either the standard format (ON1) or the enhanced format (ON2) of output. Note that the enhanced format can only be set for either daily reports or monthly reports.

Output Formats

The format of output is available in either the standard or enhanced format. Hourly reports can have the standard format only.

Standard format: Prints the results of computing configured on a report-channel basis.

Enhanced format:

Daily reports: the results of computing configured on a report-channel basis plus information on the result of computing given at each preset time.

Monthly reports: the results of computing configured on a report-channel basis plus information on the result of computing given simultaneously with the preset time for making each report

The following shows the format of daily reports:

	Time to make report	Starting time							
DAILY REPORT	Jan.03.97 00:00	(START=Jan.01.97 00:00)							
RCH CH/TAG	MODE UNIT	Jan.03 00:00	MIN/TOTAL	MAX	Jan.02 01:00	Jan.02 02:00 . . .	Jan.03 00:00		
R01 TAG-001CH	AVE V	-1.0000	-2.0000	1.0000	-2.0000	-2.0000	-2.0000		
R02 002	INST V	10.000			9.000	9.000	10.000		
R03 003	SUM L	2.400000E+01	4.800000E+01		1.000000E+0	1.000000E+00	1.000000E+00		
R04									
R05									
R06 TAG-A01CH	AVE unit06	20000.000	10000.000	30000.000	10000.000	10000.000	10000.000		
R07 A02	INST	200000.00			9999.99	9999.99	200000.00		
R08 A03	SUM	2.400000E+01	4.800000E+01		1.000000E+0	1.000000E+00	1.000000E+00		
R09									
R10									
:									
R60									

**Standard-format section of report
(results of computing on a report-channel basis)**

**Enhanced-format section of report
(list of the result of computing at
respective preset times)**

Time to Make Report (START TIME)

Set the time to make a report in the format day of month : time. Define the day of month field within a 01-28 range and the time field within a 00-23 range.

Hourly reports:

The DR recorder makes reports every hour on the hour (1:00, 2:00, . . . , 23:00, 24:00). For cumulative summation, it resets the cumulative sum at a preset time.

Daily reports:

The DR recorder makes reports at a preset time or times. For cumulative summation, it resets the cumulative sum at the preset time of a day.

Monthly reports:

The DR recorder makes reports at a preset time of the day.

Report Channels

There are sixty report channels, from R01 to R60 (DR231/DR241) or thirty report channels, from R01 to R30 (DR130). You can assign channels for measuring objects being computed or computation channels and the type of computing on a report-channel basis. When making a report of computed data, let computing start before letting the report making start.

Types of Computing

Menu Item	Data Item for Computing
INST	Instantaneous value at the time of making report
AVE	Average, maximum and minimum over the computing period
SUM	Sum and cumulative sum over the computing period

Sum and Cumulative Sum

Sum: The total sum over an hour for hourly reports, the sum over a day for daily reports or the sum over a month for monthly reports. The DR recorder resets this value each time it makes any of these reports.

Cumulative sum: The total sum up to the preset time to make a report in the case of hourly reports or the sum up to a preset time of the day to make a report in the case of daily reports. The DR recorder resets this value at each preset time or at each preset time of the day for report making. The DR recorder does not perform cumulative summation for monthly reports.

As an example, the following illustrates the process of summation and cumulative summation for hourly reports. The example shows the case where the preset time to make a report is 8:00.

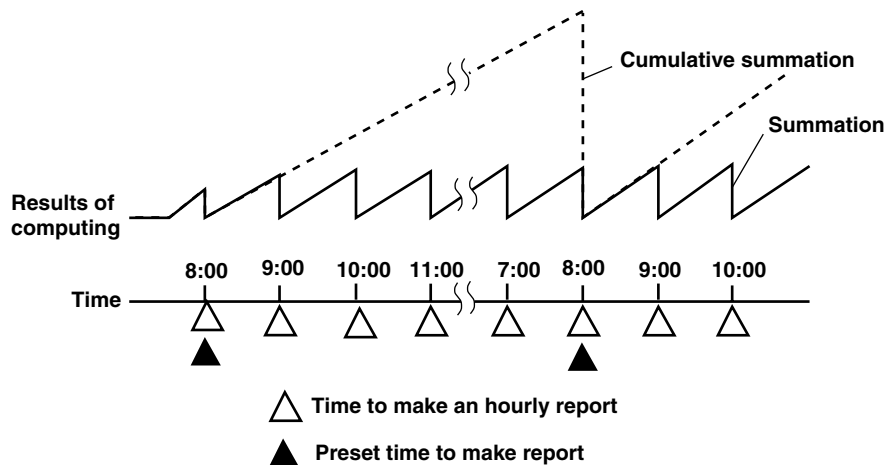

Unit of Summation (SUM UNIT)

Such input data items as the flowrate that have a unit in /sec, /min, /hour or /day, when simply summed, give results of computing different from their actual values. This occurs because the unit of such a data item differs from that of the measurement interval. In that case, you can take the output after having converted the unit of summation so it matches that of the input data item applied.

Unit of Input (Preset Unit)	Conversion Formula
INTVL (no conversion)	\sum (measured data values)
/sec	\sum (measured data values) \times measurement interval
/min	\sum (measured data values) \times measurement interval/60
/hour	\sum (measured data values) \times measurement interval/3600
/day	\sum (measured data values) \times measurement interval/86400

Printing Reports on a Recording Chart

You can print created reports on a recording chart. If you set the REPORT PRINT menu item to on during the configuration of the report function, the DR recorder starts printing automatically at the same time it finishes making a report. You can also print reports by pressing the FUNC key, opening the FUNC menu and then selecting the REP RECALL START menu item. In that case, take note of the following:

- You can print the latest report only, irrespective of whether it is an hourly, daily or monthly report. Neither daily nor monthly reports are printed if you print immediately after an hourly report was created.
- Care must be taken when the REPORT PRINT menu item is set to automatic printing. If the time for automatic printing arrives while printing is enabled from the FUNC menu, the DR recorder will no longer print reports automatically.
- Even if you have configured the DR recorder so it prints a daily report in the enhanced format, it prints the report in the standard format if it has been more than an hour since the report was created.
- Even if you have configured the DR recorder so it prints a monthly report in the enhanced format, it prints the report in the standard format if it has been more than a day since the report was created.

To stop printing, press the FUNC key and select REP PRINT STOP from the FUNC menu. The following are examples of how a daily report prints.

Standard format:

		Time to make report		Starting time			
DAILY REPORT Jan.03.97 00:00 (START=Jan.01.97 00:00)							
RCH	CH/TAG	MODE	UNIT	Jan.03 00:00	MIN/TOTAL	MAX	
R01	TAG-001CH	AVE	V	-1.0000	-2.0000	1.0000	
R02	002	INST	V	10.000			
R03	003	SUM	L	2.400000E+01	4.800000E+01		
R04							
R05							
R06	TAG-A01CH	AVE	unit06	20000.000	10000.000	30000.000	
R07	A02	INST		200000.00			
R08	A03	SUM		2.400000E+01	4.800000E+01		
R09							
R10							
:							
R60	Channels included in printing (Axx: computing channel)		Types of computing	Units	Results of computing	Minimum or cumulative sum	Maximum

Report channels

Enhanced format:

		Time to make report		Starting time			
DAILY REPORT Jan.03.97 00:00 (START=Jan.01.97 00:00)							
RCH	CH/TAG	MODE	UNIT	Jan.03 00:00	MIN/TOTAL	MAX	
R01	TAG-001CH	AVE	V	-1.0000	-2.0000	1.0000	
R02	002	INST	V	10.000			
R03	003	SUM	L	2.400000E+01	4.800000E+01		
R04							
R05							
R06	TAG-A01CH	AVE	unit06	20000.000	10000.000	30000.000	
R07	A02	INST		200000.00			
R08	A03	SUM		2.400000E+01	4.800000E+01		
R09							
R10							
:							
R60	Channels included in printing (Axx: computing channel)		Types of computing	Units	Results of computing	Minimum or cumulative sum	Maximum
Enhanced-format section of report (list of the result of computing at respective preset times for daily reports)							

Report channels

Note

- If any of the following conditions is true, you cannot print reports even when the preset time to make a report arrives. In that case, the DR recorder prints reports when the current printing ends.
 - Manual printing is in progress.
 - List printing or setup list printing is in progress.
 - Header printing is in progress.
 - Logging printing is in progress.
- The DR recorder does not print reports either even if the preset time to make a report arrives while printing is enabled from the FUNC menu.

Starting/Stopping Report Making

Report making can be started or stopped in two ways:

- Press the FUNC key and select REPORT_START or REPORT_STOP from the FUNC menu.
- Use the event/action functions to define the start/stop of making a report for the following events:
 - Edge action: You can define every event as an edge action to start/stop report making.
 - Level action: You can use remote, alarm, relay and end-of-chart signals as events to start/stop report making. Report making starts at the same time that any of these events occur. Report making stops when the event clears.

Note

- If you start report making, all reports created up to that point are reset.
- When report making is in progress, you cannot make changes to measurement channels, measuring ranges or dates and times nor can you copy information on the ranges.
- If any computed data are included in your report making, let computing start first and then get report making started. If you fail to enable computing, the data in your reports will become meaningless because no change takes place on the computed data.
- If you want the start of computing and report making enabled at the same time, use the event/action functions to assign both of these instructions to the same event as actions.

Time Relationship Between the Settings of the REPORT_START/STOP Menu Items and Report Making

The following figure shows the time relationship between the settings of the REPORT_START/STOP menu items and report making.

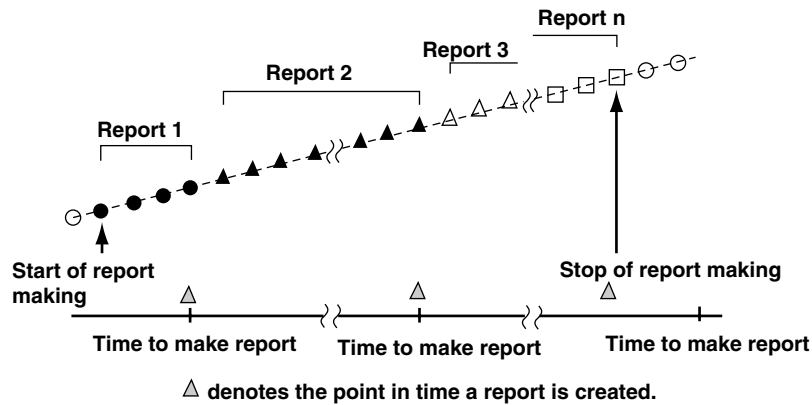

- Data items included in the first round of report making after the start of report making are fewer in number than those included in the second and subsequent rounds of report making.
- The DR recorder samples data before stopping report making. The report created when the DR recorder stops making reports thus includes those data.
- If the time when report making is started coincides with the time the report is created, the start of report making precedes. Thus, no report is created.
- The data sampled at the same time report making started are included in first round of report making. The report created when the DR recorder stops making reports thus includes those data.
- If you have defined timer and match-time signals as events using the event/action functions so the time report making starts matches the time the report is created, data items included in the first round of report making are one data item greater in number than those included in the second or any subsequent round of report making.

Processing Against Absence of Measurement

Measurement may not take place if the DR recorder is loaded beyond its processing capability. If absence of measurement occurs, the DR recorder compensates for the missing data with the data it measures immediately after recovering from the absence of measurement (the data for the period with no measurement thus match those acquired immediately after recovering from the absence of measurement).

If Power Failure Occurs While Report Function Is Active

The DR recorder takes different actions depending on the length of a power failure.

If the power failure time is longer than 12 hours:

The DR recorder makes a report immediately after it recovers from the power failure and then stops making reports. It does not execute printing based on the settings for automatic printing. Print out reports either using the communication function or from the FUNC menu.

Results of computing: The DR recorder computes data measured up to the point immediately before the power failure.

Time of report making: The time when the power failure occurred.

If the power failure is less than 12 hours:

The DR recorder takes different actions depending on the time it recovers from the power failure.

Time of Recovery from Power Failure	After the Time of Report Making	Before the Time of Report Making
Condition after recovery from power failure	Valid report function (start of report making enabled)	Valid report function (start of report making enabled)
Report making	Immediately after recovery from power failure	Time for report making
Report printing	Immediately after recovery from power failure	Time for report making
Data included in report making	Data measured up to the point of power failure	Data measured over the given period except the power failure time

If automatic report printing is turned on:

If the power failure time covers the given period of report making, no report for that period is made.

Handling of Faulty Data

If data being computed contain any faulty data, the DR recorder treats the data as summarized in the following table, depending on the type of computing and faulty data.

Type of Faulty Data	Average	Minimum/Maximum	Instantaneous Value	Sum
Positive overflow	Excluded from computing	Included in computing	Takes faulty data as the result of computing	Excluded from computing
Negative overflow	Excluded from computing	Included in computing	Takes faulty data as the result of computing	Excluded from computing
Channels included in measurement set to SKIP	Excluded from computing	Excluded from computing	Takes faulty data as the result of computing	Excluded from computing
No channel included in measurement	Excluded from computing	Excluded from computing	Takes faulty data as the result of computing	Excluded from computing
Error	Excluded from computing	Excluded from computing	Takes faulty data as the result of computing	Excluded from computing
Output of data disabled	Excluded from computing	Excluded from computing	Takes faulty data as the result of computing	Excluded from computing

The DR recorder prints the results of computing as shown in the following table if they are special data.

Type of Data	Printout Format
Positive overflow	+*****
Negative overflow	-*****
Channels included in measurement set to SKIP	Space
No channel included in measurement	Space
Error	xxxxxx
Output of data disabled	oooooo

If data being computed contain faulty data, the DR recorder prints each digital data item, beginning with an * or × as the status indication.

1. Power failure: ×

In the case of a power failure, the DR recorder prints the time for report making, also beginning with an ×.

2. Channels included in measurement set to SKIP/no channel included in measurement/error/output of disabled data: ×

3. Positive overflow/negative overflow: *

If more than one faulty data item occurs at the same time, the DR recorder prints them while giving priority to a data item with a smaller number among the numbers noted above.

Notes on daylight savings time

When the function to shift the time scale between standard time and daylight savings time is specified, the report for the day to shift from standard time to the daylight savings time seemingly includes data for only a 23-hour day and, at the same time, the report for the day to shift daylight savings time to standard time seemingly includes the data for a 25 hour day.

If you specify the time to make a report at the same time as the shift from standard time to daylight savings time, or vice versa, the report will be generated based on the time scale after the shift.

11.1 Saving Measured and Computed Data

Procedure for Saving Data

When saving measured/computed data on a floppy disk, save them first on the DR recorder's built-in RAM disk and then copy them to the floppy disk. You can save the data on the built-in RAM disk in three ways, as summarized in the following table:

Menu Item	Method for Starting Saving	Number of Files Saved
DIRECT	Immediately starts saving when the setting is complete.	One
TRIGGER	Starts saving when an event occurs as set using the event/action functions.	One
REPEAT	Starts saving when an event occurs as set using the event/action functions.	More than one*

* The DR recorder continues to save an array of files of the specified size until the built-in RAM disk becomes full.

Flow of Operation

The following paragraphs show the flow operation for a case where a measured data file is saved using the occurrence of an alarm as a trigger.

1. Setting an Event/Action

Menu Item	Setting
LOGIC in SET menu	LOGIC BOX No. EVENT=ALARM ACT=EDGE/MEMORY : WR_TRIG

2. Selecting a Channel Whose Data Are Saved

Menu Item	Setting
MEMORY in SET menu	MEMORY=CH SET 001-01: CH SET=ON (Allowed to set the consecutive numbers of channels)

3. Selecting a Method and Condition for Saving

Menu Item	Setting
MEMORY in SET menu	MEMORY=WRITE WRITE=TRIGGER WRITE file= (File name: If new, press ENTER leaving the name blank.) WRITE SAMPLE= (Interval between file savings) WRITE LENGTH= (Size of file being saved) WRITE PRE TRIG= (Pre-trigger: not configurable if MEMORY=DIRECT)

4. Copying Files Saved on Built-in RAM Disk to Floppy Disk

Menu Item	Setting
MEMORY in SET menu	MEMORY=COPY COPY MODE=TO FDD COPY TYPE=DATA COPY FILE= (Name of file being copied) COPY CONVERT=OFF (Saved as binary-data file)

See the following pages for more information on how to configure these menu items.

Relevant Keys

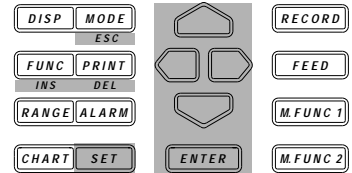
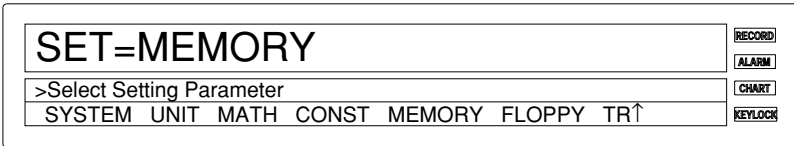

Operating Procedure

- Press the SET key to enter the SET menu.
- Select/set using the keys.
- To escape from a lower menu, press the MODE (ESC) key. Its main menu will appear, although new settings/selections will not be kept.
- New settings/selections will be kept when you reach the final display of that setting.

Selecting the channel to be saved

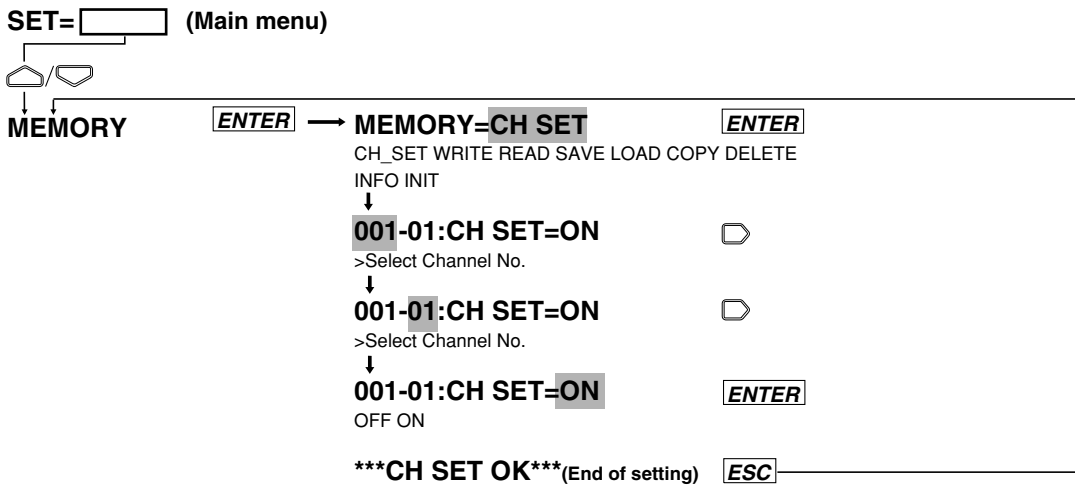

Saving immediately

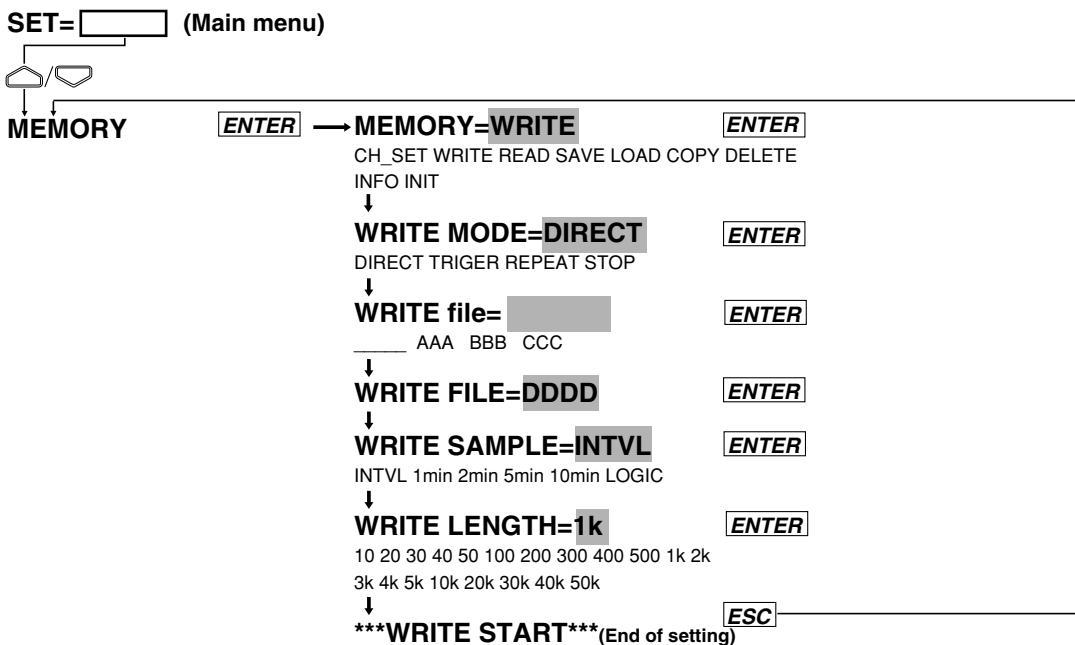

Saving one file only using the event/action function

The action in the event/action function must be configured as "MEMRY:WR_TRIG" before you can perform this task.

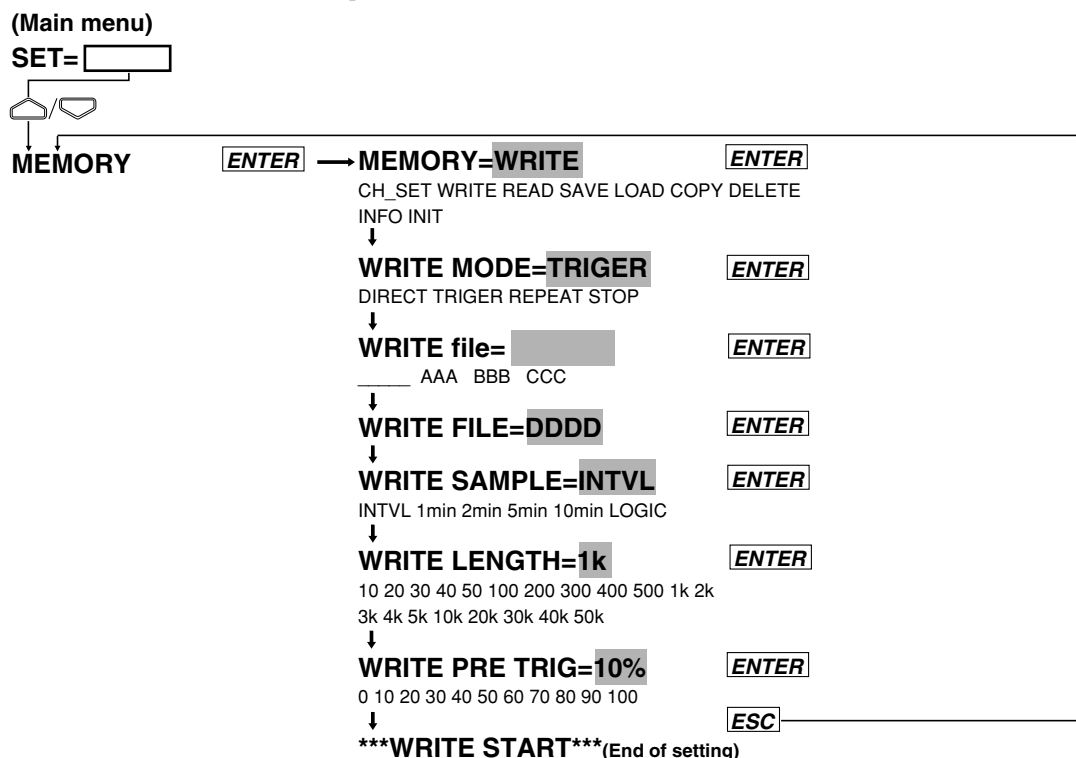

Saving files repeatedly using the event/action function

The action in the event/action function must be configured as "MEMRY:WR_TRIG" before you can perform this task.

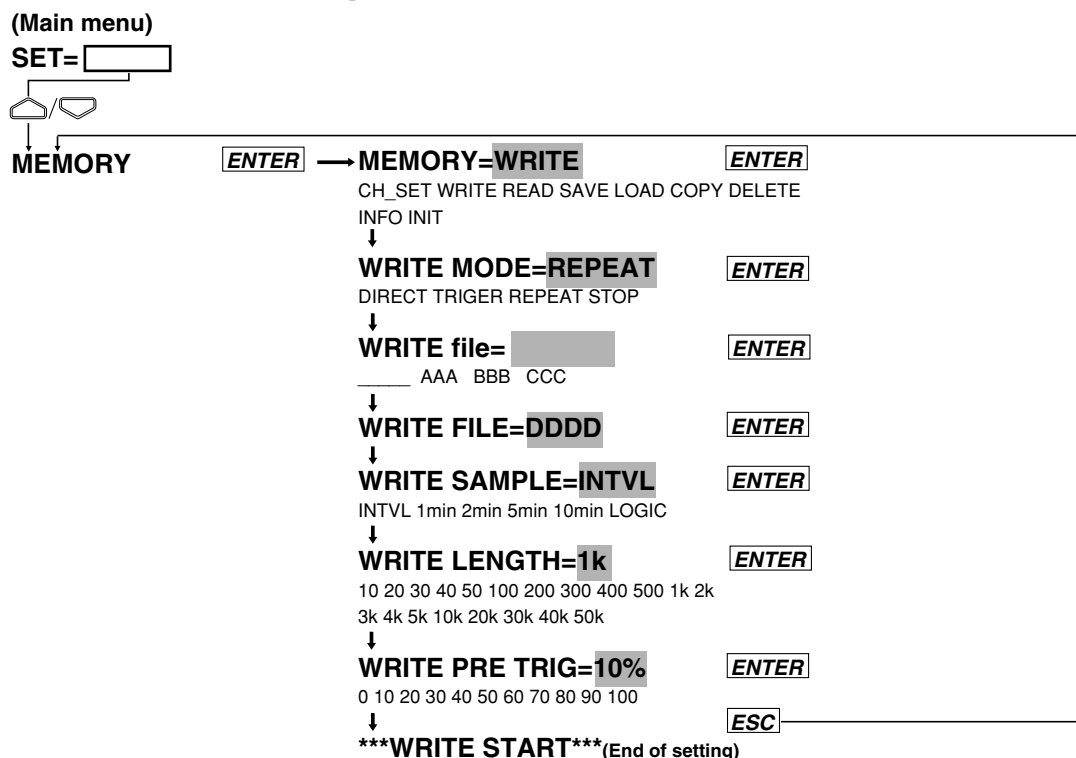

Stopping saving

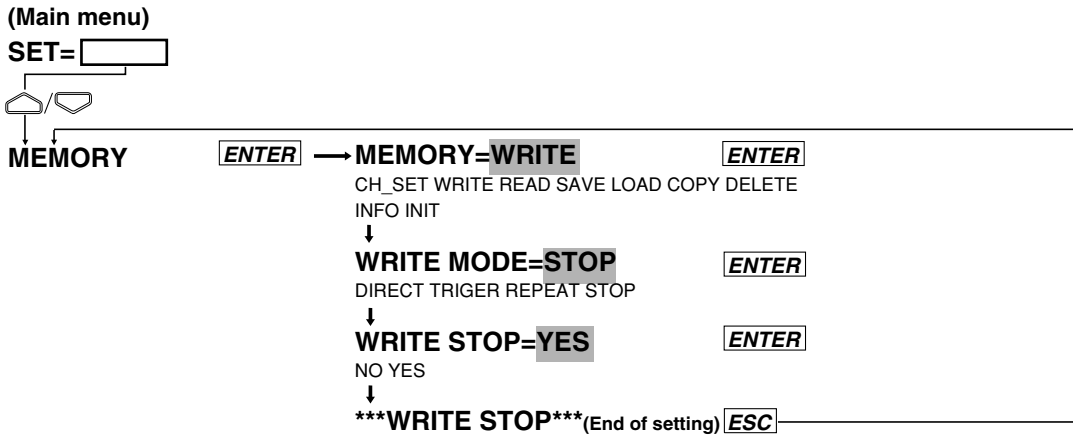

Example of configuration of event/action

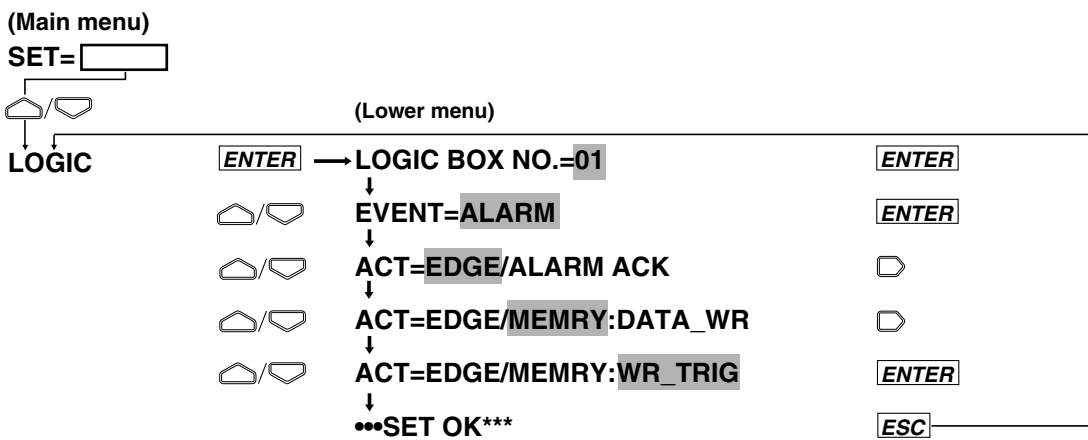

Explanation

Measured/computed data is saved to the internal RAM disk. The memory size of the RAM disk is 512 KB.

Saving method (WRITE MODE)

The following three methods are available.

- DIRECT
Measured/computed data is saved immediately after setting has been completed. Saving is complete when data of the specified length has been saved.
- TRIGGER
The event/action function is used to save only one file of measured/computed data when an event takes place. This function is useful when you want to save measured/computed data in case of an alarm.
- REPEAT
Same as TRIGGER, except that measured/computed data is saved each time an event takes place, until the RAM disk is full or saving is stopped by the operator. Events which occur during saving will be ineffective.

When TRIGGER is selected as WRITE MODE:

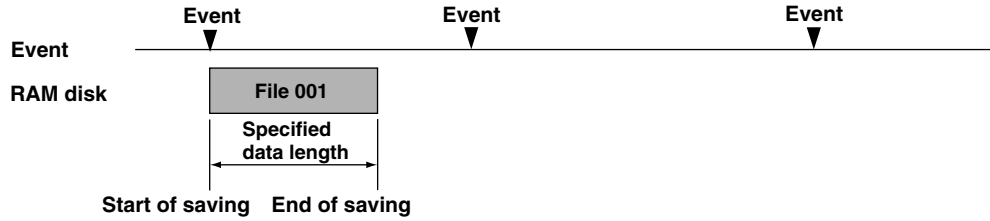

When REPEAT is selected as WRITE MODE:

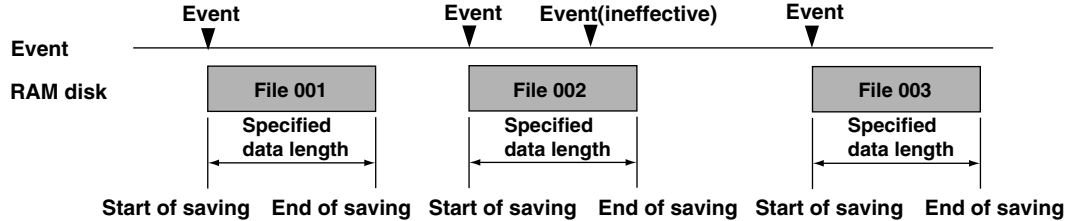

For TRIGGER or REPEAT, one event must be set for the WR TRIG action during event/action function setting. For a detailed description of the event/action function, refer to 9.1, “Setting Event/Action Functions” (page 9-1).

Data write interval (WRITE SAMPLE)

The data write interval at which data is saved can be selected from the following.

INTVL: Same as measurement interval. Every set of measured/computed data is saved.

1 min, 2 min, 5 min, 10 min: Saved at the specified interval.

LOGIC: One piece of data per channel is saved each time the event specified by DATA WR (event/action function) occurs. For a detailed description of the event/action function, refer to 9.1, “Setting Event/Action Functions” (page 9-1).

Data length (WRITE LENGTH)

Used to set the number of pieces of data per channel. Select one of the following options.

10, 20, 30, 40, 50, 100, 200, 300, 400, 500, 1k, 2k, 3k, 4k, 5k, 10k, 20k, 30k, 40k, 50k

Some options cannot be selected depending on the number of channels to be saved or the number of computation channels.

Pre-trigger (PRE TRIGGER)

If REPEAT or TRIGGER has been selected as WRITE MODE, data which occurs before the trigger (event) is activated can be saved within the specified data length. Set the trigger timing in units of percentage (%) of the specified data length in steps of 10%.

Data which occurs before the trigger

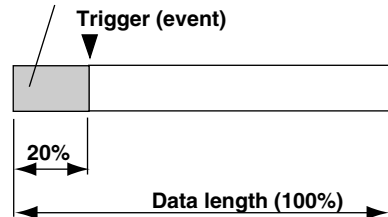

File name

If DIRECT or TRIGGER has been selected as WRITE MODE, the file name must consist of up to 8 characters.

If REPEAT has been selected as WRITE MODE, the file name must be of up to 5 characters in length. The lower 3 digits of the file name indicate the serial number (001 to 208). Characters that can be used with a file name are only those which you can choose on the display. No spaces are allowed. AUX, CON, PRN and CLOK cannot be used for a file name. The identifier is .DAT.

Data format

Measured/computed data is saved in binary format.

Data size

Data size can be calculated using the following equations.

Measured data: 2 bytes / 1 data

Computed data: 4 bytes / 1 data

Header: $576 + 64 \times (\text{number of measurement channels} + \text{number of computation channels})$ bytes

Data size = $576 + 64 \times (\text{number of measurement channels} + \text{number of computation channels}) + (\text{number of measurement channels} \times 2 + \text{number of computation channels} \times 4 + 6) \times \text{specified data length}$

For instance, if the number of channels is 10, number of computation channels is 5 and specified data length is 5k, the data size can be calculated as follows.

Data size = $576 + 64 \times (10 + 5) + ((10 \times 2 + 5 \times 4) + 6) \times 5k = 231,536$ bytes

Status display during saving

The following status symbols are displayed in the sub-display 2 (lowest display section).

M: Saving is in progress. **T**: Awaiting a trigger

Restrictions during saving

The following settings can not be made while saving is in progress.

- Settings relating to media, except for saving stop setting
- Measuring range
- Computation equation/constant
- Group
- Copying when range copying is "on"

11.2 Reading Measured and Computed Data

Relevant Keys

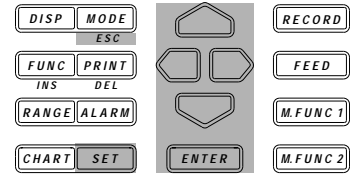
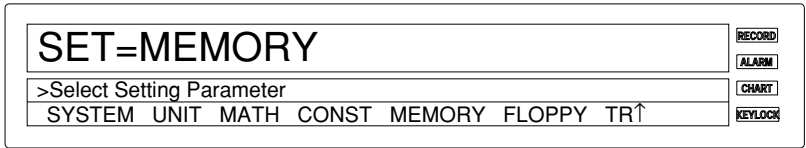

Operating Procedure

- Press the SET key to enter the SET menu.
- Select/set **█** using the keys.
- To escape from a lower menu, press the MODE (ESC) key. Its main menu will appear, although new settings/selections will not be kept.
- New settings/selections will be kept when you reach the final display of that setting.

Reading measured/computed data immediately from the RAM disk

(Main menu)

SET=

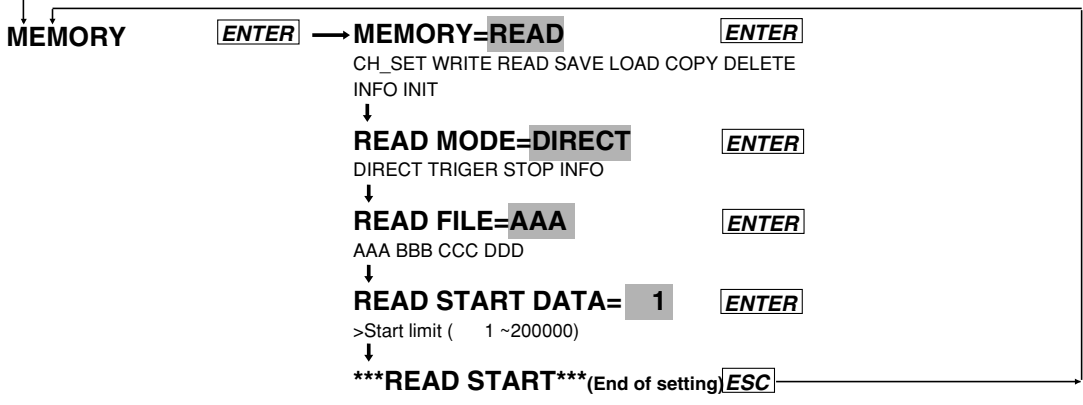

Reading measured/computed data from the RAM disk using the event/action function

(Main menu)

SET=

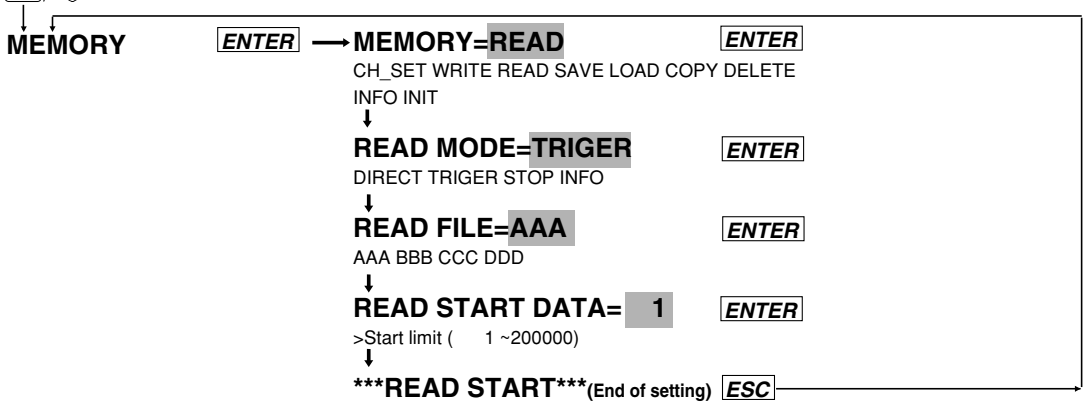

Reading data from a floppy disk

To read data from a floppy disk, it is necessary to copy the data from the floppy disk to the RAM disk. However, data in ASCII format cannot be read. See section 11.5, "Copying a Data File," for more information.

Status display during reading

The following status symbols are displayed in the sub-display 2 (lowest display section).

It is not possible to make media settings other than reading stop setting while measured/computed data is being read. See Section 11.5, "Copying a Data File," for more information.

M: Reading is in progress.

T: Awaiting a trigger

11.3 Saving Set-up Data

Saving set-up data for the SET mode

Relevant Keys

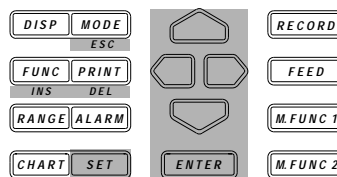
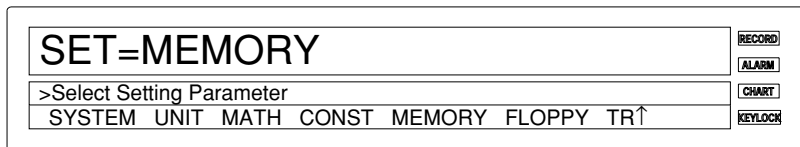

Operating Procedure

- Press the SET key to enter the SET menu.
- Select/set using the keys.
- To escape from a lower menu, press the MODE (ESC) key. Its main menu will appear, although new settings/selections will not be kept.
- New settings/selections will be kept when you reach the final display of that setting.

(Main menu)

SET=



MEMORY

ENTER

MEMORY=SAVE

ENTER

CH_SET WRITE READ SAVE LOAD COPY DELETE

INFO INIT

SAVE file=

ENTER

___ AAA BBB CCC

SAVE FILE=AAA

ENTER

Saving... *

SAVE OK (End of saving)

ESC

FLOPPY

ENTER

FLOPPY=SAVE

ENTER

SAVE LOAD DELETE INFO FORMAT

SAVE file=

ENTER

___ AAA BBB CCC

SAVE FILE=AAA

ENTER

Saving... *

SAVE OK (End of saving)

ESC

Saving set-up data for the SETUP mode

Relevant Keys

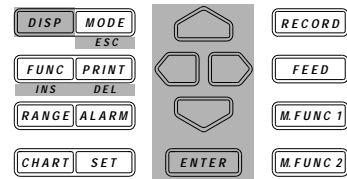
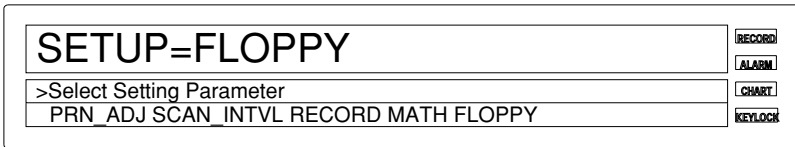

Operating Procedure

- Carry out the following steps to enter the SET UP menu.
 1. If the SET UP menu is not currently displayed, turn the power OFF
 2. While holding the DISP key, turn the power ON. Make sure depression of the DISP key is maintained for approximately another five seconds..
- Select/set using the keys.
- To escape from a lower menu, press the MODE (ESC) key. Its main menu will appear, although new settings/selections will not be kept.

(Main menu)

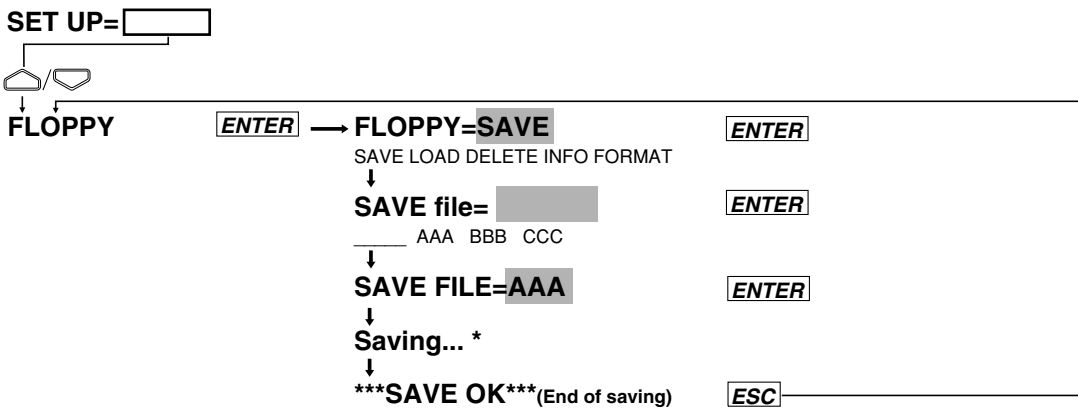

Explanation

Set-up data except for date/time is saved to the internal RAM disk or a floppy disk. Set-up data for the SETUP mode can be saved to a floppy disk only. Data is always saved in ASCII format. The file name must consist of up to 8 characters. The following identifier is used.
 Set-up data file for SET mode : .PNL
 Set-up data file for SETUP mode : .SET

Data size

- DR130
 - Set-up data for SET mode : up to approximately 42 KB (20 measurement channels and 30 computation channels)
 - Set-up data for SETUP mode : up to approximately 13 KB (20 measurement channels and 30 computation channels)
- DR230
 - Set-up data for SET mode : up to approximately 50 KB (30 measurement channels and 30 computation channels)
 - Set-up data for SETUP mode : up to approximately 15 KB (30 measurement channels and 30 computation channels)

Note

- "Saving ...*" will be displayed during saving. During this period, key board operations are not possible.
- No data saving is possible during computations.
- During saving, GP-IB/RS-232-C/RS-422-A/RS-485 communication remains inactive.

11.4 Reading Set-up Data

Reading set-up data for the SET mode

Relevant Keys

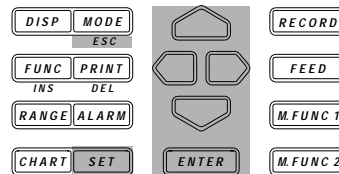
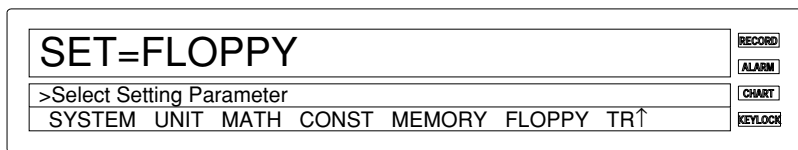

Operating Procedure

- Press the SET key to enter the SET menu.
- Select/set **MEMORY** using the keys.
- To escape from a lower menu, press the MODE (ESC) key. Its main menu will appear, although new settings/selections will not be kept.
- New settings/selections will be kept when you reach the final display of that setting.

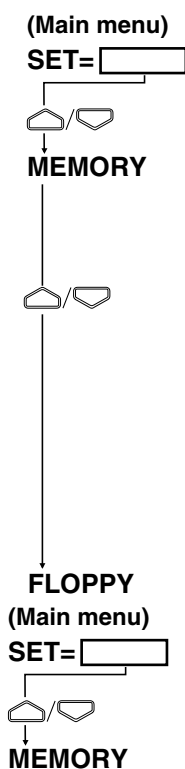

ENTER → **MEMORY=LOAD** **ENTER**
 CH_SET WRITE READ SAVE LOAD COPY DELETE
 INFO INIT
 ↓
LOAD MODE=DIRECT **ENTER**
 DIRECT TRIG_1 TRIG_2 TRIG_3
 ↓
LOAD FILE=AAA **ENTER**
 AAA BBB CCC
 ↓
Loading... *
 ↓
Operation status displayed

ENTER → **FLOPPY=LOAD** **ENTER**
 SAVE LOAD DELETE INFO FORMAT
 ↓
LOAD MODE=DIRECT **ENTER**
 DIRECT TRIG_1 TRIG_2 TRIG_3
 ↓
LOAD FILE=AAA **ENTER**
 AAA BBB CCC
 ↓
Loading... *
 ↓
Operation status displayed

Reading set-up data for the SETUP mode

Relevant Keys

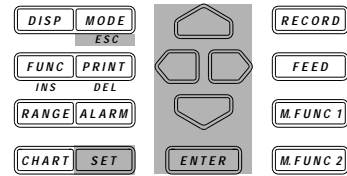
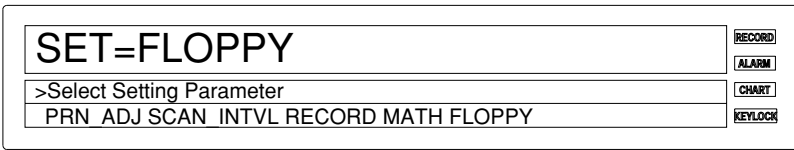

Operating Procedure

- Carry out the following steps to enter the SET UP menu.
 1. If the SET UP menu is not currently displayed, turn the power OFF
 2. While holding the DISP key, turn the power ON. Make sure depression of the DISP key is maintained for approximately another five seconds.
- Select/set **■** using the keys.
- To escape from a lower menu, press the MODE (ESC) key. Its main menu will appear, although new settings/selections will not be kept.

(Main menu)

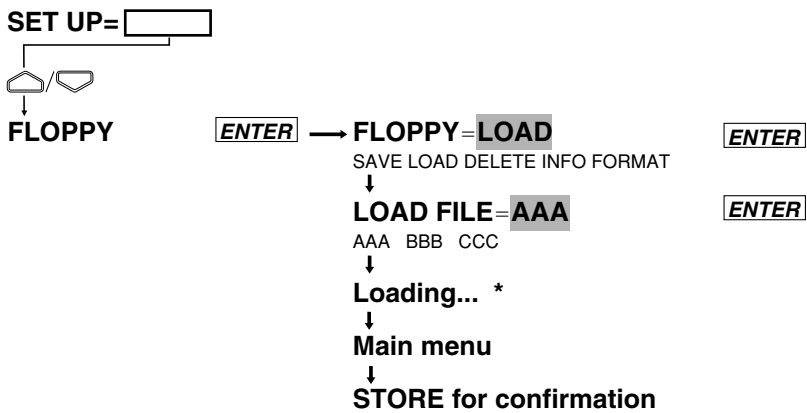

Explanation

Set-up data for the SET mode or SETUP mode is read from the internal RAM disk or a floppy disk.

Loading methods (LOAD MODE in SET mode)

The following two methods are available.

- **DIRECT**

Setup data is loaded immediately after setting has been completed.

- **TRIG 1/TRIG 2/TRIG 3**

The event/action function is used to load set-up data when an event takes place. This function is useful if you want to record data when an event takes place, with different recording spans.

One event must be set for the LD_TRG1, LD_TRG2 and LD_TRG3 actions during event/action function setting. For a detailed description of the event/action function, refer to 9.1, "Setting Event/Action Functions" (page 9-1).

Confirming the set-up data

To confirm the read set-up data for the SETUP mode, specify SETUP = STORE in the same way as the SETUP mode setting.

Note

- If set-up data saved on another instrument (DR series recorder) is loaded and does not match this instrument's configuration, settings which do not comply with the configuration cannot be made.
- No file reading is possible during computations.
- During reading, GP-IB/RS-232-C/RS-422-A/RS-485 communication remains inactive.

11.5 Copying a Data File

Relevant Keys

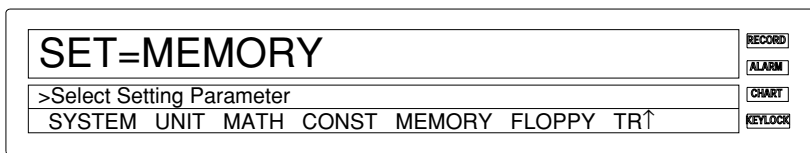

Operating Procedure

- Press the SET key to enter the SET menu.
- Select/set **MEM** using the keys.
- To escape from a lower menu, press the MODE (ESC) key. Its main menu will appear, although new settings/selections will not be kept.
- New settings/selections will be kept when you reach the final display of that setting.

SET= (Main menu)

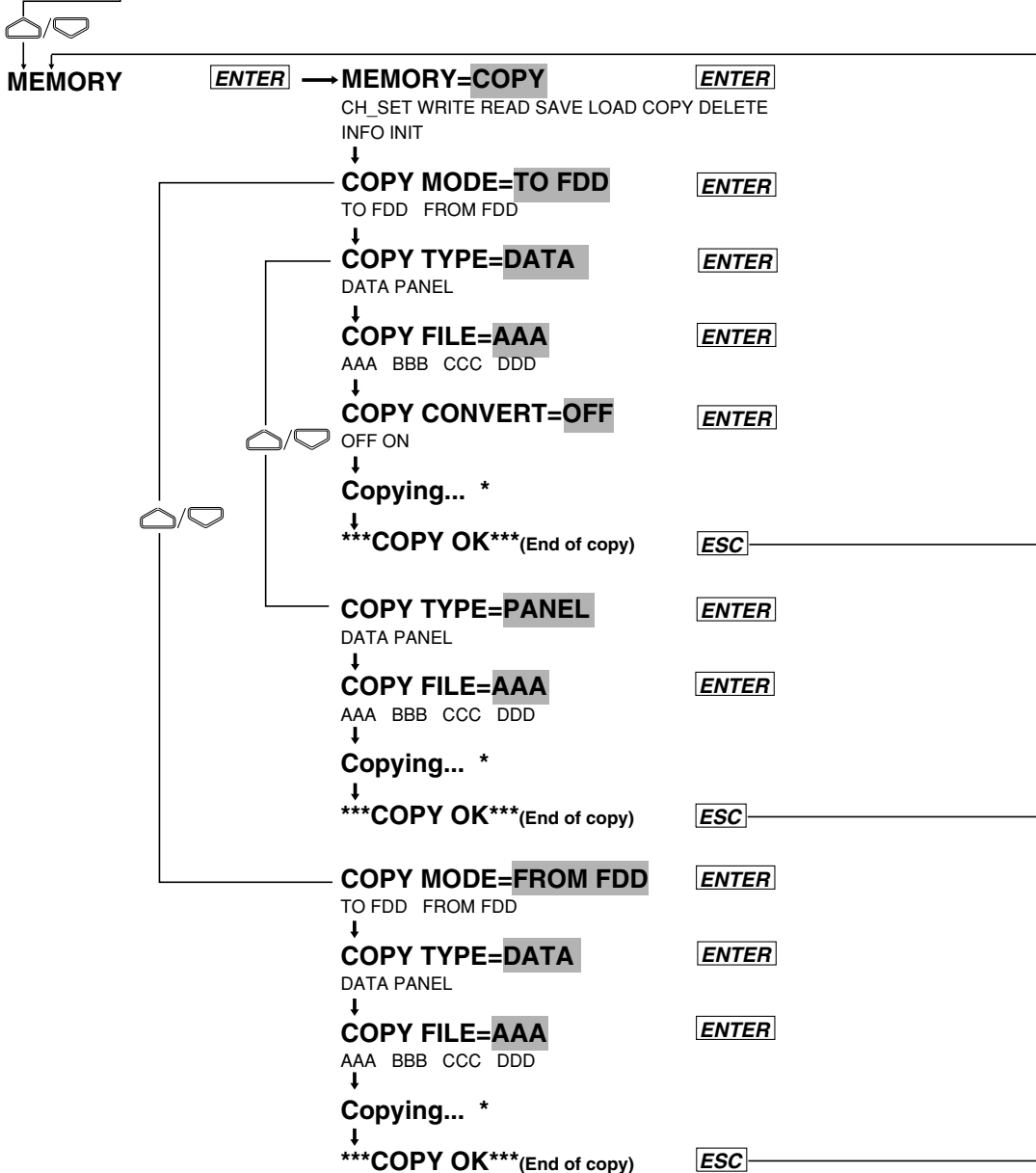

Explanation

Measured/computed/set-up data is copied from the internal RAM disk to a floppy or vice versa.

Types of files that can be copied (COPY TYPE)

- DATA: copies measured/computed data.
- PANEL: copies setup data.

Saving measured/computed data to a floppy disk

Data measured or computed using the instrument cannot be saved to a floppy disk directly. It must be saved to the internal RAM disk first, then copied to a floppy disk. It is not possible to change the file name when copying the file.

Displaying/recording measured/computed data saved on a floppy disk using the instrument

To use the instrument to display or record measured/computed data copied to a floppy disk, the file containing measured/computed data must be copied from the floppy disk to the RAM disk. However, data in ASCII format cannot be copied. It is not possible to change the file name when copying the file.

Note

- No file copying is possible during computations.
- During copying, GP-IB/RS-232-C/RS-422-A/RS-485 communication remains inactive.

11.6 Copying in ASCII Format

Relevant Keys

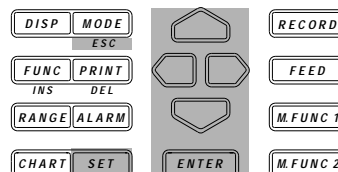
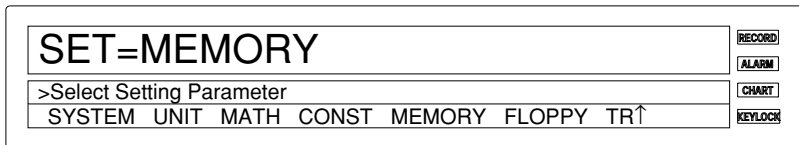

Operating Procedure

- Press the SET key to enter the SET menu.
- Select/set **█** using the keys.
- To escape from a lower menu, press the MODE (ESC) key. Its main menu will appear, although new settings/selections will not be kept.
- New settings/selections will be kept when you reach the final display of that setting.

(Main menu)

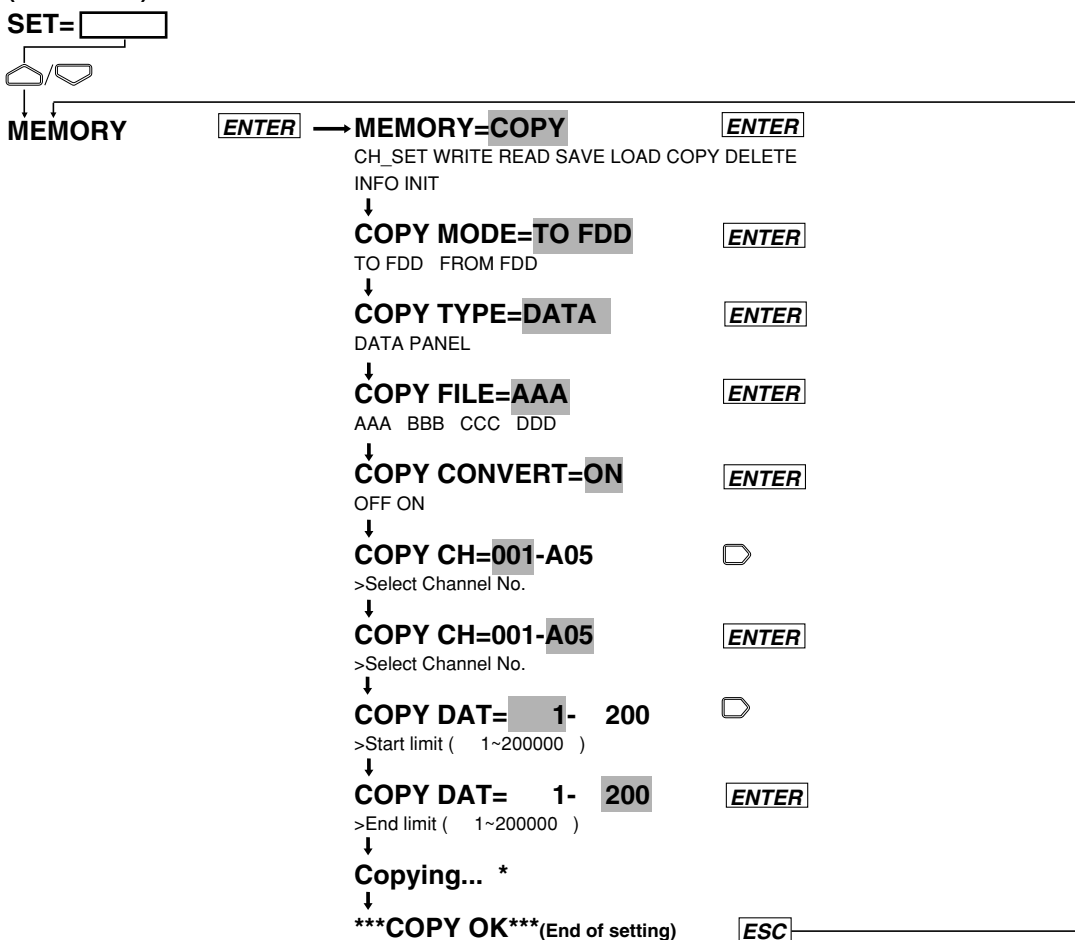

Explanation

Measured/computed data in the internal RAM disk is converted to ASCII data, then copied to a floppy disk. The identifier is .CSV.

Conversion channel (COPY CH)

Used to select a channel whose data is to be converted to ASCII data.

The measurement and computation channels are arranged in order, as shown below:

DR130: 001, 002, . . ., 020, A01, A02, . . ., A30.

Setting "020-A02," for example, converts data on channels 020, A01 and A02.

DR231/241: 001, 002, . . ., 030, A01, A02, . . ., A30.

Setting "030-A02," for example, converts data on channels 030, A01 and A02.

Conversion data (COPY DAT)

Used to specify the conversion range for the channels specified by COPY CH. Enter the conversion start data No. and end data No.

Data size

When measured/computed data is converted to ASCII data, 12 bytes will be used for each data set. Thus, data size can be calculated as follows.

Data size = $178 + 20 \times \text{number of conversion channels} - 2 + (24 + 12 \times \text{number of conversion channels} - 1) \times \text{number of data sets to be converted}$

Copying is not possible if destination's memory size is insufficient.

Note

- When a file is copied to a floppy disk, the file creation date will be replaced by the date on which the file is copied.

11.6 Copying in ASCII Format

Data format

ASCII converted data is saved in the following format.

```

"Sample by Stand-alone"
"Trigger Time", "96-02-14 15:05:07" ← Trigger date/time
"Sample Rate (Sec)", 2 ← Saving interval
"Start Data No.", 1 ← ASCII conversion data No.
"Data Length", 20 ← Data length (number of data sets)
"Ch. Name", "TURBINE1", "TURBINE2", "TURBINE5", "TURBINE7", "TURBINE0" ← Channel No. or tag
"Unit", "mV", "Kg/mm", "C", "C", "C", "C" ← Unit
"YY-MM-DD HH:MM:SS.S"
"96-02-14 15:05:07.0", " 12.520", " 315.00", " 23.2", " -5.0", " 16.3"
"96-02-14 15:05:09.0", " 12.322", " 315.05", " 23.2", " -4.9", " 15.9"
"96-02-14 15:05:11.0", " 13.724", " 315.20", " 23.3", " -4.8", " 15.9"
"96-02-14 15:05:13.0", " 13.220", " 315.12", " 23.3", " -4.9", " 15.8"
"96-02-14 15:05:15.0", " 13.925", " 315.60", " 23.3", " -4.9", " 15.8"
"96-02-14 15:05:17.0", " 13.227", " 315.55", " 23.3", " -4.9", " 16.0"
"96-02-14 15:05:19.0", " 13.928", " 315.04", " 23.3", " -5.0", " 16.1"
"96-02-14 15:05:21.0", " 12.620", " 315.29", " 23.3", " -5.1", " 16.1"
"96-02-14 15:05:23.0", " 12.643", " 315.01", " 23.2", " -5.1", " 16.2"
"96-02-14 15:05:25.0", " 13.426", " 315.05", " 23.2", " -5.1", " 16.3"
"96-02-14 15:05:27.0", " 12.227", " 315.42", " 23.2", " -5.2", " 15.9"
"96-02-14 15:05:29.0", " 12.233", " 315.81", " 23.2", " -5.2", " 15.8"
"96-02-14 15:05:31.0", " 13.822", " 315.03", " 23.2", " -5.1", " 15.8"
"96-02-14 15:05:33.0", " 12.324", " 315.05", " 23.2", " -5.2", " 15.8"
"96-02-14 15:05:35.0", " 13.220", " 315.07", " 23.2", " -5.1", " 16.0"
"96-02-14 15:05:37.0", " 13.450", " 315.91", " 23.2", " -5.1", " 16.3"
"96-02-14 15:05:39.0", " 13.720", " 315.05", " 23.2", " -5.1", " 16.3"
"96-02-14 15:05:41.0", " 12.670", " 315.02", " 23.2", " -5.2", " 16.2"
"96-02-14 15:05:43.0", " 12.830", " 315.01", " 23.2", " -5.0", " 16.1"
"96-02-14 15:05:45.0", " 12.350", " 315.01", " 23.2", " -5.0", " 16.1"

```

Saving date/time
Data

Note

- The following special ASCII codes will be converted as follows.
 - ° ⇒ Space (20H)
 - Ω ⇒ Space (20H)
 - μ ⇒ u (75H)
 - ε ⇒ e (65H)
 - Ū ⇒ Space (20H)
- No file copying is possible during computations.
- During copying, GP-IB/RS-232-C/RS-422-A/RS-485 communication remains inactive.
- If a data item is saved using a trigger, the letter T precedes the time at which the trigger was applied to save the data item.

11.7 Deleting a Data File

Deleting a data file for the SET mode

Relevant Keys

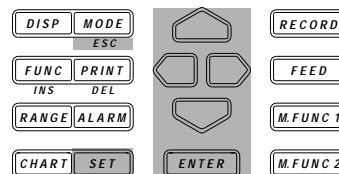
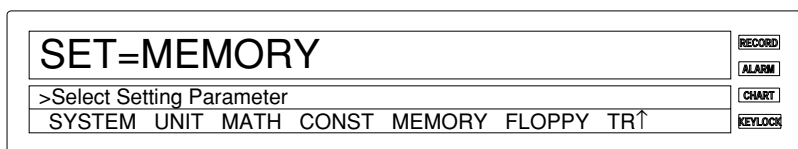

Operating Procedure

- Press the SET key to enter the SET menu.
- Select/set **MEMORY** using the keys.
- To escape from a lower menu, press the MODE (ESC) key. Its main menu will appear, although new settings/selections will not be kept.
- New settings/selections will be kept when you reach the final display of that setting.

(Main menu)

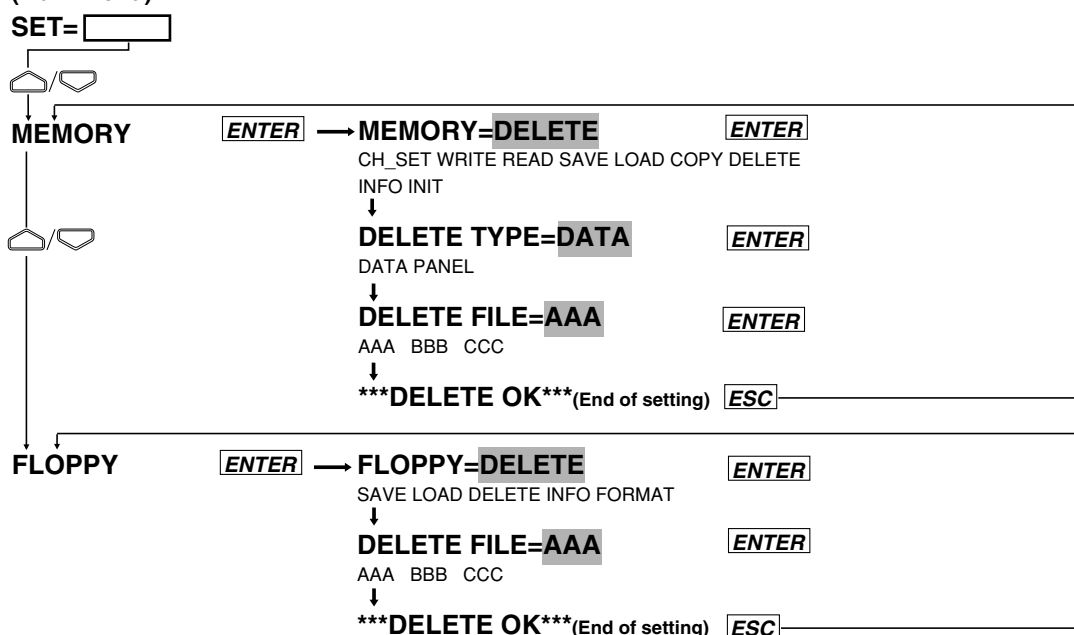

Deleting a data file for the SETUP mode

A data file for the SETUP mode can be deleted in the same way as a data file for the SET mode is deleted.

Select FLOPPY from the SETUP menu.

(Main menu)

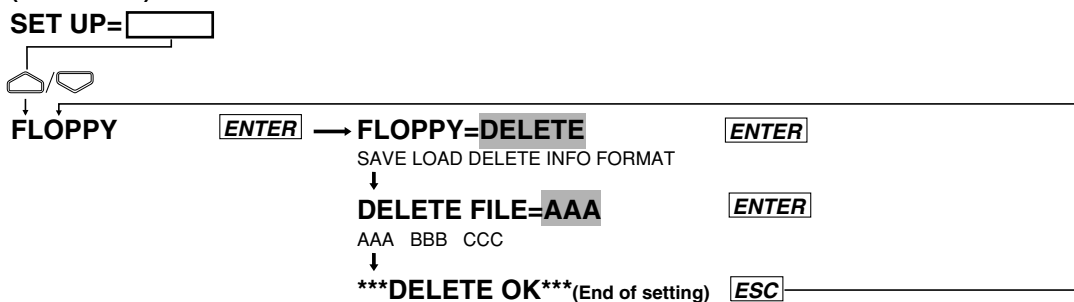

Note

- During deletions, GP-IB/RS-232-C/RS-422-A/RS-485 communication remains inactive.

11.8 Displaying RAM Disk and Floppy Disk Information

Displaying information in the SET mode

Relevant Keys

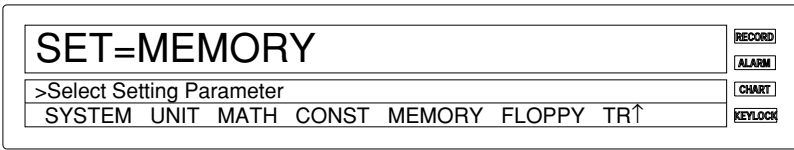

Operating Procedure

- Press the SET key to enter the SET menu.
- Select/set **MEMO** using the keys.
- To escape from a lower menu, press the MODE (ESC) key. Its main menu will appear, although new settings/selections will not be kept.
- New settings/selections will be kept when you reach the final display of that setting.

(Main menu)

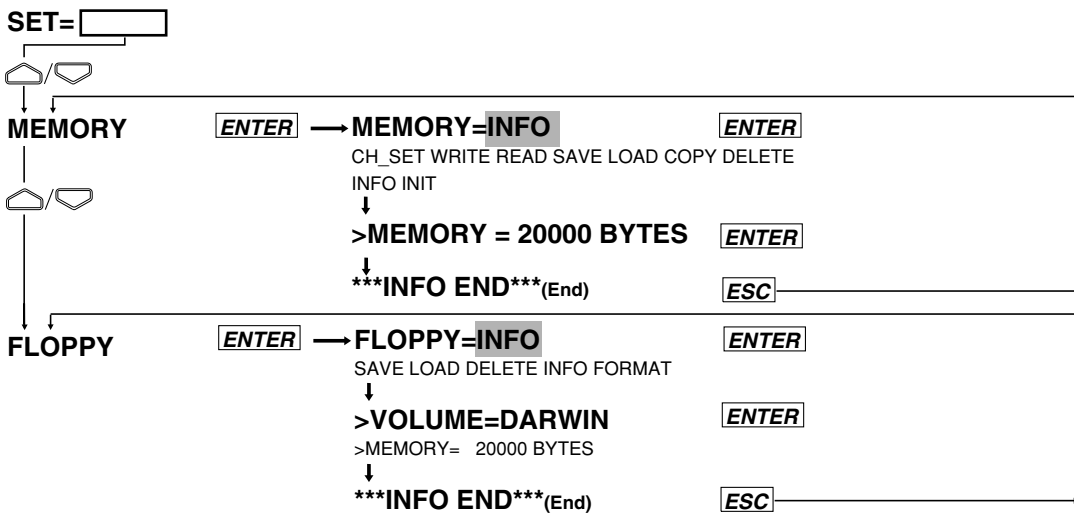

Displaying information in the SETUP mode

Information can be displayed in the same way as the SET mode. Select FLOPPY from the SETUP menu.

(Main menu)

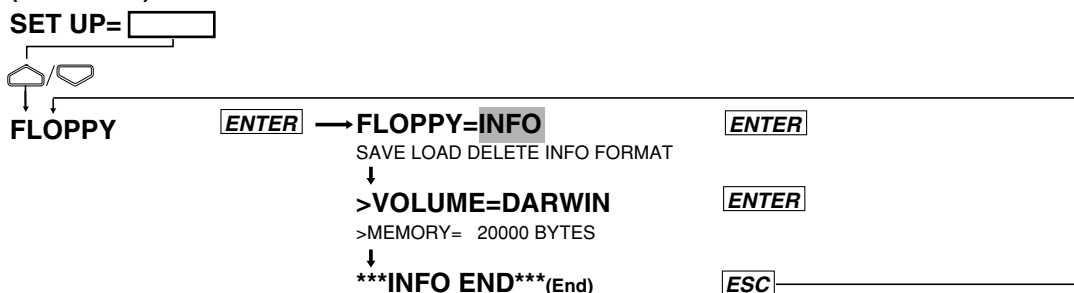

Explanation

Internal RAM disk and floppy disk information is displayed.

Internal RAM disk

Remaining memory size is displayed.

Floppy disk

Volume name and remaining memory size are displayed.

11.9 Initializing the RAM Disk

Relevant Keys

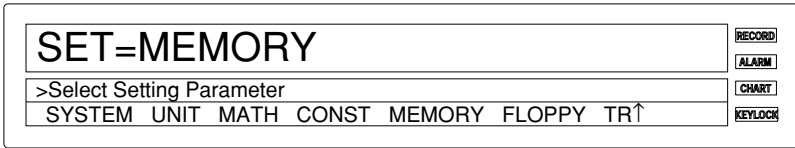

Operating Procedure

- Press the SET key to enter the SET menu.
- Select/set **MEM** using the keys.
- To escape from a lower menu, press the MODE (ESC) key. Its main menu will appear, although new settings/selections will not be kept.
- New settings/selections will be kept when you reach the final display of that setting.

(Main menu)

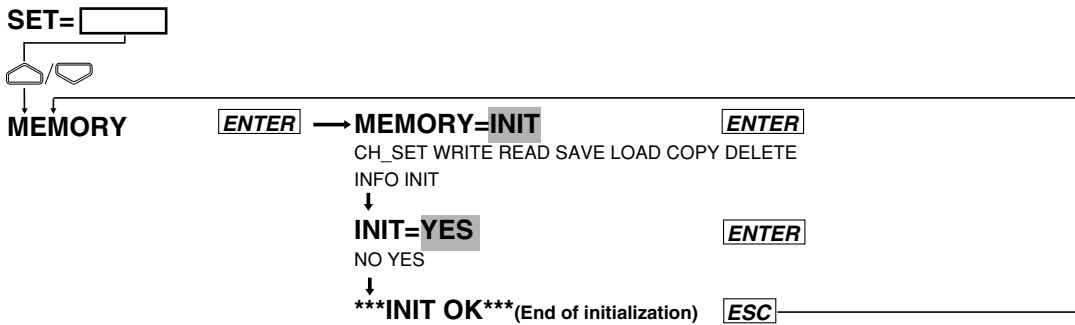

Explanation

The internal RAM disk is initialized. All the data in the RAM disk will be deleted. Thus, copy necessary data to a floppy disk before carrying out initialization.

Note

- During initializations, GP-IB/RS-232-C/RS-422-A/RS-485 communication remains inactive.

11.10 Formatting a Floppy Disk

Formatting a floppy disk in the SET mode

Relevant Keys

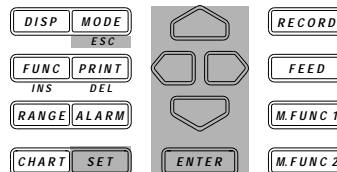
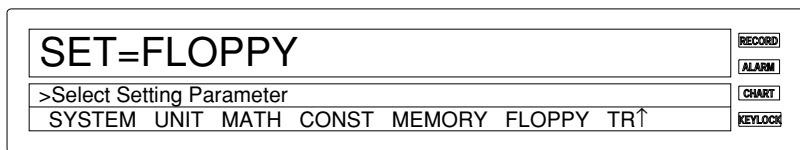

Operating Procedure

- Press the SET key to enter the SET menu.
- Select/set **█** using the keys.
- To escape from a lower menu, press the MODE (ESC) key. Its main menu will appear, although new settings/selections will not be kept.
- New settings/selections will be kept when you reach the final display of that setting.

(Main menu)

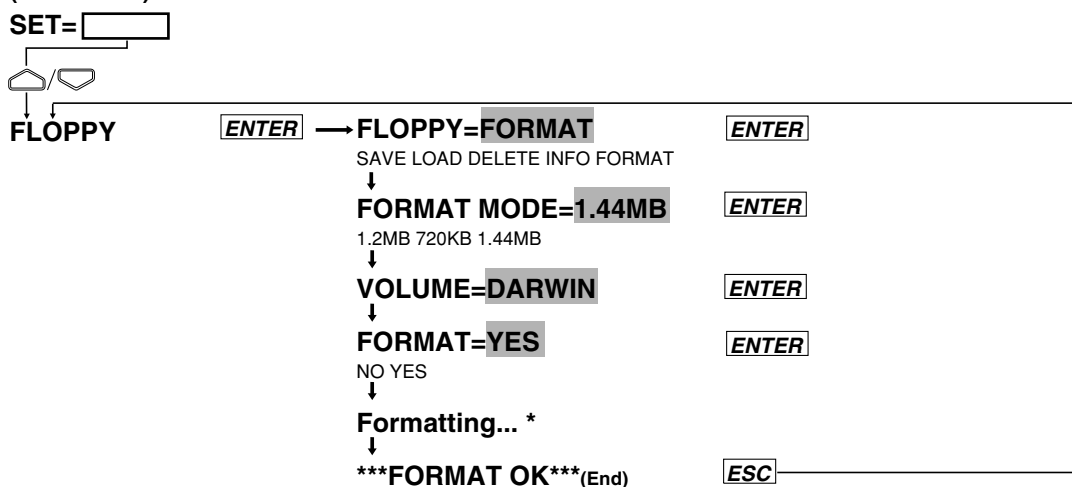

Formatting a floppy disk in the SETUP mode

A floppy disk can be formatted in the same way as in the SET mode. Select FLOPPY from the SETUP menu.

(Main menu)

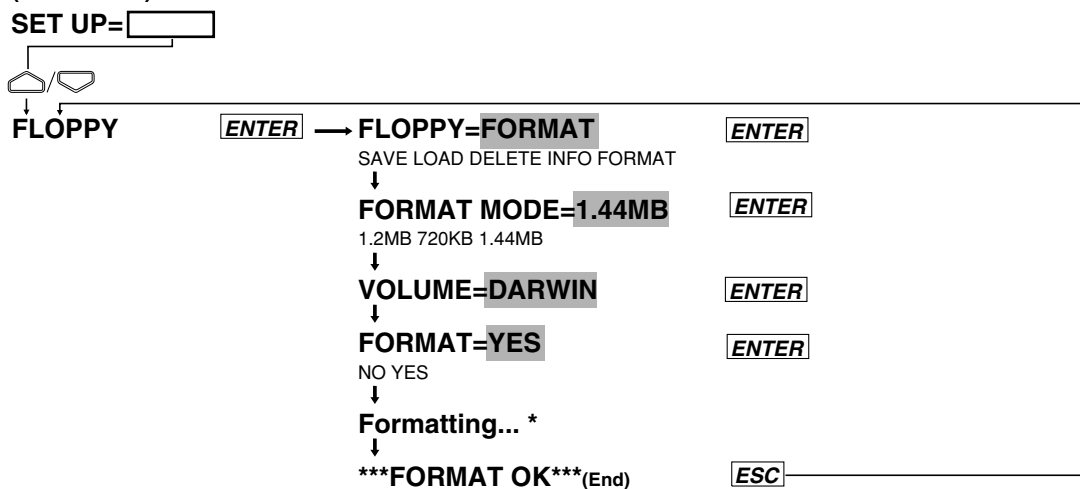

Explanation

A floppy disk is formatted. All the data on the floppy disk will be deleted. Thus, copy necessary data to another media before carrying out formatting.

Format mode (FORMAT MODE)

Select the format mode from the following.

2HD: 1.44 MB, 1.2 MB

2DD: 720 KB

Volume name

Give the volume name using no more than 11 standard-width characters.

Beginning the volume name with a space is not allowed. If this happens, an error will occur.

Note

-
- During initializations, GP-IB/RS-232-C/RS-422-A/RS-485 communication remains inactive.
-

12.1 Overview of the Computation Function

Type	Operator	Example	Description
Addition	+	001+002	Obtain the sum of the measured data of channel 001 and channel 002.
Subtraction	-	002-001	Obtain the difference of the measured data of channel 002 and channel 001.
Multiplication	*	003*K1	Multiply constant K1 to the measured data of channel 003.
Division	/	004/K2	Divide the measured data of channel 004 by constant K2.
Power	**	005**006	Take the power of measured data of channel 005 with the measured data of channel 006.
Absolute value	ABS()	ABS(001)	Obtain the absolute value of the measured data of channel 001.
Square root	SQR()	SQR(002)	Obtain the square root of the measured data of channel 002.
Common logarithm	LOG()	LOG(003)	Obtain the common logarithm of the measured data of channel 003.
Natural Logarithm	LN()	LN(004)	Obtain the natural logarithm of the measured data of channel 004.
Exponent	EXP()	EXP(005)	Make the measured data of channel 005 to be x and obtain e ^x .

* +/- can be used as signs as in -(001).

Logical operators

Type	Operator	Example	Description
Logical product	AND	001AND002	when channel 001=0 and channel 002=0, "0". when channel 001=nonzero and channel 002=0, "0". when channel 001=0 and channel 002=nonzero, "0". when both channel 001 and channel 002 are nonzero, "1".
Logical sum	OR	001OR002	when channel 001=0 and channel 002=0, "0". when channel 001=nonzero and channel 002=0, "1". when channel 001=0 and channel 002=nonzero, "1". when both channel 001 and channel 002 are nonzero, "1".
Exclusive OR	XOR	001XOR002	when channel 001=0 and channel 002=0, "0". when channel 001=nonzero and channel 002=0, "1". when channel 001=0 and channel 002=nonzero, "1". when both channel 001 and channel 002 are nonzero, "0".
Logical negation	NOT	NOT001	when channel 001=0, "1". when channel 001=nonzero, "0".

Relational operators

Type	Operator	Example	Description
Equal	.EQ.	001.EQ.002	when channel 001 = channel 002, "1". when channel 001 ≠ channel 002, "0".
Not equal	.NE.	002.NE.001	when channel 001 ≠ channel 002, "1". when channel 001 = channel 002, "0".
Greater than	.GT.	003.GT.K1	when channel 003 > constant K1, "1". when channel 003 ≤ constant K1, "0".
Less than	.LT.	004.LT.K10	when channel 004 < constant K10, "1". when channel 004 ≥ constant K10, "0".
Greater than or equal to	.GE.	003.GE.K1	when channel 003 ≥ constant constant K1, "1". when channel 003 < constant K1, "0".
Less than or equal to	.LE.	004.LE.K10	when channel 004 ≤ constant K10, "1". when channel 004 > constant K10, "0".

Specified channel statistical operators

Type	Operator	Example	Description
Maximum value	TLOG.MAX()	TLOG.MAX(001)	Obtain the maximum value of the measured data of channel 001.
Minimum value	TLOG.MIN()	TLOG.MIN(002)	Obtain the minimum value of the measured data of channel 002.
Max-min value	TLOG.P-P()	TLOG.P-P(003)	Obtain the P-P value of the measured data of channel 003.
Total value	TLOG.SUM()	TLOG.SUM(004)	Obtain the total value of the measured data of channel 004.
Average value	TLOG.AVE()	TLOG.AVE(005)	Obtain the average value of the measured data of channel 005.

* Statistical computation of the measured data from the start of the statistical computation until it is stopped. When combining with each of the operators, MAX(), MIN(), P-P(), SUM(), and AVE(), the value that can be specified inside the () is limited to the input channel number or the computation channel number (refer to next page) (Example: TLOG.MAX(A01)).

Statistical operators within the group

Type	Operator	Example	Description
Maximum value	CLOG.MAX()	CLOG.MAX(G01)	Obtain the maximum value of the measured data of group G01.
Minimum value	CLOG.MIN()	CLOG.MIN(G02)	Obtain the minimum value of the measured data of group G02.
Max-min value	CLOG.P-P()	CLOG.P-P(G03)	Obtain the P-P value of the measured data of group G03.
Total value	CLOG.SUM()	CLOG.SUM(G04)	Obtain the total value of the measured data of group G04.
Average value	CLOG.AVE()	CLOG.AVE(G05)	Obtain the average value of the measured data of group G05.

* Statistical computation of the measured data of the input channel within the same group measured at the same time every specified interval.

Special operators

Type	Operator	Example	Description
Previous value*	PRE()	PRE(001)	Obtain the previous measured data of channel 001
Hold**	HOLD():	HOLD(001):TLOG.SUM(002)	When the measured value of channel 001 changes from 0 to a nonzero value, maintain the integrated value of the measured data of channel 002 while the measured value of channel 001 is nonzero.
Reset**	RESET():	RESET(001):TLOG.SUM(002)	When the channel 001 = nonzero, reset the integrated value of the measured data of channel 002

* Previously measured data or computed data. In the case of computed data, the value is set to 0 when the computation is reset. At the start of the computation, if the computation was reset, the value is "0". If it was not reset, the value is the last value of the previous computation. The value that can be specified inside the() is limited to the input channel number (001 to 030) or the computation channel number (A01 to A30). Each computing equation can be used once.

** When specifying HOLD(A):B or RESET(A):B, A and B are channel numbers or computing equations. These can be used once in the beginning of the computing equation.

Limitations in computing equations

Multiple operators can be used in 1 computing equation. But, there are following limitations.

- Number of characters that can be used : 40 characters
- Total number of channel numbers and constants: 16 (Computation error occurs when 16 exceeded, and the computed result becomes +OVER or -OVER)
- Computation channel numbers: Computation channel numbers less than the current computation channel number can be used as variables within the computing equation.
Example: A02=001+A01 ← Computation channel numbers greater than or equal to A03 can not be used in this computation.
- Statistical operators (TLOG. or CLOG.) can only be used once in 1 computing equation.

Computation channel

A total of 30 computation channels are available (A01 to A30).

Constant

A total of 30 constants can be set (K01 to K30).

Flag (F01 to F16)

Flags can be set in computing equations as constants (1 or 0). Flags are normally 0, but it is set to 1 when a certain event occurs according to the event/action function. For example, if the computing equation is set to

NOTF01*TLOG.SUM(001),

and FLAG:F01 is set as an edge action of an event/action, F01 becomes 1 when the event occurs. This causes NOTF01 to become 0 and the SUM of channel 001 to become 0.

Computation range

If the result exceeds $\pm 10^{308}$ during computation, an overflow will occur.

Data applicable for computation

The following data is used for computation.

- Measured data: Specified by channel No. (DR130: 001 to 020; DR231/241: 001 to 030)
- Computed data: Specified by computation channel No. (A01 to A30).
- Constant: Value specified for K01 to K30.
- Group data: Measured data of channels belonging to a group. Specified by group No. (G01 to G07). This is applicable only for CLOG.
- Communication input data: Data written to the instrument's memory via communication interface. Specified by data No. (C01 to C30).
- Data on internal RAM disk: Applicable only for the DR130-1/DR231-1/DR241-1 (equipped with a floppy disk drive). Measured/computed data saved in the internal RAM disk. Use the following numbers to specify data.

Measured data:

DR130: M001 to M020

DR231/241: M001 to M030

Computed data:
DR130/231/241: MA01 to MA30

Handling of data for computation

For computation, measured/computed data is treated as a value having no unit. For instance, if the measured data for channel 001 is 20 mV and the measured data for channel 002 is 20 V, the computation result of “001 + 002” will be 40.

Priority of Operators

Priority of operators when they are used in an equation is shown below. Operators are listed in order of priority, from the highest to the lowest.

Type	Operator
Function	ABS(), SQR(), LOG(), LN(), EXP(), MAX(), MIN(), P-P(), SUM(), AVE(), PRE(), HOLD():, RESET():
Repeated multiplication	**
Sign, logical negation	+, -, NOT
Multiplication, division	*, /
Addition, subtraction	+, -
Greater, smaller	.GT., .LT., .GE., .LE.
Equal, not equal	.EQ., .NE.
Logical AND	AND
Logical OR, exclusive OR	OR, XOR

Alarm

Up to 4 alarms can be set for each computation channel. Only two types of alarm are available: upper-limit alarm (H) and lower-limit alarm (L). Hysteresis is always set to “0”. For a detailed description of alarm setting, refer to 8.1, “Setting Alarms and Relays (including internal switches)” (page 8-1).

Event/action function

The event/action function can be used to start/stop computation and clear computation channels in case an event takes place. refer to 9.1, “Setting Event/Action Functions” (page 9-1).

Actions to be taken in case of overflow and computation error

Actions to be taken in case of an error during computation can be specified.

- Error display: +OVER or -OVER is displayed.
- Error data during TLOG or CLOG: The operator is asked to select whether to display the data as a computation error or ignore the error and continue computation.
- Overflow data during TLOG or CLOG: The operator is asked to select whether to display the data as a computation error or ignore the error and continue computation. The operator is also asked to select whether or not the data be used as the upper-/lower-limit value.

Description of the upper-/lower-limit value is given below:

Measurement channels to which linear scaling is applied: Specified scaling upper-/lower-limit

Measurement channels to which no linear scaling is applied: Upper-/lower-limit of the measuring range

Computation channels: Specified LEFT/RIGHT value

12.2 Setting a Computation Equation

Relevant Keys

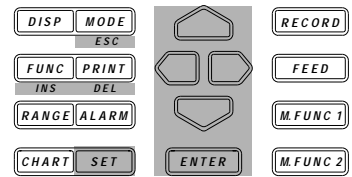

Operating Procedure

- Press the SET key to enter the SET menu.
- Select/set **■** using the keys.
- To escape from a lower menu, press the MODE (ESC) key. Its main menu will appear, although new settings/selections will not be kept.
- New settings/selections will be kept when you reach the final display of that setting.

(Main menu)

SET=

MATH

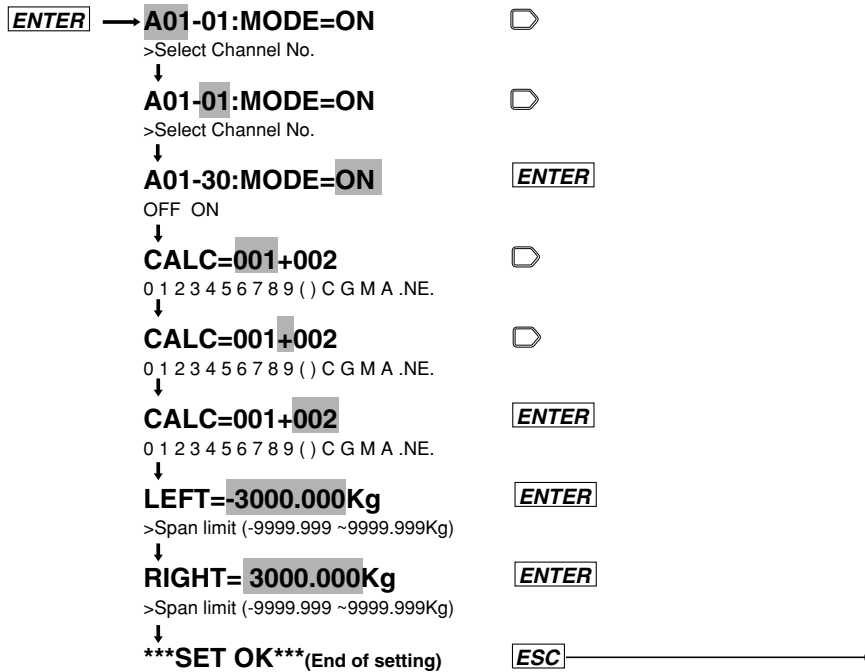

Explanation

A computation equation can be set for up to 30 channels (A01 to A30).

Setting the mode

If "A01-30 MODE=ON" is specified as in the example given on the previous page, the same equation can be set for channels A01 to A30. To set an equation for one channel only, specify, for instance, "A01-A01 MODE=ON".

Computation equation

In addition to operators described on page 12-1, the following symbols can be used in equations.

(/): Used for () setting.

K : Used if equations contain constants K01 to K30.

M : Used to specify the measurement channel No. for which the data saved on the RAM disk is to be re-generated. Applicable for the DR130-1/DR231-1/DR241-1 equipped with a floppy disk drive.

A : Used to specify the computation channel No. for which the data saved on the RAM disk is to be re-generated. Applicable for the DR130-1/DR231-1/DR241-1 equipped with a floppy disk drive. Also used to specify a computation-channel number, as in "A05."

C : Used to specify communication input data (digital data).

G : Used to specify the group No. for which CLOG (computation of data of a group measured on the same time) is to be used.

Restrictions in Equations

Computation channel No

- The specified computation equation for a computation channel No. can contain only computation channel Nos. as variable which are equal to or smaller than said computation channel No.

(Example) $A02=001+A01$

In this example, any computation channel No. which is equal to or greater than A03 cannot be used.

- Either TLOG or CLOG can be used in an equation.

Note

- Each equation must consist of up to 40 characters.
- The total number of channels and constants to be used for each equation is 16 or smaller.

Setting the recording span

Set the recording span for computation results. The setting range is from -9999999 to 99999999.

A decimal point can be placed in such positions as shown in "\$.\$\$\$\$," "\$\$.\$\$\$," "\$\$\$.\$\$,

"\$\$\$\$.\$," and "\$\$\$\$\$.". The unit specified in 6.1, "Setting Recording Mode/Engineering Unit/Recording Channel and Recording Interval" (page 6-1) will be used.

LEFT : Sets the left-limit value of the recording span.

RIGHT : Sets the right-limit value of the recording span.

Note

If the computation ON/OFF, computation equation or span setting is changed, the alarm and partial compression recording settings for the corresponding channel will be reset.

Example of Settings of CLOG

When computing the maximum, minimum, maximum minus minimum, sum and average of data measured at the same time on multiple channels, you must configure groups beforehand.

Example of settings where the averages for channels 001, 002, 003, 004, 006 and 008 are computed:

Configuration of groups:

In the SET menu, assign channels 001, 002, 003, 004, 006 and 008 to group G01, as shown below:

SET=GROUP

GROUPNo.=G01

G01=001-004, 006, 008

Define the computational expression that computes the average of group 1, as shown below:

CALC=CLOG.AVE (G01)

12.3 Setting a Constant

Relevant Keys

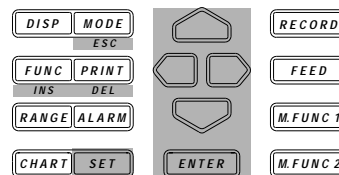
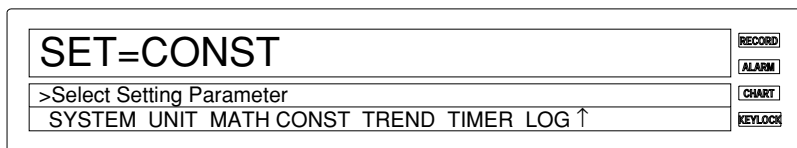

Operating Procedure

- Press the SET key to enter the SET menu.
- Select/set using the keys.
- To escape from a lower menu, press the MODE (ESC) key. Its main menu will appear, although new settings/selections will not be kept.
- New settings/selections will be kept when you reach the final display of that setting.

(Main menu)

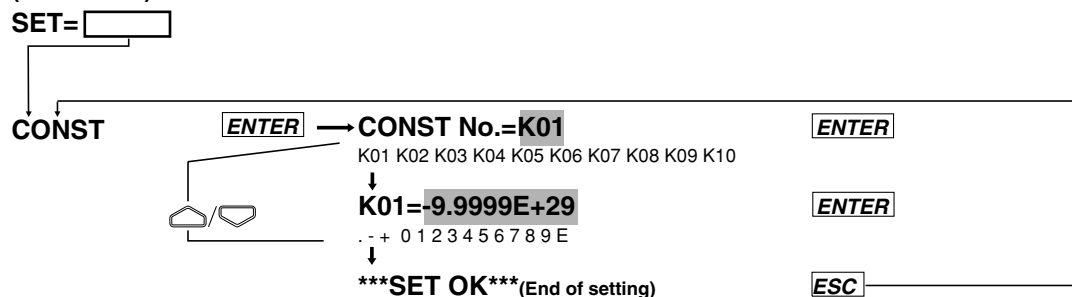

Explanation

Up to 30 constants (K01 to K30) can be set.

The number of significant digits is 5 excluding the decimal point. If exponent is used, the mantissa and exponent must consist of 5 digits and 2 digits, respectively.

The configurable ranges are:

- $-1.0000E + 35$ to $-1.0000E - 35$
- 0
- $1.0000E - 35$ to $1.0000E + 35$

12.4 Starting/Stopping Computation

Computation can be started and stopped from the FUNC menu or using the event/action function.

Starting/stopping computation from the FUNC menu

Press the FUNC key and select the desired operation from the FUNC menu.

- MATH START
Starts computation. This is displayed while computation is not in progress.
- MATH CLR START
Clears computation results then re-starts computation.

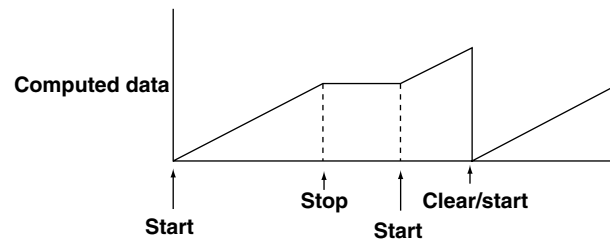

- MATH STOP
Stops computation. Computation results are not cleared. This is displayed while computation is in progress.
- MACH ACK
Clears status indication which is displayed in case of incomplete measurement during computation.

For a detailed description of the FUNC menu, refer to 9.3, “Alarm Acknowledgment, Alarm Rest, Timer Reset, Keylock, and Message Printout” (page 9-14).

Starting/stopping computation using the event/action function

The event/action function can be used to carry out the following operations.

- MATH START
Starts computation.
- MATH STOP
Stops computation.
- MATH CLEAR
Clears data before the first computation is carried out.

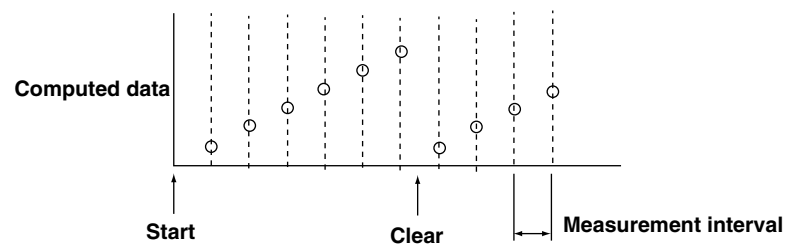

- MATH RESET
Clears data after the first computation is carried out.

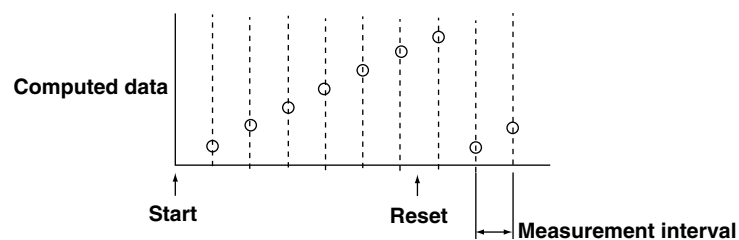

Event/action function

An example of setting the event/action function is given below.

Set the event/action function if you want to reset the results after computation is carried out for a certain period of time, then resume computation.

1. Set **TIMER RST** for the **MFUNC KEY:1** event.
2. Set **MATH:START** for the same **MFUNC KEY:1** event.
3. Set **MATH:RESET** for **TIMER:1** event.
4. Set the mode for **TIMER No.1** to **RELATIVE** and **TIME** to "00 01:00".

After the above settings have been made, press the **MFUNC1** key. Timer 1 will be reset according to the above steps 1 and 2, then computation starts. After elapse of one hour, computation results will be reset according to step 3, but computation will still continue. When a further hour elapses, computation results will be reset. The above operations will be carried out repeatedly until computation is stopped.

For a detailed description of the event/action function, refer to 9.1, "Setting Event/Action Functions" (page 9-1). Refer to pages 2-9, 6-2 and 6-3 for a description of timers.

Status display during computation

The following status symbols are displayed in the sub-display 2 (lowest display section).

- C**: Computation is in progress.
- X**: Incomplete measurement has occurred. If this status occurs frequently, reduce the number of equations or reduce the measurement period. The number of equations may be too large for computation to be carried out within the specified measurement period.

Restrictions during computation

The following settings cannot be made while computation is in progress.

- Measuring range
- Computation equation/constant
- Group
- Copying when range copying is "on"

Examples of Setting Using the Event/Action Functions

- Sum the values measured on channel 001 from 8:00 to 9:00 every day.
Setting the MATCH TIME field:
Configure the DR recorder so events occur at 8:00 and 9:00 every day.

(Main menu item)

SET=

MATCH TIME

(Submenu items)

ENTER →

MATCH TIME No.=1

ENTER

Selects match timer no. 1.

1 2 3

↓
1:TIME=00 08:00

ENTER

Sets the date to 00 and time to 8:00.

>Set Day & Time DD HH:MM:00

↓
SET OK (configuration complete)

ENTER

↓
MATCH TIME No.=2

ENTER

Selects match timer no. 2.

1 2 3

↓
1:TIME=00 09:00

ENTER

Sets the date to 00 and time to 9:00.

>Set Day & Time DD HH:MM:00

↓
SET OK (configuration complete)

ENTER

Setting the EVENT/ACTION fields:

Configure the DR recorder so it uses the match time as the event to clear computed values and then start computing at 8:00 and ends computing at 9:00.

(Main menu item)

SET=

LOGIC

ENTER →

(Submenu items)

LOGIC BOX No.=1

ENTER

(01 to 30)

↓
EVT=MATCH TIME:1

ENTER

Selects match time 1.

↓
ACT=EDGE / MATH : CLEAR

ENTER

Provides the setting for clearing computed values.

↓
SET OK (configuration complete)

ENTER

↓
LOGIC BOX No.=2

ENTER

(01 to 30)

↓
EVT=MATCH TIME:1

ENTER

Selects match time 1.

↓
ACT=EDGE / MATH : START

ENTER

Provides the setting for starting computing.

↓
SET OK (configuration complete)

ENTER

↓
LOGIC BOX No.=3

ENTER

(01 to 30)

↓
EVT=MATCH TIME:2

ENTER

Selects match time 2.

↓
ACT=EDGE / MATH : STOP

ENTER

Provides the setting for ending computing.

↓
SET OK (configuration complete)

ENTER

Computation equation:

CALC=TLOG.SUM (001)

If, in the event/action functions, you have assigned the same event to more than one LOGIC BOX number at the same time, the DR recorder executes computing, beginning with the smallest LOGIC BOX number. In the above configuration, the DR recorder clears computed values at 8:00 and starts computing. The values and behaviors of the event/action functions when computing is done with the above configuration are as follows:

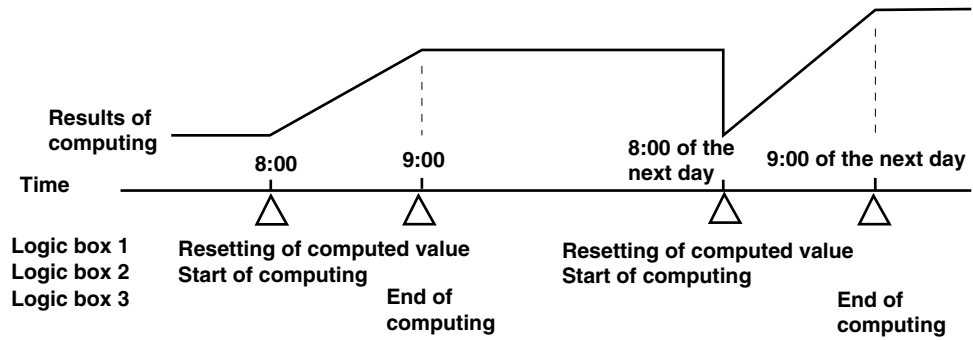

- Sum the values measured on channel 001 every hour.
- Setting the TIMER field:
 Configure the DR recorder so an event occurs every hour with reference to the hour 00:00.

(Main menu item)

SET=

TIMER

(Submenu items)

- ENTER** → **TIMER No.=1** **ENTER**
 1 2 3 4 5 6
 ↓
1: TIMER MODE=ABSOLUTE **ENTER** Absolute time
 ↓
1: TIME=1h **ENTER** One-hour interval
 ↓
1: REF TIME=00:00 **ENTER** Sets the reference time.
 ↓
*****SET OK***** (configuration complete) **ENTER**

Setting the EVENT/ACTION fields:
 Configure the DR recorder so it clears computed values at the time set on the timer.

(Main menu item)

SET=

LOGIC

(Submenu items)

- ENTER** → **LOGIC BOX No.=1** **ENTER**
 (01 to 30)
 ↓
EVT=TIMER:1 **ENTER** Selects timer 1.
 ↓
ACT=EDGE / MATH : CLEAR **ENTER** Resets the computed value.
 ↓
*****SET OK***** (configuration complete) **ENTER**

Computation equation:
 CALC=TLOG.SUM (001)

To start computing, press the FUNC key and select MATH START from the FUNC menu.
 The values and the behaviors of the event/action functions when computing is done with the above configuration are as follows:

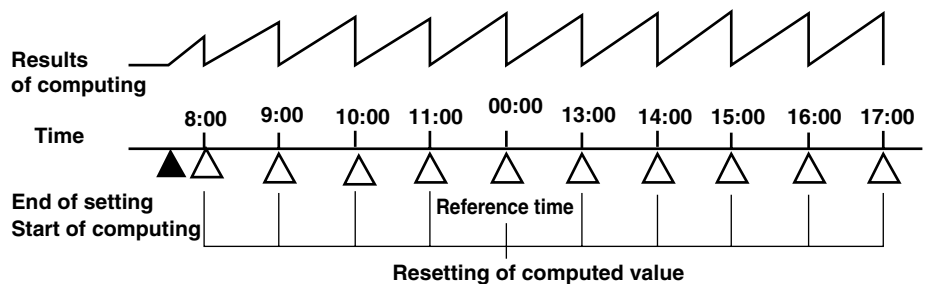

Explanation**Displaying/recording in case of computation error (MATH ERROR)**

Used to determine whether +OVER or -OVER be displayed/recording in case of computation error.

Time axis scale for TLOG SUM (TLOG TIME SCALE)

For TLOG.SUM of time series, data is added at each measurement interval. However, in the case of an input having unit of /s, /min or /h like flow rate, the computation result will differ from the actual value, if addition of data is carried out. In this case, setting TLOG TIME SCALE according to the unit of the input will cause the data measured at measurement intervals to be processed according to the unit of the input.

For instance, if the measurement interval is 2s and input value is 100 m³/min, the computation result will be 30000 after the elapse of one minute, since 100 is added every 2 seconds. Setting TLOG TIME SCALE to /min will cause the measured data to be multiplied by 2s/60s at each measurement interval, thus making the result close to the actual input value.

If this function is set to OFF, simple addition of data will be carried out.

Process of abnormal data during TLOG or CLOG (TLOG CH ERROR)

Used to select the process method for abnormal data obtained during TLOG or CLOG.

- ERROR : Abnormal data is processed as a computation error.
- SKIP : Abnormal data is ignored and computation is continued.

Process of overflow data during TLOG or CLOG (TLOG CH OVER)

Used to select the process method for overflow data obtained during TLOG or CLOG.

- ERROR : Overflow data is processed as a computation error.
- SKIP : Overflow data is ignored and computation is continued.
- LIMIT : Overflow data is treated as the next data for computation.

Measurement channels to which linear scaling is applied: Specified scaling upper-/lower-limit

Measurement channels to which no linear scaling is applied: Upper-/lower-limit of the measuring range

Computation channels: Specified LEFT/RIGHT value

Processing of the results of TLOG.PSUM computation

- OVER: If the result of a separate calculation of TLOG.PSUM (XXXX) exceeds 99999999, the DR recorder goes into an overflow.
 - ROTATE: If the result of a separate calculation of TLOG.PSUM (XXXX) exceeds 99999999, the DR recorder resets the value subsequent to 99999999 to 0 and continues computing.
- The process is effective only when a pulse input module is installed.

13.1 Periodic Maintenance and Recommended Parts Replacement Period

Periodic maintenance

Check the recorder's operation periodically to keep it in good operating condition. Especially check the following items and replace consumable parts as needed. Do not use a lubricant for periodic maintenance.

- Are display and recording functioning properly?
- Are there blurred or broken sections of the recording or printout characters?
When replacing the ribbon cassette, refer to Section 3.3, "Chart and Ribbon Cassette Installation."
- Is the chart paper feeding properly? When replacing the ribbon cassette, see Section 3.3, "Chart and Ribbon Cassette Installation."
- Is there enough chart paper left?
- The remaining chart paper length is printed in the left margin of the chart at 15-cm intervals (DR130) or 20-cm intervals (DR231/241).
- When replacing the chart paper, see Section 3.3, "Chart and Ribbon Cassette Installation."

If problems develop with the recorder, see Section 13.3, "Troubleshooting."

Recommended parts replacement period

It is necessary that recorder parts be replaced periodically for use of the recorder over an extended period of time. The table below shows the recommended parts replacement periods for specific parts that wear out. These replacement periods indicate where the recorders have been used under normal operating conditions. When replacing parts, refer to these replacement periods taking the actual operating conditions into consideration. When replacing parts other than the chart paper, ribbon cassette, or fuse, please contact your nearest Sales representative. Addresses may be found on the back cover of this manual.

Part	Part number	Replacement period (in years)	Description
Display	B9233KJ	3.4	30,000 hours
Fuse	A1350EF	2	For AC power supply (250V/2.5A, time-lag fuse)
Fuse	A1354EF	2	For DC power supply (250V/6.3A, time-lag fuse)
Fuse	B9573TZ	10	For printer board (500 mA)
Motor	B9233EA	5	For chart paper
Motot (DR130)	B9231CM	5	For carriage (with a screw shaft)
Motor (DR231)	B9232CM	5	For carriage (with a screw shaft)
Motor (DR241)	B9233EF	5	For carriage (with a screw shaft)
Motor	B9233GR	3	For ribbon cassette
Lithium battery (DR130)	B9231XG	10	For backup of information that has been set
Lithium battery (DR231/DR241)	B9234XZ	10	For backup of information that has been set
Fluorescent lamp (DR231/DR241)	B9628ZN	3.4	Internal assembly lighting (30,000 hours)
Printer head	B9233HA	3	1.5×10^8 dots (depend on the set conditions)
Carriage	B9233GA	5	Depends on the set conditions.

13.2 Replacing the Fuse

WARNING

- The fuse must be of the specified rating (current, voltage, type) to prevent a fire hazard.
- When replacing the fuse, be sure to turn off the AC power switch and check that the source of the DC power supply is turned OFF also. Next, remove the AC power cord, power supply wires, and DC power supply connector. Then, replace the fuse.
- Never short-circuit the fuse holder.

Fuse Rating

The fuse must have the following specifications:

For AC power supply

Maximum rated voltage: 250 V Maximum rated current: 2.5 A Type: time-lag

Standard: IEC/VDE certified Part number: A1350EF

For DC power supply

Maximum rated voltage: 250V Maximum rated current: 6.3A Type: time-lag

Standard: IEC/VDE certified Part number: A1354EF

Replacement procedure

To replace the fuse, proceed as follows:

DR130/DR231 (in case of AC power supply)

1. Turn off the power switch. Turn off the AC power switch also on the rear panel of the DC power supply model.
2. Unplug the AC power cord from the power outlet.
3. Remove the fuse holder at the side of the AC power connector on the rear panel.
4. Remove the blown fuse from the holder.
5. Insert a new fuse into the holder and then install the holder in place.

DR130

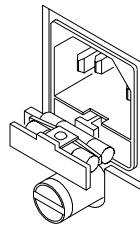

DR130 DC power model

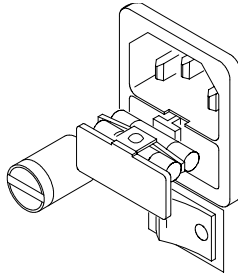

DR231

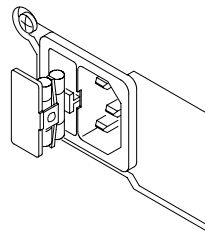

DR231 DC power model

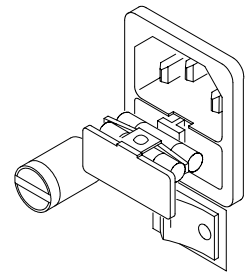

DR241

1. Turn off the power switch.
2. Disconnect the power connections.
3. Open the front and display doors to gain access to the fuse holder. Use a standard screwdriver to turn the fuse-holder screw counterclockwise. Then remove the fuse holder.
4. Remove the blown fuse from the holder.
5. Insert a new fuse into the holder and then install the holder in place.

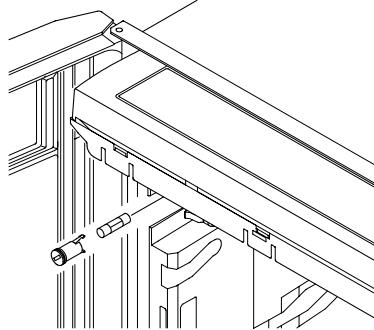
**DR130/DR231/DR241 (in case of DC power supply)**

1. Turn off the power switch.
2. Disconnect the power connections.
3. Use a standard screwdriver to turn the fuse-holder screw counterclockwise, located next to the DC power terminals. Then remove the fuse holder.
4. Remove the blown fuse from the holder.
5. Insert a new fuse into the holder and then install the holder in place.

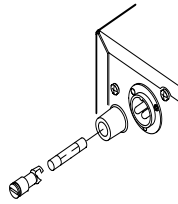
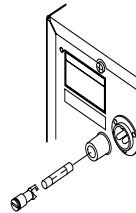
DR130**DR231****Note**

The fuse is located in the case at the rear side of the main unit where the input/output module is connected. This fuse may not be replaced by the customer. Fuse rating is a 250V2A time-lag fuse with IEC/VDE certification for an AC power supply. It is a 250V6.3A time-lag fuse with UL/CSA certification for a DC power supply.

13.3 Troubleshooting

If an error code appears on the display, see Section 13.4, "Error Codes."

If servicing is necessary, or if the instrument is not operating correctly though the following corrective actions have been taken, please contact your nearest sales representative. Addresses may be found on the back cover of this manual.

Problem	Probable Cause	Corrective Action
Recorder does not operate.	Power switch is off.	Turn on the power. There is also an AC power switch on the back panel on the DC power supply model.
(The recorder carriage and chart do not move.)	Power supply is not connected properly.	Connect properly.
	Supplied power does not meet power requirements.	Use power meeting its requirements.
	Fuse blown.	Replace fuse. (If the fuse blows immediately after turning on the power, servicing will be required.)
Output beyond its limits Fluctuating indication Carriage swung over.	Input specifications are not correct.	Correct input specifications.
	Incorrect measuring range or recording span	Change measuring range or recording span.
	Noise superimposed.	Connect input wiring far away from noise source.
		Ground recorder.
		Ground measurement object.
		Isolate thermocouple from measurement object.
		Use shielded wiring for input line.
		Change A/D integral times.
	Use moving average.	
	Use input filter.	
No countermeasure taken against ambient temperature changes.	Install input terminal cover properly.	
	Protect recorder from blowing air of fan.	
	Keep temperature changes near input terminals small.	
Input connected improperly.	Connect input properly.	
	Connect module properly.	
	Tighten screws properly.	
	Isolate RTD from ground.	
	Replace disconnected thermocouples.	
Recorder connected in parallel with other instruments.	Do not use burnout functions in other instruments.	
	Ground recorder and other instruments in the same ground line.	
	Do not connect recorder in parallel with other instruments (for use with dual-element TC).	
RJC set improperly (for TC input)	Set RJC properly.	
Dot-printing position not calibrated correctly.	Calibrate correctly.	
Other cause.	Contact your nearest sales representative.	
Defective display	Noise superimposed.	Lay input wiring far away from noise source.
		Ground recorder.
		Ground measurement object.
		Isolate TC from measurement object.
		Use shielded wires for input line.
		Change A/D integration times.
	Use input filter.	
DC supply voltage is low.	Increase the input voltage or use a thicker wire to lower the wire resistance (The voltage at the DC power supply connector may be lower than the operating supply voltage range due to the wire resistance).	
Data indicates "xxxxxx"	Input module connected improperly	Connect input properly.
Recorder does not work even with operation key pressed.	Key-lock not released.	Disable key-lock functions in setup mode.
	Recorder set in remote mode.	Set recorder in local mode.
	Other cause.	Contact your nearest sales representative.

13.4 Error Codes

If servicing is necessary, or if the recorder does not operate correctly even though the following corrective actions have been taken, contact your nearest Sales representative. Addresses may be found on the back cover of this manual.

Error Code	Error	Corrective Action
001	System error.	Contact your nearest Sales representative.
002	Set data out of range.	Set numeric data correctly.
003	Time set incorrectly.	Set time correctly.
004	Channels set incorrectly.	Set channels correctly.
005	Invalid setting function parameter.	Set parameter correctly.
006	Invalid character string.	Set character string correctly.
007	Invalid type of input for input module.	Set the type of input correctly.
008	Invalid range setting for input module.	Set range correctly.
009	Numeric values out of range.	Set numeric values correctly.
011	Attempted to do manual, header, list or setup list printout at the end of chart paper.	Install new chart paper.
030	There may be a module that cannot be set in channels with continuous ranges.	Re-set ranges or channels with continuous ranges.
031	There may be an invalid module in channels with continuous ranges.	Change channels in which continuous ranges are set.
040	Reference channel number greater than that of the channel for interchannel differential computations.	Change the reference channel number.
041	Skipped range in the reference channel for interchannel differential computations.	Change the range in the reference channel.
042	RPJC range in the reference channel for interchannel differential computations.	Change the range in the reference channel.
043	SCALE in range setting in the reference channel for interchannel differential computations.	Change the range in the reference channel.
044	The reference channel for interchannel differential computations does not exist.	Change the reference channel number.
045	The left and right spans are identical.	Change the scale setpoint.
046	The left and right scale values are identical.	Change the scale setpoint value.
060	The alarm setting was made in the channel where SKIP was set.	Change ranges.
061	The alarm was set to a channel with ranges where alarm setting cannot be set.	Change ranges.
062	The alarm setpoint is out of range in a channel with continuous ranges.	Set correct alarm setpoint.
063	Relay number set incorrectly.	Set relay number correctly.
080	Invalid character strings for group setting.	Set character strings correctly.
081	Invalid channel in character string for group setting.	Set channel correctly.
083	Partial compaction set to a channel where SKIP was set.	Change ranges.
084	Partial compaction set to a channel in which ranges cannot be partially compacted.	Change ranges.
085	Partial compaction out of range in a channel with continuous ranges.	Set correct partial compaction range.
086	The left and right zones have the same values.	Change zone set values.
087	The left zone is wider than the right zone.	Change zone set values.
088	The left and right zones are less than 5 mm apart wide.	Change zone set values.
089	Copy channel setting error	Sets the correct channel.
090	Attempted to copy a message with the same source and destination number.	Change copy source or destination.
091	Illegal protocol for logic setting.	Set correct protocol.

13.4 Error Codes

100	No equation option	Not possible to make any computation settings.
101	Invalid code in the equation	Set the equation correctly.
102	Incorrect number of () in the equation	Set the correct number of ().
103	Syntax error	Set the equation correctly.
104	Illegal character(s) or code(s) is used before or after an operator.	Set the equation correctly.
105	The right and left spans are the same.	Change the span.
106	Attempted to make range setting during computation.	Stop making range setting.
110	Syntax error for computation constant	Set the constant correctly.
111	Out of constant setting range	Set the constant within the range.
120	Floppy disk not inserted or not formatted.	Insert a formatted floppy disk into the drive.
121	Insufficient memory	Delete unnecessary files.
122	Incorrect file name or volume name	Set the correct file name or volume name.
123	Attempted to make settings which are not allowed to be made during saving or reading of measured data.	Stop making the settings.
124	Too many files in the media	Delete unnecessary files.
125	Attempted to read data which was saved by another instrument model.	Select data which has been saved by DR/DA.
127	Attempted to save data in a write-protected file.	Cancel write-protection.
128	No event/action has been set.	Set the desired action .
130	Incorrect channel found during saving or reading of measured data.	Set the correct channel.
132	Attempted to format the disk while a file is open.	Close the file.
134	Set-up data saving error	
135	Internal data error	
136	Incorrect copy channel	Set the correct copy channel.
139	Other media related error	
141	Disconnected modules were selected.	Specify correct modules.
143	Modules selected which cannot be calibrated.	Specify correct modules.
144	Calibration done improperly.	Check electrical connections. Calibrate again.
145	Hardware becomes faulty during calibration.	If the same error occurs again, contact your nearest Sales representative. Turn off the power and then on. Calibrate again. If the same error occurs again, contact your nearest Sales representative.
170	The IP address does not belong to any of the classes, A, B, or C.	Set the correct IP address.
171	There is a hole in the mask or the host address section is not released.	Set the correct subnet mask.
172	The net address section including the subnet does not match the subnet section of the IP address.	Set the correct net address.
173	The host address section of the IP address is either all zeroes or all ones.	Set the correct IP address.
ROM ERROR	System ROM error	Contact your nearest sales representative.
ROM ERROR*	System ROM error	Contact your nearest sales representative.
RAM ERROR	Main memory error	Contact your nearest sales representative.
RAM-DISK ERROR	RAM disk error	Contact your nearest sales representative.
FLOPPY ERROR	Floppy disk error	Contact your nearest sales representative.
MAIN NV READ ERROR	Internal nonvolatile memory read error	Contact your nearest sales representative.
MAIN NV WRITE ERROR	Internal nonvolatile memory write error	Contact your nearest sales representative.
CARRIAGE CANNOT MOVE	Printer error	Contact your nearest sales representative.
SYSTEM ERROR □□ (□□ : number)	System error □□ (□□ : number)	Contact your nearest sales representative. Check whether each unit or power code is connected properly after turning off the power switch. If the same error occurs again even though you turn on the power switch, contact your nearest sales representative.
RESET ERROR	An error occurs between the main unit and communication module.	Same as above.

13.5 Calibration

Overview

We recommend that you calibrate at least once a year to assure its measurement accuracy. When calibrating, please contact your nearest Sales representative at its address on the back cover of this manual.

Press and hold the MODE key and then turn on the power switch to place the recorder in the calibration mode. Select the module to calibrate the recorder on a module basis. After completing the calibration, turn off the power and then turn it back on when resuming the measurements.

CAUTION

You can use the DISPLAY mode only for a calibration adjustment. If it is maladjusted, the recorder may become faulty. For details, please contact your nearest Sales representative.

Calibration needs selection of:

- a module and;
- the calibration mode.

Once the module has been selected, it is no longer selected again as long as the calibration END mode is not executed.

Calibration mode

- CAL/EXEC mode: This mode enables specified ranges to be calibrated.
- DISPLAY mode: This mode enables current calibrated values to be displayed.
- END mode: This mode enables calibrated values to be stored in the internal nonvolatile memory and terminates the calibration mode. (If ABORT is selected, the calibrated values are not stored in memory.)

Module selection error

The following error messages are displayed:

- The specified module remains disconnected (ERROR141).
- The specified module is such that it cannot be calibrated (ERROR143).

Calibrated data error

The following error messages are displayed:

- Attempted to remove the module during calibration. Or hardware error: ERROR145
- Invalid calibrated data: ERROR144
- Attempted to set invalid numeric values in the DISPLAY mode: ERROR145

Note

When a calibrated data error appears, the error data are stored in memory.

Preliminary

Required Equipment

Name	Measurement Range	Accuracy	Recommended
DC Voltage Generator	0V to 50V	0.005% of setting+1 μ V	Yokogawa 9000*, 4808
DMM	0V to 50V	0.005% of setting+1 μ V	HP3458A
Decade Resistance Box	0.1 Ω to 1000 Ω	0.01%	Yokogawa 2793

* For 0V input, it is necessary to either short the input terminals, or to monitor the output voltage using the DMM.

Calibrating Conditions

- Ambient temper : 23°C \pm 2°C
- Ambient humidity : 55 10%RH
- AC power supply voltage : 100 to 240 VDC
- DC power supply voltage : 12 to 28 VDC
- Power supply frequency : 50/60 Hz \pm 1% (for AC power supply model only)
- Warm-up time : at least 30 minutes for this recorder, and necessary warm-up time for the used equipment

Connection (terminal screw connections)

• **DC Voltage Measurement**

- Apply a rated voltage in the voltage range that is to be calibrated to channel 3.

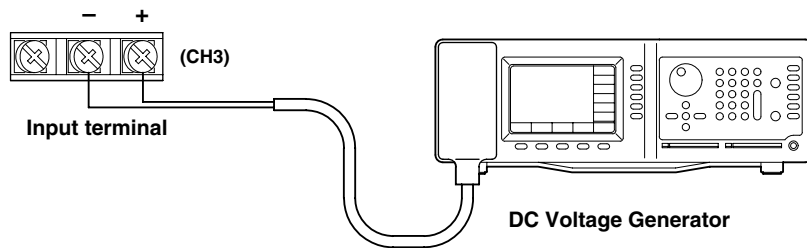

- Short-circuit between “+” and “-” terminals in channel 2.

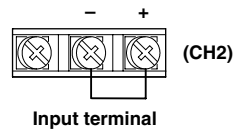

• **Temperature Measurement Using RTD**

- apply the 100 Ω resistance to channel 5.

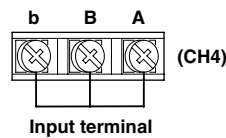

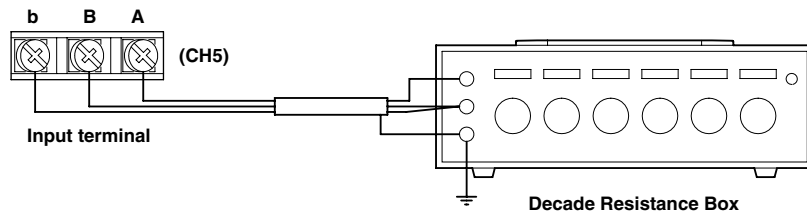

- Short-circuit the resistance input terminals A, B, and b in channel 4.



Operating Procedure**Entering the calibration mode**

1. While pressing and holding the MODE key, turn on the power.

Selecting the module numbers



2. With  , select the module number.

MODULE No=0

0 1 2 3 4 5

3. Press the ENTER key.

Calibrating in CAL/EXEC mode



4. With  , select the CAL/EXEC mode.

AD JUST MODE=CAL/EXEC

>MODULE No=0

DISPLAY CAL/EXEC END

5. Press the ENTER key.

6. With  , select the calibration range.

AD JUST RANGE=20mV

>MODULE No=0

20mV 60mV 200mV 2V 6V 20V 50V Pt:1mA P ↑

7. Enter the rated value in the selected range.

8. Press the ENTER key to execute calibration. During the calibration, the following display appears.

A/D Adjusting

>MODULE No=0

20mV 60mV 200mV 2V 6V 20V 50V Pt:1mA P ↑

9. After the calibration is completed, the following display appears.

*** * * CALC END * * ***



>MODULE No=0

>AD JUST RANGE=20mV

10. Press the ENTER key.

Checking calibrated values in the DISPLAY mode

Use this mode only for checking calibrated values. In this mode, you can adjust a calibrated value, but, if this value is invalid, the instrument may be inoperative. For details, contact your nearest Sales representative.

11. With  , select the DISPLAY mode.

```

AD JUST MODE=DISPLAY
-----
>MODULE No=0
-----
DISPLAY CAL/EXEC END
-----
    
```

12. Press the ENTER key to display the calibrated value display items.

The following shows where the universal input modules are calibrated. The calibrating procedures for DC V/TC/DI input modules are those except RTD in universal input modules.

13. The calibrated values are displayed as follows:

```

20mV ZERO=-          1
-----
>MODULE No=0
-----
>
    
```

14. Press the ENTER key.

15. Display the calibrated-value display items in the following order:

Repeat steps 13 and 14 above.

20 mV SPAN → 60 mV ZERO → 60 mV SPAN → 200 mV ZERO → 200 mV SPAN → 2 V ZERO → 2 V SPAN → 6 V ZERO → 6 V SPAN → 20 V ZERO → 20 V SPAN → 50 V ZERO → 50 V SPAN → Pt: 1 mA ZERO → Pt: 1 mA SPAN → Pt: 2 mA ZERO → Pt: 2 mA SPAN → Pt: 1 mA-H SPAN → Pt: 2 mA-H SPAN → Cu: 2 mA ZERO → Cu: 2 mA SPAN



16. After checking the [Cu: 2 mA SPAN] calibrated value in the above calibrated-value display items, press the ENTER key.

```

* * * DISPLAY END * * *
-----
>MODULE No=0
-----
>
    
```

17. Press the ENTER key.

Completing the selected module calibration with the END mode



18. With  , select the END mode.

ADJUST MODE=END

>MODULE No=0

DISPLAY CAL/EXEC END

19. PRESS the ENTER key.

20. With  , select STORE or ABORT.

A/D ADJUST END=ABORT

>MODULE No=0

ABORT STORE

21. Press the ENTER key. Return to operation 2.

Terminating the calibration mode

22. When you return to normal measurement after completing calibration, turn off the power and then back on.

Explanation**CAL/EXEC mode (for calibration of a specified range)****• Items for calibration range**

- Items for the calibration range vary depending on the type of module to be calibrated.
- For use with universal input modules, select the items for the calibration range from among the following:
20 mV/60 mV/200 mV/2 V/6 V/20 V/50 V/Pt: 1 mA/Pt: 2 mA/Pt: 1 mA-H/Pt: 2 mA-H/Cu: 2 mA
- When the DC V/TC/DI input module is selected, RTD in the universal input module is not displayed.

• Displaying error messages

The following error messages are displayed.

- Attempted to remove the module during calibration. Or, hardware error: ERROR145
- Invalid calibrated data: ERROR144

Note

- When calibrating a high-precision RTD (Pt: []-H), do so after calibrating the voltages to maintain accuracy.
- When a calibrated data error appears, the error data are stored in memory.
- If ERROR145 appears, turn off the power and then back on to restart operation. If the same error occurs again, the recorder may be defective.
- If ERROR144 appears, check the electrical connections and input data. If the same error occurs again, the module to be calibrated may be defective.

DISPLAY mode (to display and adjust the calibrated value)

Use this mode only for checking the calibrated value. In this mode, you can adjust the calibrated value, but, if it is invalid, the instrument may be inoperative. For details, contact your nearest Sales representative.

• **Calibrated-value display items**

- Calibrated-value display items vary depending on the type of module to be calibrated.
- For use with universal input modules, display calibrated-value display items in the following order:
 20 mV ZERO → 20 mV SPAN → 60 mV ZERO → 60 mV SPAN → 200 mV ZERO → 200 mV SPAN → 2 V ZERO → 2 V SPAN → 6 V ZERO → 6 V SPAN → 20 V ZERO → 20 V SPAN → 50 V ZERO → 50 V SPAN → Pt: 1 mA ZERO → Pt: 1 mA SPAN → Pt: 2 mA ZERO → Pt: 2 mA SPAN → Pt: 1 mA-H SPAN → Pt: 2 mA-H SPAN → Cu: 2 mA ZERO → Cu: 2 mA SPAN
- When the DC V/TC/DI input module is selected, the displayed values for RTD in the universal input module can be modified without influencing operation of the recorder.
- The calibrated values appear in the above order each time the ENTER key is pressed. If the MODE key is pressed while displaying calibrated values, the display returns to “A/D calibration mode selection,” and the calibrated value already adjusted before pressing the MODE key is canceled. Calibrated values are effective immediately after terminating the DISPLAY mode.

• **Adjustable range and error display**

- Adjustable ranges are -32768 to 32767 (excepting 16384, -16384, 16385 and -16383).
- If the following numeric values are set, errors appear.
 Outside the range from -32768 to 32767: ERROR002
 16384 or -16384: ERROR145
 16385 or -16383: ERROR144

Note

- In the adjustable ranges, if the following are not satisfied, the adjusted module is recognized as an error module.
- Calibrated value (ZERO) : -3277 to 3277 (ideal value = 0)
- Calibrated value (SPAN) : 29491 to -29491 (ideal value = -32768)

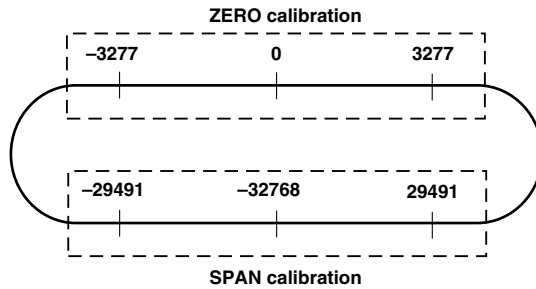

- When calibrating the DC, TC, or DI input module, you need not calibrate an RTD.

END mode (storing a calibrated value in the internal nonvolatile memory)

Select one of the following two:

- STORE : Stores data in the internal nonvolatile memory.
- ABORT : Cancels the storage of data in the internal nonvolatile memory.

14.1 Specifications of DR130/DR231/DR241 (Style S8)

DR130/DR231/DR241 Modules (specified at time of order, and cannot be increased at a later time)

Input module: universal (DC voltage, RTD, TC, DI), DCV/TC/DI...(dedicated input)

Alarm module: 10ch (make contact)

Communication interface module: selectable from GP-IB or RS-232-C

DI/DO module: alarm 2-point output (transfer contact), fail output, chart-end output, input signal for remote control

Max. number of modules : DR130: 4

DR231/241: 6

alarm module in combination with /A4 option: only 1

communication output module in combination with /C □ option: only 1

DI/DO module in combination with /R1 option: only 1

Input

Input type

Universal, or DCV/TC/DI input.

Number of channels/terminal type

DR130 : Selectable from 10/20 ch, and screw/clamp terminal.

DR231/DR241 : Selectable from 10/20/30ch, and screw/clamp terminal.

Input method

floating unbalanced input, each channel mutually isolated (channel independent)

The RTD range has a common potential (terminal b)

A/D resolution

±20000

A/D integration time

20ms (50Hz), 16.7ms (60Hz), 100ms (10Hz) selectable or automatically switched between 50/60Hz (Except, auto switch does not function on the DC power supply model.)

Minimum measurement interval

DR130

Filter ON/OFF A/D number of channels	integration time	Low-pass filter OFF		Low-pass filter ON	
		20ms/16.7ms (50Hz/60Hz)	100ms (10Hz)	20ms/16.7ms (50Hz/60Hz)	100ms (10Hz)
10		2s	4s	3s	12s
20		2s	5s	4s	15s

DR231/DR241

Filter ON/OFF A/D number of channels	integration time	Low-pass filter OFF		Low-pass filter ON	
		20ms/16.7ms (50Hz/60Hz)	100ms (10Hz)	20ms/16.7ms (50Hz/60Hz)	100ms (10Hz)
10		0.5s*	4s	3s	12s
20		2s	5s	4s	15s
30		2s	6s	4s	20s

*: 2s if the power monitor module is installed

Reference junction compensation

Switchable internally or externally for each channel.

Compensation accuracy for the reference junction

(measured at 0°C, where the input terminals are balanced)

Type R, S, B, W : ±1°C

Type K, J, E, T, N, L, U : ±0.5°C

Maximum allowable input voltage

2V DC or lower range, TC, RTD, DI (CONT) : ±10V DC

6V DC or greater range, DI (LEVEL) : ±60V DC

Normal mode voltage

DC voltage, TC : 1.2 times the rated range or less (at peak value, including 50 or 60Hz signal component)

RTD : 50 mV or lower (at peak value)

Normal mode rejection ratio

40dB or greater (50/60Hz ±0.1%)

14.1 Specifications of DR130/DR231/DR241 (Style S3)

Common mode noise voltage

250VAC rms (50/60Hz)

Common mode rejection ratio

120dB or greater (50/60Hz $\pm 0.1\%$, 500 Ω unbalanced, between the negative measurement terminal and ground)

Maximum noise between channels

150VAC rms (50/60Hz)

Measurement range, accuracy and resolution

As described below, under the following operating conditions:

Ambient temperature: 23 $\pm 2^\circ\text{C}$; ambient humidity: 55 $\pm 10\%$ RH; power supply voltage: 90 to 250 VAC (AC power supply) or 10 to 32 VDC (DC power supply)/90 to 132/80 to 250 VAC (when /P6 option is specified); power supply frequency: 50/60Hz within $\pm 1\%$; warm-up time 30 minutes or more; vibrations and others not affecting instrument operation.

However, RTD input is not available with the DCV/TC/DI input module

Input	Type	Measurement (digital display)		Maximum resolution
		Measurement range	Measurement accuracy	
DC Voltage	20mV	-20.000 to 20.000mV	$\pm(0.05\%$ of rdg + 5digits)	1 μV
	60mV	-60.00 to 60.00mV	$\pm(0.05\%$ of rdg + 2digits)	10 μV
	200mV	-200.00 to 200.00mV	$\pm(0.05\%$ of rdg + 2digits)	10 μV
	2V	-2.0000 to 2.0000V	$\pm(0.05\%$ of rdg + 2digits)	100 μV
	6V	-6.000 to 6.000V	$\pm(0.05\%$ of rdg + 2digits)	1mV
	20V	-20.000 to 20.000V	$\pm(0.05\%$ of rdg + 2digits)	1mV
	50V	-50.00 to 50.00V	$\pm(0.05\%$ of rdg + 2digits)	10mV
TC (Note that Accuracy of reference junction compensation is not considered).	R *1	0.0 to 1760.0 $^\circ\text{C}$	$\pm(0.05\%$ of rdg + 1 $^\circ\text{C}$) However,R,S;0 to 100 $^\circ\text{C}$, $\pm 3.7^\circ\text{C}$ 100 to 300 $^\circ\text{C}$, $\pm 1.5^\circ\text{C}$ B:400 to 600 $^\circ\text{C}$, $\pm 2^\circ\text{C}$ accuracy less than 400 $^\circ\text{C}$ is not specified.	0.1 $^\circ\text{C}$
	S *1	0.0 to 1760.0 $^\circ\text{C}$		
	B *1	0.0 to 1820.0 $^\circ\text{C}$		
	K *1	-200.0 to 1370.0 $^\circ\text{C}$	$\pm(0.05\%$ of rdg + 0.7 $^\circ\text{C}$) However,K attains an accuracy of $\pm(0.05\%$ of rdg. +1 $^\circ\text{C}$) within the range between -200 to -100 $^\circ\text{C}$.	
	E *1	-200.0 to 800.0 $^\circ\text{C}$	$\pm(0.05\%$ of rdg + 0.5 $^\circ\text{C}$)	
	J *1	-200.0 to 1100.0 $^\circ\text{C}$	However,J and L attain an accuracy of $\pm(0.05\%$ of rdg. +0.7 $^\circ\text{C}$) within the range between -200 to -100 $^\circ\text{C}$.	
	T *1	-200.0 to 400.0 $^\circ\text{C}$		
	L *2	-200.0 to 900.0 $^\circ\text{C}$		
	U *2	-200.0 to 400.0 $^\circ\text{C}$		
	N *3	0.0 to 1300.0 $^\circ\text{C}$	$\pm(0.05\%$ of rdg. +0.7 $^\circ\text{C}$)	
W *4	0.0 to 2315.0 $^\circ\text{C}$	$\pm(0.05\%$ of rdg. +1 $^\circ\text{C}$)		
	KPvsAu7Fe	0.0 to 300.0K	$\pm(0.05\%$ of rdg. +0.7K)	0.1K
RTD	Pt100(1mA) *5	-200.0 to 600.0 $^\circ\text{C}$	$\pm(0.05\%$ of rdg. +0.3 $^\circ\text{C}$)	0.1 $^\circ\text{C}$
	Pt100(2mA) *5	-200.0 to 250.0 $^\circ\text{C}$		
	JPt100(1mA) *5	-200.0 to 550.0 $^\circ\text{C}$		
	JPt100(2mA) *5	-200.0 to 250.0 $^\circ\text{C}$		
	Pt50(2mA) *5	-200.0 to 550.0 $^\circ\text{C}$	$\pm(0.05\%$ of rdg. +0.3 $^\circ\text{C}$)	
	Ni100(1mA) *6	-200.0 to 250.0 $^\circ\text{C}$	$\pm(0.05\%$ of rdg. +0.3 $^\circ\text{C}$)	
	SAMA			
	Ni100(1mA)DIN *6	-60.0 to 180.0 $^\circ\text{C}$	$\pm(0.05\%$ of rdg. +0.3 $^\circ\text{C}$)	
	Ni120(1mA) *7	-70.0 to 200.0 $^\circ\text{C}$		
	J263*B	0.0 to 300.0K	$\pm(0.05\%$ of rdg. +0.3K)	
	Cu10 GE *8	-200.0 to 300.0 $^\circ\text{C}$	$\pm(0.2\%$ of rdg. +0.7 $^\circ\text{C}$)	
	Cu10 L&N *8			
Cu10 WEED *8				
Cu10 BAILEY *8				
High resolution RTD	Pt100(1mA) *5	-140.00 to 150.00 $^\circ\text{C}$	$\pm(0.05\%$ of rdg. +0.3 $^\circ\text{C}$)	0.01 $^\circ\text{C}$
	Pt100(2mA) *5	-70.00 to 70.00 $^\circ\text{C}$	$\pm(0.05\%$ of rdg. +0.3 $^\circ\text{C}$)	
	JPt100(1mA) *5	-140.00 to 150.00 $^\circ\text{C}$	$\pm(0.05\%$ of rdg. +0.3 $^\circ\text{C}$)	
	JPt100(2mA) *5	-70.00 to 70.00 $^\circ\text{C}$	$\pm(0.05\%$ of rdg. +0.3 $^\circ\text{C}$)	
Contact	Voltage input	OFF for a voltage of less than 2.4V. ON for a voltage of 2.4V or more.(TTL)	OFF for a voltage of less than 2.4V. ON for a voltage of 2.4V or more. (TTL)	
	Contact input	ON/OFF of contact	ON/OFF of contact	

*1 : R,S,B,K,E,J,T:ANSI,IEC 584,DIN IEC 584,JIS C 1602-1981

*2 : L:Fe-CuNi,DIN43710,U:Cu-CuNi,DIN 43710

*3 : N:Nicrosil-Nisil,IEC 584,DIN IEC 584

*4 : W:W:5%RE-W:26%Re (Hoskins Mfg Co)

*5 : Pt50:JIS C 1604-1981,JIS C 1606-1986

Pt100:JIS C 1604-1989,JIS C 1606-1989,IEC 751,DIN IEC 751

JPt100:JIS C 1604-1981,JIS C 1606-1989

*6 : SAMA/DIN

*7 : McGRAW EDISON COMPANY

*8 : ranges to which accuracy applies:

Cu10 GE:-84.4 to 170.0 $^\circ\text{C}$,

Cu10 L&N:-75.0 to 150.0 $^\circ\text{C}$,

Cu10 WEED:-200.0 to 250.0 $^\circ\text{C}$,

Cu10 BAILEY:-200.0 to 250.0 $^\circ\text{C}$

Measurement interval

DR130 : Selectable from 2, 3, 4, 5, 6, 10, 12, 15, 20, 30 or 60s; max. 2s/20ch (measured with 20ch, filter:OFF, A/D integration time: 20ms(50Hz)/16.7ms(60Hz))

DR231/DR241 : Selectable from 2, 3, 4, 5, 6, 10, 12, 15, 20, 30 or 60s; max. 2s/30ch (measured with 30ch, filter:OFF, A/D integration time: 20ms(50Hz)/16.7ms(60Hz))

Noise rejection

Rejection by integration type A/D, lowpass filter, or moving averaging.

Input resistance

Min. 10M Ω at 2V DC or lower and thermocouple range

Approx. 1M Ω at 6V DC or higher.

Insulation resistance

Min. 20M Ω at 500V DC between the input terminal and ground.

Input bias current

max. 10nA

Dielectric strength

Between input terminals : 1000V AC (50/60Hz) for one minute

Between an input terminal and ground : 1500V AC (50/60Hz) for one minute

Input source resistance

DCV, TC : 2k Ω or lower

RTD : 10 Ω or lower per line (Pt100 Ω)

5 Ω or lower per line (Pt50 Ω)

1 Ω or lower per line (Cu10 Ω)

Temperature coefficient

zero : 0.01% of range/ $^{\circ}$ C

full span : 0.01% of range/ $^{\circ}$ C (0.02% of span/ $^{\circ}$ C for CU10 Ω)

Thermocouple burnout

Detected in a TC range (On/Off) enabled, current of 4 μ A, detectable pulse width of approx. 5ms
2 k Ω or lower is considered "normal"

100 k Ω or greater is considered "disconnected"

Detection interval for thermocouple burnout

Detected at each measurement interval.

Input Type

Power monitor

Terminal Configuration

Single-phase use (one channel each for voltage and current): clamp

Three-phase use (three channels each for voltage and current): clamp

Shortest Measurement Interval

2 s

Method of Input

Transformer-isolated input, with isolation between channels (separated channels)

Method of Measurement and Computing

Digital multiplication

Input Ranges

Voltage: 25 or 250 Vrms

Current: 0.5 or 5 A

In three-phase measurement or single-phase three-wire measurement, the current/voltage ranges are identical between the respective phases or lines (the current/voltage ranges are set in common between the respective channels).

Measured Frequency Range

45 to 65 Hz

Wiring Methods

DU400-12: Single-phase two-wire

DU400-22: Single-phase two-wire, single-phase three-wire, three-phase three-wire (dual-voltage, dual-current), three-phase three-wire (triple-voltage, triple-current) and three-phase four-wire

Measured Data Items

For each module, a maximum of six data items can be selected from the effective voltage, effective current, active power, apparent power, reactive power, frequency, power factor and phase angle. The selected data items can then be assigned to channel numbers xx1 to xx6 to show them on the display as well as record them. Restrictions apply to the combination of selectable data items, however, depending on the method of input wiring.

Conditions of Measurement

- Measuring range for current and voltage inputs
10% of the measuring range < current and voltage inputs ≤ 100% of the measuring range
- V1 range is monitored in frequency measurement
- All measurements are done relative to the frequency on a channel for V1 and, therefore, the results of measurements are not guaranteed if the V1 input is out of the range noted above.
- If the input apparent power falls below 10% of the span, the DR recorder cannot measure the phase and power factor (negative overflow).
- A maximum of two scans' worth of data become invalid immediately after a change has been made to the measuring range and/or wiring.

Measuring Accuracy and Resolution

As described below, under the following operating conditions:

Ambient temperature: 23 ±2°C; ambient humidity: 55 ±10% RH; power supply voltage: 90 to 250 VAC (AC power supply) or 10 to 32 VDC (DC power supply)/90 to 132/80 to 250 VAC (when /P6 option is specified); power supply frequency: 50/60Hz within ±1%; warm-up time 30 minutes or more; vibrations and others not affecting instrument operation.

However, RTD input is not available with the DCV/TC/DI input module

Measured Data Item	Measuring Accuracy	Resolution
Effective voltage	± (0.5% of SPAN)	0.01 Vrms (for 25-V range), 0.1 Vrms (for 250-V range)
Effective current	± (0.5% of SPAN)	0.0001 Arms (for 0.5-A range), 0.001 Arms (for 5-A range)
Active power	± (1% of SPAN) $\phi = 0$ ± (2.5% of SPAN) $0 < \phi \leq 30$ ± (5% of SPAN) $30 < \phi \leq 80$	0.01 W (for 12.5-W, 25-W and 37.5-W spans) 0.1 W (for 125-W, 250-W and 375-W spans) 1 W (for 1,250-W, 2,500-W and 3,750-W spans)
Apparent power	± (1% of SPAN) $0 \leq \phi \leq 80$	0.01 VA (for 12.5-VA, 25-VA and 37.5-VA spans) 0.1 VA (for 125-VA, 250-VA and 375-VA spans) 1 VA (for 1,250-VA, 2,500-VA and 3,750-VA spans)
Reactive power	± (5% of SPAN) $0 \leq \phi < 60$ ± (2.5% of SPAN) $60 \leq \phi \leq 80$	0.01 Var (for 12.5-Var, 25-Var and 37.5-Var spans) 0.1 Var (for 125-Var, 250-Var and 375-Var spans) 1 Var (for 1,250-Var, 2,500-Var and 3,750-Var spans)
Frequency	±0.1Hz	0.01Hz
Power factor	± (2% of SPAN) $0 \leq \phi \leq 80$	0.01
Phase angle	±5deg $0 \leq \phi \leq 80$	0.1deg

Measuring Ranges

Measured Data Item	25 V-0.5A	25 V-5 A	250 V-0.5 A	250 V-5 A
Effective voltage Vi (i = 1, 2, 3, 13, 0)	0.00 to 25.00 V rms	0.00 to 25.00 V rms	0.0 to 250.0 V rms	0.0 to 250.0 V rms
Effective current Ii (i = 1, 2, 3, 13, 0)	0.0000 to 0.5000 A rms	0.000 to 5.000 A rms	0.0000 to 0.5000 A rms	0.000 to 5.000 A rms
Active power P1, P2, P3	-12.50 to 12.50 W	-125.0 to 125.0 W	-125.0 to 125.0 W	-1250 to 1250 W
Active power P13	-25.00 to 25.00 W	-250.0 to 250.0 W	-250.0 to 250.0 W	-2500 to 2500 W
Active power P0	-37.50 to 37.50 W	-375.0 to 375.0 W	-375.0 to 375.0 W	-3750 to 3750 W
Apparent power VA1, VA2, VA3	0.00 to 12.50 VA	0.0 to 125.0 VA	0.0 to 125.0 VA	0 to 1250 VA
Apparent power VA13	0.00 to 25.00 VA	0.0 to 250.0 VA	0.0 to 250.0 VA	0 to 2500 VA
Apparent power VA0	0.00 to 37.50 VA	0.0 to 375.0 VA	0.0 to 375.0 VA	0 to 3750 VA
Reactive power Var1, Var2, Var3	0.00 to 12.50 Var	0.0 to 125.0 Var	0.0 to 125.0 Var	0 to 1250 Var
Reactive power Var13	0.00 to 25.00 Var	0.0 to 250.0 Var	0.0 to 250.0 Var	0 to 2500 Var
Reactive power Var0	0.00 to 37.50 Var	0.0 to 375.0 Var	0.0 to 375.0 Var	0 to 3750 Var
Power factor PFi (i = 1, 2, 3, 13, 0)	-1.00 to 1.00	-1.00 to 1.00	-1.00 to 1.00	-1.00 to 1.00
Phase PHi (i = 1, 2, 3, 13, 0)	-80.0 to 80.0 deg	-80.0 to 80.0 deg	-80.0 to 80.0 deg	-80.0 to 80.0 deg
Frequency FREQ	45.00 to 65.00 Hz	45.00 to 65.00 Hz	45.00 to 65.00 Hz	45.00 to 65.00 Hz

Ranges of Indication

Measured Data Item	25 V-0.5A	25 V-5 A	250 V-0.5 A	250 V-5 A
Effective voltage Vi (i = 1, 2, 3, 13, 0)	0.00 to 26.25 V rms	0.00 to 26.25 V rms	0.0 to 262.5 V rms	0.0 to 262.5 V rms
Effective current Ii (i = 1, 2, 3, 13, 0)	0.0000 to 0.5250 A rms	0.000 to 5.250 A rms	0.0000 to 0.5250 A rms	0.000 to 5.250 A rms
Active power P1, P2, P3	-13.75 to 13.75 W	-137.5 to 137.5 W	-137.5 to 137.5 W	-1375 to 1375 W
Active power P13	-27.50 to 27.50 W	-275.0 to 275.0 W	-275.0 to 275.0 W	-2750 to 2750 W
Active power P0	-41.25 to 41.25 W	-412.5 to 412.5 W	-412.5 to 412.5 W	-4125 to 4125 W
Apparent power VA1, VA2, VA3	0.00 to 13.75 VA	0.0 to 137.5 VA	0.0 to 137.5 VA	0 to 1375 VA
Apparent power VA13	0.00 to 27.50 VA	0.0 to 275.0 VA	0.0 to 275.0 VA	0 to 2750 VA
Apparent power VA0	0.00 to 41.25 VA	0.0 to 412.5 VA	0.0 to 412.5 VA	0 to 4125 VA
Reactive power Var1, Var2, Var3	0.00 to 13.75 Var	0.0 to 137.5 Var	0.0 to 137.5 Var	0 to 1375 Var
Reactive power Var13	0.00 to 27.50 Var	0.0 to 275.0 Var	0.0 to 275.0 Var	0 to 2750 Var
Reactive power Var0	0.00 to 41.25 Var	0.0 to 412.5 Var	0.0 to 412.5 Var	0 to 4125 Var
Power factor PFi (i = 1, 2, 3, 13, 0)	-1.00 to 1.00	-1.00 to 1.00	-1.00 to 1.00	-1.00 to 1.00
Phase PHi (i = 1, 2, 3, 13, 0)	-89.0 to 89.0 deg	-89.0 to 89.0 deg	-89.0 to 89.0 deg	-89.0 to 89.0 deg
Frequency FREQ	41.00 to 69.00 Hz	41.00 to 69.00 Hz	41.00 to 69.00 Hz	41.00 to 69.00 Hz

14.1 Specifications of DR130/DR231/DR241 (Style S3)

Output Data Items of Each Wiring Method

Output Data Item	Single-phase Two-wire	Single-phase Three-wire	Three-phase Three-wire (Dual-voltage, Dual-current)	Three-phase Three-wire (Triple-voltage, Triple-current)	Three-phase Four-wire
Effective voltage V	V1	V1, V3 V13: (V1+V3)/2	V1, V3 V13: (V1+V3)/2	V1, V2, V3 V13: (V1+V3)/2 V0: (V1+V2+V3)/3	V1, V2, V3 V0: (V1+V2+V3)/3
Effective current I	I1	I1, I3 I13: (I1+I3)/2	I1, I3 I13: (I1+I3)/2	I1, I2, I3 I13: (I1+I3)/2 I0: (I1+I2+I3)/3	I1, I2, I3 I0: (I1+I2+I3)/3
Active power W	P1	P1, P3 P13: P1+P3	P1, P3 P13: P1+P3	P1, P2, P3 P13: P1+P3	P1, P2, P3 P0: P1+I2+P3
Apparent power VA	VA1	VA1, VA3 VA13: VA1+VA3	VA1, VA3 VA13: VA1+VA3	VA1, VA2, VA3 VA13: VA1+VA3	VA1, VA2, VA3 VA0: VA1+VA2+VA3
Reactive power Var	Var1	Var1, Var3 Var13: Var1+Var3	Var1, Var3 Var13: Var1+Var3	Var1, Var2, Var3 Var13: Var1+VA3	Var1, Var2, Var3 Var0: Var1+Var2+Var3
Frequency FREQ	FREQ	FREQ	FREQ	FREQ	FREQ
Power factor PF	PF1	PF1, PF3 PF13	PF1, PF3 PF13	PF1, PF2, PF3 PF13	PF1, PF2, PF3 PF0
Phase angle PH	PH1	PH1, PH3 PH13	PH1, PH3 PH13	PH1, PH2, PH3 PH13	PH1, PH2, PH3 PH0

Continuously Applicable Maximum Voltage and Current

Voltage: 250 Vrms

Current: 5 Arms

Crest Factor

3 maximum (600 Vpeak)

Maximum Common Mode Voltage

250 Vrms

Common Mode Voltage Rejection Ratio (Voltage and Current Ranges)

0.02% of span (when 250 V, 45 to 65 Hz is imposed)

Input Resistance

Voltage input: 300 kΩ minimum for AC voltages

Current input: 1 Ω maximum for AC currents

Filter

Moving average

Wattage Calculation

Use of /M1 computing function

Insulation Resistance

Across output terminals and ground: 100 MΩ minimum

Withstanding Voltage

Across output terminals and ground: 2,300 V AC (50/60 Hz), 1 min

Recording

Recording method

Raster scan method, 10-color wire trend recording

Number of recording points

Measurement results: Max.30 points

Recording paper

DR130

Ordinary recording chart, Z-fold chart (total width 230.0mm, length 20m)

Effective recording width: 150mm (for trend recording)

DR231/DR241

Ordinary recording chart, Z-fold chart (total width 342.5mm, length 30m)

Effective recording width: 250mm (for trend recording)

Recording colors

Analog trend mode

Trend recording: purple, red, green, blue, brown, black, navy blue, yellowish green, red-purple, orange (can be specified for each channel)

Digital printout: black

Alarm printout: red (however, alarm release mark: blue)

Logging mode

purple

Recording accuracy

DR130

Trend recording: $\pm(0.2\%$ of recording span + measurement accuracy)

DR231/DR241

Trend recording: $\pm(0.1\%$ of recording span + measurement accuracy)

Max. recording resolution

Trend recording: $\pm 0.1\text{mm}$

Recording interval

Recording interval for analog trend recording:

FIX: Min2s, and same as measurement interval

AUTO: Min 2s, and Linked to measurement interval and chart speed

Digital printout interval for analog trend recording:

MULTIPLE: Specify for each channel from 6 kinds of intervals

SINGLE: Determined automatically from the chart speed and the number of channels used to print digital values.

Digital value printing interval in the logging mode:

MULTIPLE: Specify for each channel from 6 kinds of intervals

SINGLE: Common to all points

Recording interval change: 2 kinds; changes by event/action function

Recording modes

Analog trend mode and logging mode

Chart paper feed

chart speed: 1 to 1500 mm/hour

chart speed change: 2 kinds; changes by event/action function

chart feed method: by pulse motor

chart feed accuracy: $\pm 0.1\%$ of length (when recording is performed continuously for at least 1000mm; does not include elongation or shrinkage of paper)

Recording start/stop

Usually starting and stopping of recording is done by means of key operation. However, this can also be done by the event/action function.

Normal recording

Trend recording on alarm occurrence: trigger/level

Group trend recording

Auxiliary printing functions

During analog trend recording and logging, setting information and comments will be printed.

Chart speed (mm/hour) \times trend recording interval must not exceed 3000.

Printout items: Engineering unit, channel number/TAG, alarm, scale, title, message

Event/Action function

Recording can be started, or the chart speed changed by alarm output status/remote control signal/chart end signal/timer or key operation.

Relation between the chart speed and recording interval (analog trend mode)

however, chart speed (mm/hour) \times trend recording interval must not exceed 3000.

Chart speed	Channel No./TAG	Digital print out	Alarm/scale/message
1 to 9mm/h	Record enabled	Record disabled	Record enabled
10 to 1500mm/h	Record enabled	Record enabled	Record enabled

Recording interval for digital printout and chart speed

When the recording interval is SINGLE

however, chart speed (mm/hour) × trend recording interval must not exceed 3000.

Unit : hour

Chart speed	Number of digital print rows*			
	1 row	2 row	3 row	4 row
10 to 24mm/h	12	6	4	3
25 to 49mm/h	4	2	2	1
50 to 99mm/h	2	1	1	1
100 to 1500mm/h	1	1	1	1

* Three- and four-row digital printing is available only with the DR231/241.

When the recording interval is MULTIPLE

Set by timer.

Other functions

Manual printout: One scan's worth of data can be digitally printed by a key operation or event/action function.

Zone recording: Recording width and recording positions (0% and 100% positions) can be set in mm units for each channel in case of trend recording.

Partial compression: A part of the amplitude can be compressed in case of trend recording (only one boundary).

Display

Display method

VFD (5 × 7 dot matrix, 3 rows)

Number of characters

Main display: 22 large characters (1 row); Sub-display 1 and 2: 40 small characters (2 rows)

Displayed contents

Digital value display: data for freely selected channels can be displayed on each row (1 channel per line, max. 5 rows); channel No. or tag (up to 7 characters); alarm search; measurement values; engineering unit

Bargraph display: measurement values of the main display are displayed as a bargraph

Auxiliary data: clock, alarm status, relay status, key-lock ON/OFF, recorder operation

Alarms

Number of settings

Up to four alarms can be set for each channel.

Kind of alarms: selection from higher limit, lower limit, difference higher limit, difference lower limit, higher limit on rate of change, lower limit on rate of change. However, only upper limit and lower limit alarms are output for totalized results.

Rate of change alarm time interval: Can be set to measurement interval × 1 to 15 (common to both rising and falling limits).

Output mode

Energize/de-energize selection, AND/OR mode selection, and output hold/non-hold selection can be made (common to all channels).

A maximum number of 6 reflash alarm output points can be specified.

Number of alarm output points

Max. 12 (when equipped with both /A4 and /R1 options).

Alarm recording

Analog trend mode: The alarm occurrence/release mark, channel number or tag, kind of alarm and alarm item No. are printed in the right margin.

Logging mode: The kind of alarm is printed when the measured data are recorded.

Alarm display

Alarm status indication: Lights or flashes when an alarm is detected;

Alarm acknowledge indication: Indicator stops flashing by key operation.

Standard Computation Functions

Kinds of computation

Difference between channels, linear scaling (scaling) and moving average.

Scaling

Scalable range: DC voltage, TC, RTD, contact

Scaling range: -30000 to +30000

Measurement accuracy for scaling: measurement accuracy for scaling (digits) = measurement accuracy (digits) \times scaling span (digits) / measurement span (digits) + 2 digits. Numbers below the decimal point are discarded.

(Example)

Measurement accuracy when the following settings are made:

Measuring range: 6 VDC, Measurement span: 1.000 to 5.000 V, Scaling span: 0.000 to 2.000,

Measured value: 5 V

$\pm(0.05 \times 5 + 2) \times 2000/4000 + 2 = \pm/3.125$

Measurement accuracy = $\pm/4$ digits = $\pm/0.004$ V

Moving average

Moving average results for between 2 to 64 scans are computed.

Data Save/Load Function

Media for data save/load

Buffer memory (internal SRAM)

Capacity: 512 KB

Data backup: Around 10 years (backup with lithium battery, at room temperature while power is off)

Specified data length: 10, 20, 30, 40, 50, 100, 200, 300, 400, 500, 1k, 2k, 3k, 4k, 5k, 10k, 20k, 30k, 40k, and 50k data/ch (Total memory length must be within the free memory size.)

3.5-inch floppy disk

Number of drives: 1

Disk types: 2HD, 2DD

Supported formats: 1.2 MB, 1.44 MB, and 720 KB

Applicable data

Setting values, measured values, and computed values (only possible when optional math function is specified)

Method to save to the floppy disk

Copies data stored in the buffer memory to the floppy disk, except for setting values which can be directly saved to the floppy disk.

Method to load from floppy disk

Copies data from the floppy disk to the buffer memory except for setting values which can be directly loaded from the floppy disk.

Printing and outputting loaded data

Able to print captured data saved in the buffer memory or output to a communication interface.

Data save format

Setting values: ASCII

Measured/computed values: binary (except ASCII (CSV Format) is also possible when saving to floppy disk.)

Data capacity

Setting values

DR130 : Maximum about 42 KB (in case when saving the setting values of an operation mode with 30ch inputs and 30ch computations.)

DR231/DR241 : Maximum about 50 KB (in case when saving the setting values of an operation mode with 30ch inputs and 30ch computations.)

Measured values

Binary data: 2 bytes / 1 data

ASCII data: 12bytes / 1 data

Computed values

Binary data: 4 bytes / 1 data

ASCII data: 12 bytes / 1 data

Equation to calculate the total data capacity

$256 + 64 \times (\text{number of measured ch} + \text{number of computation ch}) + (\text{number of measured ch} \times 2 + \text{number of computation ch} \times 4 + 6) \times \text{specified data length}$

Save interval of measured/computed values

Measurement interval of the recorder, or select from 1 min/2 min/5 min/10 min (By combining with the event/action function, it can also sample 1 data at a time e.g. at each M.FUNC key or remote control signal input.)

Selection of the saving method of measured/computed values (WRITE MODE)

Direct: Start saving the data when key operation occurs. After saving specified length of data, stop the saving process.

Trigger single: Start saving the data when the trigger condition is met.

After saving a specified length of data, stop the saving process.

Trigger repeat: Start saving the data when the trigger condition is met. Repeat the process of saving a specified length of data to 1 file, until there is no more area in the memory.

Trigger condition

All Trigger conditions are configured with the event/action function.

Trigger condition when saving the measured/computed values: Event/action function (such as key operation, remote control signal, alarm status, and chartend)

Trigger condition when loading the measured/computed values (from buffer memory): Event/action function (such as key operation, remote control signal, and alarm status)

Pretrigger: 0 to 100% (can be specified in 10% intervals)

Filename when saving data

8 ASCII characters input. However, when saving the measured/computed values using trigger repeat, 5 ASCII characters input (last 3 letters are set automatically from 001 to 208.)

Optional Math Function

Computation types

Types: Four arithmetical operations, SQR(square root), ABS(absolute value), LOG(common logarithm), LN(natural logarithm), EXP(exponent), statistical computation*, logical computation (AND, OR, NOT, and XOR), relational computation, exponentiation, previously-measured value reference, hold**, and reset

* Statistical computation

CLOG: Computation process of simultaneously measured values within a group (total, maximum, minimum, average, and maximum - minimum)

TLOG: Computation process of a specific channel over time axis (total, maximum, minimum, average, and maximum - minimum)

Statistical computation interval: Set by the event/action function

**Hold

Temporary suspending of computation and temporary hold of the computed result

During statistical computation, resume the computation from the hold point after the hold is released.

Number of channels for computing (Number of channels that can be allocated for computational purposes.)

: 30ch maximum

Computation interval

Every measurement interval (except when the computation becomes too difficult to be processed every measured interval, in which case an alarm is generated)

Significant digits during computation

$\pm 10^{308}$

Significant digits of the computed result

-9,999,999 to +99,999,999 (Decimal point can be set to have 1 to 4 digits on the right of the decimal point)

Input from communication interface

Digital value (ASCII numerical array) input from the communication interface can be handled as computational data

Computation start/stop

Can be controlled by communication commands, M.FUNC key operation, and event/action function (such as FUNC key operation, remote control signal, timespecified, and alarm status)

Other functions included in the math function: Remote RJC

Input type: Thermocouple (TC)

Accuracy: (Twice the measurement accuracy of the standard thermocouple input) + (temperature difference between the terminal of the remote terminal section and thermocouple section for measuring the remote terminal temperature)

Thermocouple burnout: not selectable

Communication Function

Communication interface is possible by GP-IB, RS-232-C, RS-422-A or RS-485.

Report Function (feature of the suffix code /M3; available with models with style number 5 or higher)

Report Channels

60 channels, from R01 to R60 (DR231/DR232)

30 channels, from R01 to R30 (DR130)

Types of Reports

Hourly report: Hourly (every hour) statistical information

Daily report: Statistical information for a day (starting at a specified time)

Monthly report: Statistical information for a month (starting at a specified date and time)

These types of report making can be turned on or off separately.

Output of the Results of Computing for Reports

The DR recorder prints the results on a recording chart or send them to a report output.

Output Formats of the Results of Computing for Reports

Hourly report: Standard format

Daily report: Standard format or enhanced format

Standard format: results of computing daily reports

Enhanced format: results of computing daily reports plus results of computing hourly reports*

Monthly report: Standard format or enhanced format

Standard format: results of computing monthly reports

Enhanced format: results of computing monthly reports plus results of computing daily reports*

The enhanced format applies to either daily reports or monthly reports only.

*: Either the average, instantaneous value or sum in each computing of a report.

Types of Computing for Reports

AVE: Average, maximum and minimum over a preset interval

INST: Instantaneous value at the time of report making

SUM: Sum and cumulative sum over a preset interval

	Sum	Cumulative Sum
Hourly report	Hourly sum	Sum over 24 hours (resets at the time to make up a daily report)
Daily report	Daily sum	Sum over a month (resets at the time to make up a monthly report)
Monthly report	Monthly sum	Not applicable

Unit Conversion (SUM only)

When inputs over a unit of time are integrated, the unit conversion compensates for any discrepancy in the unit of value arising between computed values depending on the measurement interval applied.

INTVL: no conversion; Σ (results of computing)

/sec: converted to the sum of input in seconds; Σ (results of computing) \times measurement interval

/min: converted to the sum of input in minutes; Σ (results of computing) \times measurement interval/60

/hour: converted to the sum of input in hours; Σ (results of computing) \times measurement interval/3600

/day: converted to the sum of input in days; Σ (results of computing) \times measurement interval/86400

Time to Make Report

Reference dates: 1st to 28th days of a month

Reference times: 00:00 to 23:00

Output Ranges of the Results of Computing for Reports

AVE: -9999999 to 99999999 (with the position of the decimal point dependent on the measurement and computing channels assigned as report channels)

INST: -9999999 to 99999999 (with the position of the decimal point dependent on the measurement and computing channels assigned as report channels)

SUM: seven digits for the mantissa and two digits for the exponent

Processing of Faulty Data

AVE: Faulty data are excluded from computing. Data of positive and negative overflows, however, are included in the computing of the maximum and minimum.

INST: Faulty data are included in computing.

SUM: Faulty data are excluded from computing.

Information on and Process in Case of Power Failure

- The DR recorder adds × to the time on a printout provided upon recovery from a power failure. It does not print the character, however, if it has been more than 12 hours since the power failure occurred.
- The DR recorder excludes data occurring during a power failure from its reports.
- If the DR recorder recovers from a power failure after the time to make a report, it makes a report immediately after the recovery.
- In an application where the REPORT PRINT menu item is set to on for automatic printing, the DR recorder prints a report only immediately after it recovers from a power failure if the power failure time is less than 12 hours and the recorder has recovered after the preset time for report printing.
- In an application where the REPORT PRINT menu item is set to on for automatic printing, the DR recorder prints a report at the scheduled time for report printing if a power failure time is less than 12 hours and the recorder has recovered before the preset time for report printing.
- If a power failure time is longer than 12 hours, the DR recorder stops report making even if the power is restored.
The recorder prints a report (for data acquired up to the power failure), however, immediately after it recovers from the power failure.
- If a power failure time is longer than 12 hours, the DR recorder does not print a report even if the menu item for automatic printing is set to on. In that case, you can print a report from the FUNC menu or send data to a communication output.

Time Intervals for Printing

Type of Report	Printing Format	Number of Columns	Chart Length	Printing Time
Hourly report	Standard	77	20 cm	approximately 4 minutes
Daily report	Standard	77	20 cm	approximately 4 minutes
	Enhanced	437	114 cm	approximately 22 minutes
Monthly report	Standard	77	20 cm	approximately 4 minutes
	Enhanced	542	141 cm	approximately 27 minutes

The printing time is maximum when you print an hourly report and a daily report each in the standard format and a monthly report in the enhanced format, all at the same time.

Required printing time: 4 + 4 + 27 = 35 (minutes)

Format of Output via Communication

Binary

Power Supply

Rated supply voltage

AC power supply: 100 to 240 VAC (freely selected)

DC power supply: 12 to 28 VDC

AC power supply for /P6 option: 100 to 240 VAC (100/200 V auto switch)

Except, if the instrument is operated at 200 V it does not switch back to 100 V. In this case, turn OFF the AC power switch on the back panel, and turn it back ON again.

Permissible supply voltage

AC power supply: 90 to 250 VAC

DC power supply: 10 to 32 VDC

AC power supply for /P6 option: 90 to 132/180 to 250 VAC

Rated supply frequency

50/60 Hz

Power consumption

AC power supply: Max. approx. 130 VA

DC power supply: Max approx. 80 VA

AC power supply for /P6 option: Max. approx. 130 VA

Fuse Ratings

- Main unit

AC power supply:

Maximum rated voltage/current: 250 V/2.5 A, Type: Time-lag, Standard: IEC/VDE

DC power supply:

Maximum rated voltage/current: 250V/6.3A, Type: Time-lag, Standard: IEC/VDE

- In the case at the rear side of the main unit where the input/output module is connected.(The fuse may not be replaced by the customer.)

AC power supply:

Maximum rated voltage/current: 250 V/2 A, Type: Time-lag, Standard: IEC/VDE

DC power supply:

Maximum rated voltage/current: 250V/6.3A, Type: Time-lag, Standard: UL/CSA

AC power supply:

Maximum rated voltage/current: 250V/2.5A, Type: Time-lag, Standard: IEC/VDE

Priority on the use of the AC and DC power supplies on models with the /P6 option (when both AC and DC powers are supplied.)

DC power supply terminal voltage	Power supply input with higher priority
Less than 20 V	AC power supply
20 to 28 V	Indefinite
28 to 32 V	DC power supply

Normal Operating Conditions

Supply voltage

AC power supply: 90 to 250 VAC

DC power supply (in case of DR130/231 with /P6 option or DR241 with -2 power supply cord): 10 to 32 VDC

AC power supply for /P6 option (for DR130/DR231 only): 90 to 132/180 to 250 VAC

Supply frequency

50Hz ±2%, 60Hz ±2%

Ambient temperature

0 to 50°C (5 to 40°C when using floppy disk)

Ambient humidity

20 to 80%RH for 0 to 40°C, 10 to 50%RH for 40 to 50°C (no condensation)

Vibration

10 to 60 Hz, 0.2m/s²

Shock

Not allowed

Magnetic field

400 A/m max. (50/60Hz)

Position

Unit should be positioned left-right horizontally

Installation location

Room

Installation height

Altitude up to 2,000 m

Installation category based on IEC 1010-1

II*1

Pollution degree based on IEC 1010-1

2*2

Warm-up time

At least 30 minutes after power switch-on.

*1Installation category is the specification of the inputs withstanding voltage which is also called as overvoltage category.

*2Pollution degree is the level of foreign body adhesion such as the solid, liquid, and gas which decrease the withstanding voltage, 2 means general indoor atmosphere.

Effect of Operating Conditions

Ambient temperature: Variation for a temperature change of 10°C: within $\pm(0.1\%$ of rdg + 1 digit); $\pm(0.2\%$ of span + 1 digit) for Cu10 Ω

Voltage variation: power supply: within ± 1 digit over the range of 90 to 132, or 180 to 250 VAC (AC power supply, frequency 50/60Hz), 10 to 32 VDC (DC power supply)

External magnetic field: variation with respect to AC (50/60Hz) and DC magnetic fields of 400 A/m: within $\pm (0.1\%$ of rdg + 10 digits) Except for power monitor module: within $\pm 15\%$ of range

Signal source resistance: variation with respect to signal source resistance 1 k Ω change

(1) voltage

2 V range or below: within $\pm 10\mu\text{V}$

6 V range or above: within 0.1% of rdg

(2) thermocouple

within $\pm 10\mu\text{V}$; however it must be within 100 μV when burnout is specified.

(3) RTD

Variation with respect to change of 10 Ω per wire (when all wires have the same resistance value)

Indication: within $\pm(0.1\%$ of rdg + 1 digit)

Variation in indication with respect to a difference of 40m Ω in the resistance between conductors (max. difference between 3 wires): approx. 0.1°C

Mounting position

Variation when the unit is mounted horizontally on a panel: within $\pm(0.1\%$ of rdg + 1 digit)

Vibration

Variation when sinusoidal vibration of acceleration 0.2m/s² is applied for two hours in each of the 3 axial directions over a frequency range of 10 to 60Hz: within $\pm(0.1\%$ of rdg + 1 digit)

Transportation and Storage Conditions

These refer to the environmental conditions existing during transportation and storage from the time of shipment from the factory until commencement of use, and also during transportation and storage in the case of a temporary period of non-use.

If the environmental conditions are specified within the specified range, the unit will not incur permanent damage, and can be returned to a normal working condition (although re-adjustment may be required in some cases).

Ambient temperature

-25 to 60°C (-20 to 60°C with floppy disk drive)

Humidity

5 to 95% RH

Vibration

10 to 60Hz 4.9m/s² max

Shock

392 m/s² max (in packed condition)

General Specifications

EMC Conformity Standard

- Emission EN55011:Class A
- Immunity EN50082-2

IEC1000-4-2	Electrostatic Discharge 8kV(Air), 4kV(Contact)	Performance Criteria A*
IEC1000-4-3	Radiated fields 80~1000MHz, 10V/m	Performance Criteria A*
IEC1000-4-4	Fast Transients Power line 2kV, The others 1kV	Performance Criteria B
IEC1000-4-6	Conducted Disturbance 0.15~80MHz, 10V	Performance Criteria A*

*Effect on accuracy
 ±10% of range (except for 50V range)
 ±20% of range (50V range)
 When the extender module is used:
 ±20% of range (except for 50V range)
 ±40% of range (50V range)

Installation

Desk-top type: DR130/DR231
 Panel-mount type: DR241

Regardless of which installation method you use, be sure to install the units in an upright position.

Materials

Steel plate, aluminium plate, plastic moldings

Color

Display: Slate Gray light (equivalent to Munsell 0.1 PB 4.6/0.2)
 DR130/DR231 main unit: Lamp Black (equivalent to Munsell 0.8 Y 2.5/0.4)
 DR241 main unit: Ice White (equivalent to Munsell 6.6 Y 7.9/0.5)

External dimensions

DR130 : approx. 338 (W) × 221 (H) × 335 (D) mm
 DR130 (with /P6 option) : approx. 338 (W) × 221 (H) × 381 (D) mm
 DR231: approx. 438 (W) × 291 (H) × 336 (D) mm
 DR231 (with /P6 option) : approx. 438 (W) × 291 (H) × 381 (D) mm
 DR241: approx. 444 (W) × 288 (H) × 343 (D) mm

Weight

DR130: approx. 9.3kg^{*1}, 10.8kg^{*3}
 DR231: approx. 13kg^{*2}, 14.5kg^{*3}
 DR241: approx. 16kg^{*2}

- *1 with 20 input channels and alarm output (/A4) installed
- *2 with 30 input channels and alarm output (/A4) installed
- *3 with /P6 option

Clock

with calendar function

Clock accuracy

±100ppm. However, this does not include the delay (less than 1 second) caused when the power is switched ON and OFF once.

Fail Output

Contact output (when /R1 option is selected)

Set value backup

Lithium battery backup (approx. 10 years, at ambient temperature of 23°C)

Insulation resistance

At least 20MΩ between the power supply and ground, between each terminal and ground, and between each input terminal (measured with 500 VDC)

Dielectric Strength

Between power supply terminal and ground of DR130/DR231/DR241 main unit: 1500 VAC (50/60Hz) for one minute, Between input terminal and ground of DR130/DR231/DR241 main unit: 1500 VAC (50/60Hz) for one minute, Between output terminal and ground of DR130/DR231/DR241 main unit: 2300 VAC (50/60Hz) for one minute, Between DC power supply terminal and ground of DR130/DR231 main unit: 500 VAC (50/60Hz) for one minute (with /P6 option), Between DC power supply terminal and ground of DR241 main unit: 1000 VAC (50/60Hz) for one minute (in case of power supply code -2).

14.2 Specifications of Optional Functions

GP-IB Communication (when equipped with /C1)

Electrical and mechanical specifications

conform to IEEE Standard 488-1978

Code

ISO (ASCII) code

Address

0 to 15

Functions

- Talker functions
Output of measurement values (ASCII, binary); output of setting parameters (ASCII)
- Listener functions
Setting of measurement conditions, controls of starting and stopping measurement, specifying causes of interrupts (excluding setting and control of power ON/OFF)

Causes of interrupts

Syntax error, chart end, completion of A/D conversion, operations of internal timer, end of data saving/reading, incomplete measurement during computation

RS-232-C Communication (when equipped with /C2)

Electrical and mechanical specifications

conform to standard EIA RS-232-C

Connection method

point-to-point

Communication method

half-duplex

Synchronization mode

Start-stop synchronization (synchronized by a start and a stop bit)

Baud rate

150, 300, 600, 1200, 2400, 4800, 9600, 19200, 38400 bps

Start bit

Fixed at 1 bit

Data length

7 or 8 bits, selectable

Parity

Selectable from even, odd, or none

Stop bit

1 or 2, selectable

Transmission distance

max. 15 m

Connector

D-sub 25pin

Handshake

hardware : transmission and reception control by 'DTR' 'RTS', 'CTS' signal enabled.

Software : transmission control by 'XON' and 'XOFF' enabled.

Capacity of receiving buffer

200 bytes

Escape sequence

for reception only

Functions

- Talker functions
Output of measurement data (ASCII, binary) and setting parameters (ASCII)
- Listener functions
Setting of measurement conditions, control of measurement start and stop (excluding the setting and control of power on/off), specifying causes of 'ESC S' (output of a status byte)

Contents of 'status'

Syntax error, chart end, completion of A/D conversion, operations of internal timer, end of data saving/reading, incomplete measurement during computation

RS-422-A/RS-485 Communication (when equipped with /C3)**Electrical & mechanical specs**

Conform to the EIA RS-422-A and EIA RS-485 Standard

Connection format

Multi-drop 1:n (n=16 for RS-422-A, n=31 for RS-485)

Communication format

Half duplex

Synchronizing format

Start-stop asynchronous transmission (synchronized by start/stop bit)

Baud rate (bps)

300, 600, 1200, 2400, 4800, 9600, 19200, 38400 (selectable)

START bit

1 bit (fixed)

Data length

Either 7 or 8 bits (selectable)

Parity

Even, Odd, or None (selectable)

STOP bit

Either 1 or 2 bits (selectable)

Connector

6 point screw type terminal (uses M4 screws)

Minimum response time

0, 10, 20, 50 or 100 ms (selectable)

Reception buffer length

250 bytes

Escape sequence

Trigger, Status call, Open and Close

Electrical characteristics

SDA, SDB, RDA, RDB, SG. Between the signal terminal and the main internal circuit is insulated functionally.

Communication distance

1.2 km maximum

Terminator

Internal resistor (120 ohm, 1W) switch with the slide switch

Ethernet (when equipped with /C7)**Electrical and Mechanical specifications**

Conforms to IEEE802.3 (Frames are not supported.)

Communication method

Ethernet

Transmission specifications

10BASE-T (CSMA/CD, 10 Mbps, Baseband)

Transmission speed

10 Mbps

Protocols

TCP, IP, UDP, ARP, ICMP

Maximum number of connections

4

Input data

ASCII

Supporting RS-232-C commands

Output data

ASCII, Binary

Alarm Output (when equipped with /A4)

Number of outputs

10 points

Output updating rate

every measurement interval

Contact mode

Make contact : normal open/common contact type

Energize/de-energize

switchable

Hold/non-hold

switchable

Reflash alarm

up to 6 contacts can be specified.

Contact rating

250V DC/0.1A (resistive load)

250V AC/2A (resistive load)

30V DC/2A (resistive load)

Dielectric strength

Between the output terminal and ground: 2300V AC (50/60Hz) for one minute.

Alarm Output using DI/DO (when equipped with /R1)

Number of outputs

2 points

Output updating rate

every measurement interval

Contact mode

Transfer contact : normal open/common/normal close type

Energize/de-energize

switchable

Hold/non-hold

switchable

Reflash alarm

can be set

Contact rating

250V DC/0.1A (resistive load)

250V AC/2A (resistive load)

30V DC/2A (resistive load)

Dielectric Strength

Between the output terminal and ground: 2300V AC (50/60Hz) for one minute.

Failure Output using DI/DO (when equipped with /R1)

Function

The output relay for a failure becomes de-energized when an error is detected in this instrument.

Contact mode

Transfer contact : normal open/common/normal close type

Energize/de-energize

not switchable

Contact rating

250V DC/0.1A (resistive load)

250V AC/2A (resistive load)

30V DC/2A (resistive load)

Dielectric Strength

Between the output terminal and ground: 2300V AC (50/60Hz) for one minute.

Chart-end Output using DI/DO (when equipped with /R1)**Function**

The output relay for chart-end becomes energized when the recorder runs out of chart paper.

Contact mode

Transfer contact : normal open/common/normal close type

Energize/de-energize

not switchable

Contact rating

250V DC/0.1A (resistive load)

250V AC/2A (resistive load)

30V DC/2A (resistive load)

Dielectric Strength

Between the output terminal and ground: 2300V AC (50/60Hz) for one minute.

Remote control of recorder functions using DI/DO (when equipped with /R1)**Function**

The following functions can be controlled by contact input:

- alarm acknowledge;
- alarm reset;
- timer reset;
- starting/stopping recording;
- manual printout;
- digital printout;
- message printout;
- message display;
- changing chart speed/recording interval;
- group trend recording.

Input signal

No voltage contact, open-collector driven by a TTL or transistor

Rated voltage: 0 to 5 V DC (input impedance: 4.7k Ω , 5 V DC pull up)

Maximum input voltage (allowable range)

-2 to 7 V DC

Input conditions

- ON voltage: 0.5V max. (30mA DC)
- Leakage current at OFF state: 0.25mA max.

Duration of input signal

one second or longer (input signal detection interval: approx. 0.5 seconds)

Dielectric strength

Between the output terminal and ground : 1500V AC (50/60Hz) for one minute.

14.3 Dimensional Drawings

DR130

Number of input channels : 30

Unit : mm

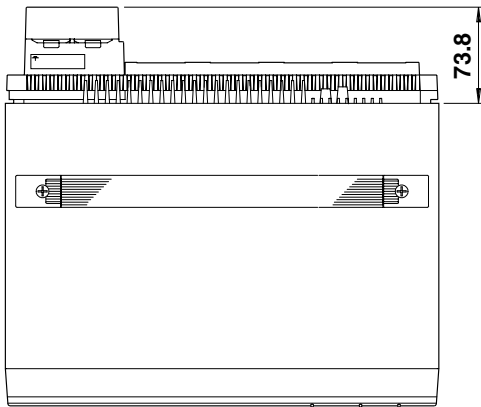

Rear Panel

AC power supply model

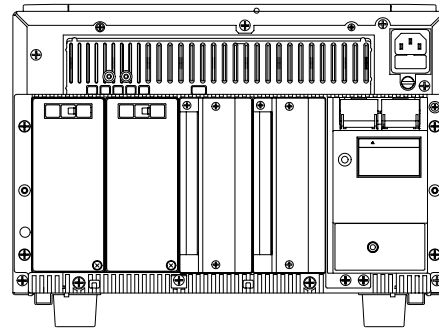

DC power supply model

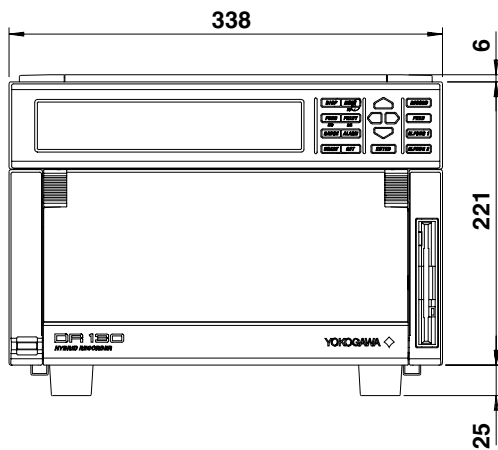
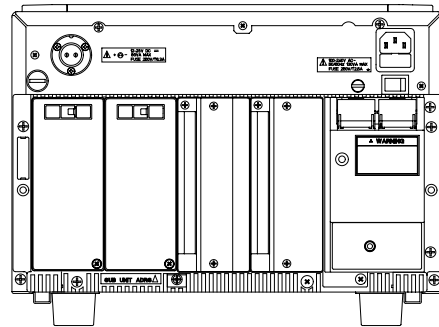

AC power supply model

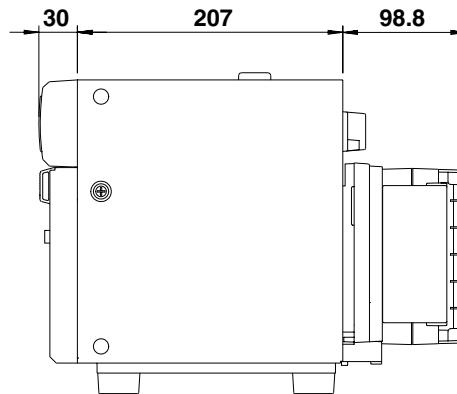

DC power supply model

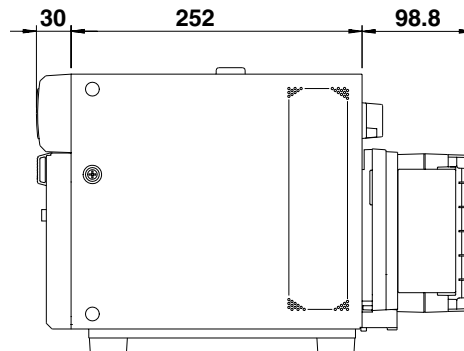

If not specified, the tolerance is $\pm 3\%$. However, in cases of less than 10mm, the tolerance is $\pm 0.3\text{mm}$.

DR231

Unit : mm

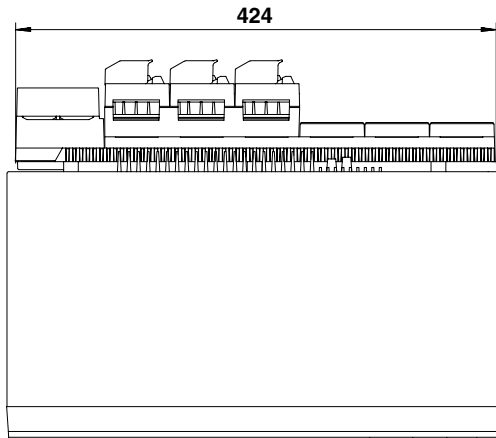

Rear Panel

AC power supply model

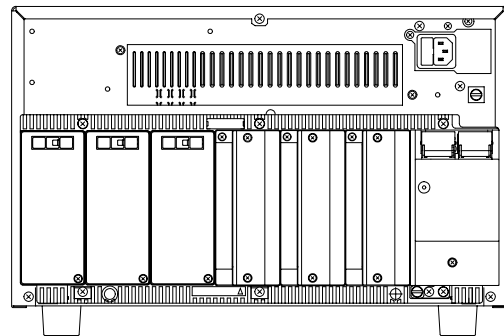

DC power supply model

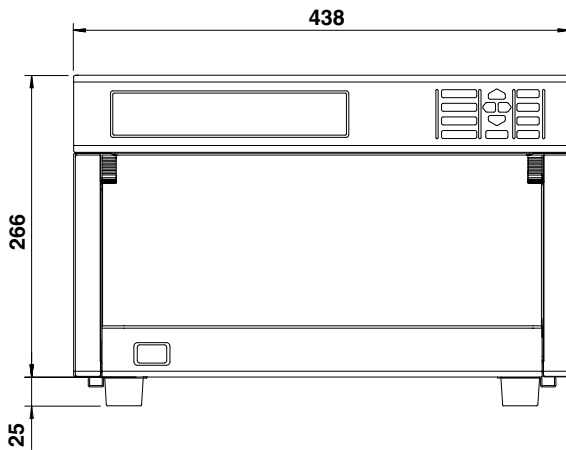
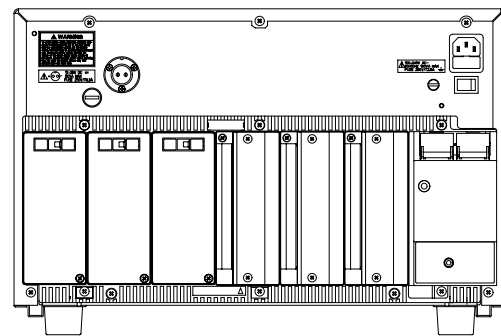

AC power supply model

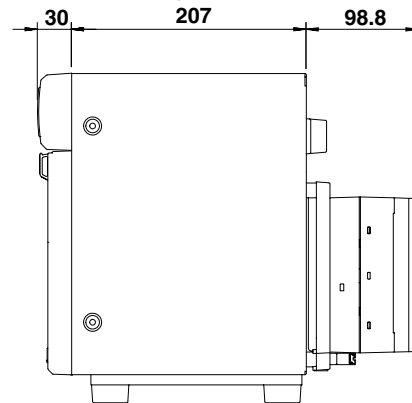

DC power supply model

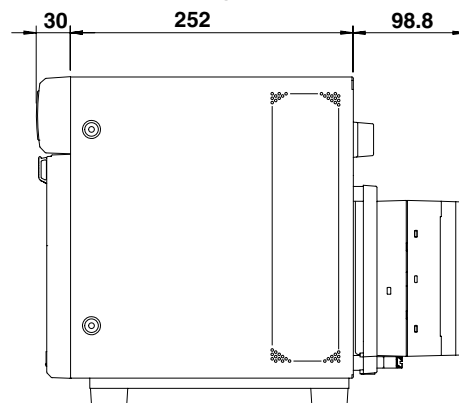

If not specified, the tolerance is $\pm 3\%$. However, in cases of less than 10mm, the tolerance is $\pm 0.3\text{mm}$.

DR241

Number of input channels : 30

Unit : mm

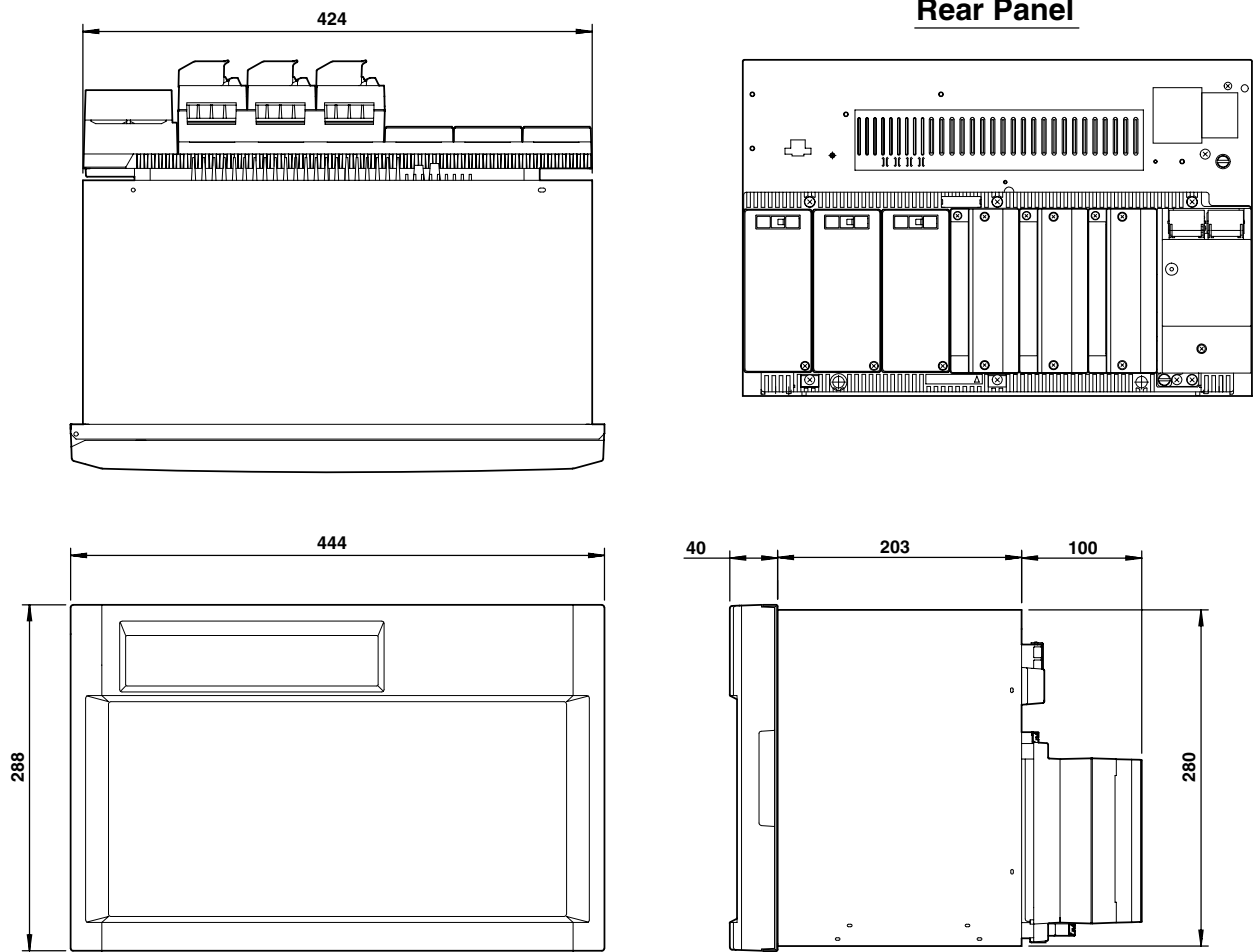

If not specified, the tolerance is $\pm 3\%$. However, in cases of less than 10mm, the tolerance is $\pm 0.3\text{mm}$.

Main Menu

Pressing the relevant key causes a menu (the main menu) to appear in the main display. If the instrument is equipped with a floppy disk drive and option codes /C (or /C2) and /A4 or /R1 and /M1 are set at the factory prior to shipment, the menu will indicate that alarm display hold and relay hold functions are turned on.

● RANGE menu

001-01:VOLT/2V → Selecting the type of input/setting the recording span/setting linear scaling (pages 5-1 and 5-4)

● CHART menu

SET=

CHART → Setting the chart speed (page 6-4)



CLOCK → Setting the date and time (page 3-24)

● PRINT menu

MAN PR START → Starting manual printing (page 7-2)



LIST START → Printing list (page 7-2)



HEADER START → Printing header (page 7-2)

● ALARM menu

001-01:1/OFF → Setting alarms and relays (including internal switches) (page 8-1)

● SET menu

SET=

SYSTEM → Setting the recording mode (page 6-1)



UNIT → Setting the engineering unit (page 6-1)



TREND → Setting the recording channel (page 6-1)



TIMER → Setting the recording interval (timer) (page 6-1)



MATH → Setting computation (chapter 12)



CONST → Setting constant (page 12-7)



MEMORY → Saving/reading data (chapter 11)



FCOPY → Saving/reading set-up data (chapter 11)



LOGIC → Setting event/action functions (page 9-1)



COPY → Copying (page 9-11)

● SET3 menu

SET=

CHART2 → Setting the chart speed (page 6-4)



ZONE → Setting recording zones (page 6-6)



PARTIAL → Setting partially expanded recording (page 6-6)



TAG → Setting tags (page 6-8)



DIGITAL PR → Setting digital printout (page 6-8)



MANUAL PR → Setting manual printout (page 6-8)



ALARM PR → Setting alarm printout (page 6-10)



SCALE PR → Setting scale printout (page 6-12)



LIST PR → Setting list printout (page 6-12)



LIST FMT → Setting list format (page 6-12)



MESSAGE → Entering messages (page 6-14)



HEADER → Entering headers (page 6-14)



TITLE → Entering title (page 6-14)



MATCH TIME → Setting match time (page 6-16)



MOVE AVE → Setting moving average (page 6-16)



INTERPOL → Setting interpolation (page 6-16)



GROUP → Setting groups (page 6-16)

● **FUNC menu**

ALARM ACK → Alarm acknowledgment (page 9-14)



ALARM RST → Alarm reset (page 9-14)



INIT BRANCE → Executing initial balancing (page 5-10)



TIMER RESET → Timer reset (page 9-14)



MATH START → Starting computation (page 12-8)



MATH CLR START → Re-starting computation after clearing computed data (page 12-8)



MATH STOP → Stopping computation (page 12-8)



MATH ACK → Clearing incomplete measurement status indication (page 12-8)



REPORT START → Starting report making (page 10-32)



REPORT STOP → Stopping report making (page 10-32)



REP RECALL START → Starting report printing (page 10-30)



REP PRINT STOP → Stopping report printing (page 10-30)



KEY LOCK ON → Keylock (page 9-14)



MSG PRINT → Starting message printing (page 7-3)

● **FUNC3 menu**

S/U LIST START → Printing set-up lists (page 7-4)



ALM BUF CLEAR → Clearing alarm buffer (page 9-16)



MSG BUF CLEAR → Clearing message buffer (page 9-16)



MODULE INF → Displaying module information (page 9-16)



COMM INF → Displaying communications information (page 9-16)



RE SYSTEM → Structuring system modules (page 9-16)



RAM INIT → Initializing RAM (page 9-16)

● **SET UP menu**

SET UP=



PRN ADJ → Selecting adjustment of dot-printing (page 10-1)



SCAN INTVL → Selecting scan interval (page 10-1)



RECORD → Setting recording format (page 10-3)



MATH → Setting action to be carried out in case of computation error and setting the units for TLOG.SUM (page 12-12)



FLOPPY → Saving/reading set-up data (chapter 11)



REPORT → Setting report format (page 10-27)



ALARM → Selecting alarm interval/hysteresis/hold (page 10-7)



A/D INTG → Selecting A/D converter integration time (page 10-7)



FILTER → Selecting filter (page 10-7)



RELAY → Setting operation mode of relay/internal switch (page 10-9)



BURN OUT → Setting burn-out (page 10-12)



RJC → Setting reference junction compensation (page 10-12)



COLOR → Setting recording colors (page 10-14)



LOCK → Setting keylock (page 10-15)



FUNC PARM → Setting FUNC/FUNC3 menu (page 10-17)



SET PARM → Setting SET/SET3 menu (page 10-20)



DISPLAY → Selecting display update interval (page 10-24)



END → Registering details set/selected with set up menu, and terminating set up menu (page 10-24)

INDEX

[A]

- ABSOLUTE, Absolute time 2-9, 6-3
- Accessories 5
- AC power switch 3-24
- Action 2-18
 - edge 9-9
 - level 9-9
 - setting, selection 9-9, 9-10
- Additional printouts 2-13
- A/D (converter) integration time 2-4, 10-8
- Alarm
 - acknowledgment of 2-16, 9-15
 - Search Display 2-1, 4-7, 4-8
 - Status Display 2-1, 4-10
 - copy *See also* Copying, 9-13
 - clearing buffer 9-17
 - Difference high/low limit 2-14, 8-2
 - high limit, upper-limit 2-14, 8-2
 - low limit, lower-limit 2-14, 8-2
 - occurrence of, occurrence mark
 - See also* Trend recording upon occurrence, 2-6, 2-14 to 2-16
 - output, output relays
 - See also* Alarm module, 2-14 to 2-16, 2-19, 3-18, 4-11, 4-12, 8-3, 9-9, 10-9 to 10-11
 - printing, recording 2-6, 2-7, 2-16
 - rate-of-change, high/low limit of 2-14, 8-2
 - REFLASH, Reflashing 2-15, 10-10
 - release 2-14 to 2-16
 - reset 2-16, 8-4, 9-15
 - setting 6-11, 8-1
 - trend recording upon occurrence 2-10, 10-4
 - type 2-14, 8-2
 - upper-limit, high limit 2-14, 8-2
- Alarm module
 - See also* Alarm output, 3, 3-18, 4-12, 8-3, 9-17
- ALL SKIP 4-2, 4-3
- Ambient temperature and humidity 3-2, 4-13, 4-14
- Analog Trend Mode 2-5, 2-8, 2-16, 6-2, 6-3
- AND/OR 2-15, 10-10
- ASCII conversion 11-18 to 11-20
- Asterisk, for the meaning of excess of alarm or message records
 - 6-11, 7-3
- Attenuation 2-4
- AUTO, for recording interval *See also* Display, 2-9, 6-2
- Averaging *See* Moving average

[B]

- Backup, of set values 14-15
- Bargraph Display 2-1, 4-9
- Basic Setting (SET-UP) Chapter 10
- Baud rate 3-12, 3-13, 14-16, 14-17
- Boundary value, for partial expanded recording 2-11, 6-7
- Buffer
 - Alarm 6-11, 9-17

- Alarm printout 6-11
 - clearing 9-17
- Digital 2-5 to 2-8, 6-9, 7-1, 10-5, 10-6
 - number of columns for 2-8, 10-5
- Engineering unit 2-13, 6-2
- Header 2-13, 6-15, 7-2
- List 2-12, 6-13, 7-2
- Manual 2-13, 7-2, 9-10
- Message 2-13, 6-15, 7-3, 9-10, 9-17
- Message printout 7-3
 - clearing 9-17
- Tag 2-13, 6-9, 10-4
- Title 2-6 to 2-8, 2-13, 6-15
- Scale(d) 2-13
- Burnout 10-13

[C]

- Carriage 3-8, 13-1
- Carrying handle 3, 2-20
- Chart, chart cassette, chart paper 5, 3-6 to 3-10
- Chart end output 2-19, 3-18
- Chart speed 2-5, 2-9, 6-4, 6-5
 - setting/change of 2-5, 6-5, 9-10
- Clamp terminal 3 to 5, 3-17
- Clock 2-1, 4-13
- CODE NUMBER *See* Password
- Component type 1-1, 1-4
- Computation 2-17
- Computation
 - Computation error 12-12, 12-13
 - Operator 12-1
 - Equation 12-1 to 12-6
 - Constant 12-7
 - Starting/stopping/clearing/resetting 12-8, 12-9
- Computed data
 - Saving 11-1 to 11-6
 - Reading 11-7 to 11-10
 - Deleting 11-21
 - Copying 11-16 to 11-20
- Condition 2-2
- Copying, alarm, other items, range 9-12, 9-13
- Crimp-on lugs 3-16

[D]

- Data format 11-6
- Data length 3-12, 3-13
- Data size 11-6, 11-12, 11-19
- DC power supply 3-23
- DC power supply connector 5, 3-23
- DC voltage 2-3, 5-3
- DCV/TC/DI input module 4, 3-17

Deleting a character or numerical
 *See* Inserting/deleting a character or numerical
 Destination channel, for difference between channels 2-17, 5-3
 DI, digital input 5-3
 DI/DO module 4, 3-18
 Difference between channels 2-17, 4-2, 5-3
 Difference high/low limit *See* Alarm
 Digital printout (printing) 2-5 to 2-8, 6-9, 7-1, 10-5, 10-6
 number of columns for 2-8, 10-5
 Display *See also* Functions, 1-2 to 1-4, 4-2, 4-3
 Alarm 4-2, 4-3
 hold function 2-16, 10-8
 information 2-16
 Alarm Search 2-1, 4-7, 4-8
 Alarm Status 2-1, 4-10
 AUTO 2-1, 4-1 to 4-3
 channel 4-2, 4-3
 Clock 2-1, 4-13
 Condition 2-1
 difference between channels 4-2, 5-3
 Main 1-2 to 1-4, 2-1, 4-3
 MANUAL 4-4
 measurement values 4-2, 4-3
 Page, PAGE 2-1, 4-6
 remote/local control status 2-1
 Relay status 2-1, 4-11, 4-12
 Display mode *See* mode
 Display update interval *See* interval
 Dot-printing shift 10-2
 Dot-printing recording system *See also* trend recording, 10-4

[E]

Engineering unit
 display 4-2, 4-3
 Printout of 2-13, 6-2
 Edge action 9-9
 Event, event/action functions 2-18, 9-1 to 9-11
 External input/output 2-19
 External RJC (EXT) *See* RJC

[F]

Fail (failure) output 2-19
 Feed, recording paper 7-1
 Ferrite core 3-11, 3-13, 3-35
 Filter
 Input 2-4, 10-8
 Noise 3-30
 First channel 5-2
 FIX, recording interval 2-9, 6-2
 Floppy disk
 Handling 1-5
 Formatting 11-25
 Front door 1-2 to 1-4
 Functions
 Action 2-18
 Alarm 2-14 to 2-16
 Alarm display hold 2-16, 10-8

Computation 2-17
 Display 2-1
 Event/action 2-18, 9-1 to 9-11
 External input/output 2-19
 Interpolation 2-11, 6-17
 Key-lock, keylock 2-18, 9-14, 10-15, 10-16
 Match Time function 2-13, 6-17, 9-9
 Measurement input 2-3, 2-4
 Recording 2-5 to 2-13
 Relay hold *See also* HOLD/NON-HOLD, 2-16, 10-11
 Function Grounding Terminal, function-ground terminal,
 7, 3-11, 3-13, 3-35
 Full scale position 10-2
 Fuse 5
 holder 13-2, 13-3
 replacement of 13-2, 13-3

[G]

GP-IB interface 3, 2-20, 3-11
 GP-IB module 4, 3-11
 Graph *See* Bargraph display
 Grounding, protective grounding
 7, 3-17, 3-22, 3-23, 3-28, 3-34, 3-35
 Group setting 2-12, 6-17, 10-4
 Group trend recording 2-10, 9-10, 10-4

[H]

Handshake 3-12, 14-16
 Handle for carrying *See* Carrying handle
 Header printout (printing) 2-13, 6-15, 7-2
 Heat sink fins 1-2 to 1-4
 High limit alarm *See* alarm
 High resolution RTD 14-2
 HOLD/NON-HOLD 2-15, 10-11
 Horizontal or vertical printing *See* Recording direction
 Hysteresis 2-14, 10-8

[I]

Initialization 9-17
 Input
 channel 3, 1-2 to 1-4
 filter *See* filter
 terminals 1-2 to 1-4, 3-16 to 3-20
 type 3, 2-3, 5-1 to 5-3
 Inserting/deleting a character or numerical 6-15
 Installation method 3-2 to 3-5
 Instrument number 3
 Integration time *See* A/D (converter) integration time
 Internal illumination 2-19
 Internal RJC *See* RJC
 Internal switches 2-14, 8-3, 10-9 to 10-11
 Interpolation 2-11, 6-17
 Interval
 Display update 2-1, 10-24
 for recording 2-9, 6-3, 6-5, 10-6, 14-4
 for scan (measurement) 2-4, 2-9, 10-2

for rate-of-change alarms 2-14, 10-8
INTVL 11-5

[J]**[K]**

Key-lock (keylock) function 2-18, 9-15
 setting of 10-15, 10-16
KEY LOCK, KEYLOCK See Key-lock function

[L]

Last channel 5-2
Level action 9-9
Life of lithium battery 3-24, 3-25, 14-9, 14-15
Linear scaling 2-17, 5-5
List printout, printing 2-12, 6-13, 7-2
Logging, LOGGING See Mode
Logic (LOGIC) box 9-9
Low limit alarm, lower-limit alarm See Alarm

[M]

MANUAL See Display
Manual printout, printing 2-13, 7-2, 9-10
Margin 2-6, 2-7
Match Time function 2-13
 setting of 6-17, 9-9
Measured data
 Saving 11-1 to 11-6
 Reading 11-7 to 11-10
 Deleting 11-21
 Copying 11-16 to 11-20
Measurement input functions 2-3, 2-4
Measurement interval See interval
Measurement range 14-2
Memory 3
Message printout, printing 2-13, 6-15, 7-3, 9-10

Mode

Analog Trend 2-5, 2-8, 2-16, 6-2, 6-3
Display 2-1, 4-1 to 4-13
Logging, LOGGING 2-5, 6-3
Monitor Display 2-1
Operation 2-15, 10-9 to 10-11
Recording 2-5, 6-2
 TIME mode 6-3
Model and Suffix Codes 3 to 6
Module information 9-17
Monitor Display Mode 2-1
Mounting brackets 5, 3-2
Moving average functions 2-17, 6-17
 number of samples for 2-17, 6-17
MULTIPLE 2-9, 10-6

[N]

Names of parts 1-2 to 1-5, 3-6 to 3-9

Name plate 3
NO ALARM 4-7 to 4-9
Noise, countermeasures 3-26 to 3-35

[O]

Operating conditions (reference) 14-4
Operation panel 1-2 to 1-4
Operation mode See mode
Optional modules 4
 alarm module 2-19
 communication interface modules 2-19
 DI/DO module 2-19

[P]

Parity 3-12, 14-16, 14-17
Partially expanded display See Display
Parts replacement 13-1
Password 9-15, 2-18
Periodic maintenance 13-1
Pitch See printing pitch
Platen 3-6
Position marks, when installing the chart and ribbon cassette 3-7
Power
 connector (AC) 1-2, 1-3, 3-21
 connector (DC) 1-2, 1-3, 3-23
 cable (code) 3, 3-1, 3-21
 switch 1-2 to 1-4, 3-24
 terminals 1-2 to 1-4, 3-22, 3-23
Power supply voltage 3, 3-16 to 3-24
Pre trigger 11-5
Printing pitch 2-8, 10-5
Printout, printing
 Additional 2-13
Priority, for recording colors 2-11
Protective grounding See grounding

[Q]**[R]**

Rack mount kit, rack mounting 6, 3-2
RATE, for partially expanded recording 2-11, 6-7
Recording
 colors See also priority, 2-9, 10-14
 direction (, horizontal or vertical printing) 2-8, 10-5
 example 2-6 to 2-8, 2-12
 functions 2-5 to 2-13
 interval See Interval
 mode 2-5, 6-2
 Normal (NORMAL) 2-10, 10-4
 Partially expanded 2-11, 6-7
 span 2-10, 5-3
 starting/stopping of (to start/stop) 2-10, 7-1 to 7-4
 starting/stopping time of 2-6 to 2-8, 10-5
 zones See also Zone, 2-10, 6-7

Re-failure or re-alarm See Alarm reflashing
 Reference channel, for difference between channels 2-17, 5-3
 Reference junction compensation See RJC
 REFLASH, Reflashing alarm 2-15, 10-10
 Registration, of details set/selected with SET UP menu 10-24
 RELATIVE, relative time 2-9, 6-3
 Relay
 for alarm output See Alarm
 energizing/de-energizing setting 2-15, 10-11
 Remote control, REMOTE 2-19, 3-18, 9-9
 Replacement period, for parts 13-1
 Report 10-27 to 10-34
 Reset
 Alarm See Alarm
 Timer See Timer reset
 Resistance temperature detector See RTD
 Ribbon cassette 4, 3-6 to 3-10
 RJC 2-3, 10-13
 RRJC 2-20, 5-3
 RS-232-C Interface 3, 2-20, 3-12
 RS-232-C module 4, 3-12
 RS-422-A/RS-485 Interface 3, 2-20, 3-13, 14-17
 RS-422-A/RS-485 module 4, 3-12
 RTD 2-3, 5-3

[S]

Scan interval See Interval
 Scale check mark See also Values, 10-5
 Scale value See value
 Screw shaft 3-8, 13-1
 Screw terminals 3, 3-16, 3-22
 Set-up data
 Saving 11-11 to 11-12
 Reading 11-13 to 11-15
 Deleting 11-21
 Copying 11-16 to 11-20
 Set-up list, printing 7-4
 Shunt resistor (resistance) 6, 3-17

 SINGLE 2-9, 10-6
 SKIP, skipping 4-2, 4-3, 4-5 to 4-7, 4-9, 5-3
 Slots 4-2, 4-3, 4-10, 4-12, 10-10, 10-11
 Software 6
 Span
 for recording 2-10, 5-3
 calibrated values of 13-12
 Spares 6
 Sprocket 3-7
 Stop bit 3-12, 14-16, 14-17
 Style number 2
 Sub-display 1, 2 1-2 to 1-4, 2-1, 4-3
 Suffix codes See Model and Suffix Codes
 Symbols
 for conventions 9
 for safety See also WARNING, 7
 System module, recognition of 9-17

[T]

Tag
 printout 2-13, 6-9, 10-4
 selection 2-8, 6-9, 10-4
 Number of character of 2-8, 10-4
 Temporary stop 7-1
 Terminal cover 3-16
 Thermocouple 2-3, 5-3
 TIME mode 6-3
 Time-up 2-9
 Timer No. 2-9, 6-3
 Timer reset 2-9, 9-14, 9-15
 Title, title printouts 2-6 to 2-8, 2-13, 6-15
 Trend recording 2-5 to 2-7, 2-10, 6-2
 method of 2-10, 10-4
 Trigger 11-4, 11-9
 Trigger recording
 See also Alarm (trend recording upon occurrence), 2-10
 Troubleshooting 13-4

[U]

Unit No. 4-2 to 4-4
 Universal input module 4, 3-17
 Upper-limit alarm See Alarm

[V]

Value
 Scale (scaled) 2-6, 2-7, 2-10
 printout 2-8
 Reference point for
 See also scale check mark, 2-6 to 2-8
 Vertical printing See Recording direction
 Voltage level 5-3

[W]

Warm up 3-24
 WARNING, for safety precautions 7
 Wiring 3-16

[X]

[Y]

[Z]

Zero position 10-2
 calibrated values of 13-12
 Zone See also recording, 2-10, 6-7
 Left position of 2-10, 6-7
 Right position of 2-10, 6-7