

Measure and Analyze a Wealth of Signals in Real-Time and Speed up Development & Fault Finding.



# Precision Making

ScopeCorder  
DL850E / DL850EV

Measure and analyze a wealth of signals in real-time and speed up development and fault finding



**ScopeCorder  
DL850E / DL850EV**

ScopeCorder is a powerful portable data acquisition recorder that can capture and analyze both transient events and trends up to 200 days. Using flexible modular inputs it combines measurements of electrical signals, physical (sensors) and CAN / LIN serial buses and is able to trigger on electrical power related and other calculations in real-time.



**Flexible Inputs and Built-in Signal Conditioning**

Choose from 17 input modules to configure a ScopeCorder up to 128 channels and gain a thorough insight into any application by synchronizing the measurement of different types of electrical and physical signals.

- Voltage & Currents
- Sensor Outputs
- Temperature, Vibration/Acceleration, Strain, Frequency
- Logic Signals & CAN / LIN

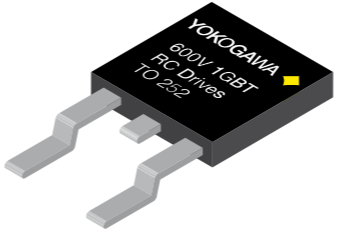

**Precise Measurement of Fast Switching Signals Even in the Harshest Environments**

Individually isolated and shielded input channels provide high-resolution and high sample rates

**A Trustworthy Measurement Platform for Durability Testing**

Measurement recording up to 200 days to the large acquisition memory, the internal hard disk and/or PC hard disk

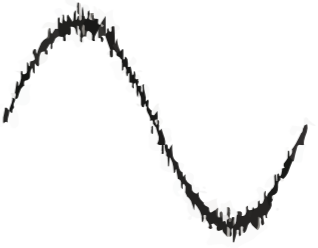

**Reduce Time Spent on Fault Finding**

Capture transient signals even during long term measurements using powerful triggers and unique features such as dual-capture & history memory

**Real-Time Evaluation of Dynamic Behavior within Power Applications**

Trend calculations such as active power, power factor, integrated power, harmonics and more using the new power math option



**3 Year Warranty**  
The quality and reliability of a ScopeCorder is supported by a standard 3 year warranty.



# Capture and record detailed waveforms from milliseconds up to months

A ScopeCorder provides a wide variety of unique acquisition features to handle small or large amounts of data. Therefore it can perform multi-channel measurements for longer measurement periods while still being able to precisely capture transient events with the highest detail.

## Real-time hard disk recording

Use a ScopeCorder as a measurement platform for simple durability testing up to 200 days. Real-time hard disk recording enables measurement data to be streamed directly to either a built-in hard drive (/HDD option) or via the eSATA interface (/HD1 option) to an external hard drive.

Sample Rate	Single Channel	For 16 Channels.
1 MS/s	10 Hours	-
200 kS/s	60 Hours	-
100 kS/s	5 Days	10 Hours
20 kS/s	20 Days	2,5 Days
2 kS/s	200 Days	20 Days

Measurement examples to internal or external Hard Disk



## Recall waveform events - history memory

When an abnormal phenomenon is spotted during a repetitive high speed measurement, the anomaly has often already disappeared from the screen by the time the measurement is stopped. With a ScopeCorder the "History" function is always active and automatically divides the available acquisition memory in up to 5,000 "history waveforms".

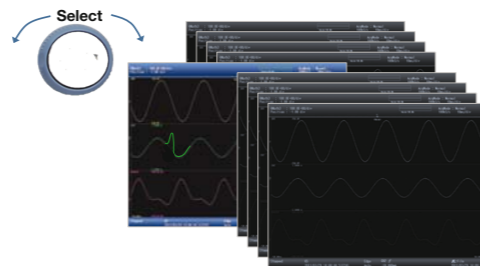

These history records are easily accessible and can be displayed simultaneously after measurement is stopped. Using condition-based searches inside the history memory, users can quickly isolate individual waveform records. Once the required waveforms have been identified they can be used for further analysis.

## Capture High-Speed Transients During Long Term Recording – Dual capture

To visualize long term trends for durability testing, data is typically acquired at lower speed sample rates. On the other hand, suddenly-occurring transitional phenomena have to be captured at high-speed sample rates and detail to be able to investigate the event. The "Dual Capture" function uniquely resolves these conflicting requirements by recording at two different sampling rates.

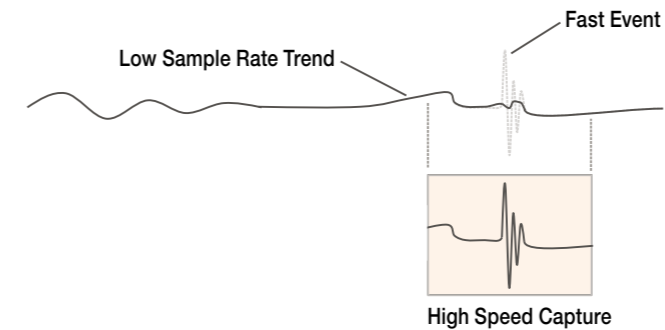

Set waveform triggers and capture 5,000 high-speed transient events at sample rates up to 100 MS/s, while at the same time continuously record trend measurements at up to 100kS/s.

## Continuous PC based data acquisition

Especially for longer duration or surveillance testing the ScopeCorder comes with an easy to setup acquisition software. The software enables continuous data recording to a PC hard drive. When using the software in free run mode there are virtually no restrictions in recording time and/or file size. Just click the start button to immediately start measurements!

## Continuous PC Based Data Acquisition ScopeCorder Acquisition Software



## The Setup Wizard Makes It Easy

Guided by four screens, the Setup Wizard easily guides you through the necessary settings for configuring the acquisition system such as measurement settings, data save and display options.

## Reduce time spend on fault finding or transient analysis - simple & enhanced triggers

Having the possibility to set individual triggers on multiple channels provides the power to investigate what causes a particular transient event. Moreover, the availability of a large acquisition memory, and thus longer measurement time, helps the analysis of the effect of such an event on other parts of the application.

## Wave Window Trigger

The ideal trigger for AC power line monitoring. Easily capture voltage sags, interfering impulses, phase shifts or drop outs.

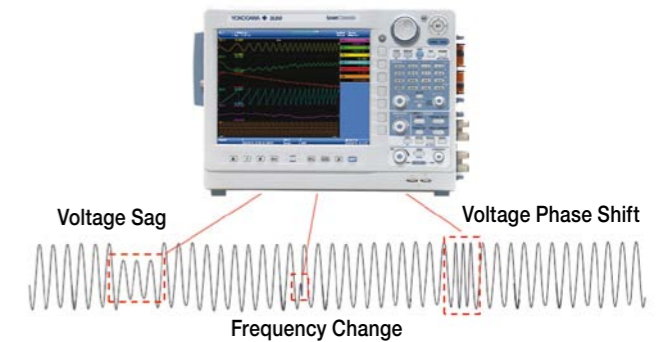

## Action on trigger

Leave a ScopeCorder unattended and automatically save the waveform to a file or send an email for notification of a trigger event.

## Fast and Large Acquisition Memory

A ScopeCorder is equipped with a large & fast acquisition memory up to 2Gpoint and enables high sample rates of up to 100MS/s on multiple channels simultaneously. This is ideal for viewing multiple inverter switching outputs simultaneously.

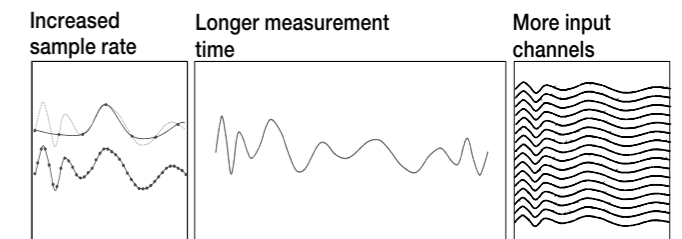

- Standard memory 250MPoint
- Expanded memory 1GPoint (/M1 Option)
- Expanded memory 2GPoint (/M2 Option)

Sample Rate	Single Channel	For 16 Channels
100 MS/s	20 Sec.	2 Sec. (using 8 ch.)
10 MS/s	3 Min. 20 Sec.	10 Sec.
1 MS/s	30 Min.	1Min. 40 Sec.
100 kS/s	5 Hours	10 Min.
10 kS/s	50 Hours	2 Hours 30 Min.
200 S/s	100 Days	5 Days
100 S/s	200 Days	10 Days

Measurement examples to 2GPoint acquisition memory



## Real-Time Measurement of Electrical Power – (/G5 option)

Trend calculations such as active power, power factor, integrated power and harmonics, using a dedicated Digital Signal Processor (DSP) that is able to calculate and display up to 125-types of electrical power related parameters in real-time. This enables the user to display raw waveform signals such as voltages and currents along with power calculated parameters and even the capability to trigger on all of them. Data updating rate up to 100kS/s. Trend waveforms of each order of harmonics, bar-graphs and vector displays can be displayed. Both RMS and Power analysis modes are available. Besides the powerful power calculations, the /G5 option also contains all the functionality of the /G3 option.

## Application Example | Inverter/Motor Testing

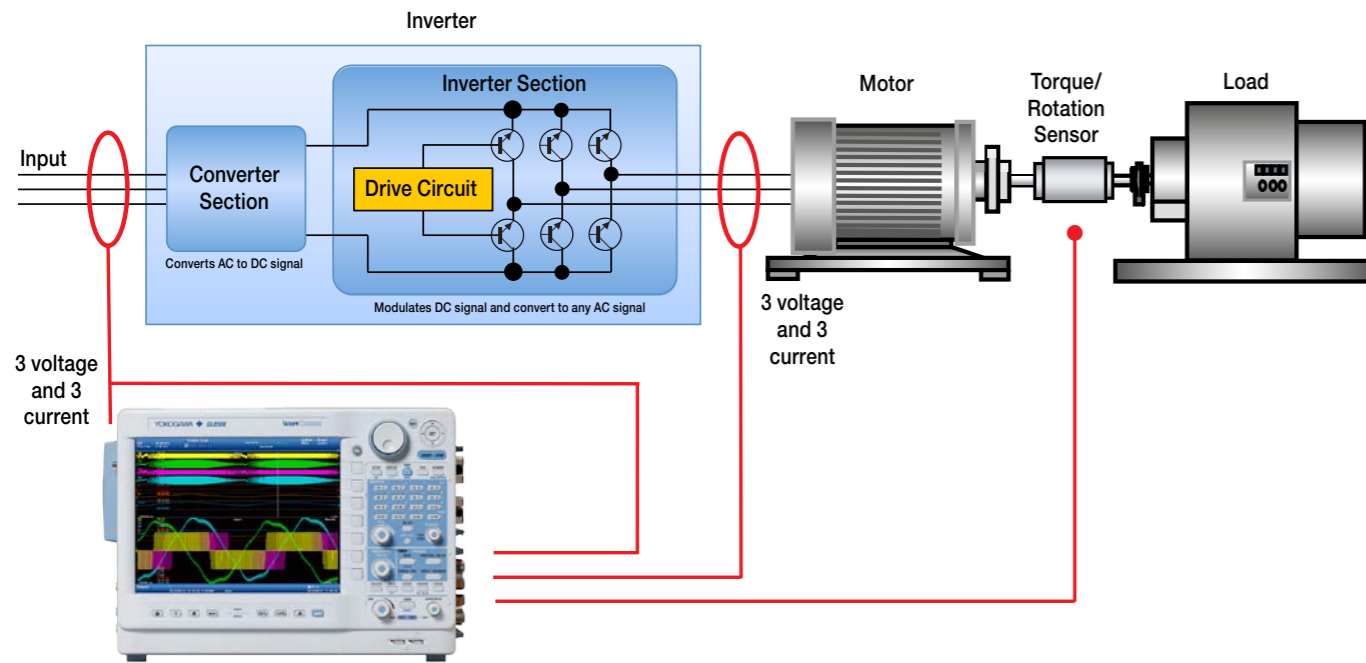

## User defined computations - (/G2 option)

With user defined computations it is possible to create equations using a combination of differentials and integrals, digital filters, and a wealth of other functions. Moreover it is possible to perform various-types of FFT analysis using two FFT windows. In applications such as vibration and shock tests, you can easily evaluate abnormal vibrations while simultaneously measuring other signals.

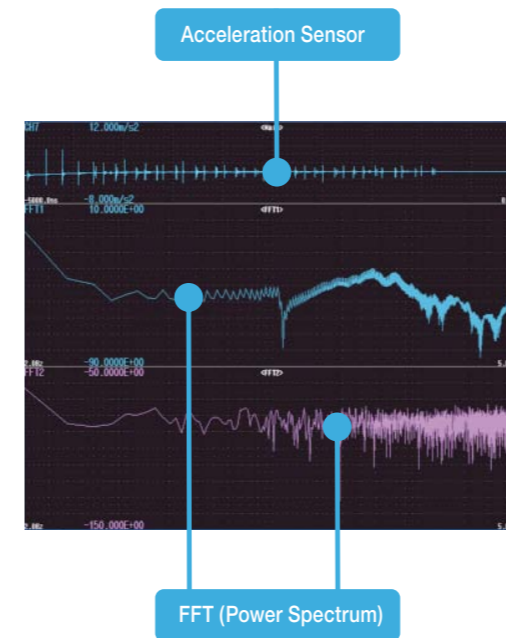

Application Example | with FFT

# Powerful Real-Time Calculations and Analysis Functions

By default the ScopeCorder is equipped with a set of basic arithmetic mathematical functions such as addition, subtraction, division, multiplication, fast Fourier transformation and other computations. Furthermore to really enrich the measurement and analysis capabilities of a ScopeCorder, several real-time options are available.

## Automatic Waveform Parameter Measurement

The parameter measure function is the most precise method for automatically calculating any or all of the 28 different waveform parameters such as, amplitude, peak to peak values, RMS, rise time, frequency and more.

Voltage measurement items			
Peak to Peak	Maximum	High	Average
Amplitude	Minimum	Low	Middle
Overshoot	Undershoot	RMS	Std. Deviation

## Cycle Statistics

With this powerful analysis function, the ScopeCorder measures selected parameters individually for each waveform cycle and provides statistical information which can easily be saved to a file. By selecting maximum or minimum values from the results, the instrument can automatically zoom into the selected waveform cycle for further analysis, potentially saving additional data analysis time.

Time measurement items			
Rise time	Period	Duty cycle	Pulse count
Fall time	+ width	Avg. Frequency	Burst 1
Frequency	- width	Avg. Period	Burst 2

## Cursor Measurement

Using cursors is a quick and easy method to measure waveform parameters on the screen. Available cursors are horizontal, vertical, marker, degree or combined horizontal & vertical.

Other measurement items	
Integ1TY	Integ2XY
Integ2TY	
Integ1XY	

## Real-Time Mathematical Computations and Digital Filtering – (/G3 option)

Armed with a dedicated digital signal processor the ScopeCorder can perform mathematical calculations such as arithmetic operators with coefficients, integrals and differentials, and higher-order equations on acquired measurement data. The results of these calculations are displayed during waveform capture in real-time. In addition to mathematical operators, steep digital filters can also be selected to isolate or trigger on the amplitude of certain frequency components.

## Giga Zoom Engine II

Zoom into 2 Billion samples in just a blink of the eye. Each ScopeCorder is equipped with the revolutionary Giga Zoom Engine II, a powerful processor designed for optimizing access to data seamlessly. It is possible to activate 2 zoom windows while displaying the entire original signal.

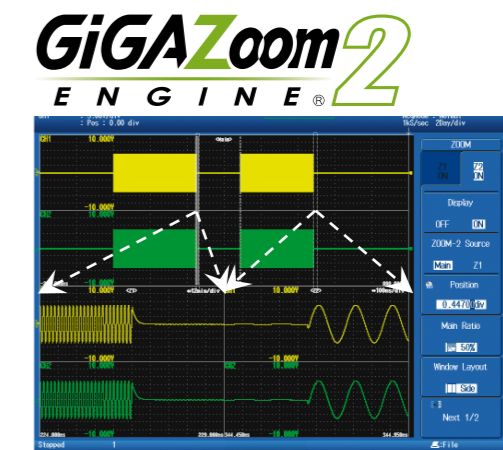

# DL850EV ScopeCorder Vehicle Edition

The ScopeCorder Vehicle Edition is designed for engineers working in the automotive and railway industry. A common measurement challenge is to combine measurements of electrical signals, physical performance parameters, indicated by sensors, together with CAN- or LIN-bus data transmitted by the powertrain management system. A ScopeCorder Vehicle Edition addresses this requirement by providing a thorough insight into the dynamic behavior of the electromechanical system. The result is a considerable saving of time compared to other approaches such as analysis on a PC or the use of other software.



## Battery Powered Operation - (/DC option)

In addition to AC power, it is also possible to take the ScopeCorder Vehicle Edition in a vehicle and power the unit from the vehicle's DC battery. The DC power option allows AC and DC power supplies to be used together to ensure a highly reliable power source. If the AC power goes down, the DL850EV instantly switches to the DC supply without interrupting the measurement.

- AC power (100 - 120V / 200 - 240V)
- DC power (10 - 18V)

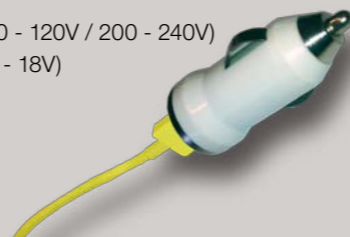

## CAN and LIN Bus Monitoring

Use a ScopeCorder to decode the CAN- or LIN-Bus signals and display information on physical data like engine temperature, vehicle speed and brake-pedal position as analog waveforms and compare this with the data coming from real sensors.

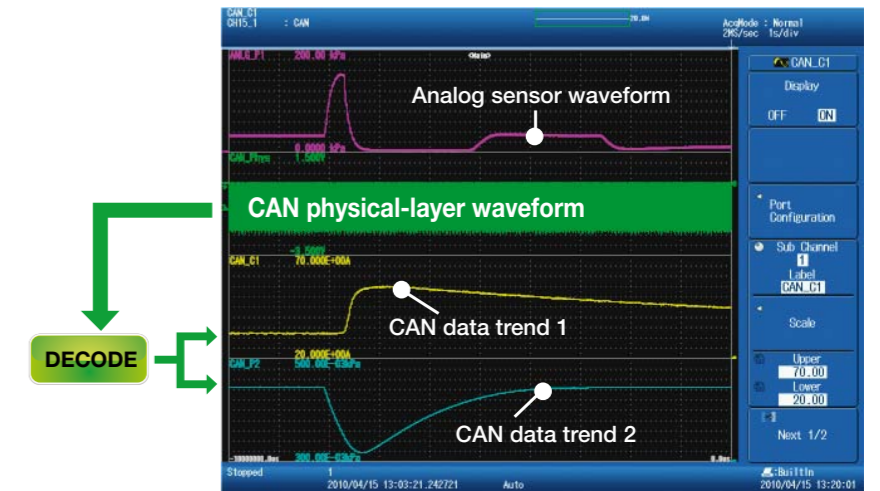

## Symbol Editor

The symbol editor is a software tool which makes it possible to define which physical values from the CAN- or LIN bus data frame have to be trended as waveform data on the display of the ScopeCorder. The Symbol Editor can accept vehicle-installed network definition files (CAN DBC, LIN LDF).

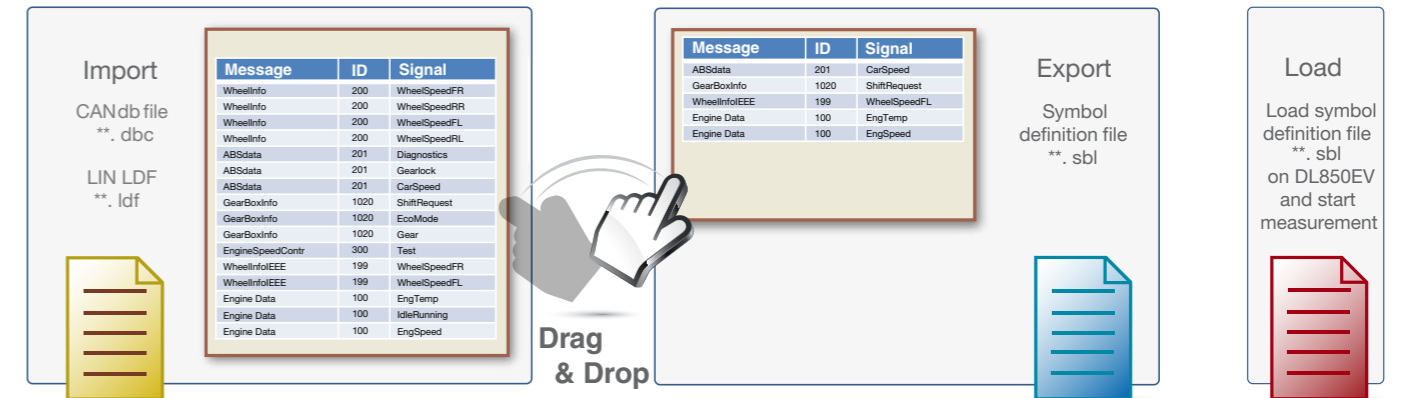

# Flexible operation and a variety of connection interfaces

A ScopeCorder has been designed to grant users access to functionality in the field quickly and easily using the front panel menu buttons. For users that prefer workbench operation it is possible to connect a USB mouse or keyboard.

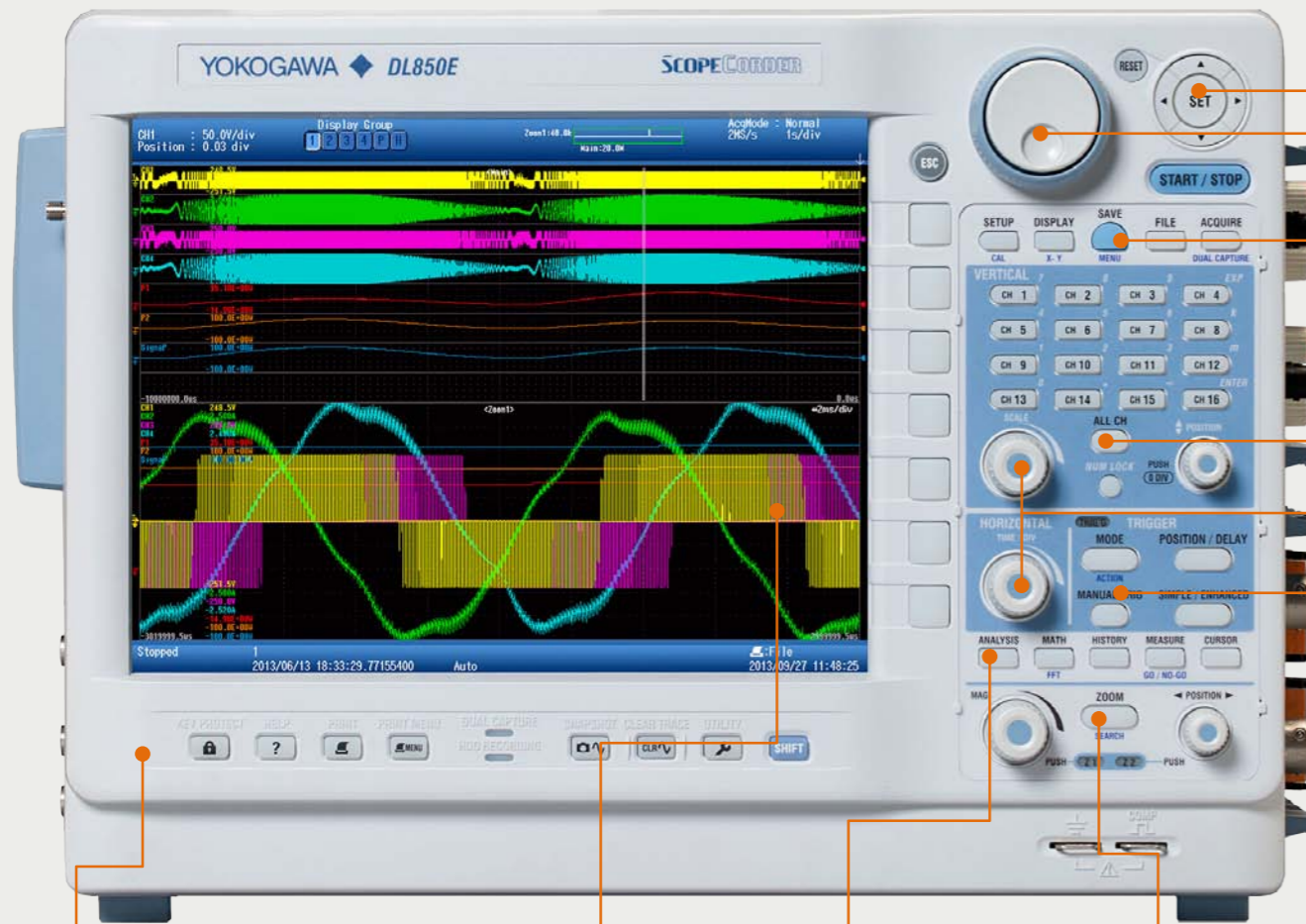

- Cursor Keys**  
For scrolling through setting menus. To enable a setting press the center [SET] key.
- Jog Shuttle**  
This multifunctional knob allows easy and quick adjustment of parameters & settings
- Single Button Save**  
A pre programmable button that saves data to hard drive, SD card, USB stick or a remote network storage location.
- All Channel Setup**  
For quick and easy setup, displays an overview of the settings of multiple input channels simultaneously.
- Vertical Scale & Horizontal Time/div**  
Use these rotary knobs to set the vertical scale (voltage/div) of the selected input channel or to set the required measurement time (time/div).
- Trigger**  
Minimize the time spent on fault finding by using simple or enhanced triggers.

- Local Language Support**  
Operate the ScopeCorder in the language of your choice by selecting any of the 8 languages for the instrument's software menu and front panel. Choose from English, German, French, Italian, Spanish, Chinese, Korean or Japanese.
- High Resolution Display**  
A large 10.4-inch XGA LCD, displays multiple channels in precise detail.
- Analysis**  
Display power calculations, such as active power, power factor, integrated power and harmonics in real-time
- Zoom**  
With 2 zoom windows the Gigazoom Engine II zooms into 2 Billion samples in just a blink of the eye.

- Video Output**  
Duplicate the ScopeCorder display on an external display or beamer.
- EXT I/O**  
Multifunctional port used for indicating the results of repeated automatic GO/NO-GO measurements or for external start/stop of the measurement.
- External Clock In**  
Synchronize the sampling clock to an external clock signal, for example when working with rotary devices for position related sampling.
- USB Type B**  
To operate a ScopeCorder from a PC or to download measurement files.
- External Trigger Input / Output**  
Use an external source for trigger input or use trigger output to simultaneously start another measuring device
- Ethernet 1000BASE-T**  
Control a ScopeCorder via Ethernet, implement in test programs or automatically save measurement results to a remote storage location.
- USB Type A**  
Two USB ports support USB storage, keyboard input and mouse operation.

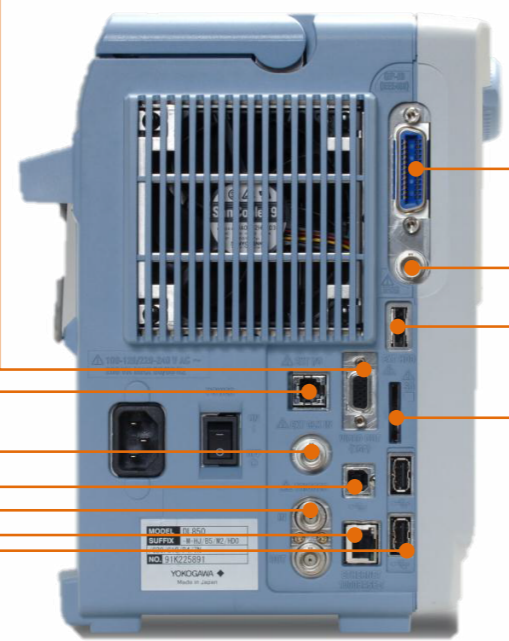

- GP-IB (/C1 or /C20 option)**  
IEEE-488 GPIB short-range digital communications bus for automated test setup use.
- IRIG Interface (/C20 option)**  
Use an IRIG time code signal from a GPS receiver to synchronize the time and sampling clock of one or more ScopeCorders.
- GPS Interface (/C30 option)**  
A GPS antenna can be directly connected to the ScopeCorder side panel. The instruments time clock and the sampling clock will be synchronized to the GPS clock.
- External eSATA Hard Drive Interface (/HD0 option)**  
Save measurement data to external eSATA hard drive.
- Internal Hard Drive (/HD1 option)**  
Save measurement data to internal xxGB hard drive.
- SD card slot**  
Supports storage to SD & SDHC cards up to 16GB

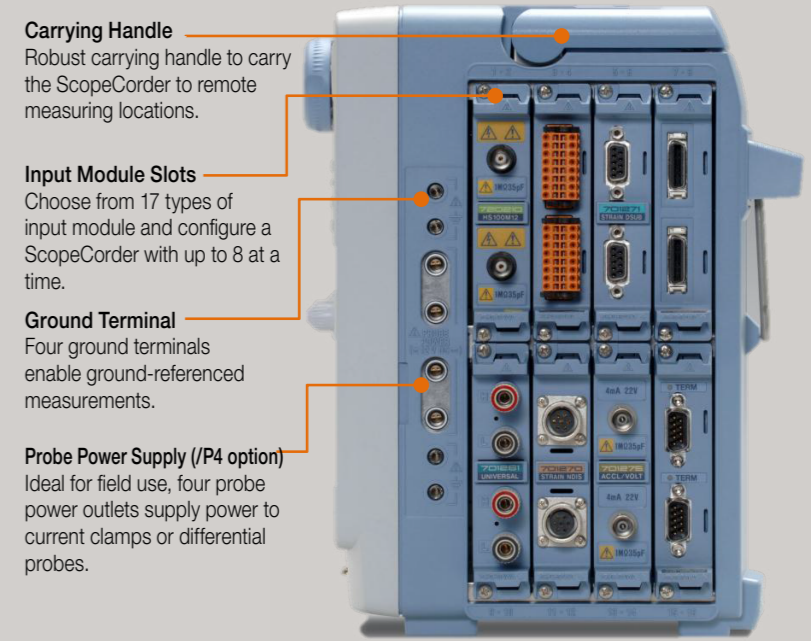

- Carrying Handle**  
Robust carrying handle to carry the ScopeCorder to remote measuring locations.
- Input Module Slots**  
Choose from 17 types of input module and configure a ScopeCorder with up to 8 at a time.
- Ground Terminal**  
Four ground terminals enable ground-referenced measurements.
- Probe Power Supply (/P4 option)**  
Ideal for field use, four probe power outlets supply power to current clamps or differential probes.

# Applications in Power & Transportation

With today's increased incorporation of power electronics and switching devices in power and transportation related applications, measuring the power consumption and performance of the individual components alone is often not sufficient to understand the overall performance and behavior of a system.

A ScopeCorder satisfies this new measurement requirement by not only capturing voltage and current waveforms but combines these with real-time calculations of power and other electrical and physical parameters in a single measurement overview.



## Motors and Electric Drives

The majority of industrial applications incorporate a variable speed drive in combination with a three-phase induction motor. Where an Oscilloscope often has a limited channel count and non-isolated input channels, the DL850E can be equipped with 16 or more channels and has a diverse range of input modules, where each channel is individually isolated.

The instrument offers direct input of voltages up to 1000V, with no need for active probing, and samples data at rates up to 100MS/s with 12 or 16 Bit vertical resolution. These features are ideal for capturing inverter switching signals with high precision.

Being able to connect the outputs from additional torque sensors, rotary encoders or thermocouples also makes the DL850E ScopeCorder an ideal measuring instrument to enable engineers to improve the design of motor and electric drives, reduce size and costs, and increase efficiency levels. This in turn helps to reduce global industrial power consumption.

## Sustainable Operation of Urban Mobility



Perform service and maintenance in the field by taking a ScopeCorder on-board a vehicle. The DL850EV can be driven by DC power, such as the vehicle's battery, in addition to AC power.

## Simultaneously Measure and Analyze 3 Phase Inputs and 3 Phase Outputs



The ScopeCorder's multichannel platform with large memory enables the power of 6 inputs (3x voltage and 3x current) and 6 outputs to be analyzed simultaneously.

## Real-Time Evaluation of Dynamic Behavior within Power Applications



Active power, power factor, integrated power, harmonics and more can be calculated and shown as trends using the new /G5 power math option.

## Precise Measurement of Fast Switching Signals Even in the Harshest Environments



Individually isolated and shielded input channels provide high-resolution and high noise immunity.

## Vehicle Testing

The increasing demand for clean and energy efficient ways of transportation drives the development of efficient railway electrification systems incorporating new greener propulsion and control technologies. In the automotive market, the electrification of the powertrain is shaping the future of vehicle technology development. The DL850EV ScopeCorder Vehicle edition is designed to provide engineers with knowledge about the dynamic behavior of their specific application and its efficiency.



- Rotary encoder position
- Consumed Energy
- Sensor Linearization
- RMS
- Real Power
- Harmonics
- Frequency
- AC Waveform Trigger

## Analyze the Dynamics of Electric Drive Trains

Combine electrical signals and physical sensor parameters, related to mechanical performance, with data from the control system such as a CAN or LIN bus. This enables R&D engineers to identify the correlation between communication data transmitted over the vehicle bus and analog data such as voltage, temperature and sensor signals, or the ECU's control logic signals.

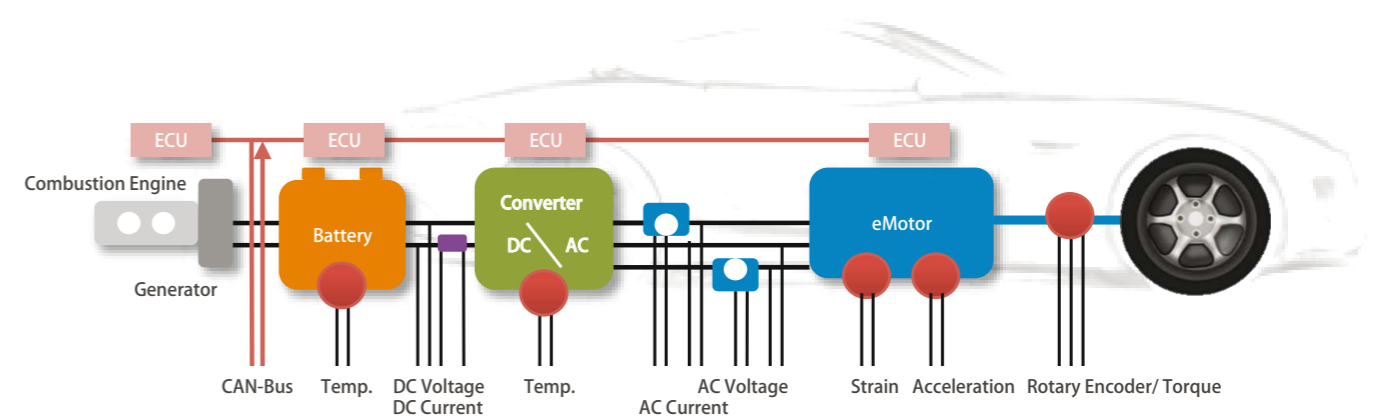

# Flexible and swappable input modules with built-in signal conditioning

Choose from 17 types of input module and install up to 8 in a ScopeCorder at a time.



701250 High-speed 10MS/s, 12-bit			
Sample Rate	10MS/s	Channels	2
Resolution	12 Bit	Type of input	Isolated
Bandwidth	3 MHz	Max input voltage	600V*1 250V*2
DC Accuracy	±0,5%	Note: High Noise Immunity	

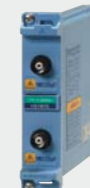

701251 High-speed 1MS/s, 16-bit			
Sample Rate	1MS/s	Channels	2
Resolution	16 Bit	Type of input	Isolated
Bandwidth	300 KHz	Max input voltage	600V*1 140V*2
DC Accuracy	±0,25%	Note: High Sensitivity & Noise Immunity	



720220 Voltage Scanner, 200kS/s, 16-bit			
Sample Rate	200kS/s	Channels	16
Resolution	16 Bit	Type of input	Isolated (GND-terminal Non-Isolated (CH-CH))
Bandwidth	5 kHz	Max input voltage	42V*2
DC Accuracy	±0,3%	Note: Channel sample rate determined by the number of channels used	



701261 Universal Voltage / Temperature			
Sample Rate	100 kS/s (Voltage) 500S/s (Temp)	Channels	2
Resolution	16 Bit (Voltage) 0,1°C (Temp)	Type of input	Isolated
Bandwidth	40 kHz (voltage) 100Hz (temperature)	Max input voltage	42V*2
DC Accuracy	±0,25% Voltage	Note: Thermocouple	



701262 Universal Voltage / Temperature			
Sample Rate	100 kS/s (Voltage) 500S/s (Temp)	Channels	2
Resolution	16 Bit (Voltage) 0,1°C (Temp)	Type of input	Isolated
Bandwidth	40 kHz (voltage) 100Hz (temperature)	Max input voltage	42V*2
DC Accuracy	±0,25% Voltage	Note: Same as 701261 but with anti aliasing filter	



701255 High-speed 10MS/s, 12-bit, Non-Isolated			
Sample Rate	10MS/s	Channels	2
Resolution	12 Bit	Type of input	Non-Isolated
Bandwidth	3 MHz	Max input voltage	600V*2 250V*2
DC Accuracy	±0,5%	Note: Non-Isolated version of 701250	



701267 High-voltage 100kS/s, 16-bit			
Sample Rate	100 kS/s	Channels	2
Resolution	16 Bit	Type of input	Isolated
Bandwidth	40 kHz	Max input voltage	850V*2
DC Accuracy	±0,25%	Note: With RMS and high noise immunity	



701265 High-precision Temperature / Voltage			
Sample Rate	500S/s (Voltage) 500S/s (Temp)	Channels	2
Resolution	16 Bit (Voltage) 0,1°C (Temp)	Type of input	Isolated
Bandwidth	100 Hz	Max input voltage	42V*2
DC Accuracy	±0,08% Voltage	Note: Thermocouple, High sensitivity range (0,1mV/div), and low noise (± 4µV typ)	



720221 Temperature Scanner, 10 S/s, 16-bit			
Sample Rate	10S/s	Channels	16
Resolution	16 Bit	Type of input	Isolated
Bandwidth	600 Hz	Max input voltage	42V*2
DC Accuracy	±0,15% Voltage	Note: Requires 701953 external scanner box	



701953 16 Channels Scanner Box	
External Scanner Box for 720221 temperature scanner, enables 16 channel temperature or voltage measurement.	



701270 Strain NDIS			
Sample Rate	100kS/s	Channels	2
Resolution	16 Bit	Type of input	Isolated
Bandwidth	20 kHz	Max input voltage	10V
Strain Accuracy	±0,5%	Note: NDIS, 2,5,10V built in bridge power supply	



701271 Strain DSUB			
Sample Rate	100kS/s	Channels	2
Resolution	16 Bit	Type of input	Isolated
Bandwidth	20 kHz	Max input voltage	10V
Strain Accuracy	±0,5%	Note: DSUB, 2,5,10V built in bridge power supply and shunt calibration	

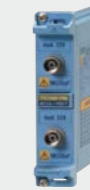

701275 Acceleration and Voltage			
Sample Rate	100kS/s	Channels	2
Resolution	16 Bit	Type of input	Isolated
Bandwidth	40 kHz	Max input	42V*2
DC Accuracy	±0,25% (Voltage) ±0,5% (acceleration)	Note: Supports built-in amp acceleration sensors. (4 mA/22 V)	

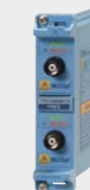

701280 Frequency			
Sample Rate	25kS/s	Channels	2
Resolution	16 Bit	Type of input	Isolated
Bandwidth	50 ns	Max input voltage	420V*1 42V*2
DC Accuracy	±0,1%	Note: Measures 0,01 Hz to 200kHz, parameters: frequency, rpm, period, duty, power supply frequency, distance, speed	



720230 Logic Input			
Sample Rate	10 MS/s	Channels	8 bits x 2 ports
Max input voltage	10 V	Type of input	Non-Isolated
Note: For use with up to 2 logic probes			

\*1: In combination with 10:1 probe model 700929. \*2: Direct input. \*3: In combination with 10:1 probe model 701940.



For the full input module specifications see bulletin DL850E-01EN

## IsoPRO technology enables High speed (100 MS/s), High resolution (12-bit), 1kV isolated measurements.\*



720210 High Voltage 100MS/s, 12-bit, Isolated			
Sample Rate	100 MS/s	Channels	2
Resolution	12 Bit	Type of input	Isolated
Bandwidth	20 MHz	Max input voltage	1000V*1 200V*2
DC Accuracy	±0,5%	Note: Up to 4 of these modules can be installed	

The *isoPRO* core technology is designed for inverter / IGBT related applications in mind. Using high speed optical fiber-based transmission, the module achieves high speed ADC clock and data isolation and provides the performance needed to develop high efficiency inverters, which employ high voltages, large currents, and ever increasing switching speeds.

\* With the combination of the 720210 high-speed isolation module and a 700929 or 701947 probe

## Input modules for DL850EV.



720240 CAN Bus Monitor			
Sample Rate	100 kS/s	Channels	120 (60 signals x 2 ports)
Max input voltage	10 V	Type of input	Isolated
Note: For DL850EV. Supports CAN data frames up to 32 bit. Up to two 720240 or 720241 input modules can be installed.			



720241 CAN / LIN Bus Monitor			
Sample Rate	100 kS/s	Channels	120 (60 CAN signals & 60 LIN signals)
Max input voltage	10 V (CAN)	Type of input	Isolated
Note: For DL850EV. Up to two 720240 or 720241 input modules can be installed.			



# Accessories and Specifications

Different applications, different types of signals, different measurement needs and different accessories.

Analyze measurement data using the ScopeCorder itself or in the PC using Xviewer software.



**Xviewer** can display acquired waveforms, transfer files and control instruments remotely. In addition to simply displaying the waveform data, Xviewer features many of the same functions that the ScopeCorder offers; zoom display, cursor measurements, calculation of waveform parameters, and complex waveform math. Binary waveform data can be easily converted to CSV, Excel or Floating Point Decimal format.

## ScopeCorder Advanced Utility Option

The Xviewer advanced utility option enables waveform data to be pre-analyzed while the acquisition on the instrument is still in progress. It also adds the possibility to merge and synchronize measurement files taken by multiple ScopeCorders as well as file splitting and file format conversion.

## Free Xviewer trial

Get the free 30 day trial version of Xviewer at [tmi.yokogawa.com](http://tmi.yokogawa.com)

	10:1 Isolation Probe 700929		7000 Vpk, 50MHz Differential Probe 701926		Current Probe 500 Arms DC to 2 MHz 701931
	100:1 Isolation Probe 701947		±1400V, 100MHz Differential Probe 700924		Current Probe 30 Arms DC to 50 MHz 701933
	1:1 Safety BNC Adapter Lead 701901		±500V, 15MHz Differential Probe 700925		Current Probe 150 Arms DC to 10 MHz 701930
	Measurement Lead Set 758917		Passive Probe 701940		Probe Power Supply 4-outputs 701934
	Plug-On Clip 701948		BNC Cable 366924/366925		/P4 Probe power 4-outputs
	Safety BNC Cable 1 m : 701902 2 m : 701903		1:1 BNC-Alligator Cable 366926		Bridge Head (NDIS) 120 : 701955 350 : 701956
	Large Alligator-Clip (Dolphin type) 701954		1:1 Banana-Alligator Cable 366961		Bridge Head (DSUB) 120 : 701957 350 : 701958
	Safety Mini-Clip (Hook type) 701959		Fork Terminal Adaptor Set 758921		High-Speed Logic Probe 700986
	Alligator Clip Adaptor Set 758922		16 Channel Scanner Box 701953 for 720221 input module		Isolation Logic Probe 700987
	Alligator Clip Adaptor Set 758929		Shunt Resistor for 4-20 mA Measurement 438920 (250 ±0.1%) 438921 (100 ±0.1%) 438922 (10 ±0.1%)		Logic Probe (TTL level Contact Input) 1m: 702911 3m: 702912

## Related Products



### High Speed PC based DAQ SL1000

- High speed data streaming to PC
- 100 MS/s, 16 channels
- Supports multi-unit synchronisation



### Mixed Signal Oscilloscope DLM4000 Series

- 8 Analog Input Channels
- 350 MHz or 500 MHz bandwidth
- Up to 24 bit logic inputs



### High Performance Power Analyzer WT1800

- Up to 6 input elements
- 5 MHz voltage and current bandwidth
- Basic power accuracy ±0.1%

## Software Support

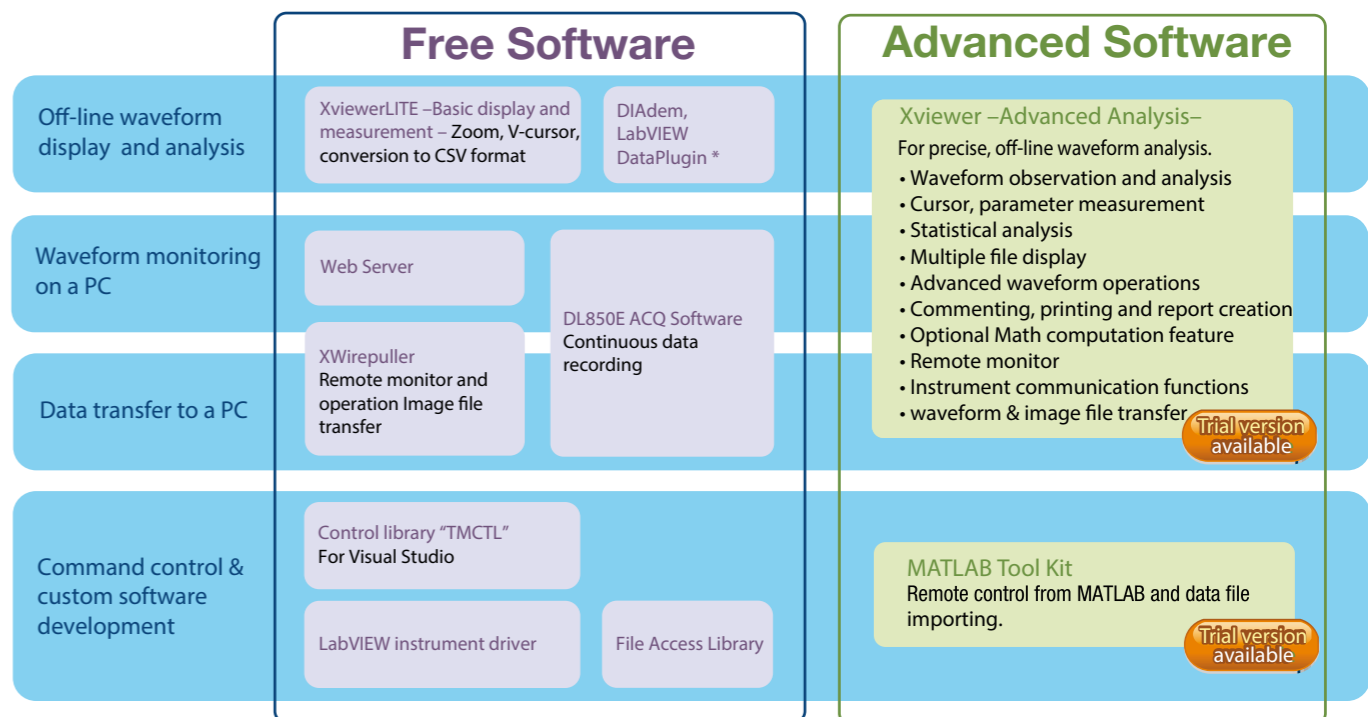

\* The Data Plugin is downloadable from the National Instruments web site.



## Main Specification (Main Unit)

Main Specifications	
Input Section	Plug-in module
Number of slots	8 Max 4 for 720210 modules Max 2 modules for 720240, 720241 (for DL850EV only)
Number of input channels	DL850E: 16CH/Slot, 128CH/Unit DL850EV: 120CH/Slot, 336CH/Unit (Maximum simultaneous display waveform is 64 waveforms x 4 screen selectable)
Max recording length	Max recording length depends on kinds of modules and number of channels Standard 250 Mpts (1 CH), 10 Mpts/CH (16 CH <sup>-1</sup> ) /M1 option 1 Gpts (1CH), 50 Mpts/CH (16 CH <sup>-1</sup> ) /M2 option 2 Gpts (1CH), 100 Mpts/CH (16 CH <sup>-1</sup> ) 1 pts (point) = 1 W (word)
Max Time axis setting range	100ns/div to 1s/div (1-2.5 step) 2s/div, 3s/div, 4s/div, 5s/div, 6s/div, 8s/div, 10s/div, 20s/div, 30s/div, 1min/div to 10min/div (1min step), 12min/div, 15min/div, 30min/div, 1h/div to 10h/div (1h step), 12h/div, 1day/div, 2day/div, 3day/div, 4day/div, 5day/div, 6day/div, 8day/div, 10day/div, 20day/div
Time axis accuracy <sup>2)</sup>	±0.005%
Trigger Section	
Trigger mode	auto, auto level, normal, single, single (N), ON start
Trigger level setting range	0 centered ±10div
Simple trigger	CHn (n: any input channel), Time, External, Line Rising, falling, or rising/falling
Trigger source	CHn (n: any input channel), Time, External, Line
Trigger slope	Rising, falling, or rising/falling
Time trigger	Date (year/month/day), time (hour/minute), time interval (10 seconds to 24 hours)
Enhanced trigger	
Trigger source	CHn (n: any input channel)
Trigger type	A→B(N), A Delay B, Edge on A, OR, AND, Period, Pulse Width, Wave Window
Display	
Display	10.4-inch TFT color LCD monitor, 1024x768(XGA)
Display resolution of waveform display	selectable either 801x656 (normal waveform display) or 1001x656 (wide waveform display)
Display format	Max 3 simultaneous displays available In addition to main, 2 more waveforms available among zoom 1, zoom 2, XY1, XY2, FFT1, FFT2 (/G2 option), Vector (/G5 option), Bar graph (/G5 option)
Function	
● Acquisition and display	
Acquisition mode	Normal Normal waveform acquisition Envelope Maximum sample rate regardless of record time, holds peak value Averaging Average count 2 to 65536 (2n steps) Box average Increase A/D resolution up to 4 bits (max 16 bits)
Roll mode	It is effective when the trigger mode is set to auto/auto level/single/ON start, and time axis is greater than 100ms/div.
Dual capture	Performs data acquisition on the same waveform at 2 different sample rates.
Main waveform (low speed)	Maximum sample rate 100kS/s (roll mode region) Maximum record length 1G point (/M2, 1CH)
Capture waveform (high speed)	Maximum sample rate 100MS/s Maximum record length 500k point
Realtime hard disk recording	Maximum sample rate 1MS/s (1CH used), 100kS/s (16CH used) depends on channel used Depends on HDD vacant capacity Action When waveform acquisition occurs according to the specified trigger mode, the DL850E/DL850EV stores the data to an internal hard disk or an external hard disk that supports eSATA.
(/HDD0,/HD1 option)	Capacity Action
History memory	Maximum 5000 waveforms
● Display	
Display format	TY display for 1, 2, 3, 4, 6, 8, 12, 16 division display
Maximum number of display traces	64 trace per 1 display group, selectable in every 4 displays
X-Y display	Selectable X axis/Y axis in CHn, MATHn (max 4 trace x 2 window)
Accumulation	Accumulates waveforms on the display (persistence mode)
Snapshot	Retains the current displayed waveform on the screen. Snapshot waveforms can be saved/loaded.
ALL CH menu	Set all channels while displaying waveforms. Operation using USB keyboard and USB mouse are available.
Expansion/reduction of vertical axis direction	x0.1 to x100 (varies depending on the module), DIV/SPAN set selectable
Vertical position setting	±5div waveform move is available from the center of waveform screen frame.
Linear scaling	Set AX+B mode or P1-P2 mode independently for CHn
● Analysis, computation	
Cursor measurement	Horizontal, Vertical, Marker, Degree (for T-Y waveform display only), H&V
Zoom	Expand the displayed waveform along time axis (up to 2 locations using separate zoom rates) Expanded display 100ns/div to 1/2 of Main waveform Auto scroll Automatically scrolls the zoom position.
Search and zoom	Search for, then expand and display a portion of the displayed waveform. Search conditions Edge count, logic pattern, event, time

History search function	Search for and display waveforms from the history memory that satisfies specified conditions. Zone search/parameter search
Waveform parameters items	Up to 24 items can be displayed P-P, Amp, Max, Min, High, Low, Avg, Mid, Rms, Sdev, +OverShoot, -OverShoot, Rise, Fall, Freq, Period, +Width, -Width, Duty, Pulse, Burst1, Burst2, AvgFreq, AvgPeriod, Int1TY, Int2TY, Int1XY, Int2XY, Delay(between channels)
Statistical processing	Automated measured values of waveform parameters Statistics Max, Min, Avg, Sdev, Count Mode All waveforms/cycle statistics/history statistics Maximum number of cycles 64,000 cycles (when the number of parameters is 1) Maximum number of parameters 64,000 Maximum measurement range 100M points
Computation (MATH)	Definable MATH waveforms Max 8 Calculable record length Max. 1M point (1ch) Operators +, -, ×, ÷, binary computation, phase shift, and power spectrum User-defined computation Computation setting is available by combining any following operators and parameter measurement items. ABS, SQRT, LOG, EXP, NEG, SIN, COS, TAN, ATAN, PH, DIF, DDIF, INTG, IINTG, BIN, P2, P3, F1, F2, FV, PWH, PWHL, PMLL, PMLL, PWXX, DUTYH, DUTYL, FLT1, FLT2, HLBT, MEAN, LS-, PS-, PSD-, CS-, TF-, CH-, MAG, LOGMAG, PHASE, REAL, IMAG
FFT	Subject to be computed CHn, MATHn Number of channels 1 (/G2 no option), 2 (/G2 option) Computation points 1k/2k/5k/10k/20k/50k/100k Time window Rect/Hanning/Hamming/FlatTop, Exponential (/G2 option) Average function Yes (/G2 option)
Real time MATH (/G3 option)	Number of computation waveforms Maximum 16 (Selectable with any input channel <sup>3)</sup> ) Digital filter Gauss (LFF), SHARP (LFF/HFF/BPF), IIR (LFF/HFF/BPF), MEAN (LFF) Delay 100ns to 10.00ms (The data will be decimated when the delay time is relatively long.) Types of computation +, -, ×, ÷, four fundamental arithmetic operations with coefficients, differential, integral, angle, D-A conversion, quartic polynomial equation, rms value, active power value, Reactive power value, integrated power value, logarithm, square root, sin, cos, atan, electrical angle, polynomial addition & subtraction, frequency, period, edge count, resolver, IIR filter, PWM, knock filter (DL850EV only), and CAN ID (DL850EV only)
Power MATH (/G5)	
Power Analysis	Max. number of analyzable system 2-system (3-phase) Max. number of measurement parameters 126 (1-system) 54 (2-system) Wiring System single-phase, two-wire; single-phase, three-wire; three-phase, three-wire; three-phase, four-wire; and three-phase, three-wire with three-voltage, three-current method 3P3W Difference, 3P3W>3V3A 3P4W Star>Delta 3P3W(3V3A) Delta>Star
Delta Computation	3P3W Difference, 3P3W>3V3A 3P4W Star>Delta 3P3W(3V3A) Delta>Star
Measurement Items	RMS voltage/current of each phase, Simple voltage and current average (DC) of each phase, AC voltage/current component of each phase (AC), Active power, Apparent power, Reactive power, Power factor, Current phase difference, Voltage/Current frequency, Maximum voltage/current, Minimum voltage/current, Maximum/Minimum power, Integrated Power (positive and negative), Integrated Current (positive and negative), Volt-ampere hours, Var hours, Impedance of the load circuit, Series resistance of the load circuit, Series reactance of the load circuit, Parallel resistance of the load circuit, Parallel reactance of the load circuit, Unbalance rate of three-phase voltage, Unbalance rate of three-phase current, Motor output, Efficiency, Integration time
Harmonic Analysis	Max. number of analyzable system 1-system Max. analyzable frequency 1kHz (fundamental signal) Number of FFT points 512 Wiring System single-phase, two-wire; single-phase, three-wire; three-phase, three-wire; and three-phase, three-wire with three-voltage, three-current method Delta Computation 3P3W Difference, 3P3W>3V3A 3P4W Star>Delta 3P3W(3V3A) Delta>Star
Measurement Mode	RMS Measurement mode, Power Measurement mode
Measurement Items	RMS Measurement mode: 1 to 40 order RMS, 1 to 40 order RMS distortion factor, 1 to 40 order phase difference, Total RMS, Distortion Factor (IEC), Distortion Factor (CSA) Power Measurement mode: 1 to 35 order active power, 1 to 35 order active power distortion factor, 1 to 35 order phase difference, Total active power, Total Apparent power, Total Reactive power, Power factor, 1st order RMS voltage, 1st order RMS current, 1st order voltage phase difference, 1st order voltage phase difference
GO/NO-GO determination	Operate selected actions based on the determination criteria to the captured waveform. Zone Determination using combination of up to 6 waveform zones (AND/OR). parameters Determination using combinations of 16 waveform parameters Actions Screen image data output, waveform data storage, buzzer notification, and e-mail transmission
Action-on trigger	Operates the selected actions each time trigger occurs. Actions once triggered Screen image data output, waveform data storage, buzzer notification, mail transmission
● Screen image data output	
Built-in printer (/B5 option)	Prints hard copy of screen.

## Main Specification (Main Unit)

External printer	Outputs the screen image to an external printer via Ethernet or USB
File output data format	PNG, JPEG, BMP
● Other functions	
Mail transmission function	Transmission function by SMTP
PROTECT key	Key protection is available to prevent from careless or unexpected operation.
NUM key	Direct input of numerical numbers is available.
Built-in printer (/B5 option)	
Printing system	Thermal line dot system
Paper width	112mm
Effective printing width	104mm (832 dot)
Feeding direction resolution	8dot/mm
Function	Display hard copy
Storage	
SD card slot	Memory cards conforms to SD, SDHC, maximum capacity 16GB
USB memory	Mass storage device which conforms to USB Mass Storage Class Ver.1.1
External HDD(/HDD0 option)	Hard disc conforms to eSATA, FAT32
Built-in HDD(/HD1 option)	2.5 inch, 500GB, FAT32
USB peripheral interface	
Connector type	USB type A connector (receptacle) x 2
Electrical, mechanical specifications	Conforms to USB Rev.2.0 <sup>*</sup>
Supported transmission standards	HS (High Speed) mode, FS (Full Speed) mode, LS (Low Speed) mode
Supported device	Mass storage device which conforms to USB Mass Storage Class Ver.1.1 109 keyboard, 104 keyboard, mouse which conform to USB HID Class Ver.1.1 HP(PCL) inkjet printer which conforms to USB Printer Class Ver.1.0
Power supply	5V, 500mA (in each port) <sup>*</sup> Connect USB device directly. Composite device is not supported.
USB-PC connection	
Connector type	USB type B connector (receptacle) x1
Electrical, mechanical specifications	Conforms to USB Rev.2.0
Supported transmission standards	HS(High Speed) mode (480Mbps), FS(Full Speed) mode (12Mbps)
Supported protocol	USBTMC-USB48 (USB Test and Measurement Class Ver.1.0)
Ethernet	
Connector type	RJ-45 modular jack x1
Electrical, mechanical specifications	Conforms to IEEE802.3
Transmission system	Ethernet (1000BASE-T/100BASE-TX/10BASE-T)
Communication protocol	TCP/IP
Supported services	Server FTP, Web, VX-11 Client SMTP, SNMP, LPR, DHCP, DNS, FTP
GP-IB (/C1, /C20 option)	
Electrical specifications	Conforms to IEEE Std 488-1978/JIS C 1901-1987
Functional specifications	SH1, AH1, T6, L4, SR1, RL1, PP0, DC1, DT0, C0
Protocol	Conforms to IEEE Std 488.2-1992
IRIG input (/C20 option)	
Connector type	BNC connector x1
Supported IRIG signals	A002, B002, A132, B122
Input impedance	50Ω/5kΩ selectable
Maximum input voltage	±8V
Function	Main unit time synchronization, sample block synchronization
Clock synchronization range	±80ppm
Accuracy after synchronization	No drift against input signal
GPS input (/C30 option)	
Connector type	SMA x1
Receiver type	GPS L1 C/A code SBAS: WAAS EGNOS MSAS
Function	Main unit time synchronization, Sample clock synchronization
Accuracy after synchronization	±200ns (when GPS signal is locked.)

## Measurement Range and Display Range

The measurement range of the ScopeCorder is ±10 divisions (20 divisions of absolute width (span) around 0 V. The display range of the screen is ±5 divisions (10 divisions of span). The following functions can be used to move the displayed waveform and display the waveform outside the display range by expanding/reducing the displayed waveform.

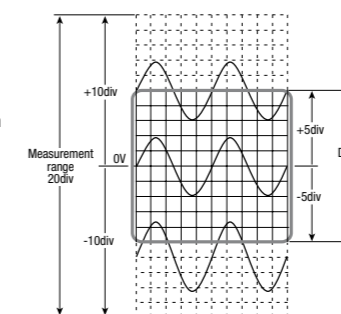

- Move the vertical position.
- Set the offset voltage.
- Zoom in or out of the vertical axis (expand/reduce).

Time for synchronization	Less than 5 minutes after booting
Antenna	Active antenna 3.3V power A1068ER (standard accessory)
Auxiliary I/O section	
EXT CLK IN	BNC connector, TTL level, minimum pulse width 50ns, 9.5MHz or less
EXT TRIG IN	BNC connector, TTL level, rising/falling
EXT TRG OUT	BNC connector, 5VCMOS level, fallen when triggered, and rising when acquisition completed.
EXT I/O	Connector type RJ-11 modular jack
GO/NO-GO determination I/O	Input level TTL or contact input output level 5V CMOS
External start/stop input	Input level TTL or contact input
Manual event	Input level TTL or contact input
Video signal output	D-Sub 15 pin receptacle Analog RGB, quasi XGA output 1024x768 dot, approx 60Hz Vsync
COMP output (probe compensation signal output terminal)	1kHz±1%, 1Vp-p±10%
Probe power output (/P4 option)	Number of terminals: 4, output voltage ±12V
General specifications	
Rated power supply voltage	100 to 120VAC/220 to 240VAC (automatic switching)
Rated power supply frequency	50/60Hz
Maximum power consumption	200VA
Withstand voltage	1500V AC between power supply and earth for 1 minute
Insulation resistance	10MΩ or higher at 500V DC between power supply and earth
External dimensions	Approx. 355mm (W) x 259 mm (H) x 180 mm (D), excluding handle and other projections
Weight	Approx. 6.5kgJ (for main unit only, include /B5/M2/HD1/P4 options, exclude chart paper)
Operating temperature range	5 to 40 °C
12 V DC power (/DC option, for DL850EV only)	
Supply method	Automatic DC/AC switching (with priority on AC), isolated between DC power input terminal and main unit
Rated supply voltage	12 V DC
Allowable supply voltage	10 to 18 V DC
Power consumption	Approx. 150 VA maximum
Voltage input protection circuit	Overcurrent detection: Breaker (15 A) Inverse connection protection: Breaker shutdown Undervoltage detection: Interruption at approx. 9.5 V or lower Overvoltage detection: Interruption at approx. 18 V or more
Withstand voltage	30 V AC between DC power terminal and ground for 1 min
Insulation resistance	10 MΩ or more at 500 V DC between DC power terminal and ground
External dimensions including the main unit	Approx. 355 mm (W) x 259 mm (H) x 202mm (D), excluding the grip and projections
Weight of DC power box	Approx. 800 g
Acquisition Software	
Number of connectable units	1 unit per 1 PC
Interface	USB, Ethernet
Functions	Recording Start/Stop, Monitoring, Setup control Data filing on a PC
Measurement mode	Free-run
Max. transmission rate	100KS/s(16CH)
Max. number of channels	336CH
Operation Conditions	OS: Windows7 (32bit / 64bit), Windows8 (32bit / 64bit) CPU: Intel Core 2 Duo(2GHz) or higher Memory: 1GB or more
Standard operation conditions	
Ambient temperature:	23 ±5 °C
Ambient humidity:	20 to 80 %RH
Errors in power supply voltage/frequency:	Errors in power supply voltage/frequency: Within ±1% of rated voltage, within ±1% of rated frequency warm-up of 30 min. or more, after calibration.
*1 Example when using the 2-CH Voltage Input Module (such as 701250)	
*2 Under the standard operating conditions	
*3 It is not possible to switch a channel associated with the 16-CH Voltage Input Module (720220), 16-CH Temp./Voltage Input Module (720221), CAN Bus Monitor Module (720240), and CAN & LIN Bus Monitor Module (720241) to real-time computation (/G3).	

## Outline drawing

(unit: mm)

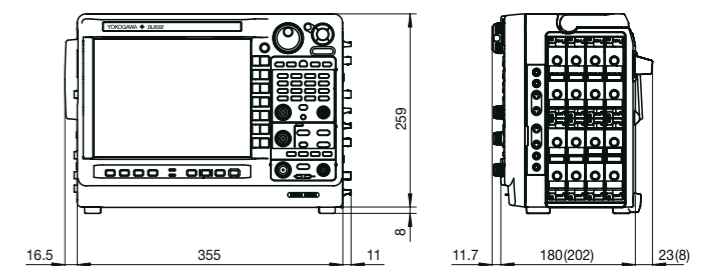

(case without /DC option)

Model/Suffix Code		
Model	Suffix Codes	Description
DL850E		DL850E main unit, 250MPoints memory <sup>1</sup>
DL850EV		DL850EV main unit, 250MPoints memory <sup>1</sup>
Power Code	-D	UL and CSA standard
	-F	VDE standard
	-R	AS standard
	-Q	BS standard (British standard)
	-H	GB standard
	-N	NBR standard
Languages	-HE	English menu and panel
	-HJ	Japanese menu and panel
	-HC	Chinese menu and panel
	-HK	Korean menu and panel
	-HG	German menu and panel
	-HF	French menu and panel
	-HL	Italian menu and panel
-HS	Spanish menu and panel	
Options	/B5	Built-in printer (112mm) <sup>5</sup>
	/DC	DC12 V power (10-18 V DC) (can be specified for DL850EV only) <sup>5</sup>
	/M1	Memory expansion to 1GPoints <sup>2</sup>
	/M2	Memory expansion to 2GPoints <sup>2</sup>
	/HDO	External HDD interface <sup>3</sup>
	/HD1	Internal HDD (500GB) <sup>3</sup>
	/C1	GP-IB interface <sup>4</sup>
	/C20	IRIG and GP-IB interface <sup>4</sup>
	/C30	GPS interface <sup>4,7</sup>
	/G2	User-defined math function
	/G3	Real time math function <sup>6</sup>
	/G5	Power math function (with including Real time math function) <sup>6</sup>
	/P4	Four probe power outputs

<sup>1</sup>: The main unit is not supplied with a plug-in module.  
<sup>2</sup>, <sup>3</sup>, <sup>4</sup>, <sup>5</sup>, and <sup>6</sup>: When selecting these, specify one of them.  
<sup>7</sup>: The /C30 option can be provided only for a nation that is not prohibited by the Radio Law.

Plug-in Module Model Numbers	
Model	Description
720210	High-speed 100 MS/s 12-Bit Isolation Module (2 ch)
720220	Voltage Input Module(16 ch)
720221	16-CH Temperature/Voltage Input Module
701953-L1	16-CH Scanner Box (provided with 1 m cable)
701953-L3	16-CH Scanner Box (provided with 3 m cable)
720230	Logic Input Module (16 ch)
720240	CAN Bus Monitor Module (32 ch, available DL850V only)
720241	CAN & LIN Bus Monitor Module
701250	High-speed 10 MS/s 12-Bit Isolation Module (2 ch)
701251	High-speed 1 MS/s 16-Bit Isolation Module (2 ch)
701255	High-speed 10 MS/s 12-Bit non-Isolation Module (2 ch)
701267	High-voltage 100 kS/s 16-Bit Isolation Module (with RMS, 2 ch)
701261	Universal Module (2 ch)
701262	Universal Module (with Anti-Aliasing Filter, 2 ch)
701265	Temperature/high-precision voltage Module (2 ch)
701270	Strain Module (NDIS, 2 ch)
701271	Strain Module (DSUB, Shunt-CAL, 2 ch)
701275	Acceleration/Voltage Module (with Anti-Aliasing Filter, 2 ch)
701280	Frequency Module (2 ch)

\* Probes are not included with any modules.

Note 1: These modules can be used with the DL750/DL750P/SL1000 and SL1400 as well with some exceptions.  
 Note 2: Up to two 720240 or 720241 modules in total can be installed in a single DL850V main unit.  
 Note 3: Max. four(4) 720210 modules can be installed in a main unit.  
 Note 4: The use of a 720221 module always requires the External Scanner Box (model 701953).  
 Note 5: The firmware ver2.00 or later is required when using 720221 and/or 720241 module.  
 Note 6: The firmware ver2.20 or later is required when using 701267 module.

Probes, Cables, and Converters		
Product	Model No.	Description <sup>1</sup>
100:1 Isolation Probe	701947	1000 V (DC+ACpeak) CAT II
10:1 Probe (for Isolated BNC Input)	700929	1000 V (DC+ACpeak) CAT II
1:1 Safety BNC Adapter Lead (in combination with followings)	701901	1000 Vrms-CAT II
Safety Mini-Clip (Hook type)	701959	1000 Vrms-CAT II, 1 set each of red and black
Large Alligator-Clip (Dolphin type)	701954	1000 Vrms-CAT II, 1 set each of red and black
Alligator Clip Adaptor Set (Rated Voltage 1000 V)	758929	1000 Vrms-CAT II, 1 set each of red and black
Alligator Clip Adaptor Set (Rated Voltage 300 V)	758922	300 Vrms-CAT II, 1 set each of red and black
Fork Terminal Adapter Set	758321	1000 Vrms-CAT II, 1 set each of red and black
Passive Probe <sup>2</sup>	701940	Non-isolated 600 Vpk (701255)(10:1)
1:1 BNC-Alligator Cable	366926	Non-isolated 42 V or less, 1m
1:1 Banana-Alligator Cable	366961	Non-isolated 42 V or less, 1.2m
Current Probe <sup>3</sup>	701933	30 Arms, DC to 50 MHz, supports probe power
Current Probe <sup>3</sup>	701930	150 Arms, DC to 10 MHz, supports probe power
Current Probe <sup>3</sup>	701931	500 Arms, DC to 2 MHz, supports probe power
Probe Power Supply <sup>4</sup>	701934	Large current output, external probe power supply (4 outputs)
Shunt Resistor	438920	250 Ω±0.1%
Shunt Resistor	438921	100 Ω±0.1%
Shunt Resistor	438922	10 Ω±0.1%
Differential Probe	700924	1400 Vpk, 1000 Vrms-CAT II
Differential Probe	700925	500 Vpk, 350 Vrms (For 701255)
Differential Probe	701926	7000Vpk, 5000Vrms
Bridge Head (NDIS, 120 Ω/350 Ω)	701955/56	With 5 m cable
Bridge Head (DSUB, Shunt-CAL, 120 Ω/350 Ω)	701957/58	With 5 m cable
Safety BNC-banana Adapter	758924	500 Vrms-CAT II
Printer Roll Paper	B9988AE	For DL750, DL850E, DL850EV, 10 mx 10
Logic Probe <sup>5</sup>	702911	8-Bit, 1 m, non-Isolated, TTL level/Contact Input
Logic Probe <sup>5</sup>	702912	8-Bit, 3 m, non-Isolated, TTL level/Contact Input
High-speed Logic Probe <sup>5</sup>	700986	8-Bit, non-Isolated, response speed: 1 μs
Isolated Logic Probe <sup>5</sup>	700987	8-Bit, each channel isolated
Measurement Lead Set	758917	Measurement leads (2 per set) Alligator-Clip is required separately.
	758933	1000 V/19 A/1 m length Alligator-Clip is required
Safety BNC-BNC Cable (1 m)	701902	1000 Vrms-CAT II (BNC-BNC)
Safety BNC-BNC Cable (2 m)	701903	1000 Vrms-CAT II (BNC-BNC)
External I/O Cable	720911	For external I/O connection
Plug-On Clip	701948	For 700929 and 701947
Long Test Clip	701906	For 700924 and 701926
Terminal	A1800JD	For 720220 input terminal, one (1) piece
Soft Carrying Case	701963	For DL850E/DL850EV/DL750
Connecting cables	705926	Connecting cable for 701953 (1 m)
	705927	Connecting cable for 701953 (3 m)
DC Power Supply Cable (Alligator clip type)	701971	For DL850EV DC 12 V Power
DC Power Supply Cable (Cigarette lighter plug type)	701970	For DL850EV DC 12 V Power
DC Power Supply Connector	B8023WZ	It comes standard with the /DC option
GPS antenna	A1058ER	It comes standard with the /C30 option

<sup>1</sup> Actual allowable voltage is the lower of the voltages specified for the main unit and cable.  
<sup>2</sup> 42 V is safe when using the 701940 with an isolated type BNC input.  
<sup>3</sup> The number of current probes that can be powered from the main unit's power supply is limited.  
<sup>4</sup> Any number of externally powered probes can be used.  
<sup>5</sup> Includes one each of the B9879PX and B9879KX connection leads.  
<sup>6</sup> Additionally, 758917 and either the 758922 or 758929 are required for measurement.

SCOPECORDER **isoPRO** **GIGASET** are trademarks, pending trademarks or registered trademarks of Yokogawa Electric Corporation.

\* Any company's names and product names mentioned in this document are trade names, trademarks or registered trademarks of their respective companies.  
 The User's Manuals of this product are provided by CD-ROM.

## Yokogawa's Approach to Preserving the Global Environment

- Yokogawa's electrical products are developed and produced in facilities that have received ISO14001 approval.
- In order to protect the global environment, Yokogawa's electrical products are designed in accordance with Yokogawa's Environmentally Friendly Product Design Guidelines and Product Design Assessment Criteria.

**YOKOGAWA EUROPE B.V.** Euroweg 2, 3825 HD, Amersfoort, The Netherlands.  
 Phone: (31)-88-4641000, Fax: (31)-88-4641111 tmi@nl.yokogawa.com

**YOKOGAWA METERS & INSTRUMENTS CORPORATION**  
 Global Sales Dept. /Phone: +81-42-534-1413 Facsimile: +81-42-534-1426  
 E-mail: tm@cs.jp.yokogawa.com

**YOKOGAWA CORPORATION OF AMERICA** Phone: (1)-770-253-7000, Fax: (1)-770-254-0928

**YOKOGAWA ENGINEERING ASIA PTE. LTD.** Phone: (65)-62419933, Fax: (65)-62412606

Subject to Change without notice.  
 Copyright©2013 Yokogawa Europe B.V.

[Ed: 01] printed in the Netherlands