



## Table of Contents

Introduction.....	3
Product Inspection .....	5
The QSFP28 Test Adapter Care and Handling Precautions .....	6
General Test Adapter, Cable, and Connector.....	8
Handling and Storage .....	8
Visual Inspection.....	8
Cleaning .....	8
Making Connections .....	8
Electrostatic Discharge Information.....	9
User Model .....	10
Calibration Through De-Embedding (Preliminary) .....	13
Mechanical and Environmental Specifications.....	14
Electrical Specifications .....	20
QSFP28 Test Adapter Reference Information .....	31
Wilder Technologies, LLC – Limited Warranty .....	32
Wilder Technologies, LLC – Terms & Conditions of Sale .....	33
Compliance with Environmental Legislation .....	34
WEEE Compliance Statement.....	34
Glossary of Terms .....	35
Addendum A – QSFP28 Receptacle Test Adapter with Power Sinking .....	36
Power Sinking Version Receptacle Test Adapter.....	36
Index .....	37

## Introduction

This user's guide documents the QSFP28 Plug and Receptacle Test Adapters (QSFP28-TPA100G-HCB-P and QSFP28-TPA100G-MCB-R). The two test adapter types, shown in Figures 1 and 2, test QSFP28 interface cables, hosts, and modules to the requirements of the SFF-8665 specification. Addendum A also provides reference information as it pertains to the Power Sinking version of the Receptacle Test Adapter (QSFP28-TPA100GH-MCB-R).

The -HCB-P and -MCB-R test adapter assemblies allow easy access, via SMA connections, to measure or inject data signals.

**NOTE: To avoid damaging the cables, use the handling techniques described in the Care and Handling section before making any connections or configuring a test setup.**

**Always use a static-safe workstation when performing tests, as explained in the "Electrostatic Discharge Information" section.**

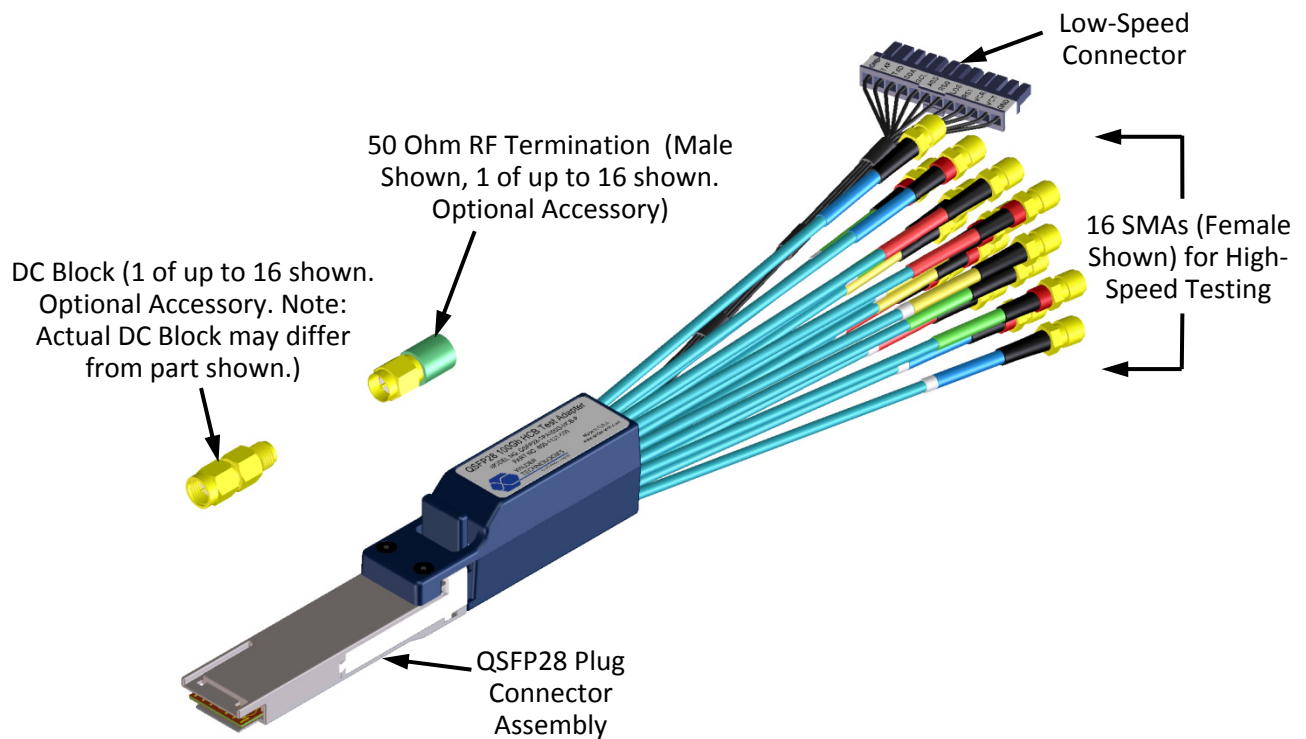

**Figure 1. The QSFP28 HCB Test Adapter tests to the requirements of the Host Compliance Board (Plug)**  
(Note: Coaxial cables shown are illustrated shorter than those used in the test adapter. The coaxial cables are configuration dependent and may be terminated with different SMA connectors than what is shown.)

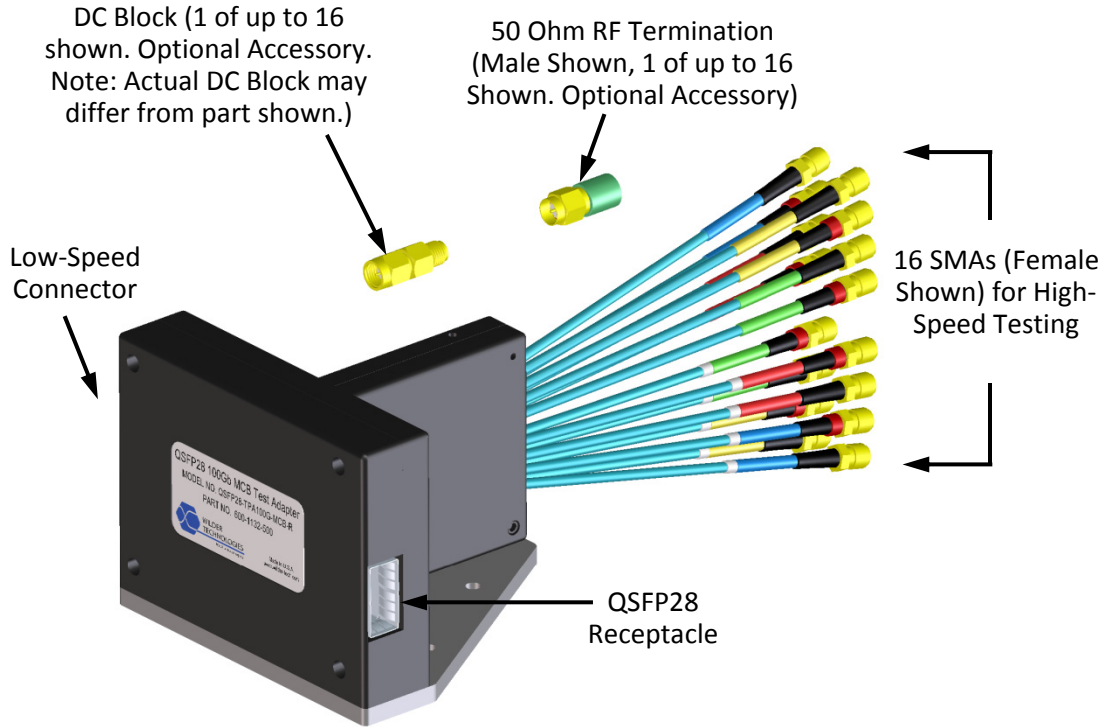

Figure 2. The QSFP28 MCB Test Adapter tests to the requirements of the Module Compliance Board (Receptacle). (Note: Coaxial cables shown are illustrated shorter than those used in the test adapter. The coaxial cables are configuration dependent and may be terminated with different SMA connectors than what is shown.)

**NOTE: The metal shell of both the plug (QSFP28-TPA100G-HCB-P) and receptacle (QSFP28-TPA100G-MCB-R) connectors tie high-speed ground to chassis ground.**

The low-speed 12-position receptacle and plug connectors are keyed and latching (Molex part number 43645-1200 for the plug TPA and 43650-1204 for the receptacle TPA). The mating connector housings and contact pins for 26-30awg wire are Molex part number 43640-1201 for the 12-position housing and 43031-0011 for the plug contacts used with the plug TPA, and Molex part number 43645-1200 for the 12-position housing and 43030-0011 for the receptacle contacts used with the receptacle TPA. Replacement parts can be purchased through Molex distributors.

**NOTE: The receiver SMA connections for QSFP28 are normally AC coupled. The QSFP28 plug and receptacle TPAs do NOT have internal DC Blocks. This allows for parametric testing through the TPAs. Normal testing may require DC Blocks (May be optionally ordered from Wilder Technologies). Refer to the Electrical Specifications section of this document for DC Block performance parameters.**

## Product Inspection

Upon receiving the QSFP28-TPA100G from Wilder Technologies, perform the following product inspection:

- Inspect the outer shipping container, foam-lined instrument case, and product for damage. Retain the outer cardboard shipping container until the contents of the shipment have been inspected for completeness and the product has been checked mechanically and electrically. Use the foam-lined instrument-case for secure storage of the Wilder Technologies QSFP28 Test Adapter when not in use.
- Locate the shipping list and verify that all items ordered were received.
- In the unlikely event that the product is defective or incomplete, the “Limited Warranty” section discusses how to contact Wilder Technologies for technical assistance and/or how to package the product for return.

## The QSFP28 Test Adapter Care and Handling Precautions

The QSFP28 Test Adapter requires careful handling to avoid damage. Improper handling techniques, or using too small a cable bend radius, can damage the coaxial cable connections within the adapter housing or the cables themselves. This can occur at any point along the cable. To achieve optimum performance and to prolong the QSFP28 TPA's life, observe the following handling precautions:

- **CAUTION 1: Avoid Torque Forces (Twisting)**  
While individual coaxial cables within the test adapter have some rotational freedom, twisting the QSFP28-TPA100G as a unit, with one end held stationary, may damage or severely degrade performance. Adherence to Caution 5 (below) helps to avoid twisting.
- **CAUTION 2: Avoid Sharp Cable Bends**  
Never bend coaxial cables into a radius of 26 mm (1-inch) or less. Never bend cables greater than 90°. Single or multiple cable bends must be kept within this limit. Bending the QSFP28-TPA100G cables less than a 26mm (1-Inch) radius will permanently damage or severely degrade test adapter performance.
- **CAUTION 3: Avoid Cable Tension (Pull Forces)**  
Never apply tension (pull forces) to an individual coaxial cable that is greater than 2.3 kg (5 lbs.). To avoid applying tension, always place accessories and equipment on a surface that allows adjustment to eliminate tension on the QSFP28-TPA100G and cables. Use adjustable elevation stands or apparatus to accurately place and support the QSFP28 TPA.
- **CAUTION 4: Connect the QSFP28-TPA100G First**  
To prevent twisting, bending, or applying tension to the coaxial cables when connecting a QSFP28 TPA, always attach the QSFP28-TPA100G to the device under test (DUT) or cable under test before attaching any SMA connectors. Carefully align the QSFP28 connectors and then gently push the connectors together until fully seated.

If the QSFP28-TPA100G must be turned or twisted to make connection to the DUT, avoid using the QSFP28-TPA100G housing alone to make this occur. Try to distribute the torque forces along the length of the test setup and cabling. If this is not possible, it is recommended to first loosen or disconnect the SMA connections at the QSFP28 TPA, make the connection to the DUT and then re-tighten or attach the test equipment leads.

---

**NOTE: Only grip the test adapter housing when inserting or extracting the QSFP28-TPA100G to or from the DUT. Pulling directly on the QSFP28-TPA100G cables or using them to insert the QSFP28-TPA100G may cause damage.**

---

- **CAUTION 5: Carefully Make SMA Connections**  
To connect the QSFP28-TPA100G SMA connectors, follow these steps:
  1. Hold the cable stationary by grasping the cable at the black heat-shrink section near the SMA connector.
  2. Insert the mating SMA barrel and hand-tighten the free-spinning SMA nut onto the connector while avoiding pulling, bending, or twisting the QSFP28-TPA100G coaxial cable.

3. The QSFP28-TPA100G SMA connectors have flats that accept an open-end 1/4-inch or 5/16-inch wrench, depending on configuration. When attaching instrument cables to the QSFP28 TPA100G, it is recommended that the QSFP28 TPA100G SMA connectors be mechanically held and the test leads be tightened to the equipment manufacturer's torque recommendations, normally 5 in-lbs, using an open-end torque wrench.

If the test set-up requires repositioning, first loosen or disconnect the SMA connections to avoid twisting, bending, or tension.

---

**NOTE: A drop in signal amplitude by half or 6dB during the testing of a channel may indicate that a cable has been mechanically pulled free of coaxial cable connections internal to the assembly. This could be determined by checking if the cable has any lateral play relative to the TPA. This would only occur when the TPA has exceeded the pull force as specified within the mechanical specification. If the cable cannot be re-seated, the test adapter will need to be sent back to the factory for service.**

---

- **CAUTION 6: Independently Support Instrument Cables or Accessories**  
Excessive weight from instrument cables and/or accessories connected to the QSFP28 TPA100G can cause damage or affect the test adapter performance. Be sure to provide appropriate means to support and stabilize all test set-up components.
- **CAUTION 7: ESD Sensitivity**  
The QSFP28 test adapters are passive components and are not in themselves sensitive to electrostatic discharge. However, when an active DUT is installed, that device becomes susceptible to ESD. Observe proper ESD precautions, further discussed later in this document.

## General Test Adapter, Cable, and Connector

Observing simple precautions can ensure accurate and reliable measurements.

### Handling and Storage

Before each use of the QSFP28 TPA100G, ensure that all connectors are clean. Handle all cables carefully and store the QSFP28-TPA100G in the foam-lined instrument case when not in use, if possible. Do not set connectors contact end down. Install the SMA protective end caps when the QSFP28-TPA100G is not in use.

### Visual Inspection

Be sure to inspect all cables carefully before making a connection. Inspect all cables for metal particles, scratches, deformed threads, dents, or bent, broken, or misaligned center conductors. Do not use damaged cables.

### Cleaning

If necessary, clean the connectors using low-pressure (less than 60 PSI) compressed air or nitrogen with an effective oil-vapor filter and condensation trap. Clean the cable threads, if necessary, using a lint-free swab or cleaning cloth moistened with isopropyl alcohol. Always completely dry a connector before use. Do not use abrasives to clean the connectors. Re-inspect connectors, making sure no particles or residue remains.

### Making Connections

Before making any connections, review the “Care and Handling Precautions” section. Follow these guidelines when making connections:

- Align cables carefully
- Make preliminary connection lightly
- To tighten, turn connector nut only
- Do not apply bending force to cable
- Do not over-tighten preliminary connections
- Do not twist or screw-in cables
- Use an appropriately sized torque wrench, and do not tighten past the “break” point of the torque wrench (normally 5 inch pounds)



## Electrostatic Discharge Information

Protection against electrostatic discharge (ESD) is essential while connecting, inspecting, or cleaning the QSFP28-TPA100G test adapter and connectors attached to a static-sensitive circuit (such as those found in test sets).

Electrostatic discharge can damage or destroy electronic components. Be sure to perform all work on electronic assemblies at a static-safe work station, using two types of ESD protection:

- Conductive table-mat and wrist-strap combination
- Conductive floor-mat and heel-strap combination

When used together, both of these types provide a significant level of ESD protection. Used alone, the table-mat and wrist-strap combination provide adequate ESD protection. To ensure user safety, the static-safe accessories must provide at least 1 M $\Omega$  of isolation from ground. Acceptable ESD accessories may be purchased from a local supplier.

---

**WARNING: These techniques for a static-safe work station should not be used when working on circuitry with a voltage potential greater than 500 volts.**

---

## User Model

The QSFP28 TPAs are capable of performing to the requirements of SFF-8665, limited only by the specifications, environmental, care and handling of this document.

In the case where the laboratory source or load is not used in the test, it must be replaced with RF terminations on each unused signal. (RF terminators are optionally offered by Wilder Technologies.)

The following examples are suggestions for possible testing setups.

In this first example, a QSFP28-TPA100G-MCB-R is used to test a QSFP28 Module:

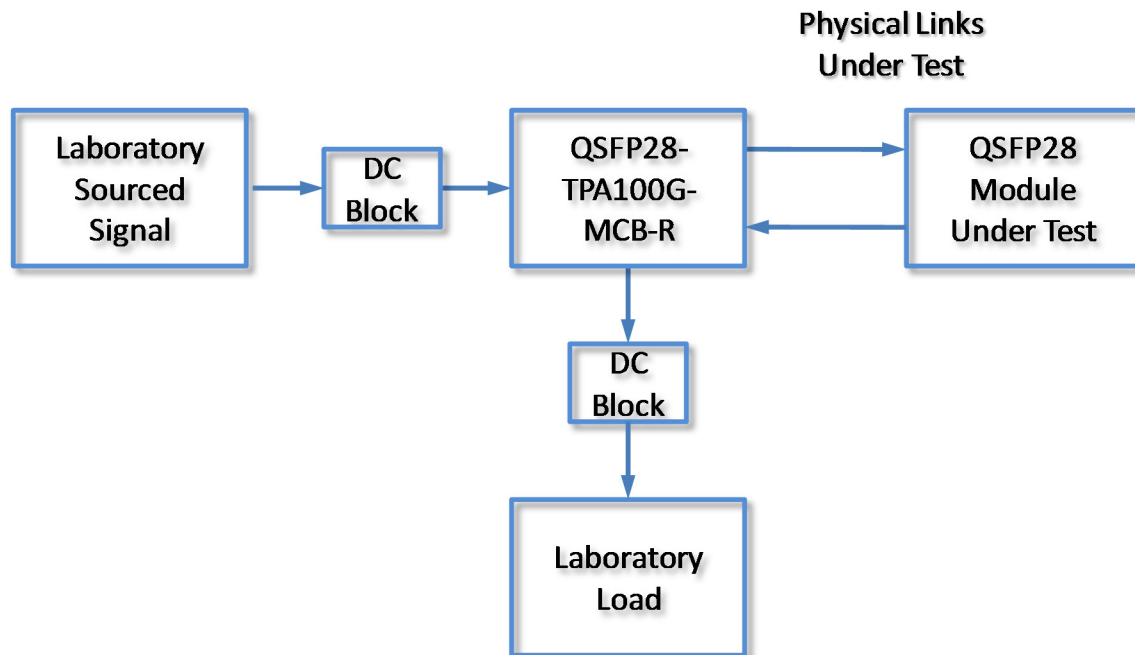

## QSFP28 Test Adapter User Manual (Preliminary)

---

The second example shows a QSFP28-TPA100G-HCB-P is used to test a host:

In the case where the laboratory source or load is not used in the test, it must be replaced with RF terminations on each unused signal. (RF terminators are optionally offered by Wilder Technologies.)

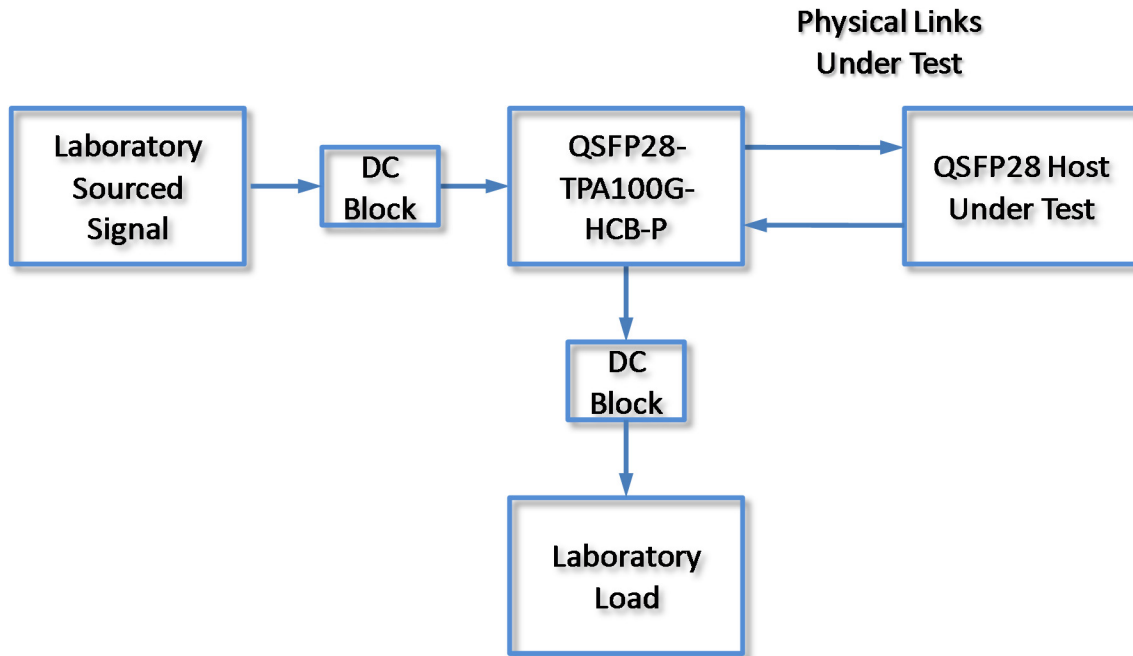

The third example shows two QSFP28-TPA100G-MCB-R's used for testing a QSFP28 cable:

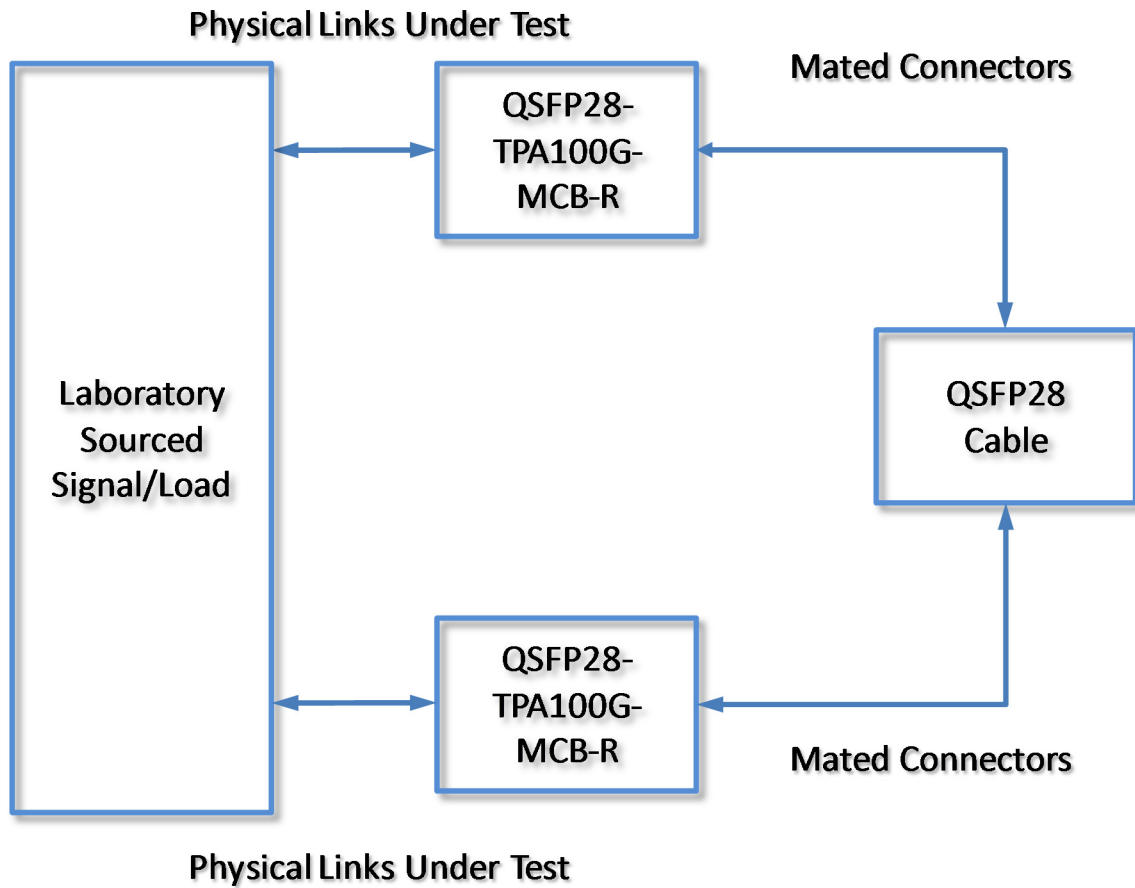

## Calibration Through De-Embedding (Preliminary)

The QSFP28 Test Adapters are fully passive components. Therefore, calibration compensating for the losses must occur within the test instrumentation that drives the QSFP28 Receivers or looks at the response of the QSFP28 Transmitters.

The QSFP28-TPA's have Touchstone S4P files for de-embedding the electrical length and losses within the TPA up to the QSFP28 connector interface pads. (Contact Wilder Technologies, [support@wilder-tech.com](mailto:support@wilder-tech.com), to obtain a copy of the S4P files.) The Touchstone S4P files enable the test engineer to compensate for the last four of the following six repeatable, systematic errors that occur when moving the reference plane:

- Signal leakage effects: *Directivity errors*
- Signal leakage effects: *Crosstalk errors*
- Reflection effects: *Source Impedance Mismatching errors*
- Reflection effects: *Load Impedance Mismatching errors*
- Bandwidth effects: *Receiver Transmission in Test Equipment errors*
- Bandwidth effects: *Receiver Reflection-tracking in Test Equipment errors*

These errors are corrected on each port. Refer to the Instrument Manual for instructions on the instrument's specific de-embedding process.

---

**NOTE: The reference plane is the boundary, both physically and electrically, between the calibrated and uncalibrated portions of the circuit. Everything outside the reference plane is considered part of the DUT. Any instrument that does not use calibration or de-embedding of the test fixture defines the DUT as the total of externally connected components. If the de-embedding file is not used, all of the QSFP28-TPA and associated coaxial cables, as well as cables connecting the TPA assembly to the test instrument, would be a part of the DUT.**

---

Non-repeatable errors, such as drift or random errors, can be reduced but not corrected. Drift errors aggregate over time or with environmental changes such as temperature shift. To eliminate drift errors, perform an instrumentation-level calibration.

A random error cannot be corrected through calibration since the error occurred randomly. Random errors are typically associated with either test instrument noise or test repeatability problems. Reduce test instrument noise by increasing source power, lowering the IF bandwidth, or averaging results over multiple sweeps. Reduce test repeatability problems through the use of a torque wrench or, again, by averaging over multiple sweeps.

## Mechanical and Environmental Specifications

**NOTE: All specifications in this manual are subject to change.**

**Table 1. General Specifications**

ITEM	DESCRIPTION
Usage Environment	Controlled indoor environment
Plug Test Adapter Length (w/standard cables)	406.40 mm +/- 2 mm (16.00 inches +/- .08 inches) (Characteristic)
Receptacle Test Adapter Length (w/standard cables, end to end)	199.40 mm +/- 2 mm (7.85 inches +/- .08 inches) (Characteristic)
Receptacle Test Adapter Housing Dimensions	95.25 x 93.98 x 74.93 (3.75 x 3.70 x 2.95 inches) (L, W, H)
Operating Temperature	0°C to +55°C (32°F to +131°F) (Characteristic)
Storage Temperature	-40°C to +70°C (-40°F to +158°F) (Characteristic)

### QSFP28-TPA100G-HCB-P and QSFP28-TPA100G-MCB-R Cable Pinout

The QSFP28-TPA100G cables provide sixteen SMA connectors (four lanes of primary differential TX and RX). Labels clearly mark each cable or connector. The following figure refers to the pin-description table for the plug connector.

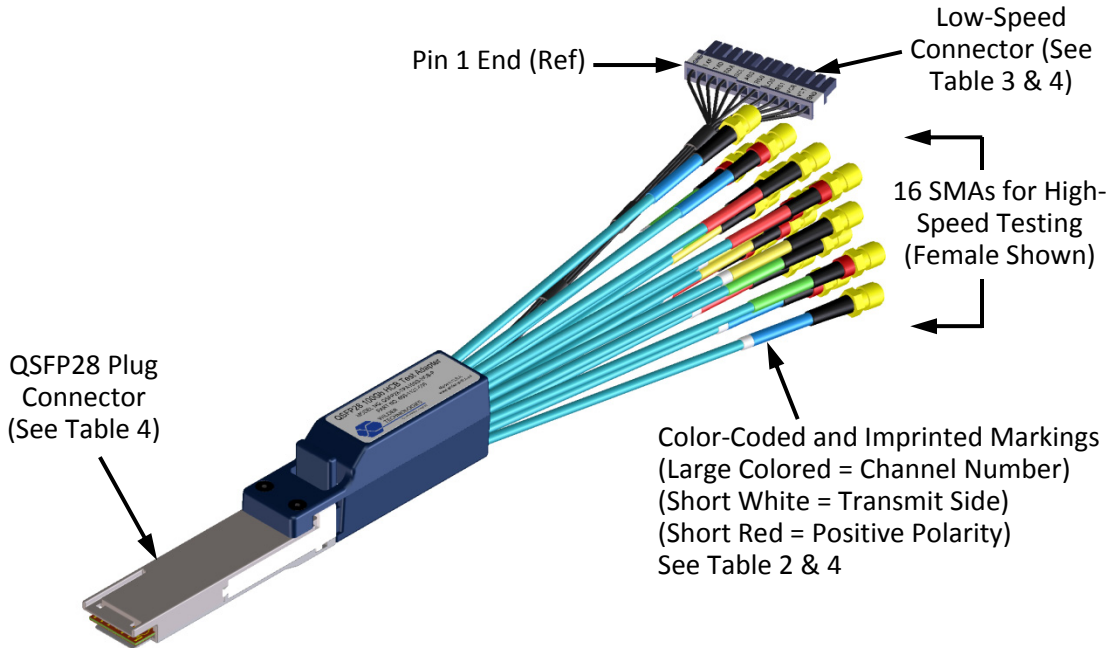
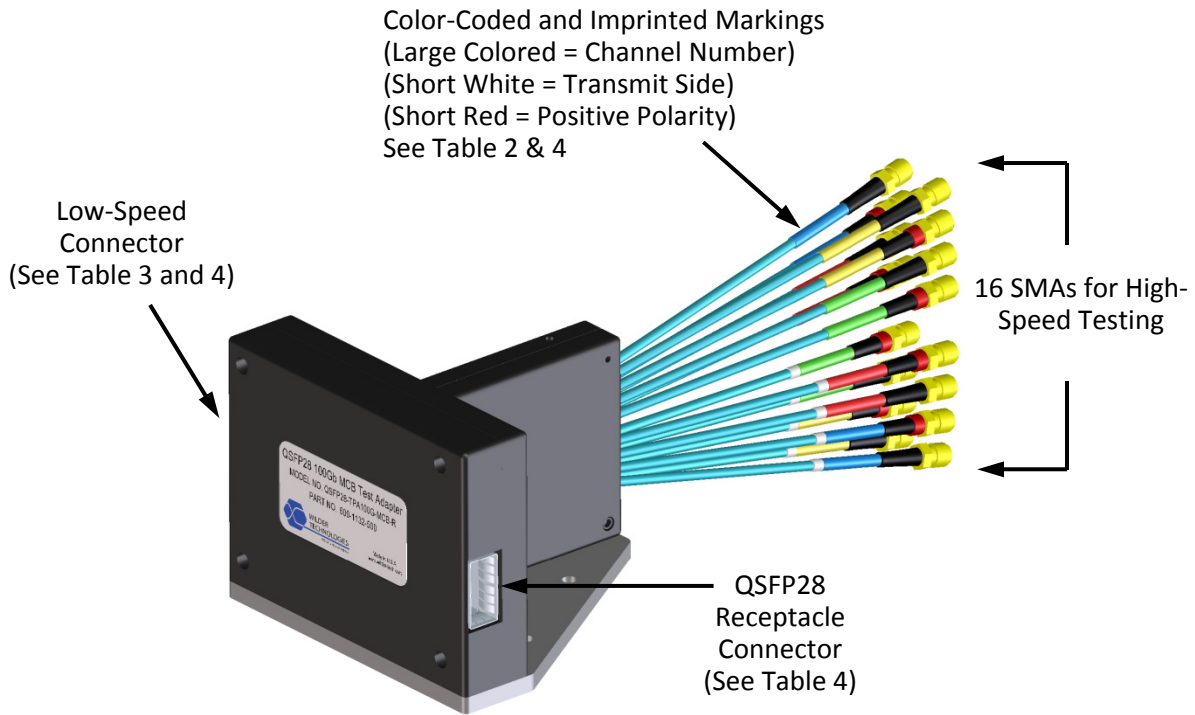

**Figure 3. Cable Connectors (QSFP28-TPA100G-HCB-P shown)**

(Note: Coaxial cables shown are illustrated shorter than those used in the test adapter. The coaxial cables are configuration dependent and may be terminated with different SMA connectors than what is shown.)

## QSFP28 Test Adapter User Manual (Preliminary)

The following figure refers to the pin-description table for the receptacle connector.



**Figure 4. Cable Connectors (QSFP28-TPA100G-MCB-R shown)**  
(Note: Coaxial cables shown are illustrated shorter than those used in the test adapter. The coaxial cables are configuration dependent and may be terminated with different SMA connectors than what is shown.)

**Table 2. SMA Cable Connectors (High-Speed)**

<b>LABEL</b>	<b>COLOR ID FOR DIFFERENTIAL PAIR</b>	<b>DESCRIPTION</b>
RX4+	Red	Lane 4 Receiver positive
RX4-	Red	Lane 4 Receiver negative
RX3+	Green	Lane 3 Receiver positive
RX3-	Green	Lane 3 Receiver negative
RX2+	Blue	Lane 2 Receiver positive
RX2-	Blue	Lane 2 Receiver negative
RX1+	Yellow	Lane 1 Receiver positive
RX1-	Yellow	Lane 1 Receiver negative
TX4+	Red with White band	Lane 4 Transmitter positive
TX4-	Red with White band	Lane 4 Transmitter negative
TX3+	Green with White band	Lane 3 Transmitter positive
TX3-	Green with White band	Lane 3 Transmitter negative
TX2+	Blue with White band	Lane 2 Transmitter positive
TX2-	Blue with White band	Lane 2 Transmitter negative
TX1+	Yellow with White band	Lane 1 Transmitter positive
TX1-	Yellow with White band	Lane 1 Transmitter negative



Table 3. QSFP28-TPA100G 12-Position Cable Connector (Low-Speed)

LABEL	PIN NO.	COLOR ID FOR HCB/MCB	DESCRIPTION
GND	Pin 1	Black/NA	Signal (RF Ground) and Supply (Power) Common
MPL	Pin 2	Black/NA	Module Present
ITL	Pin 3	Black/NA	Interrupt
SDA	Pin 4	Black/NA	SDA, I <sup>2</sup> C Data for DDC
SCL	Pin 5	Black/NA	SCL, I <sup>2</sup> C Clock for DDC
RSL	Pin 6	Black/NA	Module Reset
MSL	Pin 7	Black/NA	Module Select
LPM	Pin 8	Black/NA	Low Power Mode
VCC	Pin 9	Black/NA	Vcc1 module power supply (+3.3V)
VCR	Pin 10	Black/NA	VccR, module receiver power supply (+3.3V)
VCT	Pin 11	Black/NA	VccT, module transmitter power supply (+3.3V)
GND	Pin 12	Black/NA	Signal (RF Ground) and Supply (Power) Common

## QSFP28 Test Adapter User Manual (Preliminary)

**Table 4. QSFP28-TPA100G Plug and Receptacle Pin Assignments**

Pin Description	Connector Pin Number	Destination Number (HCB/MCB)	Color ID for Data Line Polarity	Color Identification (HCB/MCB)
Ground	1	P2/J2 Pin 1, Pin 12	N/A	Black Insulation/NA
Tx2n	2	Tx2-	Black	White/Blue
Tx2p	3	Tx2+	Red	White/Blue
Ground	4	P2/J2 Pin 1, Pin 12	N/A	Black Insulation/NA
Tx4n	5	Tx4-	Black	White/Red
Tx4p	6	Tx4+	Red	White/Red
Ground	7	P2/J2 Pin 1, Pin 12	N/A	Black Insulation/NA
MSL	8	P2/J2 Pin 7	N/A	Black Insulation/NA
RSL	9	P2/J2 Pin 6	N/A	Black Insulation/NA
VccR (Filtered)	10	P2/J2 Pin 10	N/A	Black Insulation/NA
SCL	11	P2/J2 Pin 5	N/A	Black Insulation/NA
SDA	12	P2/J2 Pin 4	N/A	Black Insulation/NA
Ground	13	P2/J2 Pin 1, Pin 12	N/A	Black Insulation/NA
Rx3p	14	Rx3+	Red	Green
Rx3n	15	Rx3-	Black	Green
Ground	16	P2/J2 Pin 1, Pin 12	N/A	Black Insulation/NA
Rx1p	17	Rx1+	Red	Yellow
Rx1n	18	Rx1-	Black	Yellow
Ground	19	P2/J2 Pin 1, Pin 12	N/A	Black Insulation/NA
Ground	20	P2/J2 Pin 1, Pin 12	N/A	Black Insulation/NA
Rx2n	21	Rx2-	Black	Blue
Rx2p	22	Rx2+	Red	Blue
Ground	23	P2/J2 Pin 1, Pin 12	N/A	Black Insulation/NA
Rx4n	24	Rx4-	Black	Red
Rx4p	25	Rx4+	Red	Red
Ground	26	P2/J2 Pin 1, Pin 12	N/A	Black Insulation/NA
MPL	27	P2/J2 Pin 2	N/A	Black Insulation/NA

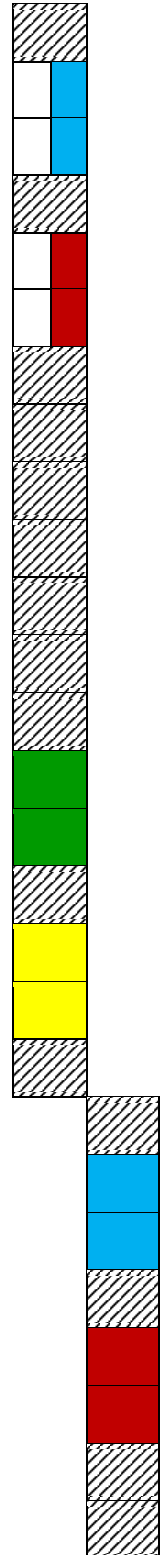

## QSFP28 Test Adapter User Manual (Preliminary)

ITL	28	P2/J2 Pin 3	N/A	Black Insulation/NA
VccT (Filtered)	29	P2/J2 Pin 11	N/A	Black Insulation/NA
Vcc1 (Filtered)	30	P2/J2 Pin 9	N/A	Black Insulation/NA
LPM	31	P2/J2 Pin 8	N/A	Black Insulation/NA
Ground	32	P2/J2 Pin 1, Pin 12	N/A	Black Insulation/NA
Tx3p	33	Tx3+	Red	White/Green
Tx3n	34	Tx3-	Black	White/Green
Ground	35	P2/J2 Pin 1, Pin 12	N/A	Black Insulation/NA
Tx1p	36	Tx1+	Red	White/Yellow
Tx1n	37	Tx1-	Black	White/Yellow
Ground	38	P2/J2 Pin 1, Pin 12	N/A	Black Insulation/NA

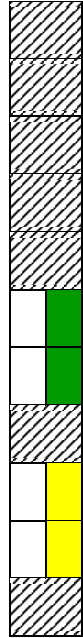

## Electrical Specifications

**NOTE: All specifications in this manual are subject to change.**

**Table 5. Electrical Specifications (TPA)**

SPECIFICATION	MIN	TYP	MAX	NOTES
SDD21 (dB), at 12.89 GHz		-1.7		HCB TPA without Connector and Pad.
SDD21 (dB), at 7.03 GHz		-1.2		HCB TPA without Connector and Pad.
SDD21 (dB), at 12.89 GHz		-TBD		MCB TPA without Connector and Pad.
SDD21 (dB), at 7.03 GHz		-TBD		MCB TPA without Connector and Pad.
SDD21 (dB), at 12.89 GHz		-4.0		Mated HCB and MCB TPAs with Connectors and Pads.
SDD21 (dB), at 7.03 GHz		-2.35		Mated HCB and MCB TPAs with Connectors and Pads.
SDD11 (dB), at 12.89 GHz		-9		Mated HCB and MCB TPAs with Connectors and Pads.
SDD11 (dB), at 7.03 GHz		-16		Mated HCB and MCB TPAs with Connectors and Pads.
SDC21 (dB), at 12.89 GHz		-20.0		Mated HCB and MCB TPAs with Connectors and Pads.
SDC21 (dB), at 7.03 GHz		-25.0		Mated HCB and MCB TPAs with Connectors and Pads.
Differential Impedance (ohms), 34 ps Rise Time, 20 –80%	90		110	All Differential Pairs, Receptacle and Plug, excluding QSFP28 connector.
Differential Impedance (ohms), 34 ps Rise Time, 20 –80%	80		120	All Differential Pairs, Receptacle and Plug, including QSFP28 connector.
Impedance (ohms), 34 ps Rise Time, 20 –80%	45		55	Single-ended signals within differential pairs, Receptacle and Plug, excluding QSFP28 connector.
Intra-pair Skew (ps)	-3?		3?	All Differential Pairs, Receptacle and Plug.
Inter-pair Skew (ps)	-6		6	All Differential Pairs, Receptacle and Plug.
NEXT (dB), at 10 GHz	-30	-40		Single aggressor, with QSFP28 connector, mated HCB to MCB, with standard coaxial cables and terminations.

**QSFP28 Test Adapter User Manual (Preliminary)**

**Table 6. Electrical Specifications (Optional External DC Block) as Supplied by Wilder Technologies**

SPECIFICATION	MIN	TYP	MAX	NOTES
Insertion Loss (dB), at 100 kHz - 12.4 GHz at 12.4 - 26.5 GHz		0.50 0.75		
VSWR, 7kHz TO 26.5 GHz			1.35	
Upper -3dB Bandwidth (GHz)	26.5			
Lower -3dB Bandwidth (kHz)			7	
Voltage		100 Volts Max.		
In-Line Capacitance (μF)		0.474		
Impedance (Ohms)		50		

**Table 7. Electrical Specifications (Optional RF Termination) as Supplied by Wilder Technologies**

SPECIFICATION	MIN	TYP	MAX	NOTES
VSWR, DC to 4 GHz 4 to 12.4 GHz 12.4 to 18 GHz			1.05 1.15 1.20	
Frequency Range (GHz)	DC		18	
Power Dissipation (Watts)			2	Power derates linearly from 100% ≤ 25°C to 10% @ 125°C
Impedance (Ohms)		50		

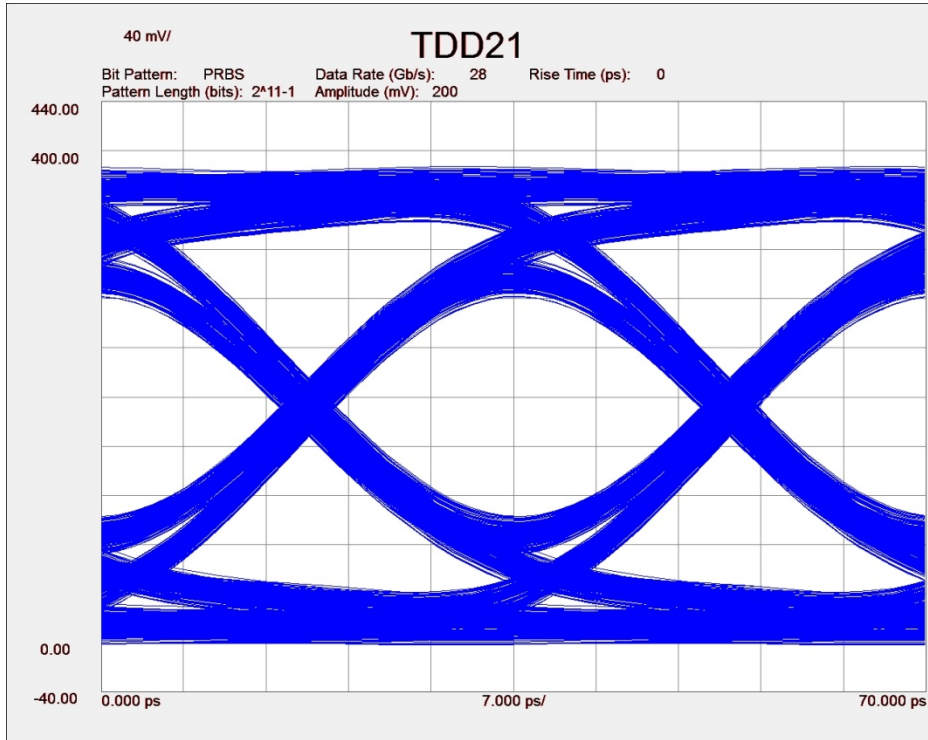

Figure 5. Typical mated pair 28 Gb/s eye diagram.

Parameter Measurement Result

Name	Measurement Result
Eye Level Zero(mV)	53.99
Eye Level One(mV)	330.75
Eye Level Mean(mV)	192.37
Eye Amplitude(mV)	276.76
Eye Height(mV)	167.48
Eye Height(db)	-7.76
Eye Width	3.03e-011
Eye Opening Factor	0.61
Eye Signal_to_Noise	4.43
Eye Duty Cycle Dist	-2.25e-012
Eye Duty Cycle Dist(%)	-6.31
Eye Rise Time (20-80)	1.90e-011
Eye Fall Time (80-20)	1.86e-011
Eye Jitter(PP)	5.46e-012
Eye Jitter(RMS)	1.32e-012

S<sub>11</sub> Param DUT Files Meas

Figure 6. Typical mated pair 28 Gb/s eye data.

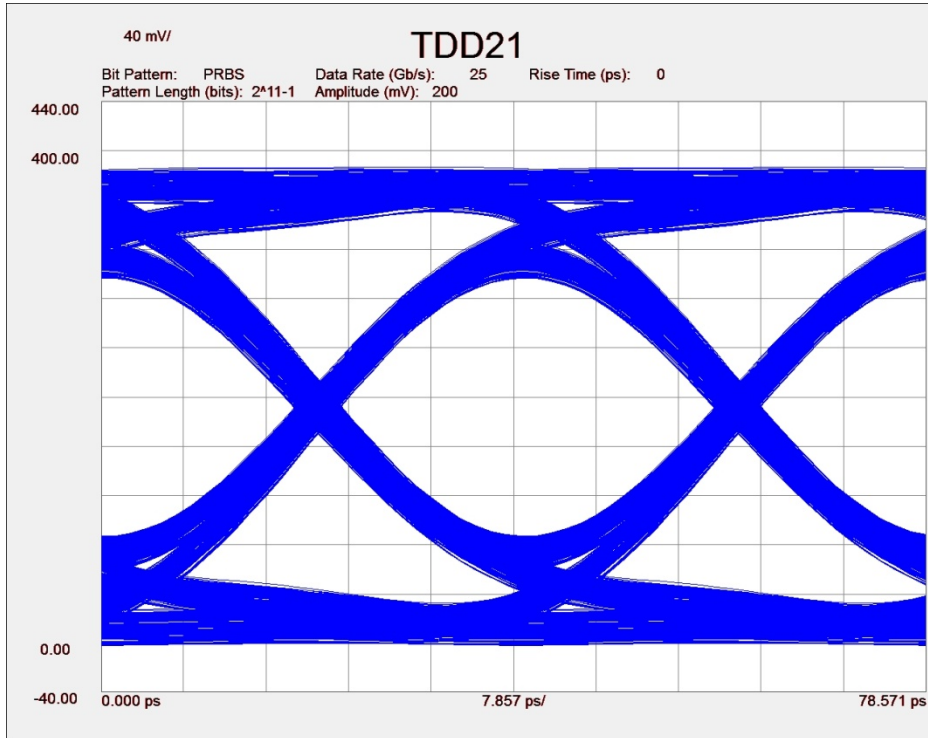

Figure 7. Typical mated pair 25 Gb/s eye diagram.

Parameter Measurement Result

Name	Measurement Result
Eye Level Zero(mV)	46.94
Eye Level One(mV)	339.28
Eye Level Mean(mV)	193.11
Eye Amplitude(mV)	292.34
Eye Height(mV)	189.91
Eye Height(db)	-7.21
Eye Width	3.49e-011
Eye Opening Factor	0.65
Eye Signal_to_Noise	5.13
Eye Duty Cycle Dist	-2.40e-012
Eye Duty Cycle Dist(%)	-6.00
Eye Rise Time (20-80)	2.00e-011
Eye Fall Time (80-20)	1.96e-011
Eye Jitter(PP)	5.06e-012
Eye Jitter(RMS)	1.25e-012

S<sub>11</sub> Param DUT Files Meas

Figure 8. Typical mated pair 25 Gb/s eye data.

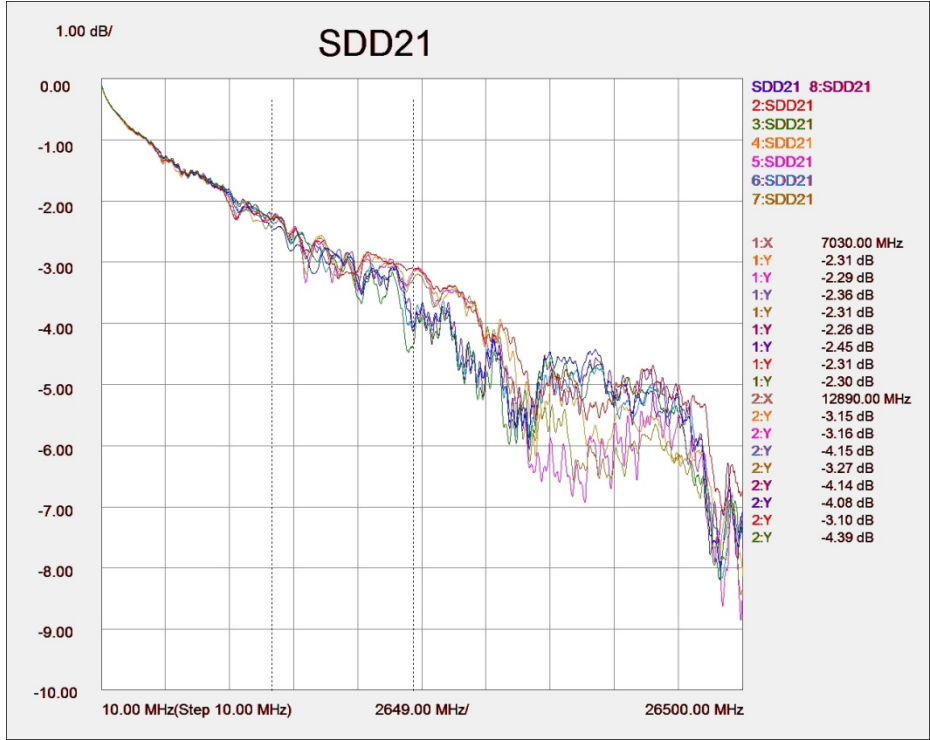

Figure 9. Typical mated pair balanced insertion loss.



Figure 10. Available S4Ps showing balanced insertion loss of HCB without connector, MCB without connector, and HCB through MCB without connectors.



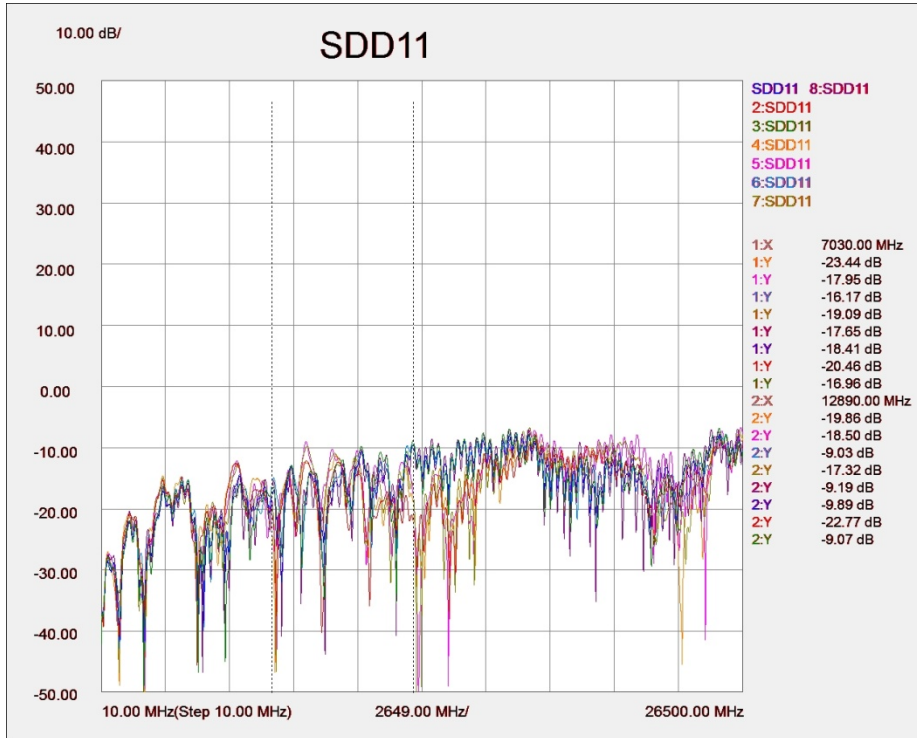

Figure 11. Typical mated pair balanced return loss.



Figure 12. Available S4Ps showing balanced return loss of HCB without connector, MCB without connector, and HCB through MCB without connectors.

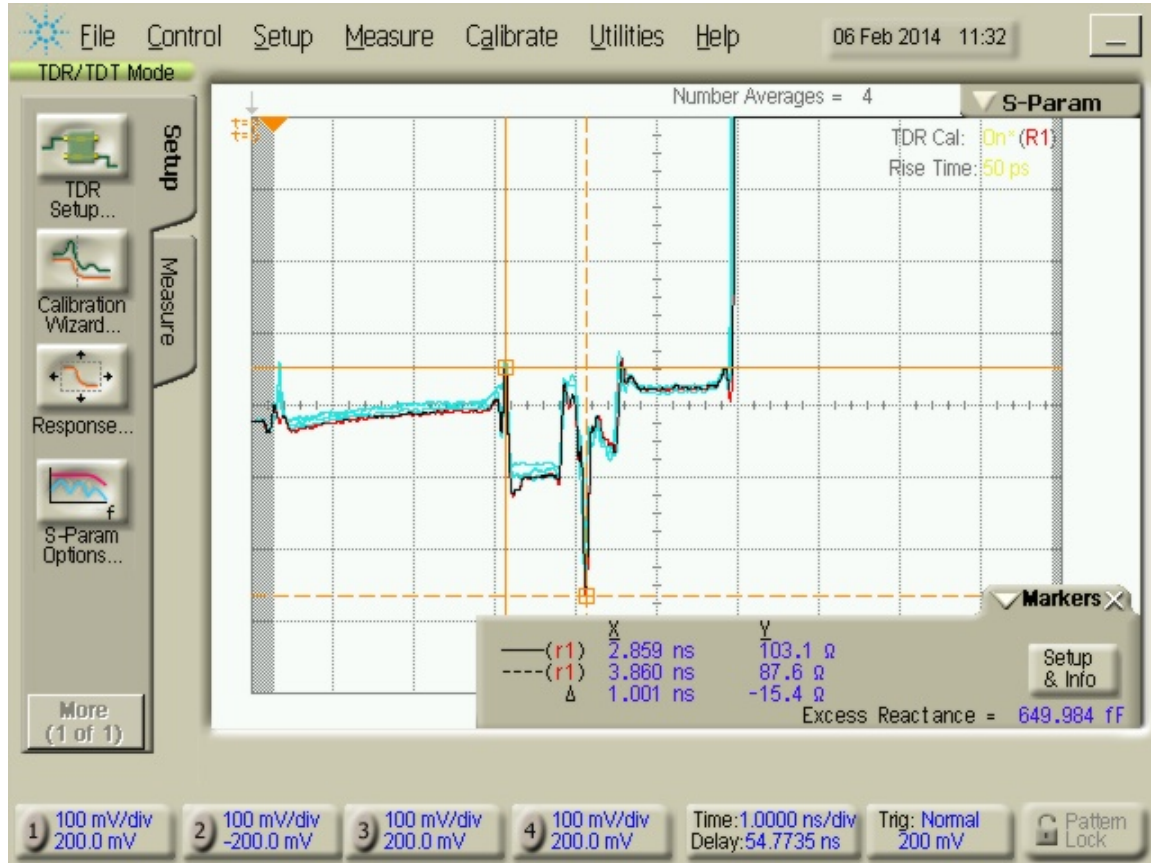

Figure 13. Typical differential TDR of TX channels of QSFP28-TPA100G-HCB-P connected to QSFP28-TPA100G-MCB-R at 34 ps Rise Time (20-80%) (Measured at 50 ps 10-90%).

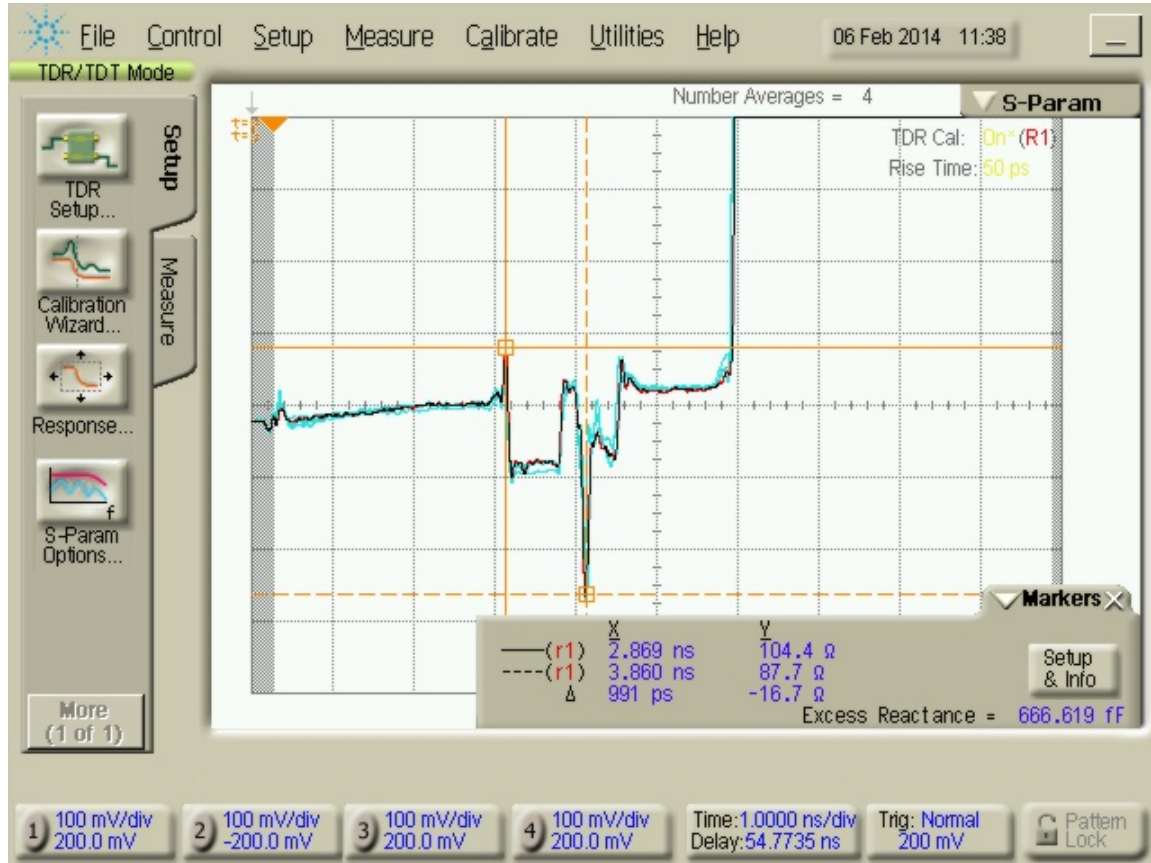

Figure 14. Typical differential TDR of RX channels of QSFP28-TPA100G-HCB-P connected to QSFP28-TPA100G-MCB-R at 34 ps Rise Time (20-80%) (Measured at 50 ps 10-90%).

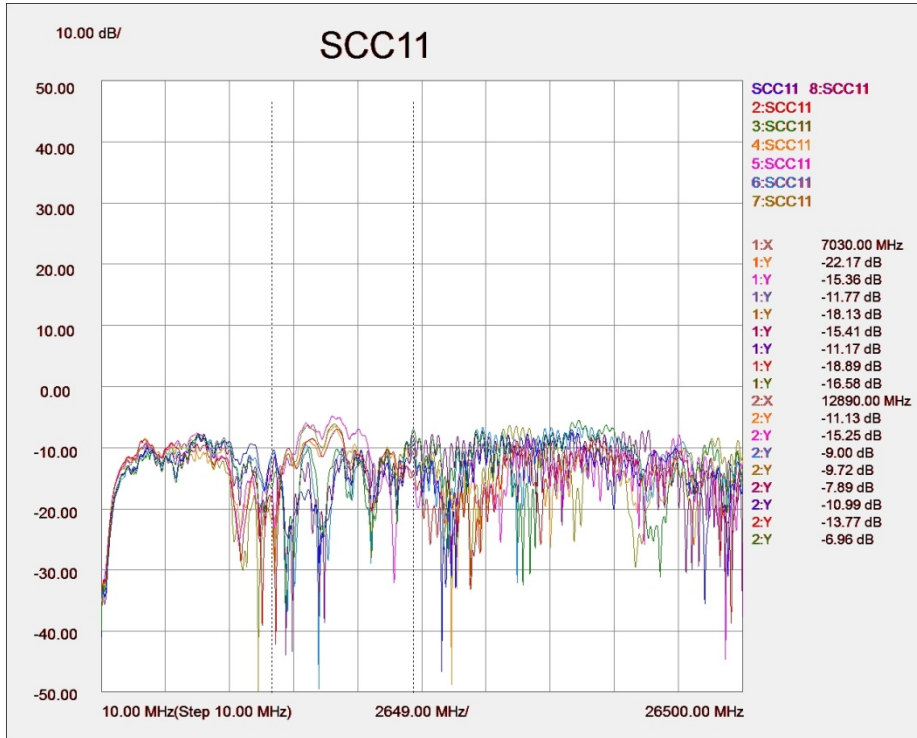

Figure 15. Typical mated pair common mode return loss.

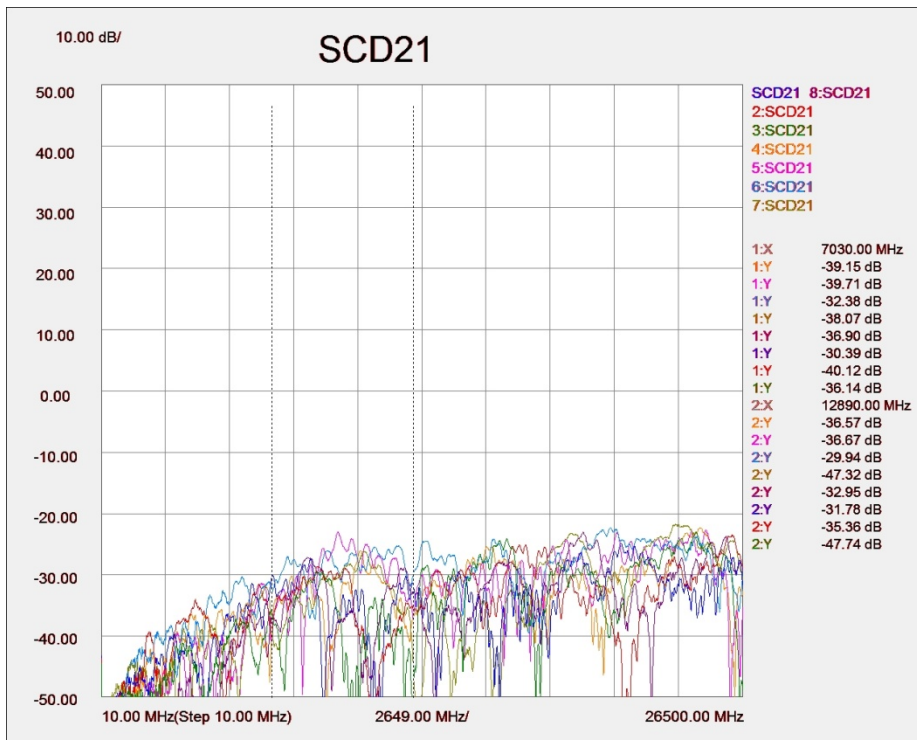

Figure 16. Typical mated pair differential to common mode conversion.

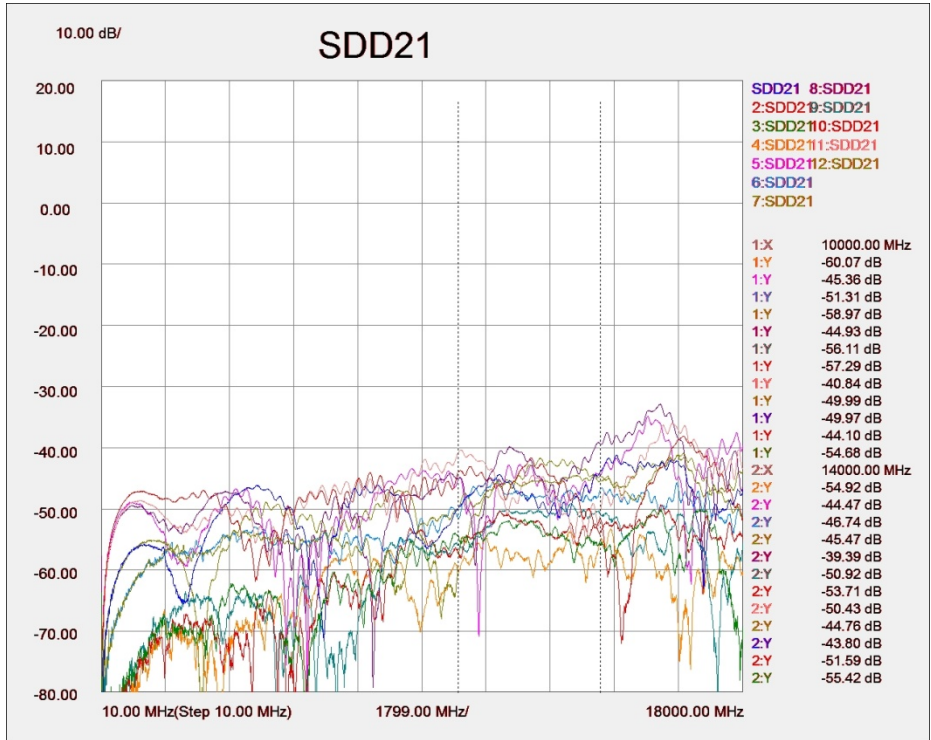

Figure 17. Typical Differential NEXT, Plug TPA, with mated connectors, adjacent differential pairs, both transmit and receive terminated at both ends.

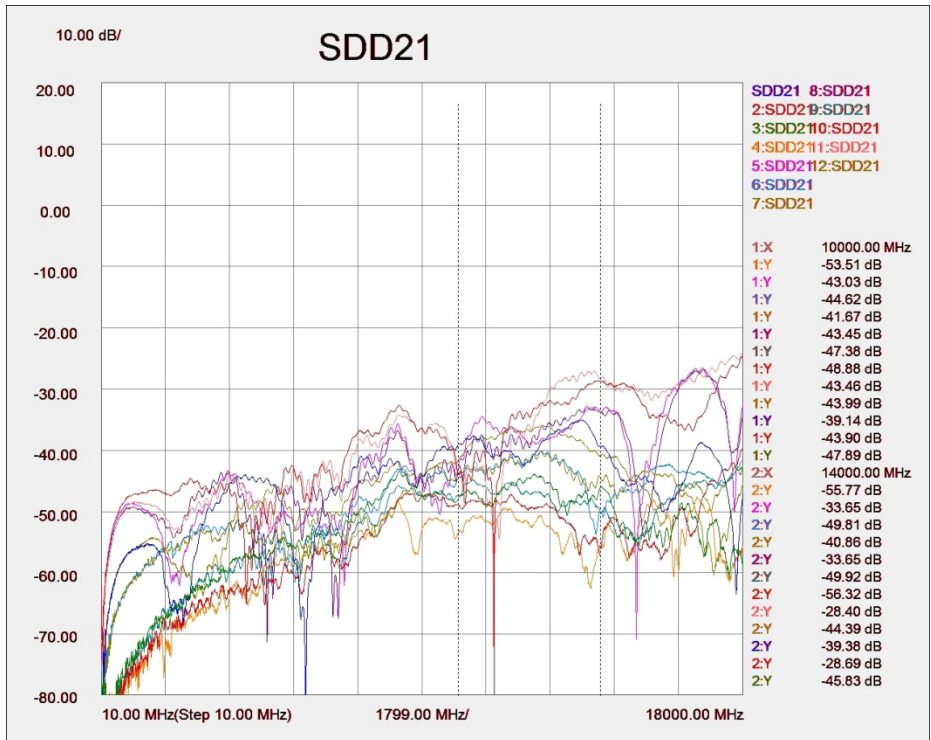

Figure 18. Typical Differential NEXT, Receptacle TPA, with mated connectors, adjacent differential pairs, both transmit and receive terminated at both ends.

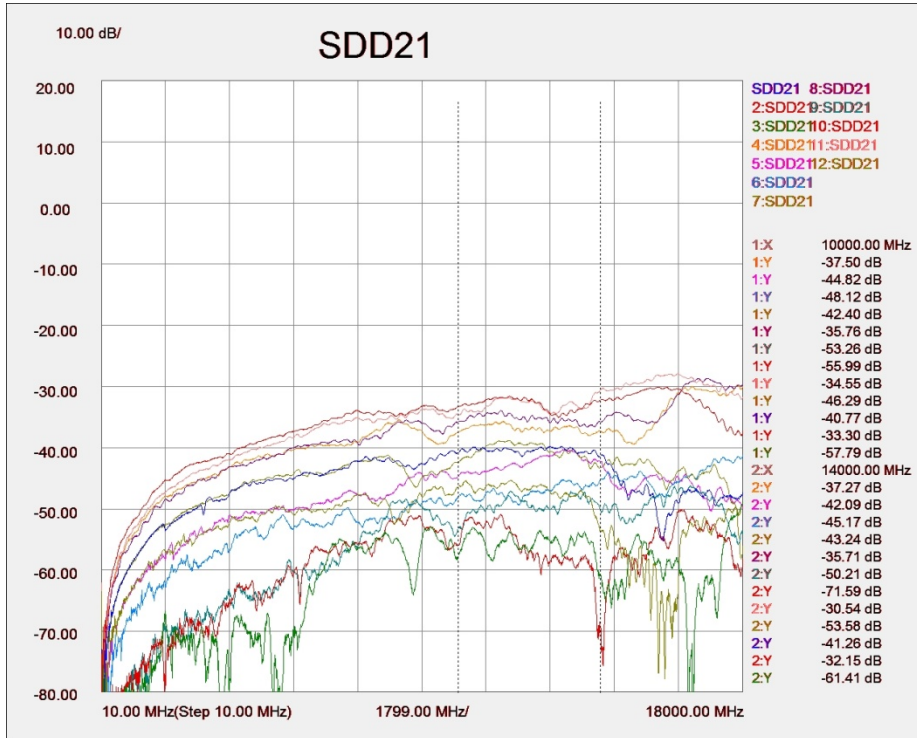

Figure 19. Typical Differential FEXT, with mated connectors, adjacent differential pairs, both transmit and receive terminated at both ends.

## QSFP28 Test Adapter Reference Information

This section contains a schematic diagram of the QSFP28-TPA100G-MCB-R Power Connections.

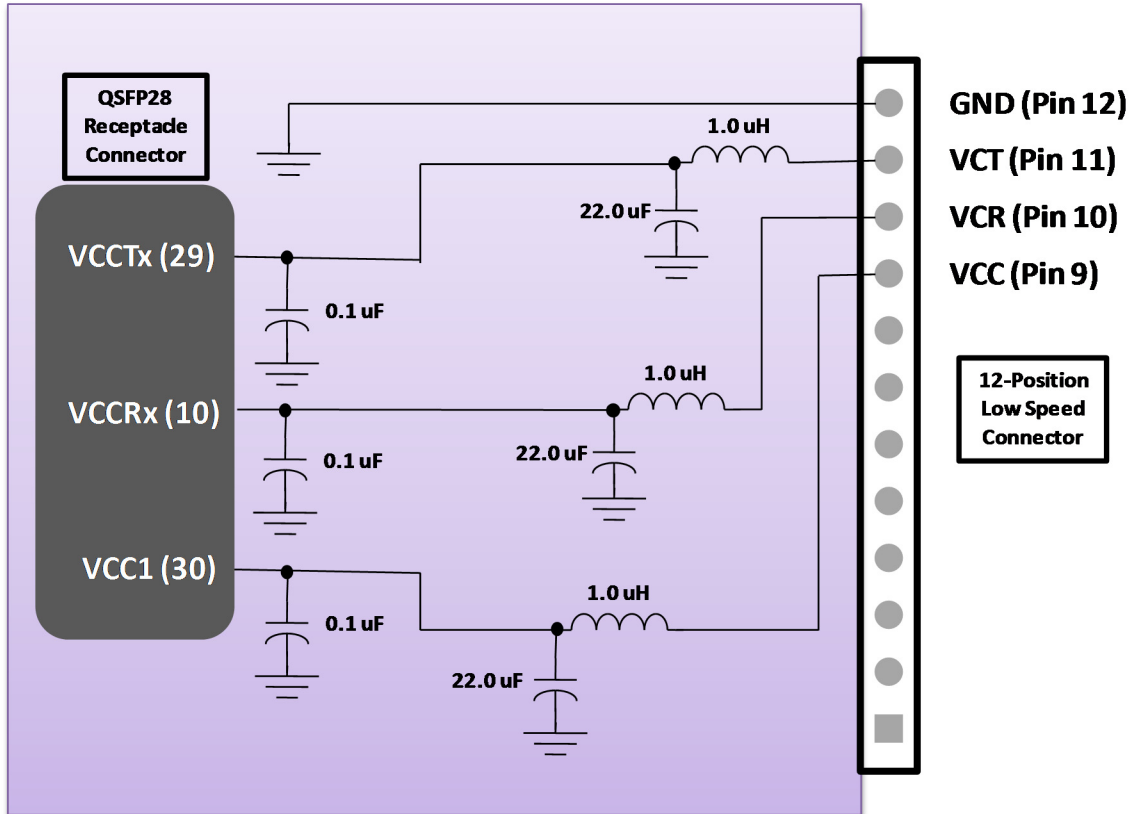

Figure 20. QSFP28-TPA100G-MCB-R Power Connections

## Wilder Technologies, LLC – Limited Warranty

Wilder Technologies, LLC warrants that each Test Adapter, 1) is free from defects in materials and workmanship and, 2) conforms to Wilder Technologies specifications for a period of 12 months, with the exceptions of the HDMIA2 (HDMI v2.0), HDMID2 (HDMI v2.0), SFP28, QSFP28, and QSFP+ 100G Test Adapters, whereby are warranted for a period of 6 months, all other aspects of the Wilder Technologies, LLC warranty apply.

### **See Consumable and Fragile Material Warranty for exceptions to the 12 month warranty**

The warranty period for a Test Adapter is a specified, fixed period commencing on the date of ship from Wilder Technologies, LLC. If you did not purchase your Test Adapter directly from Wilder Technologies, LLC, the serial number and a valid proof of purchase will be required to establish your purchase date. If you do not have a valid proof of purchase, the warranty period will be measured from the date of ship from Wilder Technologies, LLC.

If, during the warranty period, the Test Adapter is not in good working order, Wilder Technologies, LLC will, at its option, repair or replace it at no additional charge, except as is set forth below. In some cases, the replacement Test Adapter may not be new and may have been previously installed. Regardless of the Test Adapter's production status, Wilder Technologies, LLC appropriate warranty terms apply.

### **Consumable and Fragile Material Warranty**

Wilder Technologies, LLC warrants that consumable materials and all fragile materials supplied by Wilder Technologies, LLC either as part of an instrument or system, or supplied separately, will be free from defects in material and workmanship at the time of shipment.

### **Extent of Warranty**

The warranty does not cover the repair or exchange of a Test Adapter resulting from misuse, accident, modification, unsuitable physical or operating environment, improper maintenance by you, or failure caused by a product for which Wilder Technologies, LLC is not responsible. The warranty is voided by removal or alteration of Test Adapter or parts identification labels. The initial three months are unconditional; the remaining months excludes plugs, receptacles and SMA connectors. Connectors are wear items and excluded from the warranty after the initial three months.

**These warranties are your exclusive warranties and replace all other warranties or conditions, express or implied, including but not limited to, the implied warranties or conditions or merchantability and fitness for a particular purpose. These warranties give you specific legal rights and you may also have other rights which vary from jurisdiction to jurisdiction. Some jurisdictions do not allow the exclusion or limitation of express or implied warranties, so the above exclusion or limitation may not apply to you. In that event, such warranties are limited in duration to the warranty period. No warranties apply after that period.**

### **Items Not Covered by Warranty**

Wilder Technologies, LLC does not warrant uninterrupted or error-free operation of a Test Adapter.

Any technical or other support provided for a Test Adapter under warranty, such as assistance via telephone with "how-to" questions and those regarding Test Adapter set-up and installation, will be provided **WITHOUT WARRANTIES OF ANY KIND**.

### **Warranty Service**

Warranty service may be obtained from Wilder Technologies, LLC by returning a Wilder Technologies, LLC Returns Material Authorization and the Test Adapter to Wilder Technologies, LLC during the warranty period. To obtain RMA number, contact [support@wilder-tech.com](mailto:support@wilder-tech.com).

You may be required to present proof of purchase or other similar proof of warranty entitlement. You are responsible for any associated transportation charges, duties and insurance between you and Wilder Technologies, LLC. In all instances, you must ship Test Adapters in Wilder Technologies, LLC approved packaging. Information on packaging guidelines can be found at: [www.wilder-tech.com](http://www.wilder-tech.com). Wilder Technologies, LLC will ship repaired or replacement Test Adapter Delivery Duty Prepaid (DDP) and will pay for return shipment. You will receive title to the repaired or replacement Test Adapter and you will be the importer of record.



## Wilder Technologies, LLC – Terms & Conditions of Sale

- Other Documents:** This Agreement may NOT be altered, supplemented, or amended by the use of any other document(s) unless otherwise agreed to in a written agreement signed by both you and Wilder Technologies, LLC. If you do not receive an invoice or acknowledgement in the mail, via e-mail, or with your Product, information about your purchase may be obtained at [support@wilder-tech.com](mailto:support@wilder-tech.com) or by contacting your sales representative.
- Payment Terms, Orders, Quotes, Interest:** Terms of payment are within Wilder Technologies, LLC's sole discretion, and unless otherwise agreed to by Wilder Technologies, LLC, payment must be received by Wilder Technologies, LLC prior to Wilder Technologies, LLC's acceptance of an order. Payment for the products will be made by credit card, wire transfer, or some other prearranged payment method unless credit terms have been agreed to by Wilder Technologies, LLC. Invoices are due and payable within the time period noted on your invoice, measured from the date of the invoice. Wilder Technologies, LLC may invoice parts of an order separately. Your order is subject to cancellation by Wilder Technologies, LLC, in Wilder Technologies, LLC's sole discretion. Unless you and Wilder Technologies, LLC have agreed to a different discount, Wilder Technologies, LLC's standard pricing policy for Wilder Technologies, LLC-branded systems, which includes hardware, software and services in one discounted price, allocates the discount off list price applicable to the service portion of the system to be equal to the overall calculated percentage discount off list price on the entire system. Wilder Technologies, LLC is not responsible for pricing, typographical, or other errors in any offer by Wilder Technologies, LLC and reserves the right to cancel any orders resulting from such errors.
- Shipping Charges; Taxes; Title; Risk of Loss:** Shipping, handling, duties and tariffs are additional unless otherwise expressly indicated at the time of sale. Title to products passes from Wilder Technologies, LLC to Customer on shipment from Wilder Technologies, LLC's facility. Loss or damage that occurs during shipping by a carrier selected by Wilder Technologies, LLC is Wilder Technologies, LLC's responsibility. Loss or damage that occurs during shipping by a carrier selected by you is your responsibility. You must notify Wilder Technologies, LLC within 7 days of the date of your invoice or acknowledgement if you believe any part of your purchase is missing, wrong or damaged. Unless you provide Wilder Technologies, LLC with a valid and correct tax exemption certificate applicable to your purchase of Product and the Product ship-to location, you are responsible for sales and other taxes associated with the order. **Shipping dates are estimates only.**
- WARRANTY:** WILDER TECHNOLOGIES, LLC, warrants that the item(s) manufactured under the Buyer's contract shall be free from defects in materials and workmanship furnished by WILDER TECHNOLOGIES, LLC, and shall conform to the applicable drawings and specifications. WILDER TECHNOLOGIES, LLC'S liability herein, for breach of warranty, contract or negligence in manufacturing, shall be limited to repair or replacement. Repair or replacement of defective items will be applicable only if the Buyer notifies WILDER TECHNOLOGIES, LLC, by written notice within 30-days of delivery. All claims shall be addressed to: [support@wilder-tech.com](mailto:support@wilder-tech.com) or WILDER TECHNOLOGIES, LLC, 6101A East 18th Street, Vancouver, Washington 98661 U.S.A.; ATTENTION: Customer Service Manager. WILDER TECHNOLOGIES, LLC, reserves the right to inspect at the Buyer's plant all items claimed to be defective or nonconforming prior to authorizing their return. WILDER TECHNOLOGIES, LLC, assumes no liability for the results of the use of its components in conjunction with other electric, electronic or mechanical components, circuits and/or systems. The foregoing constitutes the sole and exclusive remedy of the Buyer and the exclusive liability of WILDER TECHNOLOGIES, LLC, and is IN LIEU OF ANY AND ALL OTHER WARRANTIES, STATUTORY, IMPLIED OR EXPRESSED AS TO MERCHANTABILITY, FITNESS FOR THE PURPOSE SOLD, DESCRIPTION, QUALITY, and PRODUCTIVENESS OR ANY OTHER MATTER. Without limiting the foregoing, in no event shall WILDER TECHNOLOGIES, LLC, be liable for loss of use, profit or other collateral, or for special and/or consequential damages.
- RETURNED GOODS:** WILDER TECHNOLOGIES, LLC, will accept only those goods for return that have been authorized for return. All goods authorized for return shall be assigned a Returned Material Authorization (RMA) Number. The RMA Number shall be clearly marked on the shipping container(s) and all documentation accompanying the goods authorized for return. The RMA Number shall be assigned by WILDER TECHNOLOGIES, LLC pursuant to the conditions set forth in Paragraph 4, WARRANTY.
- UNITED STATES GOVERNMENT CONTRACTS:** In the event this offer is accepted under Government contract, WILDER TECHNOLOGIES, LLC, agrees to accept clauses required by Government regulations and to waive WILDER TECHNOLOGIES, LLC conditions inconsistent therewith. WILDER TECHNOLOGIES, LLC, certifies that it is a regular manufacturer or dealer of the goods and/or services offered herein and that the prices offered do not exceed those charged to any customer for like quantities, services or materials under the same conditions.

## Compliance with Environmental Legislation

Wilder Technologies, LLC, is dedicated to complying with the requirements of all applicable environmental legislation and regulations, including appropriate recycling and/or disposal of our products.



### WEEE Compliance Statement

The European Union adopted Directive 2002/96/EC on Waste Electrical and Electronic Equipment (WEEE), with requirements that went into effect August 13, 2005. WEEE is intended to reduce the disposal of waste from electrical and electronic equipment by establishing guidelines for prevention, reuse, recycling and recovery.

Wilder Technologies has practices and processes in place to conform to the requirements in this important Directive.

In support of our environmental goals, effective January 1<sup>st</sup>, 2009 Wilder Technologies, LLC has partnered with EG Metals Inc. – Metal and Electronics Recycling of Hillsboro, Oregon, [www.egmetalrecycling.com](http://www.egmetalrecycling.com), to recycle our obsolete and electronic waste in accordance with the European Union Directive 2002/96/EC on waste electrical and electronic equipment ("WEEE Directive").

As a service to our customers, Wilder Technologies is also available for managing the proper recycling and/or disposal of all Wilder Technologies products that have reached the end of their useful life. For further information and return instructions, contact [support@wilder-tech.com](mailto:support@wilder-tech.com).

## Glossary of Terms

TERMINOLOGY	DEFINITION
Aggressor	A signal imposed on a system (i.e., cable assembly) to measure response on other signal carriers.
Decibel (dB)	Ten times the common logarithm (i.e. log10) of the ratio of relative powers.
Far-end crosstalk or FEXT	Crosstalk that is propagated in a disturbed channel in the same direction as the propagation of a signal in the aggressor channel. The terminals of the aggressor channel and the victim channel are usually close to each other.
Informative	The designation of a test that is not required for compliance.
Insertion loss	The ratio, expressed in dB, of incident power to delivered power.
Near-end crosstalk or NEXT	Crosstalk that is propagated in a disturbed channel in the opposite direction as the propagation of a signal in the aggressor channel. The terminals of the aggressor channel and the victim channel are usually close to each other.
Normative	The designation of a test that is required for compliance.
Return Loss	The ratio, expressed in dB, of incident power to reflected power.
QSFP28	28 Gbps 4X Pluggable Transceiver (Quad Small Form Factor Pluggable)
QSFP28 Host	The QSFP28 Host is the fixed end of the connection supporting IEEE 802.3.
QSFP28 Module	The QSFP28 Module is the moveable end of the connection supporting IEEE 802.3.
QSFP28 TPA	QSFP28 Test Point Access. A specialized assembly that interfaces to a QSFP28 host or module and enables access of signals for measurement or stimulation.
Victim	A signal carrier on a system that has a response imposed on it by other signals in the system.

## Addendum A – QSFP28 Receptacle Test Adapter with Power Sinking

This addendum provides reference information as it relates to the QSFP28-TPA100GH-MCB-R (QSFP28 Receptacle Test Adapter with Power Sinking) version of QSFP28 Receptacle Test Adapters.

### Power Sinking Version Receptacle Test Adapter

Features of the QSFP28-TPA100GH-MCB-R Test Adapter are illustrated below.

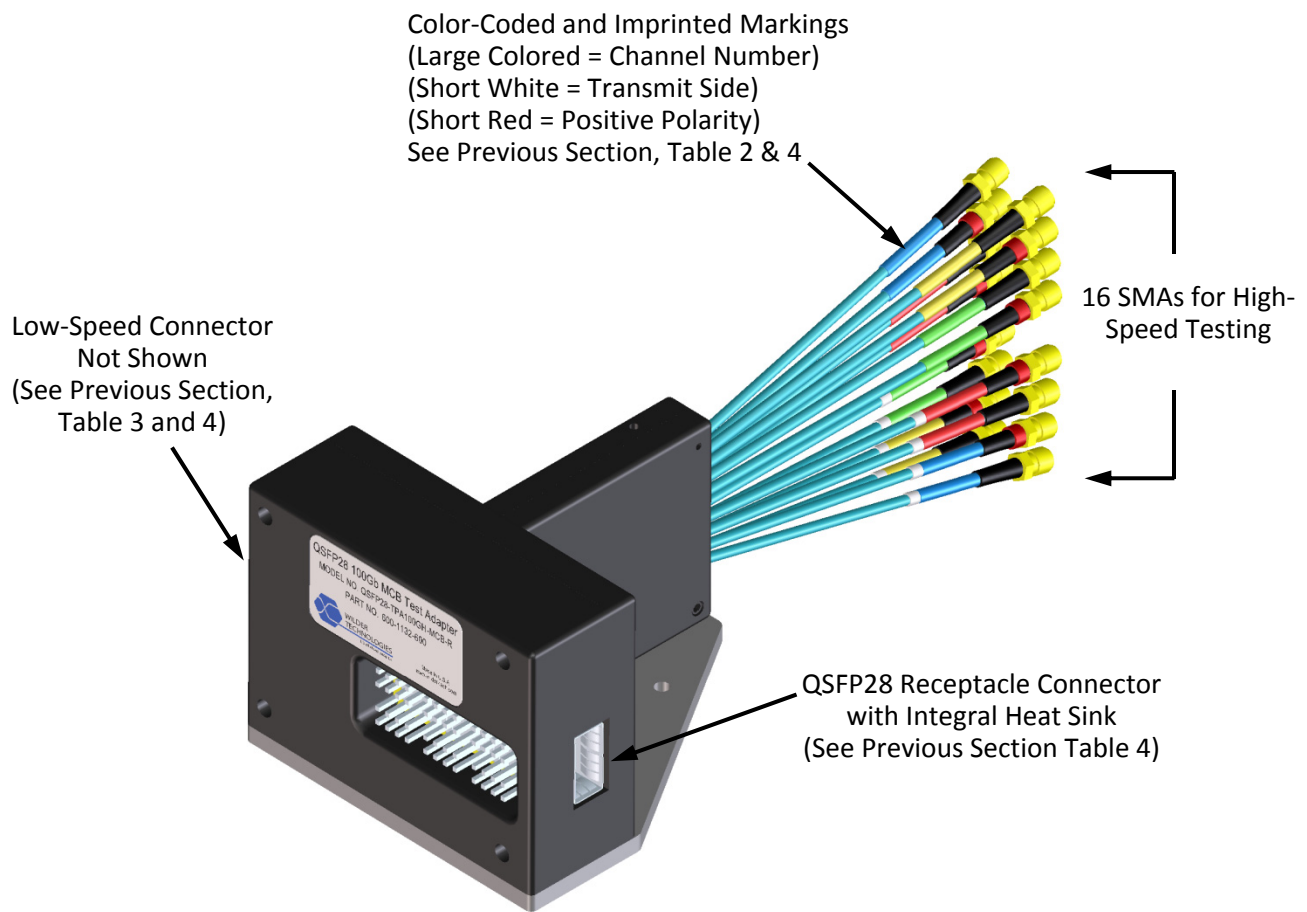

Figure A-1. The QSFP28-TPA100GH-MCB-R Test Adapter (Receptacle TPA with Power Sinking)  
(Note: Coaxial cables shown are illustrated shorter than those used in the test adapter.  
The coaxial cables are configuration dependent and may be terminated with different  
SMA connectors than what is shown.)

## Index

- AC coupled, 4
- Addendum A – QSFP28-TPA100GH-MCB-R Test Adapter, 36
- Cable Bend Limits, 6
- Cable Tension (Pull Forces), 6
- Cable Twisting (Torque), 6
- Calibration Through De-Embedding, 13
- Care and Handling, 6
- Cleaning, 8
- Compliance
  - WEEE, 34
- Connections
  - QSFP28-TPA100G to DUT, 6
  - SMA, 6, 7
- Crosstalk Errors, 13
- DC Blocks, 3, 4, 10, 11, 21
- Directivity Errors, 13
- Drift Errors, 13
- DUT, 13
- Electrical Specifications, 20
- Electrostatic Discharge Information (ESD), 9
- Environmental Changes, 13
- Errors
  - Crosstalk*, 13
  - Directivity*, 13
  - Drift*, 13
  - Load Impedance Mismatching*, 13
  - Random*, 13
  - Receiver Reflection-tracking in Test Equipment*, 13
  - Receiver Transmission in Test Equipment*, 13
  - Source Impedance Mismatching*, 13
- ESD protection, 9
- ESD Sensitivity, 7
- Figures
  - Cable Connectors, 14, 15, 36
  - QSFP28-TPA100GH-MCB-R Test Adapter, 36
  - QSFP28-TPA100G-MCB-R Test Adapter Power Connections, 31
  - The QSFP28 HCB Test Adapter (Plug), 3, 14
  - The QSFP28 MCB Test Adapter (Receptacle), 4, 15
  - The QSFP28-TPA100GH-MCB-R Test Adapter (Receptacle with Power Sinking), 36
- Glossary, 35
- Handling and Storage, 8
- Load Impedance Mismatching Errors, 13
- Low-Speed Connector, 4
- Low-Speed Connector Part Numbers, 4
- Making Connections, 8
- Mechanical and Environmental Specifications, 14
- Molex part numbers, 4
- Power Sinking Version, 36
- Product Inspection, 5
- Product Return, 5
- Pull Force, 6, 7
- QSFP28-TPA100G Reference Information, 31
- QSFP28-TPA100G-HCB-P Cable Pinout, 14
- QSFP28-TPA100G-HCB-P Plug TPA Testing a Host, 11
- QSFP28-TPA100G-MCB -R Testing a QSFP28 Module, 10
- QSFP28-TPA100G-MCB-R Cable Pinout, 14
- QSFP28-TPA100G-MCB-R's Testing a QSFP28 Cable, 12
- Random Errors, 13
- Receiver Reflection-Tracking in Test Equip. Errors, 13
- Receiver Transmission in Test Equipment Errors, 13
- RF Terminations, 3, 4, 10, 11, 21
- Secure Storage, 5
- SFF Specification, 3
- SMA cables, 14
- Source Impedance Mismatching Errors, 13
- Support, 13, 33
- Supporting Instrument Cables or Accessories, 7
- Tables
  - Electrical Specifications (External DC Block), 21
  - Electrical Specifications (RF Termination), 21
  - Electrical Specifications (TPA), 20
  - General Specifications, 14
  - QSFP28-TPA100G 12-Position Cable Connector, 17
  - QSFP28-TPA100G Plug & Recept. Pin Assignments, 18
  - SMA Cable Connectors (High-Speed), 16
- Terms and Conditions of Sale, 33
- Test Instrument Noise, 13
- Test Repeatability Problems, 13
- User Model Examples, 10, 11, 12
- Visual Inspection, 8
- Warranty, 32
- Web Sites
  - support@wilder-tech.com, 32, 33
  - www.egmetalrecycling.com, 34
  - www.wilder-tech.com, 32
- WEEE, 34

Visit our website at [www.wilder-tech.com](http://www.wilder-tech.com)



**WILDER  
TECHNOLOGIES**

It's all about integrity

Wilder Technologies, LLC  
6101A East 18<sup>th</sup> Street  
Vancouver, WA 98661  
Phone: 360-859-3041  
Fax: 360-859-3105  
[www.wilder-tech.com](http://www.wilder-tech.com)

©2015 Wilder Technologies, LLC  
Document No. 910-0045-000 Rev. A  
Created: 8/26/2015 Updated: 10/23/2015