

The Essential Signal Generator Guide

Building a Solid Foundation in RF – Part 1

Eliminate uncertainties and doubts from your test results with a reliable signal source

Engineers designing consumer wireless, military communications, or radar devices face an ongoing bandwidth crunch in spectrum filled with interference. An accurate signal generator offers precise and stable test signals for characterizing your device under test (DUT). It also lets you apply impairments to test your design within and beyond its limits.

Getting to market faster with test results you can trust starts with selecting the right test instrument for the job. Our two-part series will help you better understand how signal generators work and which key specifications are critical for your projects.

Part 1 introduces you to the inner workings of the signal generator. It provides a deeper look at basic specifications such as power, accuracy, and speed. [Part 2](#) covers more advanced features such as modulation, spectral purity, and distortion.

Contents

Section 1. What is a signal generator?

Understand the basic functions of a signal generator, different types of signal generators, and key specifications.

Section 2. Power

Learn about the difference between average power, envelope power, and peak envelope power, as well as measurement applications for high or low output power.

Section 3. Accuracy

Gain confidence in your measurements. Take a deeper look at why accuracy matters and specifications of interest.

Section 4. Speed

We cover speed specifications and how to improve test throughput.



Section 1 - What Is a Signal Generator?

A signal generator is a source that outputs a signal. This signal can be a basic sinusoidal wave, a pulse, or a modulated signal. Sometimes also referred to as a signal source, this instrument allows you to output signals at various frequencies, amplitudes, and times.

What is a signal generator used for and why is it important?

Engineers use signal generators to test components, receivers, and systems for a variety of applications throughout the product development cycle. The output signal can be as simple as a continuous wave (CW) or complex, like a digitally modulated signal. The signal generator simulates a variety of signals at different stages of communication systems. Figures 1-1 and 1-2 show common signal generator use cases for component and receiver test.

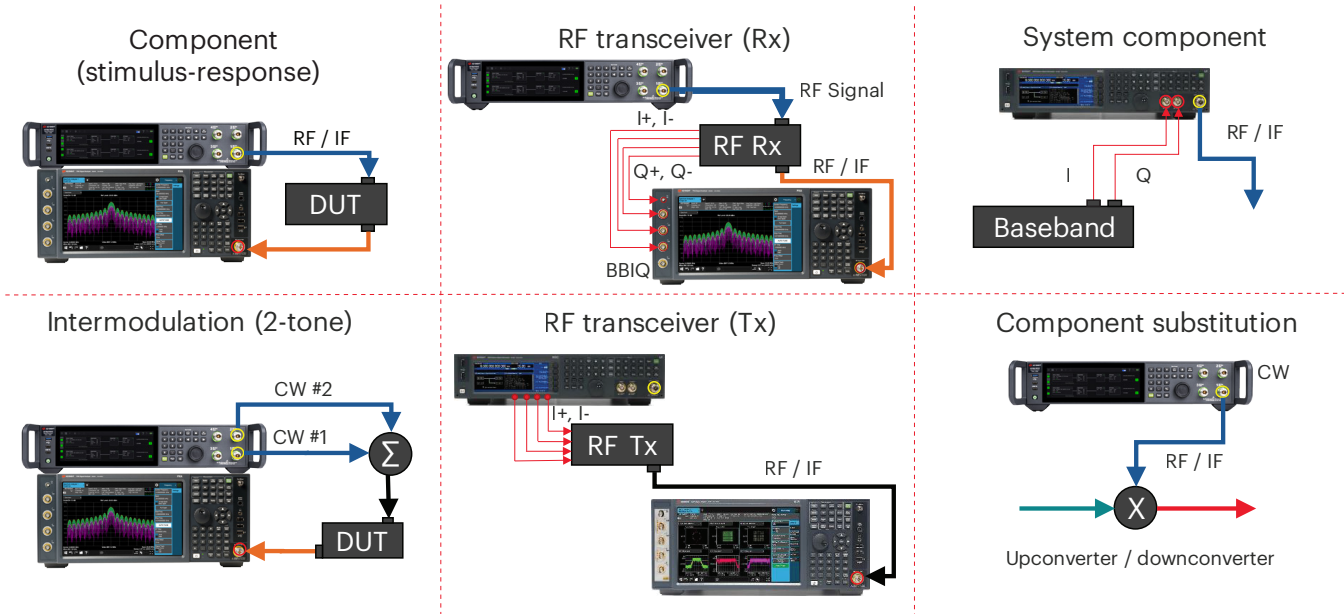

Figure 1-1. Signal generator use cases for component characteristic tests or a system component

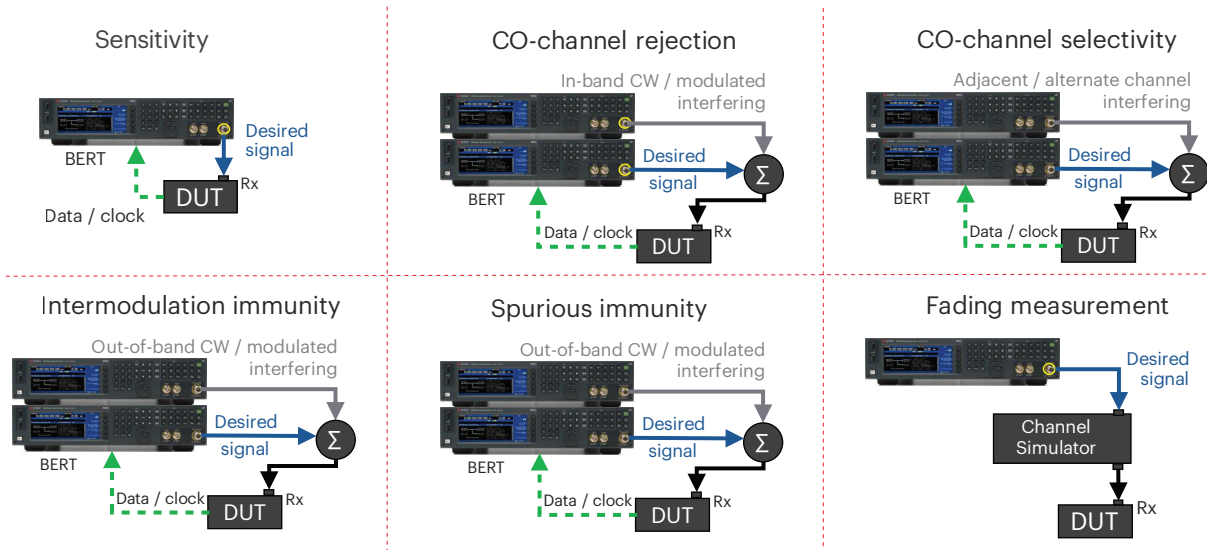

Figure 1-2. Signal generator use cases for receiver sensitivity tests

Why is a signal generator important? Signal generators produce precise and stable test signals for characterizing your device under test (DUT). They can simulate different kinds of signals, from digital I/Q to high-frequency signals. To characterize your device's behavior, a signal generator can also apply impairments to test your design within and beyond its limits.

Types of signal generators

Signal generators can be classified based on their form factor and capabilities.

Form factor: benchtop or modular?

The most common signal generator form factor is benchtop. We typically see these boxed instruments on benches and in racks. Benchtop signal generators are well-suited for R&D, where engineers use the front panel controls to analyze, and troubleshoot devices.

The PXIe modular form factor signal generators are compact instruments housed in a PXIe chassis and controlled using a PC. Several PXIe signal generators can be placed in a single chassis, making them ideal for applications that require multi-channel measurement capabilities, fast measurement speed, and a small footprint. A PXIe signal generator often uses the same software applications as a benchtop signal generator, providing measurement consistency and compatibility from product development to manufacturing and support.



Figure 1-3. Benchtop and PXI modular signal generator

Capabilities: analog, vector, and agile signal generators

Analog signal generators supply sinusoidal continuous wave (CW) signals and several types of analog modulation like amplitude, frequency, and pulse modulation. The maximum frequency range for analog signal generators spans from RF to microwave. Most generators feature step/list sweep modes for passive device characterization or calibration.

Vector signal generators add the ability to create digital modulation schemes. Traditional vector signal generators have a built-in baseband I/Q modulator to generate complex modulation formats, such as quadrature phase-shift keying (QPSK), quadrature amplitude modulation (QAM), or more complex orthogonal frequency-division multiplexing (OFDM) signals. Some next-generation vector signal generators replace the I/Q modulator with direct digital synthesis (DDS) technology to produce the same complex formats with higher signal fidelity and better overall modulation quality. When combined with an IQ baseband generator, virtually any signal can be emulated and transmitted within the modulation bandwidth supported by the system.

Optimized for speed, agile signal generators can quickly change frequency, amplitude, and phase of the signal. They also have the unique capability to be phase coherent at all frequencies, at all times. This attribute, along with extensive pulse modulation and wideband chirp capabilities, make them ideal for electronic warfare (EW) and radar applications.

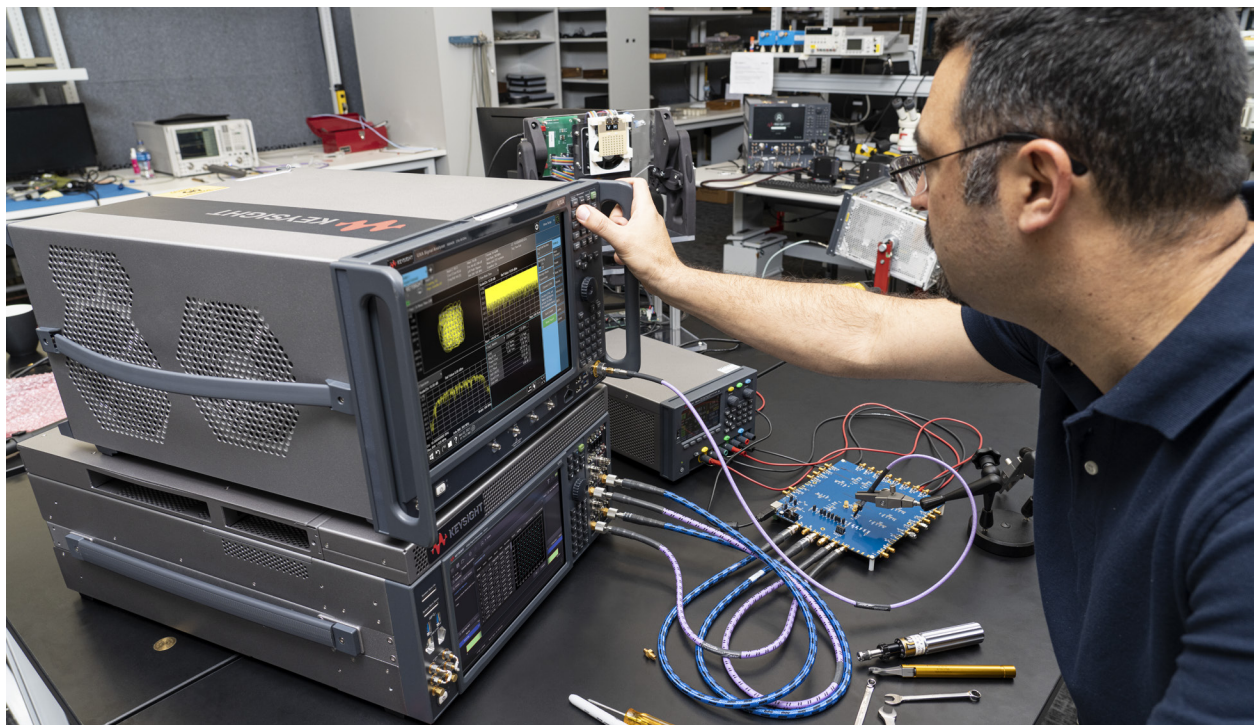

Overview of key specifications

To select the right signal generator for your project, you'll need to understand its performance specifications. Specifications tell you about the capability of your signal generator. Let's explore major specifications: frequency, amplitude, and spectral purity performance.

Frequency specifications

The frequency specification defines the range, resolution, accuracy, and switching speed of your signal generator.

- Range — the maximum and minimum frequencies your signal generator can output.
- Resolution — the smallest frequency change.
- Accuracy — how close the source's output frequency is to the set frequency.
- Switching — how fast the output settles to the desired frequency.

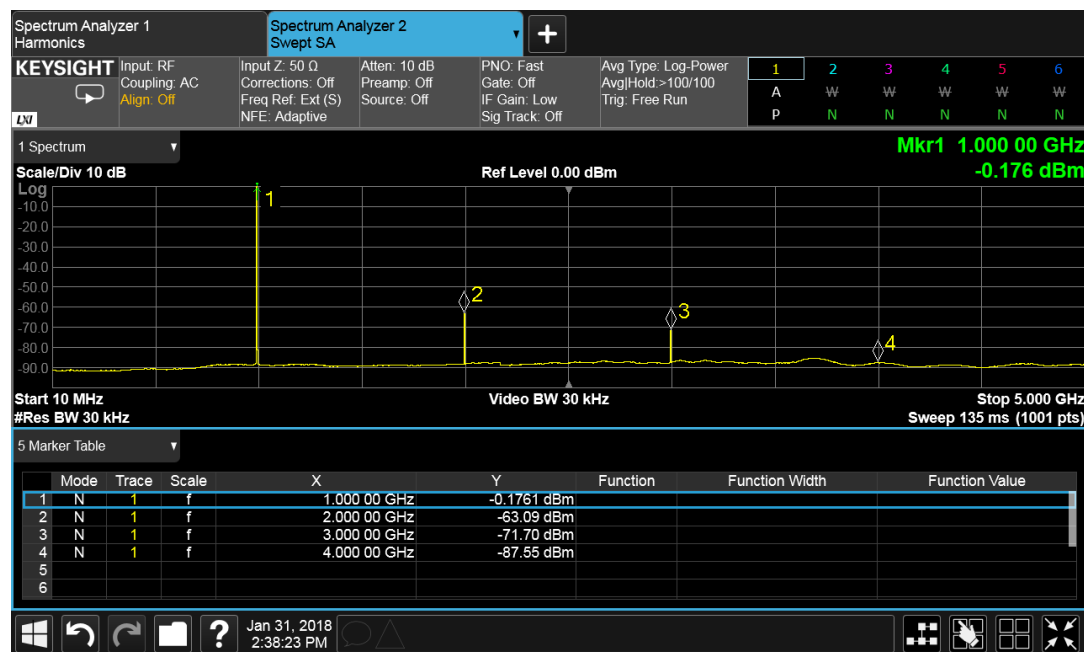

Figure 1-4. Spectrum analysis with frequency and amplitude readouts

Amplitude specifications

Amplitude specifications include range, resolution and switching speed.

- Range — the difference between the maximum and minimum output power capability of the signal generator. The signal generator's output attenuator design determines its range. The output attenuator allows the signal generator to produce extremely small signals used to test a receiver's sensitivity.
- Resolution — the smallest possible power increment.
- Switching speed — how fast the source can change from one power level to the next.

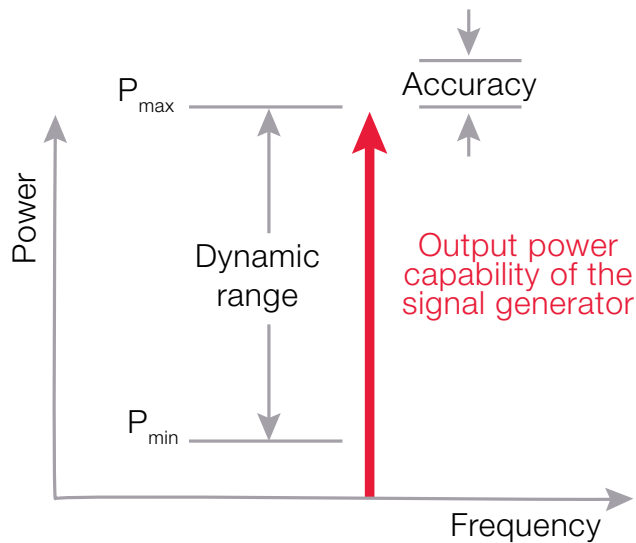

Figure 1-5. Power output range and accuracy

Spectral purity

Spectral purity is the inherent stability of a signal. A perfect signal generator will generate a sinusoidal wave at a single frequency without the presence of noise. However, signal generators consist of non-ideal components which introduce noise and distortion. The specifications associated with spectral purity are often the most difficult to understand. These specifications include phase noise, harmonics, and spurs as shown in Figure 1-6.

- Phase noise — a frequency-domain view of the noise spectrum around the oscillator signal. It describes the frequency stability of an oscillator.
- Harmonics — integer multiples of the sinusoidal fundamental frequency output. These harmonics are caused by non-linear characteristics of components used in the signal generator.
- Spurs — non-random or deterministic signals created from mixing and dividing signals to get the carrier frequency. These signals may be harmonically or non-harmonically related to the carrier.

Download our [Signal Generator Selection Guide](#) to learn more about Keysight's comprehensive portfolio of Signal Generators.

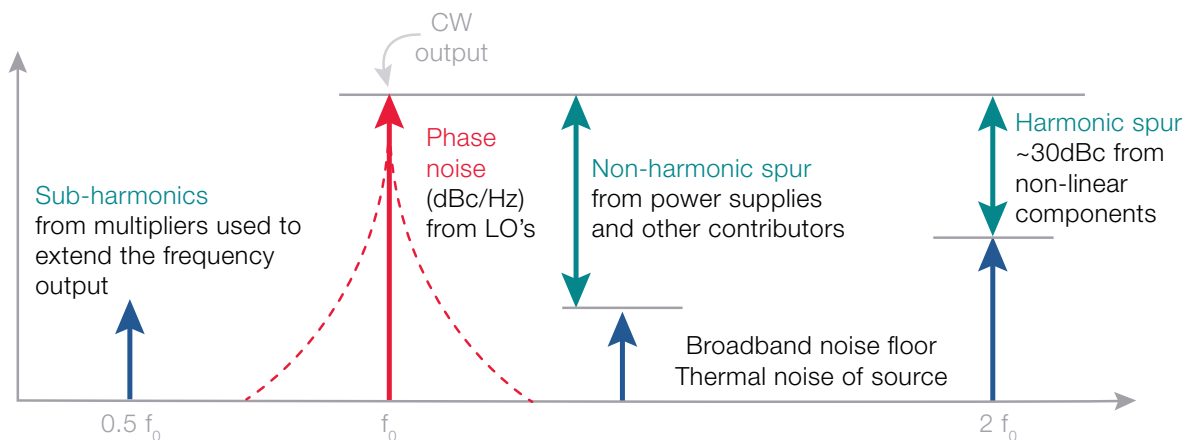

Figure 1-6. Various non-ideal spectral components

Section 2 - Power

Signal generators provide precise and stable test signals for a variety of component and system test applications. An important specification of any signal generator is output power range. Often, signal generators need output signals as low as -120 dBm in receiver sensitivity testing and as high as +20 dBm in RF power amplifier testing. They also need to achieve this wide dynamic range while meeting key specifications such as accuracy, spectral purity and noise.

There are several types of power to consider: average power, envelope power, and peak envelope power (PEP) to name a few. But before we look at each of these in detail, let's first understand the basics of power.

What is power?

The International System of Units defines the watt (W) as a unit of power – one watt is one joule per second, used to quantify the rate of energy transfer. At direct current (DC) and low frequencies, voltage and current measurements are simple and straightforward. Power (P) is the product of voltage (V) and current (I).

For low-frequency signals, both voltage and current vary with time. The energy transfer rate (instantaneous power) also varies with time. In Figure 2-1, the instantaneous power shifts around cycles as represented by the blue curve. Average power is calculated by integrating the area under the P curve.

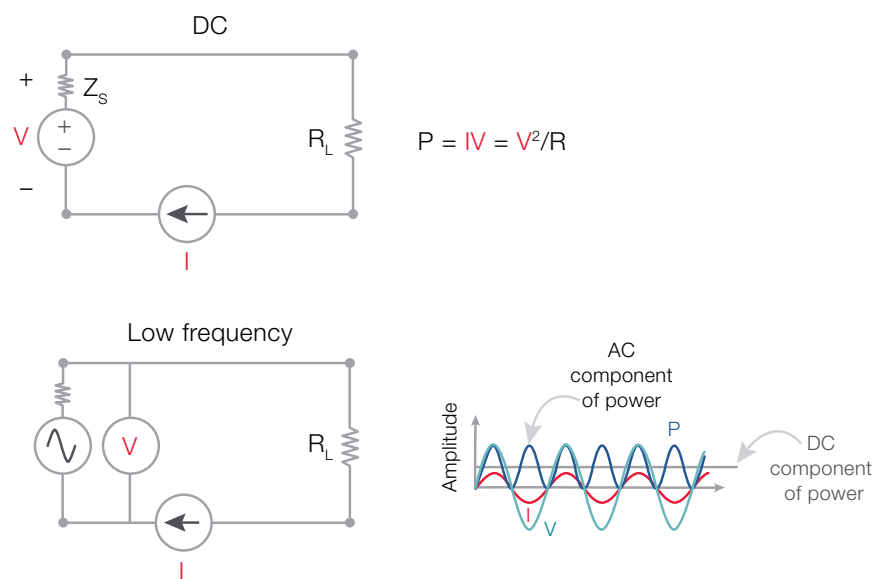

Figure 2-1. DC and low frequency power measurements

However, as frequency increases, voltage and current measurements become difficult and impractical, so engineers measure power directly. Figure 2-2 represents three continuous waves (CW) with the same voltage level but different frequencies. P_i (green curve) is instantaneous power and it varies with time, while P_{avg} (red line) is average power. Notice that average power remains constant and independent of frequency which is suitable for high-frequency signals. Let's take a closer look at different definitions of power for RF measurements.

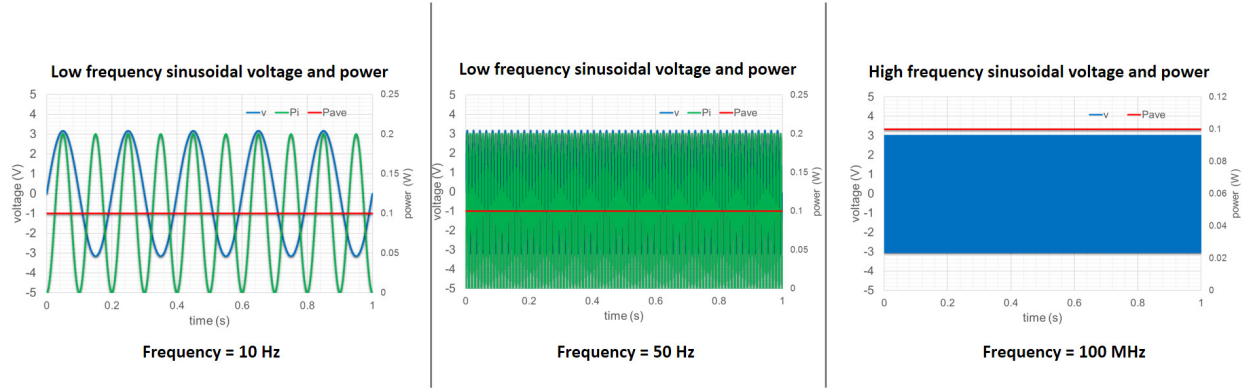

Figure 2-2. Low and high-frequency power measurements

Average power

As frequency increases, the impedance will vary. RF engineers commonly use the term average power to specify all RF and microwave systems because instantaneous power variations are too fast to be meaningful. Average power is the average energy transfer rate across many time periods of the lowest frequency.

Envelope power and peak envelope power

For some applications, engineers examine the effects of modulation or transient conditions without examining details of the RF carrier waveform. Figure 2-3 illustrates high frequency modulated signal power measurements. The upper graph represents the voltage envelope of the modulated signal. The lower left graph shows the instantaneous power of the signal in green and the average power in red. The envelope power is measured by averaging the power over a time period that is long compared to the period of the highest modulation frequency, but short compared to the period of the carrier. The lower right graph shows the envelope power in red. The maximum envelope power is called peak envelope power (PEP), an important parameter used to characterize the output power of a modulated signal.

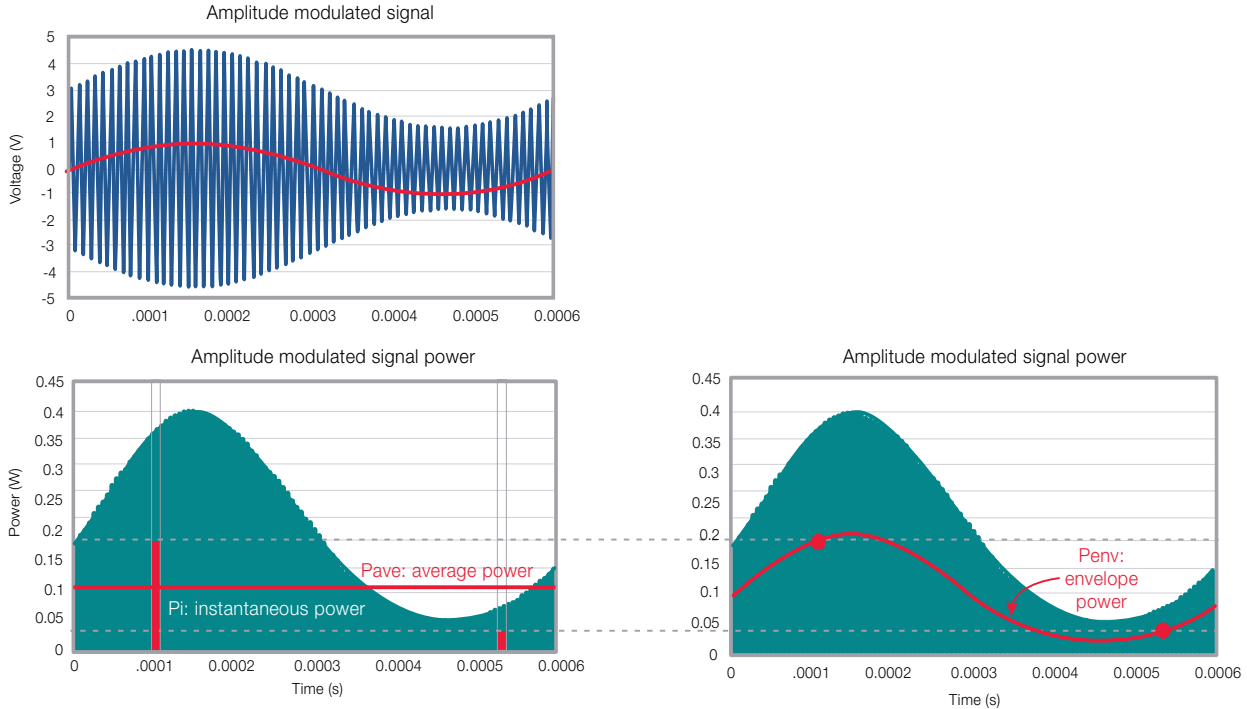

Figure 2-3. Voltage envelope and power envelope of a high-frequency modulated signal

Understanding the power specifications

When it comes to power specifications, many signal generators' datasheets will list the power output range, resolution, and applicable frequency ranges. There are several points to be aware of:

- Output amplitude is affected by frequency ranges and operating temperatures.
- There are often options for higher output power needs.
- The step attenuator provides coarse power attenuation (in 5 dB steps) to achieve low power levels. Fine power level adjustment is provided by the ALC (automatic level control) within the attenuator hold range.
- Maximum output power generally applies to CW mode. Some datasheets list maximum output power for I/Q modulation. For the Keysight CXG / EXG / MXG signal generators, power specification, it refers to PEP.

Tip: Impedance match is important because mismatch between source and the load impedance changes the effective signal input level to the DUT. If the mismatch is not distinguished from the measurement result, it appears as degraded DUT performance.

The N5186A MXG signal generator features an embedded reflectometer built for convenient match-corrected signal generation. It enables in-situ generation of a match-corrected signal incident to the current load with a single button press. Learn more about the benefits of match-corrected measurements in this [application note](#).



Table 2.1: Amplitude specifications of Keysight CXG signal generator

Output parameters	
Settable range	+30 to -144 dBm
Resolution	0.01 dB
Step attenuator	0 to 130 dB in 5 dB steps electronic type
Connector	Type N 50 Ω, nominal
Max output power ¹ () = typical	
Frequency	Standard
9 kHz to 10 MHz	+13 dBm
> 10 MHz to 3 GHz	+18 dBm
> 3 to 5 GHz	+16 dBm
> 5 to 6.0 GHz	+16 dBm

¹ Quoted specifications between 20 °C and 30 °C. Maximum output power typically decreases by 0.01 dB/°C for temperatures outside this range.

Why use dB and dBm? dB and dBm make expressing very large or very small values more convenient. Besides, using dB also allows you to easily calculate total system gain or loss. You just need to add for gain and subtract for loss.

Characterize modulation signals

Many of the digitally modulated signals appear noise-like in the time and frequency domains, with seemingly random peaks. How do you ensure you are not driving your signal generator to saturation during these peaks? The Power Complementary Cumulative Distribution Function (CCDF) curves tells us how high these peaks will go.

Figure 2-4 shows a CCDF curve with the highest peak to average ratio (PAR) at 5.67 dB. In this example, the maximum output power of the signal generator is 18 dBm, so the maximum power output your signal generator can be set to is 12.33 dBm (18 dBm - 5.67 dB). Remember that the signal generator's power output is average power output. Setting your signal generator's output higher than 12.33 dBm will lead to clipped peaks.

Looking for some tips on high power applications? Get them [here](#).

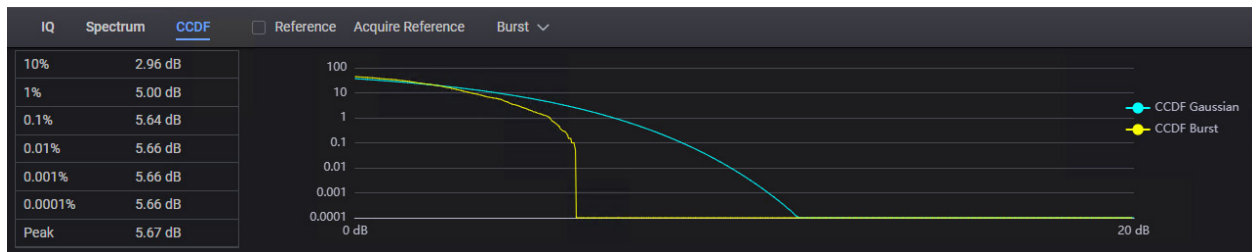

Figure 2-4. CCDF plot from Keysight's E7608APPC PathWave Signal Generation for custom modulation.

Measurement applications

If you need to go beyond the specified output power range, you can use an amplifier to increase the output power or an attenuator to decrease it. However, you will need to take the amplifier's gain uncertainty, and the attenuator's flatness and accuracy into consideration. Here are some test applications for high and low output power.

High-output power test applications:

- Overcome switching losses within automated test equipment (ATE) systems
- Address the attenuation of signals within long cable runs
- Over-the-air (OTA) tests
- High-power amplifiers
- Receiver blocking tests

Low-output power test applications:

- Receiver sensitivity measurement
- As interference signals

Section 3 – Accuracy

People often confuse accuracy with precision. The accuracy of a signal generator measures how close its output value is to the set value. Precision measures the degree to which the signal generator's output fluctuates. A high precision generator will have a stable output with little variations. However, a high precision generator may not necessarily have an accurate output. Figure 3-1 shows the distinction between accuracy and precision.

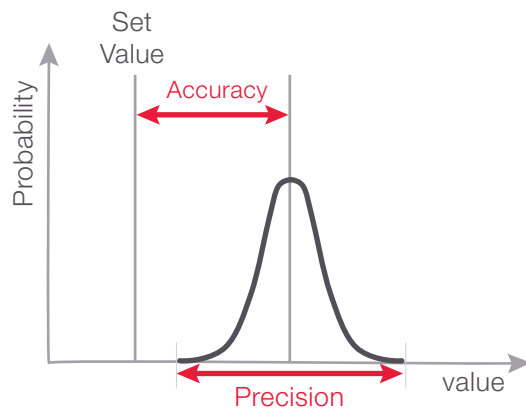

Figure 3-1. Accuracy vs precision

Why accuracy matters

In research and development, you characterize your designs with high-accuracy measurement instruments to ensure errors are from your device under test instead of the instruments. In manufacturing, you test the RF receiver to ensure that it meets specifications. However, you also want to be sure that you're not rejecting perfectly good units. Did you know that you can easily improve yield and product quality by improving the accuracy of test?

Key accuracy specifications

We will cover two key accuracy specifications, amplitude accuracy and frequency accuracy. How much accuracy you need depends on your application. If you are testing a wireless receiver's sensitivity with ± 4 dB accuracy, you will need to use a source with ± 1 dB amplitude accuracy to achieve a test accuracy ratio of 4.

Amplitude accuracy

Amplitude accuracy tells you how close your signal generator's output amplitude is to the set amplitude. It is important to check the amplitude accuracy for the frequency and temperature range of interest because a signal generator's output accuracy degrades with temperature and at higher frequencies. For example, the N5182B's absolute level accuracy degrades by 0.01 dB/°C when the ambient temperature is outside of the 20 °C to 30 °C range. Table 3-1 shows the amplitude accuracy specification of the N5166B CXG signal generator.

Download the [white paper](#) and find how to improve the amplitude accuracy with next-generation signal generators.

Table 3.1: Accuracy specification of N5166B CXG signal generator

Absolute level accuracy in CW mode (ALC on) () = typical		
	Standard	
Range	Max power to -60 dBm	< -60 to -110 dBm
9 to 100 kHz	(± 0.6 dB)	(± 0.9 dB)
100 kHz to 5 MHz	± 0.8 dB (± 0.3)	± 0.9 dB (± 0.3)
> 5 MHz to 3 GHz	± 0.6 dB (± 0.3)	± 0.8 dB (± 0.3)
> 3 to 6 GHz	± 0.6 dB (± 0.3)	± 1.1 dB (± 0.3)
Absolute level accuracy in CW mode (ALC off, power search run, relative to ALC on)		
9 kHz to 6GHz	(± 0.15 dB)	
Absolute level accuracy in digital I/Q mode (N5182B only)		
(ALC on, relative to CW, W-CDMA 1 DPCH configuration < +10 dBm)		
5 MHz to 6 GHz	± 0.25 dB (± 0.05)	

Amplitude flatness

Frequency sweeps are often used to test filters and power amplifiers. Amplitude accuracy affects the frequency sweeping capability of a signal generator. The less the amplitude changes from one frequency to another, the flatter the output. The change in amplitude when moving from one frequency to another is called flatness. While closely related to amplitude accuracy, the flatness specification is tighter than the amplitude accuracy and usually referenced to the amplitude of the starting frequency. Figure 3-2 illustrates this difference.

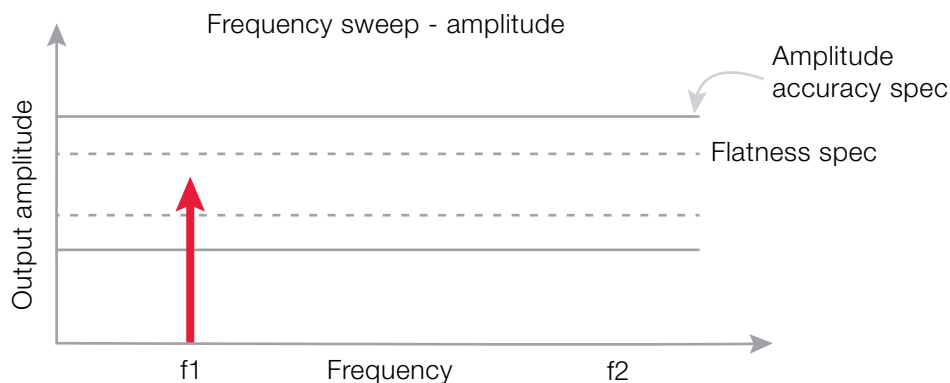

Figure 3-2. Comparison between amplitude accuracy and flatness

Improve accuracy to improve yield

Receiver sensitivity testing requires sources with accurate output power. Receiver sensitivity testing determines if a receiver can detect weak signals above a specified power level. For example, a 4G mobile phone receiver has a specified sensitivity level of -110 dBm. The device under test will be rejected if it fails to detect signals with a power level of -110 dBm or more.

To illustrate the effects of poor accuracy on test yield, let's use the 4G receiver example. Consider a signal generator with an amplitude accuracy of ± 5 dB. To avoid over-acceptances (or false positives), the signal generator is setup to output -115 dBm. At -115 dBm, the signal generator's output power will vary between -110 dBm to -120 dBm. As you can see in Figure 3-3, using this signal generator will cause you to inadvertently reject four perfectly good receivers with borderline performance.

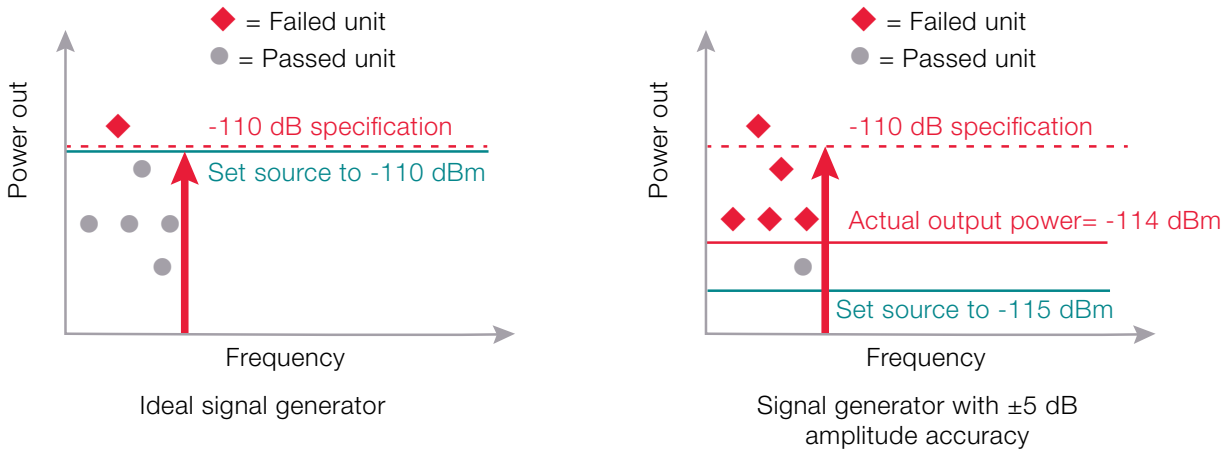

Figure 3-3. Effects of poor amplitude accuracy to test yield

You can improve test yield by using a more accurate signal generator. Figure 3-4 shows the same test using a signal generator with an amplitude accuracy specification of ± 1 dBm. Four of the same six receivers tested earlier now pass the sensitivity test. We reduced false rejects by 75% just by using a more accurate signal generator.

A more accurate signal generator may cost more. However, in the long run, the improved yield will return the cost of investment many times over.

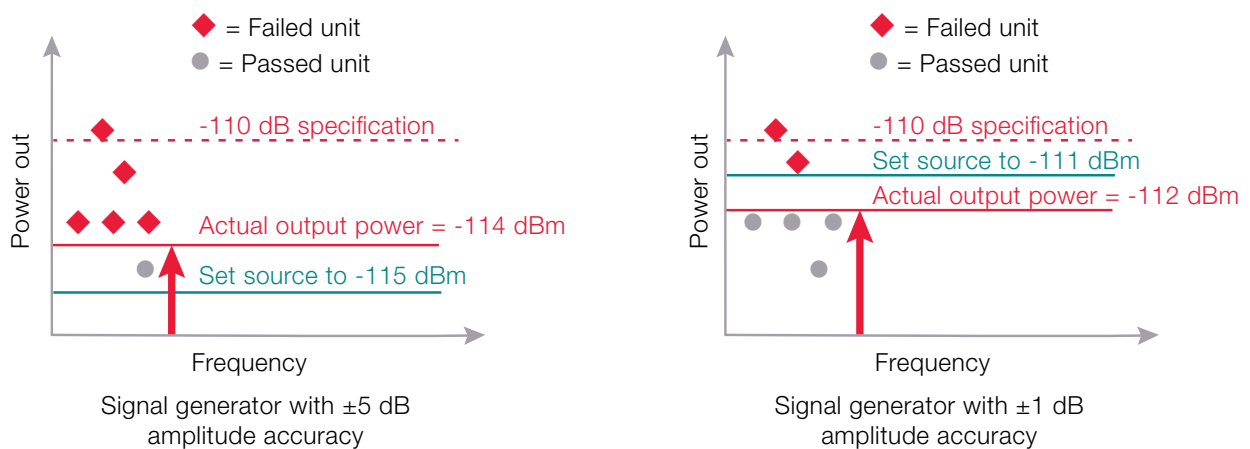

Figure 3-4. Effects of improved amplitude accuracy to test yield

Frequency accuracy

The frequency accuracy of a signal generator is affected by two main factors: the stability of the reference oscillator and the amount of time that has passed since the signal generator was calibrated. Although temperature and line voltage also affect frequency stability, its effects are several orders of magnitude less than the aging effect. Therefore, the key specification to look out for is the reference oscillator aging rate.

A typical reference oscillator used in a signal generator has an aging rate of 0.152 ppm per year. A 10 GHz signal generator with this reference oscillator that has not been calibrated for one year will have a frequency accuracy of ± 1.52 kHz. The calculation is shown below.

$$\text{Frequency Accuracy (Hz)} = \text{Output Frequency (Hz)} \times \text{Aging Rate (ppm/year)} \times \text{Time since last calibration} = 10 \text{ GHz} \times 0.152 \text{ ppm / year} \times 1 \text{ (year)} = 1.52 \text{ kHz}$$

Table 3.2: Frequency reference of the N5172B EXG signal generator

Frequency reference	
Accuracy	\pm (time since last adjustment x aging rate)
	\pm temperature effects
	\pm line voltage effects
	\pm calibration accuracy
Internal time base reference oscillator aging rate ¹	$\leq \pm 5$ ppm/10yrs, $< \pm 1$ ppm/yr
Initial achievable calibration accuracy	$\pm 4 \times 10^{-8}$ or ± 40 ppb
Adjustment resolution	$< 1 \times 10^{-10}$
Temperature effects	± 1 ppm (0 to 55 °C), nominal
Line voltage effects	± 0.1 ppm, nominal; 5% to 10%, nominal

1. Not verified by the Keysight N7800A TME Calibration and Adjustment Software. Daily aging rate may be verified as a supplementary chargeable service, on request.

Section 4 – Speed

Reducing test time can reduce test costs. So, the speed of your signal generator influences the cost of test. A fast signal generator allows you to quickly switch from one frequency to another, from one amplitude to another, or from one waveform to another. Speed is specified in milliseconds. Table 4-1 shows the frequency switching speed specification for the N5182B MXG signal generator.

Tip: Improve waveform switching speed by using the list / step sweep mode to pre-load the waveforms into the non-volatile memory.

Table 4.1: Switching speed specification of the N5182B MXG signal generator

Frequency switching speed ^{1,2}			
	Standard	Option UNZ ³	Option UNZ, typical
CW mode	≤ 5 ms, typical	≤ 1.15 ms	≤ 950 μs
SCPI mode	≤ 5 ms, typical	≤ 900 μs	≤ 800 μs
Digital modulation on (N5182B only)			
	Standard	Option UNZ ³	Option UNZ, typical
CW mode	≤ 5 ms, typical	≤ 1.15 ms	≤ 950 μs
List/step sweep mode	≤ 5 ms, typical	≤ 900 μs	≤ 800 μs

- ¹ Time from receipt of SCPI command or trigger signal to within 0.1 ppm of final frequency or within 100 Hz, whichever is greater.
- ² With internal channel corrections on, the frequency switching speed is < 1.3 ms, measured for list mode and SCPI mode cached frequency points. For the initial frequency point in SCPI mode the time is < 3.3 ms, measured. The instrument will automatically cache the most recently used 1024 frequencies. There is no speed degradation for amplitude-only changes.
- ³ Specifications apply when status register updates are off. For export control purposes CW switching speed to within 0.05% of final frequency is 190 μs (measured).

Factors affecting speed

Type of change and the source of commands affect switching speed. The time documented in the specification refers to the amount of time needed for the output of the signal generator to stabilize once a command is sent. Typical switching times can be up to 40% faster than speed specifications which are worst case scenarios.

When you set the signal generator to a new frequency, the frequency synthesizer will change its output to the desired frequency. The output amplifier will then adjust the power level so that the output power stays the same at the new frequency. Essentially, frequency switching requires changes to both the frequency synthesizer and output amplifier, which is why frequency switching is often slower than amplitude switching. During switching, command processing takes up the most time. Figure 4-1 shows each step to process a SCPI command request.

Frequency	AMPLITUDE	List Table		
6.000 000 000 00 GHz	-144.00 dBm	Edit Item		
List Node Values				
Pg 1	11			
Frequency	Power	Waveform	Dwell	
1 6.000000000000 GHz	-144.00	-- CW (no modulation)	2.000 ms	
2 6.000000000000 GHz	-144.00	-- CW (no modulation)	2.000 ms	Insert Row
3 6.000000000000 GHz	-144.00	-- CW (no modulation)	2.000 ms	
4 6.000000000000 GHz	-144.00	-- CW (no modulation)	2.000 ms	
5 6.000000000000 GHz	-144.00	-- CW (no modulation)	2.000 ms	Delete Row
6 6.000000000000 GHz	-144.00	-- CW (no modulation)	2.000 ms	
7 6.000000000000 GHz	-144.00	-- CW (no modulation)	2.000 ms	
8 6.000000000000 GHz	-144.00	-----	2.000 ms	
9 6.000000000000 GHz	-144.00		2.000 ms	Goto Row
10 6.000000000000 GHz	-144.00		2.000 ms	
02/23/2012 14:19				More 1 of 2

Frequency Amplitude Baseband I/Q Waveform Dwell Time

Figure 4-1. SCPI command processing time in a signal generator

Faster switching speed

A signal generator's output in automatic test systems can be improved by using STEP or LIST commands. Typically, an operator sends commands to a signal generator for setting frequency, amplitude, and waveform when these states are not initially known. When using Standard Commands for Programmable Instruments (SCPI), command sending, parsing, and processing consumes overhead time before switching can begin.

If the frequency, amplitude, and waveform combination is known in advance, using a STEP or LIST sweep significantly improves speed. The signal generator can then sequence through the states in rapid succession. Typical switching time in sweep mode is 600 μ s to 800 μ s compared to 2 ms in SCPI mode.

Some signal generators offer high speed switching options. The N5182B MXG signal generator, for example, has the UNZ option which offers sub-millisecond switching speeds, perfect for high volume production. Keysight's exclusive baseband tuning technology innovation enables fast frequency and amplitude switching speeds in list mode.

Where switching speed matters

Wireless manufacturing

Test throughput is everything in manufacturing. Reducing test time leads to lower test cost. Using a fast signal generator can help with higher bandwidth and advanced features in the latest chipsets.

Device characterization

Adding integrated functions in wireless systems impacts test demands and test costs. Introducing new communications standards, frequency bands, and multi-antenna techniques raises the device's complexity. This requires switching frequencies for multiple bands, waveforms for multiple formats, and amplitude levels to characterize the device's performance.

Electronic warfare (EW) simulation

To simulate EW complex scenarios, you need a signal generator with capabilities such as fast switching, phase repeatability, and pulse modulation. It requires direct digital synthesis (DDS) technology to control frequency and phase, and an agile attenuator to adjust amplitude levels.

Summary

More and more functionalities are integrated into wireless devices, requiring more tests with more setups under more conditions. A wireless device includes multiple wireless standards, multiple frequency bands, and multiple antennas. This increases significant test challenges in verification and production test. Test engineers are continuously looking for ways to improve test throughput and cost. When equipped with the fast switching capability, these signal generators can switch frequency, amplitude, or waveform in less than 1 millisecond in most cases.



End of Part 1

We have reached the end of Part 1 of our two-part white paper. We hoped you've gained valuable understanding on the fundamental specifications of signal generators. In [Part 2](#), we will talk about more advance topics such as modulation, spectral purity, distortions and software. Learn about the various types of modulation schemes and gain a more in-depth understanding on harmonics and spurs. We'll share why distortions are not always evil and how you can improve your productivity with the latest software. To stay up to date with the most recent tutorials, techniques, and best practices check out the [Keysight RF and microwave blog](#) and follow the [Keysight RF Test and Measurement](#) Facebook page and [Keysight RF & Microwave Instruments & Measurements](#) LinkedIn page.

Keysight enables innovators to push the boundaries of engineering by quickly solving design, emulation, and test challenges to create the best product experiences. Start your innovation journey at www.keysight.com.