

**LeCroy**

# WavePro® 7 Zi Series

1.5 GHz – 6 GHz

The New Oscilloscope Experience



# THE NEW OSCILLOSCOPE EXPERIENCE IS HERE

## The Only Complete Debug Solution Up to 6 GHz

Combining signal fidelity with an architecture that maximizes speed in every performance aspect, the new WavePro 7 Zi Series presents a totally new oscilloscope experience from 1.5 to 6 GHz bandwidths. Experience 50  $\Omega$  and 1 M $\Omega$  inputs for every channel and four inputs into high-speed front end amplifiers and analog to digital converters. Experience the new X-Stream II architecture that provides 10 to 20 times faster long memory performance than any other oscilloscope. Combined with LeCroy's flexible and deep analysis toolbox, the WavePro 7 Zi Series gives an unforgettable experience for the debugging, validation, analysis and compliance testing of electronic designs.





1. X-Stream II streaming architecture — 10–20 times faster than other oscilloscopes
2. Deepest toolbox with more measurements, more math, more power
3. TriggerScan™ detects and captures more anomalies per second
4. Exceptional instrument responsiveness, even at maximum acquisition memory (256 Mpts)
5. 500 Mpts/s data transfer rate from oscilloscope to PC with LeCroy Serial Interface Bus (LSIB) option
6. 750,000 measurements/second with optimal signal integrity
7. 15.3" widescreen (16x9) high resolution WXGA color touch screen display
8. Protect your investment with bandwidth upgrades
9. Serial Data Analyzer and Disk Drive Analyzer models are tailored for advanced serial data analysis and for the most complete disk drive test solution
10. Low-speed serial triggering and decode (I<sup>2</sup>C, SPI, UART-RS232, CAN, LIN, FlexRay™) available to provide a total system view
11. WaveScan™ quickly and intuitively locates, analyzes and displays abnormal events even in long waveforms
12. 50  $\Omega$  and 1 M $\Omega$  inputs on 1.5–6 GHz models provide unsurpassed flexibility
13. ProBus and ProLink probe interfaces on 4–6 GHz models offer 8 inputs for multiplexing into four channels. Minimize reconnections.

# MOST COMPLETE DEBUG SOLUTION FROM 1.5–6 GHz

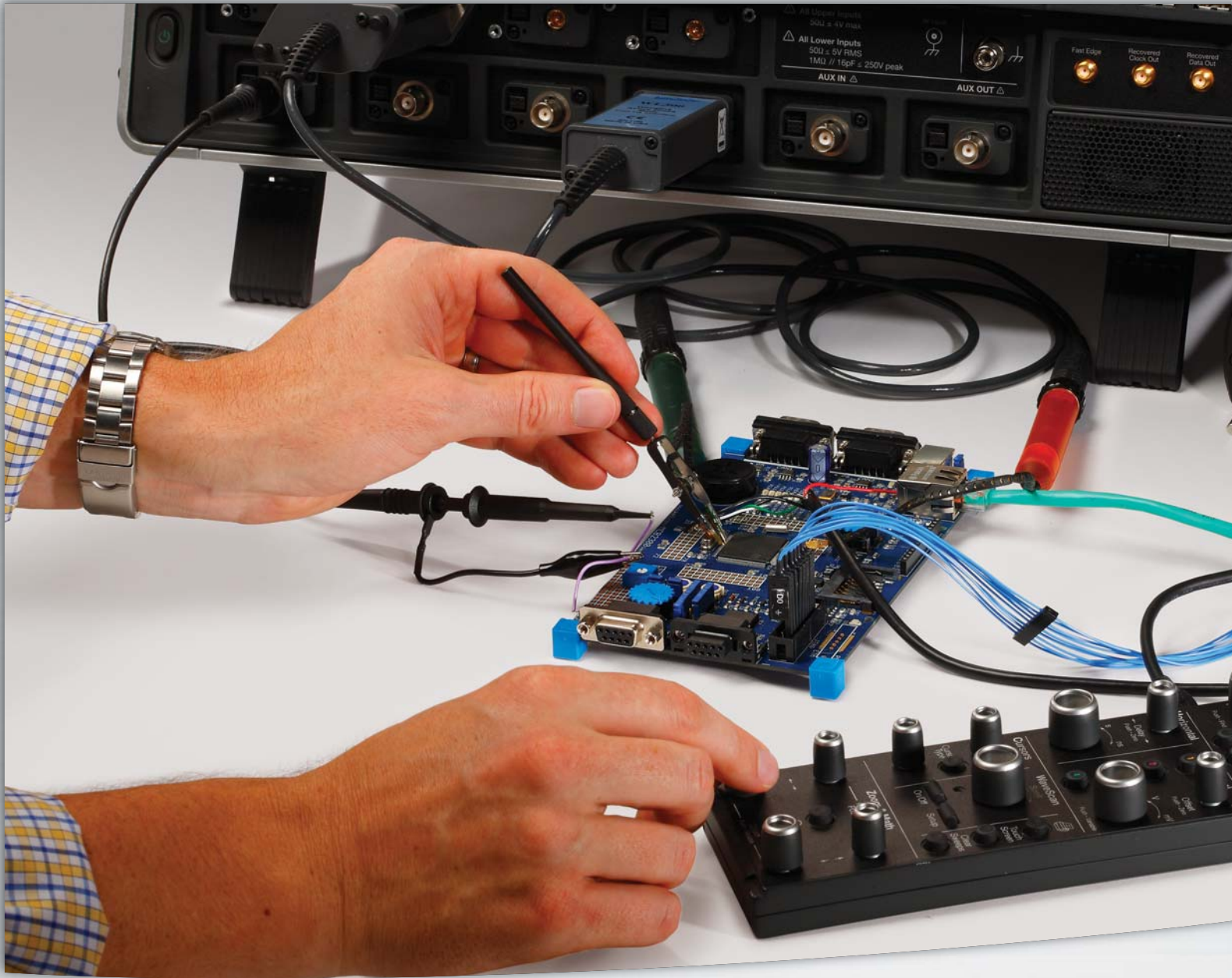

## Freedom from Limitations

WavePro 7 Zi excels in the way it offers general purpose utility never before seen in oscilloscopes from 1.5 to 6 GHz. All WavePro 7 Zi oscilloscopes contain selectable 50  $\Omega$  and 1 M $\Omega$  input capability. The 4 and 6 GHz models include both ProBus and ProLink input types which means eight probes can be attached and then

multiplexed from the front panel or by remote control. The result—it's easy to hook up a passive probe even on 4 or 6 GHz models—no more frustration and hassle of trying to find a 1 M $\Omega$  input adapter. Plus, any existing investment in LeCroy probes, such as current probes, single-ended or differential active probes, or high voltage probes, is fully leveraged. Perfect.

## A New Way to Control an Oscilloscope

WavePro's fast and responsive front panel and touch screen user interface are well integrated so you can easily choose and setup your vertical, horizontal trigger and measurements. Zoom and scroll through a long waveform signal, control the oscilloscope with the detachable front panel right next to the circuit being probed.

## Quick Insight for Debug

*Insight* is the power or act of seeing into a situation. Start up problems on a new design require a combination of problem recognition, precise triggering for fast isolation of rare events, and comparison tools that help correlate timing of problems. The ability to capture megapoints of waveform information and intuitively analyze it to find anomalies shortens the time to debug. WavePro's TriggerScan, WaveScan and deep measurement toolbox maximize quick insight.

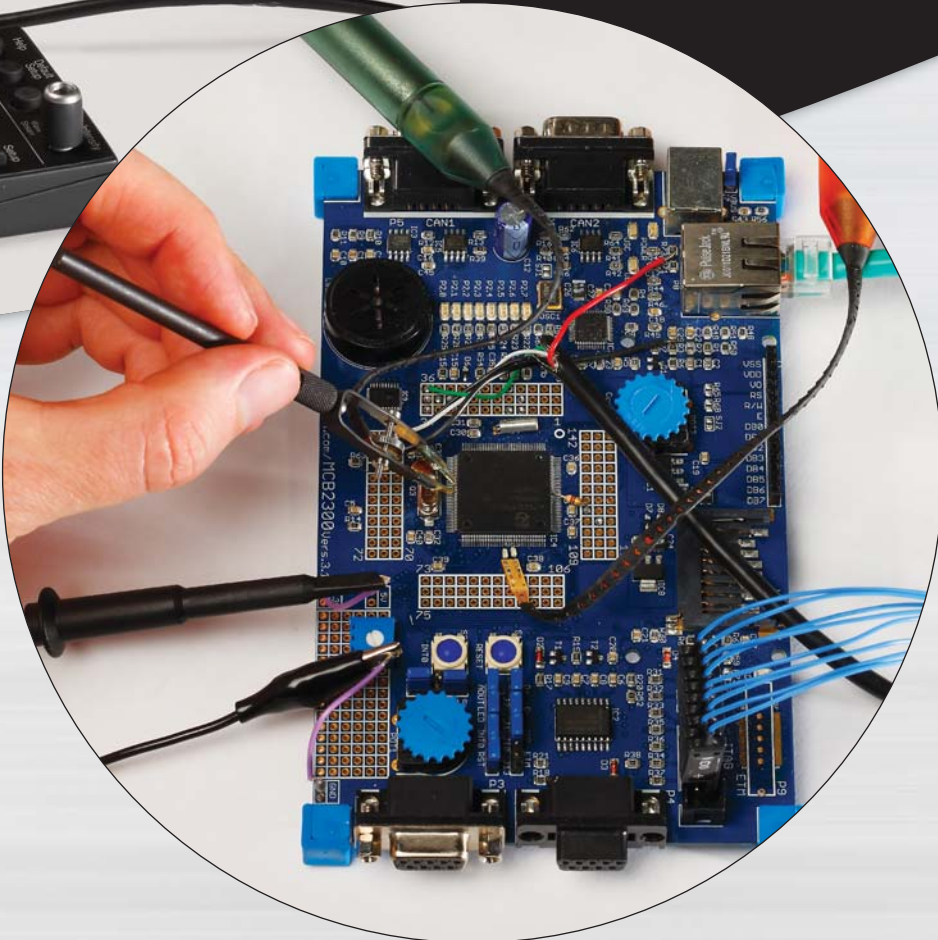

*Single-ended active probes, current probes, high-voltage, mixed signals, and high frequency differential probes all connect to the WavePro 7 Zi oscilloscope and give you a total system view.*

# QUICK INSIGHT: TRIGGER ON THE PROBLEM

## More Triggers Isolate More Problems More Effectively

A powerful combination of high bandwidth Edge and 10 different SMART triggers allow you to isolate the problem quickly and begin to focus on the cause. Most SMART triggers allow triggering on pulse widths or features as small as 200 ps. A high-speed serial trigger enables triggering on up to 2.7 Gb/s serial patterns of up to 80-bits in length. Built-in hardware clock recovery is also included.

A full range of serial triggers (I<sup>2</sup>C, SPI, UART, RS-232, CAN, LIN, FlexRay) are available, providing capability to isolate events related to serial peripheral bus traffic. Most serial triggers contain powerful conditional DATA triggering to allow inclusion or exclusion of entire ranges of data values, which will expedite understanding of how a range of serial bus traffic DATA values interact with other signals.

## TriggerScan™

TriggerScan uses high-speed hardware triggering capability with persistence displays to capture only the signals of interest and provide answers up to 100X faster than other methods. Traditional fast display update modes work best on frequent events occurring on slow edge rates while TriggerScan excels in finding infrequent events on fast edge rates.

Since hardware triggering is used to capture only the elusive events, TriggerScan is more effective at finding anomalies quickly compared to simple display technologies.

A built-in automated Trigger Trainer analyzes the waveforms, identifies normal behavior, and then sets up a large set of rare event smart trigger setups that target abnormal behavior. The trainer 'learns' trigger setups to identify faulty operation based on



*A 1 in a billion rare event seems fast but is only 5 seconds of circuit operation on a 200 MHz clock. TriggerScan finds the rare event in 4 minutes while an oscilloscope with 400,000 waveforms/second capture rate misses 99.8% of the signals and could spend nearly 42 minutes to find the error.*

slew rates, periods, amplitudes outside of a range and then applies them sequentially. It then rapidly sequences through each individual trigger with a

user-defined dwell time, and captures and displays any anomalous signals that meet the trigger conditions.

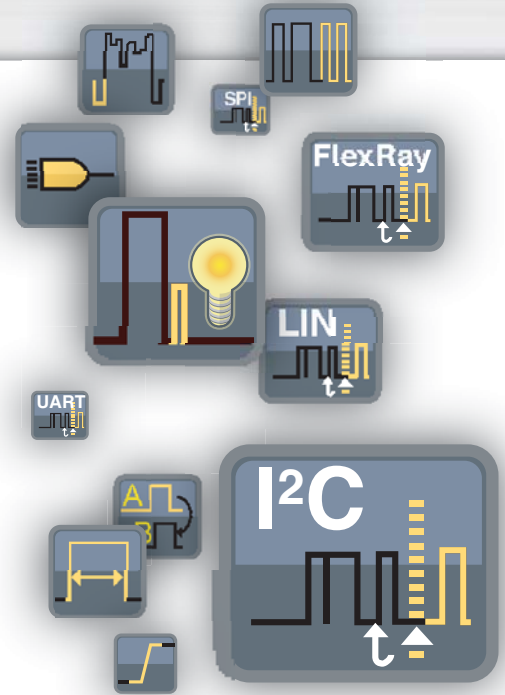

# QUICK INSIGHT: SEARCH AND SCAN TO UNDERSTAND

## WaveScan™ Advanced Search and Analysis Finds Problems that Triggers Won't Find

The best trigger won't find all unusual events—a more powerful capability is sometimes needed. WaveScan provides the ability to locate unusual events in a single capture (i.e., capture and search) or “scan” for an event in many acquisitions over a long period of time. Select from more than 20 search modes (frequency, rise time, runt, duty cycle, etc.), apply a search condition and begin scanning. When an event is found, WaveScan highlights the error on screen and displays a table listing the errors. Simply click on an event in the table and go right to the anomaly. The X-Stream II processing architecture quickly ‘scans’ millions of events much faster than any other oscilloscope. Individual events can be compared and contrasted using ScanHisto and ScanOverlay features. These tools simplify the understanding of how errors correlate across input channels thus enabling faster debug.

## Fully Integrated Mixed Signal Oscilloscope (4+36) Option

Add Mixed Signal Oscilloscope (MSO) operation using the MS Series mixed signal options. These convenient add-ons connect to the LeCroy LBUS and quickly and simply provide capability to acquire up to 36 digital lines time-correlated with analog waveforms. No time is wasted in trying to learn how to connect, synchronize or operate a complicated logic analyzer since the MSOs



Find over 20 different types of features with WaveScan. Each feature is highlighted in the waveform and listed in a table. From the Scan Table jump directly to any anomaly and overlay for characterization.

## Serial Decode—A Whole New Meaning to Insight

Advanced software algorithms deconstruct serial data waveforms into binary, hex, or ASCII protocol information and then overlay the decoded data on the waveform. Each section of the protocol is uniquely color-coded to make it easy to understand. The decode operation is fast—even with long acquisitions. Turn your oscilloscope into a

protocol analyzer with the Table Display of protocol information. Customize the table, or export table data to an Excel file. Select a table entry and automatically zoom for detail. Search for specific address or data values in the acquisition. Supported serial standards are I<sup>2</sup>C, SPI, CAN, LIN, UART-RS-232, and FlexRay.



MSO options add capability to incorporate both analog and digital signals into a 4+36 pattern trigger for useful debugging in mixed signal designs.

# X-STREAM™ II FAST ANALYSIS AND RESPONSIVENESS

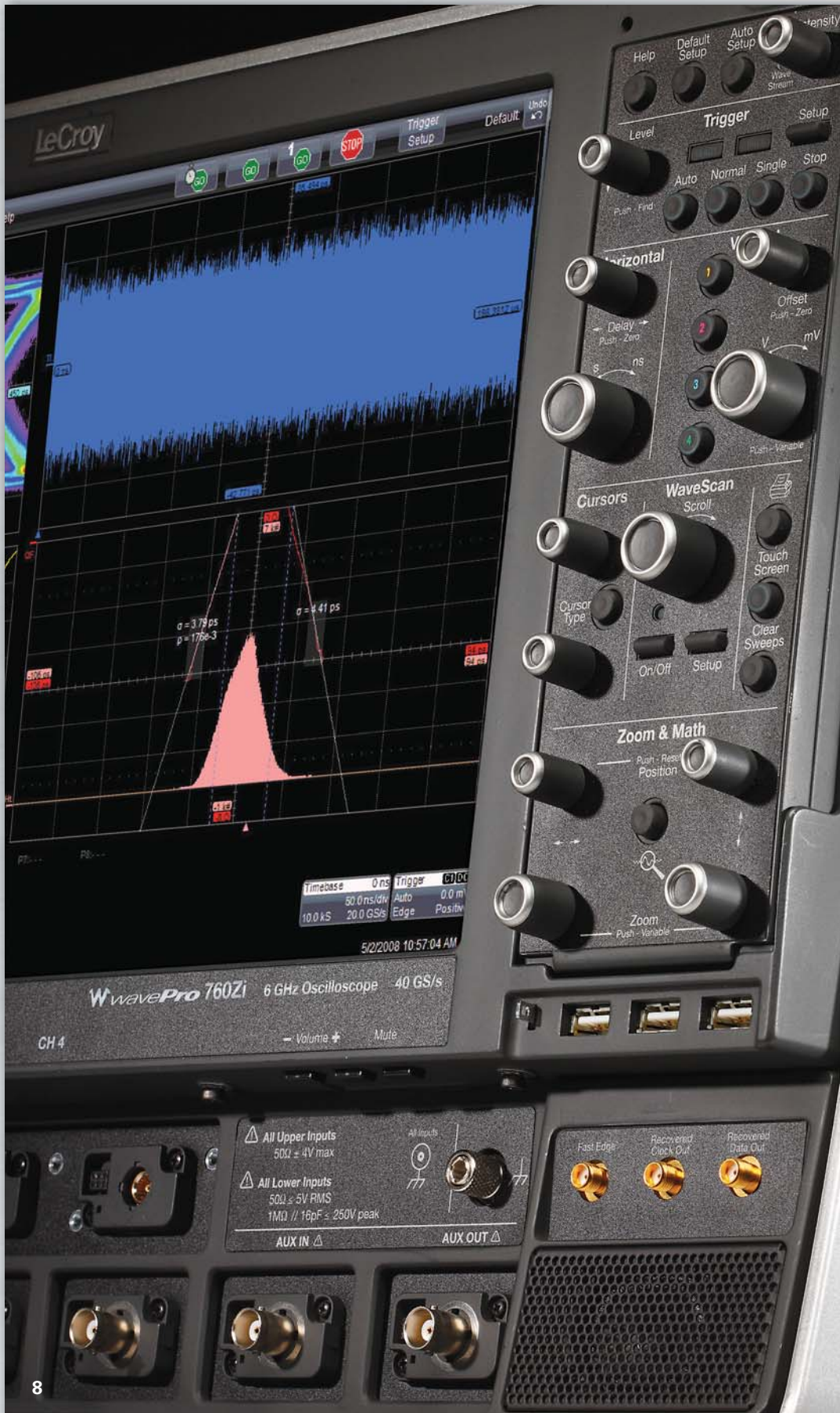

## Deep Insight for Analysis

Applying the WavePro 7 Zi Series' flexible and deep measurement and analysis toolbox to characterize and validate a design creates understanding. That is Deep Insight. An oscilloscope's operating performance comes from the design that integrates the operating system, the hardware processor specification and the waveform processing method. Each component is important to the overall architecture performance but only the X-Stream II waveform processing method unleashes amazing speed performance and no compromise in responsiveness, thus drastically reducing the time to generate Deep Insight.



## LeCroy — The Acquisition Memory Leader

LeCroy has found a way to make long acquisition memory seamless and pain free to use. The WavePro 7 Zi Series' proprietary X-Stream II architecture supports capturing, zooming, measuring and analyzing multiple waveforms at 256 Mpts deep. What you experience is performance gains of 10–20X over what is available today. Whether looking at the acquired signal or while analyzing several screens of statistics, tracking a frequency or identifying complex patterns the WavePro 7 Zi is designed to perform. When the application calls for post-processing data off-line, an optional high-speed 500 Mpts/second option provides readout over 20X faster than any other test instrument.

### Instantaneous Responsiveness

The first time you use the Zi oscilloscope you will experience responsiveness that you've never seen before. Acquiring and manipulating the longest

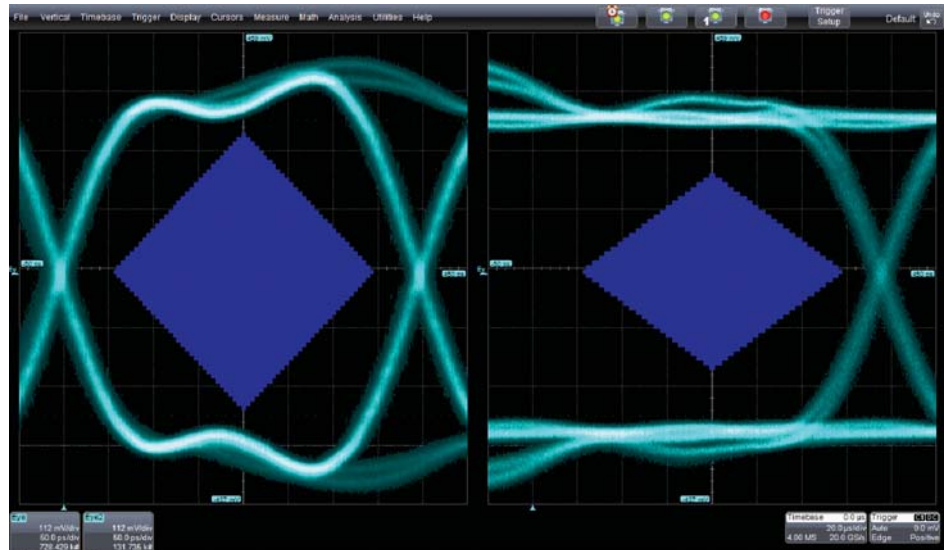

*WavePro 7 Zi excels at performing complex calculations on long waveforms, enabling users to gain waveform insight with confidence. Here, a 50 Mpts PCIe Gen1 waveform acquisition is acquired and fully analyzed in a matter of seconds—nearly 100X faster than competitive oscilloscopes.*

record lengths and the most complex WaveShape Analysis are all easily handled at the same time. Whether you use the front panel or choose to make adjustments with a mouse or the touch screen, the system performs. The simple act of turning a knob to change the offset or make an adjustment to trigger delay happens quickly. No time is lost waiting for an

operation to end or the next one to begin. Some competitive oscilloscopes become painfully slow to respond when long memory is applied. The LeCroy X-Stream II is the basis for a fast and responsive oscilloscope. Bottom line: oscilloscopes no longer need to carry a penalty for operating with long memory.

## X-Stream II Architecture

### Optimized for Fast Throughput

Designed for long memory operation and responsiveness X-Stream II technology enables high throughput of data—even when the oscilloscope is performing multiple 100 Mpts waveforms. It does so by eliminating the trade-offs between long memory length and quick processing. WavePro 7 Zi's proprietary architecture design is augmented with an Intel® Core™ 2 Quad processor, high-speed serial data buses, a 64-bit OS and up to 8 GB of RAM.

### Optimized for Long Memory

By using variable waveform segment lengths to improve the CPU cache memory efficiency the WavePro 7 Zi is designed for the fastest processing of long waveform records. The result—10-20 times faster processing compared to other oscilloscopes.

### Optimized for Responsiveness

By dynamically allocating buffers to maximize memory availability, the WavePro 7 Zi Series embodies the fastest front panel responsiveness. Waveform previewing shows interim calculation results while a built in processing abort make front panel control changes instant by stopping the current process and allowing new waveforms to be positioned or zoomed—all without a lengthy recalculation.

# DEEP INSIGHT TO CLARIFY COMPLEX SIGNALS

## All Oscilloscope Tools are not Created Equal

WavePro 7 Zi has the deepest toolbox of any oscilloscope, providing more measure, math, graphing, statistical, and other tools, and more ways to leverage the tools to get the answer faster. While many other oscilloscopes provide similar looking tools, LeCroy allows the most flexibility in applying the tools to any waveform—whether it be a math or graphing function, memory trace, FFT, or parameters. Tools can be chained together to create unique views and understanding. All tools supplied with optional application packages are always integrated into the general purpose oscilloscope.

## More Ways to Analyze

Convert time-domain information into statistical, parameter, or frequency domain. Use the oscilloscope as a spectrum analyzer for detailed frequency analysis (WPZi-SPECTRUM option). Implement Finite or Infinite Impulse Response (FIR or IIR) filters to eliminate undesired spectral components and enhance your ability to examine important waveform components (WPZi-DFP2 option).

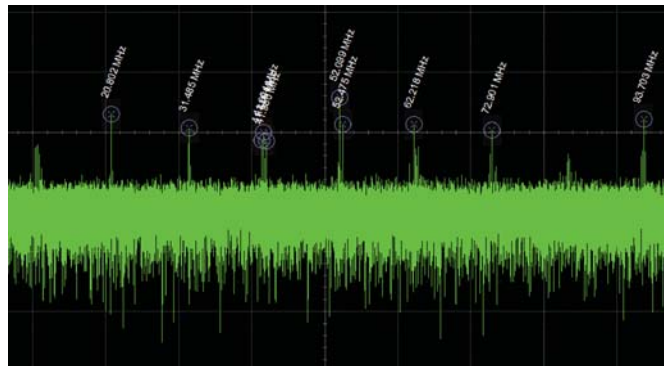

*X-Stream II fast throughput streaming architecture makes difficult analysis and deep insight possible. Above, an FFT is applied to a 50 Mpts waveform to determine root cause failure. The high frequency resolution this provides enables deep insight into signal pathologies.*



*XDEV allows MATLAB® script to apply a customized filter and return the waveform to the scope display. Continue further analysis with the advanced toolbox in the oscilloscope.*

## More Ways to Create

Only LeCroy completely integrates third party programs into the scope's processing stream by allowing you to create and deploy a new measurement or math algorithm directly into the oscilloscope environment and display the result on the oscilloscope in real-time! There is no need to run a separate program, or ever leave the scope window. With the XDEV Advanced Customization package, you can extend your WavePro 7 Zi to

include your most unique algorithms using FastWave port based on C/C++, and other programs (MATLAB, Excel, Jscript (JAVA), and Visual Basic). The code is entered in real time using the oscilloscope menus, which allows the built in debugger to provide immediate feedback. The resulting measurement or math waveform is then returned to the display, allowing further analysis within the oscilloscope.

# DISPLAY OPTIMIZED FOR ANALYSIS

## More Ways to Understand

Use the processing web to set up advanced math operations. Apply multiple operators and process large amounts of data simultaneously to achieve the deepest of insights. Overlay color-coded protocol decodes to serial datastreams for fast understanding.

## Track Views

Track in WavePro 7 Zi (WPZi-JTA2 option) uses every instance of a measurement in an acquisition to create a plot of measurement values on the Y-axis and time on the X-axis. The result is a graphical display of a measurement change time-correlated to the original channel acquisition—perfect for intuitive understanding of behaviors in FM or pulse width modulation (PWM) circuits and jitter measurements, including modulation or spikes.



Capture 5 ms (100 Mpts) of low-speed and high-speed waveforms. Easily zoom, and validate timing relationships between signals.

## Histograms

WavePro 7 Zi calculates over 750,000 measurements/second—5X faster than other oscilloscopes in its class. With this much data, it is essential to provide more than just a list of mean, min, max, sdev, etc. values. Histograms provide an intuitive way to graphically view the distribution of statistical data and quantify real insight into underlying problems.

## Trend Views

Slowly sample at 1000 seconds/div to capture hours of slow speed signal data and turn your oscilloscope into a strip chart Recorder. Using Trend views, plot measurement values of high-speed signals with slower speed signals, such as transducer or voltage values.

## Data Transfer Speeds 25–100X Faster

LeCroy's LSIB solution enables direct connection to the PCI Express® X4 high-speed data bus in the oscilloscope to enable data transfer rates up to 250 Mpts/s. All that is required is installation of an optional LSIB card in the oscilloscope and the corresponding host board (card) for desktop (laptop) PC in the remote computer. Data transfer is easily enabled through a supplied application program interface (API).

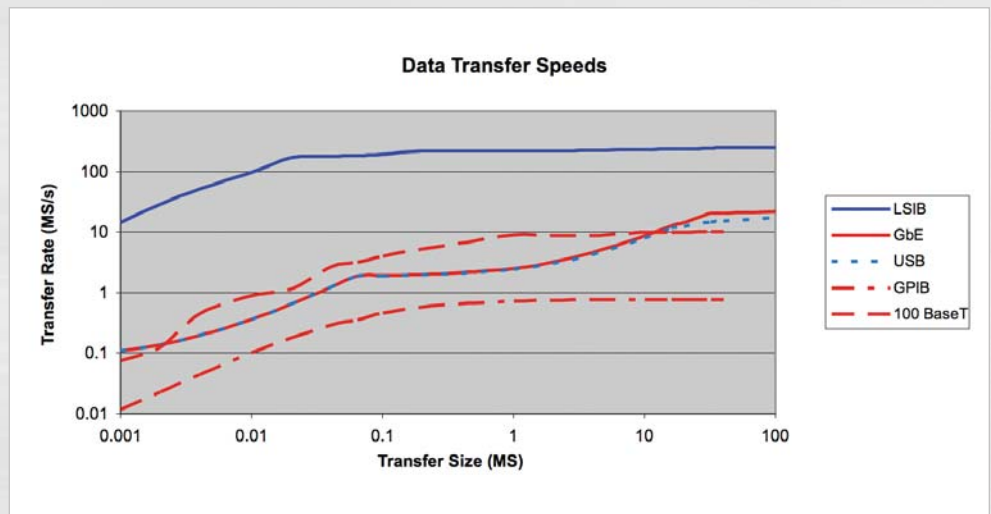

# PROBES

High-performance probes are an essential tool for accurate signal capture. Consequently LeCroy offers an extensive range of probes to meet virtually every application need. Optimized for use with LeCroy oscilloscopes, these probes set new standards for responsiveness and signal detection.

## ZS Series High Impedance Active Probes

- 1 GHz (ZS1000) and 1.5 GHz (ZS1500) bandwidths
- High Impedance (0.9 pF, 1 M $\Omega$ )
- Extensive standard and available probe tip and ground connection accessories
- $\pm 12$  Vdc offset (ZS1500)
- LeCroy ProBus system



## PPE1.2KV, PPE2KV, PPE4KV, PPE5KV, PPE6KV, PPE20KV

- Suitable for safe, accurate high-voltage measurements
- 1.2 kV to 20 kV
- Works with any 1 M $\Omega$  input oscilloscope



## ADP305, ADP300

- 20 MHz and 100 MHz bandwidth
- 1,000 V<sub>rms</sub> common mode voltage
- 1,400 V<sub>peak</sub> differential voltage
- EN 61010 CAT III
- 80 dB CMRR at 50/60 Hz
- LeCroy ProBus system



## CP030 and CP031

- 30 A<sub>rms</sub> continuous current
- 50 or 100 MHz bandwidth
- Measure pulses up to 50 A<sub>peak</sub>
- Small form factor accommodates large conductors with small jaw size
- LeCroy ProBus system



## AP031

- Lowest priced differential probe
- 15 MHz bandwidth
- 700 V maximum input voltage
- Works with any 1 M $\Omega$  input oscilloscope



## AP033 and AP034

- 500 MHz and 1 GHz bandwidth
- 10,000:1 CMRR
- Wide dynamic range, low noise
- LeCroy ProBus System



## HFP2500

- 2.5 GHz bandwidth, 0.7 pF input capacitance
- Interchangeable tips for a variety of probing needs
- Hands free probing with probe holder
- AutoColor ID matches probe color to channel



# WAVELINK PROBES

**WaveLink™ Differential probes provide industry leading performance for wideband signal connection to test instruments. The flexible connection options and superior signal fidelity make the WaveLink probe a perfect complement to the WavePro 7 Zi oscilloscope.**

## D610/D620 and D310/D320

The new amplifiers boast excellent noise performance that is essential for making precise jitter and other signal integrity measurements. The high DC and midband impedance make them ideal for many serial data and memory



applications such as PCI Express, FireWire, and DDR. With  $\pm 4$  volt offset capability and  $\pm 3$  volt common mode control, the WaveLink probes are designed for multi-purpose applica-

tions for single ended needs (such as DDR memory) and serial data applications (such as HDMI).

## D600A-AT/D500PT Browser

WaveLink browser solutions offer adjustable tip widths and varying form factors and a hand held x-y-z positioner for accurate probe placement.

## Three Different Tips for Interconnect Flexibility

WaveLink offers 3 interconnect configurations for the most flexible probing solution.



### A. Solder-In Lead

*The Solder-In interconnect lead features the highest electrical performance and smallest physical tip size of any high bandwidth differential probe.*



### B. Quick Connect (D610/D620 only)

*Quickly move the probe between multiple test points on the test circuit. Solder a pair of damping resistors at each desired interconnect location. Move easily between test points.*

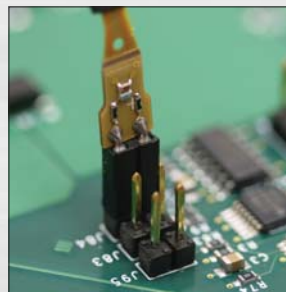

### C. Square Pin

*The Square Pin interconnect lead directly mates with a pair of 0.025" (0.635 mm) square pins that are mounted on standard 0.100" (2.54 mm) centers.*

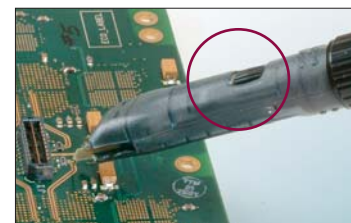
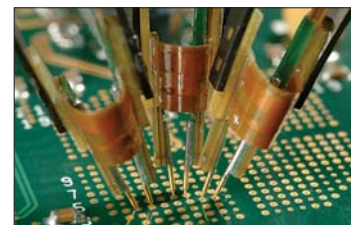

# APPLICATION SPECIFIC SOLUTIONS

In addition to the general purpose WaveShape Analysis tools, application specific solutions are available for Automotive, Embedded Design, Digital Design, and Serial Data Compliance. These packages extend the LeCroy standard measurement and analysis capabilities and expand your oscilloscope's utility as your needs change.

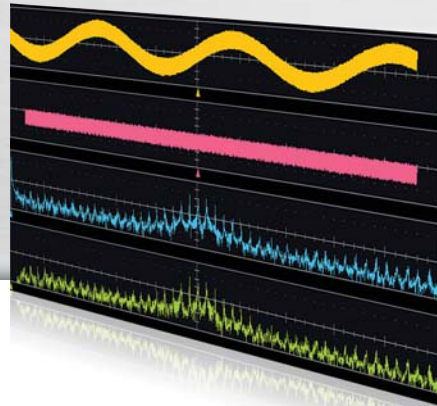

## Digital Filter Software Package (WPZi-DFP2)

DFP2 lets you implement Finite or Infinite Impulse Response filters to eliminate undesired spectral components, such as noise, and enhances your ability to examine important signal components. You can choose from a standard set of FIR or IIR filters. You can also design your own filters.



## Spectrum Analyzer Analysis Package (WPZi-SPECTRUM)

The spectrum converts the controls of your oscilloscope to those of a spectrum analyzer. Adjust the frequency span, resolution and center frequency. Apply filtering to your signal and watch the frequency signature change in real time. A unique peak search labels spectral components and presents frequency and level in a table. Touch any line to move to that peak.

## Serial Data Trigger and Decode

Quickly and easily isolate serial data events on your embedded controller for better understanding and faster debug. Trigger and decode options provide powerful conditional triggering, intuitive color-coded decode overlays, and a table summary with search and zoom capabilities. Solutions are available for I<sup>2</sup>C, SPI, UART/RS-232, CAN, LIN, and FlexRay.

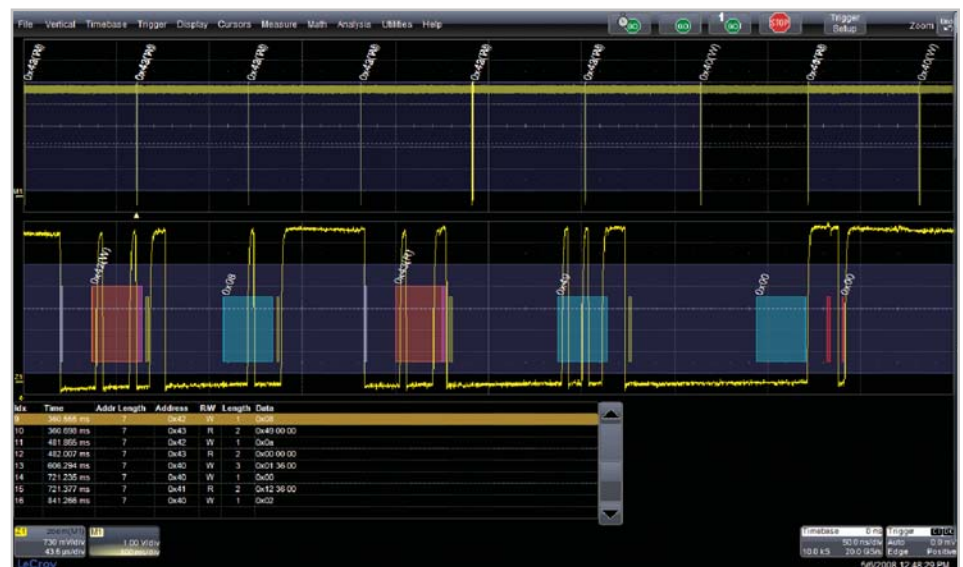

I<sup>2</sup>C decoding package with intuitive color decoding and table view allows quick location of 0x42 address.

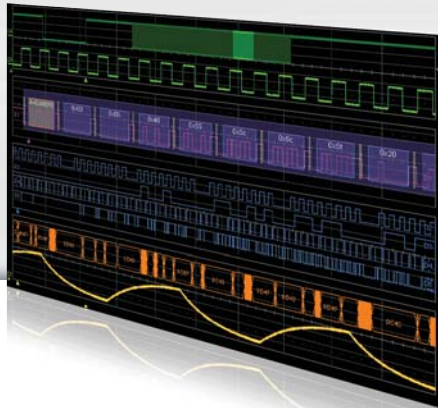

### Mixed Signal Oscilloscope Option (MS-250/MS-500)

The Mixed Signal option allows the WavePro 7 Zi to convert to a mixed signal oscilloscope with up to 36 digital channels. Channels are sampled at 2 GS/s up to 50 Mpts/Ch. Having up to 36 digital inputs time-synchronized with four analog channels extends the oscilloscope's use to provide a total system view.

### Serial Data Compliance Packages

QualiPHY serial data compliance packages provide easy to use step-by-step instructions for a broad set of serial data standards, such as USB 2.0, PCI Express, SATA, and UWB (Ultra-Wide-band). With fast automated performance, illustrated instructions and comprehensive reporting capability, QualiPHY packages are the best solution for compliance testing.

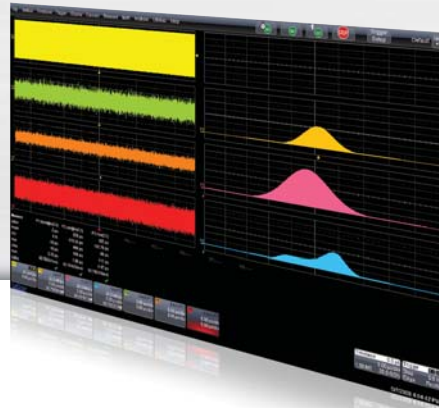

### Jitter and Timing Analysis Package (WPZi-JTA2)

Specialized timing parameters measure period, cycle-cycle, half period, width, etc. jitter on a variety of signals. Use the three views of jitter (statistical, time, and frequency) to understand root cause and to debug problems. Histograms provide understanding of statistical distributions. Tracks provide a means to show time-correlated peaks of jitter, and compare to other signals. FFTs provide the ability to debug root causes of high in-circuit jitter.

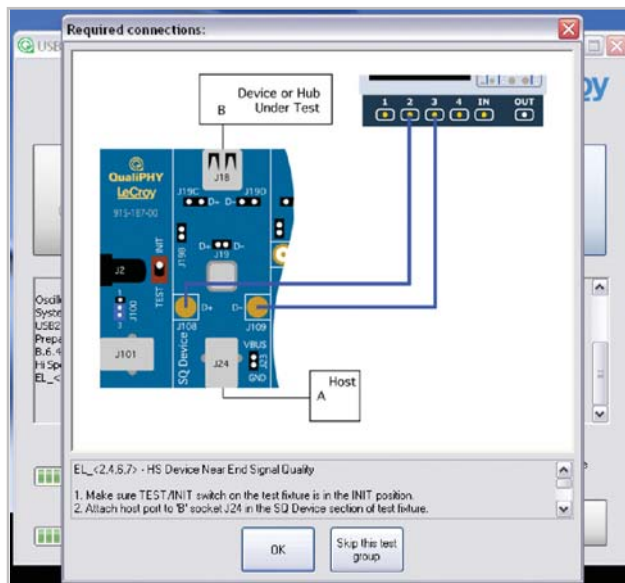

Quick Insight.  
Deep Insight.  
Experience the  
**WavePro 7 Zi Series**

EXPERIENCE  
THE 7 Zi

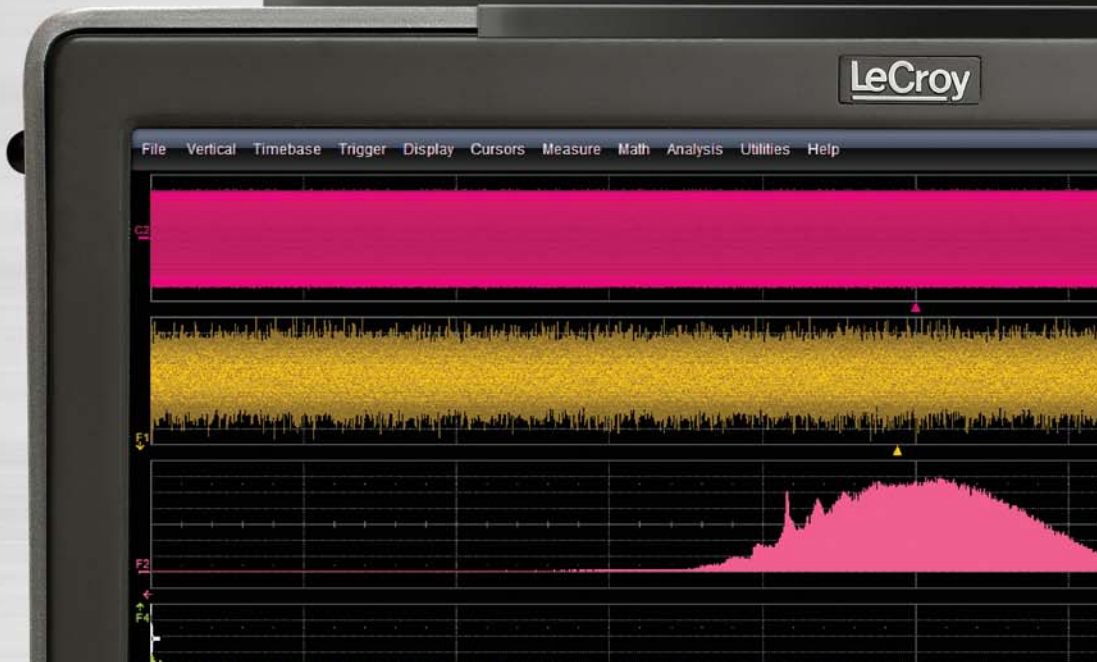
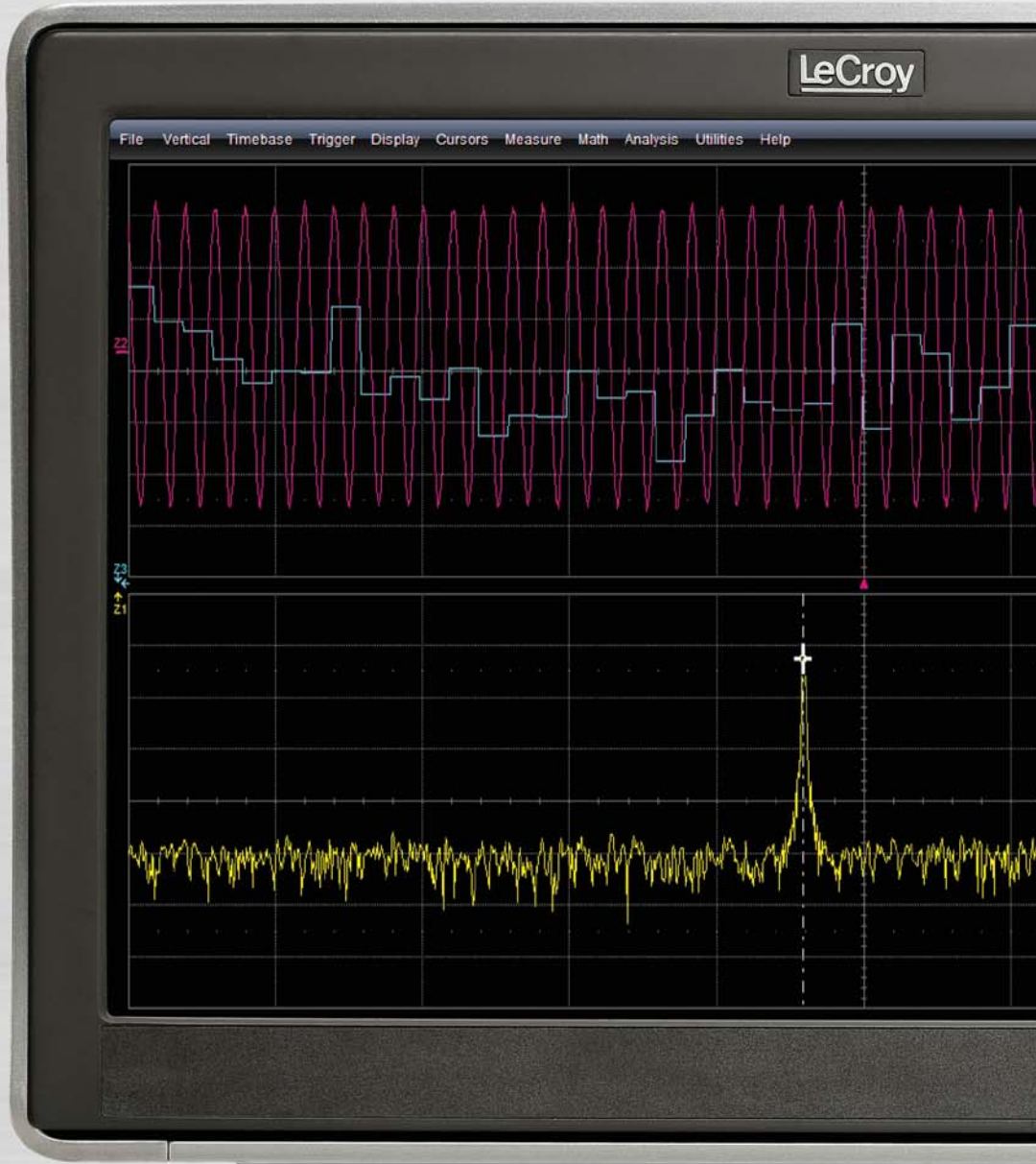





The nature of circuit design, validation and debug is to understand that which has been modeled, designed and fabricated. LeCroy oscilloscopes provide Insight. They illuminate the unseen. Every engineer who has worked on the bench remembers a 'challenge' design where a one in a billion event caused an interruption or lock-up. Even circuits simulated and designed for the best robustness can demonstrate unforeseen behavior when the hardware arrives. WavePro 7 Zi oscilloscopes maintain high signal fidelity, and provide the

Create your own report to document your measurements and conclusions. LabNotebook™ automatically saves all waveforms and setups, lets you freehand scribble on the display and save the report in formats such as pdf, rtf or html. Incorporate your own logo and you're ready to print or email the whole report. Documentation complete.

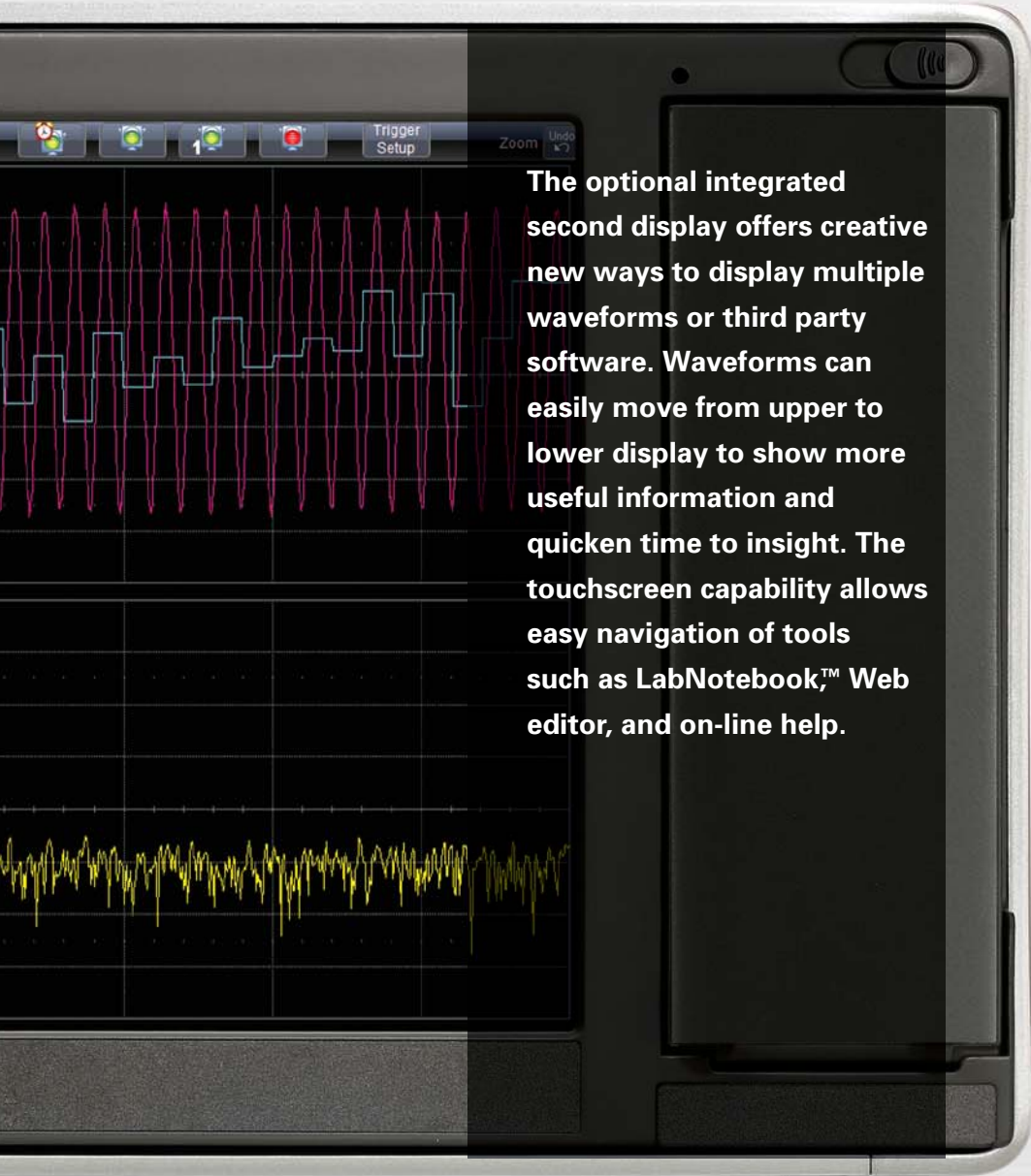

The optional integrated second display offers creative new ways to display multiple waveforms or third party software. Waveforms can easily move from upper to lower display to show more useful information and quicken time to insight. The touchscreen capability allows easy navigation of tools such as LabNotebook™, Web editor, and on-line help.



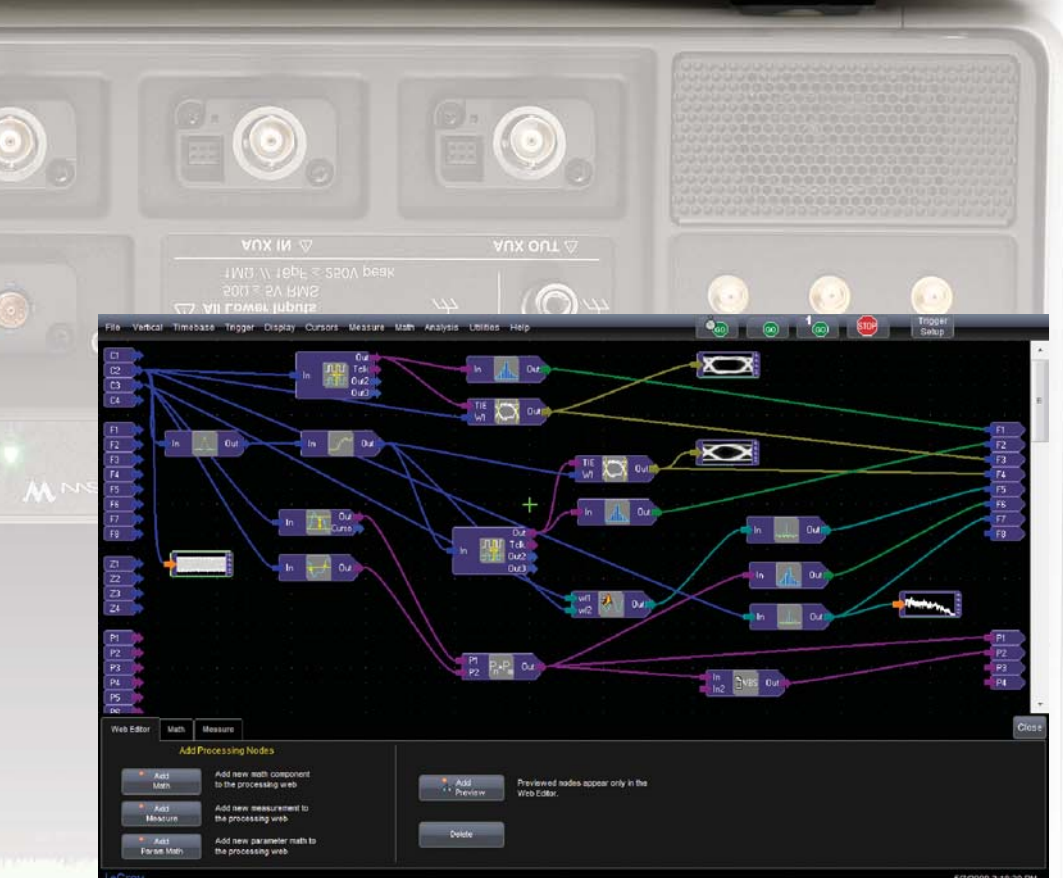

most usable and thorough hardware and software measuring toolsets and advanced triggering to find elusive events. The integration and speed in finding, understanding and fixing design problems inspires confidence. LeCroy WavePro 7 Zi oscilloscopes were created to provide insight and designed to inspire the confidence necessary to get the job done more completely and in less time.

*Insight comes from access to multiple ways to analyze a problem. WavePro Zi's Processing Web is a graphical, intuitive way to create powerful, chained math or measurement calculations. No equation editing required...it's all visual.*

# SDA 7 Zi SERIES

## Key Features

- LeCroy's unique summary view displays the Eye Pattern, TIE, Bathtub Curve and Jitter Histogram all on the screen at the same time
- De-Embed cables allow all of the SDA tools to be used as if the cables were not in the system
- Create Eye Patterns utilizing the full memory for maximum statistical significance
- Display Eye Patterns up to 100 times faster than other solutions
- Trigger on 80-bit patterns at up to 2.7 Gb/s using the Serial Trigger
- Decode 8b/10b data on up to 4 lanes simultaneously
- Configure software PLL for any standard or custom requirement
- Serial data compliance testing
  - Ethernet
  - USB 2.0
  - HDMI 1.2
  - PCI Express (2.5 GT/s)
  - Serial ATA (1.5 Gb/s)
  - UWB



## A Total Solution for Serial Data Analysis

Unleash the power of serial data analysis for understanding and characterizing your design, proving compliance and why a device or host fails compliance. The Quad Summary View of the SDA always shows the eye, TIE, bathtub curve and jitter histogram. No other Analyzer lets you see the simultaneous interaction and real-time changes in all four measurements. The X Stream II Architecture provides fast updates and the fastest eye interpretation. The fastest eye building and the maximum unit intervals per second means the shortest time to understanding.

A high-speed serial trigger enables triggering on up to 2.7 GB/s serial patterns or up to 80-bits in length.

Jitter calculations are based on statistics. With the most advanced long memory performance to 256 Mpts/Ch and X-Stream II enabled responsiveness, jitter breakdown occurs rapidly.

## Automated Compliance Testing

QualiPHY compliance test suite provides easy to use step by step instructions for testing compliance on a wide array of serial data standards. Fast automated test operation, illustrated instructions and connection diagrams simplify the process. Complete test reporting is provided along with 'stop on fail' feature which starts you on your debug process.

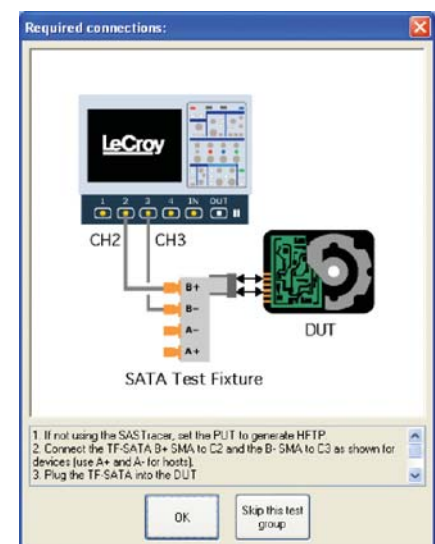

# A TOTAL SOLUTION FOR SERIAL DATA ANALYSIS



Whether debugging eye pattern failures or other compliance test failures, the SDA Series has the tools that are easily accessible. Rapidly isolate the source of the problem in your design. Advanced usability like 8b/10b decode, mask violation locator, ISI plot, spread spectrum clocking analysis are easily accessed. Cable de-embedding lets you adjust for cable effects by inserting S-parameters for a given cable type. The result...true rise time and amplitudes in your measurements. The SDA uses the same flexible math on math analysis which is valuable when understanding design behavior in the event of a compliance failure.

## Data Rate Configuration Chart

Standard	Bit Rate	Recommended Bandwidth	Recommended Oscilloscope
Ethernet	250 Mb/s	1 GHz	WavePro 715Zi or Above
USB	480 Mb/s	2 GHz	WavePro 725Zi or Above
Fibre Channel	531.25 Mb/s	1.5 GHz	SDA 725Zi or Above
IEEE 1394b FireWire	786.43 Mb/s	2 GHz	SDA 725Zi or Above
Rapid I/O LP-LVDS	1 Gb/s	2.5 GHz	SDA 725Zi or Above
Fibre Channel	1.0625 Gb/s	2.5 GHz	SDA 725Zi or Above
IOF	1.24416 Gb/s	3.5 GHz	SDA 735Zi or Above
Ethernet	1.25 Gb/s	3.5 GHz	SDA 735Zi or Above
Rapid I/O LP-LVDS	1.25 Gb/s	3.5 GHz	SDA 735Zi or Above
Rapid I/O LP-LVDS	1.5 Gb/s	4 GHz	SDA 740Zi or Above
SAS	1.5 Gb/s	4 GHz	SDA 740Zi or Above
SerialATA	1.5 Gb/s	4 GHz	SDA 740Zi or Above
IEEE 1394b FireWire	1.5729 Gb/s	4 GHz	SDA 740Zi or Above
HDMI 1.2a / DVI	1.65 Gb/s	4 GHz	SDA 740Zi or Above
Rapid I/O LP-LVDS	2 Gb/s	6 GHz	SDA 760Zi or Above
Fibre Channel	2.125 Gb/s	6 GHz	SDA 760Zi or Above
InfiniBand	2.5 Gb/s	6 GHz	SDA 760Zi or Above
PCI Express	2.5 Gb/s	6 GHz	SDA 760Zi or Above
Rapid I/O LP-LVDS	2.5 Gb/s	6 GHz	SDA 760Zi or Above

# SDA – ADVANCED TOOLS TO ISOLATE AND ANALYZE

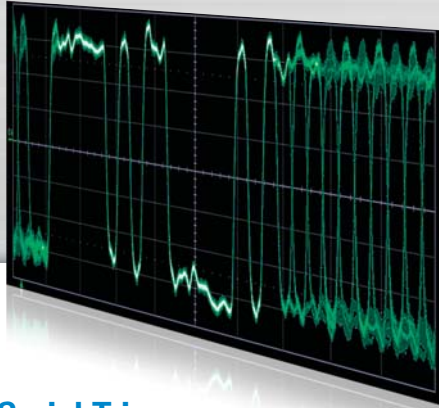

## Serial Trigger

The SDA 7 Zi Series come standard with the 80-bit Pattern Trigger installed. The SDA 760Zi and SDA 740Zi include the High-speed Pattern Trigger option (up to 2.7 Gb/s) while the SDA 735Zi and SDA 725Zi pattern triggers up to 1.25 Gb/s. Both pattern triggers provide a recovered clock and data output on the front of the oscilloscope.



## 8b/10b Decoding

LeCroy 8b/10b serial decode option with powerful search capability enables captured waveforms to be searched for user-defined sequences of symbols. Multi-lane analysis decodes up to four simultaneously captured lanes.



## Spread Spectrum Clock

LeCroy's long acquisition memory and fast sample rate are ideal for seeing fine details in data transmitted with Spread Spectrum Clocks (SSC). Today's designs use SSC for its low modulation frequency, typically 33 kHz, and lower noise contribution. Quickly access the whole waveform memory to see the modulation effects.

## Eye Patterns Show Mask Violations to the Bit

- Eye pattern measurement on up to 8 million consecutive bits ensures that even transient jitter and noise events are captured
- Consecutive bit eye pattern analysis allows for the measurement of the wave shapes of individual bits that violate the compliance mask (violation location)
- The fastest UI accumulation and very low measurement jitter (typically 1 ps rms)

## Jitter Bathtub

- Bathtub curve extrapolated directly from the time interval error (TIE) histogram gives an accurate total jitter measurement
- Presents jitter as a function of bit error rate
- Predicts maximum BER performance of system

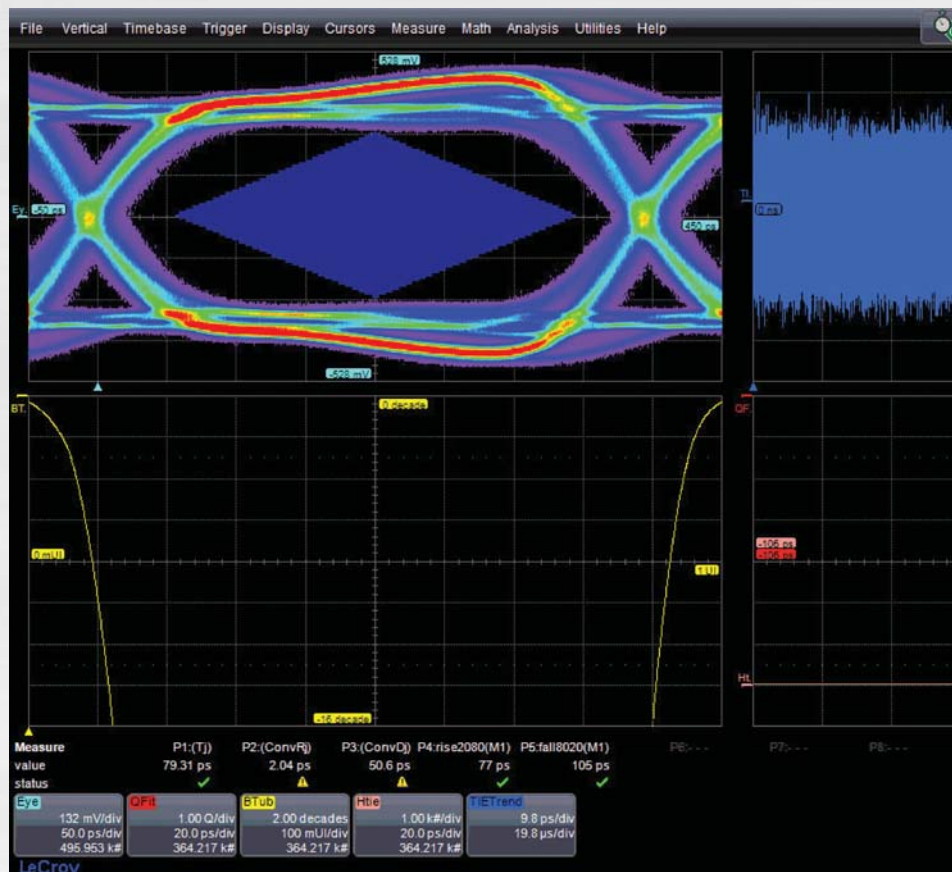

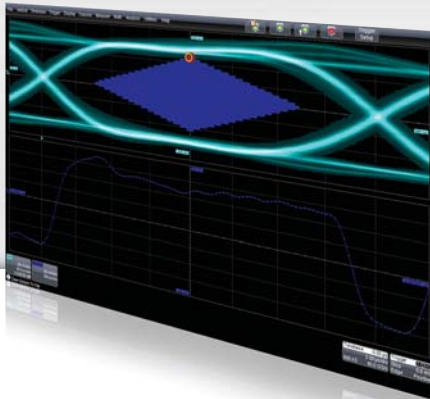

### Mask Violation Locator

Mask failures are identified by contrasting color spots which appear anywhere the data intersects the mask template. Users can call up the actual stored bit stream waveform at the point in time of the initial failure. The actual bit sequence is also identified, pointing out any ISI problems. Instantly jump to the next violation, or any other within the stored pattern.

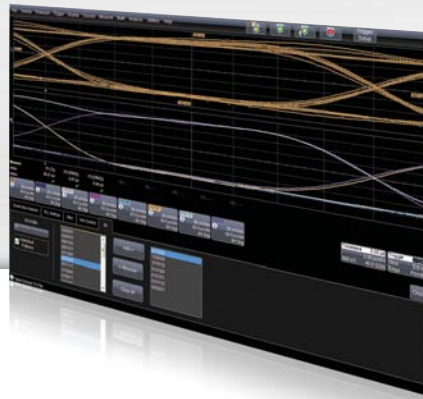

### ISI Plot

The ISI plot displays data dependent jitter contributions to the eye pattern for the second-to-last bit of a bit length, set from 3 to 10. This plot measures data dependent jitter without the need for a repeating bit pattern.



Before

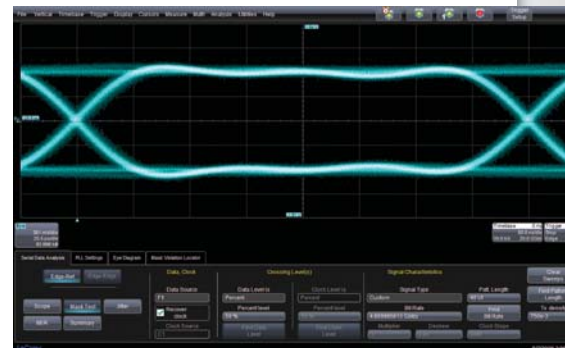

After

### Cable De-Embedding

Remove cable effects from your measurements. Simply enter the S-parameters of the cable then all of the functionality of the SDA 7 Zi can be utilized with cable effects de-embedded.

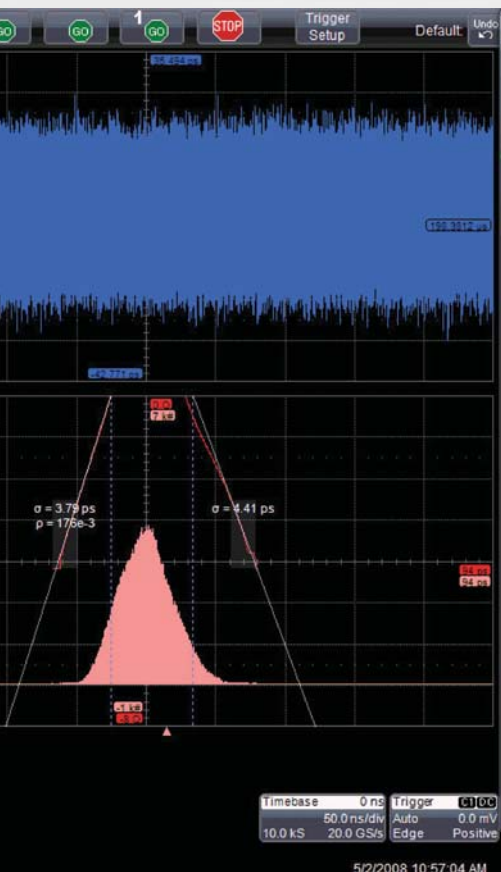

### Jitter Trend

- Time domain view of jitter displays transient jitter events that can be missed by viewing the histogram alone
- Clearly shows any non-stationary jitter behavior

### Histogram

- Display of measured jitter histogram clearly shows any unusual jitter distributions such as bi-modal or non-Gaussian tails. By simply viewing the jitter breakdown (Rj, Dj), the raw data view shows jitter behavior that can be lost
- This unprocessed display gives a high degree of confidence in the accuracy of the jitter breakdown and bathtub curve

# DDA 7 Zi SERIES

## Key Features

- 3.5 or 6 GHz
- Zoom on multi-zoom on sectors
- One button access to read channel emulation and disk drive triggers
- Head equalization, channel Emulation, and SAM histograms
- Segmented memory for sector by sector parametric analysis
- Built-in PWxx, amplitude, pulse shape, and ACSN parametric measurements
- Customizable with MATLAB, Visual Basic, or Excel scripts
- 500 Mpts/s data transfer rate from oscilloscope to PC for offline analysis (optional)
- Full suite of SDA tools integrated for analysis of SAS/SATA drives
- 20 Mpts memory standard
- 8 dual integrated inputs of 50  $\Omega$  and 1 M $\Omega$  with DDA 760Zi



## A Total Solution for Disk Drive Analysis

### Maximum Performance

LeCroy Disk Drive Analyzers (DDA) assist data storage design engineers by integrating tools that improve the time to market of new products and accelerate understanding and failure analysis on existing drives. LeCroy continues that tradition with the DDA 7 Zi Series equipped with its powerful Disk Drive Analysis toolset. Capture, view, and analyze the wave shape of high-speed, complex drive signals with speed and integrity. Data Storage applications are memory intensive as capturing multiple sectors or a complete track of data can be important in troubleshooting a design or characterizing media. The X-Stream II architecture enables fast and accurate measurements and analysis of disk drive signals. Memory can be extended to 128 Mpts/Ch (256 Mpts/Ch on 2 Ch) using Option L.

Both the DDA 760Zi and DDA 735Zi offer the convenience of selectable 50  $\Omega$  or 1 M $\Omega$  inputs. The standard 20 Mpts of waveform memory and 40 GS/s capture on two channels, means multiple drive sectors can be acquired at once.

### Long Memory and Flexibility in Finding Problems

Acquire a head signal up to 6 GHz, and then QuickZoom it from the front panel. The DDA copies and expands the drive signal automatically. Simply scroll horizontally and vertically to examine any sector. Multiple zooms let you view up to eight separate areas of the head signal; each zoom comes in a distinct color. Disk drive parameters let you characterize the pulse width variation or signal-to-noise ratio across a region. Failure Analysis engineers can store and recall golden waveforms and panel setups to compare problem



# A TOTAL SOLUTION FOR DISK DRIVE ANALYSIS

drives with the known good drives. Analog-to-digital converters running at speeds up to 40 GS/s ensure the right sensitivity to measure today's high-speed read channels. In every DDA, you can run your customer-developed scripts to view the captured signal with the filters matched to your channel and media. Custom user scripts can be created in MATLAB, Visual Basic, Excel or other formats.

## Exceptional Trigger and Sequence Performance

The DDA's disk triggers allow you to set up a series of events in the signal that then cause a trigger. For example, qualify the signal on the index signal and then capture all the sectors of information on the track. As memory is increased in

the DDA, more sectors can be captured, with up to 50 picosecond/sample time resolution. Up to 15,000 sectors of data can be gathered with the DDA 7 Zi analyzers. An optional capability, Streaming Sequence, uses the X-Stream II and the fast hardware architecture of the DDA to stream up to 300,000 segments of data to memory; all taken at a high trigger rate.

## Natural Graphical Interface

One press on the DDA menu takes you directly to the Disk Drive Analyzer features. The familiar controls on the front panel, coupled with a natural, context-sensitive graphical user-interface, react quickly to your commands. Functionality is exactly where you expect it to be.

The DDA 7 Zi provides one button access to all the tools needed to accurately debug and analyze disk drive operation.

The DDA 7 Zi Features:

- 28 Custom Parameters
- Specific Drive Triggers
  - Sector
  - Servo Gate
  - Read Gate Trigger
- Advanced Drive Analysis Tools
  - Head Filter Equalizer Emulation
  - Channel Emulation
  - SAM Histograms
  - Plot of SAM Values
  - Analog Compare

*Simultaneously connecting low-speed signals, like index and servo gate, and high-speed signals, like read channels has never been easier. With integrated 50  $\Omega$  and 1 M $\Omega$  inputs on all models, there is no longer a need for expensive adapters.*



# SPECIFICATIONS

Vertical System	WavePro 715Zi	WavePro 725Zi (SDA)	WavePro 735Zi (SDA, DDA)	WavePro 740Zi (SDA)	WavePro 760Zi (SDA, DDA)
Analog (ProLink Input) Bandwidth @ 50 Ω (-3 dB) (≥ 10 mV/div)	Not Applicable	Not Applicable	Not Applicable	4 GHz (≥ 10 mV/div)	6 GHz (≥ 10 mV/div)
Analog (ProBus Input) Bandwidth @ 50 Ω (-3 dB)	1.5 GHz (≥ 10 mV/div)	2.5 GHz (≥ 10 mV/div)	3.5 GHz (≥ 10 mV/div)	3.5 GHz (≥ 10 mV/div)	3.5 GHz (≥ 10 mV/div)
Analog (ProBus Input) Bandwidth @ 1 MΩ (-3 dB)	500 MHz (Typical)	500 MHz (Typical)	500 MHz (Typical)	500 MHz (Typical)	500 MHz (Typical)
Rise Time (Typical, 50 Ω)	235 ps	150 ps	120 ps	105 ps	70 ps
Input Channels	4				
Bandwidth Limiters	20 MHz, 200 MHz, 1 GHz		20 MHz, 200 MHz, 1 GHz, 3 GHz	20 MHz, 200 MHz, 1 GHz, 3 GHz	20 MHz, 200 MHz, 1 GHz, 3 GHz, 4 GHz
Input Impedance	50 Ω ±2% or 1 MΩ    16 pF, 10 MΩ    11 pF with supplied probe				
Input Coupling	1 MΩ: AC, DC, GND; 50 Ω: DC, GND				
Maximum Input Voltage	50 Ω: ±5 V <sub>rms</sub> 1 MΩ: 250 V max. (peak AC: ≤ 10 kHz + DC)			50 Ω (ProBus): ±5 V <sub>rms</sub> 50 Ω (ProLink): ±4 V <sub>peak</sub> 1 MΩ (ProBus): 250 V max. (peak AC: ≤ 10 kHz + DC)	
Channel-Channel Isolation	≥ 100:1 at 2 GHz; ≥ 40:1 at 3 GHz; ≥ 20:1 at 4 GHz				
Vertical Resolution	8 bits; up to 11 bits with enhanced resolution (ERES)				
Sensitivity	50 Ω: 2 mV–1 V/div, fully variable (2–9.99 mV/div via zoom); 1 MΩ: 2 mV–10 V/div, fully variable				
DC Gain Accuracy	±1.5% of full scale				
Offset Range	50 Ω (ProBus Input): ±750 mV @ 10–170 mV/div ±4 V @ 172 mV/div–1 V/div 1 MΩ (ProBus Input): ±1 V @ 2–128 mV/div ±10 V @ 130 mV–1.28 V/div ±100 V @ 1.3 V–10 V/div			50 Ω (ProLink Input): ±750 mV @ 10–118 mV/div ±4 V @ 120 mV/div–1 V/div 50 Ω (ProBus Input): ±750 mV @ 10–170 mV/div ±4 V @ 172 mV/div–1 V/div 1 MΩ (ProBus Input): ±1 V @ 2–128 mV/div ±10 V @ 130 mV–1.28 V/div ±100 V @ 1.3 V–10 V/div	

Offset Accuracy ±(1.5% of full scale + 1.0% of offset value + 1 mV)

## Horizontal System

Timebases	Internal timebase common to 4 input channels; an external clock may be applied at the auxiliary input				
Time/Division Range	Real time: 20 ps/div–1000 s/div (RIS mode: 20 ps/div–10 ns/div; Roll mode: up to 1000 s/div)				
Clock Accuracy	≤ 1 ppm + (aging of 0.5 ppm/yr from last calibration)				
Time Interval Accuracy	< 0.06 / SR + (clock accuracy * Reading) (rms)				
Jitter Noise Floor	1.5 ps (Typical)	1 ps (Typical)	800 fs (Typical)	750 fs (Typical)	560 fs (Typical)
Trigger and Interpolator Jitter	3 ps <sub>rms</sub> (Typical)	2 ps <sub>rms</sub> (Typical)		1 ps <sub>rms</sub> (Typical)	
Channel-Channel Deskew Range	±9 x time/div. setting, 100 ms max., each channel				
External Timebase Reference (Input)	10 MHz; 50 Ω impedance, applied at the rear input				
External Timebase Reference (Output)	10 MHz; 50 Ω impedance, applied at the rear output				
External Clock	0.1 Hz–100 MHz, 50 Ω or 1 MΩ impedance, applied at the auxiliary input				

Acquisition System	WP715Zi	WP725Zi (SDA)	WP735Zi (SDA, DDA)	WP740Zi (SDA)	WP760Zi (SDA, DDA)
Single-Shot Sample Rate/Ch	20 GS/s on 2 Ch 10 GS/s on 4 Ch (Option) WPZi-1.5GHZ-4X20GS doubles the sample rate)		40 GS/s on 2 Ch 20 GS/s on 4 Ch		
Random Interleaved Sampling (RIS)	200 GS/s for repetitive signals (20 ps /div. to 10 ns/div)				
Maximum Trigger Rate	1,250,000 waveforms/second (in Sequence Mode, up to 4 channels)				
Intersegment Time	800 ns				
Maximum Acquisition Memory Points/Ch	(4 Ch / 2 Ch)			Number of Segments	
Standard Memory	10 M / 20 M (Standard memory for SDA and DDA scopes are 20M / 40 M)			5000	
S-32 – Memory Option	32 M / 64 M			15,000	
M-64 – Memory Option	64 M / 128 M			15,000	
L-128 – Memory Option	128 M / 256 M			15,000	

# SPECIFICATIONS

Acquisition Processing	WavePro 715Zi	WavePro 725Zi (SDA)	WavePro 735Zi (SDA, DDA)	WavePro 740Zi (SDA)	WavePro 760Zi (SDA, DDA)
Averaging	Summed averaging to 1 million sweeps; continuous averaging to 1 million sweeps				
Enhanced Resolution (ERES)	From 8.5 to 11 bits vertical resolution				
Envelope (Extrema)	Envelope, floor, or roof for up to 1 million sweeps				
Interpolation	Linear or Sin x/x				

## Triggering System

Modes	Normal, Auto, Single, and Stop				
Sources	Any input channel, Aux, Aux/10, or line; slope and level unique to each source (except line trigger)				
Coupling Mode	DC, AC, HFRej, LFRrej				
Pre-trigger Delay	0–100% of memory size (adjustable in 1% increments of 100 ns)				
Post-trigger Delay	0–10,000 divisions in real time mode, limited at slower time/div settings or in roll mode				
Hold-off by Time or Events	From 2 ns up to 20 s or from 1 to 99,999,999 events				
Internal Trigger Range	±4.1 div from center				
Trigger Sensitivity with Edge Trigger (Ch 1–4) ProBus Inputs	2 div @ < 1 GHz 1.5 div @ < 500 MHz 1.0 div @ < 200 MHz (for DC, AC, LFRrej coupling, ≥ 10 mV/div, 50 Ω)	2 div @ < 2.5 GHz 1.5 div @ < 1.25 GHz 1.0 div @ < 200 MHz (for DC, AC, LFRrej coupling, ≥ 10 mV/div, 50 Ω)		2 div @ < 3.5 GHz 1.5 div @ < 1.75 GHz 1.0 div @ < 200 MHz (for DC, AC, LFRrej coupling, ≥ 10 mV/div, 50 Ω)	
Trigger Sensitivity with Edge Trigger (Ch 1–4) ProLink Inputs	Not Applicable			2 div @ < 4 GHz 1.5 div @ < 2 GHz 1.0 div @ < 200 MHz (for DC, AC, LFRrej coupling, ≥ 10 mV/div, 50 Ω)	2 div @ < 6 GHz 1.5 div @ < 3 GHz 1.0 div @ < 200 MHz (for DC, AC, LFRrej coupling, ≥ 10 mV/div, 50 Ω)
External Trigger Sensitivity, (Edge Trigger)	2 div @ < 1 GHz 1.5 div @ < 500 MHz 1.0 div @ < 200 MHz (for DC, AC, LFRrej coupling)				
Max. Trigger Frequency, SMART Trigger™	1.0 GHz @ ≥ 10 mV/div (minimum triggerable width 500 ps)	2.0 GHz @ ≥ 10 mV/div (minimum triggerable width 300 ps)	2.0 GHz @ ≥ 10 mV/div (minimum triggerable width 250 ps)	2.0 GHz @ ≥ 10 mV/div (minimum triggerable width 200 ps)	
External Trigger Input Range	Aux (±0.4 V); Aux/10 (±4 V)				

## Basic Triggers

Edge	Triggers when signal meets slope (positive, negative, or either) and level condition.
TV-Composite Video	Triggers NTSC or PAL with selectable line and field; HDTV (720p, 1080i, 1080p) with selectable frame rate (50 or 60 Hz) and Line; or CUSTOM with selectable Fields (1–8), Lines (up to 2000), Frame Rates (25, 30, 50, or 60 Hz), Interlacing (1:1, 2:1, 4:1, 8:1), or Synch Pulse Slope (Positive or Negative).
Window	Trigger when signal or exits a window defined by adjustable thresholds.

## SMART Triggers

State or Edge Qualified	Triggers on any input source only if a defined state or edge occurred on another input source. Delay between sources is selectable by time or events.
Qualified First	In Sequence acquisition mode, triggers repeatably on event B only if a defined pattern, state, or edge (event A) is satisfied in the first segment of the acquisition. Delay between sources is selectable by time or events.
Dropout	Triggers if signal drops out for longer than selected time between 1 ns and 20 s.
Pattern	Logic combination (AND, NAND, OR, NOR) of 5 inputs (4 channels and external trigger input). Each source can be high, low, or don't care. The High and Low level can be selected independently. Triggers at start or end of the pattern.

## SMART Triggers with Exclusion Technology

Glitch	Triggers on positive or negative glitches with widths selectable as low as 200 ps (depending on oscilloscope bandwidth) to 20 s, or on intermittent faults.
Width (Signal or Pattern)	Triggers on positive, negative or both widths with widths selectable as low as 200 ps (depending on oscilloscope bandwidth) to 20 s, or on intermittent faults.
Interval (Signal or Pattern)	Triggers on intervals selectable between 1 ns and 20 s.
Timeout (State/Edge Qualified)	Triggers on any source if a given state (or transition edge) has occurred on another source. Delay between sources is 1 ns to 20 s, or 1 to 99,999,999 events.
Runt	Trigger on positive or negative runts defined by two voltage limits and two time limits. Select between 1 ns and 20 ns.
Slew Rate	Trigger on edge rates. Select limits for dV, dt, and slope. Select edge limits between 1 ns and 20 ns.
Exclusion Triggering	Trigger on intermittent faults by specifying the expected behavior and triggering when that condition is not met.

# SPECIFICATIONS

## High-speed Serial Protocol Triggering

	WavePro 715Zi	WavePro 725Zi (SDA)	WavePro 735Zi (SDA, DDA)	WavePro 740Zi (SDA)	WavePro 760Zi (SDA, DDA)
Data Rates	Not available	(Option WPZi-MSPT, standard with SDA) 50 Mb/s–1.25 Gb/s		(Option WPZi-HSPT, standard with SDA) 50 Mb/s–2.7 Gb/s	
Pattern Length	–	80 bits, NRZ or 8b10b			
Clock and Data Outputs	–	400 mV <sub>p-p</sub> (Typical), AC coupled			
Clock Recovery Jitter	–	1 ps rms + 0.3% Unit Interval rms for PRBS data patterns with 50% transition density			
Hardware Clock Recovery Loop BW	–	PLL Loop BW = Fbaud/5500, 50 Mb/s to 1.25 Gb/s (Typical)			

## Low-speed Serial Protocol Triggering (Optional)

Available	I <sup>2</sup> C, SPI (SPI, SSPI, SIOP), UART-RS232, CAN, LIN, FlexRay Reference individual datasheets for complete specifications.
-----------	--

## Color Waveform Display

Type	Color 15.3" flat panel TFT-Active Matrix LCD with high resolution touch screen
Resolution	WXGA; 1280 x 768 pixels
Number of Traces	Display a maximum of 8 traces. Simultaneously display channel, zoom, memory and math traces.
Grid Styles	Auto, Single, Dual, Quad, Octal, X-Y, Single+X-Y, Dual+X-Y
Waveform Representation	Sample dots joined, or sample dots only

## Integrated Second Display

Type	Color 15.3" flat panel TFT-Active Matrix LCD with high resolution touch screen
Resolution	WXGA; 1280 x 768 pixels

## LeCroy WaveStream Fast Viewing Mode

Intensity	256 Intensity Levels, 1–100% adjustable via front panel control
Number of Channels	Up to 4 simultaneously
Type	Select analog or color graded
Max. Sampling Rate	40 GS/s (20 GS/s for WavePro 715Zi without WPZi-1.5GHZ-4X20GS option)
Persistence Aging	Select from 500 ms to Infinite
Waveforms/Second (continuous)	Up to 2500 Waveforms/second

## Analog Persistence Display

Analog and Color-Graded Persistence	Variable saturation levels; stores each trace's persistence data in memory
Persistence Types	Select analog, color, or three-dimensional
Trace Selection	Activate persistence on all or any combination of traces
Persistence Aging	Select from 500 ms to infinity
Sweep Display Modes	All accumulated, or all accumulated with last trace highlighted

## High-speed Digitizer Output (Option)

Type	LeCroy LSIB
Transfer Rate	Up to 250 Mpts/s (Maximum)
Output Protocol	PCI Express, Gen1 (4 lanes utilized for data transfer)
Control Protocol	TCP/IP
Command Set	Via Windows Automation, or via LeCroy Remote Command Set

## Zoom Expansion Traces

Display up to 4 Zoom and 8 Math/Zoom traces

## Processor/CPU

Type	Intel® Core™ 2 Quad, 2.5 GHz (or better)
Processor Memory	2 GB standard, up to 8 GB optional (4 GB standard with "S-32" memory, 8 GB standard with "M-64" or "L-128" memory)
Operating System	Microsoft Windows® Vista® Business Edition (64-bit) with SP1
Real Time Clock	Date and time displayed with waveform and in hardcopy files. SNTP support to synchronize to precision internal clocks.

## Internal Waveform Memory

4 active waveform memory traces (M1–M4) store 16-bit/point full length waveforms.  
Waveforms can be stored to any number of files limited only by the data storage media capacity.

## Setup Storage

Front Panel and Instrument Status	Store to the internal hard drive or to a USB-connected peripheral device.
-----------------------------------	---

# SPECIFICATIONS

Interface	WavePro 715Zi	WavePro 725Zi (SDA)	WavePro 735Zi (SDA, DDA)	WavePro 740Zi (SDA)	WavePro 760Zi (SDA, DDA)
Remote Control	Via Windows Automation, or via LeCroy Remote Command Set				
Network Communication Standard	LXI Class C, VXI-11 and VICP				
GPIB Port (Optional)	Supports IEEE – 488.2				
LSIB Port (Optional)	Supports PCI Express Gen1 x4 protocol with LeCroy supplied API				
Ethernet Port	Supports 10/100/1000BaseT Ethernet interface (RJ45 port)				
USB Ports	Minimum 6 total (Including 3 front panel) USB 2.0 ports support Windows compatible devices				
External Monitor Port	15-pin D-Type WXGA compatible to support customer-supplied external monitor. DVI and power connector to support LeCroy WPZi-EXTDISP-15 additional touch screen display accessory. Includes support for extended desktop operation with optional LeCroy or other second monitor.				
Peripheral Bus	LeCroy LBUS standard				
<b>Auxiliary Input</b>					
Signal Types	Select External Trigger or External Clock Input on the front panel				
Coupling	50 $\Omega$ : DC; 1 M $\Omega$ : AC, DC, GND				
Max. Input Voltage	50 $\Omega$ : 5 V <sub>rms</sub> ; 1 M $\Omega$ : 250 V (Peak AC < 10 kHz + DC)				
<b>Auxiliary Output</b>					
Signal Types	Select from calibrator, control signals or Off				
Calibrator Signal	500 Hz–5 MHz square wave or DC level; 0.0 to 500 mV into 50 $\Omega$ (0–1 V into 1 M $\Omega$ )				
Control Signals	Trigger enabled, trigger out, pass/fail status				
<b>Automatic Setup</b>					
Auto Setup	Automatically sets timebase, trigger, and sensitivity to display a wide range of repetitive signals				
Find Vertical Scale	Automatically sets the vertical sensitivity and offset for the selected channel to display a waveform with the maximum dynamic range				
<b>General</b>					
Auto Calibration	Ensures specified DC and timing accuracy is maintained for 1 year minimum.				
<b>Probes</b>					
Probes	Qty. (4) $\pm$ 10 Passive Probes				
Probe System	ProBus (and ProLink on 4 and 6 GHz models). Automatically detects and supports a variety of compatible probes				
Scale Factors	Automatically or manually selected depending on probe used				
Calibration Output	1 kHz square wave, 1 V <sub>p-p</sub> (typical), output to probe hook				
<b>Power Requirements</b>					
Voltage	100–240 VAC $\pm$ 10% at 50/60 Hz; 100–120 VAC $\pm$ 10% at 400 Hz; Automatic AC Voltage Selection				
Max. Power Consumption	800 W/ 800 VA				
<b>Environmental</b>					
Temperature (Operating)	+5 °C to +40 °C including CD-RW/DVD-ROM drive				
Temperature (Non-Operating)	–20 °C to +60 °C				
Humidity (Operating)	5% to 80% relative humidity (non-condensing) up to +31 °C. Upper limit derates to 50% relative humidity (Non-condensing) at +40 °C.				
Humidity (Non-Operating)	5% to 95% relative humidity (non-condensing) as tested per MIL-PRF-28800F				
Altitude (Operating)	Up to 10,000 ft. (3048 m) at or below +25 °C				
Altitude (Non-Operating)	Up to 40,000 ft. (12,192 m)				
Random Vibration (Operating)	0.5 g <sub>rms</sub> 5 Hz to 500 Hz, 15 minutes in each of three orthogonal axes				
Random Vibration (Non-Operating)	2.4 g <sub>rms</sub> 5 Hz to 500 Hz, 15 minutes in each of three orthogonal axes as tested per MIL-PRF-28800F				
Functional Shock	20 g peak, half sine, 11 ms pulse, 3 shocks (positive and negative) in each of three orthogonal axes, 18 shocks total as tested per MIL-PRF-28800F				
<b>Physical Dimensions</b>					
Dimensions (HWD)	355 mm x 467 mm x 289 mm; 14" x 18.4" x 11.4" (height excludes feet)				
Weight	18.4 kg; 40 lbs.				
Shipping Weight	26.6 kg; 58 lbs.				
<b>Certifications</b>					
	CE Compliant, UL and cUL listed; conforms to EN 61326, EN 61010-1, UL 61010 2nd edition, and CSA C22.2 No. 61010-1-04				
<b>Warranty and Service</b>					
	3-year warranty; calibration recommended annually. Optional service programs include extended warranty, upgrades, and calibration services.				

# SPECIFICATIONS

## Standard

### Math Tools

Display up to 8 math function traces (F1–F8). The easy-to-use graphical interface simplifies setup of up to two operations on each function trace, and function traces can be chained together to perform math-on-math.

absolute value	invert (negate)
average (summed)	log (base e)
average (continuous)	log (base 10)
derivative	product (x)
deskew (resample)	ratio (l)
difference (–)	reciprocal
enhanced resolution (to 11 bits vertical)	rescale (with units)
envelope	roof
exp (base e)	(sinx)/x
exp (base 10)	square
fft (power spectrum, magnitude, phase, up to 128 Mpts)	square root
floor	sum (+)
integral	zoom (identity)

- Parameter math – add, subtract, multiply, or divide two different parameters
- Narrow-band power measurements
- Auto-correlation function
- Sparse function
- Cubic and Quadratic Interpolation function

### Measure Tools

Display any 12 parameters together with statistics, including their average, high, low, and standard deviations. Histicons provide a fast, dynamic view of parameters and wave shape characteristics.

amplitude	level @ x	rms
area	maximum	std. deviation
base	mean	top
cycles	median	width
data	minimum	median
delay	narrow band phase	phase
Δ delay	narrow band power	time @ minimum (min.)
duty cycle	number of points	time @ maximum (max.)
duration	+overshoot	Δ time @ level
falltime (90–10%, 80–20%, @ level)	–overshoot	Δ time @ level from trigger
frequency	peak-to-peak	x@ max.
first	period	x@ min.
last	rissetime (10–90%, 20–80%, @ level)	

### Pass/Fail Testing

Simultaneously test multiple parameters against selectable parameter limits or pre-defined masks. Pass or fail conditions can initiate actions including document to local or networked files, e-mail the image of the failure, save waveforms, send a pulse out at the front panel auxiliary BNC output, or (with the GPIB option) send a GPIB SRQ.

## Standard

### Jitter and Timing

#### Parametric Measurements:

- period@level • width@level • duty@level • frequency@level
- TIE@level • edge@level

#### Statistical Analysis:

Jitter Trend (1000 pts) • Histograms (1000 pts)

## Software Options

### Jitter and Timing Analysis Software Package (WPZi-JTA2)

This package provides jitter timing and analysis using time, frequency, and statistical views for common timing parameters, and also includes other useful tools. JTA2 includes:

- Jitter and timing parameters, with “Track” graphs of
  - Cycle-Cycle Jitter
  - N-Cycle
  - N-Cycle with start selection
  - Frequency
  - Period
  - Half Period
  - Width
  - Time Interval Error
  - Setup
  - Hold
  - Skew
  - Duty Cycle
  - Duty Cycle Error
- Edge@lv parameter (counts edges)
- Histograms expanded with 19 histogram parameters and up to 2 billion events
- Trend (datalog) of up to 1 million events
- Track graphs of all parameters
- Persistence histogram, persistence trace (mean, range, sigma)

### Spectrum Analyzer Mode (WPZi-SPECTRUM)

This package provides a new capability to navigate waveforms in the frequency domain using spectrum analyzer type controls.

FFT capability added to include:

- power averaging • power density • real and imaginary components
- frequency domain parameters • FFT on up to 128 Mpts.

### Disk Drive Measurements Package (WPZi-DDM2)

This package provides disk drive parameter measurements and related mathematical functions for performing disk drive WaveShape Analysis.

- Disk Drive Parameters are as follows:

amplitude asymmetry	local time trough-peak
local base	local time under threshold
local baseline separation	narrow band phase
local maximum	narrow band power
local minimum	overwrite
local number	pulse width 50
local peak-peak	pulse width 50–
local time between events	pulse width 50+ resolution
local time between peaks	track average amplitude
local time between troughs	track average amplitude–
local time at minimum	track average amplitude+ auto-correlation s/n
local time at maximum	
local time peak-trough	non-linear transition shift
local time over threshold	

# ORDERING INFORMATION

## Product Description

## Product Code

### WavePro 7 Zi Series Oscilloscopes

1.5 GHz, 10 GS/s, 4 Ch, 10 Mpts/Ch (20 GS/s and 20 Mpts/Ch in interleaved mode) with 50 Ω and 1 MΩ Input	WavePro 715Zi
2.5 GHz, 20 GS/s, 4 Ch, 10 Mpts/Ch (40 GS/s and 20 Mpts/Ch in interleaved mode) with 50 Ω and 1 MΩ Input	WavePro 725Zi
3.5 GHz, 20 GS/s, 4 Ch, 10 Mpts/Ch (40 GS/s and 20 Mpts/Ch in interleaved mode) with 50 Ω and 1 MΩ Input	WavePro 735Zi
4 GHz, 20 GS/s, 4 Ch, 10 Mpts/Ch (40 GS/s and 20 Mpts/Ch in interleaved mode) with 50 Ω and 1 MΩ Input	WavePro 740Zi
6 GHz, 20 GS/s, 4 Ch, 10 Mpts/Ch (40 GS/s and 20 Mpts/Ch in interleaved mode) with 50 Ω and 1 MΩ Input	WavePro 760Zi

### SDA Zi Series Serial Data Analyzers

2.5 GHz, 20 GS/s, 4 Ch, 20 Mpts/Ch (40 GS/s and 40 Mpts/Ch in interleaved mode) with 50 Ω and 1 MΩ Input	SDA 725Zi
3.5 GHz, 20 GS/s, 4 Ch, 20 Mpts/Ch (40 GS/s and 40 Mpts/Ch in interleaved mode) with 50 Ω and 1 MΩ Input	SDA 735Zi
4 GHz, 20 GS/s, 4 Ch, 20 Mpts/Ch (40 GS/s and 40 Mpts/Ch in interleaved mode) with 50 Ω and 1 MΩ Input	SDA 740Zi
6 GHz, 20 GS/s, 4 Ch, 20 Mpts/Ch (40 GS/s and 40 Mpts/Ch in interleaved mode) with 50 Ω and 1 MΩ Input	SDA 760Zi

### DDA 7 Zi Series Oscilloscopes

3.5 GHz, 20 GS/s, 4 Ch, 20 Mpts/Ch (40 GS/s and 20 Mpts/Ch in interleaved mode) with 50 Ω and 1 MΩ Input	DDA 735Zi
6 GHz, 20 GS/s, 4 Ch, 20 Mpts/Ch (40 GS/s and 20 Mpts/Ch in interleaved mode) with 50 Ω and 1 MΩ Input	DDA 760Zi

### Included with Standard Configuration

÷10, 500 MHz Passive Probe (Qty. 4)	
ProLink to SMA Adapter: 4 each	LPA-SMA-A
Optical 3-Button Wheel Mouse, USB 2.0	
Protective Front Cover	
Printed Quick Reference Guide	
Printed Getting Started Manual	
Product Manual Set on CD-ROM	
Norton Anti-virus Software (Trial Version)	
Microsoft Windows® Vista® License	
Commercial NIST Calibration with Performance Certificate	
Power Cable for the Destination Country	
3-year Warranty	

### Memory and Sample Rate Options

32 Mpts/Ch (64 Mpts/Ch Interleaved) Memory Option for WavePro 7 Zi. Includes an additional 2 GB of RAM (4 GB total)	WPZi-S-32
32 Mpts/Ch (64 Mpts/Ch Interleaved) Memory Option for DDA 7 Zi. Includes an additional 2 GB of RAM (4 GB total)	DDAPZi-S-32
32 Mpts/Ch (64 Mpts/Ch Interleaved) Memory Option for SDA 7 Zi. Includes an additional 2 GB of RAM (4 GB total)	SDAZi-S-32

## Product Description

## Product Code

### Memory and Sample Rate Options (cont'd)

64 Mpts/Ch (128 Mpts/Ch Interleaved) Memory Option for WavePro 7 Zi. Includes an additional 6 GB of RAM (8 GB total)	WPZi-M-64
64 Mpts/Ch (128 Mpts/Ch Interleaved) Memory Option for DDA 7 Zi. Includes an additional 6 GB of RAM (8 GB total)	DDAZi-M-64
64 Mpts/Ch (128 Mpts/Ch Interleaved) Memory Option for SDA7 Zi. Includes an additional 6 GB of RAM (8 GB total)	SDAZi-M-64
128 Mpts/Ch (256 Mpts/Ch Interleaved) Memory Option for WavePro 7 Zi. Includes an additional 6 GB of RAM (8 GB total)	WPZi-L-128
128 Mpts/Ch (256 Mpts/Ch Interleaved) Memory Option for DDA 7 Zi. Includes an additional 6 GB of RAM (8 GB total)	DDAZi-L-128
128 Mpts/Ch (256 Mpts/Ch Interleaved) Memory Option for SDA 7 Zi. Includes an additional 6 GB of RAM (8 GB total)	SDAPZi-L-128
20 GS/s (40 GS/s Interleaved) Sampling Rate Option for 1.5 GHz WavePro 715 Zi	WPZi-1.5GHZ-4X20GS

### CPU, Computer and Other Hardware Options

Upgrade from 2 GB to 8 GB CPU RAM	WPZi-2-UPG-8GBRAM
Upgrade from 4 GB to 8 GB CPU RAM	WPZi-4-UPG-8GBRAM
Upgrade from Standard Size Hard Drive to 200 GB Hard Drive	WPZi-200GB-HD
Additional 80 GB Hard Drive	WPZi-80GB-RHD-02
Additional 200 GB Hard Drive	WPZi-200GB-RHD-02
GPIO Option for LeCroy Oscilloscope	GPIO-B-2

### Serial Data Options and Accessories

2.7 Gb/s High-speed Serial Pattern Trigger Option for 4–6 GHz Oscilloscopes (Standard on SDA 7 Zi and DDA 7 Zi)	WPZi-HSPT
1.25 Gb/s Medium-speed Serial Pattern Trigger Option for 2.5–3.5 GHz Oscilloscopes (Standard on SDA 7 Zi and DDA 7 Zi)	WPZi-MSPT
Cable De-Embed (Standard on SDA7 Zi and DDA 7 Zi)	WPZi-CBL-DE-EMBED
8b10b Decode only Option (Standard on SDA 7 Zi and DDA 7 Zi)	WPZi-8B10B D
I <sup>2</sup> C Bus Trigger and Decode Option	WPZi-I2Cbus TD
SPI Bus Trigger and Decode Option	WPZi-SPIbus TD
LIN Trigger and Decode Option	WPZi-LINbus TD
UART and RS-232 Trigger and Decode Option	WPZi-UART-RS232bus TD
FlexRay Trigger and Decode Option	WPZi-FlexRayBus TD
FlexRay Bus Trigger, Decode, and Physical Layer Test Option	WPZi-FlexRayBus TDP
CANbus TDM Trigger, Decode and Measure/Graph Option	WPZi-CANbus TDM
CANbus TD Trigger and Decode Option	WPZi-CANbus TD
Ethernet Application Software	QPHY-ENET*
USB Application Software	QPHY-USB†
PCIe Gen1 Compliance and Development Software Package	QPHY-PCIe
QualiPHY Enabled SATA Software Option	QPHY-SATA
WiMedia UWB Transmitter Measurement Software Option	QPHY-UWB
Eye Doctor (Virtual Probe and Equalizer emulation) Bundle	WPZi-EYEDR
Eye Doctor Virtual Probing Element	WPZi-EYEDR-VP
Eye Doctor Equalized Receiver Emulation	WPZi-EYEDR-EQ

\*TF-ENET-B required. †TF-USB-B required.

# ORDERING INFORMATION

## Product Description

## Product Code

### High-speed Digitizer Output

High-speed PCIe Gen1 x4 Digitizer Output	LSIB-1
PCI Express X4 Host Interface Board for Desktop PC	LSIB-HOSTBOARD
PCI Express X4 Express Card Host Interface for Laptop Express Card Slot	LSIB-HOSTCARD
PCI Express X4 3-meter Cable with X4 Cable Connectors Included	LSIB-CABLE-3M
PCI Express X4 7-meter Cable with X4 Cable Connectors Included	LSIB-CABLE-7M

### Mixed Signal Testing Options

500 MHz, 2 GS/s, 18 Ch, 50 Mpts/Ch Mixed Signal Oscilloscope Option	MS-500
250 MHz, 1 GS/s, 36 Ch, 25 Mpts/Ch (500 MHz, 18 Ch, 2 GS/s, 50 Mpts/Ch Interleaved) Mixed Signal Oscilloscope Option	MS-500-36
250 MHz, 1 GS/s, 18 Ch, 10 Mpts/Ch Mixed Signal Oscilloscope Option	MS-250

### General Purpose and Application Specific Software Options

Advanced Customization Software Package	WPZI-XDEV
Spectrum Analyzer and Advanced FFT Option	WPZI-SPECTRUM
EMC Pulse Parameter Software Package	WPZI-EMC
Serial Data Mask Software Package (Standard on SDA 7 Zi and DDA 7 Zi)	WPZI-SDM
Advanced Optical Recording Measurement Package	WPZI-AORM
Demodulation Software Package	WPZI-DMOD
Jitter Timing and Analysis Software Package (Standard on SDA7 Zi and DDA 7 Zi)	WPZI-JTA2
Digital Filter Software Package	WPZI-DFFP2
Disk Drive Measurements Software Package (Standard on DDA 7 Zi)	WPZI-DDM2
Electrical Telecom Mask Test Software Package	WPZI-ET-PMT

### General Accessories

Top-mounted, Fully Integrated 15.3" WXGA with Touch Screen Display, Including all Cabling and Software	WPZI-EXTDISP-15
Keyboard, USB	KYBD-1
Probe Deskew and Calibration Test Fixture	TF-DSQ
Hard Carrying Case	WPZI-HARDCASE
Soft Carrying Case	WPZI-SOFTCASE
Rackmount Accessory for Converting a Zi Series Oscilloscope to an 8U Rack-mounted Package	RACKMOUNT-1
ProLink to SMA Adapter	LPA-SMA-A
Kit of ProLink to SMA Adapters	LPA-SMA-KIT-A
Oscilloscope Cart with Additional Shelf and Drawer	OC1024
Oscilloscope Cart	OC1021

## Product Description

## Product Code

### Probes and Probe Accessories

2.5 GHz, 0.7 pF Active Probe ( $\pm 10$ ), Small Form Factor	HFP2500
1.5 GHz, 0.9 pF, 1 M $\Omega$ High Impedance Active Probe	ZS1500
Set of 4 ZS1500, 1.5 GHz, 0.9 pF, 1 M $\Omega$ High Impedance Active Probe	ZS1500-QUADPAK
WaveLink 7.5 GHz, Differential Probe Adjustable Tip Module	D600A-AT*
WaveLink 3.5 GHz, $\pm 2.5$ V <sub>p-p</sub> Differential Probe Small Tip Module	D310*
WaveLink 3.5 GHz, $\pm 5$ V <sub>p-p</sub> Differential Probe Small Tip Module	D320*
WaveLink 6 GHz, $\pm 2.5$ V <sub>p-p</sub> Differential Probe Small Tip Module	D610*
WaveLink 6 GHz, $\pm 5$ V <sub>p-p</sub> Differential Probe Small Tip Module	D620*
WaveLink 6 GHz, Differential Positioner Mounted Tip Module	D500PT*
WaveLink ProLink Probe Body	WL-PLink
WaveLink ProBus Probe Body	WL-PBus
7.5 GHz Low Capacitance Passive Probe ( $\pm 10$ , 1 k $\Omega$ ; $\pm 20$ , 500 $\Omega$ )	PP066
1 GHz, Active Differential Probe ( $\pm 1$ , $\pm 10$ , $\pm 20$ )	AP034
Optical-to-Electrical Converter, 500–870 nm ProLink BMA Connector	OE525
Optical-to-Electrical Converter, 950–1630 nm ProLink BMA Connector	OE555
10/100/1000Base-T Compliance Test Fixture	TF-ENET-B <sup>†</sup>
Telecom Adapter Kit 100 $\Omega$ Bal., 120 $\Omega$ Bal., 75 $\Omega$ Unbal.	TF-ET
SATA Gen1/Gen2 Compliance Test Fixture	TF-SATA
USB 2.0 Testing Compliance Test Fixture	TF-USB-B

\* For a complete probe, order a W-PLink or WL-PBus Probe Body with the Probe Tip Module

<sup>†</sup> Includes ENET-2CAB-SMA018 and ENET-2ADA-BNCSMA

A variety of other active voltage and current probes are also available. Consult LeCroy for more information.

### Customer Service

LeCroy oscilloscopes and probes are designed, built, and tested to ensure high reliability. In the unlikely event you experience difficulties, our digital oscilloscopes are fully warranted for three years and our probes are warranted for one year.

This warranty includes:

- No charge for return shipping
- Long-term 7-year support
- Upgrade to latest software at no charge



1-800-5-LeCroy  
www.lecroy.com

Local sales offices are located throughout the world.  
To find the most convenient one visit [www.lecroy.com](http://www.lecroy.com)