

Scienlab Charging Discovery System

EV & EVSE Test

SL1040A-ST2



Table of Contents

Solution Overview.....	3
Operation modes.....	4
Modularity of the Scienlab Charging Discovery System – Portable Series.....	5
Configuration examples.....	6
SL1040A-ST2 Scienlab Charging Discovery System – Portable Series.....	7
Real-time computer in 19" plug-in unit.....	7
High-voltage module.....	10
Communication modules.....	12
SL1049A EV Charging Adapter Option Class.....	15
SL1049A EVSE Plug-In Option Class.....	17
Advanced Hardware Options.....	18
SL1040A-IRE Scienlab Insulation Resistance Emulator.....	20
SL1040A-TC1 Transport case.....	21
Specifications.....	22
Operating ratings.....	22
High-voltage.....	22
Communication signals.....	23
Supplemental Characteristics.....	23
Communication signals.....	23
Licenses.....	25
SL1040A-S01 Expert mode.....	27
SL1040A-S02 Developer mode.....	28
Project Management, Consulting and Installation Services.....	30
PS-XPM-100-SL Project management services.....	30
PS-XINS-100-SL Project installation services.....	30
PS-XENG-100-SL Project engineering services.....	30
PS-XCOM-100-SL Project commissioning services.....	30
Startup assistance training.....	31
KeysightCare Solutions.....	32
Service deliverables.....	32
Extend the Capabilities of your Test Solution.....	34

Solution Overview

The Scienlab Charging Discovery System (CDS) from Keysight is a modular solution for conformance and interoperability testing of electric vehicles (EV) and EV supply equipment (EVSE) charging interfaces. Thanks to its modular design, the CDS can be configured to customers' specific needs for testing and validating the charging interface of electric vehicles and charging infrastructures.

The photos show the 19" Scienlab Charging Discovery System Portable Series. For further CDS variants (e.g. EMC shielding or high-power options) refer to other [data sheets](#).



19" Scienlab Charging Discovery System – Portable Series

Three main use cases for the Scienlab Charging Discovery System – Portable Series:

Use case 1: EV test	
<p>The CDS is used as an universal, configurable charging infrastructure (e.g. DC charging column or AC wallbox).</p> <p>It can be used for functional testing of the charging interface of any EV, as well as for safety, interoperability, conformance, and durability tests.</p>	
Use case 2: EVSE test	
<p>Here, the CDS is an universal, configurable charging interface emulation of an EV.</p> <p>Again, this allows functional, safety, interoperability, conformance and durability testing of any EVSE product.</p>	
Use case 3: Man-in-the-middle test	
<p>In this third use case, the CDS is connected between two real devices to capture all electrical signals and digital communication between an EVSE and EV.</p> <p>The user can identify and trace potential interoperability issues.</p>	

Operation modes

Emulation mode

In emulation mode, the CDS reproduces the behavior of the charging processes as described in the standards. However, there are a few locations where the CDS is more tolerant than the standards. The electrical behavior is modeled with some simple charging models.

Tolerances	
Common tolerances	Timeouts: The CDS warns about a timeout violation but proceeds with the charging process.
IEC 61851-1/SAE J1772/ GB/T 18487-2015	<ul style="list-style-type: none">• Increased tolerance values for control pilot (CP) voltage• Increased tolerance values for proximity pilot (PP) / connection confirmation (CC) resistance• Violations of power/current level are ignored with respect to the pulse width modulation (PWM) duty cycles (only switch-off limits in device of emulation (DoE) profile and system limits are checked)
DIN SPEC 70121/ ISO 15118	<ul style="list-style-type: none">• CP and PP/CC tolerances are the same as described above.• Signal Level Attenuation Characterization (SLAC) is not interrupted by CDS in case of invalid parameters, but warnings are displayed.
CHAdemo	Warns about ground errors but proceeds with charging process.
GB/T 27930-2011/2015	<ul style="list-style-type: none">• Connection detection on CC1 and CC2 within the range of ± 1 V in reference to the nominal value.• Auxiliary voltage (A+/A-) will be accepted if measurement value is above 11 V.

Test case mode

For test cases, the CDS behaves more tolerant, so that:

- Errors can be detected by a test case.
- Errors which are not relevant for the test case are ignored.

The charging models are not active in test case mode to enable the possibility to set voltage/current manually and programming custom charging models.

Tolerances	
DIN SPEC 70121 / ISO 15118	<ul style="list-style-type: none">• Control Pilot errors (PWM frequency, duty cycles) are ignored.• CDS only warns about message sequence errors, but keeps the communication running.• SLAC: Unlimited retries of sending messages if no answer is received.• SECC Discovery Protocol (SDP): Unlimited retries of sending SDP request message.• V2G:<ul style="list-style-type: none">○ EV-Test: CDS only warns about incompatible charge parameters.○ EVSE-Test: In case of communicated EVSE failure the charging process will not be interrupted.

CHAdeMO	No difference with respect to emulation mode.
GB/T 27930-2011/2015	<ul style="list-style-type: none"> • Unmatched protocol version does not interrupt charging process. • Specimen error messages are not interrupting charging process.

No-HV mode

The No-HV mode is implicitly activated if no power source/sink is selected in Charging Discover on emulation side. To make charging possible, some high-level protocol messages and set point parameters are filled with theoretically calculated measurement data.

Modularity of the Scienlab Charging Discovery System – Portable Series

Figure 1 shows the modularity of the Scienlab Charging Discovery System. This data sheet describes components in the red boxes. The components in the dark gray boxes are described in separate data sheets and clarify the extensibility of the test system.

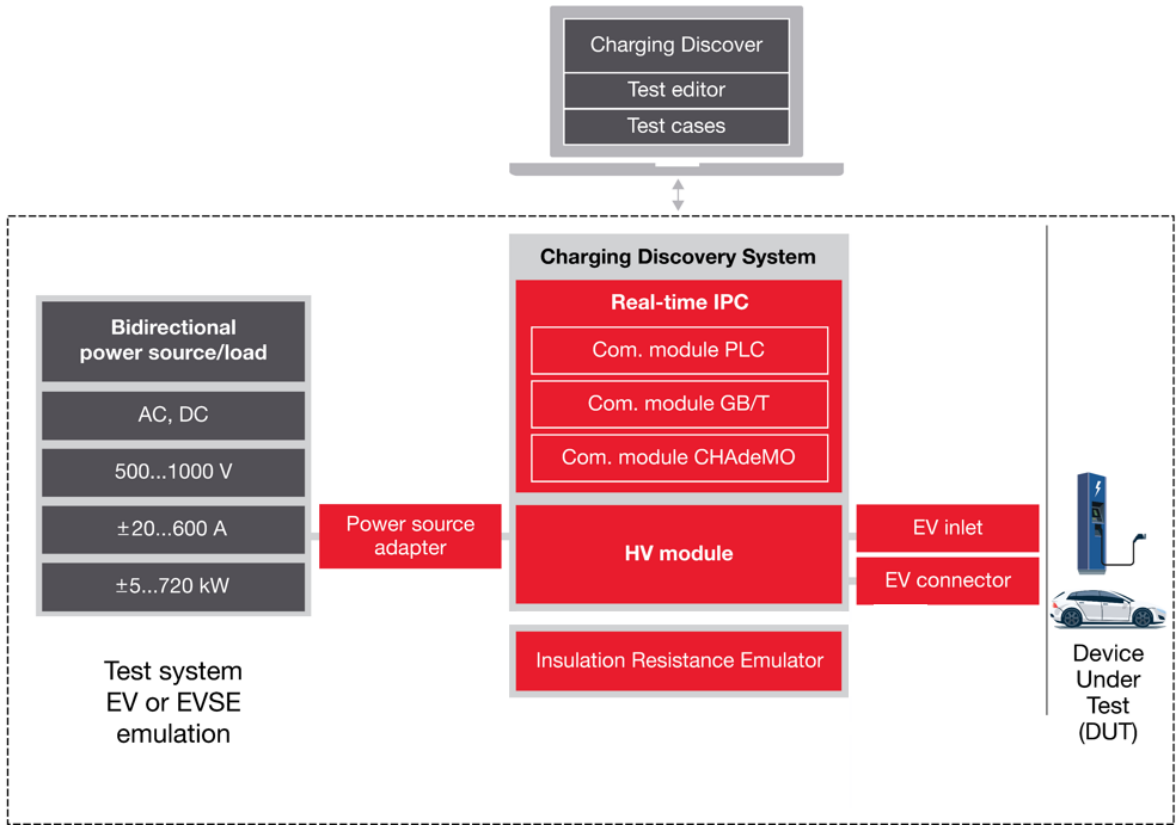

Figure 1. Modularity of the Scienlab Charging Discovery System – Portable Series.

Configuration examples

Consider the targeted use case and test scope when ordering CDS hardware. For some applications, such as conformance testing of the charging communication protocols, the CDS alone may suffice. This is suitable when testing individual components of a charging system (e.g. Supply Equipment Communication Controller (SECC) or EVCC) rather than the entire product. Full conformance tests require a power source (or load) in addition to the CDS.

The following table shows three examples of CDS configurations:

Example 1: Stand-alone CDS	
<p>In some cases, a stand-alone CDS configuration is adequate. It allows AC man-in-the-middle analysis, as well as AC charging tests of an EV when used together with the CEE plug-in adapter (see SL1040A-107).</p> <p>Adding high level communication modules (SL1040A-301, -302 and -303) allows DC man-in-the-middle analysis and V2G/CAN communication protocol testing.</p>	
Example 2: CDS and low-power DC supply	
<p>Adding a DC power source or load, even with low power, enables most DC conformance and interoperability testing.</p> <p>Keysight RP79xx ¹ Regenerative Power System (RPS) provides a scalable solution (5 to 150 kW) which is seamlessly integrated with CDS. It can be used as source or load, thus allowing EV and EVSE testing with one setup.</p>	
Example 3: CDS and high-power DC supply	
<p>For high-power DC charging, the CDS can be attached to larger DC emulators of 180 kW, 360 kW or more. EV and EVSE testing at full power range becomes possible.</p> <p>Note: For high-power charging EV testing a High-Power CDS with liquid-cooled adapters may be required.</p>	

¹ For subsequent orders of Keysight RP79xx, note that any RPS module must be commissioned by a CDS service engineer before first use. Contact your local Keysight field engineer for all service options.

SL1040A-ST2 Scienlab Charging Discovery System – Portable Series



SL1040A-ST2 Scienlab Charging Discovery System – Portable Series

Real-time computer in 19" plug-in unit



CDS real-time computer; 19" plug-in unit

General functions

- Real-time computing control unit with high system performance and low dead times.
- Standard-compliant emulation of the EV or EVSE charging communication controller; programmable using documented interfaces.
- Built-in control of up to two charging sockets with locking actuator and temperature monitoring.
- Fault injection at the control and proximity pilot (idle and short circuit).
- Man-in-the-middle mode for analyzing the charging communication interface between EV and EVSE.
- Included drivers allow easy integration of Scienlab power sources and sinks.
- Included Scienlab Charging Discover software for Windows operating system (find out more [below](#)).

System characteristics	
Dimension	2 U (rack units) in a 19-inch open frame rack
Weight	6 kg
Protection class	IP00
Recommended re-calibration period	12 months

Interfaces	
Measuring taps	
Control pilot EV	Bayonet Neill–Concelman (BNC) socket
Control pilot EVSE	BNC socket
Digital interfaces	
External data media	USB
Status LEDs	
System status	3 LEDs (monochrome)
EV	Status of EVCC (RGB) and Power Line Communication (PLC) modem
EVSE	Status of SECC (RGB) and PLC modem

Standards and directives

The CDS supports the following charging communication standards.

The basic function includes:

- AC charging mode according to IEC 61851-1 (PWM)
- AC charging mode according to SAE J1772 (PWM)
- AC charging mode according to GB/T 18487.1 (PWM)

The following are also available as additional options (see following items):

- DC fast charging mode according to DIN SPEC 70121
- DC fast charging mode according to ISO 15118
- AC charging mode according to ISO 15118
- DC fast charging mode according to GB/T 27930
- DC fast charging mode according to CHAdeMO

PWM functionality

- Measurement of the PWM level on the EVSE and EV sides
- Emulation of the EVSE signal generator with adjustable positive or negative amplitude, frequency, and duty cycle
- Testing of the PWM signal with respect to level, edge steepness, frequency, and duty cycle

- Variation of the control pilot's (CP) line impedance with switchable parallel resistors and capacitors
- Emulation of the vehicle side with freely programmable resistance emulation at the CP
- Fault injection: control pilot line break, short circuit to protective earth (PE)

GB/T and CHAdeMO signals

- CAN high and CAN low signals
- GB/T communication signals (CC1 and CC2, A+, A-)
- CHAdeMO communication signals
- All signals provided by 2 DSUB 15 mating plug divided in EV and EVSE side

Proximity pilot (PP)

- Measurement and interpretation of the resistance of the PP for coding the current rating of the charging cable
- Emulation of the PP resistance (during EVSE emulation)
- Fault injection: Line break, short circuit to PE

System architecture

The CDS consists of several internal electronic functional groups to meet EV and EVSE requirements. The following block diagram shows the system architecture:

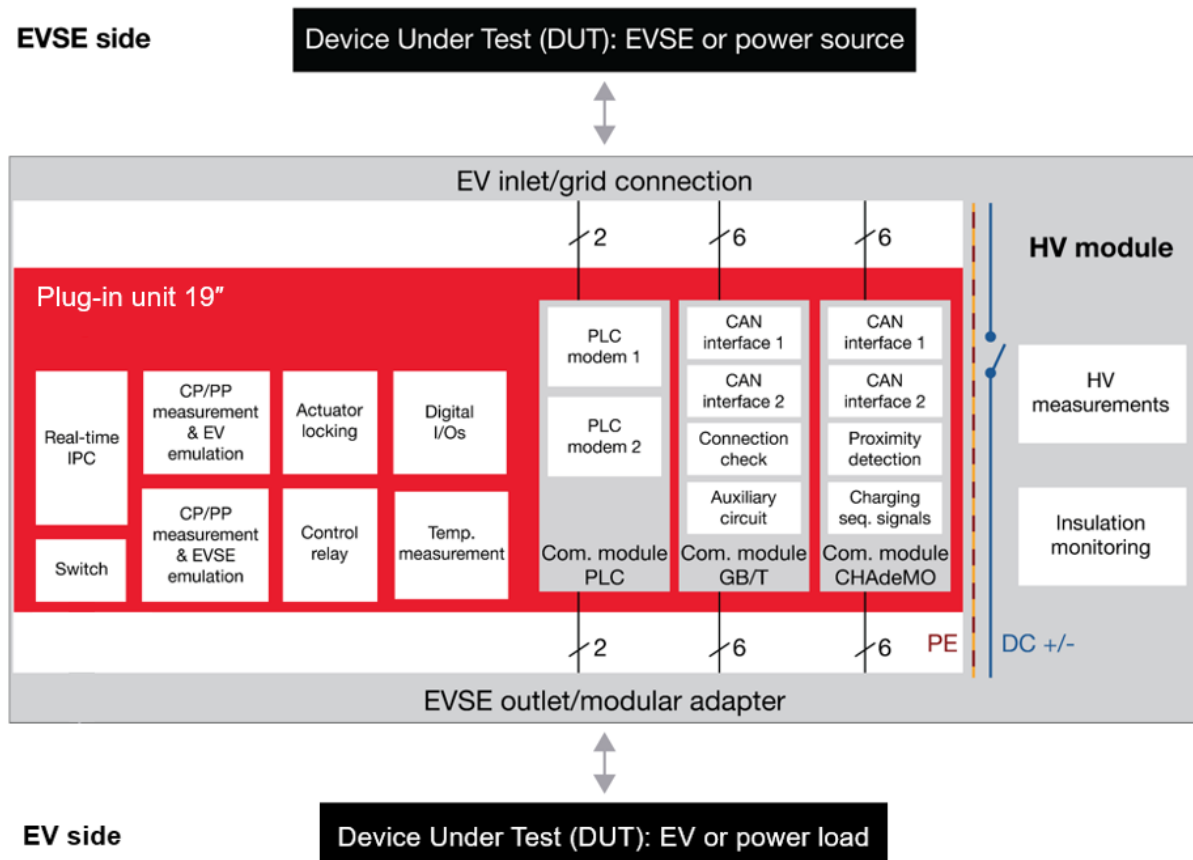

Figure 2. Block diagram of CDS architecture.

Note: Only red function blocks are included in this item.

High-voltage module

The high-voltage (HV) module connects the control unit and the communication modules to the DUT, i.e. vehicle and/or charging infrastructure. Several variants are available to fulfill different worldwide standards. In addition to country and standard-dependent DUT contacting, the HV module includes a 19" housing, current transducers, safety components, and power contactors for AC and DC.



HV module of the CDS

Included in the scope of delivery:

- 19" compact aluminum housing
- Power supply to the 24 V supply of the device via 100-230 V AC. 50/60 Hz mains
- Integration of an insulation monitoring device (Bender ISOMETER®)
- Integration of a safety relay for interlock control (Pilz PNOZ X)
- DSUB15 mating plug for stand-alone operation
- Operating instructions, CE declaration of conformity, CSA declaration of conformity (CSA C22.2 No. 61010-1-12 and 61010-2-030-12)

Note: If the HV module is ordered without a plug-in adapter (see further items within this document), the EVSE/source port at the left side of the front panel will be covered by a blank front plate.

System description	
Dimensions (H x W x D)	330 x 520 x 600 mm
Weight	36 kg (without plug-in unit)
Protection class	IP40 (with connected plugs)
Recommended re-calibration period	12 months

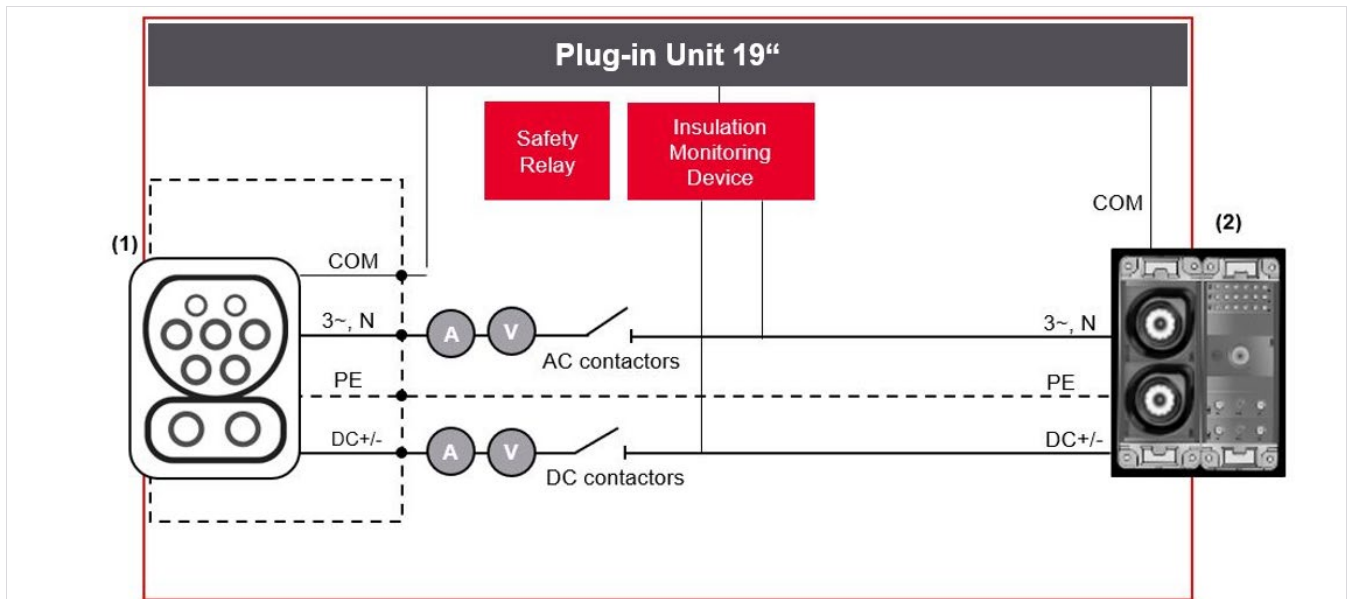

Interfaces	
Operating buttons	Fast stop (safety shutdown)
(1) Connection EVSE/external source	Via plug-in adapter
(2) Connection EV/external load	Via EV charging adapter/adapter cable
AC connection	400 V _{L-L} rms/32 A rms (per phase)
DC connection	1000 V DC (according to IEC and UL) 350 A DC (continuous) 400 A DC (approx. 90 min) ¹
HV measuring	Non-touchable banana plug
Self-supply	24 V DC (connection via terminal) Note: Desktop power supply unit not included.
Interface to operating PC	1,000 MBit/s Ethernet
Remote interface (e.g. HiL) ²	1,000 MBit/s Ethernet
Power source/sink	1,000 MBit/s Ethernet

¹ After the short-term use of 400 A DC, the system needs 30 minutes to cool down.

² Support and remote interface license are optional available.

Note: The voltage and current carrying capacity rating may be limited by the attached EV connector or inlet. Higher currents (up to 600 A) can be realized with the SL1047A Scienlab Charging Discovery System – High-Power Series (CDS HP Series), which supports liquid-cooled charging adapters.

Find out more about the [CDS HP Series](#).

This item can only be ordered in combination with “SL1040A-ST2 Charging Discovery System (real-time computer in 19” plug-in unit)”. The real-time computer is not included. DC charging according to the relevant standard is only possible with the associated communication modules (see

Communication modules

SL1040A-301 Communication module PLC

Adding two additional PLC modules to the Charging Discovery System supports the following additional functions:

- Emulation of the electrical interface on the EV and EVSE side
- EV emulation according to the standards DIN SPEC 70121 (2014) and ISO 15118 Ed. 1 (EIM only ¹)
- EVSE emulation according to the standards DIN SPEC 70121 (2014) and ISO 15118 Ed. 1 (EIM only ¹)
- Man-in-the-middle measurement between EVSE and EV with low latency (< 1 ms)
- Recording of all EV or EVSE V2G messages and display of the information contained therein in plain text
- Recording and visualization of QCA attenuation statistic when charging with PLC communication
- Access to the most important PWM, V2G and SLAC parameters from Test-Editor for creation of sophisticated test cases. For example, inserting fault conditions by manipulating the application data (e.g. “EVTargetVoltage”) and delay single response/request messages.

¹ Plug and Charge (PnC) will be available with future software update (included in SW maintenance contract).

Pin	Designation	Function	Charging interface
CP	Control Pilot	PWM control line plus digital communication via PLC	
PP	Proximity Pilot	EV testing of the charging cable connection	

Note: This option does not include electromechanical contacting (connector/inlet). See the following EV charging and EVSE plug-in module adapter options for further details.

SL1040A-302 Communication module GB/T

Adding two communication modules to the Charging Discovery System support the following additional functions:

- Emulation of the electrical interface of EV and EVSE
- EV emulation according to GB/T 27930-2011 and 2015 (DC)
- EVSE emulation according to GB/T 27930-2011 and 2015 (DC)
- Man-in-the-middle measurement between EVSE and EV with low latency
- Recording of all EV or EVSE CAN messages and display of the information contained therein in plain text
- Access to the most important CAN parameters from test editor for creation of sophisticated test cases, for example by inserting fault conditions by manipulating the application data (e.g. "Voltage demand") and/or delay single response/request messages.

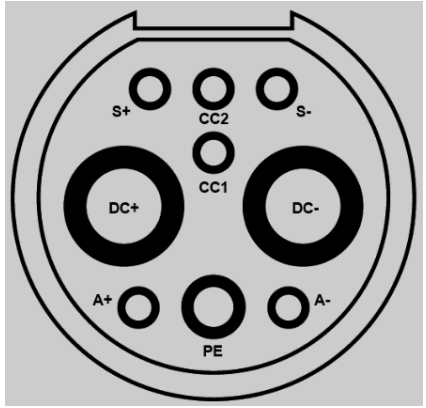
Pin	Designation	Function	Charging interface
S+	CAN-High	CAN Bus: High level communication	
S-	CAN-Low		
CC1	Connection confirmation 1	EV testing of the charging cable connection	
CC2	Connection confirmation 2	EVSE testing of the charging cable connection	
A+	Auxiliary Circuit +	EVSE voltage supply for EVCC	
A-	Auxiliary Circuit-	EVSE voltage supply for EVCC	

Note: This option does not include electromechanical contacting (connector/inlet). See following EV charging and EVSE plug-in module adapter options for further details.

SL1040A-303 Communication module CHAdeMO





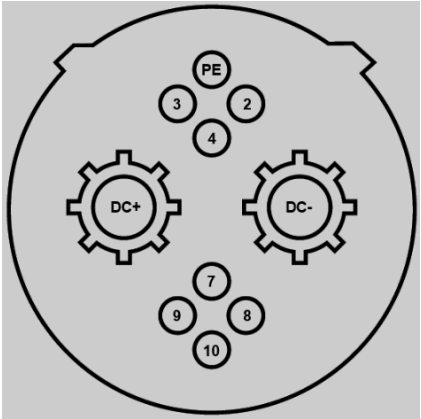

Adding two communication modules to the Charging Discovery System support the following additional functions:

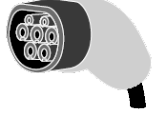

- Emulation of the electrical interface on the EV and EVSE side
- EV emulation according to the CHAdeMO specification
- EVSE emulation according to the CHAdeMO specification
- Man-in-the-middle measurement between EVSE and EV with low latency
- Recording of all EV or EVSE CAN messages and display of the information contained therein in plain text
- Access to the most important CAN parameters from Test Editor for creation of sophisticated test cases, for example by inserting fault conditions by manipulating the application data (e.g. “Charging current request”) and/or delay single response/request messages.
- Supported CHAdeMO protocols: 0.9; 0.9.1; 1.0.0; 1.0.1; 1.1; 1.2; 2.0

Pin	Designation	Function	Charging interface
8	CAN-High	CAN Bus: High level communication	
9	CAN-Low		
7	Connector proximity detection	EV testing of the charging cable connection	
4	Vehicle charge permission	EV opening for charging process	
2	Charging sequence signal 1	EVSE “start” charging	
10	Charging sequence signal 2	EVSE releasing the charging process	

Note: This option does not include electromechanical contacting (connector/inlet). See following EV charging and EVSE plug-in module adapter options for further details.

SL1049A EV Charging Adapter Option Class

EV charging adapter option class	Adapter	Rated voltage	Rated current	Cable cross-section	Approx. Weight	Standard
Adapter for AC charging						
EV charging adapter Type 1 connector AC [SL1049A-201]		250 V _{L-L}	32 A	2x 10 AWG (6 mm ²) L1, N PE: 1x 10 AWG (6 mm ²) 2x 21 AWG (0.5 mm ²) CP, PP	3 kg	IEC 62196-2/ SAE J1772
EV charging adapter Type 2 connector AC [SL1049A-202]		480 V _{L-L}	32 A	4x 6 mm ² L1, L2, L3, N PE : 1x 6 mm ² 2x 0.5 mm ² CP, PP		IEC 62196-2
EV charging adapter GB/T connector AC [SL1049A-205]		440 V _{L-L}	32 A	4x 6 mm ² L1, L2, L3, N PE: 1x 6 mm ² 2x 0.5 mm ² CP, CC		GB/T 20234.2
Adapter for DC charging						
EV charging adapter Type 1 CCS DC [SL1049A-203]		1000 V	200 A	2x AWG 1 (50 mm ²) DC± PE: 1x AWG 6 (16 mm ²) 4x AWG 16 (0.75 mm ²) CP, PP, PT1000	9 kg	IEC 62196-3
EV charging adapter Type 2 CCS DC [SL1049A-204]		1000 V	200 A	2x 50 mm ² DC± PE: 1x 25 mm ² 6x 0.75 mm ² CP, PP, PT1000	11 kg	IEC 62196-3
EV charging adapter GB/T connector DC [SL1049A-206]		1000 V	250 A	2x 70 mm ² DC± PE: 1x 25 mm ² 6x 0.75 mm ² S±, CC1/2, PTC 2x 4 mm ² A±	16 kg	GB/T 20234.3
EV charging adapter CHAdeMO connector [SL1049A-207]		500 V	125 A	2x 35 mm ² DC± PE (Signal): 0.75 mm ² 6x 0.75 mm ² CAN H/L, CSS1/2, VCP, CPD	11 kg	CHAdeMO association

EV charging adapter Type 2 CCS DC [SL1049A-209]		1000 V	Up to 350 A ¹	2x (2x50 mm ²) DC± PE: 1x 50 mm ² 6x 0.75 mm ² PT1000, CP, PP	20 kg	IEC 62196-3
EV charging adapter CHAdeMO connector [SL1049A-211]		600 V	200 A	2x 67.4 mm ² DC± PE (Signal): 0.824 mm ² 6x 0.824 mm ² CAN H/L, CSS1/2, VCP, CPD	14 kg	CHAdeMO association

¹ 250 A are permanently possible (300 A permanently only at 30 degrees Celsius, up to 350 A permanently only at 20 degrees Celsius).

Note: Limited by EV plug manufacturer's certification. All charging adapters have a standard length of 5 m. Other lengths available on request.

On secondary side, all EV charging adapter are equipped with a compatible connector, as shown in the following photos:

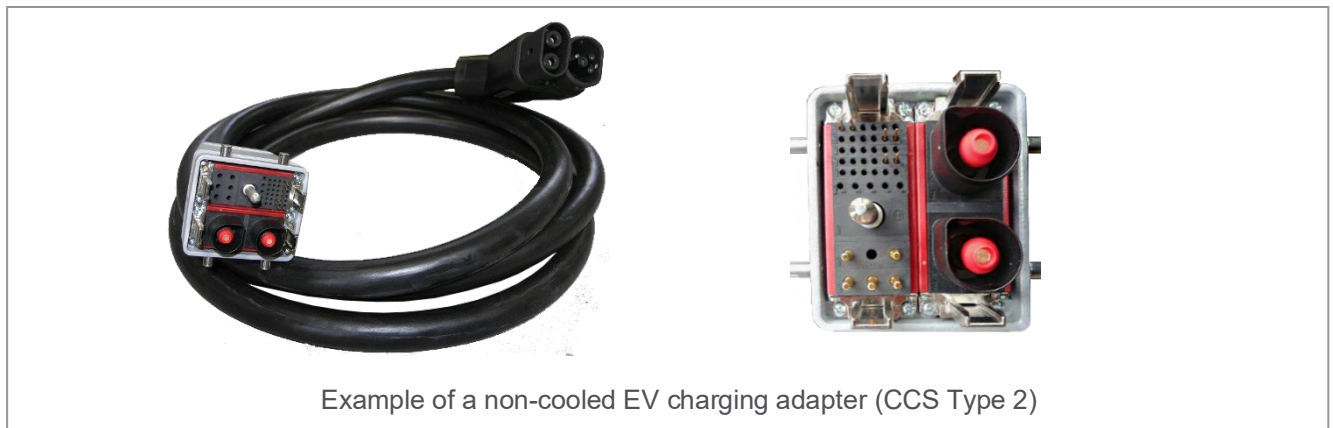

SL1049A EVSE Plug-In Option Class

EVSE plug-in option class	Plug-in adapter	Rated voltage	Rated current ¹	Inlet cross-section	Standard
EVSE plug-in CCS Type 1 [SL1049A-101]		AC: 250 V _{L-L}	AC: 32 A	2x 70 mm ² 2x 6mm ² PE: 25 mm ² 2x 0.5 mm ² CP, PP	IEC 62196-2
		DC: 1000 V ²	DC: 200 A		IEC 62196-3
EVSE plug-in CCS Type 2 [SL1049A-102]		AC: 480 V _{L-L}	AC: 32 A	2x 70 mm ² 4x 6mm ² PE: 25 mm ² 2x 0.5 mm ² CP, PP	IEC 62196-2
		DC: 1000 V ²	DC: 200 A		IEC 62196-3
EVSE plug-in GB/T AC [SL1049A-103]		440 V _{L-L}	32 A	4x 6mm ² PE: 6 mm ² 2x 0.5 mm ² CP, CC	GB/T 20234.2
EVSE plug-in GB/T DC [SL1049A-104]		1000 V	250 A	2x 70 mm ² PE: 25 mm ² 2x 2.5 mm ² A± 6x 0.5 mm ² S±, CC1/2, PTC	GB/T 20234.3
EVSE plug-in CHAdeMO [SL1049A-105]		500 V	125 A	2x 50 mm ² PE (Signal): 0.34 mm ² 6x 0.34 mm ² CAN H/L, CSS1/2, VCP, CPD	CHAdeMO association
EVSE plug-in CCS Type 1 [SL1049A-108]		AC: 250 V _{L-L}	AC: 32 A	2x 95 mm ² 2x 6mm ² PE: 25 mm ² 2x 0.5 mm ² CP, PP	IEC 62196-2
		DC: 1000 V	DC: > 250 A ³		IEC 62196-3
EVSE plug-in CCS Type 2 [SL1049A-109]		AC: 480 V _{L-L}	AC: 32 A	2x 95 mm ² 4x 6mm ² PE: 25 mm ² 2x 0.5 mm ² CP, PP	IEC 62196-2/-3
		DC: 1000 V	DC: > 250 A ³		
EVSE plug-in CHAdeMO [SL1049A-110]		1000 V	200 A	2x 70 mm ² PE (Signal): 0.5 mm ² 6x 0.5 mm ² CAN H/L, CSS1/2, VCP, CPD	CHAdeMO Association

¹ Maximum current values are limited by the available EV inlet itself. Higher ampacity will be available as soon as inlet availability improves.

CDS HV module limitation is 400 A DC, see specification in chapter 2.

² Depending on revision of manufacturers inlet 850 V.

³ Contactor can drive up to 400A. Contact Keysight field engineer for more information.

The following exemplary photo shows a plug-in adapter from the side and reverse view:





Plug-in adapter from side view (left) and reverse view (right).

Note: The weight of the plug-in adapters is between 3.3 and 4.5 kg.

Advanced Hardware Options

Plug-in adapter to connect the CDS to a power source

Plug-in adapter	Rated voltage	Rated current	Inlet cross-section	Weight
Plug-in for EVSE emulation [SL1049A-106] 	AC: 500 V _{L-L}	AC: 32 A	2x 120 mm ² 4x 6mm ² PE: 35 mm ²	5.7 kg
	DC: 1000 V	DC: 300 A		
Plug-in adapter CEE [SL1049A-107] 	AC: 400 V _{L-L}	AC: 32 A	4x 6mm ² PE: 6mm ²	3.8 kg

Note: RCD type B protection is included. For EVSE emulation a power source must be connected with the HP CDS. For this connection, an adequate adapter cable is required.

Adapter cable to connect a power source/load to the CDS (EV and EVSE emulation)

Adapter cable for EV/EVSE emulation option class	Rated voltage	Rated current	Max. wire cross-section	Cable length	Approx. weight
Adapter for EV/EVSE Emulation AC [SL1049A-215]	500 V _{L-L}	32 A	4x 6 mm ² PE: 6 mm ²	5 m	4 kg
Adapter for EV/EVSE Emulation (DC+, DC-, Communication line) [SL1049A-217]	1000 V	400 A	2x 120 mm ² PE: 35 mm ²	10 m	15 kg
Adapter for EV/EVSE Emulation for connection of RP79XX without rack ¹ [SL1049A-219]	1000 V	60 A	10 mm ² PE: 4 mm ²	5 m	5 kg
Adapter for EV/EVSE Emulation for connection of CDS to SL12XXA-STD AC [SL1049A-220]	500 V _{L-L}	32 A	4x 6 mm ² PE: 6 mm ²		4 kg
Adapter for EV/EVSE Emulation for connection of CDS to SL12XXA-SDC [SL1049A-221]	AC: 500 V _{L-L}	AC: 32 A	2x 70 mm ² 4x 6 mm ² PE: 35 mm ²		9 kg
	DC: 1000 V	DC: 180 A			
Adapter for EV/EVSE Emulation for connection of CDS to SL1203A-SDC [SL1049A-226]	AC: 500 V _{L-L}	AC: 32 A	2x 120 mm ² 4x 6 mm ² PE: 35 mm ²		11 kg
	DC: 1000 V	DC: 360 A			

¹ SL1049A-219 is only suitable for connection of a single RP79XXA unit (without rack).

Note 1: When ordering the CDS together with SL1041B, no separate adapter cable is necessary.

Note 2: For EVSE emulation a power source has to be connected to the CDS. For that a relevant plug-in-adapter (SL1049A-106) is required.

SL1040A-IRE Scienlab Insulation Resistance Emulator

For testing the insulation monitoring function of vehicle or charging station, a variable resistance between DC+ and PE and DC- and PE is connected to the Charging Discovery System (CDS). The Scienlab Insulation Resistance Emulator (IRE) can be used in this way to emulate an insulation fault systematically. The IRE may only be used in combination with the CDS and is shipped with an example test case for EVSE testing.

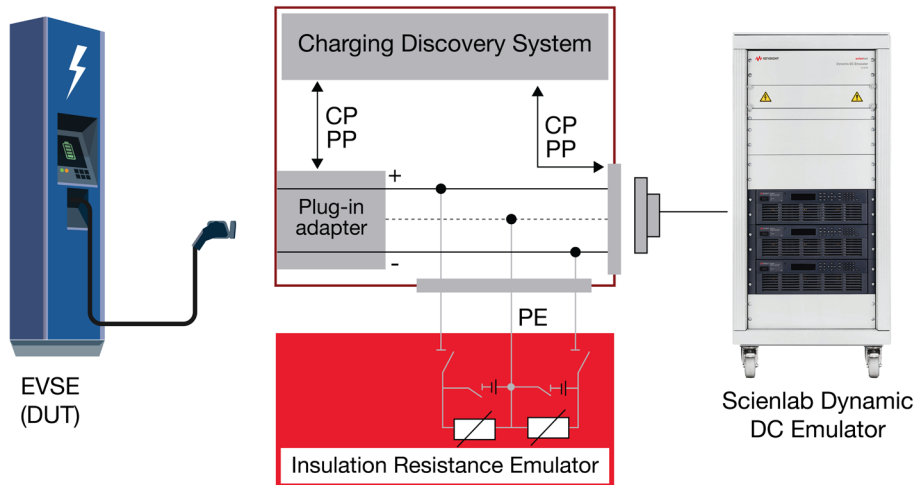

Figure 3. System topology including Scienlab Isolation Resistance Emulator.

Technical data	
Dimension (H x W x D)	220 x 520 x 600 mm
Weight	Approx. 25 kg
Protection class	IP40
Recommended re-calibration period	12 months
Adjusting range per R-cascade	500 Ω to 2 M Ω
Adjusting range Y-Capacitance	0/0.5/1.0/1.5/2.0 μ F \pm 5%
Resolution	17 bits
Max. adjustment deviation at 1 k Ω to 1 M Ω	1% of adjustment value
Electric strength	1000 V DC
Self-protection	Minimum total resistance DC+ to DC- limited by software
	32 mA fuse

SL1040A-TC1 Transport case

Case to transport a CDS or an external passive HV load. A fitted plastic foam casing guarantees a safe transport free from vibrations.

Transport case description	
Dimension (H x W x D)	Approx. 640 x 690 x 430 mm
Weight	Approx. 7 kg
Material	Aluminum
Lock	2x quick release on one side
Included accessories	ABUS three-digit combination lock

The following photos show the transport case:



Exemplary photos of the transport case

Specifications

Unless otherwise noted, specifications are warranted over the ambient temperature range of 5 to 40 °C after a 30-minute warm-up period. Specifications apply at the output terminals. Accuracy specifications are warranted for one year.

Operating ratings

Function/electric parameter		Range
AC ratings	Voltage L-N	0 to 300 V rms
	Voltage L-L	0 to 500 V rms
	Current	0 to 32 A rms (per phase)
DC ratings	Voltage	±1000 V
	Current	±350 A (continuous)
		±400 A (approx. 90 min followed by 30 min cooling)

High-voltage

Measurement values		Range	Accuracy
AC ratings	Voltage L-N	0 to 300 V rms	±0.5 V offset ±0.25% of reading
	Current	0 to 35 A rms	±0.1 A offset ±0.5% of reading
DC ratings	Voltage	±1000 V	±0.5 V offset ±0.1% of reading
			Typical: ±0.1 V offset ±0.05% of reading
	Current	±400 A	±0.5 A offset ±0.1% of reading
			Typical: 0.125 A offset ±0.1% of reading
Residual current PE	AC	±300 mA	±1 mA offset ±0.5% of reading
	DC	±300 mA	±1 mA offset ±0.5% of reading

Communication signals

Function/electric parameter	Range	Accuracy	
Control Pilot Parameter	EVSE		
	Voltage programming	0 to 15 V	±0.02 V Typical: ±0.004 V
	EV/EVSE		
	Positive voltage measurement	0 to 15 V	±0.01 V Typical: ±0.004 V
	Negative voltage measurement	-15 to 0 V	±0.01 V Typical: ±0.004 V
Proximity Pilot Parameter	Measure Resistance	50 to 3250 Ω	±0.3% of range

Note: Valid technical data from September 2021.

Supplemental Characteristics

Supplemental characteristics are not warranted but are descriptions of performance determined either by design or by type testing. All supplemental characteristics are typical unless otherwise noted.

Communication signals

Function/electric parameter	Range	Accuracy	
EVSE			
Control Pilot Parameter	Frequency programming	900 to 1100 Hz	±0.1 Hz
	Frequency measurement	900 to 1100 Hz	±0.1 Hz
	Duty Cycle programming	0 to 100%	±0.05%
	Duty Cycle measurement	0 to 100%	±0.5%
	Rise Time measurement	1 to 220 μs	< 1 μs
	Fall Time measurement	1 to 220 μs	< 1 μs
	Capacitance programming	fixed: 300 pF variable: 1600; 1800; 3100 pF	fixed: ±10% variable: ±3%
	Resistance programming	1000 Ω ± 30 Ω	±0.1%
Proximity Pilot Parameter	Resistance programming	fixed: 120; 1400; 4500; 8500 Ω variable: 0 to 1000 Ω	±1.8% of value, resolution 3.0 Ω

Function/electric parameter		Range	Accuracy
EV			
Control Pilot Parameter	Frequency measurement	900 to 1100 Hz	±0.1 Hz
	Resistance R2 programming	1 to 20000 Ω	±0.5% of value, resolution 0.5 Ω
	Resistance R3 programming	1 to 20000 Ω	±0.5% of value, resolution 0.5 Ω
	Duty Cycle measurement	0 to 100%	±0.5%
	Rise Time measurement	1 to 220 μs	< 1 μs
	Fall Time measurement	1 to 220 μs	< 1 μs
	Capacitance programming	1500; 2400; 3900 pF	±5% of value
	Voltage Diode programming	0.55; 0.7; 0.85 V	±5% of value
Proximity Pilot Parameter	Resistance programming	2160; 2430; 2700; 2970; 3240 Ω	±1% of value

Note: Valid technical data from September 2021.

Additional to the technical data, the CDS provides following functions:

Control Pilot:

- Oscillator Status programming (EVSE)
- State measurement (EV/EVSE)
- Open Circuit programming (EV/EVSE)
- Short Circuit programming (with < 1 Ω) (EV)

Proximity Pilot:

- Short Circuit programming (EV/EVSE)
- Open Circuit programming (EV/EVSE)

Licenses

Software functionality without additional license

Reading and writing test cases is a basic function of the Charging Discovery System. With the Test Editor the user can conveniently define own test cases directly within the Charging Discover graphical user interface. Test case programming is performed using functions based on common high-level language elements. Loops, test steps, and subroutines can be combined. Available system functions and parameters are automatically suggested and explained through tooltips while typing (intelligent code completion).

- Simple and intuitive programming language (proprietary, but C-like) and clear tabular representation.
- Use of chronological value tables or real charging profiles.
- Dynamic source/sink parametrization: modification of setpoint parameters while the source/sink is active.
- Independent creation of test sequences using variables for different device under test profiles.
- Use of "print commands" for documenting dynamic results in the Charging Discover trace.

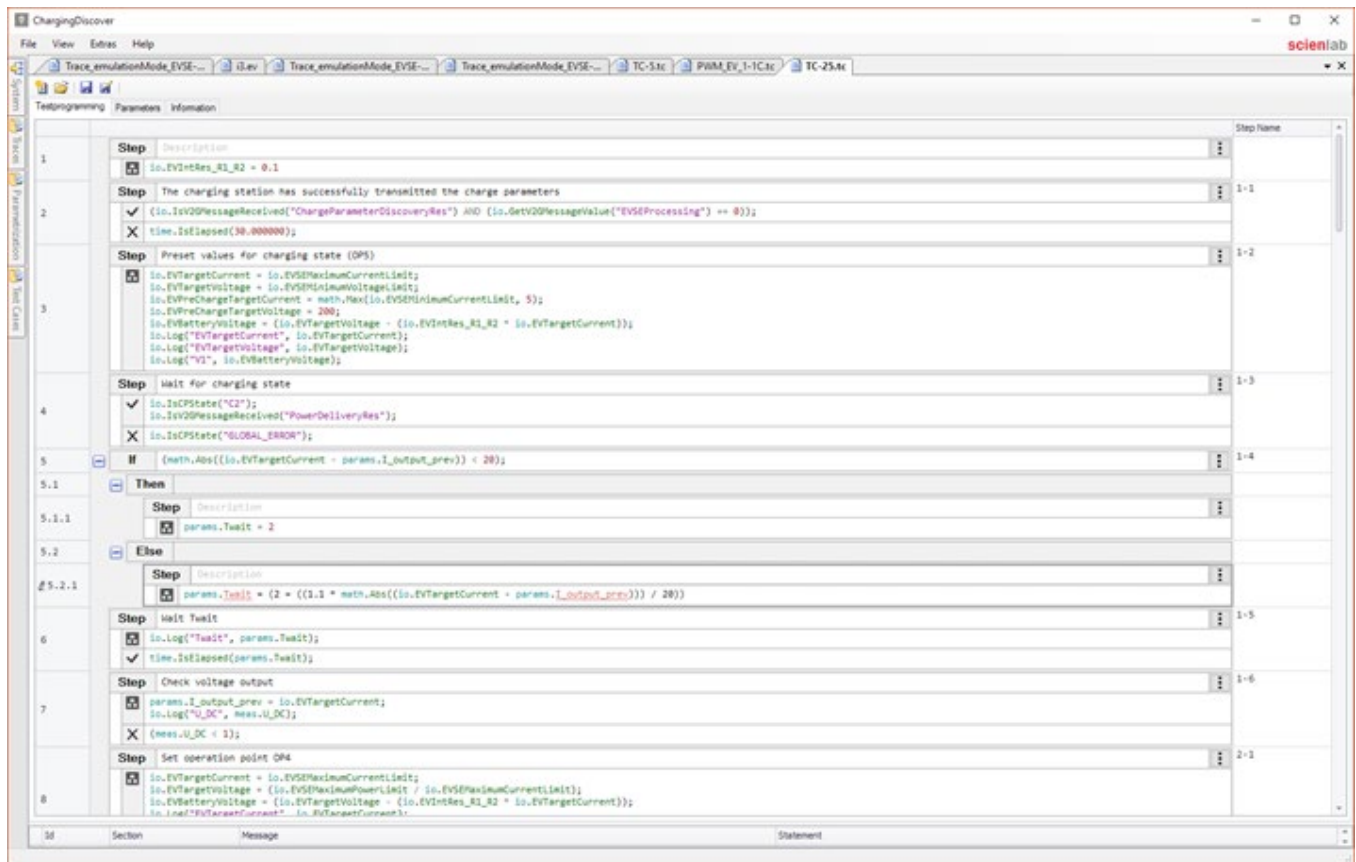

Figure 4. Test Editor screenshot.

Note: Test Editor documentation is part of the Charging Discover operating manual. If the CDS is ordered without a power source or an EVSE load, only test cases on signal level can be executed.

The following figure shows the interface topology of CDS with basic software functionality:

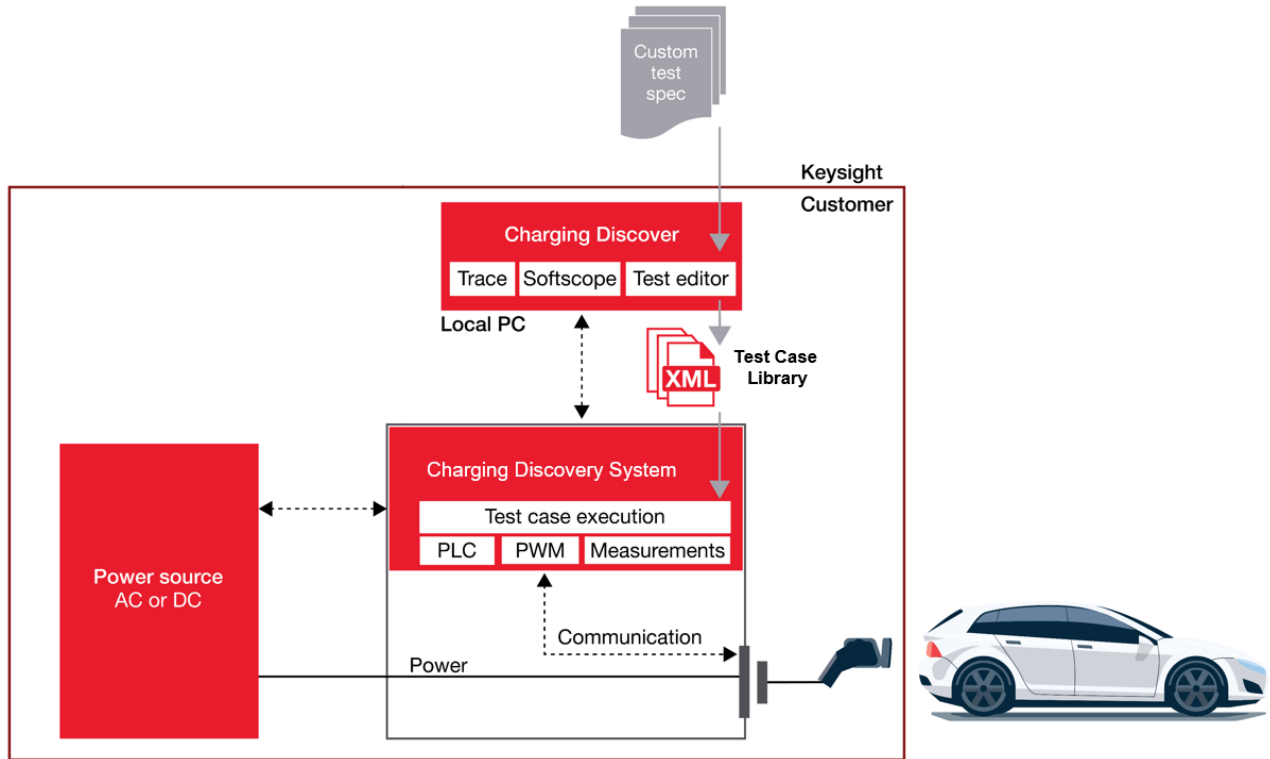

Figure 5. Interface topology of CDS with basic functionality.

The software functionality, without an additional license, includes reading and modifying test case packages purchased from Keysight as well as customized (self-created) test cases. The execution of the test case packages purchased from Keysight is also possible.

Note: If the user wants to execute customized test cases, the Expert Mode license (SL1040A-S01, next page) is required.

SL1040A-S01 Expert mode

The Expert mode represents an extension of the available software functionality described above by enabling the possibility to execute customized test cases. In addition, it is possible to control and monitor the test case execution via remote access.

Therefore, the Expert mode license includes SL1040A-S03:

SL1040A-S03 .NET driver DLL for CDS remote testcase interface

This interface specification describes the main class with all data types and functions of the Scienlab Test Case Library. In combination with the Charging Discovery System and the application software Charging Discover the Scienlab Test Case Library can be used to:

- Open and read Charging Discover project files.
- Show and modify test case parameters in a project file.
- Start and stop test cases in the Charging Discovery System.
- Show test case live states.

Within this license, a DLL file “TC .NET” will be provided via Keysight Software Manager (KSM). This file will be updated with every update of the firmware interface, whenever applicable for a convenient usage of the interface of the test case library.

The following figure shows the interface topology of CDS with Expert Mode:

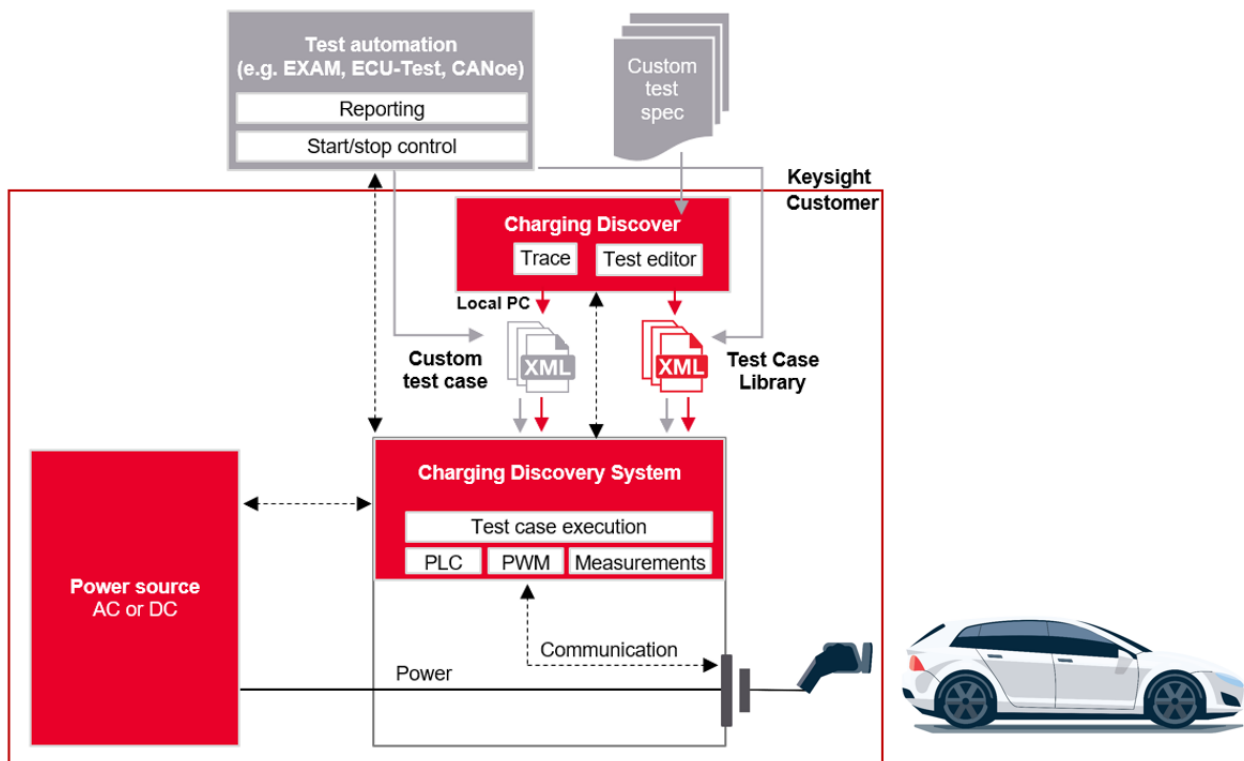

Figure 6. Interface topology of CDS with Expert mode.

SL1040A-S02 Developer mode

Remote interface

The Developer mode enables users to connect the Scienlab Charging Discovery System with a third-party test automation through Ethernet (TCP/UDP). This interface allows users to parametrize EV/EVSE emulation or test case mode and execute tests remotely. The Keysight Windows application software, Scienlab Charging Discover, captures traces in this mode when automatically connected, but the software tool is not required during test execution anymore.

Note: It is still required for test case and test project definition.

The Developer mode license is an extension of the Expert mode and includes SL1040A-S03 and SL1040A-S04.

Remote access supports the following functions:

- Configure use case, charging standard and operation mode (AC or DC) or select and run test projects/cases
- Start, stop and reset the system
- Read charging state (PWM and high-level communication)
- Read all electrical measurements of CDS (signal and power)
- manual control of CP and PP output in EVSE emulation (e.g. PWM amplitude, frequency or duty cycle)
- Manual control of CP in EV emulation (e.g. setting R2/R3 resistance and cable capacitance)
- Remote variation of all charging communication parameters (before and during charging)
- Remote injection of fault states in CP and PP (e.g. short circuit)
- Manual control of attached power sources/loads: voltage/current setpoints, power-switch off limits
- Access all charging state related high-level parameters of EV and EVSE (V2G or CAN) as decoded values (e.g. TargetCurrent, PresentVoltage, SOC)
- Direct access to EV and EVSE PLC modem of CDS (GreenPHY QCA7000)

Furthermore, the Developer mode license includes SL1040A-S04:

SL1040A-S04 .NET driver DLL for CDS SLEP interface

The interface specification of the SLEPLibrary describes the main class with all data types and functions, which are necessary to communicate with Keysight emulators and Scienlab Measurement & Control Modules.

This specification is valid for all systems.

Within this license, a DLL file "SLEP .NET" will be provided via Keysight Software Manager (KSM). This file will be updated with every update of the firmware interface, whenever applicable for a convenient usage of the SLEP interface.

The following figure shows the interface topology of CDS with Developer Mode:

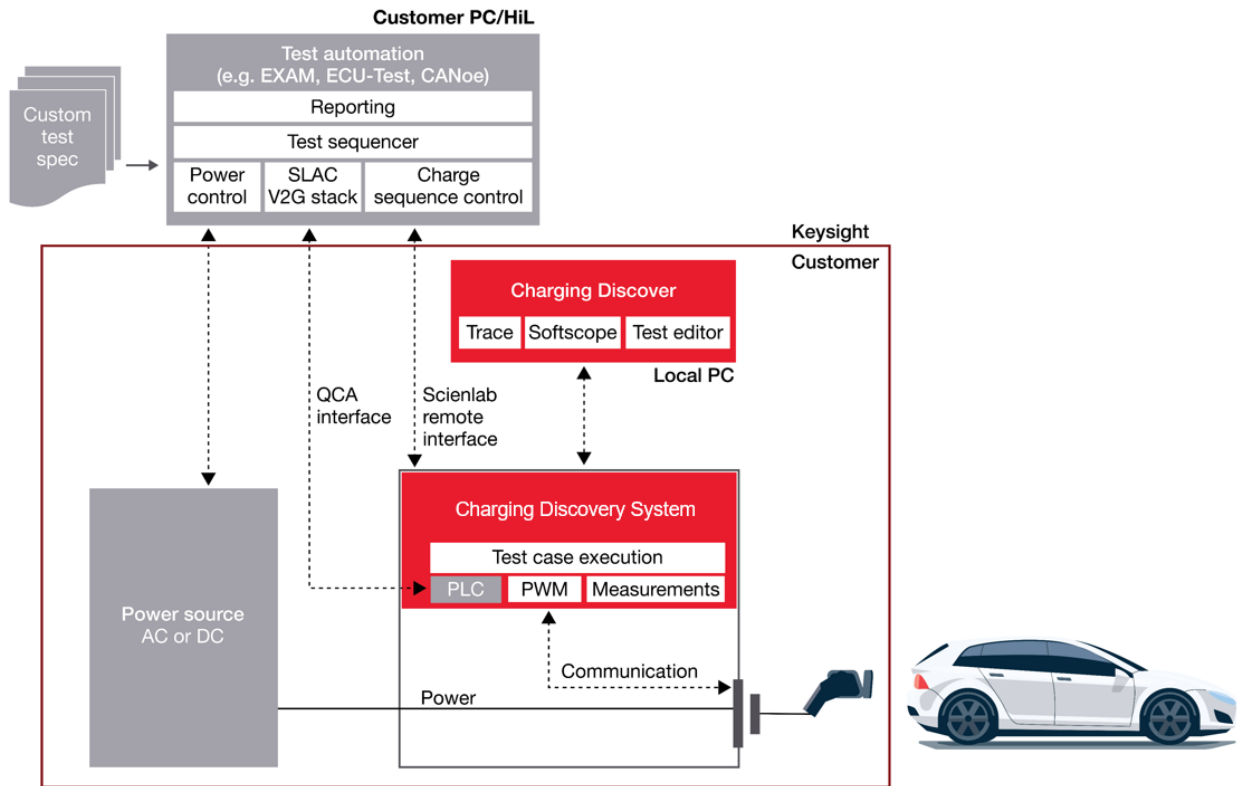

Figure 7. Interface topology of CDS with Developer mode.

Because of the direct access to all internal CDS components, users can integrate the CDS in their own test bench, automation software or hardware-in-the-loop systems and therefore combine the CDS with other third-party power sources/loads.

Note: When doing so, the CDS is neither controlling the charging sequence, nor the third-party power sources and loads. Since this control is managed by the customer's software and operator, Keysight is not responsible for technical integration issues. Technical support can be received through productivity support service.

Project Management, Consulting and Installation Services

Service features depend on the facilities, customer expertise, and overall scope of the project. For that reason, it is not possible to give exact service efforts without knowing the customer's requirements and goals. Keysight offers the following services to secure a successful project execution and reduce ramp-up time for our customers.

PS-XPM-100-SL Project management services

Keysight recommends project management services for each test bench project. By ordering the project management services, an experienced project manager is dedicated to your project and acts as a direct communication interface from Keysight to the customer's project management team.

The project manager takes over the responsibility:

- To develop and manage the project plan
- To track project progress and milestones
- Communication project status regularly and ensure any unscheduled project events or project deviations are communicated and promptly discussed with the customer project team
- To provide complete and accurate project documentation to the customer.

PS-XINS-100-SL Project installation services

These services provide installation expertise to manage, deliver and coordinate local facilities installation for the test bench. Specific installation efforts depend on the customer's individual facility, the locally available power and cooling and the test bench being delivered.

PS-XENG-100-SL Project engineering services

Project engineering services provide specialized engineering services during project development and implementation. The customer's project team will have access to engineering expertise to aid in various tasks specific to their project including but not limited to – safety matrix and test bench guard, facilities and lab layout, special power requirements, etc.

PS-XCOM-100-SL Project commissioning services

Project commissioning services for the test solution provide an experienced test bench engineer to validate and complete the test bench setup in readiness for the customer's initial usage. It includes validating specific hardware and software configurations per the project requirements and any specific consulting agreed to beforehand, given the test bench's customer-specific usage.

Startup assistance training

Startup assistance training provides insight into the solution setup and quickly prepares your team to use the solution including hardware and software. Receive training at your site with the purchase of a new solution. For ongoing training needs, cost-effective web services and advanced training are available through the Post-Acceptance Services described below.

Basic training - 1 day training about introduction to the hardware

- Switching a system on, order of instruments
- Getting a system in ready mode (software & hardware)
- Resetting system & safety matrix after emergency off
- Connect cables to DUT
- Setting up a system in software and start a test
- System care

Advanced training - 1 or 2 days advanced use of the software

- Programming examples and exercises
- Details on system warnings/errors and how to react to them

Premium - Custom # of days

- Custom content based on customer needs

KeysightCare Solutions

The KeysightCare Solutions provide comprehensive coverage for all support needs, including all hardware support and technical support.

Two levels of post-delivery solution support are available:

- KeysightCare Premium Solution Support – Prioritized support designed to minimize down time with committed technical support response times and hardware support turnaround times.
- KeysightCare Basic Solution Support – complete solution coverage for installations where uptime is less critical. Includes technical support and hardware support with non-committed response times.

Both Premium and Basic Solution Support include on-site options. This is necessary for large installations and an option for smaller solutions (such as some portable solutions).

Service deliverables

	KeysightCare Solution Basic		KeysightCare Solution Premium	
	Return to Keysight R-55J-001-X ⁷	Onsite R-55L-001-X ⁷	Return to Keysight R-55K-001-X ⁷	Onsite R-55M-001-X ⁷
	Technical support (Application and solution specific for both hardware and software¹)			
Self-service web portal & knowledge center, 24/7	✓		✓	
Technical support response times	2 business days		4 business hours ³	
Weekend support available on request ²	X		✓	
On-site technical support response time ²		7 business days ²		3 business days ²
Software configuration support ¹	✓ remote		✓ remote or onsite ⁴	
Solution hardware support⁵				
Repair service coverage	✓		✓	
Repair service turnaround or onsite response time	15 business days	7 business days response	7 business days turnaround	3 business days response
Calibration service ⁴	✓		✓	
Calibration type	Keysight Calibration		Keysight Calibration + Measurement Uncertainty + Guard Banding	
Calibration turnaround or onsite response time	10 business days	mutually scheduled	5 business days turnaround	priority scheduled
Preventive maintenance ⁸	X		✓	
Preventive maintenance frequency	X		during service events	twice a year
Application of service notes ⁶	✓ mandatory notes only		✓ mandatory and recommended notes	
Customer care review twice a year on request	X		✓	

- ¹ KeysightCare Software Agreement required for software support including software updates and notifications. Onsite support at the discretion of Keysight.
- ² Onsite technical support is provided or at the discretion of Keysight. Weekend support is only available for existing tickets by prior arrangement.
- ³ Technical support response times may vary for specific solutions.
- ⁴ Annual calibration service and calibration after repair if applicable is included for instruments that require calibration.
- ⁵ Offering may be different by country. Certain solution configurations are not applicable for return to Keysight. Please contact regional representatives.
- ⁶ We perform application of service notes during scheduled service events.
- ⁷ Service Product Number (SPN). When ordering, update with the relevant SPN based on the length of service required (e.g. -1, -2, -3, or -5 for 1 year, 2 years, 3 years or 5 years).
- ⁸ 3rd party products are excluded for basic and premium packages.

Find out more about KeysightCare Service and Support [here](#).

Extend the Capabilities of your Test Solution

Meet the SL1200A Series Scienlab Regenerative AC Emulator, 3-Phase

The SL1200A Series was designed to handle all your 3-phase AC test needs up to 1200 VAC, from 30 to 630 kVA without the need for a transformer. Two voltage ranges are available: 600 VAC and 1200 VAC. The 600 VAC models are ideal for low voltage inverter test as well as EV and EVSE charging test applications. The 1200 VAC models allow for (HVRT) testing at the IEC LV-AC limit without the need for a large, complex test setup.

- Covers AC test needs; up to 1200 V_{L-L}; up to 130 A; up to 630 kVA
- Achieve 1200 V_{L-L} at full specifications without extra equipment, such as a transformer
- Save energy with 100% regenerative (bidirectional) power solution with > 85% efficiency
- Get up and running immediately with intuitive soft front panel (SFP)
- Feel confident with complete, one-vendor solution of hardware, software, consulting, and support services worldwide for many applications, such as EVSE/EV charging test

Find out more about the [SL1200A Scienlab Regenerative AC Emulator, 3 Phase](#).

Meet the SL104XA Series Scienlab Dynamic DC Emulator

With bi-directionality, integrated DC voltage and current controllers, high dynamics, and its regenerative energy feedback capacity, the Scienlab Dynamic DC Emulator provides an all-in-one system for efficient and effective testing of the power electronic components in electric vehicles (EV) and electric vehicle supply equipment (EVSE).

- Efficient testing of power electronics and charging technology
- Available for high voltage as well as 48 V applications
- Energy-efficient source and sink mode
- Real-time-capable, open interface
- Power increase through parallelization

Find out more about the [SL104XA Series Scienlab Dynamic DC Emulator](#).

Software to control Scienlab Charging Discovery System

Meet the Scienlab Charging Discover Test Software

The Scienlab Charging Discover test software controls the Scienlab Charging Discovery System (CDS). With this up-to-date, user-friendly software, you can operate the system, visualize measured values, record test sequences, and generate reports for trusted insights.

- Live and synchronized views of recorded measurements
- Test editor for creating individual test cases
- Powerful graph view for analyzing recorded traces
- Export of measured values (for example, MDF)
- Remote functionality for Hardware in the Loop test benches



Find out more about the [SL1093A Scienlab Charging Discover Test Software](#).

Meet the Scienlab Test Case Library

The Scienlab Test Case Library provides complete test case libraries for all important charging conformance and interoperability standards. Each library is developed according to official specification and carefully verified with all CDS hardware configurations and every software release version. Hence, it is the quickest and most simple way to get valid test results out of the box.

Find out more about the [SL1095A Scienlab Test Case Library – TTCN-3](#).

Find out more about the [SL1300A Scienlab Test Case Library – Charging Discover](#).

Learn more at: www.keysight.com

For more information on Keysight Technologies' products, applications or services, please contact your local Keysight office. The complete list is available at: www.keysight.com/find/contactus

