



**ROHDE & SCHWARZ**

Test and Measurement  
Division

## **Operating Manual**

# **Power Meter**

**R&S<sup>®</sup> NRP**

**1143.8500.02**

Printed in the Federal  
Republic of Germany

Dear Customer,

R&S® is a registered trademark of Rohde & Schwarz GmbH & Co. KG.  
Trade names are trademarks of the owners.

# Supplement to Operating Manual R&S NRP

## 1144.1400.12-04-

**Dear Customer,**

Your power meter is equipped with firmware version  $\geq 03.00$ . A number of functions have been modified since the printing of the manual, and the modifications are described in the following.

### Battery operation

System → Bat...

The R&S NRP-B3 option allows the R&S NRP to be operated independently of the AC supply.

The battery is automatically charged as soon as its residual capacity has dropped below 96% full charge and the R&S NRP is connected to the AC supply.

A warning is displayed shortly before the battery is completely discharged. If the battery is fully discharged, the R&S NRP automatically switches off to prevent any damage to the battery by over-discharging. In this case, the battery should be recharged as soon as possible.

The charge status of the battery is displayed in the Battery dialog window and symbolically in every expanded window. The Battery dialog window also provides information about the battery's remaining operating time.

System menu:

Bat...

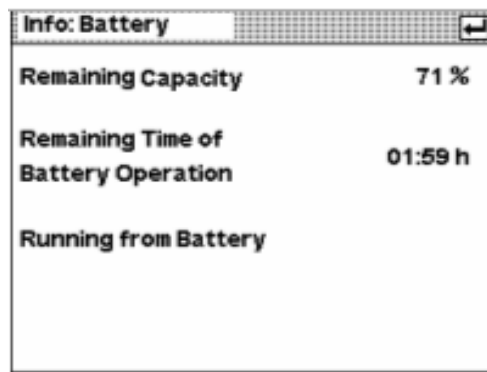
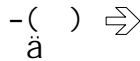

Battery – Dialog

**Remaining Capacity**

This line indicates the battery's remaining charge in percent.

**Remaining Time of Battery Operation**

This line indicates the remaining operating time.

*Note*

*After the operating status has been changed, it may take the display up to one minute to be updated.*

**Running from Battery**

This line indicates the battery's current operating status.

or

**Charging**

or

**Idle**

The data sheet specifies how long the R&S NRP can be operated from the battery. The battery operating time depends on the number and type of the connected sensors and especially on the brightness of the display backlighting.

The battery can be charged at temperatures between 5°C and 30°C and discharged at temperatures ranging from 0°C to 40°C. To prolong the life of the battery, however, the instrument should not be operated too frequently at the upper limit temperatures. If the battery is charged at temperatures above 30°C, the charging process is repeatedly interrupted to allow cooling, which considerably extends the charging time. If the temperature exceeds a value of about 35°C, charging is practically discontinued.

It is normal that battery charging continues after the battery has been charged 100%. To prolong the life of the battery, this process should not be aborted.

Since NiMH batteries are subject to considerable self-discharging, an R&S NRP that is equipped with the R&S NRP-B3 option should not be stored for more than three months without being connected to the AC supply.



### Caution

*The performance of a "Smart Battery" may be manufacturer-specific. Only the original battery will ensure correct functioning and a charging functionality that prolongs the life of the option.*

*The safety test marks lose their validity if batteries from other manufacturers are used.*

## Calibrating the charge counter

From time to time, the battery must be calibrated so that the remaining operating time is not displayed incorrectly as a result of the battery's decreasing capacity over time. A calibration cycle can automatically take place in normal operation, if the R&S NRP is fully discharged after being fully charged, without intermittently connecting the instrument to the AC supply. In this case, no further action on the part of the user is required.

However, if calibration is not performed in normal operation, after some time the battery will request a calibration cycle. This request will be displayed after the R&S NRP has been switched on.

Switch on the R&S NRP:

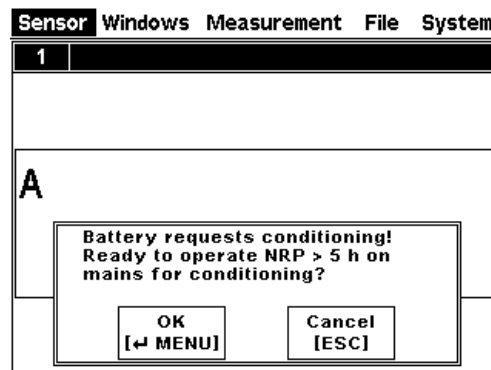

Request for a calibration cycle from the battery

(MENU)  
ä

The calibration cycle is performed. First of all, the battery is fully charged, then fully discharged and finally fully charged again. This process may take between 11 and 20 hours depending on the charge status of the battery at the beginning of the calibration cycle. The higher the charge of the battery at the beginning, the faster the calibration cycle is performed. Calibration itself takes place at the end of the discharging process.

During the calibration cycle, or at least until the end of the discharging phase, the R&S NRP should remain connected to the AC supply and should always be on. Otherwise the calibration counter is not calibrated, which means that the warning will be displayed again when the R&S NRP is switched on the next time.

(ESC/LOCAL)  
ä

The calibration cycle is not performed. The warning will be displayed again when the R&S NRP is switched on the next time.

## Supplement to Operating Manual R&S NRP 1144.1400.12-04-

**Dear Customer,**

Your power meter is equipped with firmware version  $\geq 03.00$ . A number of functions have been modified since the printing of the manual, and the modifications are described on the following pages.

### Ethernet

For remote control via a TCP/IP-based LAN, the R&S NRP can be fitted with an optional 10/100BaseT Ethernet interface (option R&S NRP-B4). The socket is located on the rear panel of the R&S NRP. Via this interface, a controller can remote-control the R&S NRP by means of the power meter's SCPI commands, using the VXI11 protocol (TCP/IP instrument protocol specification), version 1.0, released on 17 July 1995 by the VXIbus Consortium.

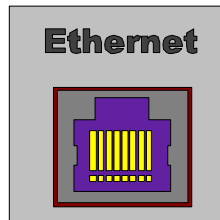

**Ethernet connection socket**

VXI11

The VXI11 protocol uses ONC RPC (open network computing remote procedure calls), making it possible to call R&S NRP functions at the source code level as if they were running locally on the controller. The following figure shows the relationships of the relevant protocol layers in the OSI reference model.

Application	VXI11 Network Instrument
Presentation	XDR (Data representation)
Session	ONC RPC
Transport	TCP
Network	IP
Data Link	Ethernet/802.3
Physical	10/100BASE-T

The VXI11 protocol stack in the OSI reference model

A VXI11 remote-control connection consists of three channels (core, abort and interrupt) which can be used to set up as many links as desired. The concept of links makes it possible to connect a *network instrument client* in a controller with a number of logical measurement *devices* in a host computer via a single VXI11 remote-control connection. A link is then set up to each logical device. It is also possible to set up several links to one logical device, provided that several servers are running on the network instrument host or a network instrument client is being served by several controllers. To prevent problems caused by several controllers simultaneously accessing one device, links can be locked. A locked link has exclusive access rights to a particular device. Accesses via other links are then not possible. An exception is an abort via the abort channel, which can be executed at any time and also aborts the execution of commands via other links.

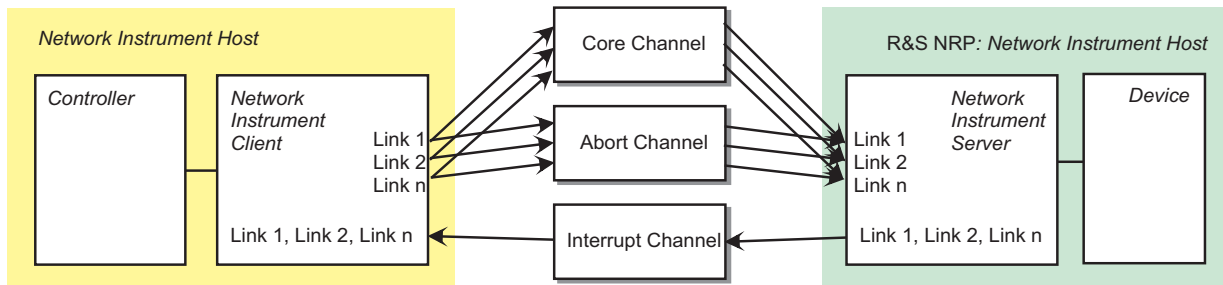

Diagram of a VXI11 connection with several links

### Communication channels of a VXI11 connection

Channel	Meaning
Core	All client-server communication, excluding aborts and interrupts, is handled via this channel.
Abort	Since the commands in the core channel are serialized and therefore cannot be interrupted, asynchronous abort commands must be transmitted via a separate, independent channel. This channel serves no further purpose.
Interrupt	Service requests (SRQs) are reported to the network instrument client via this channel. As all links share this channel, the client must subsequently determine which device triggered the SRQ by polling the status bytes ( <code>device_readstb()</code> function) of all connected devices.

## Connection setup

A socket connection is set up for each channel. All commands via the core or abort channel contain an ID that is used to assign the command to a link. The interrupt channel, which is also implemented using sockets, is shared by all links. Commands transmitted via this channel do not contain a link ID. The setup is handled by the network instrument client, which first requests the connections from the network instrument server's portmapper service at port 111. The portmapper subsequently activates the channel in the R&S NRP and tells the client at which ports channel services can be addressed. For this reason, it is important that any firewalls or routers between the client and the R&S NRP enable free access from the controller to the R&S NRP (core and abort channels) and vice versa (interrupt channel). As the ports for the channels are dynamically assigned, reliable information regarding the port numbers used cannot be provided.

## Remote control via VXI11

The following possibilities are suggested for remote-controlling the R&S NRP via VXI11:

1. The simplest way to create remote-control programs is by using a VISA (virtual instruments software architecture) implementation and creating the remote-control programs under Visual Basic or C/C++. VISA implementations provide an application programming interface (API) that offers all necessary functions. Knowledge about VXI11 is helpful but not required.

The VISA resource identifier used to identify a VXI11 device has the following format:

TCPIP::::INSTR

The IP address is specified using the familiar dot notation (e.g. 89.10.65.59).

2. The "TCP/IP Instrument Protocol Specification VXI11" contains in annex C an RPCL description of the protocol. The program `rpcgen`, which is contained in any ONC RPC distribution, is used to generate stubs, which can be inserted into separate C programs, where the functions from the following table can be called like ordinary library functions.

This procedure requires RPC programming skills.



## VXI11 protocol functions

Function name	Channel	Meaning
<code>create_link()</code>	core	Opens a link to a network instrument device, setting up socket connections for the core and abort channels, but not for the interrupt channel.
<code>destroy_link()</code>	core	Cancels a link to a network instrument device.
<code>device_write()</code>	core	Sends an IEEE 488.2 or SCPI command as a string to a network instrument device.
<code>device_read()</code>	core	Reads responses from a network instrument device.
<code>device_readstb()</code>	core	Reads the status byte of a network instrument device.
<code>device_trigger()</code>	core	Triggers a trigger in a network instrument device and is equivalent to *TRG.
<code>device_clear()</code>	core	Triggers a "device clear" (DCL) in a network instrument device. In the R&S NRP, DCL and abort have the same effect. Because <code>device_abort()</code> , unlike <code>device_clear()</code> , is transmitted over the abort channel, it is not serialized with other commands but goes directly to the device and is therefore preferable.
<code>device_remote()</code>	core	Changes the network instrument device to the remote state.
<code>device_local()</code>	core	Changes the network instrument device to the local state.
<code>device_lock()</code>	core	LLO (local lock out). The keyboard of the network instrument device is locked.
<code>device_unlock()</code>	core	Cancels the LLO state.
<code>device_docmd()</code>	core	The network instrument device executes a command.
<code>device_abort()</code>	abort	The network instrument device aborts an in-progress command. See <code>device_clear()</code> .
<code>create_intr_chan()</code>	core	An interrupt channel to the network instrument device is set up.
<code>destroy_intr_chan()</code>	core	An existing interrupt channel to the network instrument device is cleared down.
<code>device_enable_srq()</code>	core	The sending of service requests from the network instrument device to the network instrument controller is activated/deactivated.
<code>device_intr_srq()</code>	interrupt	This is the only function that the network instrument server calls from the network instrument device. It signals a service request (SRQ).

## USB

If the R&S NRP is connected to a controller via a USB 1.1 interface, it logs on as a USBTMC (USB test and measurement class) device, provided that USB is selected as a remote interface in the System→Remote menu. The USBTMC standard describes how IEEE 488.2-compatible communication with can be implemented via USB.

As with remote control via VXI11, the use of a VISA distribution that must include a USBTMC driver is recommended for remote control via USB. The VISA resource identifier used to identify a USBTMC device has the following format:

USB::<<vendor ID>::<<product ID>::<<serial number>::INSTR

<vendor ID>	0x0aad
<product ID>	0x001b
<serial number>	The serial number is a string that can be found in the System→System Info menu.

In addition, the VISA resource identifier appears on the R&S NRP display if the USB remote interface is selected.

# **Tabbed Divider Overview**

## **Data Sheet**

**Safety Instructions**  
**Certificate of Quality**  
**EU Certificate of Conformity**  
**List of R&S Representatives**

## **Tabbed Divider**

<b>1</b>	<b>Chapter 1: Putting into Operation</b>
<b>2</b>	<b>Chapter 2: Getting Started</b>
<b>3</b>	<b>Chapter 3: Operation</b>
<b>4</b>	<b>Chapter 4: Functional Description</b>
<b>5</b>	<b>Chapter 5: Remote Control – Basics</b>
<b>6</b>	<b>Chapter 6: Remote Control – Commands</b>
<b>7</b>	<b>Chapter 7: for future extensions</b>
<b>8</b>	<b>Chapter 8: Maintenance</b>
<b>9</b>	<b>Chapter 9: Error Messages</b>
<b>10</b>	<b>Chapter 10: for future extensions</b>



**Before putting the product into operation for the first time, make sure to read the following**



# Safety Instructions

Rohde & Schwarz makes every effort to keep the safety standard of its products up to date and to offer its customers the highest possible degree of safety. Our products and the auxiliary equipment required for them are designed and tested in accordance with the relevant safety standards. Compliance with these standards is continuously monitored by our quality assurance system. This product has been designed and tested in accordance with the EC Certificate of Conformity and has left the manufacturer's plant in a condition fully complying with safety standards. To maintain this condition and to ensure safe operation, observe all instructions and warnings provided in this manual. If you have any questions regarding these safety instructions, Rohde & Schwarz will be happy to answer them.

Furthermore, it is your responsibility to use the product in an appropriate manner. This product is designed for use solely in industrial and laboratory environments or in the field and must not be used in any way that may cause personal injury or property damage. You are responsible if the product is used for an intention other than its designated purpose or in disregard of the manufacturer's instructions. The manufacturer shall assume no responsibility for such use of the product.

The product is used for its designated purpose if it is used in accordance with its operating manual and within its performance limits (see data sheet, documentation, the following safety instructions). Using the products requires technical skills and knowledge of English. It is therefore essential that the products be used exclusively by skilled and specialized staff or thoroughly trained personnel with the required skills. If personal safety gear is required for using Rohde & Schwarz products, this will be indicated at the appropriate place in the product documentation.

## Symbols and safety labels

Observe operating instructions	Weight indication for units >18 kg	Danger of electric shock	Warning! Hot surface	PE terminal	Ground	Ground terminal	Attention! Electrostatic sensitive devices

Supply voltage ON/OFF	Standby indication	Direct current (DC)	Alternating current (AC)	Direct/alternating current (DC/AC)	Device fully protected by double/reinforced insulation

## Safety Instructions

Observing the safety instructions will help prevent personal injury or damage of any kind caused by dangerous situations. Therefore, carefully read through and adhere to the following safety instructions before putting the product into operation. It is also absolutely essential to observe the additional safety instructions on personal safety that appear in other parts of the documentation. In these safety instructions, the word "product" refers to all merchandise sold and distributed by Rohde & Schwarz, including instruments, systems and all accessories.

### Tags and their meaning

DANGER	This tag indicates a safety hazard with a high potential of risk for the user that can result in death or serious injuries.
WARNING	This tag indicates a safety hazard with a medium potential of risk for the user that can result in death or serious injuries.
CAUTION	This tag indicates a safety hazard with a low potential of risk for the user that can result in slight or minor injuries.
ATTENTION	This tag indicates the possibility of incorrect use that can cause damage to the product.
NOTE	This tag indicates a situation where the user should pay special attention to operating the product but which does not lead to damage.

These tags are in accordance with the standard definition for civil applications in the European Economic Area. Definitions that deviate from the standard definition may also exist. It is therefore essential to make sure that the tags described here are always used only in connection with the associated documentation and the associated product. The use of tags in connection with unassociated products or unassociated documentation can result in misinterpretations and thus contribute to personal injury or material damage.

### Basic safety instructions

1. The product may be operated only under the operating conditions and in the positions specified by the manufacturer. Its ventilation must not be obstructed during operation. Unless otherwise specified, the following requirements apply to Rohde & Schwarz products:  
prescribed operating position is always with the housing floor facing down, IP protection 2X, pollution severity 2, overvoltage category 2, use only in enclosed spaces, max. operation altitude max. 2000 m. Unless specified otherwise in the data sheet, a tolerance of  $\pm 10\%$  shall apply to the nominal voltage and of  $\pm 5\%$  to the nominal frequency.
2. Applicable local or national safety regulations and rules for the prevention of accidents must be observed in all work performed. The product may be opened only by authorized, specially trained personnel. Prior to performing any work on the product or opening the product, the product must be disconnected from the supply network. Any adjustments, replacements of parts, maintenance or repair must be carried out only by technical personnel authorized by Rohde & Schwarz. Only original parts may be used for replacing parts relevant to safety (e.g. power switches, power transformers, fuses). A safety test must always be performed after parts relevant to safety have been replaced (visual inspection, PE conductor test, insulation resistance measurement, leakage current measurement, functional test).
3. As with all industrially manufactured goods, the use of substances that induce an allergic reaction (allergens, e.g. nickel) such as aluminum cannot be generally excluded. If you develop an allergic reaction (such as a skin rash, frequent sneezing, red eyes or respiratory difficulties), consult a physician immediately to determine the cause.

## Safety Instructions

4. If products/components are mechanically and/or thermally processed in a manner that goes beyond their intended use, hazardous substances (heavy-metal dust such as lead, beryllium, nickel) may be released. For this reason, the product may only be disassembled, e.g. for disposal purposes, by specially trained personnel. Improper disassembly may be hazardous to your health. National waste disposal regulations must be observed.
5. If handling the product yields hazardous substances or fuels that must be disposed of in a special way, e.g. coolants or engine oils that must be replenished regularly, the safety instructions of the manufacturer of the hazardous substances or fuels and the applicable regional waste disposal regulations must be observed. Also observe the relevant safety instructions in the product documentation.
6. Depending on the function, certain products such as RF radio equipment can produce an elevated level of electromagnetic radiation. Considering that unborn life requires increased protection, pregnant women should be protected by appropriate measures. Persons with pacemakers may also be endangered by electromagnetic radiation. The employer is required to assess workplaces where there is a special risk of exposure to radiation and, if necessary, take measures to avert the danger.
7. Operating the products requires special training and intense concentration. Make certain that persons who use the products are physically, mentally and emotionally fit enough to handle operating the products; otherwise injuries or material damage may occur. It is the responsibility of the employer to select suitable personnel for operating the products.
8. Prior to switching on the product, it must be ensured that the nominal voltage setting on the product matches the nominal voltage of the AC supply network. If a different voltage is to be set, the power fuse of the product may have to be changed accordingly.
9. In the case of products of safety class I with movable power cord and connector, operation is permitted only on sockets with earthing contact and protective earth connection.
10. Intentionally breaking the protective earth connection either in the feed line or in the product itself is not permitted. Doing so can result in the danger of an electric shock from the product. If extension cords or connector strips are implemented, they must be checked on a regular basis to ensure that they are safe to use.
11. If the product has no power switch for disconnection from the AC supply, the plug of the connecting cable is regarded as the disconnecting device. In such cases, it must be ensured that the power plug is easily reachable and accessible at all times (length of connecting cable approx. 2 m). Functional or electronic switches are not suitable for providing disconnection from the AC supply. If products without power switches are integrated in racks or systems, a disconnecting device must be provided at the system level.
12. Never use the product if the power cable is damaged. By taking appropriate safety measures and carefully laying the power cable, ensure that the cable cannot be damaged and that no one can be hurt by e.g. tripping over the cable or suffering an electric shock.
13. The product may be operated only from TN/TT supply networks fused with max. 16 A.
14. Do not insert the plug into sockets that are dusty or dirty. Insert the plug firmly and all the way into the socket. Otherwise this can result in sparks, fire and/or injuries.
15. Do not overload any sockets, extension cords or connector strips; doing so can cause fire or electric shocks.
16. For measurements in circuits with voltages  $V_{rms} > 30 V$ , suitable measures (e.g. appropriate measuring equipment, fusing, current limiting, electrical separation, insulation) should be taken to avoid any hazards.
17. Ensure that the connections with information technology equipment comply with IEC 950/EN 60950.
18. Never remove the cover or part of the housing while you are operating the product. This will expose circuits and components and can lead to injuries, fire or damage to the product.

## Safety Instructions

19. If a product is to be permanently installed, the connection between the PE terminal on site and the product's PE conductor must be made first before any other connection is made. The product may be installed and connected only by a skilled electrician.
20. For permanently installed equipment without built-in fuses, circuit breakers or similar protective devices, the supply circuit must be fused in such a way that suitable protection is provided for users and products.
21. Do not insert any objects into the openings in the housing that are not designed for this purpose. Never pour any liquids onto or into the housing. This can cause short circuits inside the product and/or electric shocks, fire or injuries.
22. Use suitable overvoltage protection to ensure that no overvoltage (such as that caused by a thunderstorm) can reach the product. Otherwise the operating personnel will be endangered by electric shocks.
23. Rohde & Schwarz products are not protected against penetration of water, unless otherwise specified (see also safety instruction 1.). If this is not taken into account, there exists the danger of electric shock or damage to the product, which can also lead to personal injury.
24. Never use the product under conditions in which condensation has formed or can form in or on the product, e.g. if the product was moved from a cold to a warm environment.
25. Do not close any slots or openings on the product, since they are necessary for ventilation and prevent the product from overheating. Do not place the product on soft surfaces such as sofas or rugs or inside a closed housing, unless this is well ventilated.
26. Do not place the product on heat-generating devices such as radiators or fan heaters. The temperature of the environment must not exceed the maximum temperature specified in the data sheet.
27. Batteries and storage batteries must not be exposed to high temperatures or fire. Keep batteries and storage batteries away from children. If batteries or storage batteries are improperly replaced, this can cause an explosion (warning: lithium cells). Replace the battery or storage battery only with the matching Rohde & Schwarz type (see spare parts list). Batteries and storage batteries are hazardous waste. Dispose of them only in specially marked containers. Observe local regulations regarding waste disposal. Do not short-circuit batteries or storage batteries.
28. Please be aware that in the event of a fire, toxic substances (gases, liquids etc.) that may be hazardous to your health may escape from the product.
29. Please be aware of the weight of the product. Be careful when moving it; otherwise you may injure your back or other parts of your body.
30. Do not place the product on surfaces, vehicles, cabinets or tables that for reasons of weight or stability are unsuitable for this purpose. Always follow the manufacturer's installation instructions when installing the product and fastening it to objects or structures (e.g. walls and shelves).
31. Handles on the products are designed exclusively for personnel to hold or carry the product. It is therefore not permissible to use handles for fastening the product to or on means of transport such as cranes, fork lifts, wagons, etc. The user is responsible for securely fastening the products to or on the means of transport and for observing the safety regulations of the manufacturer of the means of transport. Noncompliance can result in personal injury or material damage.
32. If you use the product in a vehicle, it is the sole responsibility of the driver to drive the vehicle safely. Adequately secure the product in the vehicle to prevent injuries or other damage in the event of an accident. Never use the product in a moving vehicle if doing so could distract the driver of the vehicle. The driver is always responsible for the safety of the vehicle; the manufacturer assumes no responsibility for accidents or collisions.
33. If a laser product (e.g. a CD/DVD drive) is integrated in a Rohde & Schwarz product, do not use any other settings or functions than those described in the documentation. Otherwise this may be hazardous to your health, since the laser beam can cause irreversible damage to your eyes. Never try to take such products apart, and never look into the laser beam.



**Por favor lea imprescindiblemente antes de la primera puesta en funcionamiento las siguientes informaciones de seguridad**



## Informaciones de seguridad

Es el principio de Rohde & Schwarz de tener a sus productos siempre al día con los estándares de seguridad y de ofrecer a sus clientes el máximo grado de seguridad. Nuestros productos y todos los equipos adicionales son siempre fabricados y examinados según las normas de seguridad vigentes. Nuestra sección de gestión de la seguridad de calidad controla constantemente que sean cumplidas estas normas. Este producto ha sido fabricado y examinado según el comprobante de conformidad adjunto según las normas de la CE y ha salido de nuestra planta en estado impecable según los estándares técnicos de seguridad. Para poder preservar este estado y garantizar un funcionamiento libre de peligros, deberá el usuario atenerse a todas las informaciones, informaciones de seguridad y notas de alerta. Rohde&Schwarz está siempre a su disposición en caso de que tengan preguntas referentes a estas informaciones de seguridad.

Además queda en la responsabilidad del usuario utilizar el producto en la forma debida. Este producto solamente fue elaborado para ser utilizado en la industria y el laboratorio o para fines de campo y de ninguna manera deberá ser utilizado de modo que alguna persona/cosa pueda ser dañada. El uso del producto fuera de sus fines definidos o despreciando las informaciones de seguridad del fabricante queda en la responsabilidad del usuario. El fabricante no se hace en ninguna forma responsable de consecuencias a causa del maluso del producto.

Se parte del uso correcto del producto para los fines definidos si el producto es utilizado dentro de las instrucciones del correspondiente manual del uso y dentro del margen de rendimiento definido (ver hoja de datos, documentación, informaciones de seguridad que siguen). El uso de los productos hace necesarios conocimientos profundos y el conocimiento del idioma inglés. Por eso se deberá tener en cuenta de exclusivamente autorizar para el uso de los productos a personas peritas o debidamente minuciosamente instruidas con los conocimientos citados. Si fuera necesaria indumentaria de seguridad para el uso de productos de R&S, encontrará la información debida en la documentación del producto en el capítulo correspondiente.

### Símbolos y definiciones de seguridad

Ver manual de instrucciones del uso	Informaciones para maquinaria con un peso de > 18kg	Peligro de golpe de corriente	¡Advertencia! Superficie caliente	Conexión a conductor protector	Conexión a tierra	Conexión a masa conductora	¡Cuidado! Elementos de construcción con peligro de carga electrostática

potencia EN MARCHA/PARADA	Indicación Stand-by	Corriente continua DC	Corriente alterna AC	Corriente continua/alterna DC/AC	El aparato está protegido en su totalidad por un aislamiento de doble refuerzo



## Informaciones de seguridad

Tener en cuenta las informaciones de seguridad sirve para tratar de evitar daños y peligros de toda clase. Es necesario de que se lean las siguientes informaciones de seguridad concienzudamente y se tengan en cuenta debidamente antes de la puesta en funcionamiento del producto. También deberán ser tenidas en cuenta las informaciones para la protección de personas que encontrarán en otro capítulo de esta documentación y que también son obligatorias de seguir. En las informaciones de seguridad actuales hemos juntado todos los objetos vendidos por Rohde&Schwarz bajo la denominación de „producto“, entre ellos también aparatos, instalaciones así como toda clase de accesorios.

### Palabras de señal y su significado

PELIGRO	Indica un punto de peligro con gran potencial de riesgo para el usuario. Punto de peligro que puede llevar hasta la muerte o graves heridas.
ADVERTENCIA	Indica un punto de peligro con un potencial de riesgo mediano para el usuario. Punto de peligro que puede llevar hasta la muerte o graves heridas .
ATENCIÓN	Indica un punto de peligro con un potencial de riesgo pequeño para el usuario. Punto de peligro que puede llevar hasta heridas leves o pequeñas
CUIDADO	Indica la posibilidad de utilizar mal el producto y a consecuencia dañarlo.
INFORMACIÓN	Indica una situación en la que deberían seguirse las instrucciones en el uso del producto, pero que no consecuentemente deben de llevar a un daño del mismo.

Las palabras de señal corresponden a la definición habitual para aplicaciones civiles en el ámbito de la comunidad económica europea. Pueden existir definiciones diferentes a esta definición. Por eso se debiera tener en cuenta que las palabras de señal aquí descritas sean utilizadas siempre solamente en combinación con la correspondiente documentación y solamente en combinación con el producto correspondiente. La utilización de las palabras de señal en combinación con productos o documentaciones que no les correspondan puede llevar a malinterpretaciones y tener por consecuencia daños en personas u objetos.

### Informaciones de seguridad elementales

1. El producto solamente debe ser utilizado según lo indicado por el fabricante referente a la situación y posición de funcionamiento sin que se obstruya la ventilación. Si no se convino de otra manera, es para los productos R&S válido lo que sigue: como posición de funcionamiento se define principalmente la posición con el suelo de la caja para abajo , modo de protección IP 2X, grado de suciedad 2, categoría de sobrecarga eléctrica 2, utilizar solamente en estancias interiores, utilización hasta 2000 m sobre el nivel del mar.  
A menos que se especifique otra cosa en la hoja de datos, se aplicará una tolerancia de  $\pm 10\%$  sobre el voltaje nominal y de  $\pm 5\%$  sobre la frecuencia nominal.
2. En todos los trabajos deberán ser tenidas en cuenta las normas locales de seguridad de trabajo y de prevención de accidentes. El producto solamente debe de ser abierto por personal périto autorizado. Antes de efectuar trabajos en el producto o abrirlo deberá este ser desconectado de la corriente. El ajuste, el cambio de partes, la manutención y la reparación deberán ser solamente efectuadas por electricistas autorizados por R&S. Si se reponen partes con importancia para los aspectos de seguridad (por ejemplo el enchufe, los transformadores o los fusibles), solamente podrán ser sustituidos por partes originales. Despues de cada recambio de partes elementales para la seguridad deberá ser efectuado un control de

## Informaciones de seguridad

- seguridad (control a primera vista, control de conductor protector, medición de resistencia de aislamiento, medición de medición de la corriente conductora, control de funcionamiento).
3. Como en todo producto de fabricación industrial no puede ser excluido en general de que se produzcan al usarlo elementos que puedan generar alergias, los llamados elementos alergénicos (por ejemplo el níquel). Si se produjeran en el trato con productos R&S reacciones alérgicas, como por ejemplo urticaria, estornudos frecuentes, irritación de la conjuntiva o dificultades al respirar, se deberá consultar inmediatamente a un médico para averiguar los motivos de estas reacciones.
  4. Si productos / elementos de construcción son tratados fuera del funcionamiento definido de forma mecánica o térmica, pueden generarse elementos peligrosos (polvos de sustancia de metales pesados como por ejemplo plomo, berilio, níquel). La partición elemental del producto, como por ejemplo sucede en el tratamiento de materias residuales, debe de ser efectuada solamente por personal especializado para estos tratamientos. La partición elemental efectuada inadecuadamente puede generar daños para la salud. Se deben tener en cuenta las directivas nacionales referentes al tratamiento de materias residuales.
  5. En el caso de que se produjeran agentes de peligro o combustibles en la aplicación del producto que debieran de ser transferidos a un tratamiento de materias residuales, como por ejemplo agentes refrigerantes que deben ser repuestos en periodos definidos, o aceites para motores, deberán ser tenidas en cuenta las prescripciones de seguridad del fabricante de estos agentes de peligro o combustibles y las regulaciones regionales para el tratamiento de materias residuales. Cuiden también de tener en cuenta en caso dado las prescripciones de seguridad especiales en la descripción del producto.
  6. Ciertos productos, como por ejemplo las instalaciones de radiación HF, pueden a causa de su función natural, emitir una radiación electromagnética aumentada. En vista a la protección de la vida en desarrollo deberían ser protegidas personas embarazadas debidamente. También las personas con un bypass pueden correr peligro a causa de la radiación electromagnética. El empresario está comprometido a valorar y señalar áreas de trabajo en las que se corra un riesgo de exposición a radiaciones aumentadas de riesgo aumentado para evitar riesgos.
  7. La utilización de los productos requiere instrucciones especiales y una alta concentración en el manejo. Debe de ponerse por seguro de que las personas que manejen los productos estén a la altura de los requerimientos necesarios referente a sus aptitudes físicas, psíquicas y emocionales, ya que de otra manera no se pueden excluir lesiones o daños de objetos. El empresario lleva la responsabilidad de seleccionar el personal usuario apto para el manejo de los productos.
  8. Antes de la puesta en marcha del producto se deberá tener por seguro de que la tensión preseleccionada en el producto equivalga a la del la red de distribución. Si es necesario cambiar la preselección de la tensión también se deberán en caso dabo cambiar los fusibles correspondientes del producto.
  9. Productos de la clase de seguridad I con alimentación móvil y enchufe individual de producto solamente deberán ser conectados para el funcionamiento a tomas de corriente de contacto de seguridad y con conductor protector conectado.
  10. Queda prohibida toda clase de interrupción intencionada del conductor protector, tanto en la toma de corriente como en el mismo producto ya que puede tener como consecuencia el peligro de golpe de corriente por el producto. Si se utilizaran cables o enchufes de extensión se deberá poner al seguro, que es controlado su estado técnico de seguridad.
  11. Si el producto no está equipado con un interruptor para desconectarlo de la red, se deberá considerar el enchufe del cable de distribución como interruptor. En estos casos deberá asegurar de que el enchufe sea de fácil acceso y nabejo (medida del cable de distribución aproximadamente 2 m). Los interruptores de función o electrónicos no son aptos para el corte de la red eléctrica. Si los productos sin interruptor están integrados en construcciones o instalaciones, se deberá instalar el interruptor al nivel de la instalación.

## Informaciones de seguridad

12. No utilice nunca el producto si está dañado el cable eléctrico. Asegure a través de las medidas de protección y de instalación adecuadas de que el cable de eléctrico no pueda ser dañado o de que nadie pueda ser dañado por él, por ejemplo al tropezar o por un golpe de corriente.
13. Solamente está permitido el funcionamiento en redes de distribución TN/TT aseguradas con fusibles de como máximo 16 A.
14. Nunca conecte el enchufe en tomas de corriente sucias o llenas de polvo. Introduzca el enchufe por completo y fuertemente en la toma de corriente. Si no tiene en consideración estas indicaciones se arriesga a que se originen chispas, fuego y/o heridas.
15. No sobrecargue las tomas de corriente, los cables de extensión o los enchufes de extensión ya que esto pudiera causar fuego o golpes de corriente.
16. En las mediciones en circuitos de corriente con una tensión de entrada de  $U_{eff} > 30 \text{ V}$  se deberá tomar las precauciones debidas para impedir cualquier peligro (por ejemplo medios de medición adecuados, seguros, limitación de tensión, corte protector, aislamiento etc.).
17. En caso de conexión con aparatos de la técnica informática se deberá tener en cuenta que estos cumplan los requisitos de la EC950/EN60950.
18. Nunca abra la tapa o parte de ella si el producto está en funcionamiento. Esto pone a descubierto los cables y componentes eléctricos y puede causar heridas, fuego o daños en el producto.
19. Si un producto es instalado fijamente en un lugar, se deberá primero conectar el conductor protector fijo con el conductor protector del aparato antes de hacer cualquier otra conexión. La instalación y la conexión deberán ser efectuadas por un electricista especializado.
20. En caso de que los productos que son instalados fijamente en un lugar sean sin protector implementado, autointerruptor o similares objetos de protección, deberá la toma de corriente estar protegida de manera que los productos o los usuarios estén suficientemente protegidos.
21. Por favor, no introduzca ningún objeto que no esté destinado a ello en los orificios de la caja del aparato. No vierta nunca ninguna clase de líquidos sobre o en la caja. Esto puede producir corto circuitos en el producto y/o puede causar golpes de corriente, fuego o heridas.
22. Asegúrese con la protección adecuada de que no pueda originarse en el producto una sobrecarga por ejemplo a causa de una tormenta. Si no se verá el personal que lo utilice expuesto al peligro de un golpe de corriente.
23. Los productos R&S no están protegidos contra el agua si no es que exista otra indicación, ver también punto 1. Si no se tiene en cuenta esto se arriesga el peligro de golpe de corriente o de daños en el producto lo cual también puede llevar al peligro de personas.
24. No utilice el producto bajo condiciones en las que pueda producirse y se hayan producido líquidos de condensación en o dentro del producto como por ejemplo cuando se desplaza el producto de un lugar frío a un lugar caliente.
25. Por favor no cierre ninguna ranura u orificio del producto, ya que estas son necesarias para la ventilación e impiden que el producto se caliente demasiado. No pongan el producto encima de materiales blandos como por ejemplo sofás o alfombras o dentro de una caja cerrada, si esta no está suficientemente ventilada.
26. No ponga el producto sobre aparatos que produzcan calor, como por ejemplo radiadores o calentadores. La temperatura ambiental no debe superar la temperatura máxima especificada en la hoja de datos.

## Informaciones de seguridad

27. Baterías y acumuladores no deben de ser expuestos a temperaturas altas o al fuego. Guardar baterías y acumuladores fuera del alcance de los niños. Si las baterías o los acumuladores no son cambiados con la debida atención existirá peligro de explosión (atención celulas de Litio). Cambiar las baterías o los acumuladores solamente por los del tipo R&S correspondiente (ver lista de piezas de recambio). Baterías y acumuladores son deshechos problemáticos. Por favor tirenlos en los recipientes especiales para este fin. Por favor tengan en cuenta las prescripciones nacionales de cada país referente al tratamiento de deshechos. Nunca sometan las baterías o acumuladores a un corto circuito.
28. Tengan en consideración de que en caso de un incendio pueden escaparse gases tóxicos del producto, que pueden causar daños a la salud.
29. Por favor tengan en cuenta que en caso de un incendio pueden desprenderse del producto agentes venenosos (gases, líquidos etc.) que pueden generar daños a la salud.
30. No sitúe el producto encima de superficies, vehículos, estantes o mesas, que por sus características de peso o de estabilidad no sean aptas para él. Siga siempre las instrucciones de instalación del fabricante cuando instale y asegure el producto en objetos o estructuras (por ejemplo paredes y estantes).
31. Las asas instaladas en los productos sirven solamente de ayuda para el manejo que solamente está previsto para personas. Por eso no está permitido utilizar las asas para la sujecion en o sobre medios de transporte como por ejemplo grúas, carretillas elevadoras de horquilla, carros etc. El usuario es responsable de que los productos sean sujetados de forma segura a los medios de transporte y de que las prescripciones de seguridad del fabricante de los medios de transporte sean tenidas en cuenta. En caso de que no se tengan en cuenta pueden causarse daños en personas y objetos.
32. Si llega a utilizar el producto dentro de un vehículo, queda en la responsabilidad absoluta del conductor que conducir el vehículo de manera segura. Asegure el producto dentro del vehículo debidamente para evitar en caso de un accidente las lesiones u otra clase de daños. No utilice nunca el producto dentro de un vehículo en movimiento si esto pudiera distraer al conductor. Siempre queda en la responsabilidad absoluta del conductor la seguridad del vehículo y el fabricante no asumirá ninguna clase de responsabilidad por accidentes o colisiones.
33. Dado el caso de que esté integrado un producto de laser en un producto R&S (por ejemplo CD/DVD-ROM) no utilice otras instalaciones o funciones que las descritas en la documentación. De otra manera pondrá en peligro su salud, ya que el rayo laser puede dañar irreversiblemente sus ojos. Nunca trate de descomponer estos productos. Nunca mire dentro del rayo laser.



### Qualitätszertifikat

Sehr geehrter Kunde,

Sie haben sich für den Kauf eines Rohde & Schwarz-Produktes entschieden. Hiermit erhalten Sie ein nach modernsten Fertigungsmethoden hergestelltes Produkt. Es wurde nach den Regeln unseres Qualitätsmanagementsystems entwickelt, gefertigt und geprüft. Das Rohde & Schwarz-Qualitätsmanagementsystem ist u.a. nach ISO 9001 und ISO 14001 zertifiziert.

### Certificate of quality

Dear Customer,

You have decided to buy a Rohde & Schwarz product. You are thus assured of receiving a product that is manufactured using the most modern methods available. This product was developed, manufactured and tested in compliance with our quality management system standards. The Rohde & Schwarz quality management system is certified according to standards such as ISO 9001 and ISO 14001.

### Certificat de qualité

Cher client,

Vous avez choisi d'acheter un produit Rohde & Schwarz. Vous disposez donc d'un produit fabriqué d'après les méthodes les plus avancées. Le développement, la fabrication et les tests respectent nos normes de gestion qualité. Le système de gestion qualité de Rohde & Schwarz a été homologué, entre autres, conformément aux normes ISO 9001 et ISO 14001.



**ROHDE & SCHWARZ**



Certificate No.: 2002-36

This is to certify that:

Equipment type	Stock No.	Designation
NRP	1143.8500.02	Power Meter
NRP-B1	1146.9008.02	Sensor Check Source
NRP-B2	1146.8801.02	Second Sensor Input
NRP-B5	1146.9608.02	3rd und 4th Sensor
NRP-B6	1146.9908.02	Rear-Panel Sensor
NRP-Z3	1146.7005.02	USB Adapter
NRP-Z4	1146.8001.02	USB Adapter
NRP-Z11	1138.3004.02	Average Power Sensor
NRP-Z21	1137.6000.02	Average Power Sensor
NRP-Z22	1137.7506.02	Average Power Sensor
NRP-Z23	1137.8002.02	Average Power Sensor
NRP-Z24	1137.8502.02	Average Power Sensor
NRP-Z51	1138.0005.02	Thermal Power Sensor
NRP-Z55	1138.2008.02	Thermal Power Sensor

complies with the provisions of the Directive of the Council of the European Union on the approximation of the laws of the Member States

- relating to electrical equipment for use within defined voltage limits (73/23/EEC revised by 93/68/EEC)
- relating to electromagnetic compatibility (89/336/EEC revised by 91/263/EEC, 92/31/EEC, 93/68/EEC)

Conformity is proven by compliance with the following standards:

EN61010-1 : 1993 + A2 : 1995  
 EN55011 : 1998 + A1 : 1999  
 EN61326 : 1997 + A1 : 1998 + A2 : 2001

For the assessment of electromagnetic compatibility, the limits of radio interference for Class B equipment as well as the immunity to interference for operation in industry have been used as a basis.

Affixing the EC conformity mark as from 2002

Munich, 2003-11-13

**ROHDE & SCHWARZ GmbH & Co. KG**  
**Mühldorfstr. 15, D-81671 München**  
 Central Quality Management FS-QZ / Becker

---

# Support Center

**Telefon / Telephone:** +49 (0)180 512 42 42

**Fax:** +49 89 41 29 137 77

**E-mail:** [CustomerSupport@rohde-schwarz.com](mailto:CustomerSupport@rohde-schwarz.com)

---

Für technische Fragen zu diesem Rohde & Schwarz-Gerät steht Ihnen die Hotline der Rohde & Schwarz Vertriebs-GmbH, Support Center, zur Verfügung.

Unser Team bespricht mit Ihnen Ihre Fragen und sucht Lösungen für Ihre Probleme.

Die Hotline ist Montag bis Freitag von 8.00 bis 17.00 Uhr MEZ besetzt.

Bei Anfragen außerhalb der Geschäftszeiten hinterlassen Sie bitte eine Nachricht oder senden Sie eine Notiz per Fax oder E-Mail. Wir setzen uns dann baldmöglichst mit Ihnen in Verbindung.



Um Ihr Gerät stets auf dem neuesten Stand zu halten, abonnieren Sie bitte Ihren persönlichen Newsletter unter

<http://www.rohde-schwarz.com/www/response.nsf/newsletterpreselection>.

Sie erhalten dann regelmäßig Informationen über Rohde & Schwarz-Produkte Ihrer Wahl, über Firmware-Erweiterungen, neue Teiler und Applikationsschriften.

Should you have any technical questions concerning this Rohde & Schwarz product, please contact the hotline of Rohde & Schwarz Vertriebs-GmbH, Support Center.

Our hotline team will answer your questions and find solutions to your problems.

You can reach the hotline Monday through Friday from 8:00 until 17:00 CET.

If you need assistance outside office hours, please leave a message or send us a fax or e-mail. We will contact you as soon as possible.



To keep your instrument always up to date, please subscribe to your personal newsletter at

<http://www.rohde-schwarz.com/www/response.nsf/newsletterpreselection>.

As a subscriber, you will receive information about your selection of Rohde & Schwarz products, about firmware extensions, new drivers and application notes on a regular basis.



**ROHDE & SCHWARZ**

# Adressen/Addresses

FIRMENSITZ/HEADQUARTERS	Phone Fax E-mail	Zweigniederlassung Süd, Geschäftsstelle München Mühlendorfstraße 15 · D-81671 München Postfach 80 14 69 · D-81614 München	+49 (89) 41 86 95-0 +49 (89) 40 47 64 -
Rohde & Schwarz GmbH & Co. KG Mühlendorfstraße 15 · D-81671 München Postfach 80 14 69 · D-81614 München	+49 (89) 41 29-0 +49 89 4129-121 64 -	Zweigniederlassung Süd, Geschäftsstelle Nürnberg Donaustraße 36 D-90451 Nürnberg	+49 (911) 642 03-0 +49 (911) 642 03-33 -
WERKE/PLANTS		Zweigniederlassung Mitte, Geschäftsstelle Neu-Isenburg Siemensstraße 20 D-63263 Neu-Isenburg	+49 (6102) 20 07-0 +49 (6102) 20 07 12 -
Rohde & Schwarz Messgerätebau GmbH Riedbachstraße 58 · D-87700 Memmingen Postfach 1652 · D-87686 Memmingen	+49 (8331) 108-0 +49 (8331) 108-11 24 -	ADRESSEN WELTWEIT/ADDRESSES WORLDWIDE	
Rohde & Schwarz GmbH & Co. KG Werk Teisnach Kaikenrieder Straße 27 · D-94244 Teisnach Postfach 1149 · D-94240 Teisnach	+49 (9923) 857-0 +49 (9923) 857-11 74 -	<b>Albania</b>	siehe / see Austria
Rohde & Schwarz GmbH & Co. KG Dienstleistungszentrum Köln Graf-Zeppelin-Straße 18 · D-51147 Köln Postfach 98 02 60 · D-51130 Köln	+49 (2203) 49-0 +49 (2203) 49 51-308 info@rsdc.rohde-schwarz.com service@rsdc.rohde-schwarz.com	<b>Algeria</b>	ROHDE & SCHWARZ Bureau d'Alger 5B Place de Laperrine 16035 Hydra-Alger
TOCHTERUNTERNEHMEN/SUBSIDIARIES		<b>Argentina</b>	PRECISION ELECTRONICA S.R.L. Av. Pde Julio A. Roca 710 - 6° Piso (C1067ABP) Buenos Aires
Rohde & Schwarz Vertriebs-GmbH Mühlendorfstraße 15 · D-81671 München Postfach 80 14 69 · D-81614 München	+49 (89) 41 29-137 74 +49 (89) 41 29-137 77 -		+541 (14) 331 41 99 +541 (14) 334 51 11 alberto_lombardi@prec-elec.com.ar
Rohde & Schwarz International GmbH Mühlendorfstraße 15 · D-81671 München Postfach 80 14 60 · D-81614 München	+49 (89) 41 29-129 84 +49 (89) 41 29-120 50 -	<b>Australia</b>	ROHDE & SCHWARZ (AUSTRALIA) Pty. Ltd. Sales Support Unit 6 2-8 South Street Rydalmere, N.S.W. 2116
Rohde & Schwarz Engineering and Sales GmbH Mühlendorfstraße 15 · D-81671 München Postfach 80 14 29 · D-81614 München	+49 (89) 41 29-137 11 +49 (89) 41 29-137 23 -	<b>Austria</b>	ROHDE & SCHWARZ-ÖSTERREICH Ges.m.b.H. Am Euro Platz 3 Gebäude B 1120 Wien
R&S BICK Mobilfunk GmbH Fritz-Hahne-Str. 7 · D-31848 Bad Münder Postfach 2062 · D-31844 Bad Münder	+49 (5042) 998-0 +49 (5042) 998-105 -		+43 (1) 602 61 41-0 +43 (1) 602 61 41-14 office@rsoe.rohde-schwarz.com
Rohde & Schwarz FTK GmbH Wendenschlossstraße 168, Haus 28 D-12557 Berlin	+49 (30) 658 91-122 +49 (30) 655 50-221 -	<b>Azerbaijan</b>	ROHDE & SCHWARZ Azerbaijan Liaison Office Baku ISR Plaza 340 Nizami Str. 370000 Baku
Rohde & Schwarz SIT GmbH Agastraße 3 D-12489 Berlin	+49 (30) 658 84-0 +49 (30) 658 84-183 -	<b>Baltic Countries</b>	siehe / see Denmark
ADRESSEN DEUTSCHLAND/ADDRESSES GERMANY		<b>Bangladesh</b>	BIL Consortium Ltd. Corporation Office House No: 95/A, Block - 'F' Road No. 4, Banani Dhaka-1213
Rohde & Schwarz Vertriebs-GmbH Mühlendorfstraße 15 · D-81671 München Postfach 80 14 69 · D-81614 München	+49 89 4129-133 74 +4989 4129-133 77 -		+994 (12) 93 31 38 +994 (12) 93 03 14 RS-Azerbaijan@RUS.Rohde-Schwarz.com
Zweigniederlassungen der Rohde & Schwarz Vertriebs-GmbH/Branch offices of Rohde & Schwarz Vertriebs-GmbH		<b>Belgium</b>	ROHDE & SCHWARZ BELGIUM N.V. Excelsiorlaan 31 Bus 1 1930 Zaventem
Zweigniederlassung Nord, Geschäftsstelle Berlin Ernst-Reuter-Platz 10 · D-10587 Berlin Postfach 100620 · D-10566 Berlin	+49 (30) 34 79 48-0 +49 (30) 34 79 48 48 -		+32 (2) 721 50 02 +32 (2) 725 09 36 info@rsb.rohde-schwarz.com
Zweigniederlassung Büro Bonn Josef-Wirmer-Straße 1-3 · D-53123 Bonn Postfach 140264 · D-53057 Bonn	+49 (228) 918 90-0 +49 (228) 25 50 87 -	<b>Brasil</b>	ROHDE & SCHWARZ DO BRASIL LTDA. Av. Alfredo Egidio de Souza Aranha n° 177, 1° andar - Santo Amaro 04726-170 Sao Paulo - SP
Zweigniederlassung Nord, Geschäftsstelle Hamburg Steilshooper Alle 47 · D-22309 Hamburg Postfach 60 22 40 · D-22232 Hamburg	+49 (40) 63 29 00-0 +49 (40) 630 78 70 -		+55 (11) 56 44 86 11 (general) +55 (11) 56 44 86 25 (sales) +55 (11) 56 44 86 36 sales-brazil@rsdb.rohde-schwarz.com
Zweigniederlassung Mitte, Geschäftsstelle Köln Niederlassener Straße 33 · D-51147 Köln Postfach 900 149 · D-51111 Köln	+49 (2203) 807-0 +49 (2203) 807-650 -	<b>Brunei</b>	GKL Equipment PTE. Ltd. Jurong Point Post Office P.O.Box 141 Singapore 916405
		<b>Bulgaria</b>	ROHDE & SCHWARZ ÖSTERREICH Representation Office Bulgaria 39, Fridtjof Nansen Blvd. 1000 Sofia
		<b>Bosnia-Herzegovina</b>	siehe / see Slovenia



# Adressen/Addresses

<b>Canada</b>	ROHDE & SCHWARZ CANADA Inc. 555 March Rd. Kanata, Ontario K2K 2M5	+1 (613) 592 80 00 +1 (613) 592 80 09 cgirwarnauth@rscanada.ca	<b>Denmark</b>	ROHDE & SCHWARZ DANMARK A/S Ejby Industrivej 40 2600 Glostrup	+45 (43) 43 66 99 +45 (43) 43 77 44
<b>Canada</b>	TEKTRONIX CANADA Inc. Test and Measurement 4929 Place Olivia Saint-Laurent, Pq  Montreal H4R 2V6	+1 (514) 331 43 34 +1 (514) 331 59 91	<b>Ecuador</b>	REPRESENTACIONES MANFRED WEINZIERL Vía Láctea No. 4 y Vía Sta. Inés P.O.Box 17-22-20309 1722 Cumbayá-Quito	+593 (22) 89 65 97 +593 (22) 89 65 97 mweinzierl@accessinter.net
<b>Chile</b>	DYMEQ Ltda. Av. Larrain 6666 Santiago	+56 (2) 339 20 00 +56 (2) 339 20 10 dnussbaum@dymeq.com	<b>Egypt</b>	U.A.S. Universal Advanced Systems 31 Manshiet El-Bakry Street Heliopolis 11341 Cairo	+20 (2) 455 67 44 +20 (2) 256 17 40 an_uas@link.net
<b>China</b>	ROHDE & SCHWARZ China Ltd. Representative Office Shanghai Central Plaza 227 Huangpi North Road RM 807/809 Shanghai 200003	+86 (21) 63 75 00 18 +86 (21) 63 75 91 70	<b>El Salvador</b>	siehe / see Mexico	
<b>China</b>	ROHDE & SCHWARZ China Ltd. Representative Office Beijing Room 602, Parkview Center 2 Jiangtai Road Chao Yang District Beijing 100016	+86 (10) 64 31 28 28 +86 (10) 64 37 98 88 info.rschina@rsbp.rohde- schwarz.com	<b>Estonia</b>	ROHDE & SCHWARZ DANMARK A/S Estonian Branch Office Narva mnt. 13 10151 Tallinn	+372 (6) 14 31 23 +372 (6) 14 31 21 margo.fingling@rsdk.rohde- schwarz.com
<b>China</b>	ROHDE & SCHWARZ China Ltd. Representative Office Guangzhou Room 2903, Metro Plaza 183 Tianhe North Road Guangzhou 510075	+86 (20) 87 55 47 58 +86 (20) 87 55 47 59	<b>Finland</b>	Orbis Oy P.O.Box 15 00421 Helsinki 42	+358 (9) 47 88 30 +358 (9) 53 16 04 info@orbis.fi
<b>China</b>	ROHDE & SCHWARZ China Ltd. Representative Office Chengdu Unit G, 28/F, First City Plaza 308 Shuncheng Avenue Chengdu 610017	+86 (28) 86 52 76 05 to 09 +86 (28) 86 52 76 10 rsbpc@mail.sc.cninfo.net	<b>France</b>	ROHDE & SCHWARZ FRANCE Immeuble "Le Newton" 9-11, rue Jeanne Braconnier 92366 Meudon La Forêt Cédex	+33 (1) 41 36 10 00 +33 (1) 41 36 11 73
<b>China</b>	ROHDE & SCHWARZ China Ltd. Unit 3115 31/F Entertainment Building 30 Queen's Road Central Hongkong	+85 (2) 21 68 06 70 +85 (2) 21 68 08 99	<b>France</b>	Niederlassung/Subsidiary Rennes 37 Rue du Bignon Bât. A F-35510 Cesson Sevigne	+33 (0) 299 51 97 00 +33 (0) 299 51 98 77 -
<b>China</b>	ROHDE & SCHWARZ China Ltd. Representative Office Xi'an Room 10125, Jianguo Hotel Xi'an No. 2, Huzhu Road Xi'an 710048	+86 (29) 321 82 33 +86 (29) 329 60 15 sherry.yu@rsbp.rohde-schwarz.com	<b>France</b>	Niederlassung/Subsidiary Toulouse Technoparc 3 B.P. 501 F-31674 Labège Cédex	+33 (0) 561 39 10 69 +33 (0) 561 39 99 10 -
<b>China</b>	Shanghai ROHDE & SCHWARZ Communication Technology Co.Ltd. Central Plaza, Unit 809 227 Huangpi North Road Shanghai 200003		<b>France</b>	Aix-en-Provence	+33 (0) 494 07 39 94 +33 (0) 494 07 55 11 -
<b>China</b>	Beijing ROHDE & SCHWARZ Communication Technology Co.Ltd. Room 106, Parkview Centre No. 2, Jiangtai Road Chao Yang District Beijing 100016	+86 (10) 64 38 80 80 +86 (10) 64 38 97 06	<b>France</b>	Office Lyon	+33 (0) 478 29 88 10 +33 (0) 478 79 18 57
<b>Croatia</b>	siehe / see Slovenia		<b>France</b>	Office Nancy	+33 (0) 383 54 51 29 +33 (0) 383 54 82 09
<b>Cyprus</b>	HINIS TELECAST LTD. Agiou Thoma 18 Kiti  Larnaca 7550	+357 (24) 42 51 78 +357 (24) 42 46 21 hinis@logos.cy.net	<b>Ghana</b>	KOP Engineering Ltd. P.O. Box 11012 3rd Floor Akai House, Osu Accra North	+233 (21) 77 89 13 +233 (21) 701 06 20
<b>Czech Republic</b>	ROHDE & SCHWARZ - Praha s.r.o. Hadovka Office Park Evropská 33c 16000 Praha 6	+420 (2) 24 31 12 32 +420 (2) 24 31 70 43 office@rscz.rohde-schwarz.com	<b>Greece</b>	MERCURY S.A. 6, Loukianou Str. 10675 Athens	+302 (10) 722 92 13 +302 (10) 721 51 98 mercury@hol.gr
			<b>Guatemala</b>	siehe / see Mexico	
			<b>Honduras</b>	siehe / see Mexico	
			<b>Hongkong</b>	Electronic Scientific Engineering 36/F Dorset House, Taikoo Place 979 King's Road Quarry Bay Hong Kong	+852 (25) 07 03 33 +852 (25) 07 09 25 stephenchau@ese.com.hk
			<b>Hungary</b>	ROHDE & SCHWARZ Budapesti Iroda Váci út 169 1138 Budapest	+36 (1) 412 44 60 +36 (1) 412 44 61 rohdehu@rsoe.rohde-schwarz.com
			<b>Iceland</b>	siehe / see Denmark	

# Adressen/Addresses

<b>India</b>	ROHDE & SCHWARZ India Pvt. Ltd. Bangalore Office No. 24, Service Road, Domlur 2nd Stage Extension Bangalore - 560 071	+91 (80) 535 23 62 +91 (80) 535 03 61 rsindiab@rsnl.net	<b>Kenya</b>	Excel Enterprises Ltd Dunga Road P.O.Box 42 788 Nairobi	+254 (2) 55 80 88 +254 (2) 54 46 79
<b>India</b>	ROHDE & SCHWARZ India Pvt. Ltd. Hyderabad Office 302 & 303, Millenium Centre 6-3-1099/1100, Somajiguda  Hyderabad - 500 016	+91 (40) 23 32 24 16 +91 (40) 23 32 27 32 rsindiah@nd2.dot.net.in	<b>Korea</b>	ROHDE & SCHWARZ Korea Ltd. 83-29 Nonhyun-Dong, Kangnam-Ku  Seoul 135-010	+82 (2) 514 45 46 +82 (2) 514 45 49 sales@rskor.rohde-schwarz.com service@rskor.rohde-schwarz.com
<b>India</b>	ROHDE & SCHWARZ India Pvt. Ltd. 244, Okhla Industrial Estate, Phase-III New Delhi 110020	+91 (11) 26 32 63 81 +91 (11) 26 32 63 73 sales@rsindia.rohde-schwarz.com services@rsindia.rohde-schwarz.com	<b>Kuwait</b>	Group Five Trading & Contracting Co. Mezanine Floor Al-Bana Towers Ahmad Al Jaber Street Sharq	+965 (244) 91 72/73/74 +965 (244) 95 28 jk_agarwal@yahoo.com
<b>India</b>	ROHDE & SCHWARZ India Pvt. Ltd. RS India Mumbai Office B-603, Remi Bizcourt, Shah Industrial Estate, Off Veera Desai Road Mumbai - 400 058	+91 (22) 26 30 18 10 +91 (22) 26 32 63 73 rsindiam@rsnl.net	<b>Latvia</b>	ROHDE & SCHWARZ DANMARK A/S Latvian Branch Office Merkela iela 21-301 1050 Riga	+371 (7) 50 23 55 +371 (7) 50 23 60 rsdk@rsdk.rohde-schwarz.com
<b>Indonesia</b>	PT ROHDE & SCHWARZ Indonesia  Graha Paramita 5th Floor Jln. Denpasar Raya Blok D-2  Jakarta 12940	+62 (21) 252 36 08 +62 (21) 252 36 07 sales@rsbj.rohde-schwarz.com services@rsbj.rohde-schwarz.com	<b>Lebanon</b>	ROHDE & SCHWARZ Liaison Office c/o Haji Abdullah Alireza Co. Ltd. P.O.Box 361 Riyadh 11411	+966 (1) 465 64 28 Ext. 303 +966 (1) 465 64 28 Ext. 229 chris.porzky@rsd.rohde-schwarz.com
<b>Iran</b>	ROHDE & SCHWARZ IRAN  Groundfloor No. 1, 14th Street Khaled Eslamboli (Vozara) Ave. 15117 Tehran	+98 (21) 872 42 96 +98 (21) 871 90 12 rs-tehran@neda.net	<b>Lebanon</b>	Netcom	
<b>Ireland</b>	siehe / see United Kingdom		<b>Liechtenstein</b>	siehe / see Switzerland	
<b>Israel</b>	EASTRONICS LTD. Messtechnik / T&M Equipment 11 Rozanis St. P.O.Box 39300 Tel Aviv 61392	+972 (3) 645 87 77 +972 (3) 645 86 66 david_hasky@easx.co.il	<b>Lithuania</b>	ROHDE & SCHWARZ DANMARK A/S Lithuanian Office Lukiskiu 5-228 2600 Vilnius	+370 (5) 239 50 10 +370 (5) 239 50 11
<b>Israel</b>	J.M. Moss (Engineering) Ltd. Kommunikationstechnik/ Communications Equipment 9 Oded Street P.O.Box 967 52109 Ramat Gan	+972 (3) 631 20 57 +972 (3) 631 40 58 jmoss@zahav.net.il	<b>Luxembourg</b>	siehe / see Belgium	
<b>Italy</b>	ROHDE & SCHWARZ ITALIA S.p.a. Centro Direzionale Lombardo Via Roma 108 20060 Cassina de Pecchi (MI)	+39 (02) 95 70 42 03 +39 (02) 95 30 27 72 ornella.crippa@rsi.rohde-schwarz.com	<b>Macedonia</b>	siehe / see Slovenia	
<b>Italy</b>	ROHDE & SCHWARZ ITALIA S.p.a. Via Tiburtina 1182 00156 Roma	+39 (06) 41 59 82 18 +39 (06) 41 59 82 70	<b>Malaysia</b>	DAGANG TEKNIK SDN. BHD. No. 9, Jalan SS 4D/2 Selangor Darul Ehsan  47301 Petaling Jaya	+60 (3) 27 03 55 68 +60 (3) 27 03 34 39 mey.nara@danik.com.my
<b>Japan</b>	ADVANTEST Corporation RS Sales Department 1-32-1, Asahi-cho Nerima-ku Tokyo 179-0071	+81 (3) 39 30 41 90 +81 (3) 39 30 41 86 RSSales@advantest.co.jp	<b>Malta</b>	ITEC International Technology Ltd B'Kara Road San Gwann SGN 08	+356 (21) 37 43 00 or 37 43 29 +356 (21) 37 43 53 sales@itec.com.mt
<b>Jordan</b>	Jordan Crown Engineering & Trading Co.  Jabal Amman, Second Circle Youssef Ezzideen Street P.O.Box 830414 Amman, 11183	+962 (6) 462 17 29 +962 (6) 465 96 72 jocrown@go.com.jo	<b>Mexico</b>	Rohde & Schwarz de Mexico (RSMX) S. de R.L. de C.V. German Centre Oficina 4-2-2 Av. Santa Fé 170 Col. Lomas de Santa Fé 01210 Mexico D.F.	+52 (55) 85 03 99 13 +52 (55) 85 03 99 16 latinoamerica@rsd.rohde-schwarz.com
<b>Kazakhstan</b>	ROHDE & SCHWARZ Kazakhstan Representative Office Almaty Pl. Respubliki 15 480013 Almaty	+7 (32) 72 63 55 55 +7 (32) 72 63 46 33 RS-Kazakhstan@RUS-Rohde-Schwarz.com	<b>Mexico</b>	Rohde & Schwarz de Mexico (RSMX) Av. Prof. Americas No. 1600, 2° Piso Col. Country Club Guadalajara, Jal. Mexico CP, 44610	+52 (33) 36 78 91 70 +52 (33) 36 78 92 00
			<b>Moldavia</b>	siehe / see Romania	
			<b>Netherlands</b>	ROHDE & SCHWARZ NEDERLAND B.V. Perkinsbaan 1 3439 ND Nieuwegein	+31 (30) 600 17 00 +31 (30) 600 17 99 info@rsn.rohde-schwarz.com
			<b>New Zealand</b>	Nichecom 1 Lincoln Ave.  Tawa, Wellington	+64 (4) 232 32 33 +64 (4) 232 32 30 rob@nichecom.co.nz
			<b>Nicaragua</b>	siehe / see Mexico	
			<b>Nigeria</b>	Ferrostaal Abuja Plot 3323, Barada Close P.O.Box 8513, Wuse Off Amazon Street Maitama, Abuja	+234 (9) 413 52 51 +234 (9) 413 52 50 fsabuja@rosecom.net

# Adressen/Addresses

<b>Norway</b>	ROHDE & SCHWARZ NORGE AS Enebakkveien 302 B 1188 Oslo	+47 (23) 38 66 00 +47 (23) 38 66 01	<b>Spain</b>	ROHDE & SCHWARZ ESPANA S.A. Salcedo, 11  28034 Madrid	+34 (91) 334 10 70 +34 (91) 329 05 06  rses@rses-rohde-schwarz.com
<b>Oman</b>	Mustafa Sultan Science & Industry Co.LLC. For Test & Measurement ONLY Way No. 3503 Building No. 241 Postal Code 112 Al Khuwair, Muscat	+968 636 000 +968 607 066 m-aziz@mustafasultan.com	<b>Sri Lanka</b>	LANKA AVIONICS 658/1/1, Negombo Road Mattumagala Ragama	+94 (1) 95 66 78 +94 (1) 95 83 11 lankavio@sltnet.lk
<b>Pakistan</b>	Siemens Pakistan 23, West Jinnah Avenue Islamabad	+92 (51) 227 22 00 +92 (51) 227 54 98 reza.bokhary@siemens.com.pk	<b>Sudan</b>	SolarMan Co. Ltd. P.O.Box 11 545 North of Fraouq Cementry 6/7/9 Bldg. 16 Karthoum	+249 (11) 47 31 08 +249 (11) 47 31 38 solarman29@hotmail.com
<b>Panama</b>	siehe / see Mexico		<b>Sweden</b>	ROHDE & SCHWARZ SVERIGE AB Marketing Div. Flygfältsgatan 15 128 30 Skarpnäck	+46 (8) 605 19 00 +46 (8) 605 19 80 info@rss.se
<b>Papua-New Guinea</b>	siehe / see Australia		<b>Switzerland</b>	Roschi Rohde & Schwarz AG Mühlestr. 7 3063 Ittigen	+41 (31) 922 15 22 +41 (31) 921 81 01 sales@roschi.rohde-schwarz.com
<b>Philippines</b>	MARCOM INDUSTRIAL EQUIPMENT, Inc. 6-L Vernida I Condominium 120 Amorsolo St. Legaspi Village Makati City/ Philippines 1229	+63 (2) 813 29 31 +63 (2) 810 58 07 marcom@i-next.net	<b>Syria</b>	Electro Scientific Office  Baghdad Street Dawara Clinical Lab. Bldg P.O.Box 8162 Damascus	+963 (11) 231 59 74 +963 (11) 231 88 75 memo@hamshointl.com
<b>Poland</b>	ROHDE & SCHWARZ Österreich SP.z o.o. Przedstawicielstwo w Polsce ul. Stawki 2, Pietro 28 00-193 Warszawa	+48 (22) 860 64 94 +48 (22) 860 64 99 rohdepl@rsoe.rohde-schwarz.com	<b>Taiwan</b>	Lancer Communication Co. Ltd. for Div. 1 and 7 16F, No. 30, Pei-Ping East Road Taipei	+886 (2) 23 91 10 02 +886 (2) 23 95 82 82 info@lancercomm.com.tw
<b>Portugal</b>	Rohde & Schwarz Portugal, Lda.  Alameda Antonio Sergio, n° 7 R/C, Sala A 2795-023 Linda-a-Velha	+351 (21) 415 57 00 +351 (21) 415 57 10 telerus@mail.telepac.pt	<b>Taiwan</b>	System Communication Co. Ltd. for Div. 2 and 8 16F, No. 30, Pei-Ping East Road Taipei	+886 (2) 23 91 10 02 +886 (2) 23 95 82 82 info@lancercomm.com.tw
<b>Romania</b>	ROHDE & SCHWARZ Representation Office Bucharest Str. Uranus 98 Sc. 2, Et. 5, Ap. 36 76102 Bucuresti, Sector 5	+40 (21) 410 68 46 +40 (21) 411 20 13 rohdero@rsoe.rohde-schwarz.com	<b>Tanzania</b>	SSTL Group P.O. Box 7512 Dunga Street Plot 343/345 Dar es Salaam	+255 (22) 276 00 37 +255 (22) 276 02 93 sstl@twiga.com
<b>Russian Federation</b>	ROHDE & SCHWARZ Representative Office Moscow 119180, Yakimanskaya nab., 2 Moscow	+7 (095) 745 88 50 to 53 +7 (095) 745 88 54 rs-russia@rsru.rohde-schwarz.com	<b>Thailand</b>	Schmidt Electronics (Thailand) Ltd. 63 Government Housing Bank Bldg. Tower II, 19th floor, Rama 9 Rd. Huaykwang, Bangkapi Bangkok 10320	+66 (2) 643 13 30 to 39 +66 (2) 643 13 40 kamthoninthuyot@schmidttailand.com
<b>Saudi Arabia</b>	Mr. Chris Porzky ROHDE & SCHWARZ International GmbH c/o Haji Abdullah Alireza Co. Ltd. P.O.Box 361 Riyadh 11411	+966 (1) 465 64 28 Ext. 303 +966 (1) 465 6428 Ext. 229 chris.porzky@rsd.rohde-schwarz.com	<b>Thailand</b>	TPP Operation Co., Ltd. 41/5 Mooban Tarinee Boromrajchonnee Road Talingchan, Bangkok 10170	+66 (2) 880 93 47 +66 (2) 880 93 47 thipsukon@tpp-operation.com
<b>Saudi Arabia</b>	GENTEC		<b>Trinidad &amp; Tobago</b>	siehe / see Mexico	
<b>Serbia-Montenegro</b>	Representative Office Belgrade Tose Jovanovica 7 11030 Beograd	+381 (11) 305 50 25 +381 (11) 305 50 24	<b>Tunisia</b>	TELETEK 71, Rue Alain Savary Residence Alain Savary (C64) 1003 Tunis	
<b>Slovak Republic</b>	Specialne systémy a software, a.s. Svrčia ul. 841 04 Bratislava	+421 (2) 65 42 24 88 +421 (2) 65 42 07 68 stefan.lozek@special.sk	<b>Turkey</b>	ROHDE & SCHWARZ International GmbH Liaison Office Istanbul Bagdad Cad. 191/3, Arda Apt. B-Blok 81030 Selamicesme-Istanbul	+90 (216) 385 19 17 +90 (216) 385 19 18 rsturk@superonline.com
<b>Slovenia</b>	ROHDE & SCHWARZ Representation Ljubljana Tbilisijska 89 1000 Ljubljana	+386 (1) 423 46 51 +386 (1) 423 46 11 rohdesi@rsoe.rohde-schwarz.com	<b>Ukraine</b>	ROHDE & SCHWARZ Representative Office Kiev 4, Patris Loumoumba ul 01042 Kiev	+38 (044) 268 60 55 +38 (044) 268 83 64 rohdeukr@rsoe.rohde-schwarz.com
<b>South Africa</b>	Protea Data Systems (Pty.) Ltd. Communications and Measurement Division Private Bag X19 Bramley 2018	+27 (11) 719 57 00 +27 (11) 786 58 91 unicm@protea.co.za	<b>United Arab Emirates</b>	ROHDE & SCHWARZ International GmbH Liaison Office Abu Dhabi P.O. Box 31156 Abu Dhabi	+971 (2) 633 56 70 +971 (2) 633 56 71 michael.rogler@rsd.rohde-schwarz.com
<b>South Africa</b>	Protea Data Systems (Pty.) Ltd. Cape Town Branch Unit G9, Centurion Business Park Bosmandam Road Milnerton Cape Town, 7441	+27 (21) 555 36 32 +27 (21) 555 42 67 unicm@protea.co.za			

# Adressen/Addresses

---

<b>United Arab Emirates</b>	ROHDE & SCHWARZ Bick Mobile Communication P.O.Box 17466  Dubai	+971 (4) 883 71 35 +971 (4) 883 71 36 www.rsbeck.de
<b>United Arab Emirates</b>	ROHDE & SCHWARZ Emirates L.L.C. Ahmed Al Nasri Building, Mezzanine Floor, P.O.Box 31156 Off old Airport Road Behind new GEMACO Furniture Abu Dhabi	+971 (2) 631 20 40 +971 (2) 631 30 40 rsuaeam@emirates.net.ae
<b>United Kingdom</b>	ROHDE & SCHWARZ UK Ltd. Ancells Business Park Fleet Hampshire GU 51 2UZ England	+44 (1252) 81 88 88 (sales) +44 (1252) 81 88 18 (service) +44 (1252) 81 14 47 sales@rsuk.rohde-schwarz.com
<b>Uruguay</b>	AEROMARINE S.A. Cerro Largo 1497 11200 Montevideo	+598 (2) 400 39 62 +598 (2) 401 85 97 mjin@aeromarine.com.uy
<b>USA</b>	ROHDE & SCHWARZ, Inc. Broadcast & Comm. Equipment (US Headquarters) 7150-K Riverwood Drive Columbia, MD 21046	+1 (410) 910 78 00 +1 (410) 910 78 01 rsatv@rsa.rohde-schwarz.com rsacomms@rsa.rohde-schwarz.com
<b>USA</b>	Rohde & Schwarz Inc. Marketing & Support Center / T&M Equipment 2540 SW Alan Blumlein Way M/S 58-925 Beaverton, OR 97077-0001	+1 (503) 627 26 84 +1 (503) 627 25 65 info@rsa.rohde-schwarz.com
<b>USA</b>	Rohde & Schwarz Inc. Systems & EMI Products 8080 Tristar Drive Suite 120 Irving, Texas 75063	+1 (469) 713 53 00 +1 (469) 713 53 01 info@rsa.rohde-schwarz.com
<b>Venezuela</b>	EQUILAB TELECOM C.A. Centro Seguros La Paz Piso 6, Local E-61 Ava. Francisco de Miranda Boleita, Caracas 1070	+58 (2) 12 34 46 26 +58 (2) 122 39 52 05 r_ramirez@equilabtelecom.com
<b>Venezuela</b>	REPRESENTACIONES BOPIC S.A. Calle C-4 Qta. San Jose Urb. Caurimare Caracas 1061	+58 (2) 129 85 21 29 +58 (2) 129 85 39 94 incotr@cantv.net
<b>Vietnam</b>	Schmidt Vietnam Co., (H.K.) Ltd., Representative Office in Hanoi Intern. Technology Centre 8/F, HITC Building 239 Xuan Thuy Road Cau Giay, Tu Liem Hanoi	+84 (4) 834 61 86 +84 (4) 834 61 88 svnhn@schmidtgroup.com
<b>West Indies</b>	siehe / see Mexico	
	GEDIS GmbH Sophienblatt 100 Postfach 22 01 24021 Kiel	+49 (431) 600 51-0 +49 (431) 600 51-11 sales@gedis-online.de

## Table of Contents

<b>1</b>	<b>Putting into Operation</b> .....	<b>1.1</b>
	<b>Notes on putting into operation</b> .....	<b>1.1</b>
	Unpacking the meter .....	1.1
	Setting up the meter .....	1.2
	<b>Front and rear views</b> .....	<b>1.3</b>
	Front panel .....	1.3
	Rear panel .....	1.5
	<b>Installation in a 19" rack</b> .....	<b>1.7</b>
	<b>AC supply voltage</b> .....	<b>1.7</b>
	<b>AC supply fuses</b> .....	<b>1.7</b>
	<b>EMC</b> .....	<b>1.7</b>
	<b>Switching the meter on/off</b> .....	<b>1.8</b>
	Welcome screen and function test .....	1.8
	Resetting and setting brightness and contrast .....	1.10
	ON state .....	1.10
	<b>Preset</b> .....	<b>1.11</b>

# 1 Putting into Operation

This Chapter describes putting into operation (unpacking, AC supply connection, switching the meter on and off), function testing and installing the meter, the preset or default settings and also contains front and rear views of the meter.

## Notes on putting into operation

Before putting the R&S NRP into operation, ensure that

- the sensor inputs are not overloaded,
- the meter's outputs are not overloaded or wrongly connected,
- the ventilation holes are not obstructed.

The meter may be damaged if these precautions are not observed.

## Unpacking the meter

When you have removed the meter from its packing, check that nothing is missing using the delivery note and the accessory lists.

If there is any damage, contact the carrier. Keep all the packing to support any claims for compensation.

It is also best to use the original packing if the meter has to be shipped or transported at a later date.

## Setting up the meter

### Carrying handle

If the R&S NRP is not installed in a rack, it should be set up so that the viewing angle for the display is optimal. The carrying handle can be locked in a variety of positions to act as a stand.



To adjust the handle, pull the two side-pieces of the handle outwards so that the handle can be rotated.

The handle locks at angles which are multiples of 60°.

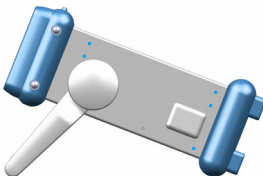
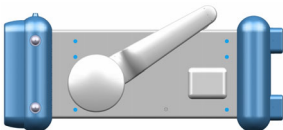

## Front and rear views

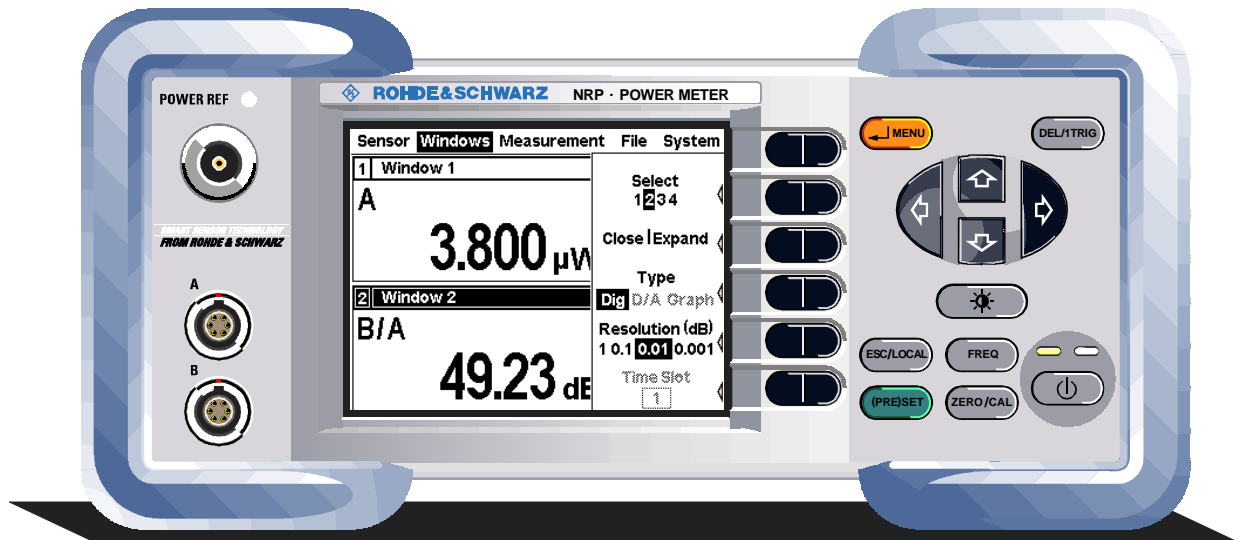

## Front panel

### Sensor connector



The front panel accommodates a maximum of two sensor connectors (for sensors **A** and **B**). The power sensors are connected by inserting the male connector. To disconnect hold the connector by its sleeve. Pulling on the sensor cable will not release the sensor connector.

### Test generator



The test generator connector (option R&S NRP-B1) provides a high-precision, unmodulated sine signal with a power of 1 mW and a frequency of 50 MHz for checking the sensors.

The generator is turned on and off from the **System** menu (see Chapter 4.6 System Settings).



Keypad

See Chapter 3 (Manual Operation).

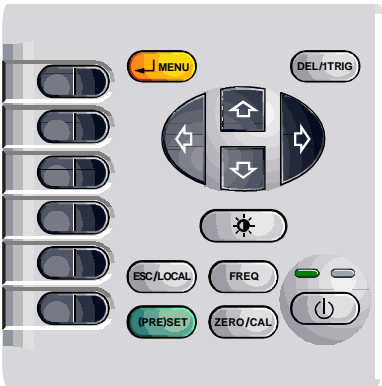

## Rear panel

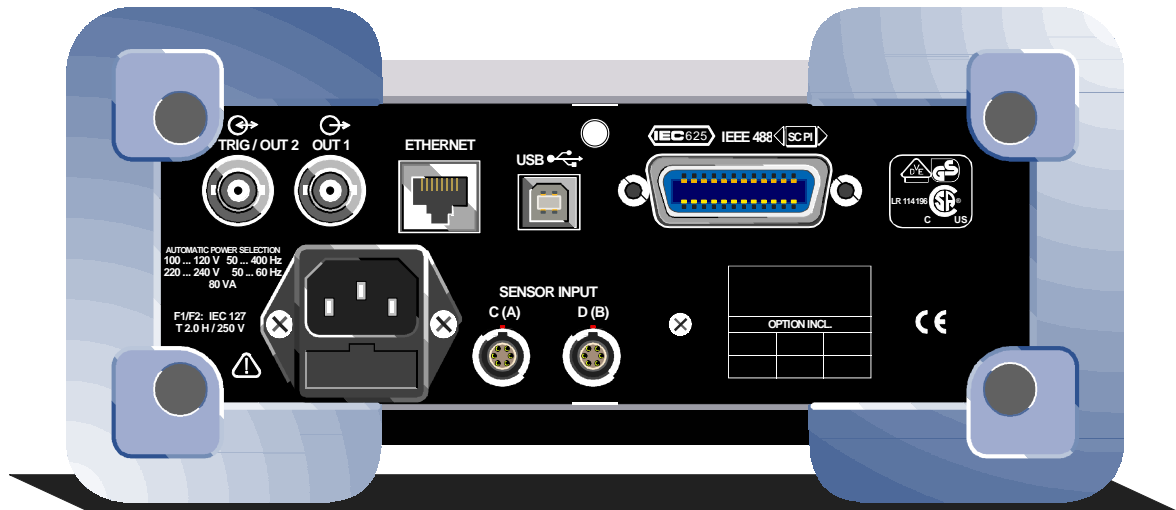

## OUT1 and TRIG / OUT2

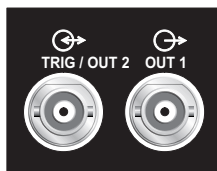

The BNC connector OUT1 outputs an analog signal with a voltage between 0V and 3.3 V. It can be used to output a voltage that is proportional to the measured value (e.g. for level regulation) or a digital signal for threshold monitoring.

The BNC connector TRIG / OUT2 can be used either as an external trigger input or as a second analog output.

The inputs/outputs are configured from the **System** menu (see Chapter 4.6 System Settings).

## Ethernet

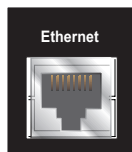

The Ethernet connector (option R&S NRP-B4) is an RJ45 socket for remote controlling the R&S NRP via a network.

## USB



The type-B USB connector is used to update firmware by means of PC downloads (for more information, see the service manual, Chapter 4).

## IEC/IEEE bus

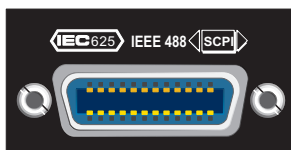

The IEC/IEEE bus connector to IEEE488 is used to remote control the R&S NRP.

**AC supply connector**

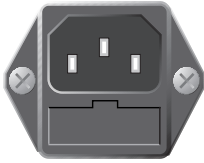

The AC supply connector comprises a standard, IEC low-temperature connector and contains a fuse holder for two miniature fuses. The fuse holder can be taken out with a screwdriver.

See [AC supply voltage](#) on page 1.7 for more on connecting the AC supply.

**Sensor connectors**

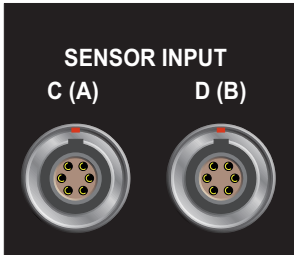

Sensor connectors A and B (option R&S NRP-B6) or C and D (option R&S NRP-B5) can be accommodated on the rear panel.

## Installation in a 19" rack



### Caution

*If the meter is rack-mounted ensure there is a free flow of air through the holes in the side panels.*

The R&S NRP can be installed in 19" racks using a variety of rack adapters (see data sheet for order Nos.). The installation instructions come with the adapter.

## AC supply voltage

The R&S NRP can be operated from AC lines with a voltage range of 100 V to 240 V and a frequency range of 50 Hz to 60 Hz. Note that a restricted voltage range (100 V to 120 V) applies to 400 Hz networks. The AC supply connector is at the rear of the meter. The meter sets itself automatically to the applied voltage if it is in range.

## AC supply fuses

The R&S NRP has two fuses as indicated by the type plate. The fuses are accommodated in a fuse holder in the AC supply connector. The holder can be pulled out to insert fuses. The power supply has its own fuse.



### Caution

*Only the service department may replace the internal fuse.*

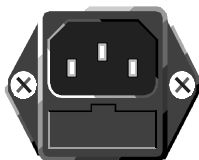

———— AC supply connector

———— Fuse holder

AC supply connector at the rear of the meter

## EMC

To prevent EMI, the meter must always be installed to meet the relevant EMC standards. Never operate the instrument with its enclosure removed. Only use shielded signal and control cables that meet the relevant EMC standards.

## Switching the meter on/off

### ON/STANDBY key

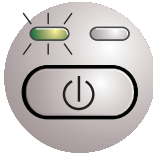

### ( Ø ) key

The ON/STANDBY key is used to toggle between the *on* and *standby* states.

### Yellow LED (AC supply)

The yellow LED indicates that the AC supply is connected to the R&S NRP.

### Green LED (ON)

The green LED indicates when the meter is on.

The following are, therefore, the possible operating states:



The meter is off and disconnected from the AC supply.



The meter is on standby. The AC supply is connected and the power supply is operating correctly.

If option R&S NRP-B3 (battery) has been installed, automatic charging will be started if the battery is low.



The meter is on and is being powered from the AC supply.

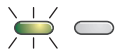

The meter is on and is being battery powered (only applies if option R&S NRP-B3 has been installed).



### Caution

*If you want to completely isolate the meter from the AC supply, pull out the AC supply plug. Selecting the standby mode does **not** disconnect the AC supply.*

## Welcome screen and function test

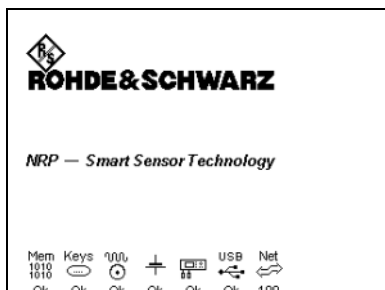

After switch-on, the R&S NRP performs a selftest. The contents of all non-volatile memories, the RAM and the addressability of all interfaces is checked. Messages indicate which options have been installed.

Mem  
1010  
1010  
Ok

Function test on the RAM.



Addressability check on the interfaces for the sensor channels. Only one of the icons shown on the left is displayed to show the number of channels that have been installed.



Channel A.

Appears if the device is single-channel.



Channel A or channels A and B, fitted on the front panel.

Appears only if option R&S NRP-B2 is installed (second measurement input).



Channels A and B, fitted on the rear panel.

Appears only if option R&S NRP-B6 is installed at the rear (sensor connectors A (B)).



Channels A to D.

Appears only if option R&S NRP-B5 is installed (3rd and 4th measurement input).

Keys



Addressability check on the keypad controller.

USB



Addressability check on the USB interface at the rear of the meter.

Test generator



Addressability check on the test generator.

Appears only if option R&S NRP-B1 is installed (test generator).

Addressability test on the Ethernet interface. The transmission rate is displayed.

Appears only if option R&S NRP-B4 is installed (Ethernet).



The "Ok" below the network icon indicates that the interface can be addressed.

If the R&S NRP is not connected to a network hub or if a connection cannot be established during booting, the message *NC (Not Connected)* is displayed instead of *OK*. It is however possible to establish a network connection later on at any time.



Ok

Addressability check on the battery and charging regulator.

Appears only if option R&S NRP-B3 (battery) is installed.



If an error occurs when an interface test is being performed, the message *failed* is displayed under the appropriate icon and the icon is shown in inverse video. When all the tests are completed, booting is interrupted; booting can be restarted by pressing the **continue** softkey.

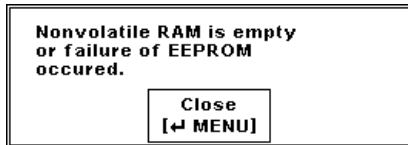

If an error is detected when the non-volatile memory containing instrument settings is checked, an error message is displayed when booting is completed. The non-volatile memory is then re-initialized completely and the R&S NRP goes into the preset state. All instrument settings that have been saved are lost as a result of this procedure.

## Resetting and setting brightness and contrast

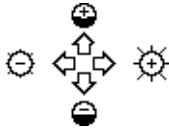

If you press the (Æ) key immediately after switching on the R&S NRP, after about 3 seconds the R&S NRP goes into a state in which you can adjust brightness and contrast.

Initially, contrast and brightness are automatically set to their default values. You can then make the settings you want using the diagram on the screen.

## ON state

Whenever the meter is switched off, its settings are saved. The next time it is switched on, these settings are automatically restored.



*If the last setup before switch-off is to be restored, the R&S NRP must be switched off with the standby key (⌀). If the meter is turned off by disconnecting the AC supply, it is possible that the settings being used immediately beforehand are not saved.*

## Preset

You can change the R&S NRP to a defined default state by pressing the ((PRE)SET) key twice. Various parameters including the following will be set as a result:

- All channels in the *Cont Av* mode (continuous average power).
- Absolute power measurement in dBm.
- One window per channel opened.
- Offset: 0 dB
- Automatic filtering (normal mode).

When the preset state is selected, all default parameters are set – even those for operating modes that have not been activated.



## Table of Contents

<b>2</b>	<b>Getting Started</b> .....	<b>2.1</b>
	Requirements.....	2.1
	Measuring average power (Cont Av mode) .....	2.2
	Window handling.....	2.11
	Setting measurement functions.....	2.16
	Graphically representing power versus time (Scope mode) .....	2.18
	Measuring av. burst power (Burst Av mode).....	2.21
	Measuring average power in defined time interval.....	2.22

## 2 Getting Started

This Chapter contains step-by-step instructions for simple measurements and provides an introduction to the R&S NRP's basic modes of operation. Each step is listed in order. The operating steps that are to be performed are highlighted in grey, while the sections between contain screenshots and also comments and references to more information.

The five sections describe the following:

☞ Measuring average power	Step-by-step introduction to standard power measurements with the R&S NRP.
☞ Window handling (p. 2.11) and ☞ Setting measurement functions (p. 2.16)	Basic techniques for configuring measurement windows.
☞ Graphically representing power versus time (Scope mode),	Graphical representation of the time characteristic.
☞ Measuring av. burst power (Burst Av mode), p. 2.21	Measurement of burst power without external triggering.
☞ Measuring average power in defined time interval, p. 2.22	Power measurement in one or more successive timeslots with internal or external triggering.

Some of the sections later on in this Chapter assume familiarity with the basic operating techniques which are introduced in the first two sections. It is, therefore, advisable to go through the first two sections before considering other topics.

## Requirements

- Read the notes on putting the meter into operation in Chapter 1.
- A single-channel R&S NRP is sufficient for most of the examples used in the sequel. However, if you want to work through all the steps in the section ☞ Setting measurement functions (p. 2.16), you will need a dual-channel instrument.
- An R&S NRP-Z1x or R&S NRP-Z2x sensor is required for the section ☞ Measuring av. burst power (Burst Av mode) (p. 2.21); all other sections can be worked through with the Thermal Sensors R&S NRP-Z5x.
- A signal source is required for the measurements that are described. It is best to use a signal generator whose level can be adjusted. If a generator of this type is not available, the R&S NRP's integral power reference (option R&S NRP-B1) can be used instead.

## Measuring average power (Cont Av mode)

### ❶ Set the R&S NRP to the PRESET state.

The instrument is set to a well-defined initial state to prevent any previous settings from causing incorrect results.



- Put the R&S NRP into operation as described in Chapter 1 and connect a sensor to connector **A**.
- Press the **(PRE)SET** key.

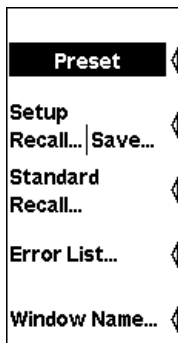

The File menu appears.

The appearance of **Preset** on a black background means that this function can also be started by pressing the **(PRE)SET** key again.



- Press the **(PRE)SET** key again or the **Preset** softkey.

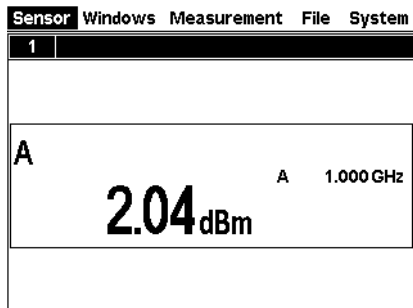

The Setup dialog box disappears and the meter is in the preset state.

A display window indicates the result (in dBm) obtained with sensor A.

2 Zeroing the meter

A zero error correction is one of the meter’s default settings. This procedure should be repeated as and when necessary, but primarily when the sensor reaches its operating temperature.

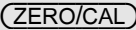

↑

- If the sensor is already connected to a signal source, switch off the power.
- Press the **ZERO/CAL** key

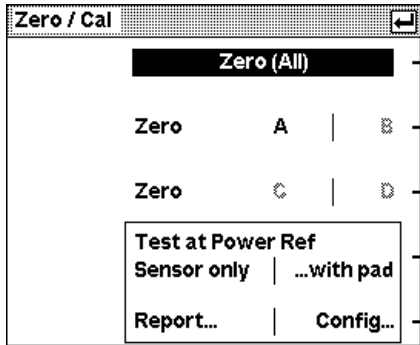

The Zero/Cal dialog box is displayed.

The appearance of **Zero (All)** on a black background means that this function can also be started by pressing the **ZERO/CAL** key again.



↑

- Press the **ZERO/CAL** key again or the **Zero (All)** soft-key.

The correction measurement takes several seconds. When completed a GO/NOGO message is output.

3 Setting the frequency

The R&S NRP must be set to the carrier frequency of the applied signal if the specified measurement accuracy is to be reached.



↑

- Connect an unmodulated signal with a level between -10 dBm and +10 dBm to the sensor.
- Press the **FREQ** key

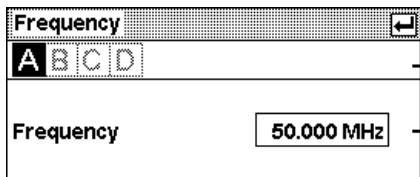

The dialog box for entering the frequency appears.

A | B | C | D



↑↔↓

- Select channel A by pressing the appropriate rocker switch.

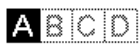

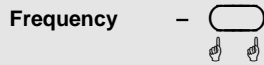

➤ Press the **Frequency** softkey

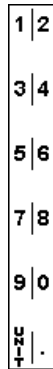

A panel with all the characters you will need to enter the frequency is displayed next to the softkeys.

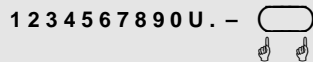

- Clear the field with the **DEL/1TRIG** key.
- Enter the frequency of the signal that is fed in by pressing the appropriate softkeys.
- Using the **UNIT** softkey, select the unit you want.

✓ **Try the following:**

To familiarize yourself with the editor, try the following steps:

- Using the left/right cursor keys, move the block cursor and overwrite the digits with new values.
- Use the up/down cursor keys to scroll the digits to the cursor position.
- Move the insertion mark to the right onto the units. Use the vertical up/down keys to change the unit.



➤ Confirm your entry.



➤ Close the dialog box.

④ Setting the unit in the display

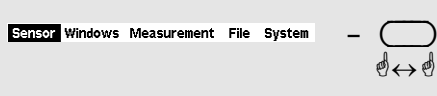

- Using the topmost rocker switch or the cursor keys (↔), select the **Measurement** menu.

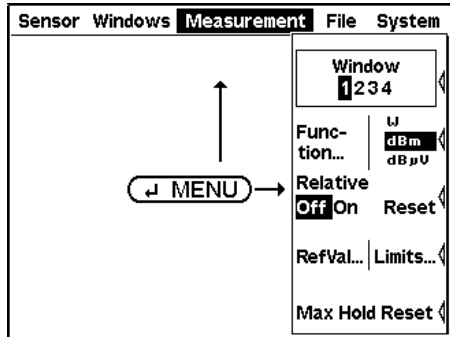

The menu opens out automatically for this procedure.

- Press the **MENU** key, if the menu is not displayed.

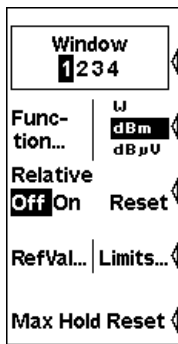

The results of post-processing are summarized in the **Measurement** menu.



- Use the **Window** softkey to select window 1.



The functions in the **Windows** and **Measurement** menu are all defined for the selected window.

The dark title bar indicates the window that has been selected.

✓ **Tip:**

You can also select windows with the up/down cursor keys.

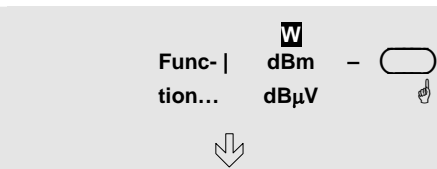

- Select the unit **W** with the adjacent rocker switch.

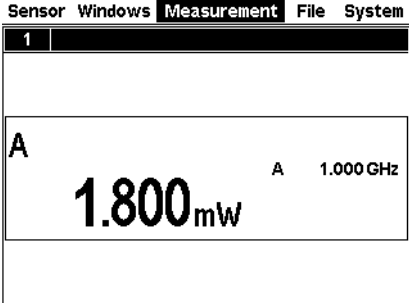

The result is displayed in W.

5 Setting a fixed offset correction

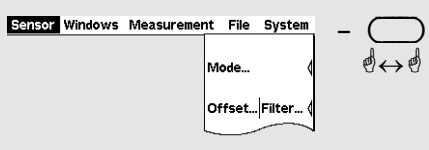

➤ Using the topmost rocker switch or the cursor keys (↔), select the **Sensor** menu.



All sensor-related settings can be made in the **Sensor** menu. This determines the type and details of data acquisition.



➤ Press the **Offset...** softkey (left-hand side of rocker-switch).

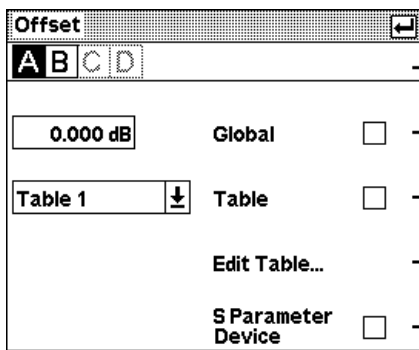

The Offset dialog box opens. Factors for correcting external signal losses or gains, due to an attenuator, for example, can be set in this box.



➤ Activate the editor for the global offset by pressing the left-hand side of the rocker switch next to **Global**.

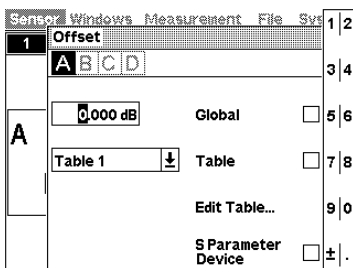

Positive values are for correcting losses and negative values for gains.

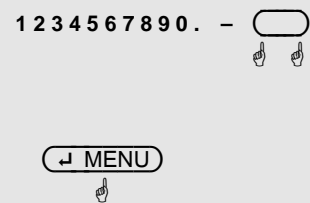

➤ If you have an attenuator at hand, enter its value and connect the attenuator between the sensor and the signal source, otherwise just enter 10 dB.

➤ Confirm the entry.



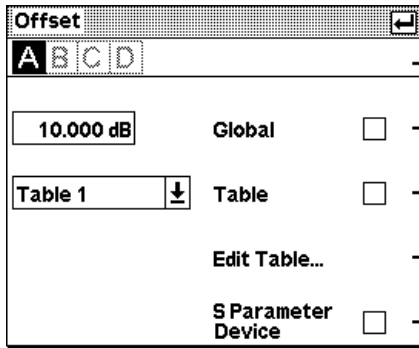

Global    -    

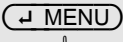

- Activate the global offset correction by pressing the right-hand side of the rocker switch next to **Global**.
- Accept the warning concerning the triggerlevel.

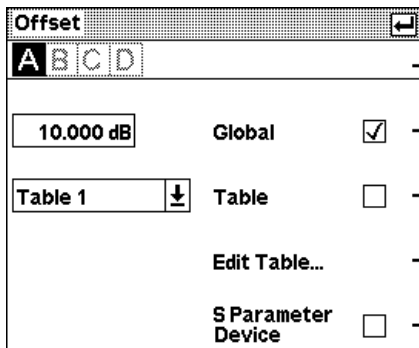

Global offset correction is now on. The displayed value is increased or decreased depending on the sign of the offset.

Factors which are not, or only minimally, dependent on frequency can be corrected in this way.

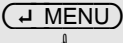

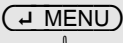

- Close the dialog box.
- Close the menu.

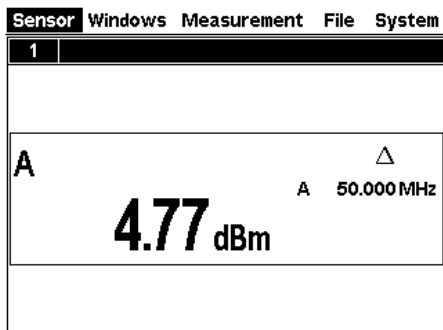



If you have connected an attenuator and entered its attenuation, the R&S NRP will display about the same value as before.

In the note line of the measurement window, the  $\Delta$  symbol indicates that global offset correction has been activated.

## ⑥ Relative power measurements

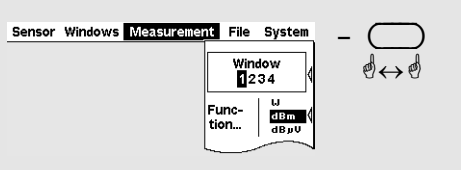
The R&S NRP can calculate and display the relative difference between a measured value and a reference value. The reference value can be a measured value that has been saved or an arbitrary value that is entered.

	<ul style="list-style-type: none"> <li>➤ Using the topmost rocker switch or the cursor keys (<math>\leftarrow\rightarrow</math>), select the <b>Measurement</b> menu.</li> </ul>
<p>Relative - </p>	<ul style="list-style-type: none"> <li>➤ To activate the relative mode, press the right-hand side of the rocker switch next to <b>Relative</b>.</li> </ul>

Relative  
Off **On** Reset

As the default setup was loaded in step ①, the value relative to 0 dBm is displayed.

<p>Relative - </p>	<ul style="list-style-type: none"> <li>➤ Press the rocker switch next to <b>Relative</b> again on the right-hand side.</li> </ul>
---	---

Relative  
Off **On** Reset

In the second line,

Off On **Reset**

is displayed briefly and then the original display returns.

The last power result obtained has now been made the new reference value. If the power has not changed in the meantime, the reference value and the power are equal and the indicated value is 0 dB.

	<ul style="list-style-type: none"> <li>➤ If an attenuator is still connected, remove it now and connect the sensor directly to the signal source.</li> </ul>
--	--

The displayed value should now equal the attenuation that has been entered.

7 Checking settings (window zoom).

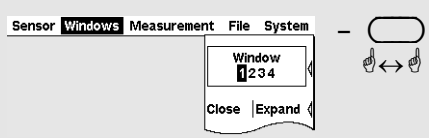

➤ Using the topmost rocker switch, or the cursor keys (↔), select the **Windows** menu

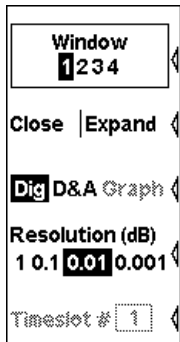

The **Windows** menu contains all the functions required for opening, closing and configuring windows.

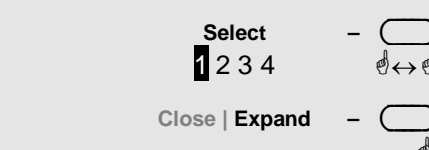

➤ Check if window 1 has been selected.

➤ Press the **Expand** softkey.

1	A (Cont Av)	System
Σ	4 Auto	
Δ	10.000 dB	
1□z		
ft		
A Rel		
10.22 dB		A 1.000 GHz

Window 1 now expands to occupy the full space below the menu bar and displays all the key measurement parameters: The frequency from ③, the offset correction from ⑤ and the relative display from ⑥.

➤ To return the window to its normal size, open the **Windows** menu with the (↵ MENU) key and press the **Arrange** softkey.

## Window handling

Up to four windows can be shown simultaneously on the R&S NRP's display. Each window can be configured for a separate measurement. The following examples show how to handle windows.

### 1 Opening, creating, zooming and closing windows.

(PRE)SET



- Press the (PRE)SET key twice.

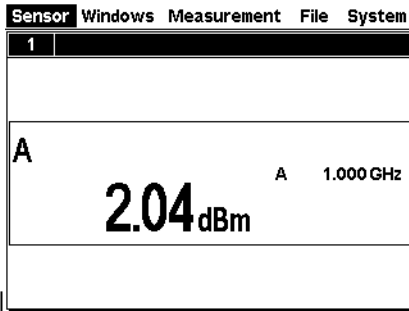

A display window indicating the result from sensor A (in dBm) appears.

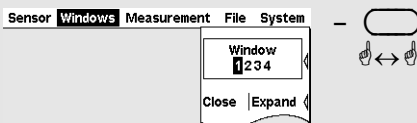

- Using the topmost rocker switch or the cursor keys (⇐⇒), select the **Windows** menu.



The **Windows** softkey can be used to select which window the functions in the **Windows** menu and in the **Measurement** menu will act on.

#### ✓ Tip

The cursor keys (↑) (↓) can, in most cases, be used instead of the rocker switch to select windows. This also applies to opened dialog boxes.

Windows  
1 2 3 4



- Select window 1.

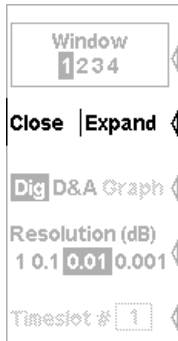

The third softkey is now labelled **Close | Expand**.

Close | Expand - 

- Press the Expand key

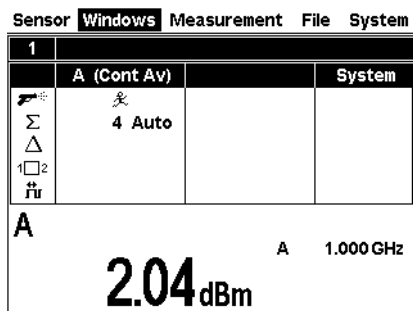

The window expands to occupy the full display height and indicates all parameters relevant to the measurement. The currently displayed values are the default values obtained after a preset.

Instead of **Expand**, the **Arrange** function is now available to arrange all opened windows.

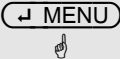
 MENU

Close | Arrange - 

- Open the menu again.
- Press the **Arrange** key.

Window 1 returns to its previous size.

The following steps show the difference between the **Open** and **Init** functions. You first have to change two settings of window 1.

Dig D/A - 

Sensor Windows Measurement File System - 

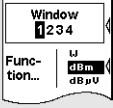

- Using the **Dig D/A** softkey, activate the analog display of results.
- Go to the **Measurement** menu and select **Relative On**.
- Return to the **Windows** menu.

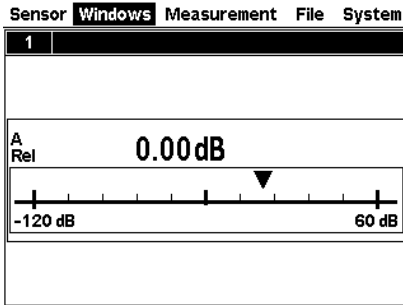

Window 1 now displays the A Rel function on an analog scale.

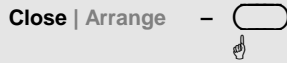

➤ Now, close window 1 with the **Close** softkey.



“Select” in **Window** shows that window 1 is still selected.

The labelling next to the third softkey is now **Open | Init**.

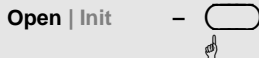

➤ Now, press the **Open** softkey (**not Init**).

The appearance of the window has not changed, and all window-specific settings have been maintained.

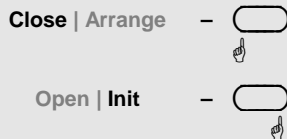

➤ Again close window 1 with **Close**, but open it this time with **Init**.

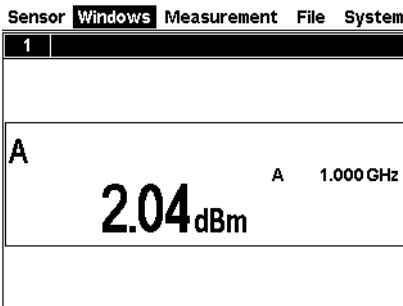

The window again displays the measurement function A in digital format.

The difference between **Open** and **Init** is that **Open** keeps the values of all the parameters that have been previously set in this window while **Init** sets all the parameters to their default values.

*Caution: This function only resets the window settings made in the **Windows** and **Measurement** menus, but it does not affect the sensor settings!*

2 Display options



The **Dig** and **D&A** softkeys are used to select various display modes.

The standard display mode is **Digital** measured value.

Dig D/A Graph -  ➤ Select the **D/A** display mode.

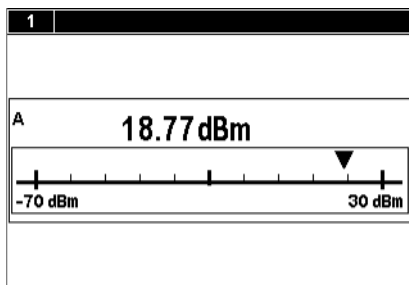

Window 1 now shows an analog scale and a digital reading.



The menu now includes the new item "Analog Meter..." for setting the scale limits.

Dig D/A -  ➤ Switch back to **Dig** display mode.

③ Auxiliary values (Maximum, Minimum, Max, Min, ...).

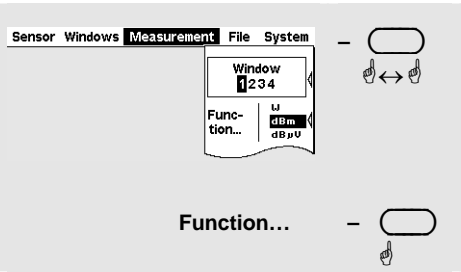

Sensor Windows Measurement File System

Window 1234

Function... dBm dBµV

Function... -

- Select the **Measurement** menu.
- Select **Function...** in this menu.

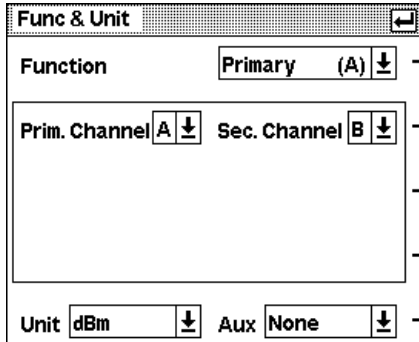

Func & Unit

Function Primary (A) ↓

Prim. Channel A ↓ Sec. Channel B ↓

Unit dBm ↓ Aux None ↓

The measurement function, unit, sensors used and the auxiliary value can be selected in the Function & Unit dialog box.

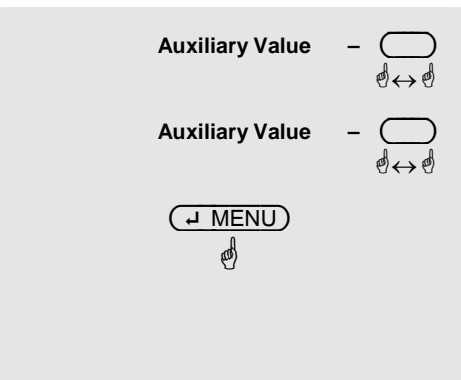

Auxiliary Value -

Auxiliary Value -

↓ MENU

- Open the **Auxiliary Value** drop-down list.
- Select **Max**.
- Close the dialog box.
- Press the **Max Hold Reset** softkey and close the menu with **↓ MENU**.

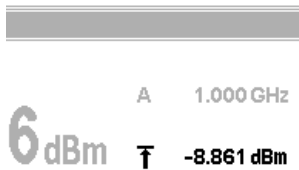

A 1.000 GHz

6 dBm ↑ -8.861 dBm

The updated maximum is now displayed on the right next to the measured value.

If you reduce the signal power, the maximum should remain the same. However, if the signal power is increased, the maximum changes accordingly.



## Setting measurement functions

A multichannel meter with two sensors connected is required for this section. If only one sensor is available, you can only select the measurement functions "Primary" and "Secondary".

### 1 Measuring one power relative to another.



- Connect the two sensors to connectors A and B on the R&S NRP and apply an unmodulated signal with a level between -10 dBm and +10 dBm to each of the sensors.

- Press the **(PRE)SET** key twice.

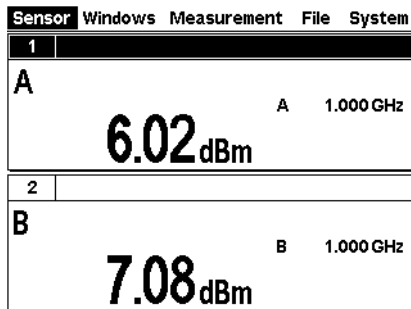

Now, two display windows with the results (in dBm) from sensors A and B appear.

A window for each sensor is opened with Preset.

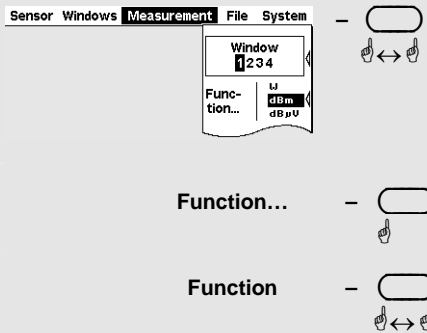

- Select the **Measurement** menu and then select **Function...** from this menu.

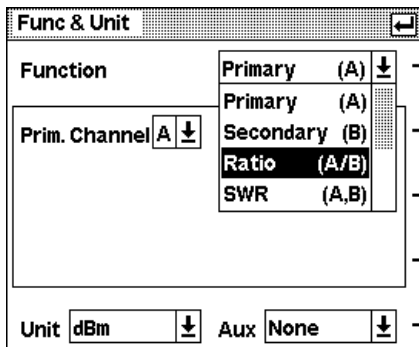

- Open the **Function** drop-down list in the Function & Unit dialog box.





In this window, you can select the function used to calculate the result in the active window. For example, **Ratio (A/B)** yields the quotient from the measured power values in channels A and B.

- Check whether **Sensor A** is selected in the drop-down list for the primary channel and **Sensor B** in the drop-down list for the secondary channel. If not, switch to the primary channel, for example. The secondary channel is then automatically set to the other sensor.

### ✓ Tip

You can also operate the drop-down lists by means of the cursor keys   instead of the rocker switch.

Function -   
 

Unit -   
 

- Select **Ratio (A/B)** from the drop-down list for the measurement function and close the drop-down list with .

- Now, press the **Unit** softkey.

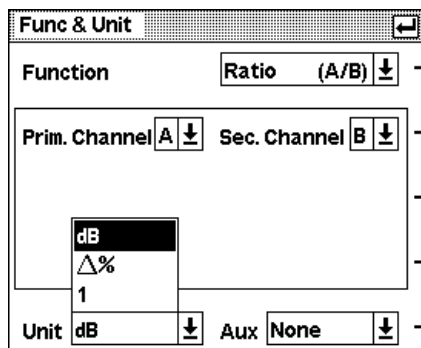

The ratio of two powers is dimensionless – this is why only **dB**, **Δ%** and **1** are available in the unit list. The symbol **Δ%** represents the relative uncertainty in % (0 % means the powers in both channels are equal), the symbol **1** represents a straight ratio, i.e. not the log of a ratio.

# Graphically representing power versus time (Scope mode)

In the *Scope* mode, power versus time can be represented graphically as with an oscilloscope. If you wish to carry out time-dependent measurements (in the Burst or Timeslot mode) on modulated signals, displaying the signal in the Scope mode is always initially recommended since stable triggering by the R&S NRP is most clearly recognized in this mode.

## 1 Setting the Scope mode.



- Connect a power sensor of the R&S NRP-Z1x or R&S NRP-Z2x family to connector A of the R&S NRP and apply an amplitude-modulated or pulsed signal having a modulation or pulse frequency of approx. 1 kHz. The maximum level should be between -10 dBm and +10 dBm.
- Press the **(PRE)SET** key twice.

A measurement window is now available.

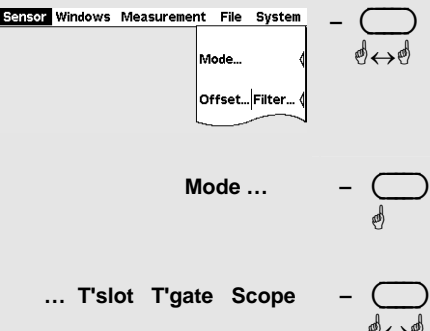

- Change to the **Sensor** menu and select **Mode**.
- Switch to the **Scope** mode.

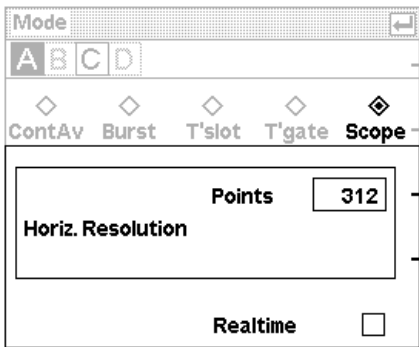

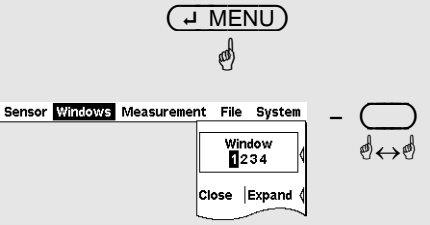

The associated parameters will appear in the lower part of the dialog box. You can leave the parameters unchanged for this exercise.

For a detailed description, see Chapter 4, Displaying data in the Scope mode.

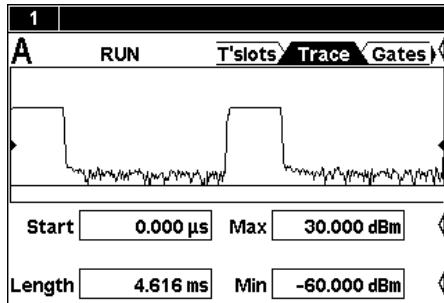

- Close the **Mode** dialog box.
- Change to the **Windows** menu and press **Expand**.

Close | Expand - 

The window is now in the Scope display mode and shows the Trace page. The **Max** and **Min** fields are used to choose the level range (the vertical resolution), and the **Length** field to choose the horizontal resolution.

If you do not see a trace, the trigger threshold probably does not match the signal. In this case, a **?** symbol on a black background (see step ②) will appear in the row of warning symbols below the window title bar.

The other pages that can be selected via the tabs are used to configure the parameters of the Timeslot mode (T'slots,  Measuring average power in defined time interval) as well as to set gates (Gates) by using markers and to perform measurements within these gates (Meas).

② Settings for reliable triggering

Trigger ... 

- Change to the Sensor menu.
- Open the Trigger dialog box.

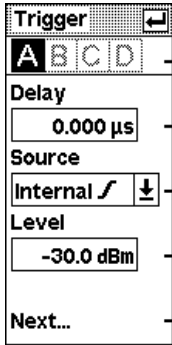

If the Trigger dialog box is opened in the Scope display, a dotted line indicates the trigger threshold in the diagram.

- **Source** (trigger threshold)  
Choose between external triggering (connector I/O2 at the rear) or internal triggering (derived from the signal) and between positive or negative edge.

*Note:* Since I/O2 functions both as a trigger input and analog output, be sure to select the correct setting (System → I/O dialog)!

- **Level**  
In the case of internal triggering, set the trigger threshold here.

✓ **Tip**

When a **?** symbol in the display shows, that the sensor doesn't trigger, the (DEL/1TRIG)-key can be used to trigger the sensor once. The then appearing graph often can give a hint how to choose trigger settings.

Next ... 

- Open the second page of the Trigger dialog box.

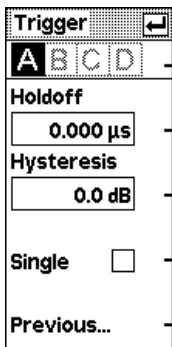

The **Holdoff** and **Hysteresis** parameters allow you to make settings that enable reliable triggering even in the case of complex signals.

- **Holdoff**  
Use this parameter to set the time range in which additional trigger events (measured from the last successful triggering) are to be ignored.
- **Hysteresis**  
Setting the trigger hysteresis to a value other than 0 dB will prevent triggering from occurring again until the measurement level has fallen below the trigger threshold by at least this value.

For a detailed description of these parameters, refer to Chapter 4, Trigger settings.

## Measuring av. burst power (*Burst Av mode*)

An R&S NRP-Z1x or R&S NRP-Z2x diode sensor is required for this measurement. To make measurements possible, a pulsed RF signal with a pulse repetition frequency not exceeding 10 kHz should be available.

The R&S NRP-Z1x and R&S NRP-Z2x sensors have two measurement modes for RF burst power: *Burst Av* and *Timeslot*.

An external trigger is not required in the *Burst Av* mode – the sensor automatically determines the trigger point from the measured signal. It is also not necessary to specify the width of the burst as the sensor determines the end of the burst automatically.

### ❶ Setting the burst mode.



- Connect an R&S NRP-Z1x or R&S NRP-Z2x sensor to connector A on the R&S NRP and apply a pulsed signal with a level between  $-10$  dBm and  $+10$  dBm.

- Press the (PRE)SET key twice.

A measurement window is now available.

- Change to the Sensor menu and select **Mode...** When the Mode dialog box opens, select **Scope**.
- Once in the Scope mode (see section [Scope](#)), make sure that the sensor detects a signal and reliably triggers.
- Change back to the Sensor menu and select **Mode...** When the Mode dialog box opens, select **Burst**.

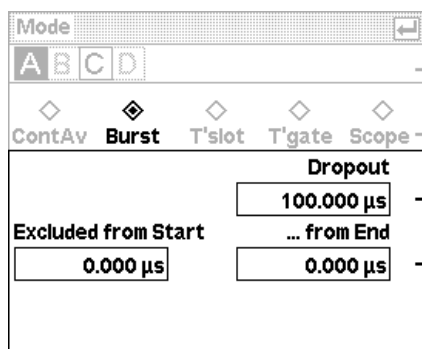

The burst mode parameters are displayed at the bottom of the dialog box.

To exclude the pulse build-up and decay phases from the measurement, you can set the **Excluded from Start** and **Excluded from End** parameters accordingly.

The parameter **Dropout** helps to ensure the reliable detection of the end of modulated-signal bursts (e.g. NADC).

See Chapter 4, *Measuring the average burst power*, for a detailed description.

## Measuring average power in defined time interval (Timeslot mode)

In the *Timeslot* mode, average power can be measured in a defined time interval of any complex signal. An external trigger signal is normally used since it always ensures reliable triggering and the measurement of very low power. Thus, for example, the power in one or more timeslots of TDMA signals can be measured simultaneously.

### ❶ Setting the Timeslot mode.

- Connect a power sensor of the R&S NRP-Z1x or R&S NRP-Z2x family to connector A of the R&S NRP and apply a signal having TDMA time structure within the level range  $-10$  dBm to  $+10$  dBm.
- Once in the Scope mode (see section [Scope](#)), make sure that the sensor detects a signal and reliably triggers.
- Change to the Sensor menu and select **Mode...** When the Mode dialog box opens, select **Timeslot**.

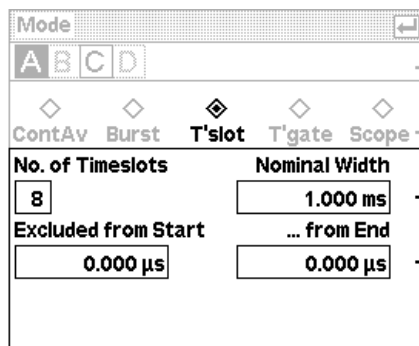

The associated parameters will appear in the lower part of the dialog box.

- Under **Nominal Width**, set the nominal value of the timeslot width.
- Under **Excluded from Start** and **Excluded from End**, define the portions to be excluded from the measurement.
- Use **No. of Timeslots** to set the number of timeslots in a TDMA frame.

### ✓ Tip

**Excluded from Start** and **Excluded from End** can also be set interactively in the Scope display on the T'slots page.

For a detailed description, see Chapter 4, "Measuring the power of TDMA signals".

## ② Settings to ensure reliable triggering

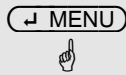

- Close the **Mode** dialog box.



- Open the **Trigger** dialog box.

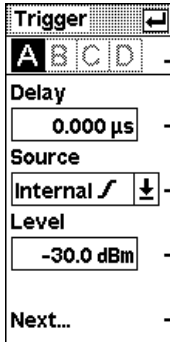

The Timeslot mode provides not only the **Source** and **Level** parameters described in the section [Settings for reliable triggering](#) but also the **Delay** parameter which is used when the start of timeslot 1 (Frame Start) does not coincide with to the trigger time.

- **Delay**  
Define the start of timeslot 1 with reference to the triggering edge. The value can be positive or negative.

### ✓ Tip

The Scope display shows physical and delayed trigger times in the form of a triangle so that **Delay** can be interactively adjusted to the signal.

## ③ Simultaneous measurement in multiple timeslots.

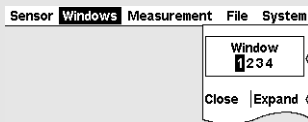

- Change to the **Windows** menu.

- Use the rocker switch beside **Timeslot #** to view the various timeslot values in the measurement window.

### ✓ Tip

You can open a separate window for each slot and thus display up to 4 timeslot values simultaneously.



## Table of Contents

<b>3</b>	<b>Manual Operation .....</b>	<b>3.1</b>
	Keys .....	3.1
	Screen layout .....	3.3
	Menu layout.....	3.5
	Menu handling .....	3.7
	Dialog boxes and their controls.....	3.8
	Display windows.....	3.11
	Window sizes and types .....	3.11
	Special symbols.....	3.12

## 3 Manual Operation

This Chapter describes the controls, displays, etc, the screen layout and how to operate the R&S NRP.

### Keys

Keys on the front panel of the meter are used to manually operate the instrument. There are several groups of keys, each group having a different function:

#### Softkeys



The six softkeys are rocker switches – in other words, they can be “rocked” backwards and forwards by pressing on the right or left side of the key.

The softkey function is context-sensitive and is indicated by screen labelling.

For more information on the softkeys see [☞ Menu handling](#) on p. 3.7 and [☞ Dialog boxes and their control elements](#) on p. 3.8.

#### Hardkeys

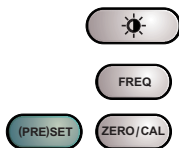

The hardkeys are a direct way of activating the main functions and are always available for use:

- Brightness/contrast
- Frequency entry
- Preset and setups
- Zeroing

For further information on using the hardkeys, see Chapter 4, section "Hardkeys".

#### Cursor keypad



The cursor-key functions are context-sensitive. They can be used to

- Select the menu,
- Select the active window,
- Move the cursor in text boxes,
- Change the value of an entry in a text box,
- Select an element from a drop-down list,
- Adjust the brightness and contrast of the display.

With the exception of moving the cursor, the functions referred to above can also be activated using softkeys.

**Enter / MENU key**

As the **(↵)** key (i.e. Enter key), it is used to confirm entries in text fields and dialog boxes and to confirm selections in the drop-down lists.

As the **(MENU)** key, it is used to fold out and fold back the menus next to the softkeys.

The function of the key is determined according to context – in other words, the Enter or MENU function is always selected automatically for the operator by the instrument.

**ESC / LOCAL**

This key is used as an **(ESC)** key to escape from the entry mode in text boxes and drop-down lists. It is also used to close dialog boxes and menus without losing any entries that have been made (☞ Title bar on p. 3.8).

As the **(LOCAL)** key, it is used to switch the R&S NRP from remote control mode (all controls disabled) to manual mode.

The key is automatically assigned its function according to context – in other words, there is no manual assignment by the operator.

**DEL / 1 TRIG**

The **(DEL)** key is used to delete numbers or text in a field so that a completely new entry can be made.

As the **(1 TRIG)** key, it triggers single-shot measurements in the Scope mode.

The function of the key is selected automatically according to context.

# Screen layout

## Window

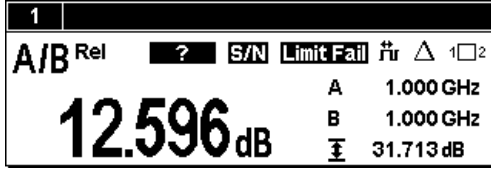

The R&S NRP displays results in windows. A maximum of four windows can be displayed simultaneously on the screen. They are numbered 1 to 4. Windows have a title bar which contains the number (not user-assignable) and a name (user-selectable) for the window.

Windows do not have any control elements.

## Menu bar

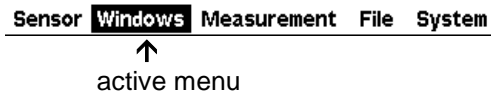

A menu bar is always displayed at the top of the screen. It contains the names of the R&S NRP's menus.

One of these names is always in inverse video and this is the name of the active menu.

## Menu selection

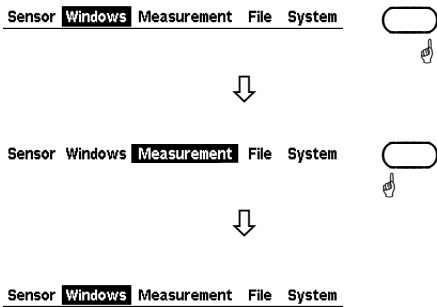

The menu you want to activate can be selected by pressing the right- or left-hand side of the topmost rocker switch one or more times.

Alternatively you can also use the cursor keys  $\rightarrow$   $\leftarrow$ .

## Folding menus out or back

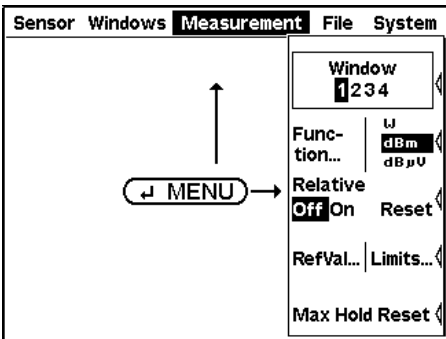

$\leftarrow$  MENU folds out the active menu.

The usual PC convention is not followed – instead of dropping down directly below the menu name in the menu bar, menus fold out to the right-hand edge of the screen. This means that the menu items are directly next to the rocker switches used to select them.

If you press the  $\leftarrow$  MENU key again, the menu folds back.

The menu also folds out automatically if another menu is selected.

**Menus**

See p. 3.7,  Menu handling for more information.



**Dialog boxes**

Dialog boxes can be opened from the menus. The dialog boxes present a group of related parameters that can be set.

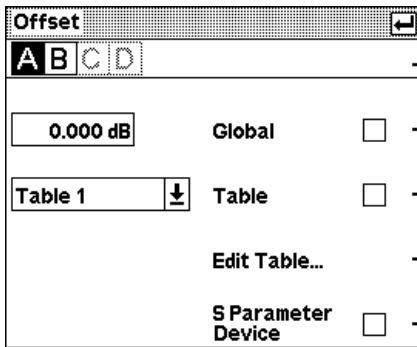

See  Dialog boxes on p. 3.8 for more information on handling dialog boxes.

## Menu layout

### Sensor

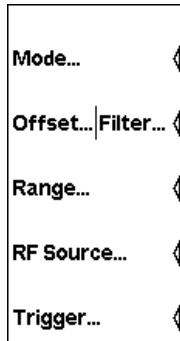

All sensor settings can be made using the **Sensor** menu. The type and details of data acquisition can be specified with this menu.

See Chapter 4, section "Data acquisition and parameters", for a detailed description.

### Windows

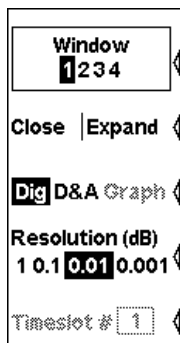

The **Windows** menu is used to configure windows and the result display in the windows.

See Chapter 4, section "Displaying measurement results", for a detailed description.

### Measurement

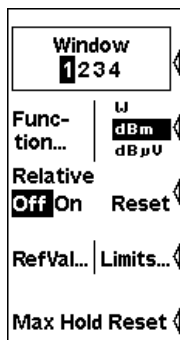

The details of postprocessing are summarized in the **Measurement** menu.

See Chapter 4, section "Configuring measurements", for a detailed description.

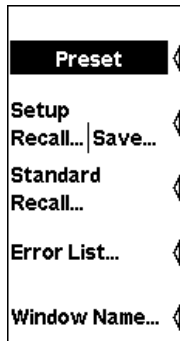
**File**

The **File** menu is used to handle the setup memories and display information about the instrument and any sensors that have been connected.

See Chapter 4, section "Management of settings", for a detailed description.

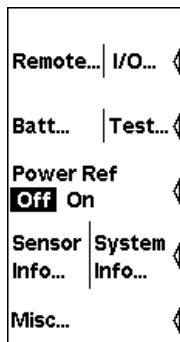
**System**

The **System** menu is used to handle functions that are not specifically used to perform measurements.

See Chapter 4, section "System settings", for a detailed description.

## Menu handling

The menus can contain up to eight menu items which are used to perform an action, open a dialog box or set a parameter.

### Perform action

If the menu contains only one or two descriptive terms, an action is performed directly.

Close

### Use hardkey to perform action

If the name of the action to be performed is shown in a wide black field, you can start the action by pressing the hardkey of the same name, e.g. **(Pre)set** in this case.

**Preset**

### Open dialog box

If a menu item is followed by three dots "...", it can be used to open a dialog box to set a variety of parameters.

Mode...

### Set parameters

Parameter-setting options are presented in the menu. The currently selected option is shown in inverse video. You can select the option you want by pressing the left or right side of the rocker switch.

Relative  
**Off** On Reset

### Softkeys with dual assignments

Some softkeys are assigned two menu items. One is selected by pressing the left-hand side of the rocker switch, the other, the right-hand side.

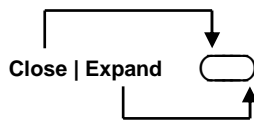

The two menu items are separated by a vertical line.



## Dialog boxes and their controls

Dialog boxes contain check boxes, option fields, editing fields and drop-down lists as control elements. They are activated using the appropriate rocker switch to their right. If two control elements are positioned side by side, the element on the left is operated with the left-hand side of the rocker switch and the element on the right with the right-hand side of the rocker switch.

### Title bar



Dialog boxes have a title bar which displays the name of the dialog box and the  symbol which is a reminder that the dialog box can be closed with the **(MENU)** key.

*Caution:* Settings made in dialog boxes are immediately set on the R&S NRP – in other words you do not need to close the dialog box to activate the settings in the box.

### Dialog boxes with tabs

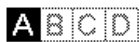

Channel-specific settings are made in a special page in a super-ordinate dialog box. In the top row of the dialog box, there are tabs which you can use to switch between pages.

Channels which do not have a sensor connected and channels that have not been installed are shown in grey and cannot be selected.

### Check boxes



Check boxes are used to activate and de-activate functions. You can toggle between the two states by pressing the appropriate softkey.

### Option fields



Option fields contain groups of mutually exclusive operating modes.

When you press the left-hand side of the rocker switch, the next option on the left is selected. When you press the right-hand side of the rocker switch, the next option on the right is selected.



In the **System I/O** dialog box, option fields are assigned to only one side of a rocker switch. It is therefore only possible to scroll through in one direction.

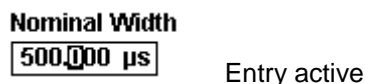

### Editing fields

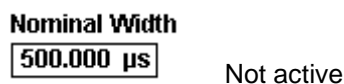

Editing fields are used to enter or modify numbers and text. The editor is activated by pressing the appropriate rocker switch — or the appropriate side of the rocker switch if there is a dual assignment.



Editing can be performed in overwrite mode, indicated by the marked character being in inverse video. Modifications can be made either with the   cursor keys or numeric/digit softkeys which are provided in a digit or letter panel when the editor is activated.

The   cursor keys are used to select the digit to be edited.

**Editing fields (cont.)**

In the editing fields for quantities with units, the left/right cursor keys can be used to select the unit too; the up/down cursor keys are used to edit it. Usually, the digit panel also contains a unit softkey which you can use to change the unit whenever you want.

If you want to make a completely new entry, the whole field can be cleared with the **(DEL/TRIG)** key. In the insert mode (indicated by the I cursor), you can enter digits and/or letters.

Any changes you make to a field can be confirmed with the **(↵ MENU)** key. When this key is pressed, the new value is subjected to a validity check. If the check discovers an error, a warning message is output.

You can quit the editor by pressing the **(ESC)** key; this leaves the old values unchanged. Any warning messages are cleared.

**✓ Tip**

To set the maximum or minimum value permitted for a parameter, first move the insertion mark to the left edge of the entry field by using the **(←)** key. Then press the **(↑)** key (several times if necessary) to set the maximum permissible value or the **(↓)** key to set the minimum permissible value.

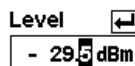
**Editing fields with direct entry of values**

Level **(↵)**  
- 29.5 dBm

The Filter, Range, Trigger and Trigger Advanced dialog boxes are designed such that you can read the values even when the dialog box is open.

If you edit a value in a dialog box using the cursor keys **(↓)** **(↑)**, the new value is accepted immediately when you press a key. This feature allows you to quickly assess the effect of editing and to perform interactive adjustment.

If you enter a new value with the letter panel (see below), however, the symbol **(↵)** appears above the editing field to indicate that the new value is not accepted until you confirm it with the **(↵ MENU)** key.

**Digit and letter panels**

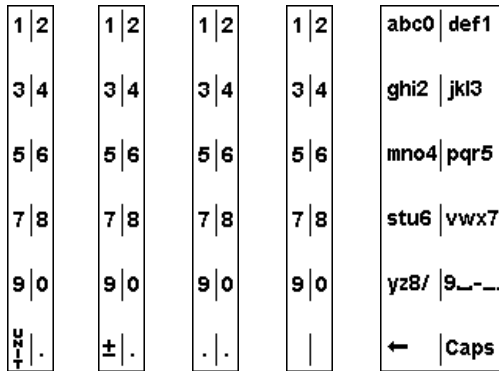

Panels which are displayed when an editing field is activated (see above) are used to enter digits, letters and units.

Entering letters with the letter panel is like entering letters on a phone keypad. The Caps key is used to select upper case for the next letter.

*Caution!* To edit the Trigger Delay, you must select the unit by means of the cursor keys (see above).

**Drop-down lists**

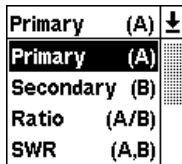

Drop-down lists are used to select an item from an “a la carte” list. When the drop-down list is activated, the list “folds out” upwards or downwards.

The up/down cursor keys, or one of the rocker switches next to the list, are used to select items from folded out pop-up menus. Confirm the selection with the **MENU** key or reject with the **ESC** key.

# Display windows

## Window sizes and types

Results are displayed in the main section of the screen in windows. Windows come in three sizes: half height, quarter height and full height. In windows, values can be displayed digitally or in a combined digital and analog mode (See Chapter 4, section "Displaying measurement results", for instructions on selecting these modes).

DIG window, full height

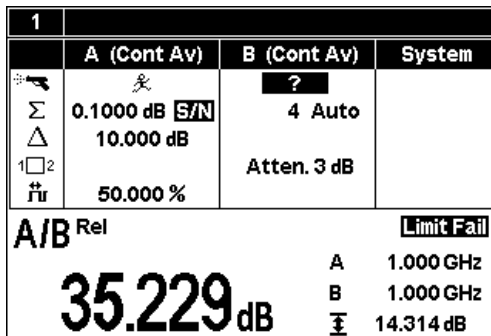

Analog window, full height

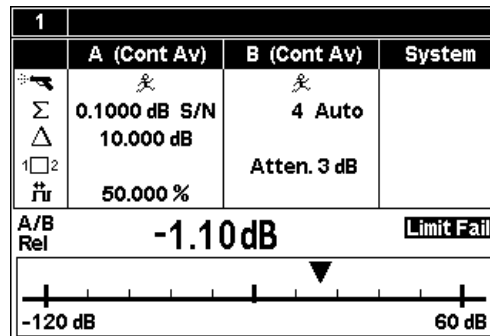

Scope window, full height

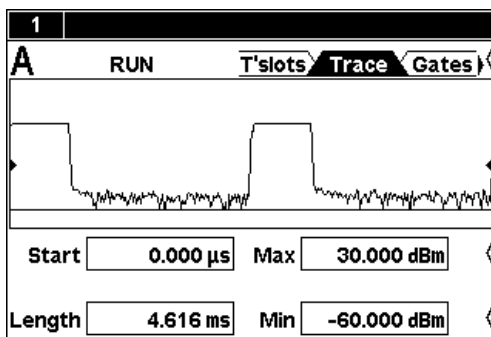

Scope window, half height

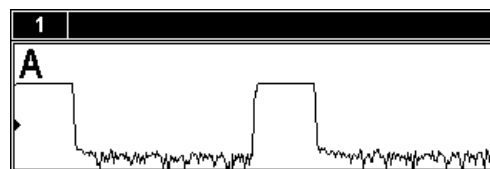

DIG window, half height



Analog window, half height

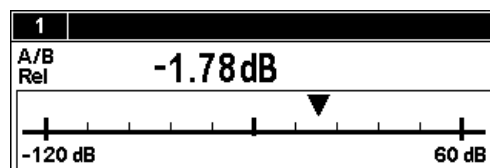

DIG window, quarter height















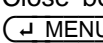





Analog window, quarter height



You can expand all opened windows to full height by activating the **Expand** function from the **Windows** menu. In this state, the full-height windows can be displayed consecutively using the **Window 1 2 3 4** menu item. The opened windows can be reduced to their previous sizes with the **Arrange** menu item. Otherwise, it is not possible to change the size of the windows – the window size is determined by the number of windows.

## Special symbols

The following table defines the individual symbols:

Window symbols		Display values	
	Window number	A 1.000 GHz B 1.000 GHz	Frequency in the primary and secondary channel
	Window name		
	Close box, operated with the  key		Auxiliary value; here, max-min
Measurement function		Auxiliary value symbol	
<b>A/B</b>	Measurement function		Max-Min
<b>Rel</b>	Relative measurement mode ON		Max
			Min
Correction functions			
	Duty cycle correction ON		
	Offset correction ON		
	Twoport correction ON (S-parameter device)		
Filter		Trigger symbols	
$\Sigma$	Averaging filter		Trigger
<b>4 Auto</b> <b>64 Man</b>	Filter size with auto-filter (normal mode) or for manual mode		Free-running trigger
<b>0.1000 dB S/N</b>	Noise component with auto-filter in "Fixed Noise" mode		Trigger remains OFF
<b>S/N</b>	Noise ratio exceeded	<b>1TRIG</b>	Single-shot mode, trigger expected
Other		<b>1TRIG</b>	Single-shot mode, measurement over
	Battery level indicator	<b>A B C D Ext</b>	Trigger source (channel A, B, C, D or external)
	Battery charging		Trigger on rising slope
<b>Limit Fail</b>	Over limit		Trigger on falling slope
		<b>RUN</b>	Measurement in progress
		<b>STOP</b>	Measurement stopped

## Table of Contents

<b>4 Instrument Functions</b> .....	4.1
<b>Hardkeys</b> .....	4.2
Stored settings (Presets) .....	4.2
Frequency settings (FREQ).....	4.3
Zeroing (ZERO/CAL) .....	4.3
Test Measurement (ZERO/CAL) .....	4.4
Test Report .....	4.5
Configuring the test measurement.....	4.5
Contrast and brightness (Contrast/Brightness) .....	4.6
<b>Data acquisition and parameters (Sensor menu)</b> .....	4.7
Setting the measurement mode.....	4.7
Free-running average-power measurements .....	4.8
Measuring the average burst power .....	4.11
Measuring the power of TDMA signals.....	4.13
Measuring power in gates.....	4.14
Analyzing the envelope power.....	4.15
Offset correction .....	4.16
Table editor for offset tables .....	4.18
Filter / averaging .....	4.19
Measurement ranges.....	4.22
Effect of the RF source .....	4.23
Trigger settings .....	4.24
Trigger sequence control.....	4.26
<b>Displaying measurement results (Windows menu)</b> .....	4.27
Window labelling.....	4.27
Arranging windows .....	4.27
The windows menu.....	4.27
Selecting a window .....	4.27
Using windows.....	4.28
Opening windows (Open) .....	4.28
Creating windows (Init) .....	4.28
Closing windows (Close).....	4.28
Expanding windows (Expand).....	4.29
Arranging windows (Arrange) .....	4.29
Selecting the result display mode.....	4.29
Configuring the result display .....	4.30
Setting the resolution (Resolution).....	4.30
Setting the analog scale (Scale) .....	4.31
Scrolling between timeslots (Timeslot #) .....	4.31

<b>Configuring measurements (Measurement menu)</b> .....	4.32
Measurement windows .....	4.32
The Measurement menu.....	4.32
Selecting a window .....	4.32
Selecting a measurement function .....	4.33
Functions and their use.....	4.34
Expanded configuration for sensors in the Scope mode .....	4.35
Setting units .....	4.36
Setting the auxiliary value .....	4.38
Resetting the extreme value display .....	4.38
Additional functions.....	4.39
Relative measurements .....	4.39
Setting the reference value manually .....	4.39
Limit monitoring.....	4.40
<b>Displaying data in the Scope mode</b> .....	4.41
Switching the sensor to the Scope mode .....	4.41
Selecting a window .....	4.43
Trigger settings .....	4.43
Filter settings .....	4.43
Setting parameters .....	4.44
Trace .....	4.44
T'slots.....	4.45
Gates.....	4.46
Meas .....	4.47
<b>Management of settings (File menu)</b> .....	4.49
Default setting (Preset) .....	4.49
Storing user-defined settings (Setups) .....	4.49
Loading user-defined settings (Setups).....	4.50
Loading settings for mobile radio standards.....	4.50
Programming aids.....	4.52
Assigning names to windows.....	4.52
<b>System settings (System menu)</b> .....	4.54
Configuring the remote control interfaces.....	4.55
Selecting a remote control interface .....	4.55
Configuring the GPIB.....	4.55
Remote control via USB.....	4.56
Configuring the Ethernet .....	4.56
Setting the analog outputs .....	4.58
Selftest .....	4.60
Keyboard test.....	4.61
Test generator .....	4.62

System information .....4.62  
    Information about sensors .....4.62  
    Information about the R&S NRP .....4.63  
Miscellaneous Operation at low ambient temperatures .....4.64  
  
**Messages and alarms .....4.65**



**Figs.**

Fig. 4-1	Setup dialog box .....	4.2
Fig. 4-2	Frequency dialog box.....	4.3
Fig. 4-3	Zero/Cal dialog box.....	4.3
Fig. 4-4	Zeroing error message.....	4.4
Fig. 4-5	Zero/Cal dialog box.....	4.4
Fig. 4-6	Test Report dialog box.....	4.5
Fig. 4-7	Config Test dialog box .....	4.6
Fig. 4-8	Display dialog box.....	4.6
Fig. 4-9	Sensor menu.....	4.7
Fig. 4-10	Mode dialog box.....	4.7
Fig. 4-11	Mode dialog box, Normal mode .....	4.8
Fig. 4-12	Mode dialog box, Burst mode .....	4.11
Fig. 4-13	Mode dialog box, Timeslot mode .....	4.13
Fig. 4-14	Mode dialog box, Timegate mode.....	4.14
Fig. 4-15	Offset dialog box .....	4.16
Fig. 4-16	Offset dialog box, Table editor .....	4.18
Fig. 4-17	Filter dialog box.....	4.20
Fig. 4-18	Auto Filter dialog box .....	4.21
Fig. 4-19	Range dialog box .....	4.22
Fig. 4-20	RF Source dialog box .....	4.23
Fig. 4-21	Trigger dialog box .....	4.24
Fig. 4-22	Trigger Advanced dialog box .....	4.25
Fig. 4-23	Windows menu, Window softkey .....	4.27
Fig. 4-24	Windows menu, softkeys for controlling the windows.....	4.28
Fig. 4-25	Window menu, softkeys for controlling the display mode .....	4.29
Fig. 4-26	Windows menu, display-specific softkeys.....	4.30
Fig. 4-27	Meter Scaling dialog box.....	4.31
Fig. 4-28	Windows menu, softkey for scrolling between timeslots.....	4.31
Fig. 4-29	Measurement menu .....	4.32
Fig. 4-30	Func & Unit dialog box.....	4.33
Fig. 4-31	Func & Unit dialog box.....	4.35
Fig. 4-32	Measurement window, .....	4.38
Fig. 4-33	Ref. Value dialog box.....	4.39
Fig. 4-34	Limits dialog box .....	4.40
Fig. 4-35	Mode dialog box, Scope mode .....	4.41
Fig. 4-36	Expanded window with control elements in the Scope mode.....	4.43
Fig. 4-37	Mode dialogHalf-height window in the Scope mode.....	4.43
Fig. 4-38	Scope mode display – Trace page .....	4.44
Fig. 4-39	Scope mode display – Timeslot page.....	4.45
Fig. 4-40	Scope mode display – Gates page .....	4.46
Fig. 4-41	Scope mode display – Meas page.....	4.47
Fig. 4-42	File menu .....	4.49
Fig. 4-43	Recall Setup dialog box .....	4.49
Fig. 4-44	Recall Setup – dialog box .....	4.50

Fig. 4-45	Recall Setup dialog box .....	4.51
Fig. 4-46	Errorlist dialog box .....	4.52
Fig. 4-43	Menu bar in the remote control mode .....	4.52
Fig. 4-48	Window Name dialog box .....	4.52
Fig. 4-49	System menu .....	4.54
Fig. 4-50	Remote dialog box .....	4.55
Fig. 4-51	Remote dialog box, GPIB .....	4.55
Fig. 4-52	Remote – Dialog, GPIB.....	4.56
Fig. 4-53	Remote – Dialog, GPIB.....	4.56
Fig. 4-54	IP Address – Dialog, Manual .....	4.57
Fig. 4-55	IP Address – Dialog, DHCP .....	4.57
Fig. 4-56	Analog Out dialog box.....	4.58
Fig. 4-57	Selftest dialog box.....	4.60
Fig. 4-58	Selftest Keyboard dialog box .....	4.61
Fig. 4-59	Sensor Info dialog box .....	4.62
Fig. 4-60	System Info dialog box.....	4.63
Fig. 4-61	Miscellaneous dialog box.....	4.64

## Tables

Table 4-1	Example of a network configuration for a direct R&S NRP – PC connection using a crossover cable.....	4.57
-----------	---	------

# 4 Instrument Functions

This Chapter contains a systematic description of the R&S NRP's functions in the order in which they occur in the menus.

The grey text in the headings provides additional information that should prove helpful.







- Hardkeys for opening dialog boxes: ----- KEY
- Menu items which directly perform an operation when selected: ----- Menu→menu item
- Menu items that open dialog boxes: ----- Menu→menu item...
- Dialog-box elements: Dialog: Dialog element

**The symbols in the left-hand column of the description indicate the following:**

Sensor menu:

Context in which the operation below can be performed.

Mode dialog:

Name	- 	Softkey (menu item or dialog element)
	<span style="border: 1px solid black; border-radius: 50%; padding: 2px;">KEY</span>	Hardkey
	- 	Function is activated with the left-hand side of the rocker switch.
	- 	Function is activated with the right-hand side of the rocker switch.
	- 	Function can be activated with either side of the rocker switch.
	- 	Selection function (change direction by pressing the other side of the rocker switch)
		Action arrow
Action		Result

# Hardkeys

The main settings for the Power Meter R&S NRP can be accessed via hardkeys.

## Stored setting



**(PRE)SET** is used to change the instrument to its default state (Preset) or to a user-defined (Setup) state (maximum of 10 possible); pressing this key once opens the File menu; pressing it a second time loads the Preset setting. The user-defined setups and settings for measurements on mobile radio standards can also be loaded from the File menu.

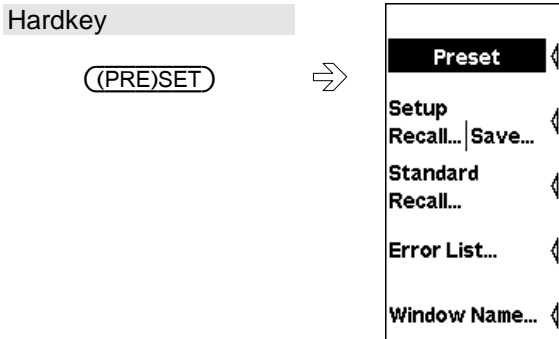
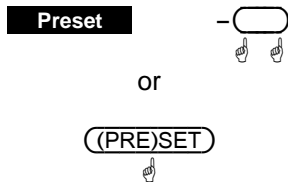

Fig. 4-1 Setup dialog box



Changes the R&S NRP to its default state (Preset).

**✓ Tip**

The black background of the text indicates that the function can also be started by pressing the **(PRE)SET** hardkey if the File menu is open.

Remote Control

\*RST (Default state for remote-control operation)

or

SYSTEM:PRESet (Default state for manual operation)

## Frequency setting

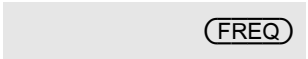

**FREQ** is used to set the carrier frequency of the applied signal. This corrects any frequency-dependent effects introduced by the sensor.

If the sensor is to reach the specified measurement accuracy, a frequency entry must be made.

Hardkey

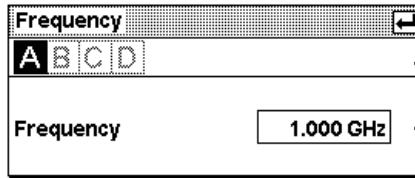

Fig. 4-2 Frequency dialog box

A | B | C | D



Tabs for selecting the sensor.

Frequency



Field for frequency entries with the units kHz, MHz or GHz.

Remote Control

[SENSe[1..4]]:FREQuency[:CW|:FIXed][?] <float\_value>



## Zeroing

**ZERO/CAL** starts the autozero function or a test to check the confidence level of sensor results (see next section).

Hardkey

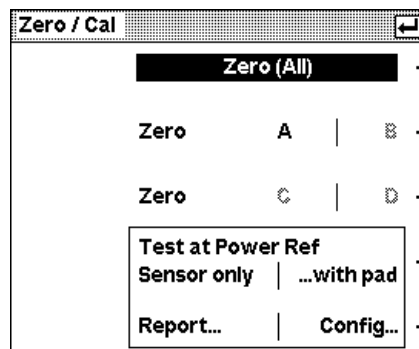

Fig. 4-3 Zero/Cal dialog box

Zero All



Zeroes all connected sensors.

or



### ✓ Tip

The black background of the text indicates that the function can also be started by pressing the **ZERO/CAL** hardkey if the Zero/Cal dialog box is open.

Remote Control

CALibration:ALL:ZERO:AUTO[?] ONCE



### Caution

Turn off all test signals before zeroing.

**Zero A | B**  Starts zeroing in channel A.

**Zero A | B** Zeroing for channels B, C and D.

**Zero C | D**

**Zero C | D**

Remote Control  
`CALibration[1..4]:ZERO:AUTO[?] ONCE`

**Zeroing failure**

If the power measured during zeroing is too large, the R&S NRP reports an error. The most common cause of this error is that the user started zeroing without turning off the test signal beforehand. Otherwise the sensor probably has a hardware defect.

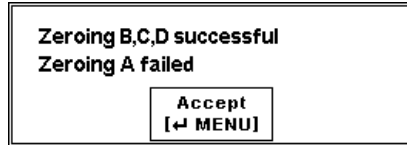

Fig. 4-4 Zeroing error message

## Test Measurement

The R&S NRP-Z power sensors are absolutely calibrated; a calibration measurement after switching on the instrument is not necessary and also not planned. The sensors should be recalibrated in regular intervals; for details on this, please refer to the data sheet. However, overload, other damage or extreme operating conditions may cause the measurement uncertainty to exceed the specified values.

The option R&S NRP-B1 (sensor check source) makes it possible to check the reliability of the sensor by performing a test measurement. In the case of sensors with a lead-in attenuator (pad) – R&S NRP-Z22, R&S NRP-Z23 and R&S NRP-Z24 – the test measurement can be made with or without an attenuator.

**Hardkey**

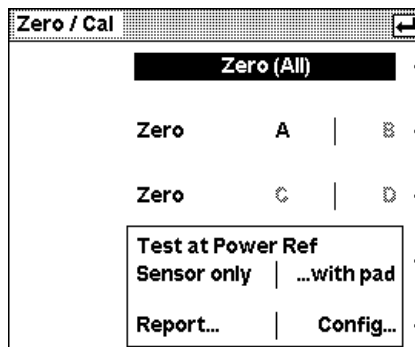



Fig. 4-5 Zero/Cal dialog box

**Test at Power Ref Sensor only** 

Starts a test measurement for a sensor without a lead-in attenuator. The sensor must be connected to the sensor check source. If an attenuator is present, it must first be removed.

**Test at Power Ref ...with Pad** 

Starts a test measurement for a sensor with a lead-in attenuator. The sensor with attenuator must be connected to the sensor check source.

**Report...** 

Opens the dialog box displaying the results of the test measurement.

**Config...**  Opens a dialog box for entering tolerance limits.

## Test Report

The test report shows the type and serial number of the tested sensor, and on two pages the deviations between the sensor and the power reference. Differences up to 0.02 dB at room temperature are absolutely normal and are due to the uncertainty in the calibration of the sensor and the power reference. Greater differences can be caused by high/low ambient temperatures but also by a damage to the sensor.

With multipath sensors (R&S NRP-Z2x family), the paths are each measured individually and the results displayed separately.

Zero/Cal dialog box

**Report...**

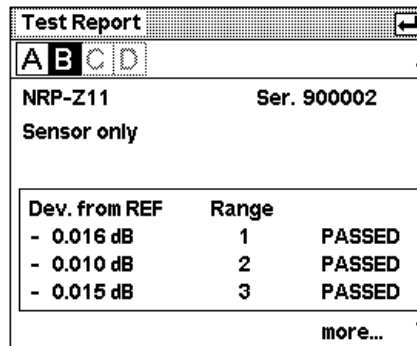

Fig. 4-6 Test Report dialog box

**A | B | C | D**



Tabs for selecting the measurement channel. When the dialog box opens, it shows the data of the sensor last tested. The measured values are lost when the R&S NRP is switched off.

**More...**



Switches between the pages **Sensor only** and **Sensor & Pad**.

**Previous...**

## Configuring the test measurement

The tolerance limits can be set in this dialog box; exceeding these limits results in an error message. The factory default settings depend on the sensor and are in line with the data sheet values. They should be observed in the entire ambient temperature range. If the base unit and the sensors are used only at room temperature, the tolerance limits can be restricted so that any damage to the sensor can be quickly detected.

Zero/Cal dialog box

Config...

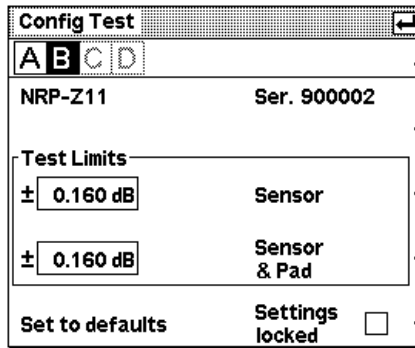
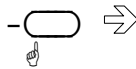

Fig. 4-7 Config Test dialog box

A | B | C | D



Tabs for selecting the measurement channel. When the dialog box opens, it shows the data of the sensor last tested.

Test Limits  
Sensor



Tolerance limits for sensors without a lead-in attenuator or with an attenuator that has been removed.

Test Limits  
Sensor & Pad



Tolerance limits for sensors with a lead-in attenuator.

Set to defaults



Resets the factory default settings.

Settings locked



Protects the settings against being changed by mistake.

## Contrast and brightness

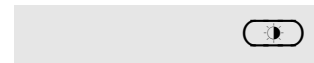

Hardkey



Fig. 4-8 Display dialog box

Contrast



Sets the display contrast.

Brightness



Sets the display brightness.

Remote Control  
DISPlay: ILLumination[?] ON | OFF



# Data acquisition and parameters

Sensor - menu

Depending on the options that have been installed, up to four sensors can be connected to the R&S NRP. The sensors perform the complete power measurement from the acquisition of the RF signal to every aspect of result processing. All parameters for configuring data acquisition are entered in the Sensor menu. Some of the parameters listed below are not available for certain types of sensor.

The Sensor menu contains the following items:

Mode...	☞ Setting the measurement mode, page 4.7.
Offset...   Filter...	☞ Offset correction, page 4.16 and ☞ Filter / averaging, page 4.19.
Range...	☞ Measurement ranges, page 4.22.
RF Source...	☞ Effect of the RF source, page 4.23.
Trigger...	☞ Trigger settings, page 4.24.

Fig. 4-9 Sensor menu

## Setting the measurement mode

Sensor→Mode...

The measurement mode is selected and configured in the Mode dialog box. In addition to the *Cont Av* mode, there are further measurement modes for the various sensor types available.

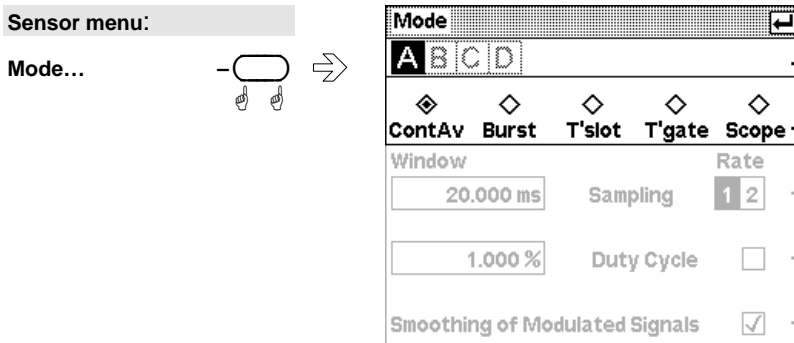

Fig. 4-10 Mode dialog box

A | B | C | D      - [Touch icon]      Tabs for sensor selection.

Cont Av, Burst...      - [Touch icon]      Measurement modes.  
 In the Continuous Average mode, the average signal power is continuously measured without the window and signal being in sync. (☞ Free-running average-power , page 4.8).

The Burst mode is for measuring the average burst power of pulsed signals. (☞ Measuring the average burst power, page 4.11).

In the Timeslot and Timegate modes, the average power can be measured over defined time intervals of a periodic signal.

The Timeslot mode should be used preferably for TDMA signals with

multiple timeslots (☞ Measuring the power of TDMA signals, p. 4.13).

The Timegate mode provides four user-configurable gates for measurement (☞ Measuring power in gates, p. 4.14).

In the Scope mode, the R&S NRP records the power versus time and displays it graphically. The time parameters of the Timeslot and Timegate modes can also be interactively configured in this mode (☞ Analyzing the envelope power, p. 4.15).

**Remote Control**

```
[SENSe[1..4]]:FUNction[:ON][?] <string>
```

**Free-running average-power measurements**

Mode : Cont Av

The Continuous Average mode is the preferred measurement method if the measurement is not to be, or cannot be, synchronized with a specific signal event.

This is the only available measurement mode for thermal sensors because they are too slow for the other measurement modes.

Mode dialog box:

Cont Av, Burst...

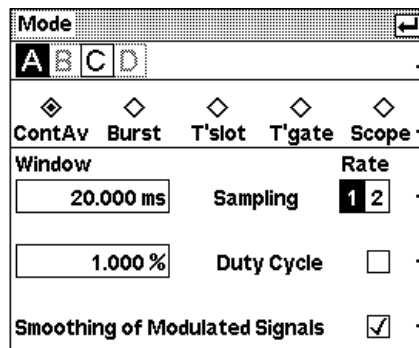

Fig. 4-11 Mode dialog box, Normal mode

Sampling Window



This parameter defines the duration of the measurement window. In the manual mode, the default setting of 20 ms combined with smoothing (see below) is usually adequate. Another value, generally larger, is essential if the result exhibits fluctuations due to modulation. With very low frequency modulation in particular, it is a good idea to set the size of the sampling window so that it exactly equals the modulation period, so ensuring optimal display settling:

		Optimal sampling-window size
Smoothing	Off	$N \times \text{modulation period} / 2$
	On	$N \times \text{modulation period} \times 2$

$N = 1, 2, 3, \dots$

This means that the minimum theoretical measurement time can only be obtained with smoothing turned off.

The more modulation periods fit into a sampling window, the less critical it is whether  $N$  is an integer or not. With smoothing on, about five periods are enough to reduce fluctuations caused by modulation to an acceptable level – even if  $N$  is not an integer. With more than nine periods, the fluctuations are imperceptible. With smoothing off, the situation is much less favourable as instead of just five periods as many as 300 are required; the fluctuations only completely disappear with more than 3000 periods.

However, it is not advisable to make the sampling window too wide by selecting an excessively large  $N$ , as the intrinsic noise of the sensor increases. To reduce display fluctuations due to noise, it is best to use the averaging filter. (☞ Filter / averaging, page 4.19)

For more information, see ☞ Background information, page 4.10.

Remote Control

```
[SENSe[1..4]][:POWer][:AVG]:APERture[?] <float_value>
```

Sampling Rate



If a sensor contains a sampling A/D converter, the sampling rate can be adjusted to prevent aliasing effects for particular types of modulation signal. Aliasing can occur with some sensors because the sampling frequency is located within the video bandwidth, which means that spectral components of the modulation signal can fall in this frequency range. Changing the sampling rate will make the aliasing effects disappear.

Remote Control

```
[SENSe[1..4]]:SAMPling[?]  FREQ1 | FREQ2
```

Duty Cycle



Using the duty cycle correction, the average power of RF bursts can be calculated from the average power of the whole signal. The average power of the whole signal is divided by the duty cycle of the signal.

If thermal sensors are used, this is the only way of determining burst power.

If diode sensors from the R&S NRP-Z1x and R&S NRP-Z2x series are used, this method must be employed if the bursts are so short that their power cannot be measured in the *Burst Av* or *Timeslot* modes.

Remote Control

```
[SENSe[1..4]]:CORRection:DCYClE:STATe[?]  ON | OFF
[SENSe[1..4]]:CORRection:DCYClE[:INPut][:MAGNitude][?]
<float_value>
```

Smoothing of modulated Signals



To reduce result fluctuations caused by modulation, this parameter should always be activated if the size of the sampling window cannot be exactly adjusted to the modulation period or if this is not required. If the size of the sampling window is 5 to 9 times greater than a modulation period, in general, the reduction in display fluctuation will be sufficient. With smoothing off, 300 to 3000 periods are required to obtain the same effect (☞ Sampling Window).

Remote Control

```
[SENSe[1..4]][:POWer][:AVG]:SMOothing:STATe[?]  ON | OFF
```

**Background information***Sampling window*

As the sensor amplifiers use chopping, a measurement comprises at least two sampling windows and a sensor-specific deadtime of a few 100  $\mu\text{s}$ . Samples at equal time intervals over the duration of a sampling window are taken and a partial measurement result is formed from these samples. The partial measurement results of two adjacent sampling windows are combined and the average is either output as the final result or is subjected to further averaging as one of a number of intermediate results (☞ Filter / averaging, page 4.19).

In the remote control mode, the sampling window determines the minimum measurement time that can be achieved ( $2 \times$  sampling window + deadtime). However, there is no point in selecting sampling window times very much smaller than 1 ms if, to reduce display noise, the averaging filter has to be used. Due to the unavoidable deadtime of the order of a few 100  $\mu\text{s}$  per sampling window, the measurement time does not drop in proportion to the reduction in sampling window time. This may even mean that, to obtain a well-defined noise component in the result, a greater measurement time overall is required, if a sampling window that is too small is selected.

*Smoothing modulated signals*

With smoothing turned off, the samples within a sampling window are given equal weighting and averaged, which turns the instrument into an integrating device. As described above, optimal reduction of fluctuations in the measurement result due to modulation can be obtained, if the size of the sampling window is an exact integer multiple of the modulation period. If this is not the case, modulation can have a considerable effect even if the sampling window is many times greater than the modulation period. This situation can be improved considerably if the samples are weighted (raised von-Hann window) before averaging. This is like video filtering and is exactly what happens when smoothing is activated.

## Measuring the average burst power

Mode : Burst Av

The Burst Average mode is the simplest method of measuring the average burst power. It is available with sensors from the R&S NRP-Z1x and R&S NRP-Z2x series.

When this mode is selected, the sensor itself detects the start and end of the burst; no external trigger signal is required. The parameter Dropout Tolerance and the trigger parameters Holdoff and Hysteresis are ways of providing stable triggering. Using the parameters Exclude from Start and Exclude from End, the starts and ends of bursts can be excluded from the measurement. This means that signal overshoots can be omitted from measurements, for example.

### Mode dialog box:

Cont Av, Burst...

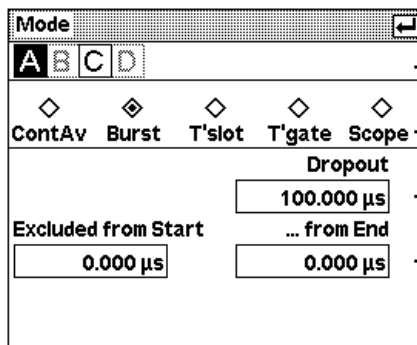
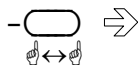

Fig. 4-12 Mode dialog box, Burst mode

Dropout Tolerance



Prevents brief power drops due to modulation from being misinterpreted as the end of a burst.

Remote Control

```
[SENSE[1..4]][:POWER]:BURSt:DTOLerance[?] <float_value>
```



### Caution

The Dropout Tolerance must be less than the no-power interval between the end and start of a burst.

Excluded from End



This time interval at the end of the burst is excluded from the measurement.

Remote Control

```
[SENSE[1..4]]:TIMing:EXCLude:STOP[?] <float_value>
```

... from Start



This time interval at the start of the burst is excluded from the measurement.

Remote Control

```
[SENSE[1..4]]:TIMing:EXCLude:START[?] <float_value>
```

### ✓ Tip

For the most common mobile radio standards, the specified parameters can easily be loaded via the "Recall Standard" dialog box in the File menu.

## Background information

### Dropout tolerance

The **Dropout** parameter facilitates the clear identification of the burst end of modulated signals (e.g. NADC). Without this parameter, the end of the burst might erroneously be detected within the burst owing to the considerable modulation-specific power drops of such signals. **Dropout** is set at least for the duration of modulation-dependent power drops within the burst; thus, the end of the burst cannot be detected until the set time has elapsed after the power has dropped below the trigger threshold. If the trigger threshold is exceeded again during the dropout time, the process restarts from the beginning.

### Timing diagram

The timing diagram below shows the relation between the following parameters:

- Trigger threshold and trigger event
- Trigger event, exclude intervals and measurement interval
- During the burst the signal frequently falls below the trigger threshold without the end of a burst being detected. The reason for this is that the signal then also quickly exceeds the trigger threshold, which means that the dropout time has not yet elapsed.
- During the dropout time indicated below, the signal no longer exceeds the trigger threshold so that the last falling slope in the burst is detected as the end of the burst.

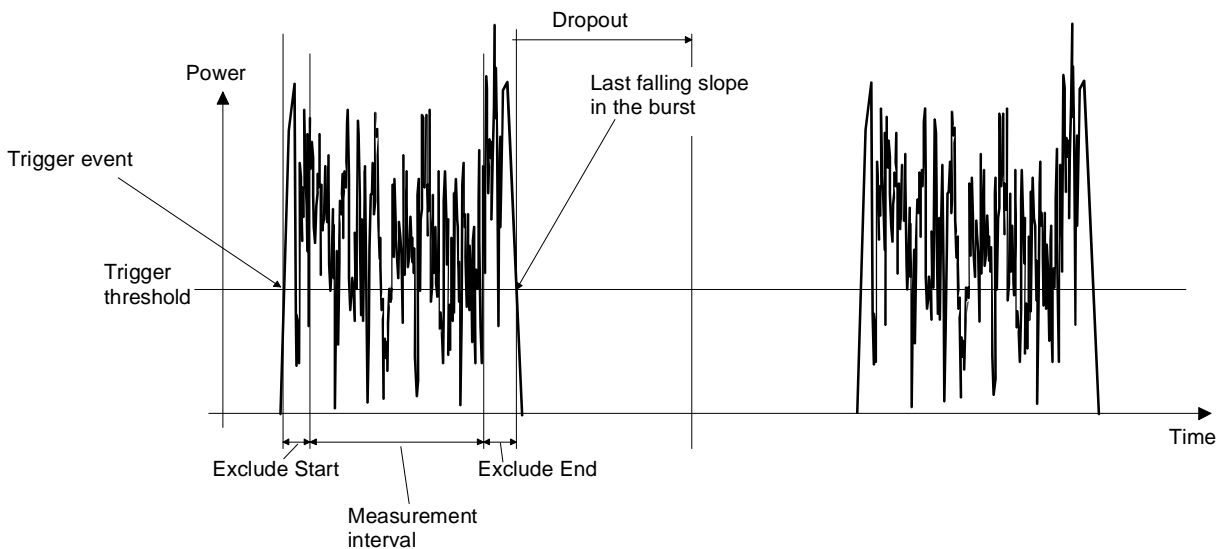

## Measuring the power of TDMA signals

Mode : Timeslot

The Timeslot mode is an easy-to-configure method for simultaneously measuring average power in multiple timeslots of a TDMA signal. It is available only with sensors of the R&S NRP-Z1x and R&S NRP-Z2x families.

This measurement mode can be used only if all timeslots of the TDMA signal are equal in length. Up to 26 timeslots are allowed. A period to be excluded from the measurement can be defined at the beginning and end of each timeslot by using the Excluded from Start and Excluded from End parameters.

Measurement can be started with an external trigger signal or automatically triggered by an internal signal. (☞ Trigger settings, p. 4.24).

### Mode dialog box:

Burst Av, T'slot...

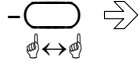

ContAv	Burst	T'slot	T'gate	Scope
<b>No. of Timeslots</b>		<b>Nominal Width</b>		
8		1.000 ms		
<b>Excluded from Start</b>		<b>... from End</b>		
0.000 μs		0.000 μs		

Fig. 4-13 Mode dialog box, Timeslot mode

No of Timeslots



Number of timeslots on which a simultaneous meas. is to be made.

Remote Control

```
[SENSE[1..4]][:POWER]:TSLot:COUNT[?] <int_value>
```

Nominal Width



Timeslot length.

When measurements are made on TDMA signals (GSM/EDGE, PDC, NADC, PMS etc), the nominal timeslot length must be entered here, i.e. the frame length divided by the number of timeslots.

GSM example:

Frame length: 4.615 ms

No. timeslots: 8

⇒ Nominal width  $4.615 / 8$  ms  
= 576.875 μs

Remote Control

```
[SENSE[1..4]][:POWER]:TSLot:WIDTH[?] <float_value>
```

Excluded from End



... from Start



These intervals at the start/end of the timeslot whose length is defined with **Nominal Width** are excluded from the measurement. Measurement can thus be restricted to the relevant part of a timeslot.

Remote Control

```
[SENSE[1..4]]:TIMing:EXCLude:START[?] <float_value>  
[SENSE[1..4]]:TIMing:EXCLude:STOP[?] <float_value>
```

### ✓ Tip

For the most common mobile radio standards, the specified parameters can easily be loaded via the "Recall Standard" dialog box in the File menu. They can also be set interactively in the Scope mode (☞ T'slots, p. 4.45).

Background information

Timing diagram

The timing diagram below shows the relation between the following parameters:

- Trigger event, trigger delay and start of the first timeslot
- Width, exclude intervals and measurement interval of the timeslots

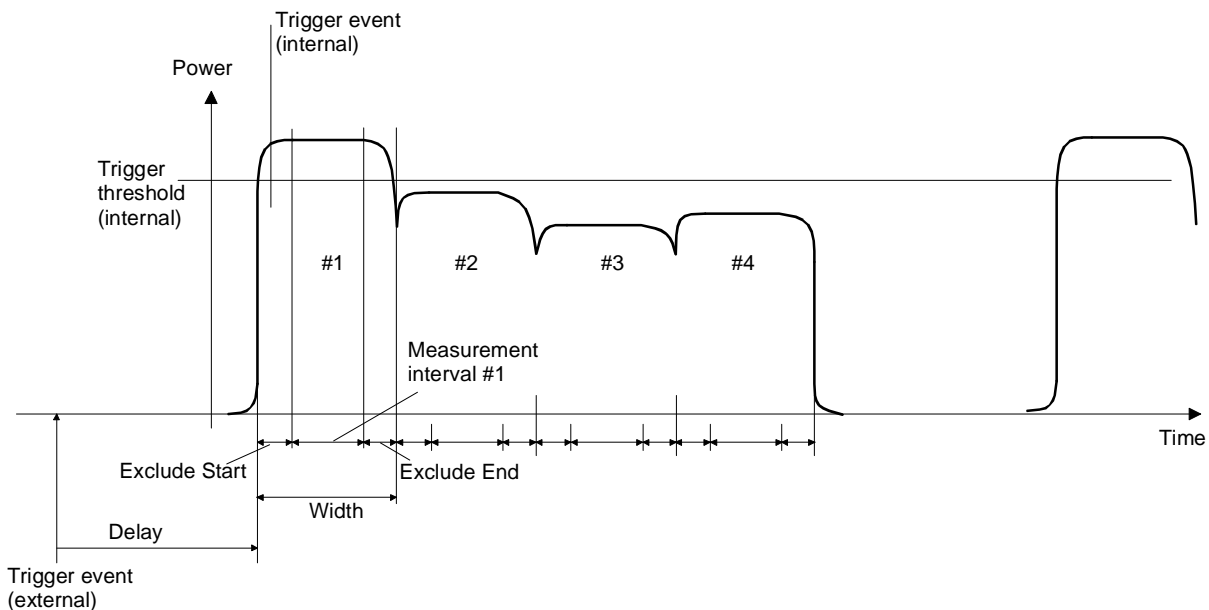

Measuring power in gates

Mode : Timegate

The Timegate mode is used to measure power in time windows (gates). Up to four different gates can be configured, although measurement can be performed only in one of them at a time.

Measurement can be started with an external trigger signal or automatically triggered by an internal signal. (☞ Trigger settings, p. 4.24).

Mode dialog box:

T'slot, T'gate...

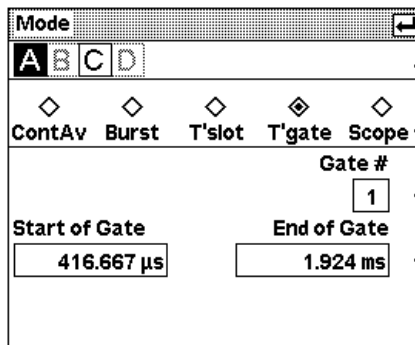







Fig. 4-14 Mode dialog box, Timegate mode



<b>Gate#</b>	- 	<p>Number of the gate to be configured.</p> <p>Remote Control</p> <p>In the following commands, the gate to be configured is determined by the TGATe suffix.</p>
<b>Start of Gate</b>	- 	<p>Start or end of the gate referenced to the delayed ( Trigger settings, Trigger Delay, p. 4.24) trigger time.</p>
<b>End of Gate</b>	- 	<p>Remote Control</p> <p>[SENSe[1..4]][:POWer]:TGATe[1..4]:OFFSet:TIME[?] &lt;float_value&gt;</p> <p>[SENSe[1..4]][:POWer]:TGATe[1..4]:TIME[?] &lt;float_value&gt;</p>

**✓ Tip**

These parameters can also be set interactively in the Scope mode ( Gates, p. 4.46).

**Analyzing the envelope power**

The Scope mode is used to record envelope power versus time. Its configuration and operation are described in  Displaying data in the Scope mode on page 4.41.

## Offset correction

Sensor→Offset...

The Offset dialog box is for activating and entering correction factors to effect an increase or decrease in the measurement result which is not level-dependent. This means that the effects of any attenuators, directional couplers or amplifiers that are connected ahead of the sensor can be allowed for.

**Global** is used to set a fixed correction factor. Frequency-dependent corrections can be made with **Table**. Both types of correction can be made simultaneously.

**S Parameter Device** is for correcting the effects of a twoport connected ahead of the sensor in terms of its S-parameters. The S-parameters of the twoport must be stored in the sensor (see *Program module Update S\_Parameters* in the sensor operating manual).

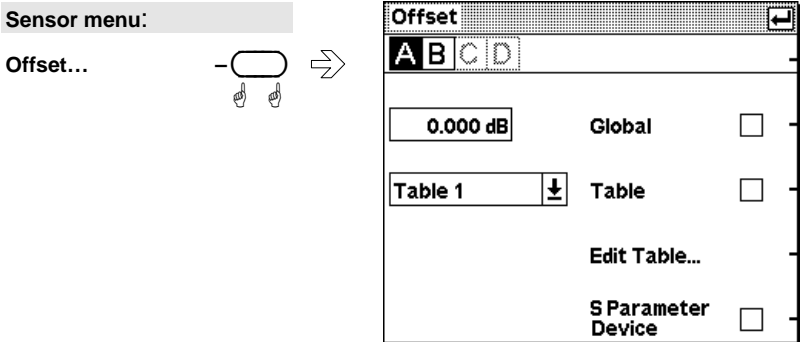

Fig. 4-15 Offset dialog box

A | B | C | D      - [softkey icon]

Tabs for selecting the sensor.

[...] Global      - [softkey icon]

Field for entering the global offset. Positive values correspond to external losses, negative values to external gains.

Remote Control  
[SENSE[1..4]]:CORRection:OFFSet[?] <float\_value>

Global      [checked] - [softkey icon]

Activates the global offset correction.

Remote Control  
[SENSE[1..4]]:CORRection:OFFSet:STATe[?] ON | OFF

Table      - [softkey icon]

The left-hand Table softkey opens a drop-down list with correction tables. There are 10 tables, each of which can contain up to 80 frequency/offset pairs. The default names of the Tables are Table 1 to Table 10; however, the names can be changed using the table editor.

Remote Control  
[SENSE[1..4]]:CORRection:FDOTable[:SElect][?] <string>

Table      - [softkey icon]

Activates the frequency-dependent offset correction specified in the Table you have selected.

Remote Control  
[SENSE[1..4]]:CORRection:FDOTable:STATe[?] ON | OFF

**Edit Table...**

Opens a dialog box for editing the selected offset correction table.

Remote Control

```
MEMory:TABLE:FREQuency[?] <Nrf>{ ,<Nrf>}
MEMory:TABLE:GAIN[:MAGNitude][?] <Nrf>{ ,<Nrf>}
```

**S Parameter Device**

Activates the S-parameter set stored in the sensor for a twoport that has been connected ahead of the sensor.

Remote Control

```
[SENSe[1..4]]:CORRection:SPDevice:STATe[?] ON | OFF
```

Table editor for offset tables

Offset : Edit Table...

The table editor displays the name of the table being edited in its title bar. Below the title bar, there is a two-column list containing frequency and offset pairs.

There are two table-editor modes:

- **Selection mode:** In this mode, using the cursor keys, you can select the number field you want to Edit, Insert OR Delete.

*Note:* The whole of a long list cannot be displayed in the window. The entries are, therefore, viewed through a “window” which automatically moves if the cursor keys take the cursor outside the section that can be seen. The position of the currently active field is shown by the scroll bar.

- **Edit mode:** When you press the Edit rocker switch the value in the selected field can be edited. In this mode, the cursor keys cannot be used for selection, but can be used “normally” to edit values in the entry field.

Offset dialog box:

Edit Table



Table 1		
Frequency	Offset	Edit
1.00 GHz	10.42 dB	
1.10 GHz	9.72 dB	Insert
1.20 GHz	9.85 dB	Delete
1.30 GHz	10.11 dB	
1.40 GHz	11.06 dB	Sort
1.50 GHz	12.30 dB	
1.60 GHz	12.70 dB	
1.70 GHz	13.55 dB	Name

Fig. 4-16 Offset dialog box, Table editor



In the selection mode, the cursor keys are used to select the field you want to edit.

Edit



For selecting the edit mode for the marked field.

The entry can be confirmed with the **↓MENU** key or aborted with the **ESC** key. Afterwards, the table editor is again in the selection mode.

Insert



Inserts a new line containing the values of the selected line. The values from the line in the selected field are also copied into the new fields. The maximum table length is 80 lines.

Delete



Deletes the marked line.

Sort



Sorts the lines in the table so that the frequencies in the lines are in ascending order.

Name



For renaming the selected table to make it easier to identify. The character editor is described in Chapter 3, in the section *Dialog boxes and their controls*.

```
Remote Control
MEMory:TABLE:MAP <string>,0..9
```

## Filter / averaging

Sensor→Filter...

The averaging filter is used to reduce fluctuations in the measured result to the extent desired. Such fluctuations can be caused by inherent noise of the measuring instrument, modulation of the measurement signal or beats from the superposition of adjacent carriers. A more stable display has to be traded off against longer measurements.

*Note* In manual mode, “longer measurements” does not mean that it takes longer to display a new result, but rather that it takes longer for the result to settle when the power changes.

The measurement result is obtained from a two-stage averaging process. First, a measured value is obtained for the time window specified in the Mode dialog box – either by weighted summation of samples or by integration.

Mode	Sensor	Time window
ContAv	R&S NRP-Z1x or R&S NRP-Z2x	☞ Sampling Window (page 4.10)
Timeslot	R&S NRP-Z1x or R&S NRP-Z2x	☞ Nominal Width (page 4.13)
Burst	R&S NRP-Z1x or R&S NRP-Z2x	Determined by the sensor according to the signal
Gate	R&S NRP-Z1x or R&S NRP-Z2x	End of Gate – Start of Gate ☞ Measuring power in gates (page 4.14)

Measurements are continuously repeated in the selected time window. Repetitions are continuous in the *ContAv* mode and trigger-controlled in the *Burst*, *Timeslot* and *Scope* modes. The measurement result is obtained by averaging the measured values for the last 2N time windows. The number N is the filter length (**Length**), the factor of 2 arises because the output signals from the microwave detector to suppress low-frequency noise are chopped at the same rate as the time windows, which means that an independent measured value can only be obtained from two consecutive values.

The filter length can be selected automatically or can be manually set to a fixed value. As a preliminary, you should always check if the autofilter mode is giving satisfactory results because you will always have to adjust an optimal, manual filter-length setting if the power is not constant.

There are two autofilter operating modes.

The **Normal** mode finds a balance between measurement time and display noise. Display noise can be adjusted using the **Resolution** parameter in the **Windows** menu (☞ Resolution, page 4.30). A higher resolution means greater filter lengths and so longer measurements.

In the **Fixed Noise** mode, the filter length is selected so that the sensor’s intrinsic noise (2 standard deviations) does not exceed the specified **Noise Content**. To avoid very long settling times when the power is low, the filter length can be limited with the **Max Settling Time** parameter. If the display noise then exceeds this preset value, the symbol **SN** is displayed.

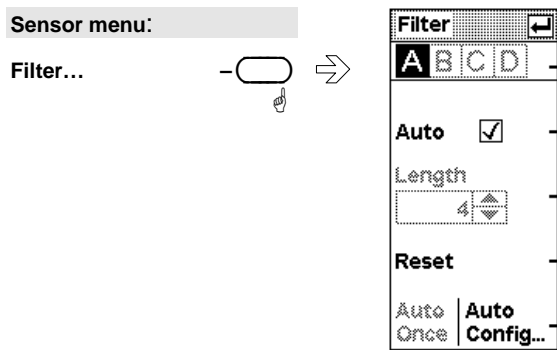





Fig. 4-17 Filter dialog box

- A | B | C | D**      

Tabs for selecting the sensor.

Remote Control  
 In the following commands, [1..4] represents the channel number (1 for channel A, 2 for channel B, etc).
- Auto**       

Toggles between automatic and manual filter setting.  
**Auto-filtering is not possible in the Scope mode.**

Remote Control  
`[SENSe[1..4]]:AVERAge:COUNT:AUTO[?] ON | OFF`
- Length**      

For setting the filter length manually. The function can be called only when autofilter is off. Changes are made immediately when a key is pressed.

Remote Control  
`[SENSe[1..4]]:AVERAge:COUNT[?] <int_value>`
- Reset**

Initializes the averaging filter with the value currently being measured. Thus, the display can be updated quickly after a change in level, particularly in the case of a large filter length.

Remote Control  
`[SENSe[1..4]]:AVERAge:RESet`
- Auto Once**      

Determines a “one-off” optimal filter length for the instantaneous measured value and enters this value in the **Length** field. This function can be called only when autofilter is off.

Remote Control  
`[SENSe[1..4]]:AVERAge:COUNT:AUTO[?] ONCE`
- Auto Config...**      

Opens a dialog box for configuring the autofilter mode.

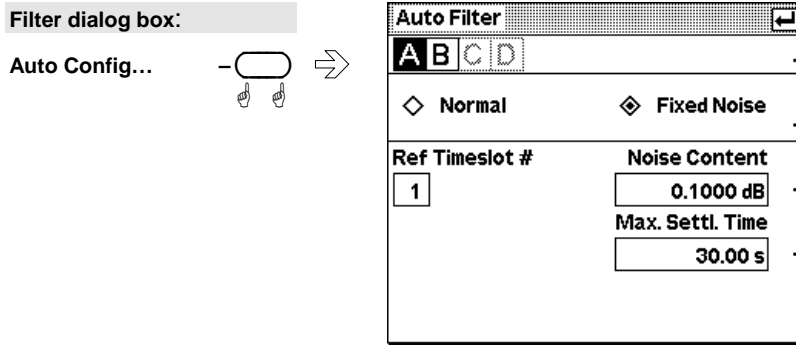







Fig. 4-18 Auto Filter dialog box

- A | B | C | D**            Tabs for selecting the sensor.
- Normal**            Selects the autofilter **Normal** mode.  
 Remote Control  
`[SENSe[1..4]]:AVERage:COUNT:AUTO:TYPE[?] RESolution`
- Fixed Noise**            Select the autofilter **Fixed Noise** mode.  
 Remote Control  
`[SENSe[1..4]]:AVERage:COUNT:AUTO:TYPE[?] RESolution`
- Noise Content**            Selects the proportion of intrinsic noise in the measured result. Specifically, **Noise Content** gives the permitted relative variation of the result which may not be exceeded for 95% of the observation time.  
 Remote Control  
`[SENSe[1..4]]:AVERage:COUNT:AUTO:NSRatio[?] <float_value>`
- Max Settling Time**            Specifies an upper limit for the settling time in the **Fixed Noise** mode. Limit exceeded **S/N**  
 Remote Control  
`[SENSe[1..4]]:AVERage:COUNT:AUTO:MTIME[?] <float_value>`
- Ref Timeslot**            Specifies the timeslot to which autofilter is applied when measurements are being performed in the **Timeslot** mode. This parameter is not available in the other measurement modes.  
 Remote Control  
`[SENSe[1..4]]:AVERage:COUNT:AUTO:SLOT[?] <int_value>`

## Measurement ranges

Sensor→Range...

R&S NRP sensors do not have measurement ranges in the conventional sense. Instead, the R&S NRP-Z1x and R&S NRP-Z2x multipath diode sensors have several measurement paths with different sensitivities which are always simultaneously active. The **Auto** range function automatically selects the most suitable paths, i.e. those that are neither overdriven or underdriven. The final measurement result for the “crossover” of the two measurement paths is derived from the measured values for both paths. There are only a few cases where it makes sense to intervene in this process, e.g. test signals with a large peak-to-average ratio.

To prevent measurement paths which have been overdriven by signal peaks from being included in the evaluation, the **User defined Crossover** function can be used to reduce levels in the measurement path crossover. The effect of setting the **Level** parameter to  $-6$  dB, for example, is to reduce the crossover by 6 dB. This corresponds to an increase in drive range of the same magnitude, which reduces measurement deviations due to modulation to 25% of the original value.

While large signal characteristics improve as the crossover level drops, the effects of zero deviations and intrinsic noise on the result become more marked. The reason for this is that above the crossover ranges the less sensitive of the two measurement paths is underdriven. This is why there is little point in changing the crossover level by more than 10 dB.

If you want to turn off the **Auto** range function, e.g. to test the drive range of a path, you can define one of the three paths as the measurement range with **Path**.

Thermal sensors (R&S NRP-Z5x) have only one measurement range over the whole dynamic range. No facilities for switching between measurement ranges are, therefore, provided.

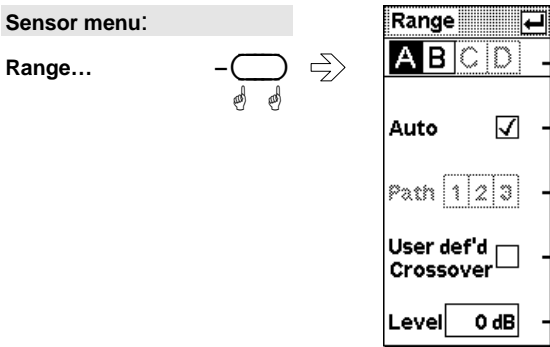







Fig. 4-19 Range dialog box

- A | B | C | D**            Tabs for selecting the sensor.
- Auto**            For turning the **Auto** range function on/off.

Remote Control  
`[SENSe[1..4]][:POWer][:AVG]:RANGe:AUTO[?] ON | OFF`
- Path**  
**1 | 2 | 3**            For selecting a measurement path when the **Auto** range function is off.

Remote Control  
`[SENSe[1..4]][:POWer][:AVG]:RANGe[?] 0 | 1 | 2`
- User def'd Crossover**            Activates a decrease in the crossover range.



**Level**  dB value by which the crossover level is reduced.  
Editing field with direct entry of values (see Chapter 3, *Dialog boxes and their controls*).

Remote Control  
[SENSE[1..4]][:POWER][:AVG]:RANGE:AUTO:CLEVEL[?] <float\_value>

## Effect of the RF source

Sensor → RF Source...

In this dialog box, you can enter information relating to the reflection coefficients,  $\Gamma$ , of the signal source. If **Source  $\Gamma$  considered for Enhanced Accuracy** is activated, measurement accuracy can be increased by correcting for the effect of source mismatch on the measured value (gamma correction). To do this, the magnitude and phase of  $\Gamma$  must be specified.

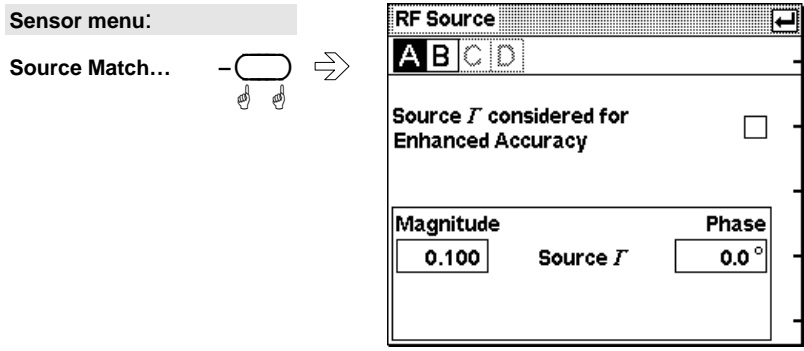





Fig. 4-20 RF Source dialog box

**Source  $\Gamma$  consid. for Enhanced Accuracy**  Increases measurement accuracy with gamma correction.  
Remote Control  
[SENSE[1..4]]:SGAMma:CORRection:STATe[?] ON | OFF

**A | B | C | D**  Tabs for selecting the sensor.

**Source  $\Gamma$  Magnitude**  Magnitude of the source reflection coefficient  $\Gamma$ .  
Remote Control  
[SENSE[1..4]]:SGAMma[:MAGNitude][?] <float\_value>

**Source  $\Gamma$  Phase**  Phase of the source reflection coefficient  $\Gamma$ .  
Remote Control  
[SENSE[1..4]]:SGAMma:PHASe[?] <float\_value>

## Trigger settings

Sensor→Trigger...

The trigger system, which is required for the BurstAv, Timeslot and Scope measurement modes, is configured in the **Trigger** dialog box and the **Trigger (Adv)** dialog box.

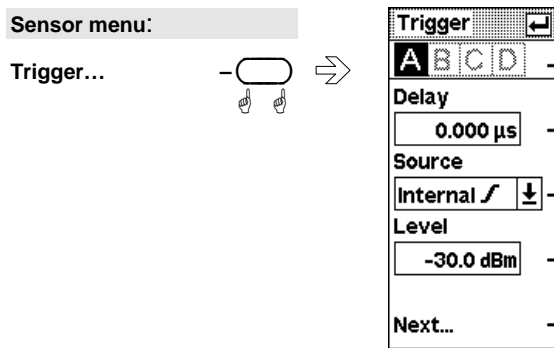







Fig. 4-21 Trigger dialog box

- A | B | C | D**  Tabs for selecting the sensor.
- Delay**  Trigger delay. Setting a positive value delays the effect of the trigger event until the set time has elapsed. Entering negative values allows pretriggering (limited to a few ms, depending on the sensor).  
The trigger delay is set in an editing field with direct entry of values (see Chapter 3, *Dialog boxes and their controls*).
- ✓ Tip**  
Entering a correct value for the trigger delay is absolutely essential for accurate measurements in the Timeslot mode. For this reason, the setting should always be checked in the Scope mode (☞ T'slots, p. 4.45).
- Source**  Drop-down list for the trigger source (external or internal) and trigger slope (positive or negative).  
Remote Control  
`TRIGger[1..4]:ALL]:DELay[?] <float_value>`
- Level**  When this level is exceeded, a measurement is triggered (or when the signal drops below this level in the case of a falling slope).  
The trigger level is set in an editing field with direct entry of values (see Chapter 3, *Dialog boxes and their controls*).  
Remote Control  
`TRIGger[1..4]:ALL]:LEVel[?] <float_value>`
- Next...**  Switches to the second page of the Trigger dialog box.

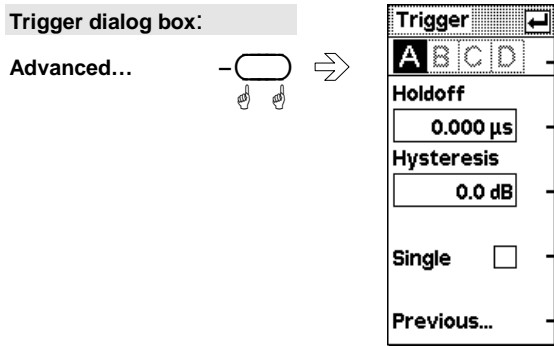

Fig. 4-22 Trigger Advanced dialog box

**A | B | C | D**

Tabs for selecting the sensor.

**Holdoff**

Allows the Holdoff time to be entered. During the Holdoff time, which starts with the trigger event, other trigger events are suppressed.

The holdoff time is set in an editing field with direct entry of values (see Chapter 3, *Dialog boxes and their controls*).

Remote Control

TRIGger[1..4]:ALL:HOLDoff[?] <float\_value>

**Hysteresis**

Allows a trigger hysteresis to be set. The signal level must be lower (higher) than the trigger level minus hysteresis (trigger level plus hysteresis) before triggering can occur again (brackets apply to triggering on the falling edge).

The trigger hysteresis is set in an editing field with direct entry of values (see Chapter 3, *Dialog boxes and their controls*).

Remote Control

TRIGger[1..4]:ALL:HYSTeresis[?] <float\_value>

**Single**

This setting is used to stop continuous triggering and thus execute only one trigger event at a time. To enable the trigger, refer to Trigger sequence control p. 4.26.

To record single events in the Scope mode, the **Realtime** check box must be enabled in the Mode dialog box. The chopper for the measurement is thus switched off. Otherwise a second measurement would automatically follow the regular measurement initiated by the trigger event and corrupt the measurement result.

Remote Control

INITiate[1..4]:ALL:CONTinuous[?] ON | OFF

**Previous...**

Switches to the first page of the Trigger dialog box

## Trigger sequence control

The **DEL/1TRIG** key is used in the Scope mode to manually control the trigger sequence:

**RUN** **STOP**

In continuous (not single-shot) mode, the **DEL/1TRIG** is used to interrupt (**STOP**) or continue (**RUN**) the measurement.

**1TRIG** **1TRIG**

In single-shot mode, each individual measurement must be released by pressing the **DEL/1TRIG** key before it can be initiated by the next trigger event. Pressing the key a second time before the trigger event also initiates a measurement (manual triggering).

## Displaying measurement results

Windows - menu

### Window labelling

The R&S NRP has a total of four windows for displaying results. They are numbered 1 to 4 and so have a unique label. The window's number is displayed in the top left of its title bar.

*Note:* Remote control commands that act on windows contain the number of the window in question in the command, e.g. `DISPlay:WINDow2:SElect`.

Windows can also be assigned a name. The **Window Name** function in the **File** menu is used to assign names to windows. The name is also displayed in the window's title bar and makes it easier to identify results. A name like *Amplifier output* is more informative than *Channel A* or *Window 2*. The names of the windows are also stored in the setups. Assigning meaningful names to the windows makes it much easier to recognize the associated measurement.

### Arranging windows

Displayed windows are shown in numerical order from the top to the bottom of the screen. The R&S NRP automatically selects the window size according to which combination of windows is displayed.

### The windows menu

The windows menu is context-sensitive and displays only those menu items that are relevant to the current measurement scenario.

### Selecting a window

Windows→Window

You can select one of the windows numbered 1 to 4 whenever you want. All the functions offered in the **Windows** and **Measurement** menus act on the selected window.

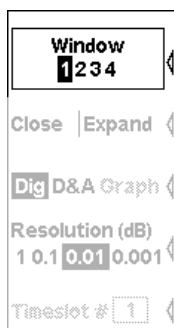

Fig. 4-23 Windows menu, Window softkey

#### Windows menu:



Selects the window whose number is highlighted in the menu. If the window is already open, it is also identified by the window title bar being in inverse video and by the “shadow” that appears along the right and bottom edges of the window.

## Using windows

The labelling of the second rocker switch in the Windows menu is context-sensitive and changes according to the status of the active window.



- ☞ Open opens the selected window.
- ☞ Init opens and initializes the selected window.
- ☞ Close closes the selected window.
- ☞ Expand expands all windows to fill the display.
- ☞ Arrange arranges all windows in cascade fashion.

Fig. 4-24 Windows menu, softkeys for controlling the windows

### Opening windows

Windows→Open



Opens a window with the previous settings. This means that a measurement which has been removed from the display can be restored.

Remote Control  
DISPlay[:WINDow][1..4][:STate][?] ON

### Creating windows

Windows→Init

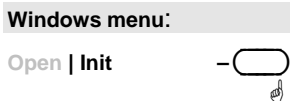

Opens a window with preset values. Configures a completely new measurement.

### Closing windows

Windows→Close

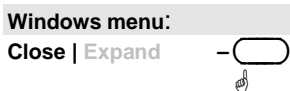

Closes an opened window. The sizes of any remaining windows are adjusted accordingly.

Remote Control  
DISPlay[:WINDow][1..4][:STate][?] OFF

### Expanding windows

Windows→Expand

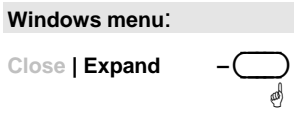

All opened windows are expanded to the full display height. The selected window is the only window that can be seen as all the other windows are “masked” by the selected window. However, the “masked” windows are still open and can be selected in sequence with **Window 1 2 3 4** or by means of the up/down cursor keys.

Expanded windows display all relevant parameters. For a graphical representation of the various window types and a description of symbols see Chapter 3, section *Window sizes and types* and *Special symbols*.

```
Remote Control
DISPlay:WINDow:SIZE[?] ZOOMed
```

### Arranging windows

Windows→Arrange

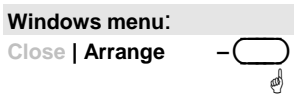

Expanded windows are reduced to their normal size and returned to their original state with **Arrange**.

```
Remote Control
DISPlay:WINDow:SIZE[?] NORMAl
```

### Selecting the result display mode

Windows→Type

In the windows, a variety of result display modes can be selected.



Fig. 4-25 Window menu, softkeys for controlling the display mode

The digital display (**Dig**) displays measured values as a number with additional information next to the reading.

The hybrid digital/analog display (**D/A**) displays the measured value on an analog scale and also digitally.

If the primary channel is in the Scope mode, oscilloscope display is automatically selected.

The **Graph** display mode plots measured values against time. This display mode is only available in the Scope mode

Windows menu:

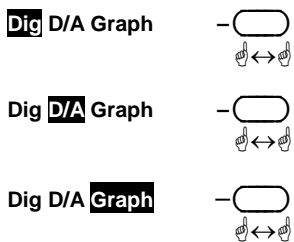

The **Dig D/A** softkey is used for switching between the various window display modes.

Digital display.

Hybrid digital/analog display.

Graph display mode in the Scope mode

```
Remote control
DISPlay[:WINDow][1..4]:FORMat[?] DIGital | ANALog
```

## Configuring the result display

Each of the display modes has special configuration parameters.



In the digital display, the resolution is adjustable (☞ Resolution, page 4.30).

In the hybrid digital/analog mode, you can adjust the resolution of the digital display (☞ Resolution, page 4.30) and specify the scaling for the analog scale (☞ Scale, page 4.31).

In the Graph display mode, there are no other parameters in the menu. The many possible settings in this display mode are made directly in the window, which for this purpose has to be expanded (☞ Expanding windows (Expand) , p. 4.29).

Fig. 4-26 Windows menu, display-specific softkeys

## Setting the resolution

Windows → Resolution

The resolution of the digital measurement result can be set in 4 stages, designated as 1 dB, 0.1 dB, 0.01 dB and 0.001 dB. If dB, dBm or dBμV is selected as the unit, the number of places after the decimal point is set directly. In the linear mode (W, Δ%, 1), the number of digits after the decimal point depends on the resolution, a digit being added or removed for each resolution stage that is added or removed.

The selected resolution also influences the action of the autofilter in the ☞ The Normal mode (see page 4.19). The greater the selected resolution, the longer the averaging filter to reflect the number of digits.

### Windows menu:

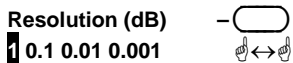

Sets the result resolution you want.

Remote Control

DISPlay[:WINDow][1..4]:RESolution[?] 1 | 0.1 | 0.01 | 0.001



### Setting the analog scale

Windows→Scale

The analog scale in the combined digital/analog display (D/A) can be set with the **Analog Meter** softkey.

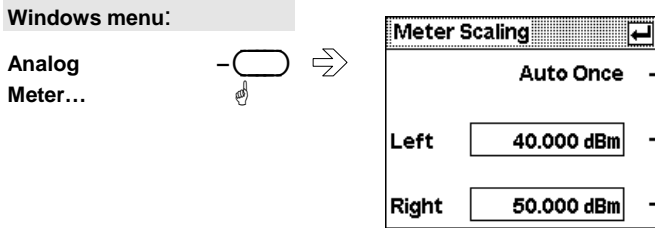





Fig. 4-27 Meter Scaling dialog box

- Auto Once**  Automatically selects the appropriate scaling so that the instantaneous measured value is in the middle of the scale.

Remote Control  
`DISPlay[:WINDow][1..4]:METer|:ANALog:AUTO[?] ONCE | OFF`
- Left**  Enables input of the left end-of-scale value.

Remote Control  
`DISPlay[:WINDow][1..4]:METer|:ANALog:LOWer[?] <float_value>`
- Right**  Enables input of the right end-of-scale value.

Remote Control  
`DISPlay[:WINDow][1..4]:METer|:ANALog:UPPer[?] <float_value>`

### Scrolling between timeslots

Windows→Time Slot

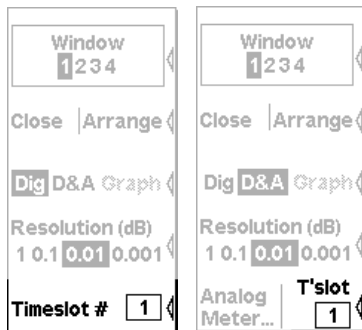

If the timeslot mode has been selected for a sensor, you can use the **Time Slot** softkey in the Windows menu to select the timeslot whose measured values you want to display.

Fig. 4-28 Windows menu, softkey for scrolling between timeslots

- Windows menu:**

**Time Slot**  Specifies which of the timeslots on which a simultaneous measurement is being performed are displayed in the active window.

If you want to display further timeslots simultaneously, a separate window must be opened and configured for each additional timeslot.

Remote Control  
`DISPlay[:WINDow][1..4]:TSlot[?] <int_value>`

# Configuring measurements

## Measurement windows

For every window opened via the **Windows** menu, you can configure a measurement in the **Measurement** menu. The measurement channels (A, B, C and D), how the measured values are processed (ratio, difference), the unit for the result, additional information (max, min), etc are also defined. This procedure does not change the sensor operating modes that have been set in the Mode menu. All key parameters are displayed along with the result in the appropriate window.

In the manual mode, four measurements can be configured, corresponding to the maximum number of windows (1, 2, 3 and 4); in the remote control mode, additional measurements 5 to 8 can be configured (not displayed on screen).

## The Measurement menu

The Measurement menu contains the functions required to configure measurements.

<div style="border: 1px solid black; padding: 2px;">Window 1 2 3 4</div>	☞ Selecting a window, page 4.32.		
<table border="0" style="width: 100%;"> <tr> <td style="border-right: 1px solid black; padding: 2px;">Func- tion...</td> <td style="padding: 2px;">W dBm dBµV</td> </tr> </table>	Func- tion...	W dBm dBµV	☞ Selecting a measurement function and the unit, page 4.33.
Func- tion...	W dBm dBµV		
<table border="0" style="width: 100%;"> <tr> <td style="border-right: 1px solid black; padding: 2px;">Relative Off On</td> <td style="padding: 2px;">Reset</td> </tr> </table>	Relative Off On	Reset	☞ Relative measurements, page 4.39.
Relative Off On	Reset		
<table border="0" style="width: 100%;"> <tr> <td style="border-right: 1px solid black; padding: 2px;">RefVal...</td> <td style="padding: 2px;">Limits...</td> </tr> </table>	RefVal...	Limits...	☞ Setting the reference value manually, page 4.39. ☞ Limit monitoring, page 4.40.
RefVal...	Limits...		
<table border="0" style="width: 100%;"> <tr> <td style="border-right: 1px solid black; padding: 2px;">Max Hold</td> <td style="padding: 2px;">Reset</td> </tr> </table>	Max Hold	Reset	☞ Resetting the extreme value display, page 4.38.
Max Hold	Reset		

Fig. 4-29 Measurement menu

## Selecting a window

Measurement → Window

You can select one of the windows (1 to 4) as and when you want. All **Windows** and **Measurement** menu functions act on the selected window.

Measurement menu:



Selects the window whose number is displayed in the menu. If the window is open, this is also indicated by the window's title bar being in inverse video and by the "shadow" along the window's right and bottom edges.

## Selecting a measurement function

Measurement→Function...

The R&S NRP can combine measured values from several channels (sensors) using a mathematical function and display the result in the selected window. The necessary settings are made in the **Function...** dialog box.

The first step is to select the measurement function, i.e. the mode of combination for multi-channel measurements. Possible functions are the power ratio of two channels, a matching measurement function derived from this or the power in a single measurement channel. All or any of the connected sensors can be selected. A primary channel, and possibly a secondary channel, can be selected for each measurement window.

The simplest case is a measurement with just one sensor. To configure this measurement, first of all select **Primary (X)** or **Secondary (X)** ( $X = A, B, C$  or  $D$ ) in the **Function** list and then the channel (sensor) you want in the **Primary Channel** or **Secondary Channel** list. Select the function **Ratio (X/Y)** to measure the power ratio and then the measurement channel assignment. For all dual-channel measurements, the first argument "X" of the measurement function is the primary measurement channel. For the sake of clarity, the primary measurement channel is referred to as the **Incident Power** for matching measurement functions (SWR, Rcoeff and Rloss) and indicates the forward wave, i.e. the wave that is incident at the DUT.

Measurement menu

Function...



Func & Unit	
Function	Primary (A) ↓
Prim. Channel	A ↓
Sec. Channel	B ↓
Unit	dBm ↓
Aux	None ↓

Fig. 4-30 Func &amp; Unit dialog box

Functions and their use

Func & Unit : Function

Func & Unit dialog box

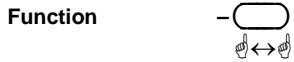

The **Function** drop-down list itemizes all the measurement functions provided by the R&S NRP. These are:

**Function**

- Primary (A) Power in the primary channel, e.g. A.
- Secondary (B) Power in the secondary channel, e.g. B.
- Ratio (A/B) Ratio of the power in the primary channel to the power in the secondary channel.
- SWR (A,B) Standing wave ratio
- RCoeff (A,B) Reflection coefficient
- RLoss (A,B) Return loss
- Diff (A-B) Power difference between the primary and secondary channel.
- Sum (A+B) Sum of power from first and second channel.
  
- Scope (A) This function cannot be selected from the "Function & Unit" dialog box but automatically appears there when the primary channel is in the **Scope** mode. The Scope mode does not allow relative measurements or two-channel measurement functions (ratio, SWR, etc).

The functions for the matching measurement are so defined that the forward power must be measured in the primary channel and the reverse power in the secondary channel.

```
Remote Control
CALCulate[1..8]:MATH[:EXPRession][?] <string>
```



Selects the primary channel which is to be used to calculate the displayed value.

If the selected channel is operating in the **Scope** mode, its power is automatically shown as a function of time ("Scope (X)" function). Except for the graphical display, it is the same as the "Primary (X)" function. It is not possible to select another measurement function.



Selects the secondary channel which is to be used for the calculation.

### Expanded configuration for sensors in the Scope mode

The measurement results of sensors operated in the Scope mode can be further processed and displayed in two ways:

a) by a power/time diagram (measurement window in the Graph display mode Selecting the result display mode, p. 4.29).

b) in the form of gated measurement results (measurement window in the Dig or D&A display)

Whereas the Graph mode allows only an absolute display of the measured values, gated measurement results can also be further processed like other measurement results: as absolute values relative to a fixed reference value or another measurement channel. For this purpose, the **Func&Unit** dialog box provides expanded configuration possibilities, including the number of the gate and the type of measurand (Avg, Peak, Peak/Avg).

Note the following:

- Restrictions regarding Peak and Peak/Avg are described in the background information to Meas, p. 4.47
- Only functions whose result is a power or a dimensionless ratio can be created
- The reference of a gate measured value to the value of another gate in the same channel is not possible

#### Func & Unit- Dialog

Primary or secondary channel in the Scope mode.

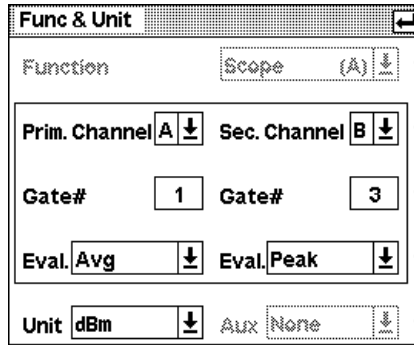

Fig. 4-31 Func & Unit dialog box

Gate#



Determines which gate is to be evaluated for the function.

Eval.



Selects one of the available measurands:

- Avg** Average power in the gate
- Peak** Peak power in the gate
- Peak/Avg** Ratio of peak power to average power in the gate

Setting units

Func & Unit : Unit

Unit



The Unit drop-down list is used to set the result unit. Only those units which are compatible with the selected measurement function are included as menu items:

Function	Unit
Primary, Secondary, Diff, Sum	W, dBm, dBμV
Ratio	Δ%, dB, 1
SWR, RCoeff	1
RLoss	dB

Measurement menu:

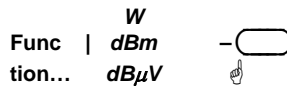

The units can be selected directly from the Measurement menu by using the right half of the function rocker switch.

Remote Control

```
UNIT[1..8]:POWER[?]          DBM | W | DBUV
UNIT[1..8]:POWER:RATio[?]    DB | DPCT | O
```

The following tables show the mathematical function used to determine the measurement result. This function depends on the measurement function and the measurement unit that is set, and is defined as either not relative to (Relative Off) or relative to (Relative On) a stored reference value  $\varphi$  Relative measurements (page 4.39):

Absolute power measurement (Relative Off)

	W	dBm	dBμV
Primary	$P$	$10 \lg\left(\frac{P}{1\text{mW}}\right)$	$20 \lg\left(\frac{\sqrt{P \cdot Z}}{1\mu\text{V}}\right)$
Secondary			

Power ratio measurement (Relative Off)

	dB	Δ%	1
Ratio (A,B)	$10 \lg\left(\frac{P_A}{P_B}\right)$	$100\left(\frac{P_A}{P_B} - 1\right)$	$\frac{P_A}{P_B}$
SWR (A,B)	-	-	$1 + \sqrt{\frac{P_B}{P_A}}$ $1 - \sqrt{\frac{P_B}{P_A}}$
Rcoeff (A,B)	-	-	$\sqrt{\frac{P_B}{P_A}}$
RLoss (A,B)	$10 \lg\left(\frac{P_A}{P_B}\right)$	-	-

## Sum and difference of power measurements (Relative Off)

	W	dBm	dB $\mu$ V
<b>Sum (A+B)</b>	$P_A + P_B$	$10 \lg \left( \frac{P_A + P_B}{1 \text{ mW}} \right)$	$20 \lg \left( \frac{\sqrt{(P_A + P_B) \cdot Z}}{1 \mu\text{V}} \right)$
<b>Diff (A-B)</b>	$P_A - P_B$	$10 \lg \left( \frac{P_A - P_B}{1 \text{ mW}} \right)$	$20 \lg \left( \frac{\sqrt{(P_A - P_B) \cdot Z}}{1 \mu\text{V}} \right)$

## Measurement result relative to reference value (Relative On)

	1	dB	$\Delta\%$
<b>Primary Secondary</b>	$\frac{P}{P_R}$	$10 \lg \left( \frac{P}{P_R} \right)$	$100 \left( \frac{P}{P_R} - 1 \right)$
<b>Sum Diff</b>	$\frac{P_A \pm P_B}{P_R}$	$10 \lg \left( \frac{P_A \pm P_B}{P_R} \right)$	$100 \left( \frac{P_A \pm P_B}{P_R} - 1 \right)$
<b>Ratio</b>	$\frac{\left( \frac{P_A}{P_B} \right)}{\left( \frac{P_X}{P_Y} \right)_R}$	$10 \lg \frac{\left( \frac{P_A}{P_B} \right)}{\left( \frac{P_X}{P_Y} \right)_R}$	$100 \left( \frac{\left( \frac{P_A}{P_B} \right)}{\left( \frac{P_X}{P_Y} \right)_R} - 1 \right)$

- $P$  Power  
 $P_A$  Power in channel A (forward power)  
 $P_B$  Power in channel B (reverse power)  
 $P_R$  Reference (power)  
 $\left( \frac{P_x}{P_y} \right)_R$  Reference (power ratio)

### Setting the auxiliary value

Func & Unit : Auxiliary Value

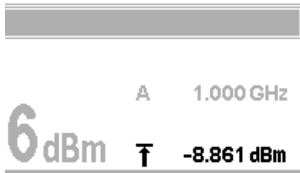

Fig. 4-32 Measurement window, Auxiliary Value

In the Digital display mode, the result and another value that characterizes the result can be displayed.



Selecting the auxiliary value:

- Max** The greatest value that has been measured since the extreme value function was last reset (☞Resetting the extreme value display, page 4.38).
- Min** The smallest value that has been measured since the extreme value function was last reset (☞Resetting the extreme value display, page 4.38).
- Max-Min** The interval that includes all values measured since the extreme value function was last reset (☞Resetting the extreme value display, page 4.38).

```
Remote Control
CALCulate[1..8][:MINimum | :MAXimum | :PTPeak]:DATA?
DISPlay[:WINDow][1..4]:AVALue[?] MINimum|MAXimum|PTPeak|OFF
```

### Resetting the extreme value display

Measurement→Max Hold Reset

For each window, the R&S NRP continuously saves the maximum and minimum value measured since the start of the measurement or since these values were last reset. These values should, therefore, be reset before the measurement is started.

Measurement menu:

Clears the extreme values and restarts recording of extreme values.



```
Remote Control
CALCulate[1..8]:EXTRemes:RESet
```



## Additional functions

### Relative measurements

Measurement → Rel

The **Rel** function is a simple way of obtaining the ratio of a measured value to a constant value, e.g. a measured power.

#### Measurement menu:

Rel  
Off On Reset



**Off:** Measurement using the measurement function that has been set.

Rel  
Off On Reset



**On:** Relative display mode.

Remote Control

CALCulate[1..8]:RELative:STATE[?] ON | OFF

Rel  
Off On Reset



If the right-hand side of the rocker switch is pressed when **On** is selected, the current measured value is transferred to the active window's reference memory. The display then returns to **On**.

Fernsteuerung

CALCulate[1..8]:RELative:MAGNitude:AUTO[?] ONCE

### Setting the reference value manually

Measurement → Ref. Val

The reference value can also be directly entered or edited using the **Ref. Val...** dialog box.

#### Measurement menu:

Ref. Val...

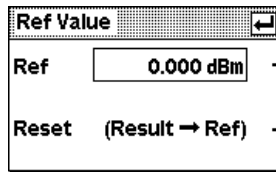



Fig. 4-33 Ref. Value dialog box

Ref. Value



For directly entering a new reference value or for editing an old value.

Remote Control

CALCulate[1..8]:RELative:MAGNitude[?] <float\_value>

Result → Ref



The current result is transferred to the reference value memory of the active window and displayed. This function can also be started from the Measurement menu by using the **Reset** softkey.

Remote Control

CALCulate[1..8]:RELative:MAGNitude:AUTO[?] ONCE

Limit monitoring

Measurement → Limits

An upper and a lower limit for each window can be set in the Limits... dialog box. If either limit is violated, a warning is issued. The warning may be one of the following:

- The **LIMIT FAIL** message is displayed on the screen.
- A warning tone is output.
- A signal is issued on analog output OUT1 (☞ Setting the analog outputs on page 4.58).

Measurement menu:

Limits...

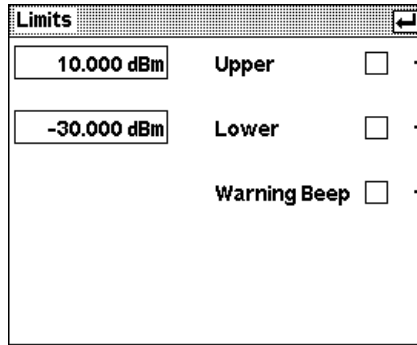

Fig. 4-34 Limits dialog box

- Upper
- Upper
- Lower
- Lower
- Warning Beep

Turns monitoring of the upper limit on/off.

Remote Control  
`CALCulate[1..8]:LIMit:UPPer:STATe[?] ON | OFF`

Upper limit.

Remote Control  
`CALCulate[1..8]:LIMit:UPPer[:DATA][?] <float_value>`

Turns monitoring of the lower limit on/off.

Remote Control  
`CALCulate[1..8]:LIMit:LOWer:STATe[?] ON | OFF`

Lower limit

Remote Control  
`CALCulate[1..8]:LIMit:LOWer[:DATA][?] <float_value>`

For activating the acoustic alarm.

Remote Control  
`CALCulate[1..8]:LIMit:BEEP[?] ON | OFF`

## Displaying data in the Scope mode

Mode : Scope

Envelope power versus time can be graphically displayed in the Scope mode, allowing timeslot and gate structures to be blended into the signal characteristic and configured. The average and peak power values measured within a gate and the Peak/Avg ratio can be numerically displayed.

## Switching the sensor to the Scope mode

To use the Scope mode display, the sensor must first be switched to a special operating mode (**Scope**) and configured. This is done by way of the **Mode** dialog box in the **Sensor** menu.

Mode dialog box:

T'gate, Scope...

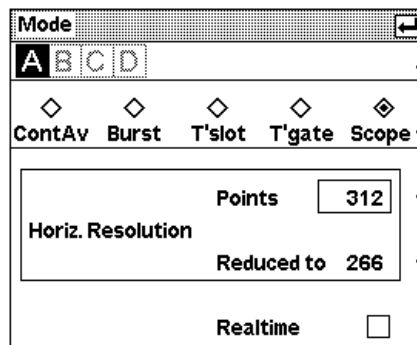

Fig. 4-35 Mode dialog box, Scope mode

Points



Desired number of measurement points. Each point represents the average power of a time interval whose width is determined by the length of the measurement window (☞ Trace, p. 4.44) and the number of measurement points.

Remote control

```
[SENSe[1..4]]:TRACe:POINTs <int_value>
```

Reduced to

If the desired time resolution cannot be obtained with the connected sensor, the number of measurement points is automatically reduced. With the Sensors R&S NRP-Z1x and R&S NRP-Z2x, this limit is approximately 2.5  $\mu$ s per measurement point (external triggering). 10  $\mu$ s is possible with internal triggering.

Realtime



In the Realtime mode each measurement point comes from a single sweep. Successively recorded traces are not averaged. For this purpose, the chopper is switched off and the averaging filter deactivated. Advantage: unstable or unclear trigger conditions are detected immediately, preventing the display of unrealistic traces caused by averaging asynchronous measurement values.

Disadvantage: if power is very low, display noise, zero offset and linearity are worse than in the Normal mode.

Remote control

```
[SENSe[1..4]]:TRACe:REALtime[?] ON | OFF
```

## Background information

### Points

The highest possible number of measurement points (312) corresponds exactly to the number of pixels available on the display of the R&S NRP. The most detailed image is obtained with this value. If the required time resolution is too high (depending on the width of the measurement window), the number of measurement points is automatically reduced to the largest possible value (**Reduced to display**). A closed trace is always displayed, with linear interpolation between the measurement points. Generally 312 measurement points should be set and the reduction performed automatically. See also the tip on page 3.9.

An exception is smoothing noisy traces by decreasing the number of points. As each measurement point represents the average power of an equivalent time interval, noise can be reduced by 30 % by reducing the number of points by half.

Another means of reducing noise is the averaging filter (☞ Filter / averaging, p. 4.19), which can be used whenever **Realtime** is not enabled. With very large averaging factors, the display will tend to respond slowly.

### Realtime

When the R&S NRP is in the Normal mode, averaging is always performed across a number of sweeps. Because of the chopper amplifier (☞ Sampling window, p. 4.10), two sweeps are always taken into account in calculating the measurement result, even if the averaging filter is set to 1 (☞ Filter / averaging, p. 4.19). If the measurement points to be averaged originate from different trigger events, this can produce a new, perhaps totally unrealistic trace. A noisy signal or a signal with more than one possible trigger point can result in different trigger events, especially if internal triggering (☞ Trigger settings, p. 4.24) is used.

Using the Realtime mode helps to set stable trigger conditions, as unstable trigger behaviour can be detected immediately. Since the dynamic range in the Realtime mode is reduced because of larger zero offsets, stronger noise and poorer linearity, it should be switched off when triggering is stable. If triggering is external, the Realtime mode is generally unnecessary (exception: single-shot measurement ☞ Trigger settings p. 4.24).

## Selecting a window

The traces recorded by a sensor in the Scope mode can be displayed in an expanded or a half-height window. The most important thing is that the sensor that has been switched to the Scope mode is entered in the **Primary Channel** of this window (☞ [Functions and their use](#), p. 4.34).

The window should be expanded so that the additional control elements of the Scope mode display can be used. As usual, the functions in the **Windows** menu are used to switch between the expanded ☞ [Expand](#) (p. 4.29) and half-height window ☞ [Arrange](#) (p. 4.29).

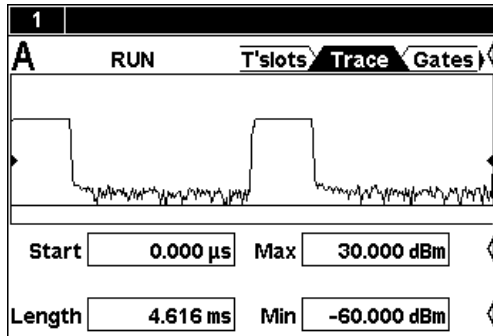

Fig. 4-36 Expanded window with control elements in the Scope mode

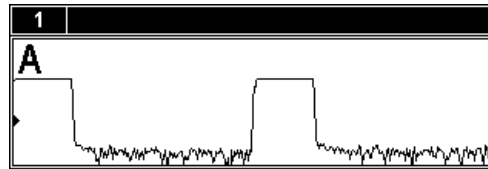

Fig. 4-37 Mode dialogHalf-height window in the Scope mode

## Trigger settings

To obtain a stable image, the trigger parameters must be set in the Trigger and Trigger (Adv.) dialog boxes so that they correspond to the signal (☞ [Trigger settings and Trigger sequence control](#), p. 4.24).

## Filter settings

Like any other result of a power measurement, the displayed trace can also be smoothed using the averaging filter. For this purpose, a number of sweeps are recorded, and the corresponding points of each sweep are averaged. For configuring the filter ☞ [Filter / averaging](#), p. 4.19. To prevent the measurement result from being corrupted by unstable trigger conditions (non-correlating points of different sweeps are averaged), a test should first be run in the Realtime mode to determine whether stable trigger conditions exist (☞ [Realtime](#), p. 4.42).

## Setting parameters

All parameters relevant to the trace display can be directly set in the expanded window. The parameters are spread across four pages marked by tabs.

Symbols



Tabs for selecting the page.



Marks the trigger level (visible at the left- and right-hand edges). If the Trigger dialog box is open, an unbroken line appears.



Time of trigger event.



Time at which the trigger delay has elapsed (delayed trigger). In the Timeslot mode, this time should coincide with the beginning of the first timeslot.

### ✓ Tip

If you use the up/down cursor keys for making changes to parameters (☞ Entry fields on page 3.8), you can observe the effects immediately and make adjustments interactively. Coarse or fine adjustments are possible, depending on the decimal place in which you "scroll".

## Trace

The parameters on the Trace page are used to determine the position and the size of the screen window. The number of measurement points must be specified in the Mode menu (☞ Switching the sensor to the Scope mode, p. 4.41).

### Scope mode display

T'slots, Trace...

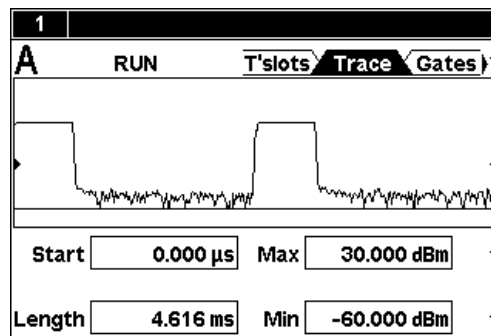

Fig. 4-38 Scope mode display – Trace page

Start





Start of the measurement window (left-hand screen edge) relative to the delayed trigger.

The value can be negative so that signal components before the trigger event can be shown (limited to a few ms, depending on the sensor).

Remote control

[SENSe[1..4]]:TRACe:OFFSet:TIME[?] <float\_value>

<b>Length</b>		<p>Length of the measurement window (image width). Co-determines the time resolution, together with the number of measurement points. (☞ Background information, p. 4.45).</p> <p>Remote control [SENSe[1..4]]:TRACe:TIME[?] &lt;float_value&gt;</p>
<b>Max</b>		<p>Maximum power that can be displayed.</p> <p>Remote control DISPlay[:WINDow][1..4]:TRACe:UPPer[?] &lt;float_value&gt;</p>
<b>Min</b>		<p>Minimum power that can be displayed.</p> <p>Remote control DISPlay[:WINDow][1..4]:TRACe:LOWer[?] &lt;float_value&gt;</p>

### ✓ Tip

The number panel for **Min** and **Max** contains an auto-softkey for adapting the power range to the trace.

### Background information

The time resolution of the trace is determined by the length of the measurement window and the number of measurement points (☞ Switching the sensor to the Scope mode, p. 4.41). A measurement point therefore represents the power for a time interval within which the test signal can considerably vary. Among the different ways of finding a representative value, each measurement point is assigned the average power of the correlating time interval, which can result in deviations from the expected characteristic of the envelope power. In this case, the time resolution must be increased by shortening the measurement window and/or raising the number of measurement points.

This aspect should be given special attention, especially when measuring the peak power and the Peak/Avg ratio (☞ Meas, p. 4.47).

### T'slots

On this page of the Scope mode display, a timeslot structure – the configuration that was defined for the Timeslot mode in the Mode menu – is blended into the power characteristic (☞ Measuring the power of TDMA signals, p. 4.13). In addition, the average power of a timeslot that can be selected from this is displayed, taking into account the exclude times. As the exclude times on the set page can be changed, the effects on the measurement result can be seen immediately.

#### Scope mode display

T'slots, Trace...

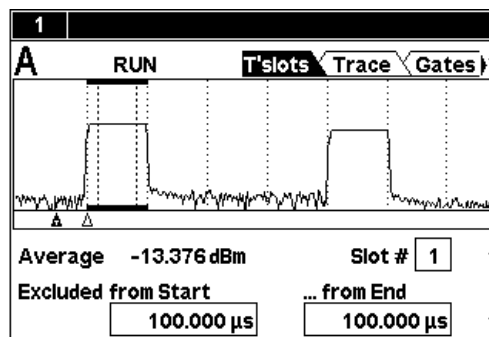
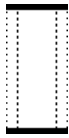

Fig. 4-39 Scope mode display – Timeslot page



Marks the set timeslot including the exclude start and end times.

Average

Average power for the set timeslot. The displayed value is obtained by averaging the measurement points between the inner vertical lines. Measurement accuracy can be increased if the Timeslot mode is selected for the actual measurement.

Slot#

Selection of the marked timeslot. For this purpose, an average power calculated from the measurement points is displayed.

Excluded from End

Setting of the exclude times. These parameters can also be set in the **Mode** dialog box.

... from Start

( Measuring the power of TDMA signals, p. 4.13).

**✓ Tip for power measurement in timeslots**

1. Enter TDMA standard parameters in the Mode menu (Timeslot).
2. Switch the sensor to the Scope mode.
3. Make the horizontal and vertical display settings on the Trace page.
4. Blend in the timeslot structure on the T'slots page.
5. Open the Trigger dialog box and set the delay so that the timeslot structure coincides with the trace.
6. Change the exclude times if necessary.

**Gates**

The R&S NRP provides four separately configurable time windows ("gates") for signal evaluation. The start and end of each gate can be set on the **Gates** page with the aid of markers.

Measurements in the time windows can be made by using the **Meas** page ( Meas, page 4.47), or by switching to the Timegate mode ( Measuring power in gates, p. 4.14).

**Scope mode display**

...Trace, Gates...

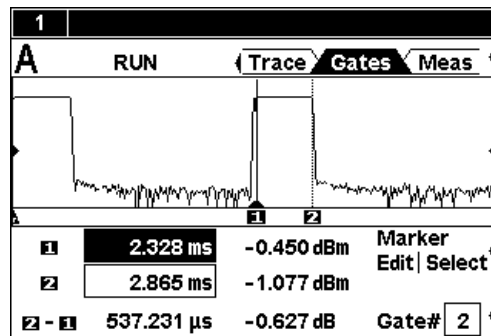

Fig. 4-40 Scope mode display – Gates page





Active marker.

The active marker can be shifted pixel by pixel using the  $\rightarrow$  and  $\leftarrow$  keys, re-entered with **Marker Edit** or changed by scrolling.



The number 1 marks the start of a time window and the number 2 the end, regardless whether the marker is active or passive.

Passive marker.

1	2.328 ms	-0.450 dBm
2	2.865 ms	-1.077 dBm

Time position of the markers and power level at the marker positions. All indicated times are relative to the delayed trigger.

The indicated times for the selected time window are identical to the **Start of Gate** and **End of Gate** parameters in the Timegate mode ( $\rightarrow$  Measuring power in gates, p. 4.14).

2 - 1 537.231  $\mu$ s -0.627 dB

Time difference between the markers and level difference between marker positions.

Marker Edit Select

Swaps the roles of the active and passive marker.

Marker Edit Select

Opens an editor for the time position of the active marker.

Gate#

Selects a time window.

## Meas

The average power, the peak power and their ratio for the selected time window are displayed on the Meas page.

The page is easy to reach from the **Gates** page, so you can quickly judge the effect of changing the marker position. As the measured values are calculated from the pixels, they do not attain the accuracy specified for the Timegate mode. For a more accurate measurement of the average power, it is therefore advisable to switch to the Timegate mode ( $\rightarrow$  Measuring power in gates, p. 4.14).

### Scope mode display

...Gates, Meas

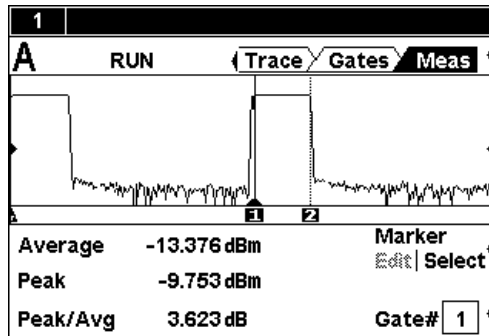



Fig. 4-41 Scope mode display – Meas page



Active marker.  
The active marker can be shifted pixel by pixel using the  and  keys.

The number 1 marks the start of a time window and the number 2 the end, regardless whether the marker is active or passive.



Passive marker.

**Average**

Average power for the set time window.



*For the following two items, please read  
☞ Background information, p.4.12.*

**Peak**

Peak power for the set window.

**Peak/Avg**

Ratio of peak power to average power for the set time window.

Remote control, configuration

CALCulate[1..8]:FEED[?] "POWer:AVERage ON SWEEp[1..4]"

CALCulate[1..8]:FEED[?] "POWer:PEAK ON SWEEp[1..4]"

CALCulate[1..8]:FEED[?] "POWer:PTAVerage ON SWEEp[1..4]"

Read result

FETCh[1..8]?

**Marker**



Swaps the roles of the active and passive marker.

**Edit Select**

**Gate#**



Selects a time window.

### Background information

To ensure accurate measurement of the peak power and the Peak/Avg ratio, two factors must be taken into account:

1. First of all, the video bandwidth of the power sensor must be greater than the RF bandwidth of the test signal so that the display of the envelope power characteristic is not corrupted. The video bandwidth of the Sensors R&S NRP-Z1x and R&S NRP-Z2x is about 100 kHz, allowing the peak power of many amplitude-modulated signals and also several TDMA signals such as NADC (RF bandwidth approx. 50 kHz) to be measured. If the RF bandwidth is considerably greater than the video bandwidth, values displayed for the peak power and the Peak/Avg ratio will generally be too low.
2. For the peak power measurement, the horizontal resolution should be high enough to allow the peak value to appear in the diagram as a round cap several pixels wide. Otherwise the displayed and/or measured value may be too low. The reason lies in the fact that a measurement point represents the power for a time interval and the average power is assigned by the R&S NRP.

# Management of settings

File - menu

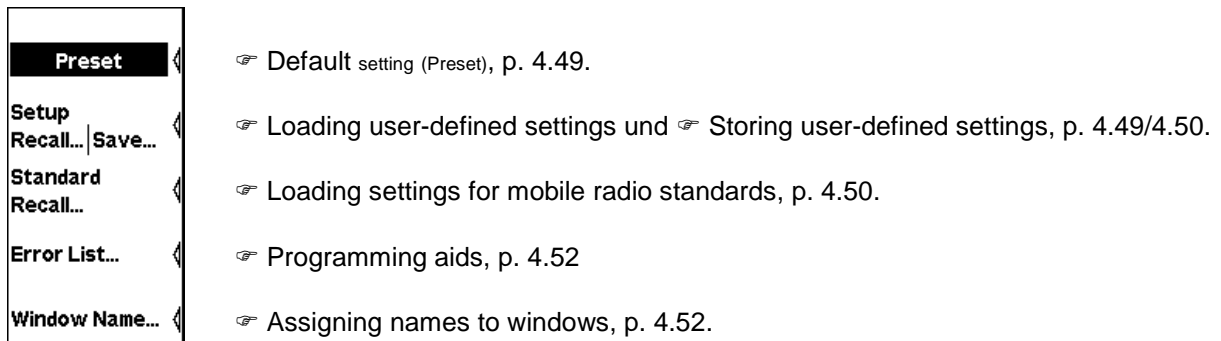

Fig. 4-42 File menu

## Default setting

The **Preset** softkey in the File menu changes the R&S NRP to its default setting. The black background of the text indicates that the function can also be started by pressing the **(PRE)SET** hardkey.

In the default setting, a window is opened for each connected sensor. The default setting is sensor-specific.

## Storing user-defined settings

The R&S NRP provides 19 memory spaces in which complete device settings can be stored (Setup memory). Settings can be stored by using the **Save Setup...** dialog box. The memory spaces can be labelled with a name for identification.

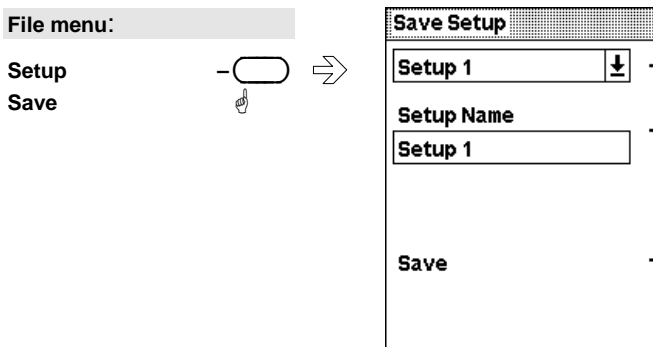



Fig. 4-43 Recall Setup dialog box

- Setup      - [softkey]      ⇒      Selects a setting.
  - Edit Name      - [softkey]      ⇒      Used to rename the selected setting.
- Remote Control  
 MEMory:STATe:MAP <string>, 1..19

**Save**  Stores the current settings under the selected name. After settings are stored successfully, the dialog box is closed.

Another way to store settings and close the dialog box is to press the **↵ MENU** key. A dialog can be cancelled by using **ESC**.

Remote Control  
\*SAV 1..19

## Loading user-defined settings

The **Recall Setup...** dialog box is used to load stored settings.

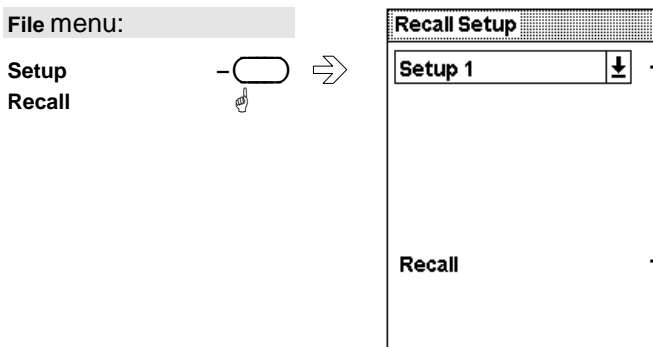



Fig. 4-44 Recall Setup – dialog box

**Setup**  Selects a setting.

**Recall**  Loads the selected setting. After the setting is loaded successfully, the dialog box is closed.

The same effect can be achieved by pressing the **↵ MENU** key. Pressing **ESC** cancels the dialog.

Remote Control  
\*RCL 0..19

## Loading settings for mobile radio standards

Predefined settings for the most common mobile radio standards can be loaded in the **Recall Standard** dialog box for quick configuring of messages in the Timeslot and Scope modes. In contrast to **Recall Setup**, essentially only the parameters that affect the connected sensors are reconfigured (Sensor menu). The name of the set standard appears in the title bar of all open windows and is also treated like any other window name (☞ Assigning names to windows, p.4.52). The name can therefore be changed and deleted as desired, but above all it is not automatically deleted when one of the preset parameters is changed and the instrument setting no longer corresponds to the loaded standard.

A table of sensor parameter values for the different standards can be found at the end of Chapter 6 under *Standard configurations*.

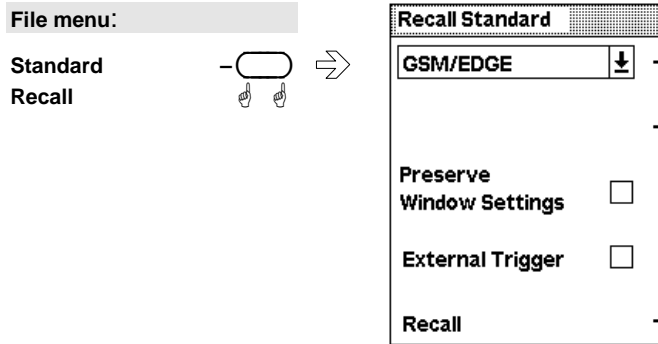





Fig. 4-45 Recall Setup dialog box

- Standard**  Selects a mobile radio standard.
- Preserve Window Settings**  If enabled, only the sensor parameters are loaded but the windows are not reconfigured.
- External Trigger**  Selects between configurations with an internal or an external trigger.
- External triggering should be selected if the test signal yields no clearly defined or only an unstable trigger event.
- If external triggering is used in the timeslot mode, ensure that the trigger delay setting is such that the start of the first timeslot coincides with the delayed trigger. (☞ Trigger settings, p. 4.24).
- Remote Control  
`SYSTEM:STANDARD:PWSettings ON | OFF`
- Remote Control  
`SYSTEM:STANDARD:TRIGGER:SOURCE INT | EXT`
- Remote Control  
`SYSTEM:STANDARD:PREset <string>`

## Programming aids

File→Errorlist...

If you are developing remote control programs, you can display the contents of the SCPI error queue in the Errorlist dialog box. In addition to the error, the command line that triggered the error is displayed, along with a question mark highlighted in black at the point where the command interpreter detected the error.

The dialog box can be left permanently open, and its contents are continuously updated.

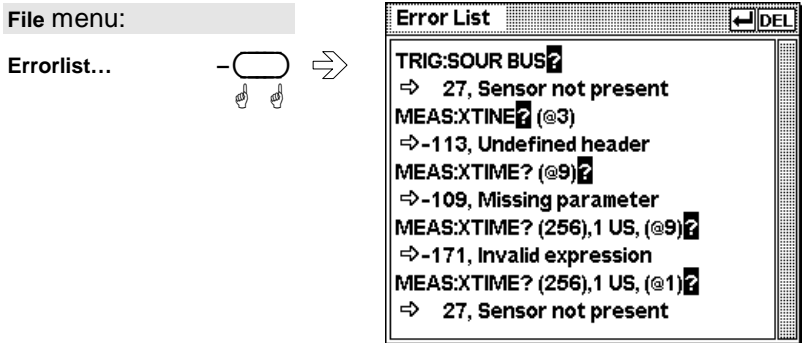

Fig. 4-46 Errorlist dialog box

If the device is already in the remote state, the menu bar is replaced and the Errorlist can be opened with the topmost softkey.



Fig. 4-47 Menu bar in the remote control mode

**DEL/1TRIG**

If the Errorlist is open, the error queue of the R&S NRP can be deleted by pressing the **DEL** key.

### Remote control

DISPlay:ERRorlist[?] ON | OFF

To activate extended error messages:

SYSTem:ERRor:EXTended[:STATe][?] <boolean>

## Assigning names to windows

File→Window Name...

Each display window is automatically labelled with a number (1, 2, 3, 4). In addition, you can enter a name for each window to more closely indicate the type of measurement result. This is particularly recommended for settings to be stored in a setup memory. The Window Name dialog box is used to assign names to windows.

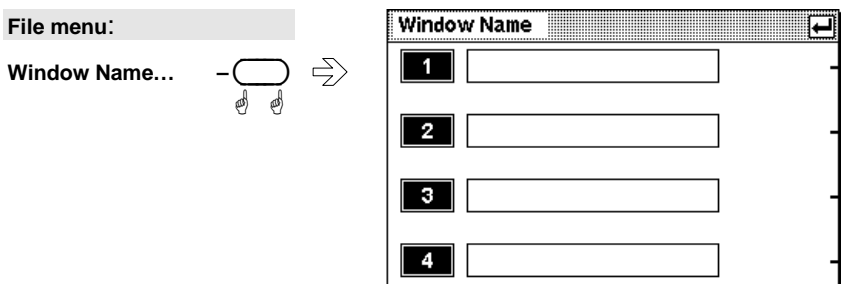

Fig. 4-48 Window Name dialog box

Window 1



Assigns a name to window 1. Pressing the softkey will open an editor for entering a name.

Window 2...4



Assign names to windows 2 to 4.

Remote Control

`DISPlay[:WINDow][1..4]:NAME[?] <string>`

## System settings

System - menu

Remote...   I/O... <	☞ Configuring the remote control interfaces, page 4.55.
Batt...   Test... <	☞ Setting the analog outputs, page 4.58.
Power Ref Off On <	☞ Selftest, page 4.60.
Sensor   System Info...   Info... <	☞ Test generator, page 4.62.
Misc... <	☞ System information, page 4.62.
	☞ Miscellaneous
	☞ Operation at low ambient temperatures, page 4.64.

Fig. 4-49 System menu



## Configuring the remote control interfaces

System → Remote

### Selecting a remote control interface

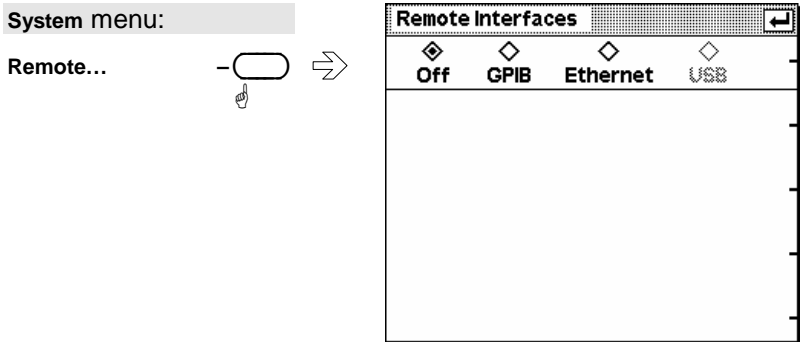

Fig. 4-50 Remote dialog box

**GPIB Ethernet** Selects the installed remote control interfaces or turns them off.

### Configuring the GPIB

Remote : GPIB

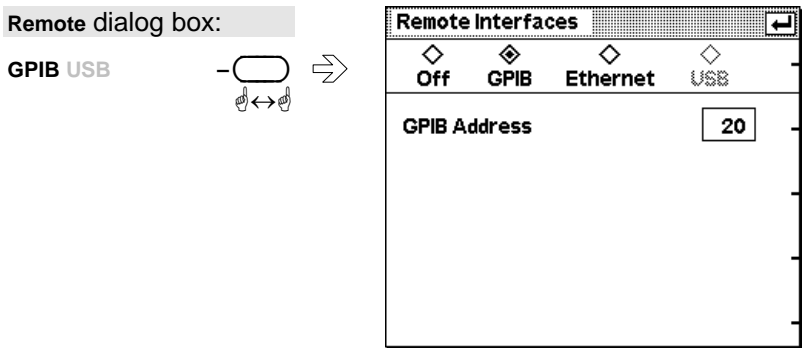

Fig. 4-51 Remote dialog box, GPIB

**GPIB Address** A GPIB address in the range 0 to 30 can be selected.

```
RemoteControl
SYStem:COMMunicate:GPIB[:SELF]:Address <NR1>
```

Remote control via USB

Remote : USB

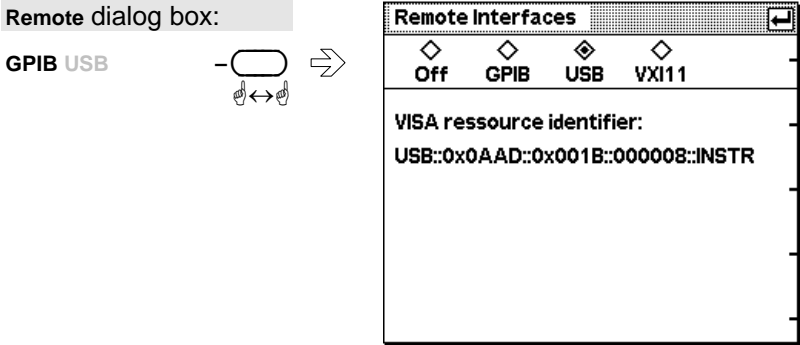

Fig. 4-52 Remote – Dialog, GPIB

Remote control of the R&S NRP via the USB is according to the USBTMC standard. For this purpose, a VISA library that supports remote control via the USB is required by the remote-control computer. The VISA library is equipped with the necessary USB device driver. The R&S NRP has a fixed, unchangeable address comprising a manufacturer number (0x0AAD for Rohde & Schwarz), an instrument number (2 for the R&S NRP) and the serial number of the R&S NRP. The serial number can be displayed in the System Info dialog box (Information about the R&S NRP, page 4.63) and must be completely, as displayed, included in the address. The VISA address string suitable for the device is displayed in the dialog box.

Configuring the Ethernet

Remote : VXI 11

Remote control of the R&S NRP via Ethernet is according to the VXI-11 standard. Prerequisite for this is the installation of the R&S NRP-B5 option. Due to the complexity of the protocol, the use of a VISA library is also urgently recommended here. The VISA library that is used must support VXI-11. The R&S NRP must have a unique IP address in the Ethernet. This address can be assigned either manually or automatically using the DHCP protocol.

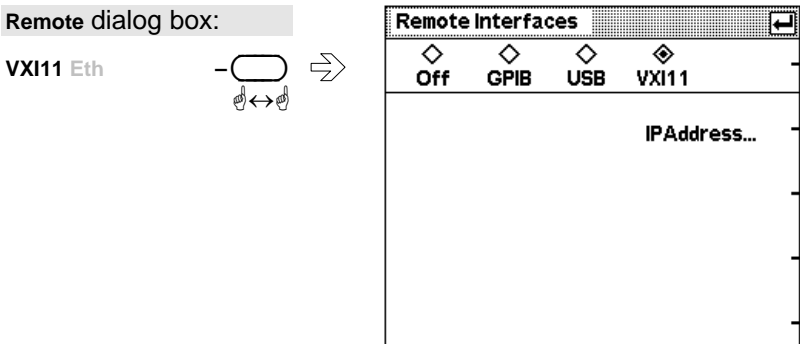

Fig. 4-53 Remote – Dialog, GPIB

**IP Address** Opens the dialog box for the configuration of the IP address.

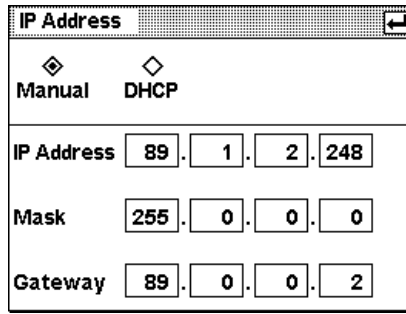

Fig. 4-54 IP Address – Dialog, Manual

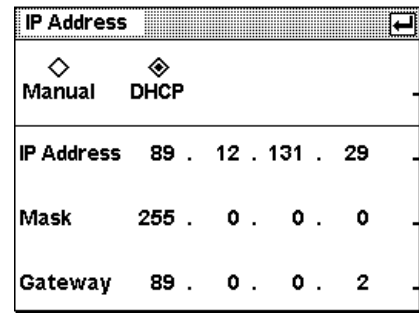





Fig. 4-55 IP Address – Dialog, DHCP

- Manual DHCP**  Selects between configuring the IP address manually or automatically.
- Remote control**  
`SYSTem:COMMunicate:GPIB[:SELf]:ADDRESS <NR1>`
- IP Address**  Manual input of IP address.
- Mask**  Manual input of network mask.
- Gateway**  Gateway computer connecting the local network with other networks.

For automatic assignment, a DHCP server must be accessible in the network.

If the R&S NRP is to be integrated into a larger network, please contact your network administrator regarding the data to be set.

If the network consists only of the R&S NRP and the control computer, the two units can be connected with each other directly using a special network crossover cable. The IP addresses are then set manually and can, for example, be selected according to the following table:

Table 4-1 Example of a network configuration for a direct R&S NRP – PC connection using a crossover cable.

	R&S NRP	PC
<b>IP Address</b>	192.168.0.2	192.168.0.1
<b>Mask</b>	255.255.255.0	255.255.255.0
<b>Gateway</b>	192.168.0.3	192.168.0.3

## Setting the analog outputs

System→IO...

There are two multifunction BNC connectors at the rear of the R&S NRP. The function of these connectors is specified in the Analog Out dialog box.

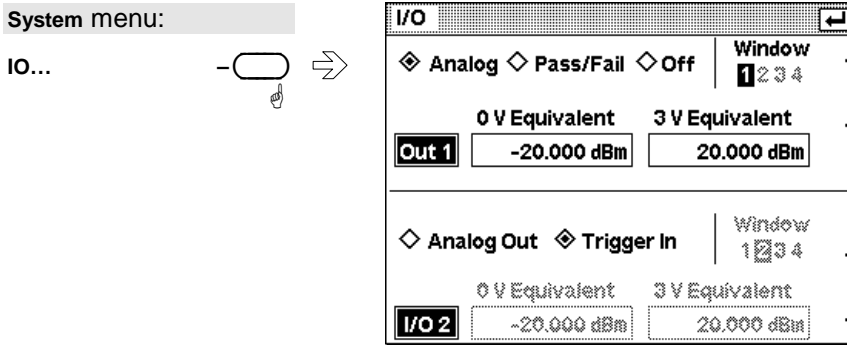

Fig. 4-56 Analog Out dialog box

Analog ... Pass/Fail

Selects the function of port Out 1.

In the case of **Analog**, a voltage is output that is proportional to the value currently displayed in the selected window (**Window 1...**). In the case of **Pass/Fail**, a logic signal is output in the selected window (**Window 1...**) to indicate that a limit value has been exceeded.

Remote Control, Analog

OUTPut:TTL[1]:STATE[?] OFF;OUTPut:REcOrder[1..2]:STATE[?] ON

Pass/Fail

OUTPut:REcOrder[1..2]:STATE[?] OFF;OUTPut:TTL[1]:STATE[?] ON

Window  1 2 3 4

Specifies the window the output pertains to.

Remote Control

OUTPut:REcOrder[1..2]:FEED[?] <string>  
OUTPut:TTL[1]:FEED[?] <string>

0 V Equivalent

Display value which corresponds to an output voltage of 0 V.

Remote Control

OUTPut:REcOrder[1..2]:LIMit:LOWer[?] <float\_value>

3 V Equivalent

Display value which corresponds to an output voltage of 3 V.

Remote Control

OUTPut:REcOrder[1..2]:LIMit:UPPer[?] <float\_value>

Pass

Logic level within the limits that have been set. The valid range is 0 V to 3.3 V.

Remote Control

OUTPut:TTL[1]:HVOLtage[?] <float\_value>

Fail

Logic level when there is a limit violation. The valid range is 0 V to 3.3 V.

Remote Control

OUTPut:TTL[1]:LVOLtage[?] <float\_value>

Analog Out  
Trigger In



Selects the function of port I/O 2.

In the case of **Analog Out**, a voltage is output to I/O 2 that is proportional to the value currently displayed in the selected window (**Window 1...**).  
In the case of **Trigger In**, I/O 2 serves as an external trigger input.

Remote Control, Analog

OUTPut:TTL[1]:STATe[?] ON

Trigger In

OUTPut:TTL[1]:STATe[?] OFF

### Background information

The voltage at the analog outputs does not follow the power fed to the sensor continuously but rather at discrete points of time. Every time the sensor has transmitted a new measured value to the base unit, i.e. after a time window has been evaluated (☞ [Filter / averaging](#), page 4.19), the voltage is adjusted to the new value.

In the ContAv mode, you can influence the rate at which the voltage is updated with the aid of the sampling window (☞ [Free-running average-power measurements](#), page 4.8). The time between two updates of the output voltage is approximately twice the length of the sampling window. The lower limit of this length of time, during which the R&S NRP can still regularly update the output voltage, depends on the number of sensors connected and their measurement mode. With a connected sensor in the ContAv mode, it is about 1 ms.

Switching on the averaging filter does not affect the refresh rate, but the speed at which the output voltage changes can be expected to slow down as a result of the filter effect.

For applications having high requirements on the dynamic behaviour of the analog outputs, for example phase-locked loops, it is advisable to freeze the screen of the R&S NRP to avoid discontinuities caused by writing to the screen memory (☞ [Miscellaneous Operation at low ambient temperatures](#), page 4.64).

## Selftest

System→Test...

While booting up, the R&S NRP performs a system test. The system test is described in Chapter 1, *Welcome screen and function test*. Hardware faults are reported at this stage.

The Selftest dialog box in the System menu is used to check the keyboard and the display and to start a selftest function in the sensors.

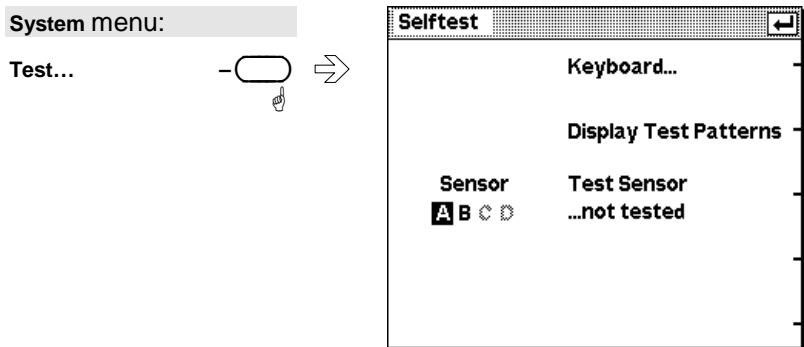

Fig. 4-57 Selftest dialog box

- Keyboard...**      - [Softkey Icon]      Opens the dialog box for testing the keyboard.
- Display Test Patterns**      - [Softkey Icon]      Displays a sequence of different test patterns for checking the display. The procedure can be aborted by pressing any key.
- Sensor A B ... Test Sensor**      - [Softkey Icon]      The right-hand softkey starts a hardware test function in the sensor selected with the left-hand softkey.
- Test Sensor Details**      - [Softkey Icon]      Opens a window containing detailed data of the sensor test.

```
Remote Control
SYSTEM:SENSOR[1..4]:TEST?
```

## Keyboard test

Selftest : Keyboard...

In the keyboard selftest dialog box, the keys can be pressed in any order. Each time a key is pressed, there is acoustic feedback and the detected key is marked. If a key is pressed more than once a warning is output. This means that specific keys or the whole keyboard can be tested.

This dialog box can be quit only if the  symbol appears on the right of the title bar. This symbol appears either after all keys have been pressed or when no key has been pressed for 15 seconds.

Selftest dialog box:

Keyboard...

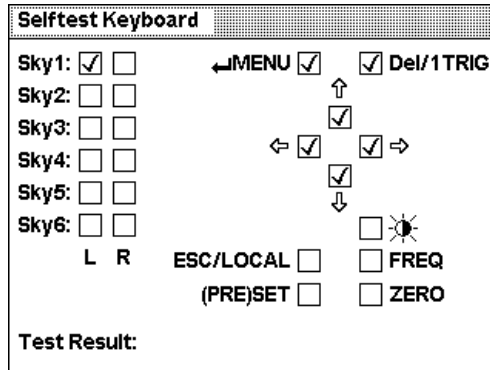

Fig. 4-58 Selftest Keyboard dialog box

The first stage in testing the whole keyboard is to press all the keys in any order without checking each response in the display. If each key has been activated once and only once, an OK message is output and the test is over. Keys that are not activated during the test do not output a tone and afterwards do not exhibit any marking. If a keystroke, e.g. due to a short, activates several keys, a warning message is output during the test. You should then repeat the test, observing the response on the display intensively.

## Test generator

System → Power Ref

How to use the test generator (option R&S NRP-B1) for  Zeroing is described on page 4.3.

As it is a high-precision generator with an output power of 1 mW at 50 MHz, it can also be used for other applications.

System menu:

Power Ref  
Off **On**



Switches the test generator on/off.

Remote Control

```
OUTPut:ROSCillator[:STATE][?] ON | OFF
```

## System information

### Information about sensors

System → Info Sensor

The following information about connected power sensors can be obtained with the Info:Sensor dialog box:

- Type and material number of sensor
- Serial number
- Software status
- Date of last calibration
- Frequency and power ranges
- Other technical data

System menu:

Info  
Sensor...

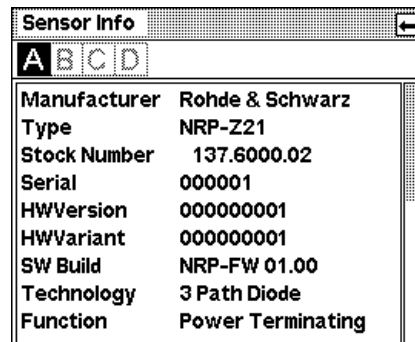

Fig. 4-59 Sensor Info dialog box



A | B | C | D



Tabs for selecting the sensor.

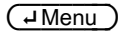

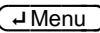
This dialog box can be closed with the  key.

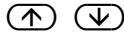

The up/down cursor keys can be used to scroll the window contents if they cannot all be viewed simultaneously.

Remote Control

SYSTem:SENSor[1..4]:INFO? [<string>]

✓ Tip

The possible values for the <string> parameter are exactly the same as the items shown in this dialog, e.g. "Manufacturer" or "HWVersion". Thus, the values available for a specific sensor model are very easy to determine.

### Information about the R&S NRP

System → Info System

The Info:System dialog box displays the following basic-device characteristics:

- Type and material number of sensor
- Serial number
- Software status of system, BIOS and keyboard controller
- Installed options
- Memory expansions
- Ethernet MAC address (for instruments with option R&S NRP-B4 installed)

System menu:

Info  
System...

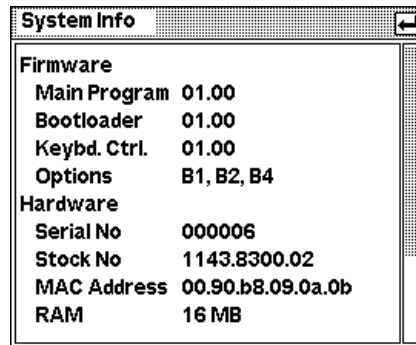
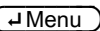

Fig. 4-60 System Info dialog box



The dialog box can be closed with the  key.



The up/down cursor keys can be used to scroll the window contents if they cannot all be viewed simultaneously.

Remote Control

SYSTem:INFO? [<string>]

## Miscellaneous

### Operation at low ambient temperatures

System→Miscellaneous

The built-in acoustic alarm can be configured in the Misc dialog.

At very low ambient temperatures, the display becomes sluggish and the rapidly changing decimal places at the end of the reading in particular cannot be reliably determined. To improve readability under these circumstances, you can reduce the display update rate.

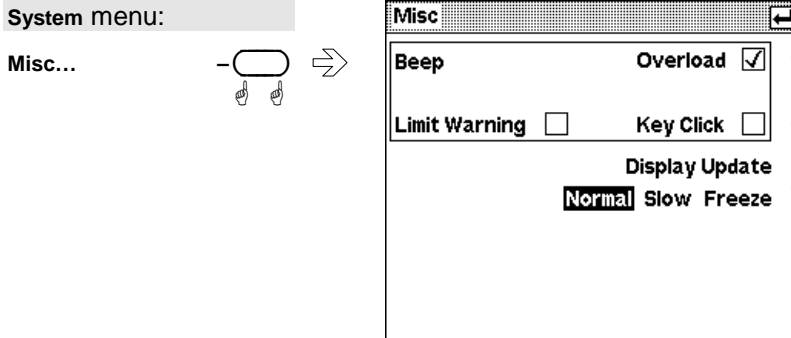



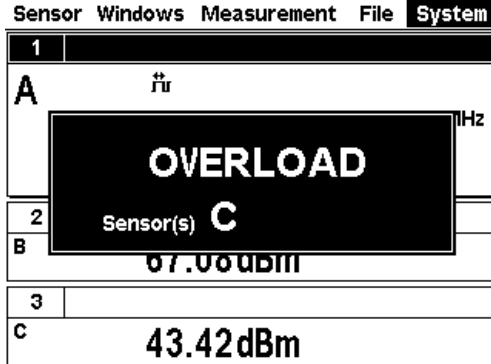

Fig. 4-61 Miscellaneous dialog box

- Beep Overload**  Activates an acoustic alarm when the sensor is overloaded.
- Beep Limit Warning**  Activates or deactivates an acoustic alarm when there is a limit violation simultaneously in all measurement windows. (☞ Limit monitoring, page 4.40).
- Beep Key Click**  Activates acoustic feedback to indicate when a key is pressed.
- Display Update**  Switches the rate at which the new measured values are displayed between Normal, Slow and Freeze. The Slow setting has been provided with very low ambient temperatures in mind. If one of the analog outputs is being used and a time resolution of a few milliseconds is needed, the screen contents can be frozen. Otherwise the picture setup leads to brief interruptions at the analog output.
- Remote Control**  
`SYSTEM:BEEPper:NOTify:OVERload[?] ON | OFF`
- Remote Control**  
`SYSTEM:BEEPper:NOTify:KEY[?] ON | OFF`
- Remote Control**  
`DISPlay:UPDate[?] NORMal | SLOW | FREeze`

## Messages and alarms



### Overload

One or more sensors are subjected to overload.



#### Caution!

Overload can destroy the sensor (depending on amount and duration of overload).

The upper measurement limit is specified in the data sheet for the sensor. The nominal value of the upper measurement limit is also displayed in the Sensor Info dialog box (☞ System information, page 4.62).

An alarm sounds when the message is displayed. The alarm can be disabled in the Misc dialog box (☞ Miscellaneous, page 4.64).

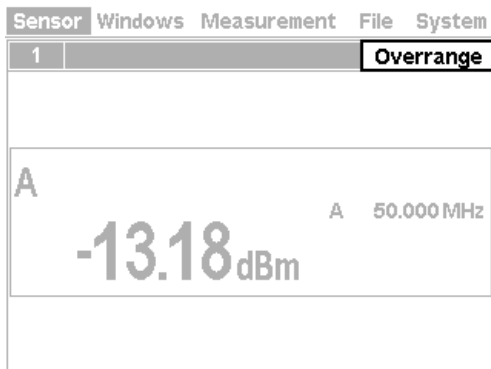

### Overrange

This message is displayed only if the Auto range function is off. It indicates that the permissible range has been exceeded. (☞ Measurement ranges, page 4.22).



### Measurement aborted

Trunc. Meas. is displayed when there is an overflow of the sensor-internal buffer for samples. Overflow occurs if a burst is too long.

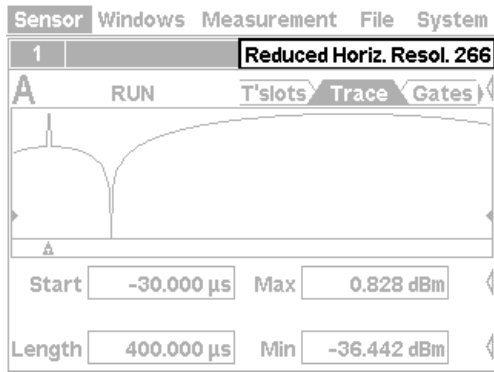

**Resolution reduced in the Scope mode**

The settings require a sampling rate located outside the range supported by the sensor. Thus, the number of sampled points is temporarily reduced.

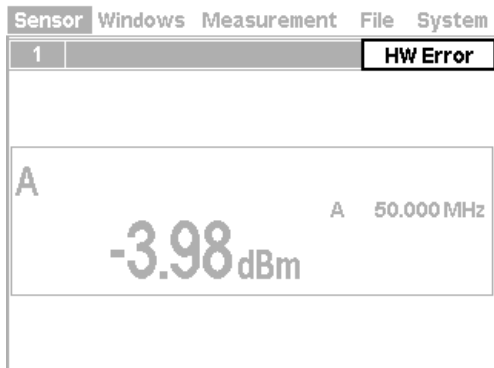

**Hardware error**

A sensor has detected a hardware error.

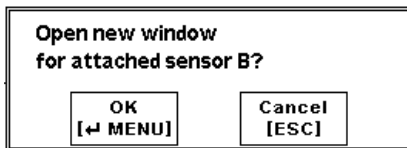

**Automatic window initialization**

If an additional sensor is connected to the R&S NRP during operation and if no currently open window displays the values measured in the channel concerned, the R&S NRP automatically offers to open a window and to configure it for measurements with the additional sensor connected.

The previous settings of the newly opened window are lost. To prevent this, we recommend you to cancel with the (ESC) key and to manually configure a window.

## Table of Contents

<b>5</b>	<b>Remote Control - Fundamentals</b> .....	5.1
	<b>Differences between Remote Control and Manual Control</b> .....	5.1
	Display .....	5.1
	Measurement Modes .....	5.2
	Calculate Blocks .....	5.2
	<b>Connecting a Controller to the Base Unit</b> .....	5.3
	Settings in Base Unit .....	5.3
	Hardware Requirements.....	5.3
	IEC/IEEE Bus.....	5.3
	<b>Switchover to Remote Control (REMOTE)</b> .....	5.3
	<b>Return to Manual Operation (LOCAL)</b> .....	5.3
	<b>Communication on Data Lines</b> .....	5.4
	Interface Messages .....	5.4
	Device-Dependent Messages (Commands and Responses) .....	5.4
	Commands.....	5.4
	Responses .....	5.5
	<b>Structure and Syntax of Device-Dependent Messages</b> .....	5.6
	SCPI Standard.....	5.6
	Command Structure.....	5.6
	Common Commands.....	5.6
	Device-Specific Commands.....	5.7
	Structure of a Program Message.....	5.9
	Responses to Queries .....	5.10
	Parameters .....	5.11
	<b>Device Model and Command Processing</b> .....	5.13
	Input Unit.....	5.13
	Command Identification (Parser).....	5.13
	Data Base and Device Hardware .....	5.13
	Status Reporting System .....	5.14
	Output Unit.....	5.14
	Command Sequence and Command Synchronization .....	5.14
	<b>Annex: Automatic Settings for Manual Selection of a Measurement Mode</b> .....	5.15
	<b>Annex: Correspondence between Remote Control and Manual Control</b> .....	5.17

**Figs.**

Fig. 5-1: SCPI command tree .....5.7  
Fig. 5-2: Device model for remote control .....5.13

**Tables**

Table 5-1: Synchronization with \*OPC, \*OPC? and \*WAI.....5.14  
Table 5-2: Automatic settings for manual selection of a measurement mode .....5.15  
Table 5-3: Correspondence between remote control and manual control .....5.17

## 5 Remote Control - Fundamentals

The Power Meter R&S NRP is equipped with an interface that can be connected to a controller for remote control.

- IEC/IEEE-bus interface (standard equipment) in line with the standards IEC 60625.1 (IEEE 488.1) and IEC 60625.2 (IEEE 488.2)
- Ethernet 10/100 BASE T interface.
- USB interface for remote control and firmware update.

Connectors are installed at the rear of the power meter. The two interfaces support the SCPI (Standard Commands for Programmable Instruments) standard, version 1999.0 of May 1999. The SCPI standard is based on the IEEE 488.2 standard and defines a standardized command language for controlling measuring and test instruments with functions beyond the scope of the IEEE 488.2 standard. In addition to the commands, error handling and status management are also described.

The present Chapter explains the differences between remote control and manual control, familiarizes the user with fundamentals of remote control and describes the status reporting system as well as the procedure for connecting a PC for remote control.

### Differences between Remote Control and Manual Control

The manual control of the R&S NRP is designed for ergonomic operation. This means, among other things, that certain parameters are assigned default values that cannot be changed and that specific changes of device settings influence other settings. In the remote control mode, all settings can be changed and the user has to make sure that the device is correctly set for the measurement to be performed. We therefore recommend performing a reset (\*RST or → `SYSTem:PRESet`, page 6.98) prior to a remote control measurement so that the device is placed in a defined state.

### Display

In the REMOTE mode, the display of measured values can be disabled (`SYSTem:SPEed FAST`); the display is cleared except for a status line at the top of the screen. Blanking of menu elements that need not be continually updated increases the data processing speed. The display can be reactivated with the SCPI command `SYSTem:SPEed NORMal`. The backlighting can also be completely switched off with `DISPlay:ILLumination OFF`.

In the remote mode, the menu line at the upper screen edge is blanked and replaced by the indication "Remote Mode". The SCPI error queue can be displayed using the topmost softkey (labelled "Error List..."). If the LLO character is displayed in the upper status line, the keyboard including `(ESC/LOCAL)` has been disabled via the `LLO` command. In this case, returning to local mode is only possible with the remote control command `GTL` or by a power-on reset.

## Measurement Modes

To simplify operation in the manual mode, preset values are used in some cases for the trigger system (TRIGger command) and the timing of the measurement (`SENSe[1..4]:TIMing:EXCLude:START` and `:STOP`) when the measurement mode (ContAv, Burst, Timeslot, Scope) is selected (→ [Table 5-2](#)). This is not the case in the remote control mode. Here the trigger system and the timing can be configured by the user as required.

## Calculate Blocks

The R&S NRP manages 8 internal calculate blocks. Each calculate block has two input channels (primary and secondary channel) to which one of up to 4 power sensors can be assigned. The channels can be processed together by means of a selectable function. The result is available at the output of the calculate block. In the manual mode, the measurement results of the first four calculate blocks (→ "[CALCulate System](#)", page [6.10](#)) are shown in windows 1 to 4, while 8 calculate blocks are available in the remote control mode.



## Connecting a Controller to the Base Unit

### Settings in Base Unit

Before a link can be established between the controller and the R&S NRP, the R&S NRP must be assigned an IEC/IEEE-bus address. In the manual control mode, this is done in the System→Remote menu.

#### IEC/IEEE bus configuration:

- Select GPIB as the active interface.
- Set the GPIB address to the desired value. Any value between 0 and 30 is permissible.

## Hardware Requirements

### IEC/IEEE Bus

In order to control the R&S NRP via the IEC/IEEE bus, a controller with an IEC/IEEE-bus interface and an IEC/IEEE-bus cable are required.

## Switchover to Remote Control (REMOTE)

A link has been established between the controller and the R&S NRP and is assumed to have been correctly configured.

After power up, the R&S NRP is always in the manual control mode (LOCAL). The R&S NRP is switched to remote control irrespective of the selected interface as soon as an SCPI command is sent to the R&S NRP. All settings are maintained when the device is switched to the REMOTE mode.

## Return to Manual Operation (LOCAL)

In the remote mode, all front-panel controls are disabled, except for the **(ESC/LOCAL)** key and the topmost toggle softkey used to insert the window with the SCPI error queue. The device remains in this state until it is switched back to manual control either on the front panel **(ESC/LOCAL)** or with the remote control command GTL.



**Note:** *The remote control command LLO also allows the **(ESC/LOCAL)** key to be disabled. In this case, return to manual operation is only possible by remote control or by switching the R&S NRP off and on again (Power On Reset).*

## Communication on Data Lines

The IEC/IEEE bus is the most common remote interface for measuring devices. It has also been implemented in the R&S NRP. The remote controller and the R&S NRP communicate by means of messages. The messages sent on the data lines (→ section "[Interfaces](#)", page 6.124) can be divided into two groups:

- **Interface messages**
- **Device-dependent messages**

### Interface Messages

Interface messages are transmitted on the data lines of the IEC/IEEE bus when the ATN control line is active. Interface messages allow the controller and the device to communicate and can only be sent by a controller which serves as the IEC/IEEE-bus controller. Interface commands can be further classified as

- **common commands**
- **addressed commands**

Common commands affect all devices connected to the IEC/IEEE bus without requiring an address, whereas addressed commands only affect devices addressed as a listener. The interface messages relevant for the device are described in the annex → "[Interface Messages](#)", page 6.127.

### Device-Dependent Messages (Commands and Responses)

Device-dependent messages are transmitted on the data lines of the IEC/IEEE bus when the ATN control line is not active. The ASCII code is used. Device-dependent messages are classified according to the direction in which they are sent:

#### Commands

are messages sent by the controller to the R&S NRP. They control the device functions and request information. The commands are classified

according to the effect they have on the device:

<b>Setting commands</b>	trigger device settings, e.g. an device reset or a configuration of the trigger system.
<b>Queries</b>	cause device data to be provided in the output queue, where they can be fetched via the IEC/IEEE bus. Queries are available for most of the setting commands. They are obtained by adding a question mark to the setting command.

according to their definition in the IEEE 488.2 and SCPI 1999.0 standard:

**Common commands** are precisely defined in the IEEE 488.2 standard in terms of function and notation. They relate to functions such as the management of standardized status registers, resetting and self test.

**Device-specific commands** relate to functions that depend on device characteristics such as the frequency setting. Most of these commands are also standardized by the SCPI Consortium (→ "[SCPI Standard](#)", page 5.6). The standard allows device-specific extensions of commands.

Parallelism:

**Overlapping commands** can be executed while another command is being executed.

**Sequential commands** can only be executed when the execution of all other commands is completed.



**Note:** *In the R&S NRP, only the remote control commands `INIT:IMM` and `CAL:ZERO:AUTO ONCE` can overlap with other commands.*

## Responses

are messages sent by the device to the controller after a query. This may be measurement results, for instance, or device status information.

# Structure and Syntax of Device-Dependent Messages

## SCPI Standard

SCPI (Standard Commands for Programmable Instruments) describes a standardized command set for the programming of instruments regardless of the type of instrument or manufacturer. The objective of the SCPI Consortium is to standardize device-specific commands as far as possible. For this purpose, a device model has been developed which defines identical functions within a device or between different devices. Command systems have been created and assigned to these functions so that it is possible to address identical functions with the same commands.

The command systems have an hierarchical structure. [Fig. 5-1](#) shows this tree structure, using details from the SENSE command system which selects the measurement to be performed by the device. Most of the other examples of command syntax and structure are taken from this command system.

SCPI is based on the IEEE 488.2 standard, i.e. it uses the same syntax elements and the common commands defined in IEEE 488.2. The syntax of the responses is subjected to somewhat stricter rules than those specified by the IEEE 488.2 standard (→ section "[Responses to Queries](#)", page [5.10](#)).

## Command Structure

Commands consist of a header and usually one or several parameters. Header and parameters are separated by a white space (ASCII code 0 to 9, 11 to 32 decimal, e.g. space). The headers may be composed of several keywords. The query is created by appending a question mark directly to the header.

## Common Commands

Device-independent commands consist of a header preceded by an asterisk (\*) The header may be followed by one or several parameters.

Examples:

**\*RST**            **Reset**, resets the device.

**\*ESE 253**       **Event Status Enable**, sets the bits of the Standard Event Status Enable Register.

**\*ESR?**           **Event Status Query**, queries the contents of the Standard Event Status Register.

## Device-Specific Commands

**Hierarchy** Device-specific commands have a hierarchical structure (→ Fig. 5-1). The various levels are represented by compound headers. Headers at the highest level (root level) have one keyword only. This keyword describes an entire command system.

Example: `SENSe[1..4]`

This keyword denotes the command system `SENSe<n>`.

For lower-level commands, the full path has to be specified, starting with the highest level in the left-most position. The individual keywords are separated by a colon ":".

**Example:** `SENSe[1..4]:TRACe:POINts <int_value>`

This command is at the third level of the `SENSe` system and sets the number of test points for the Scope mode.

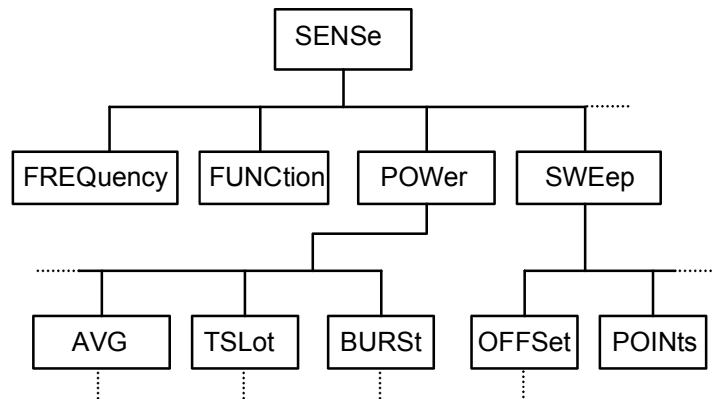

Fig. 5-1: SCPI command tree

Some keywords are used at several levels within a command system. Their effect depends on the command structure, i.e. on their position in the command header.

**Example:** `SENSe1:TRACe:POINts <int_value>`

This command contains the `POINts` keyword in the third level.

**Example:** `SENSe1:TRACe:OFFSet:POINts <int_value>`

This command contains the `POINts` keyword in the fourth level. It defines the time offset for the display of points in the Scope mode.

### Optional keywords:

In some command systems certain keywords can be inserted into or removed from the header. These keywords are shown in the manual in square brackets. For reasons of compatibility with the SCPI standard, the device must be able to recognize the full length of the command. Some of the commands become considerably shorter when the optional keywords are omitted.

Example: `[SENSe1]:POWer:TSLot:COUNT 6`

This command sets the number of timeslots in the Timeslot mode to 6. The following command has the same effect. :POWER:TSLOT:COUNT 6

Note: An optional keyword cannot be omitted if its effect is specified in more detail by a numeric suffix.

**Example:** SENSE2:POWER:TSLOT:COUNT 6 in short form:  
SENSE2:POWER:TSLOT:COUNT 6

**Long and short form** The keywords have a long and a short form. The keyword may be entered in short or in long form; other abbreviations are not allowed. The short form uses the first four characters of the long form. If the fourth character is a vowel and the long form consists of more than four characters, only the first three characters are used for the short form. The short form is shown by upper-case characters, and the long form is the entire keyword.

**Example:** STATUS:QUESTIONABLE:ENABLE 1 and STAT:QUES:ENAB 1



**Note:** Upper- and lower-case letters are only used for identifying the long and short form in the manual; the device itself does not differentiate between the two types of characters.

**Parameters** The parameter must be separated from the header by a white space. If a command contains several parameters, they have to be separated by a comma (.). Some of the commands allow the specification of the parameters MINimum, MAXimum and DEFault. For a description of the parameter types see → section [Parameters](#), page 5.11.

**Example:** SENSE1:TIMING:EXCLUDE:START? MINimum  
Response: 0  
This query asks for the minimum setting value.

**Numeric suffix** If a device has several identical functions or features, e.g. inputs, the desired function can be selected by a suffix to the command. Commands without a suffix are interpreted as having a suffix of 1.

**Example:** SENSE2:FUNCTION "POWER:AVG"  
This command sets the measurement mode of sensor 2 to the ContAv mode

## Structure of a Program Message

A program message may contain one or several commands. Several commands in a program message are separated by a semicolon (;). If the next command belongs to a different command system, the semicolon is followed by a colon. The colon stands for the root node of the command tree.

**Example:** `SYSTem:TIME 20,30,00;:SENSe:FUNCTion "POWer:AVG"`

This program message contains two commands. The first command belongs to the SYSTem system and is used to set the time of the system clock. The second command belongs to the SENSe system and must be preceded by a colon. Otherwise confusion might be caused if the SYSTem tree also had a subordinate SENSe node. In this case, it would be possible to omit the introductory keyword SYSTem. (see the following explanation:)

If the successive commands belong to the same system and therefore have one or several common levels, the program message may be abbreviated. The second command following the semicolon then starts at the level that is below the common levels. The colon after the semicolon must be omitted in this case.

**Example:** `SENSe2:TIMing:START 10; SENSe2:TIMing:STOP 10`

This program message contains two commands separated by a semicolon. Both commands belong to the SENSe system and its TIMing subsystem, i.e. they have two common levels.

In the abbreviated program message the second command starts at the level below SENSe:TIMing. The colon after the semicolon has to be omitted.

The short form of the program message is:

`SENSe2:TIMing:START 10; STOP 10`

A new program message always starts with the full path however.

**Example:** `SENSe2:TIMing:START 10  
SENSe2:TIMing:STOP 10`



**Note:** *Processing of a program message is aborted if an error occurs. If only sensor 2 is connected to a multichannel device, for example, the program message*

`SENS1:FREQ 50 GHZ;:SENS2:FREQ 50 GHZ`

*will be aborted after the first command and a second frequency setting will not be performed.*

## Responses to Queries

Unless otherwise expressly specified, a query is defined for each command. The query is created by appending a question mark to the associated command. Some of the SCPI rules for query responses are stricter than those of the IEEE 488.2 standard:

1. The required value is sent without header.

**Example:** SENSE:AVERage:TCONTRol?  
Response: MOV

2. Maximum and minimum values as well as all other quantities queried by a special text parameter are returned as numeric values.

**Example:** SENSE:POWer:TSLot:COUNT? MAXimum  
Response: 26

3. Numeric values are output without a unit. Physical quantities refer to the basic units or to the units set with the UNIT command.

**Example:** SENSE3:FREQuency?  
Response: 1.000000E06 (for 1 MHz)

4. Boolean values are returned as 0 (for OFF) and 1 (for ON).

**Example:** SYSTEM:BEEPer:STATe?  
Response: 1

5. Character data is returned in short form  
(→ also see section "[Parameters](#)", page 5.11).

**Example:** UNIT2:POWer?  
Response: DBM



## Parameters

Most commands require the specification of a parameter. Parameters must be separated from the header by a white space. Parameters may be specified as numeric values, Boolean parameters, character data, strings or block data. The type of parameter required for the specific command as well as the permissible value range are described together with the commands.

**Numeric values** Numeric values may be entered in any customary form, i.e. with sign, decimal point and exponent. If the values exceed the resolution of the device, they will be rounded off. Values between  $-9.9E37$  and  $+9.9E37$  can be entered. The exponent is denoted by "E" or "e". The exponent alone must not be used.

**Units** Physical quantities may be stated with the unit. Permissible prefixes for the unit are G (Giga), MA (Mega, MHz is also allowed), K (kilo), M (milli), U (micro) and N (nano). If no unit is specified, the basic unit will be used.

Some settings allow relative values to be stated in "One" and percent. According to SCPI, these units are represented by the strings O or DPCT.

The unit DPCT designates the deviation of a measurand from 100%. A power ratio of 95% thus corresponds to  $-5 \Delta\%$ .

Unit used in the R&S NRP	SCPI notation
Watt	W
dBm	DBM
dB $\mu$ V	DBUV
dB	DB
1	O
$\Delta\%$	DPCT
Hertz	HZ
Second	S

**Example:**

SENSE1:FREQUENCY 1.5 GHZ is equivalent to SENSE1:FREQUENCY 1.5E9

**Special numeric values**

The parameters MINimum, MAXimum, and DEFault are interpreted as special numeric values. The numeric value is returned in response to a query.

**Example:**

Command: SENSE2:POWER:APERTURE MAXimum

Query: SENSE2:POWER:APERTURE?

Response: 1.000000E02

**MIN/MAX** MINimum and MAXimum denote the minimum and maximum value.

**DEF** DEFault denotes a preset value. This value is identical to the basic setting called by the \*RST command.

**NAN** Not A Number (NAN) stands for  $9.91E37$ . NAN is only sent as a device response. This value is not defined. NAN is typically returned for dividing by zero, subtracting a value from infinity and representing missing data.

**Boolean parameters** Boolean parameters represent two states. The ON state (logical true) is represented by ON or a numeric value other than 0. The OFF state (logical false) is represented by OFF or the numeric value 0. Queries yield 0 or 1.

**Example:**

Command: SENSE:POWER:BUFFERed ON

Query: SENSE:POWER:BUFFERed?

Response: 1

**Character data** Character data follows the syntax rules for keywords, i.e. it also has both a short and a long form. They must be separated from the header by a white space same as any parameter. A query returns the short form of the character data.

**Example:**

Command: SENSE2:AVERAGE:TCONTROL MOVING

Query: SENSE2:AVERAGE:TCONTROL?

Response: MOV

**Strings** Strings must always be indicated in single or double quotes.

**Example:**

SENSE1:FUNCTION:ON "POWER:AVG" OR

SENSE1:FUNCTION:ON 'POWER:AVG'

**Block data** The block data format is suitable for the transmission of large data volumes. A command with a block data parameter has the following structure:

**Example:** DISPLAY:PIXMap?

Response: #49600xxxxxxxxx.....

The ASCII character # denotes the beginning of the data block. The next numeral specifies the number of subsequent digits defining the length of the data block. In the example above, the four digits specify a length of 9600 bytes. The data bytes follow next. During transmission of these data bytes, all terminators and other control data are ignored.

**Coupled commands** Setting one command influences the value of another command. According to SCPI 1999, this should be avoided but it makes sense when user-friendly high-level measurement commands are to be provided to configure an entire section of the device at once. The high-level commands CONF, FETCH, READ and MEASURE are therefore an exception to this rule.

## Device Model and Command Processing

The device model shown in Fig. 5-2 was prepared from the point of view of the processing of remote control commands. The individual components operate independently of each other and simultaneously. They communicate with each other by means of messages.

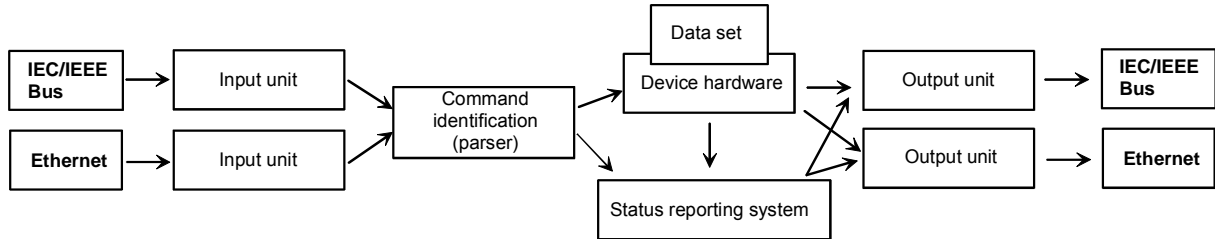

Fig. 5-2: Device model for remote control

### Input Unit

The input unit receives the commands in the form of characters from the remote control interface and collects them in the input buffer. The input unit sends a message to the command identification as soon as the input buffer is full or as soon as it receives a delimiter. The received data is processed in the parser (command identification).

### Command Identification (Parser)

The parser analyzes the data received from the input unit. Data is processed in the sequence in which it was received. Syntax errors in the command are recognized and passed on to the status reporting system. Following the syntax test, the value range of the data is verified and the setting is adapted. Only after the command has been completely executed will the next command be processed.

### Data Base and Device Hardware

The term "device hardware" refers to that part of the device which performs the measurement function.

The data base contains all parameters required for setting the device hardware. Setting commands cause a modification of the data set. Before the data is entered in the data set, it is verified for compatibility both with the other data and with the device hardware. If the setting is not possible, an error message will be sent to the status reporting system and the setting will be ignored. After successful completion of the verification, the setting will immediately be performed.

If the setting influences the result calculation, the MEASuring bit is set in the status operation register until new measured values are available. The MEASuring bit is described in more detail in the Status Reporting System section that follows. This bit may be used for the synchronization of command processing. Queries cause the data-set management to send the desired data to the output unit.

## Status Reporting System

The status reporting system collects information on the device status and makes it available to the output unit on request. Structure and function of this system are described in the following section.

## Output Unit

The data output unit collects the information requested by the controller from the data set management. It processes the information in line with the SCPI rules and makes it available in the output buffer.

## Command Sequence and Command Synchronization

All commands are executed in the order in which they are sent. There is no overlapping of command processing. (Exception: the commands `INIT` and `CAL:ZERO:AUTO ONCE`.) The user therefore can determine the sequence of execution.

If a long program message is terminated by `*OPC` or `*OPC?`, the end of command processing is signalled to the controller, provided the controller has been adequately programmed (→ [Table 5-1](#)).

Table 5-1: Synchronization with `*OPC`, `*OPC?` and `*WAI`

Command	Effect	Programming of controller
<code>*OPC</code>	Sets the Operation Complete bit in the ESR after all commands sent prior to <code>*OPC</code> have been processed.	Set bit 0 in the ESE of the R&S NRP. Set bit 5 in the SRE of the R&S NRP. Wait for service request (SRQ).
<code>*OPC?</code>	Writes 1 in the output buffer after all commands sent prior to <code>*OPC?</code> have been processed.	IEC/IEEE bus: the R&S NRP is addressed as a talker.
<code>*WAI</code>	Commands can be sent but they are only executed after completion of all commands sent prior to <code>*WAI</code> .  Dividing commands timewise before/after <code>*WAI</code> serializes the command sequence.	<code>*WAI</code> is sent directly after the command that should be completed before other commands can be executed.

## Annex: Automatic Settings for Manual Selection of a Measurement Mode

When the measurement mode of a sensor is manually selected (Sensor→Mode), automatic settings are made for the trigger system and timing, which cannot be changed by manual control. This considerably simplifies operation. These settings are not changed when the measurement mode is selected by remote control (SENSE:FUNCTION) and have to be set to the desired value by appropriate SCPI commands.

The following table lists the respective setting capabilities and the values that are automatically set in manual control.

Table 5-2: Automatic settings for manual selection of a measurement mode

Mode	SCPI command	Value	Remark
<b>ContAv</b>	TRIGger[1..4]:SOURce	IMMediate	Cannot be modified in manual mode.
	TRIGger[1..4]:SLOPe	-	Unchanged, is irrelevant.
	TRIGger[1..4]:COUNt	1	Cannot be modified in manual mode.
	TRIGger[1..4]:DELay	-	Unchanged, is irrelevant.
	TRIGger[1..4]:HOLDoff	1 NS	Cannot be modified in manual mode.
	TRIGger[1..4]:LEVel	-	Unchanged, is irrelevant.
	[SENSe[1..4]]:TIMing:EXCLude:START	-	Unchanged, is irrelevant.
	[SENSe[1..4]]:TIMing:EXCLude:STOP	-	Unchanged, is irrelevant.
INITiate[1..4]:CONTinuous	ON	Cannot be modified in manual mode.	
<b>Burst</b>	TRIGger[1..4]:SOURce	-	Unchanged, is irrelevant.
	TRIGger[1..4]:SLOPe	-	Unchanged, is irrelevant.
	TRIGger[1..4]:COUNt	1	Cannot be modified in manual mode.
	TRIGger[1..4]:DELay	-	Unchanged, is irrelevant.
	TRIGger[1..4]:HOLDoff	Depends on sensor	User-selectable.
	TRIGger[1..4]:LEVel	Depends on sensor	User-selectable.
	[SENSe[1..4]]:TIMing:EXCLude:START	Depends on sensor	User-selectable.
	[SENSe[1..4]]:TIMing:EXCLude:STOP	Depends on sensor	User-selectable.
INITiate[1..4]:CONTinuous	ON	Cannot be modified in manual mode.	
<b>Timegate</b>	TRIGger[1..4]:SOURce	EXTErnal   INTernAl	User-selectable.
	TRIGger[1..4]:SLOPe	POSitive   NEGative	User-selectable.
	TRIGger[1..4]:COUNt	1	in der HB nicht veränderbar
	TRIGger[1..4]:DELay	Depends on sensor	User-selectable.
	TRIGger[1..4]:HOLDoff	Depends on sensor	User-selectable.
	TRIGger[1..4]:LEVel	Depends on sensor	User-selectable.
	[SENSe[1..4]]:TIMing:EXCLude:START	-	Unchanged, is irrelevant.
	[SENSe[1..4]]:TIMing:EXCLude:STOP	-	Unchanged, is irrelevant.
	INITiate[1..4]:CONTinuous	ON	Cannot be modified in manual mode.

Mode	SCPI command	Value	Remark
<b>Timeslot</b>	TRIGger[1..4]:SOURce	EXTeRnal   INTeRnal	User-selectable.
	TRIGger[1..4]:SLOPe	POSitive   NEGative	User-selectable.
	TRIGger[1..4]:COUNt	1	Cannot be modified in manual mode.
	TRIGger[1..4]:DELay	Depends on sensor	User-selectable.
	TRIGger[1..4]:HOLDoff	Depends on sensor	User-selectable.
	TRIGger[1..4]:LEVel	Depends on sensor	User-selectable.
	[SENSe[1..4]]:TIMing:EXCLude:STARt	-	Unchanged, is irrelevant.
	[SENSe[1..4]]:TIMing:EXCLude:STOP	-	Unchanged, is irrelevant.
INITiate[1..4]:CONTinuous	ON	Cannot be modified in manual mode.	
<b>Scope</b>	TRIGger[1..4]:SOURce	EXTeRnal   INTeRnal	User-selectable.
	TRIGger[1..4]:SLOPe	POSitive   NEGative	User-selectable.
	TRIGger[1..4]:COUNt	1	Cannot be modified in manual mode.
	TRIGger[1..4]:DELay	0 S	Cannot be modified in manual mode.
	TRIGger[1..4]:HOLDoff	Depends on sensor	User-selectable.
	TRIGger[1..4]:LEVel	Depends on sensor	User-selectable.
	[SENSe[1..4]]:TIMing:EXCLude:STARt	0 S	Cannot be modified in manual mode.
	[SENSe[1..4]]:TIMing:EXCLude:STOP	0 S	Cannot be modified in manual mode.
	INITiate[1..4]:CONTinuous	ON	Cannot be modified in manual mode.

## Annex: Correspondence between Remote Control and Manual Control

Table 5-3 compares the control elements of the graphical user interface for manual control with the SCPI commands for remote control in order to simplify the transfer of manual control procedures to a remote control program.

Table 5-3: Correspondence between remote control and manual control





Menu item in manual control	SCPI command in short form
Sensor→Mode	SENS[1..4]:FUNCTion
Sensor→Mode→ContAv→Window	SENS[1..4]:POW:APER
Sensor→Mode→ContAv→Sampling Rate	SENS[1..4]:SAMP
Sensor→Mode→ContAv→DutyCycle	SENS[1..4]:CORR:DCYC
Sensor→Mode→ContAv→DutyCycle	SENS[1..4]:CORR:DCYC:STAT
Sensor→Mode→Burst→Dropout	SENS[1..4]:BURSt:DTOL
Sensor→Mode→Burst→Smoothing of Modulated Signals	SENS[1..4]:SMO:STAT
Sensor→Mode→Burst→Exclude Start	SENS[1..4]:TIM:EXCL:STAR
Sensor→Mode→Burst→Exclude Stop	SENS[1..4]:TIM:EXCL:STOP
Sensor→Mode→Timeslot→No. of Timeslots	SENS[1..4]:POW:TSL:COUN
Sensor→Mode→Timeslot→Nominal Width	SENS[1..4]:POW:TSL:WIDT
Sensor→Mode→Timeslot→Exclude Start	SENS[1..4]:TIM:EXCL:STAR
Sensor→Mode→Timeslot→Exclude Stop	SENS[1..4]:TIM:EXCL:STOP
Sensor→Mode→T'gate→Gate #	SENS[1..4]:SWE:SEL
Sensor→Mode→T'gate→Start of Gate	SENS[1..4]:SWE[1..4]:OFFS:TIME
Sensor→Mode→T'gate→End of Gate	Sum of SENS[1..4]:SWE[1..4]:OFFS:TIME and SENS[1..4]:SWE[1..4]:TIME
Sensor→Mode→Scope→Points	SENS[1..4]:TRAC:POIN
Sensor→Mode→Scope→Realtime	SENS[1..4]:TRAC:REAL
Sensor→Offset→Global	SENS[1..4]:CORR:OFFS SENS[1..4]:CORR:OFFS:STAT

Sensor→Offset→Table	SENS[1..4]:CORR:FDOT SENS[1..4]:CORR:FDOT:STAT
Sensor→Offset→Edit Table...	see MEMory
Sensor→Offset→S Parameter Device	SENS[1..4]:CORR:SPD:STAT
Sensor→Filter→Auto	SENS[1..4]:AVER:COUN:AUTO In Scope mode: SENS[1..4]:TRAC:AVER:COUN:AUTO
Sensor→Filter→Length	SENS[1..4]:AVER:COUN In Scope mode: SENS[1..4]:TRAC:AVER:COUN
Sensor→Filter→Auto Once	SENS[1..4]:AVER:COUN:AUTO ONCE In Scope mode: SENS[1..4]:TRAC:AVER:COUN:AUTO ONCE
Sensor→Filter→Auto Config...→Normal	SENS[1..4]:AVER:COUN:AUTO:TYPE RES In Scope mode: SENS[1..4]:TRAC:AVER:COUN:AUTO:TYPE RES
<b>Menu item in manual control</b>	<b>SCPI command in short form</b>
Sensor→Filter→Auto Config...→Fixed Noise	SENS[1..4]:AVER:COUN:AUTO:TYPE NSR In Scope mode: SENS[1..4]:TRAC:AVER:COUN:AUTO:TYPE NSR
Sensor→Filter→Auto Config...→Fixed Noise→Ref Timeslot #	SENS[1..4]:AVER:COUN:AUTO:SLOT In Scope mode: SENS[1..4]:TRAC:AVER:COUN:AUTO:SLOT
Sensor→Filter→Auto Config...→Fixed Noise→Noise Content	SENS[1..4]:AVER:COUN:AUTO:NSR In Scope mode: SENS[1..4]:TRAC:AVER:COUN:AUTO:NSR
Sensor→Filter→Auto Config...→Fixed Noise→Max. Sett. Time	SENS[1..4]:AVER:COUN:AUTO:MTIM In Scope mode: SENS[1..4]:TRAC:AVER:COUN:AUTO:MTIM
Sensor→Range→Auto	SENS[1..4]:RANG:AUTO
Sensor→Range→Path	SENS[1..4]:RANG
Sensor→Range→User def'd Crossover Sensor→Range→Level	SENS[1..4]:RANG:CLEV
Sensor→RF Source→Source $\Gamma$ considered	SENS[1..4]:SGAM:CORR:STAT
Sensor→RF Source→Phase of Source $\Gamma$	SENS[1..4]:SGAM:PHAS
Sensor→RF Source→Magnitude of Source $\Gamma$	SENS[1..4]:SGAM
Sensor→Trigger→Delay	TRIG[1..4]:DEL

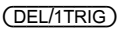
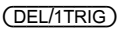

Sensor→Trigger→Source	TRIG[1..4]:SOUR TRIG[1..4]:SLOP
Sensor→Trigger→Level	TRIG[1..4]:LEV
Sensor→Trigger→Advanced...→Holdoff	TRIG[1..4]:HOLD
Sensor→Trigger→Advanced...→Hysteresis	TRIG[1..4]:HYST
Sensor→Trigger→Advanced...→Single	There is no remote control command. The functionality can only be achieved with an appropriate trigger system configuration (e.g. INIT:CONT ON;TRIG:SOUR BUS and triggering with *TRG).
Windows→Window 1234	DISP:SEL
Windows→Open/Close	DISP[1..4][:STAT]
Windows→Expand/Restore	DISP:SIZE
Windows→Dig/D&A/Graph	DISP[1..4]:FORM
Windows→Resolution	DISP[1..4]:RES SENS[1..4]:AVER:COUN:AUTO:RES
Windows→Timeslot # Windows→T'slot	DISP[1..4]:TSlot
Windows→Analog Meter...→Auto Once	DISP[1..4]:MET:AUTO ONCE DISP[1..4]:ANAL:AUTO ONCE
Windows→Analog Meter...→Left	DISP[1..4]:MET:LOW DISP[1..4]:ANAL:LOW
Windows→Analog Meter...→Right	DISP[1..4]:MET:UPP DISP[1..4]:ANAL:UPP
<b>Menu item in manual control</b>	<b>SCPI command in short form</b>
Measurement→Window 1234	DISP[1..4]:SEL
Measurement→Function...→Primary Channel Measurement→Function...→Secondary Channel Measurement→Function...→Function	CALC[1..8]:MATH:EXPR
Measurement→Function...→Unit	UNIT:POW and UNIT:POW:RAT
Measurement→Function...→Auxiliary Value = Max = Min = Max - Min	DISP[1..8]:AVAL CALC[1..8]:MAX:DATA? CALC[1..8]:MIN:DATA? CALC[1..8]:PTP:DATA?
Measurement→W / dBm / dBμV	UNIT:POW
Measurement→dB / Δ% / 1	UNIT:POW:RAT
Measurement→Rel On / Off	CALC[1..8]:REL:STAT and

Measurement→Rel Reset	CALC[1..8]:REL:AUTO ONCE
Measurement→Ref. Val...→Ref. Value	CALC[1..8]:REL
Measurement→Ref. Val...→Ref. Value→Reset (Result → Ref)	CALC[1..8]:REL:AUTO ONCE
Measurement→Limits...→Warning Sound	CALC[1..8]:LIM:BEEP
Measurement→Limits...→Upper Limit On	CALC[1..8]:LIM:UPP:STAT
Measurement→Limits...→Upper Limit	CALC[1..8]:LIM:UPP[:DATA]
Measurement→Limits...→Lower Limit On	CALC[1..8]:LIM:LOW:STAT
Measurement→Limits...→Lower Limit	CALC[1..8]:LIM:LOW[:DATA]
Measurement→Max Hold Reset	CALC[1..8]:EXTR:RES
File→Preset	SYST:PRES or *RST
File→Setup Recall...→Recall	*RCL
File→Setup Save...→Save	*SAV
File→Setup Save...→Edit Name	MEM:STAT:DEF
File→Standard Recall...→Preserve Window Settings	SYST:STAN:PWS
File→Standard Recall...→Trigger Source	SYST:STAN:TRIG:SOUR
File→Standard Recall...→Recall	SYST:STAN:PRES
File→Sensor Info...	SYSTEM:SENS[1..4]:INFO?
File→System Info...	SYSTEM:INFO?
File→Window Name	DISP:NAME
System→Remote... →GPIB→GPIB Address	SYST:COMM:GPIB:ADDR
System→I/O... →Out 1 1234	OUTP:REC1:FEED or OUTP:TTL:FEED
System→I/O... →Out 1→Analog	OUTP:REC1:STAT ON
System→I/O... →Out 1→Pass/Fail	OUTP:TTL:STAT ON
System→I/O... →Out 1→Off	OUTP:REC1:STAT ON OUTP:TTL:STAT ON
System→I/O... →Out 1→0 V Equivalent (if Analog is selected)	OUTP:REC1:LIM:LOW...
System→I/O... →Out 1→3 V Equivalent (if Analog is selected)	OUTP:REC1:LIM:UPP...
System→I/O... →Out 1→Fail (if Pass/Fail is selected)	OUTP:TTL:FAIL HIGH and OUTP:TTL:HVOLT

System→I/O... →Out 1→Pass (if Pass/Fail is selected)	OUTP:TTL:FAIL HIGH and OUTP:TTL:LVOLT
System→I/O... →I/O 2 1234	OUTP:REC2:FEED
System→I/O... →I/O 2→Analog Out	OUTP:REC2:STAT ON
System→I/O... →I/O 2→Trigger In	OUTP:REC2:STAT OFF
System→I/O... →I/O 2→0 V Equivalent (if Analog Out is selected)	OUTP:REC2:LIM:LOW . . .
System→I/O... →I/O 2→3 V Equivalent (if Analog Out is selected)	OUTP:REC2:LIM:UPP . . .
System→Errorlist	SYSTem:ERRor? DISP:ERR:STAT
<b>Menu item in manual control</b>	<b>SCPI command in short form</b>
System→Test... →Sensor ABCD / Init. Test	SYST:SENS[1..4]:TEST? *TST?
System→Power Ref	OUTP:ROSC
System→Display Update	DISP:UPD
System→Misc...→Beeper→Key	SYST:BEEP:NOT:KEY
System→Misc...→Beeper→Overload	SYST:BEEP:NOT:OVER
	DISP:CONT
	If the "Single" check box was enabled in the Scope mode, pressing  sends a *TRG to the sensor.
	Opens the File menu
	SENS[1..4]:FREQ
	CAL:ZERO:AUTO

## Table of Contents

<b>6</b>	<b>Remote Control - Commands</b> .....	<b>6.1</b>
	Notation.....	6.1
	Types of Parameters.....	6.3
	Common Commands to IEEE 488.1 .....	6.4
	DCL - Device CLeAr.....	6.4
	GTL - Go To Local.....	6.4
	LLO - Local Lock Out .....	6.4
	PPC - Parallel Poll Configure.....	6.4
	PPD - Parallel Poll Disable .....	6.4
	PPE - Parallel Poll Enable .....	6.4
	PPU - Parallel Poll Unconfigure.....	6.4
	SDC - Selected Device Clear.....	6.4
	SPD - Serial Poll Disable .....	6.5
	SPE - Serial Poll Enable.....	6.5
	Common Commands to IEEE 488.2 .....	6.5
	*CLS - CLeAr Status .....	6.5
	*ESE 0 . . 255 - Standard Event Status Enable.....	6.5
	*ESE? - Standard Event Status Enable Query.....	6.5
	*ESR? - Standard Event Status Register Query .....	6.5
	*IDN? - IDeNtification Query.....	6.5
	*IST? - Individual Status Query.....	6.6
	*OPC - OPeration Complete .....	6.6
	*OPC? - OPeration Complete Query .....	6.6
	*OPT? - OPTion Query .....	6.6
	*PRE 0 . . 255 - Parallel Poll Enable Register Command .....	6.7
	*PRE? - Parallel Poll Enable Register Query .....	6.7
	*PSC 0   1 - Power On Status Clear Command.....	6.7
	*PSC? - Power On Status Clear Query .....	6.7
	*RCL 0 . . 19 - Recall .....	6.7
	*RST - Reset.....	6.7
	*SAV 1 . . 19 - Save .....	6.7
	*SRE 0 . . 255 - Service Request Enable .....	6.8
	*SRE? - Service Request Enable Query .....	6.8
	*STB? - Status Byte Query.....	6.8
	*TRG - Trigger.....	6.8
	*TST? - Self Test Query.....	6.8
	*WAI - Wait.....	6.8

SCPI Commands .....	6.9
Overview of Command Systems .....	6.9
High-Level Measurement Commands (CONFigure, MEASure, READ and FETCh) ....	6.11
CALCulate (Configuration of Calculate Blocks) .....	6.21
CALibration .....	6.29
DISPlay .....	6.30
FORMat.....	6.38
MEMory.....	6.39
OUTPut .....	6.44
SENSe (Sensor Commands) .....	6.50
SERvice.....	6.66
STATus .....	6.68
SYSTem.....	6.93
TRIGger .....	6.103
UNIT .....	6.108
<b>List of Remote Control Commands</b> .....	<b>6.109</b>
<b>Compatibility Information</b> .....	<b>6.122</b>
<b>Interfaces</b> .....	<b>6.124</b>
IEC/IEEE Bus Interface .....	6.124
Characteristics of the Interface .....	6.124
Bus Lines .....	6.124
Interface Functions .....	6.126
Interface Messages.....	6.127
<b>Standard Configurations</b> .....	<b>6.128</b>

## Figs.

Fig. 6-1: Overview of SCPI command systems and their mutual interaction .....	6.9
Fig. 6-2: SENSE system .....	6.10
Fig. 6-3: Command system CALCulate .....	6.10
Fig. 6-4: Relationship between the commands CONFigure, READ?, FETCh? and MEASure? .....	6.12
Fig. 6-5: Characteristic of analog outputs.....	6.45
Fig. 6-6: Voltage at TTL output.....	6.49
Fig. 6-7: Meaning of drop-out TOLerance. ....	6.58
Fig. 6-8: Timing parameters for the Timegate mode.....	6.59
Fig. 6-9: Effect of commands SENS[1..4]:TIM:EXCL:STAR and :STOP .....	6.65
Fig. 6-10: Standard SCPI status register.....	6.70
Fig. 6-11: Overview on structure of Status Reporting System .....	6.73
Fig. 6-12: Operation Status Register.....	6.74
Fig. 6-13: Questionable Status Register .....	6.75
Fig. 6-14: Pin assignment of IEC/IEEE-bus interface.....	6.124

## Tables

Table 6-1: High-level measurement commands.....	6.14
Table 6-2: Commands of the CALCulate system .....	6.21
Table 6-3: Output unit of measured value of calculate block. ....	6.27
Table 6-4: Commands of the CALibration system.....	6.29
Table 6-5: Commands of the DISPlay system .....	6.30
Table 6-6: Commands of the FORMat command system.....	6.38
Table 6-7: Commands of the MEMory system .....	6.39
Table 6-8: Commands of the OUTPut system .....	6.44
Table 6-9: Voltage at TTL output.....	6.49
Table 6-10: Commands of the SENSE system.....	6.50
Table 6-11: Measurement modes.....	6.56
Table 6-12: Commands of the SERvice command system .....	6.66
Table 6-13: Queries for status registers .....	6.69
Table 6-14: Commands for the configuration of status registers .....	6.69
Table 6-15: Decimal value of individual bits in the SCPI status register.....	6.71
Table 6-16: Meaning of bits used in the status byte.....	6.76
Table 6-17: Meaning of bits used in the Device Status Register .....	6.77
Table 6-18: Meaning of bits used in the Questionable Status Register .....	6.78
Table 6-19: Meaning of bits used in the Standard Event Status Register .....	6.79

Table 6-20: Meaning of bits used in the Operation Status Register.....	6.80
Table 6-21: Meaning of bits used in the Operation Calibrating Status Register .....	6.81
Table 6-22: Meaning of bits used in the Operation Measuring Status Register.....	6.82
Table 6-23: Meaning of bits used in the Operation Status Register.....	6.83
Table 6-24: Meaning of bits used in the Operation Sense Status Register .....	6.84
Table 6-25: Meaning of bits used in the Operation Lower Limit Fail Status Register .....	6.85
Table 6-26: Meaning of bits used in the Operation Upper Limit Fail Status Register .....	6.86
Table 6-27: Meaning of bits used in the Questionable Power Status Register .....	6.87
Table 6-28: Meaning of bits used in the Questionable Window Status Register .....	6.88
Table 6-29: Meaning of bits used in the Questionable Calibration Status Register .....	6.89
Table 6-30: Initialization of device status .....	6.92
Table 6-31: Commands of the SENSE system.....	6.93
Table 6-32: Valid parameter values for the <code>SYSTEM:KEY</code> command. ....	6.96
Table 6-33: Preset and *RST value.....	6.98
Table 6-34: Commands for setting the trigger system of a sensor .....	6.103
Table 6-35: Commands of the UNIT system .....	6.108
Table 6-36: Compatibility information about remote control commands.....	6.122
Table 6-37: Interface functions of IEC/IEEE bus.....	6.126
Table 6-38: Common commands .....	6.127
Table 6-39: Addressed commands .....	6.127

## 6 Remote Control - Commands

### Notation

In the following sections, all commands implemented in the device are first listed in a table according to the command system and then described in detail. For the most part, the notation used complies with SCPI specifications.

**Command tables** For a quick overview of available commands, the commands are listed in a table before they are described. Except for the high-level measurement commands and the STATus commands, these tables contain the following four columns.

<b>Command:</b>	The commands and their hierarchical order (see indentations).
<b>Parameter:</b>	Required parameters.
<b>Unit:</b>	Basic unit of physical parameters.
<b>Remark:</b>	This column indicates which commands <ul style="list-style-type: none"> <li>• do not have a query form</li> <li>• are available as a query only</li> </ul>

**Indentations** The various levels of the SCPI command hierarchy are shown in the table by indentations to the right. The lower the level, the greater the indentation. It should be noted that the complete notation of the command always includes the higher levels.

**Example:**

SENSE[1..4]:AVERage:COUNT is shown in the table as follows:

```
SENSe[1..4] first level
  :AVERage second level
    :COUNT third level
```

In the individual description, the command is shown in full length. An example of the command is indicated at the end of the description.

**[1 to 4] or [1 to 8]** This notation indicates the numeric suffix of a command. With the SENSE commands the suffix may assume the values 1 to 4; with the CALCulate and high-level measurement commands the values 1 to 8. If the suffix is not specified, it is internally set to 1.



- [ ] Keywords and parameters in square brackets may be omitted in compound commands. This will not change the meaning of the command. Therefore, not only is there a short and a long form for the commands (distinguished here by lowercase and uppercase letters) but also a short form which is created by omitting keywords.

**For instance**, the following commands are identical:

```
[SENSE[1..4]]
  :CORREction
    :GAIN2
      [:INPut][:MAGNitude] 1

SENSE1:CORREction:GAIN2:INPut:MAGNitude 1
SENSE1:CORREction:GAIN2:INPut 1
SENSE1:CORREction:GAIN2 1
SENSE:CORREction:GAIN2 1
:CORREction:GAIN2 1
```

- [?] ? A question mark in square brackets at the end of a command indicates that this command can either be used as a setting command (without question mark) or as a query (with question mark). If the question mark is not in square brackets, the command is a query only.

**Example:**

```
[SENSE[1..4]]:POWer[:AVG]:APERture[?]
SENS1:POW:AVG:APER 1ms sets the integration time in the ContAv mode to 1 ms.
SENS1:POW:AVG:APER? returns the currently set integration time.
SYSTEM:SENSOr3:INFO? queries information of sensor C which cannot be
modified. For this reason, this command is only available as a query.
```

- | (for commands) A selection of keywords with an identical effect exists for several commands. These keywords are entered in the same line and separated by a vertical bar. Only one of these keywords has to be indicated in the header of the command. The effect of the command is independent of the keyword entered.

**Example:**

```
SENSE[1..4] first level
  :FREQuency second level
    [:CW|:FIXed] third level

SENSE[1..4]:FREQuency:CW 1E6 is equivalent to
SENSE[1..4]:FREQuency:FIXed 1E6
```

- | (for parameters) A vertical bar in the notation of parameters is used to separate alternative options and is to be seen as an "or". The effect of the command differs depending on the parameter stated.

**Example:**

```
Selection of parameter for the command INITiate:CONTinuous ON | OFF
ON or OFF can be specified as a parameter.
```

- { } Parameters in braces may be included in the command once, several times or not at all.

## Types of Parameters

<code>&lt;NRl&gt;</code>	Stands for integers with sign.  <b>Examples:</b> <ul style="list-style-type: none"><li>• 1</li><li>• -33</li><li>• 32767</li></ul>
<code>&lt;NRf&gt;</code>	Stands for floating point numbers that can also be written in exponential notation.  <b>Examples:</b> <ul style="list-style-type: none"><li>• 1</li><li>• 1.0</li><li>• -21.2345553e-6</li></ul>
<code>&lt;int_value&gt;</code>	Is an abbreviation for <code>&lt;NRl&gt;   MINimum   MAXimum   DEFault .</code>
<code>&lt;float_value&gt;</code>	Is an abbreviation for <code>&lt;NRf&gt;   MINimum   MAXimum   DEFault .</code>
<code>&lt;boolean&gt;</code>	Stands for <code>ON   OFF   0   1</code> , where ON and 1 are identical in meaning as are OFF and 0.
<code>&lt;string&gt;</code>	Stands for character strings that have to be within single or double quotes.  <b>Examples:</b> <ul style="list-style-type: none"><li>• 'Harry Potter'</li><li>• "Sirius Black"</li></ul>
<code>&lt;block_data&gt;</code>	Stands for block data (→ section " <a href="#">Parameters</a> " on page 5.11).
<code>&lt;non-decimal_numeric&gt;</code>	Is a non-decimal value in one of the following representations: <ul style="list-style-type: none"><li>• binary (e. g. #b01111010101001110 or #B01111010101001110)</li><li>• hexadecimal (e.g. #h754e or #H754E)</li><li>• octal (e.g. #q72516 or #Q75216)</li></ul>

## Common Commands to IEEE 488.1

The following messages are interface commands developed for the IEC/IEEE bus, which can be sent when the ATN line is active (→ section "[IEC/IEEE Bus Interface](#)", page 6.124).

### DCL - Device CLear

All commands and messages in progress are aborted. The TRIGger system goes to the IDLE state, input and output queues are cleared, and the parser is reset and waits for the beginning of a new command. When INITiate:CONT ON is set, a new measurement is started. This command makes the device ready to receive commands.

### GTL - Go To Local

The device is set to local mode and can again be operated manually.

### LLO - Local Lock Out

Deactivates the front-panel keypad with the exception of the power key . In the LLO state, it is possible to return to the LOCAL mode only by remote control (GTL command) or switching the R&S NRP off and on again.

### PPC - Parallel Poll Configure

Sets the device to the "Parallel Poll Addressed to Configure State" (PACS).

### PPD - Parallel Poll Disable

In the PACS, the parallel poll function is deactivated with PPD.

### PPE - Parallel Poll Enable

In the PACS, the parallel poll function is activated with PPE and the bit position and the sense bit are set.

### PPU - Parallel Poll Unconfigure

This command deactivates the parallel poll function without previous addressing.

### SDC - Selected Device Clear

Same as DCL except that it applies to all devices that are currently in the listen mode.

**SPD - Serial Poll Disable**

Terminates the serial poll mode.

**SPE - Serial Poll Enable**

Activates the serial poll mode. When addressed as a talker, the device sends the status byte.

**Common Commands to IEEE 488.2**

The Common Commands to IEEE 488.2 are device commands that can be sent via the IEC/IEEE bus.

**\*CLS - CLear Status**

Clears the status of the R&S NRP by resetting the following registers:

- Status byte register
- Standard event status register
- Error / event queue
- All SCPI status registers



**Note:** *The enable and transition registers (NTRansition and PTRansition) are not changed!*

**\*ESE 0 . . 255 - Standard Event Status Enable**

Sets the ENABLE register of the Standard Event Status Register (ESR) to the specified value(→ SCPI command [STATus](#), page [6.68](#)).

**\*ESE? - Standard Event Status Enable Query**

Returns the content of the ENABLE register of the Standard Event Status Register→ SCPI command [STATus](#) , page [6.68](#)).

**\*ESR? - Standard Event Status Register Query**

Returns the content of the EVENT register of the Standard Event Status Register→ SCPI command [STATus](#) , page [6.68](#)).

**\*IDN? - IDeNtification Query**

Returns a string with information on the R&S NRP identity (device identification code). The string has the following format <string1> , <string2> , <string3> , <string4> .

Definition of string components:

<string1>	designation
<string2>	manufacturer
<string3>	serial number of the R&S NRP
<string4>	firmware version

### \*IST? - Individual Status Query

Returns the current value of the IST flag. The IST flag is described in section → ["IST Flag and Parallel Poll Enable Register \(PPE\)"](#) on page 6.77.

### \*OPC - Operation Complete

Sets the operation complete bit in the Standard Event Status Register as soon as all currently executed commands have been completed. This bit can be used to trigger a service request. \*OPC must be at the end of a program message.

### \*OPC? - Operation Complete Query

After completion of all currently executed commands, the R&S NRP writes a "1" into the output queue.

Since \*OPC? waits until all previous commands are executed, "1" is returned in all cases. \*OPC? basically functions like the \*WAI command, but \*WAI does not return a response. \*OPC? is preferred to \*WAI because with \*OPC?, the execution of commands can be queried from a controller program before new commands are sent. This avoids an overflow of the input queue when too many commands are sent that cannot be executed.

Unlike \*WAI, \*OPC? must be at the end of a program message.

### \*OPT? - Option Query

Returns a string to the output queue containing information about all options installed.

Option	Response string
1	"NRP-B1: Test generator installed"
2	"NRP-B2: Second channel interface installed"
3	"NRP-B3: Battery installed"
4	"NRP-B4: Ethernet interface installed"
5	"NRP-B5: Four channel interface installed"
6	"NRP-B6: Sensor A/B rear socket"

**\*PRE 0 . . 255 - Parallel Poll Enable Register Command**

Sets the Parallel Poll Enable Register to the defined value.

**\*PRE? - Parallel Poll Enable Register Query**

Returns the current content of the Parallel Poll Enable Register.

**\*PSC 0 | 1 - Power On Status Clear Command**

Determines whether the content of the ENABLE registers is retained or cleared upon power-up.

\*PSC 0 causes the status registers to retain their content. With appropriate configuration of the ESE and SRE status registers, a service request may be triggered upon power-up.

\*PSC 1 clears the registers.

**\*PSC? - Power On Status Clear Query**

The query \*PSC? reads out the content of the power-on-status-clear flag. The response can be "0" or "1".

**\*RCL 0 . . 19 - Recall**

Calls the device state which has been stored with the \*SAV command under the indicated number. The effect of \*RCL 0 to 19 is the same as if one of the setups 0 to 19 had been selected in manual control.

\*RCL 0 resets the device to the default state.

**\*RST - Reset**

Sets the device to the defined default state and has almost the same effect as the SCPI command `SYSTem:PRESet`. (Table 6-33). The table also provides default settings. The following table documents the difference. `SYST:PRES` acts like the frontpanel key **(PRES)**.

	<code>INITiate:CONTinuous</code>	<code>SENSe:AVERAge:TCONtrol</code>
*RST	OFF	REPeat
<code>SYSTem:PRESet</code>	ON	MOVing

**\*SAV 1 . . 19 - Save**

Stores the current device state under the indicated number.

**\*SRE 0 . . 255 - Service Request Enable**

Sets the Service Request Enable Register bits. This command determines the conditions under which a service request is triggered.

**\*SRE? - Service Request Enable Query**

Returns the value of the Service Request Enable Register.

**\*STB? - Status Byte Query**

Returns the current value of the Status Byte Register.

**\*TRG - Trigger**

Generates a BUS-trigger event. If the sensor is in the WAIT\_FOR\_TRG state and the source for the trigger is set to BUS (TRIG:SOUR BUS), the sensor enters the MEASURING state. \*TRG invalidates all current measuring results. A query of measurement data following \*TRG will thus always return the measured value determined in response to \*TRG.

Error messages:

-211 "Trigger ignored": No sensor is in the WAIT\_FOR\_TRG state.

-211 "Trigger ignored": A sensor is in the WAIT\_FOR\_TRG state but the trigger source is not BUS.

**\*TST? - Self Test Query**

Triggers a selftest and returns 0 (no error found) or 1 (an error has occurred).

**\*WAI - Wait**

Prevents the execution of new commands until one of the following criteria is met:

- All previous commands have been executed.
- A DCL command is received.
- The device is switched off and on again (power-on-reset).

## SCPI Commands

### Overview of Command Systems

The SCPI commands described below are grouped in command systems according to their function. Only the most important functions are shown in the figures.

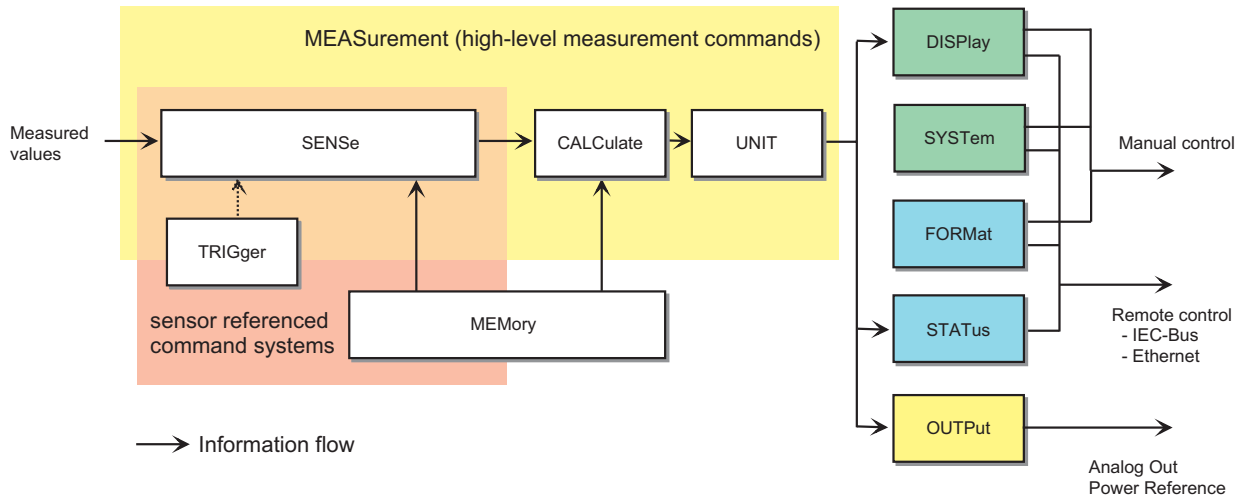

Fig. 6-1: Overview of SCPI command systems and their mutual interaction

Fig. 6-1 gives an overview of the SCPI command systems of the R&S NRP. The measured values are forwarded to the SENSE block where they are processed and handed to the CALCulate blocks. The values from the SENSE block are not immediately made available to the user, but only after they have been processed in the CALCulate blocks. In the CALCulate blocks, the values of several sensors can be processed together before they are output. MEASurement commands may be used to configure SENSE and CALCulate blocks with a single command. This may considerably simplify operation of the R&S NRP. The frequency-dependent correction tables for the measured values are managed by the MEMory command system. The other command systems have the following functions:

- DISPlay: Configures the reading on the R&S NRP display.
- FORMat: Sets the data format on the remote control interfaces.
- OUTPut: Switches the test generator on/off and calibrates it.
- STATus: Configures and queries the [Status Reporting System](#) (→ page 5.14.).
- SYSTem: Makes different system settings that affect the operation of the R&S NRP.
- UNIT: Sets the output unit of the measured values.



### SENSe System

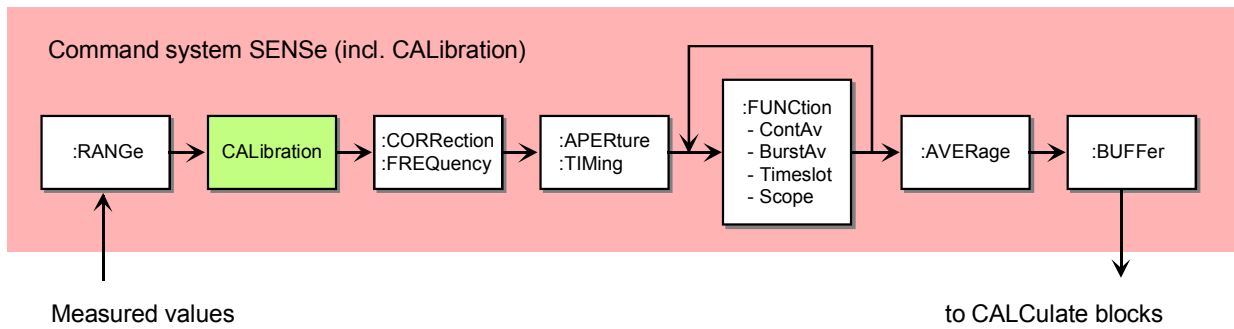

Fig. 6-2: SENSe system

This command system is used for configuring the sensors and determines the processing of measured data in the sensors. The blocks have the following functions:

- :RANGe            Shifts the range boundaries to increase the measurement accuracy.
- CALibration    Is a command system of its own and responsible for sensor calibration.
- :CORRection    Corrects measured values in three steps (fixed offset value, frequency-dependent offset value and duty cycle).
- :FREQuency
- :APERture       Determines the timeslot in which power values are averaged.
- :TIMing
- :FUNction       Determines a measurement mode.
- :AVERage        Filters the measured values.
- :BUFFer         Stores the measured values temporarily to optimize the speed of data transmission to the remote controller.

### CALCulate System

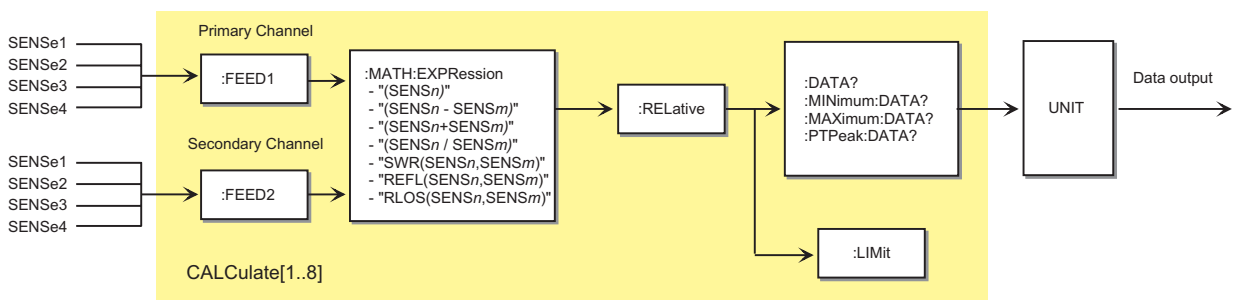

Fig. 6-3: Command system CALCulate

Eight CALCulate blocks are available to process the data supplied by the sensors. These blocks process the results of up to 2 sensors (primary and secondary channel) together. A calculation function can be selected for this purpose with the aid of :MATH:EXPRession. The result can then be correlated to a reference value (:RELative) before it is made available to the user by the UNIT block. Measured values can be monitored with the :LIMit commands.

## High-Level Measurement Commands (CONFigure, MEASure, READ and FETCh)

The high-level measurement commands CONFigure, MEASure, READ and FETCh combine several setting commands and thus simplify programming of the R&S NRP. The most convenient command is MEASure. This command configures sensors and calculate blocks, initiates a measurement and provides measurement results. The other commands perform only portions of these functions and thus allow the user to make specific modifications between the individual steps.

Strictly speaking, the CONFigure command is not a measurement command because it does not yield data and only configures a measurement. It differs from the other three high-level measurement commands as follows: a question mark at the end of the command provides information on current settings. With other commands, the question mark is compulsory and shows that the measured data is queried.

The commands have different functions:

**CONFigure:...** The calculate blocks and the associated sensors are configured by means of the parameter list. A measurement is not started. A question mark at the end of the command provides information on the parameters transferred by the last CONFigure or MEASure command, respectively. Since the device settings can be changed after a CONFigure, the query does not return the current device setup<sup>1</sup>. CONFigure is performed internally by SENSE and CALCulate commands. One or several measurement channels are configured as follows:

Measurement mode:	ContAv	Burst	Timeslot	Scope
INIT:CONT	OFF	OFF	OFF	OFF
TRIG:SOUR	IMM	INT	EXT	IMM
TRIG:COUN	1	1	1	1
TRIG:DEL:AUTO	ON	ON	ON	ON
SENS:AVER:COUN:AUTO	ON	ON	ON	-
SENS:AVER:COUN:AUTO:TYPE	ON	ON	ON	-
SENS:AVER:COUN:AUTO:SLOT	-	-	1	-
SENS:AVER:STAT	ON	ON	ON	ON
UNIT:POW UNIT:RAT	Is set as a function of the selected calculation function.			

<sup>1</sup> See also Annex "Compatibility Information".

- FETCh: . . . ?** The last valid result is returned. The command is only completed after a valid measurement has been performed. When BUS is set as the trigger source, a measurement cannot be started after the FETCh command and an SCPI error is output (-214, Trigger deadlock).  
 In compliance with SCPI 1999.0, different results can be queried with FETCh without having to restart a measurement. This is only possible if the SENSE block is not reconfigured. This is the case if only the calculation function (e.g. :RATio:RELative) changes. In all other cases, an SCPI error (-221, Setting conflict) is returned and the command aborted.
- READ: . . . ?** A measurement is started without further configuration and the measurement result is returned. The parameter list is compared to the current settings before the measurement is started. If the list does not agree, an SCPI error (-221, Setting conflict) is returned and the command aborted. Apart from this check, READ corresponds to the program message INIT:IMM; FETCh[1..8]: . . . ?
- MEASure: . . . ?** Combines CONFi gure and READ.
- FETCh?** The FETCh? command without parameters has a special meaning. While suppressing parameters normally means that default values are used and checked, the current measured value under FETCh? is supplied when it is valid. If a measured value is not yet available, processing is suspended until a valid result is available.
- READ?** Can be compared with FETCh?. READ?; starts a measurement and returns a measured value without checking the current settings.

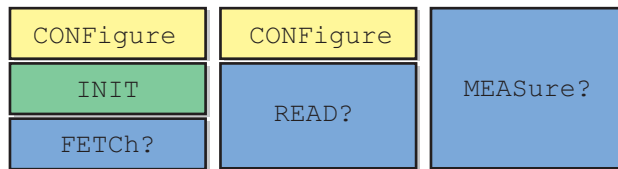

Fig. 6-4: Relationship between the commands CONFigure, READ?, FETCh? and MEASure?

## Syntactical Structure of High-Level Measurement Commands

The high-level measurement commands can be divided as follows:

**<head><function>[<expression>][?] <parameter\_list>**

**<head>**                    CONFigure[1..8], READ[1..8], MEASure[1..8], FETCh[1..8]

**<function>**                Selection of one of the measurement modes ContAv, ContAv with data buffering, Burst, Timeslot or Scope. (→SENSE[1..4]:FUNCTION command on page 6.56).

Keywords:

- [:SCALar][:POWer][:AVG]
- [:SCALar][:POWer]:TSLot
- [:SCALar][:POWer]:BURSt
- :ARRay[:POWer][:AVG]
- :XTIME[:POWer]

**<expression>**            Specification of a calculation function for the addressed CALCulate block (→CALCulate[1..8]:MATH:EXPRession command on page 6.26).

If <expression> is not specified, the measured value of the primary channel is output.

Keywords:

- :RELative
- :DIFFerence
- :DIFFerence:RELative
- :SUM
- :SUM:RELative
- :RATio
- :RATio:RELative
- :RLOSs
- :SWR
- :REFLection

**[?]**                        Queries must be terminated with an "?".

**<parameter\_list>**        A list with parameters whose meaning is determined by the selected <function>.

Since all four high-level measurement commands use the same parameter lists, they are described together in this section.

Table 6-1: High-level measurement commands

CONFigure commands	Measurement commands	Parameters
CONFigure[1..8]?	FETCh[1..8]? READ[1..8]?	
<b>ContAv mode</b>		
CONFigure[1..8]  [:SCALar] [:POWer] [:AVG] :RELative :DIFFerence :RELative :SUM :RELative :RATio :RATio:RELative :SWR :REFlection :RLOSS	READ[1..8]   MEASure[1..8]   FETCh[1..8] [:SCALar] [:POWer] [:AVG]? :RELative? :DIFFerence? :RELative? :DIFFerence? :RELative? :RATio? :RATio:RELative? :SWR? :REFlection? :RLOSS?	<contav_parameter_list> <contav_parameter_list> <contav_parameter_list> <contav_parameter_list> <contav_parameter_list> <contav_parameter_list> <contav_parameter_list> <contav_parameter_list> <contav_parameter_list> <contav_parameter_list> <contav_parameter_list>
<b>Timeslot mode</b>		
CONFigure[1..8]  [:SCALar] [:POWer]:TSLot [:AVG] :RELative :DIFFerence :RELative :SUM :RELative :RATio :RATio:RELative :SWR :REFlection :RLOSS	READ[1..8]   MEASure[1..8]   FETCh[1..8] [:SCALar] [:POWer]:TSLot [:AVG]? :RELative? :DIFFerence? :RELative? :DIFFerence? :RELative? :RATio? :RATio:RELative? :SWR? :REFlection? :RLOSS?	<timeslot_parameter_list> <timeslot_parameter_list> <timeslot_parameter_list> <timeslot_parameter_list> <timeslot_parameter_list> <timeslot_parameter_list> <timeslot_parameter_list> <timeslot_parameter_list> <timeslot_parameter_list> <timeslot_parameter_list>
<b>Burst mode</b>		
CONFigure[1..8]  [:SCALar] [:POWer]:BURSt [:AVG] :RELative :DIFFerence :RELative :SUM :RELative :RATio :RATio:RELative :SWR :REFlection :RLOSS	READ[1..8]   MEASure[1..8]   FETCh[1..8] [:SCALar] [:POWer]:BURSt [:AVG]? :RELative? :DIFFerence? :RELative? :DIFFerence? :RELative? :RATio? :RATio:RELative? :SWR? :REFlection? :RLOSS?	<burst_parameter_list> <burst_parameter_list> <burst_parameter_list> <burst_parameter_list> <burst_parameter_list> <burst_parameter_list> <burst_parameter_list> <burst_parameter_list> <burst_parameter_list>

ContAv mode (with data buffering)		
CONFigure[1..8] :ARRay [:POWer] [:AVG] :RELative :DIFFerence :RELative :SUM :RELative :RATio :RATio:RELative :SWR :REFlection :RLOSS	READ[1..8]   MEASure[1..8]   FETCh[1..8] :ARRay [:POWer] [:AVG]? :RELative? :DIFFerence? :RELative? :DIFFerence? :RELative? :RATio? :RATio:RELative? :SWR? :REFlection? :RLOSS?	<buffered_parameter_list> <buffered_parameter_list> <buffered_parameter_list> <buffered_parameter_list> <buffered_parameter_list> <buffered_parameter_list> <buffered_parameter_list> <buffered_parameter_list> <buffered_parameter_list> <buffered_parameter_list>
Scope mode		
CONFigure[1..8] :XTIME [:POWer]	READ[1..8]   MEASure[1..8]   FETCh[1..8] :XTIME [:POWer]?	<scope_parameter_list>

## Calculation Functions

The CALCulate blocks receive measurement data from the sensors via input channels which are called primary and secondary channel. The following functions are available for calculating the primary channel (PC) and the secondary channel (SC).

### One-parameter functions ( <source\_list> = (@n); n = 1, 2, 3, 4 )

-	<i>PC</i> Yields the measured average power of the sensor assigned to the PC.
:RELative	<i>PC / reference value</i> The value measured in the PC is divided by the reference value determined with the aid of one of the following commands: CALCulate[1..8]:RELative[:MAGNitude] CALCulate[1..8]:RELative:AUTO.

### Two-parameter functions ( <source\_list> = (@n), (@m); n = 1, 2, 3, 4; m = 1, 2, 3, 4 )

:DIFFerence	<i>PC - SC</i> Yields the difference between the PC and SC. This means that two sensors must be specified in <source_list>. This also applies to the following functions.
:DIFFerence:RELative	<i>(PC - SC) / reference value</i> The difference between the PC and SC is divided by the reference value determined with the aid of one of the following commands: CALCulate[1..8]:RELative[:MAGNitude] CALCulate[1..8]:RELative:AUTO.
:SUM	<i>PC + SC</i> Yields the sum of the PC and SC. The <source_list> must therefore contain two sensors. This also applies to the following functions.
:SUM:RELative	<i>(PC + SC) / reference value</i> The sum of the PC and SC is divided by the reference value determined with the aid of one of the following commands: CALCulate[1..8]:RELative[:MAGNitude] or CALCulate[1..8]:RELative:AUTO.
:RATio	<i>PC / SC</i> Yields the ratio of PC to SC.
:RATio:RELative	<i>(PC / SC) / reference value</i> The ratio of the PC and SC is divided by the reference value determined with the aid of one the following commands: CALCulate[1..8]:RELative[:MAGNitude] CALCulate[1..8]:RELative:AUTO.

**:SWR**

$$\frac{1 + \sqrt{SC/PC}}{1 - \sqrt{SC/PC}}$$

If the forward power of a wave is measured in the PC and the reflected power in the SC, the measurement command yields the standing wave ratio. The output unit is set to "One" (UNIT:RAT O).

**:REFlection**

$$\sqrt{SC/PC}$$

If the forward power of a wave is measured in the PC and the reflected/transmitted power in the SC, the calculate block yields the reflection coefficient/transmission factor of the DUT. The output unit is set to "One" (UNIT:RAT O).

**:RLOSs**

$$-20\log_{10} \sqrt{SC/PC}$$

If the forward power of a wave is measured in the PC and the reflected or transmitted power in the SC, the calculate block yields the return loss/transmission loss of the DUT.

This function principally yields the same result as the :RATio function. The only difference is the output unit which is automatically set to dB by means of this command (UNIT:RAT DB).



## Parameters

Five different parameter lists are used in the command table, depending on the selected measurement mode. The elements of these lists can be omitted starting at the end and working backward. They will then be replaced by their default values. The parameter lists are defined as follows:

<b>ContAv mode</b>	<contav_parameter_list>	[<expected_value> [,<resolution>]] [,<source_list>]
<b>Timeslot mode</b>	<timeslot_parameter_list>	<tslot_width>, <no_slots>, <start_exclude> , <end_exclude> [,<expected_value> [,<resolution>]] [,<source_list>]
<b>Burst mode</b>	<burst_parameter_list>	<dtolerance>, <start_exclude> , <end_exclude> [,<expected_value> [,<resolution>]] [,<source_list>]
<b>ContAv mode (with data buffering)</b>	<buffered_parameter_list>	(<buffered_size>), [,<expected_value> [,<resolution>]] [,<source_list>]
<b>Scope mode</b>	<scope_parameter_list>	(<scope_size>), <capture_time> [,<source_list>]

The elements of the parameter lists have the following meaning:

**<expected\_value>** Value range: <float\_value> | DEF  
According to the SCPI-1999.0 standard, a value in the order of the expected measured value can be specified. This allows the device to set an adequate measurement range. This is not required in the R&S NRP because the measurement is performed simultaneously in all measurement ranges. Any value can therefore be specified for the <expected\_value> parameter, especially the DEFault value. The value is always ignored.

**<resolution>** Value range: 1 | 0.1 | 0.01 | 0.001 |  
1 | 2 | 3 | 4

Default value: 3 (0.01)

Specifies the limit up to which the measurement result should be free of noise. The R&S NRP tries to set an adequate window for the averaging filter. This does not affect the accuracy of the measured data. The window can only be set if automatic setting of the filter window has not been disabled by the user (SENSe:AVERAge:COUNT:AUTO OFF). Since the automatic setting is activated by CONF and MEAS? as a default, the user normally does not need to alter this setting.

```

→ [SENSe[1..4]]:AVERAge:COUNT:AUTO:RESolution[?] 1 | 2
| 3 | 4,
→ [SENSe[1..4]]:TRACe:AVERAge:COUNT:AUTO:RESolution[?]
1|2|3|4 and
→ DISPlay[:WINDow][1..4]:RESolution[?] 1 | 0.1 | 0.01
| 0.001

```

**Example:**

If <resol uti on> is set to 3 or 0.01, three significant points are assigned to the value when it is displayed on a linear scale. When a log scale is used, 2 places are displayed after the decimal point.

**<source\_list>**

Value range: (@n) | (@n), (@m)  
 Default value: (@1) or (@1), (@2)  
 n and m may assume the values 1, 2, 3 or 4.

With this list, sensors are assigned to the primary and possibly to the secondary channel of a calculate block. The number for each sensor is preceded by the character @ and the entire expression is enclosed in parentheses.

**Example:**

(@1) is used for sensor A.

**Example:**

The values (@3), (@2) are set for <source\_list>. Sensor C is assigned to the primary channel and sensor B to the secondary channel. The calculate blocks process the primary channel together with the secondary depending on the desired function. If :RATio is selected as the calculation function, the result from the calculate block is the ratio of the values measured by sensor C and sensor B.

**<tslot\_width>**

Value range: depending on sensor.  
 Default value: depending on sensor.  
 Unit: s  
 Width of a timeslot in the Timeslot mode.  
 → [SENSe[1..4]][:POWER]:TSLot:[AVG]:WIDTh[?] <float\_value>

**<no\_slots>**

Value range: depending on sensor.  
 Default value: depending on sensor.  
 Unit: -  
 Number of timeslots to be measured in the Timeslot mode.

**<start\_exclude>**  
**<end\_exclude>**

Value range: depending on sensor.  
 Default value: depending on sensor.  
 Unit: s  
 Amount of time at the beginning and the end of a timeslot or integration period that should not be taken into account.  
 → [SENSe[1..4]]:TIMing:EXCLude:STARt[?] <float\_value>  
 and  
 → [SENSe[1..4]]:TIMing:EXCLude:STOP[?] <float\_value>

- <dtolerance>** Value range: depending on sensor.  
 Unit: s  
 Default value: depending on sensor.  
 The length of a time interval in which the power level may drop below the trigger level without the end of a power pulse being detected.  
 → [SENSe[1..4]][:POWer]:BURSt:DTOLerance[?]  
 <float\_value>
- <capture\_time>** Value range: depending on sensor.  
 Unit: s  
 Default value: depending on sensor.  
 Period within which measured data are captured in the Scope mode.  
 → [SENSe[1..4]]:TRACe:TIME[?] <float\_value>
- (<buffered\_size>)** Value range: depending on sensor.  
 Default value: depending on sensor.  
 Unit: -  
 Number of requested measured values.  
 → [SENSe[1..4]][:POWer][:AVG]:BUFFer:SIZE[?]  
 <int\_value>
- (<scope\_size>)** Value range: depending on sensor.  
 Default value: depending on sensor.  
 Unit: -  
 Number of measured values in one data set.  
 → [SENSe[1..4]]:TRACe:POINTs <int\_value>

## Error messages

- 24 **"Sensor mode not supported"**: A sensor does not support a measurement mode.
- 221 **"Settings conflict"**: This error is generated when a `FETCH` or `READ` command is sent and the current device settings do not correspond to the transmitted parameters. The parameters transmitted in these two commands are not used for device configuration but rather to check the settings.
- 108 **"Parameter not allowed"**: The parameter list contains unexpected parameter types or the parameters are not sent in the correct order.
- 127 **"Invalid numeric data"**: An invalid value was specified for `<resolution>`.
- 171 **"Invalid expression"**: Error in the `<source_list>` parameter. Two sensors were specified instead of one, or the specified sensor is not correct.

## CALCulate (Configuration of Calculate Blocks)

The calculate blocks calculating the measurement results from the sensor data are configured with the CALCulate command. Eight blocks are available, each with two input channels (primary and secondary channel). The available sensors (1 to 4, depending on device configuration and connected sensors) can be assigned to the channels. With the aid of a selectable function (CALC:MATH), the channels can be processed together.

Table 6-2: Commands of the CALCulate system

Command	Parameter	Unit	Remark
CALCulate[1..8]			
:DATA?		-	Query only. <b>The unit is the current unit of the measurement result.</b>
:MINimum:DATA?	-	-	Query only. The unit is the current unit of the measurement result.
:MAXimum:DATA?	-	-	Query only. The unit is the current unit of the measurement result.
:PTPeak:DATA?	-	-	Query only. The unit is the current unit of the measurement result.
:EXTRemes:RESet	-	-	No query
:FEED[1..2][?]	<string>	-	
:LIMit			
:BEEP[?]	ON OFF	-	No query
:CLEar[:IMMediate]	-	-	No query
:AUTO[?]	-	-	
:FAIL?	-	-	Query only
:FCOut?	-	-	Query only
:UPPer			
[:DATA][?]	<float_value>	-	The value range of the parameter depends on the output unit of the measured value.
:POWer[?]	<float_value>	DBM  W DBUV	
:RATio[?]	<float_value>	DB  DPCT O	
:STATe[?]	ON OFF	-	
:LOWer			
[:DATA][?]	<float_value>	-	The value range of the parameter depends on the output unit of the measured value.
:POWer[?]	<float_value>	DBM  W DBUV	
:RATio[?]	<float_value>	DB  DPCT O	
:STATe[?]	ON OFF	-	
:MATH			
[:EXPRession][?]	<string>	-	
:CATalog?	-	-	Query only
:RELative			
[:MAGNitude][?]	<float_value>	-	The value range of the parameter depends on the output unit of the measured value.
:AUTO[?]	OFF ONCE	-	
:POWer[:MAGNitude][?]	<float_value>	DBM  W DBUV	
:RATio[:MAGNitude][?]	<float_value>	DB  DPCT O	
:STATe[?]	ON OFF	-	

**CALCulate[1..8][:MINimum | :MAXimum | :PTPeak]:DATA?**

With this command the current output value of a calculate block can be queried.

If one of the optional keywords :MAXimum, :MINimum or :PTPeak is specified, other values can be queried instead of the current measured value.

- :MAXimum**      Maximum and minimum of all measured values that previously occurred in this calculate block. The two limit values are set to the current measured value when
  - the device is switched on
  - a reset is performed (\*RST)
  - the values are explicitly set to the current measured value using the command CALCulate[1..8]:EXTRemes:RESet.
- :MINimum**
- :PTPeak**      Peak-to-peak distance (maximum - minimum) of measured values in the calculate block.

Unit: → [Table 6-3](#) on page [6.27](#).

**CALCulate[1..8]:EXTRemes:RESet<sup>2</sup>**

The R&S NRP stores the maximum and minimum values for each calculate block. The current measured value is stored with CALC[1..8]:EXTR:RES as the new minimum and maximum value. The extreme values can be queried with CALC[1..8]:MIN:DATA? and CALC[1..8]:MAX:DATA?.

**CALCulate[1..8]:FEED[1..2][?] <string>**

The sensors connected with the calculate block via the primary and secondary channel can yield differently processed data: peak value, average value, peak-to-average value or even a measurement sequence, as is the case in the Scope mode. The CALC:FEED determines which of this data is to be processed by the calculate block. Depending on the measurement mode, the following settings are possible:

Primary channel measurement mode	<string>	Meaning
ContAv	"POWer:AVERAge"	Average value
Burst	"POWer:AVERAge"	Average value
Timeslot	"POWer:AVERAge"	Average value
Timegate	"POWer:AVERAge"	Average value
Scope	"POWer:TRACe" "POWer:AVERAge ON SWEEp[1..4]" "POWer:PTAVERage ON SWEEp[1..4]" "POWer:PEAK ON SWEEp[1..4]"	Measurement sequence Average value in time gate 1, 2, 3 or 4 Peak-to-average value in time gate 1, 2, 3 or 4 Peak value in time gate 1, 2, 3 or 4

CALC:FEED is only important if used in the Scope mode. Average values are processed exclusively in all other modes.

**\*RST value:** "POW:AVER"

<sup>2</sup> CALC:EXTR:RES is identical to CALC:PHOLD:CLEAr. See Annex "Compatibility Information".

**CALCulate[1..8]:LIMit:BEEP ON | OFF**

Switches the acoustic warning for limit violations on or off.

**\*RST value:** OFF

**CALCulate[1..8]:LIMit:CLEar[:IMMediate]**

Resets the limit monitoring state and the internal counter for limit violations.

**CALCulate[1..8]:LIMit:CLEar:AUTO ON | OFF | ONCE**

Automatically resets the limit monitoring state and the internal counter for limit violations if any of the following events occurs:

- INITiate[:IMMediate] is executed
- INITiate:CONTinuous ON is executed
- A MEASure? or MEASure:...? query is executed.
- A READ? or READ:...? query is executed.

If the automatic function is set to ONCE, the counter is reset only when the next of these events occurs.

**\*RST value:** OFF

**CALCulate[1..8]:LIMit:FAIL?**

Queries whether upper or lower limits have been exceeded. The status is reset by the following events (0 = no limit violation):

- The device is switched on
- A reset is performed (\*RST)
- The CALCulate[1..8]:LIMit:CLEar command is sent.

**CALCulate[1..8]:LIMit:FCOunt?**

This query returns the number of limit violations that occurred. The counter is zeroed when the following events occur:

- The device is switched on
- A reset is performed (\*RST)
- The CALCulate[1..8]:LIMit:CLEar command is sent.

**CALCulate[1..8]:LIMit:LOWer[:DATA][?] <float\_value>**

This command sets a lower limit for the measured values. The R&S NRP can respond when the values drop below this limit (see other CALCulate[1..8]:LIMit commands).

The parameter unit is determined according to [Table 6-3](#).

The value range depends on the current output unit of the calculate block's measured value:

Unit of measured value	W	DBM	DBUV	DPCT	DB	O
Value range	-9.999999E5 .. 9.999999E5	-120 .. 90	-13.0103 .. 196.897	-100 .. 999.99	-200 .. 200	-1E20 .. 1E20

**Unit:** → [Table 6-3](#) on page [6.27](#).

**\*RST value:** 0 DBM or 0 DB

**CALCulate[1..8]:LIMit:LOWer[:DATA]:POWer[?] <float\_value>**

This command sets a lower limit for the measured power (unit W, DBM or DBUV). The R&S NRP can respond when the values drop below this limit (see other CALCulate[1..8]:LIMit commands).

**Unit:** DBM | W | DBUV

**Default unit:** DBM

**Value range:** -120 DBM to 90 DBM

**\*RST value:** 0 DBM

**CALCulate[1..8]:LIMit:LOWer[:DATA]:RATio[?] <float\_value>**

This command sets a lower limit for the measured power ratios (unit DB, DPCT or O). The R&S NRP can respond when the ratios drop below this limit (see other CALCulate[1..8]:LIMit commands).

**Unit:** DB | DPCT | O

**Default unit:** DB

**Value range:** -200..200 DB

**\*RST value:** 0 DB

**CALCulate[1..8]:LIMit:LOWer:STATe[?] ON | OFF**

This command switches the monitoring function for the lower limit on or off.

**\*RST value:** OFF

**CALCulate[1..8]:LIMit:UPPer[:DATA][?] <float\_value>**

This command sets an upper limit for the measured values. The R&S NRP can respond when this limit is exceeded (see other CALCulate[1..8]:LIMit commands).

The value range depends on the current output unit of the measured value of the calculate block.

Unit of measured value	W	DBM	DBUV	DPCT	DB	O
Value range	-9.99999E5 .. 9.99999E5	-120 .. 90	-13.0103 .. 196.897	-100 .. 999.99	-200 .. 200	-1E20 .. 1E20

**Unit:** → [Table 6-3](#) on page 6.27.

**\*RST value:** 0 DBM or 0 DB

**CALCulate[1..8]:LIMit:UPPer[:DATA]:POWer[?] <float\_value>**

This command sets an upper limit for the measured power (unit W, DBM or DBUV). The R&S NRP can respond when this limit is exceeded (see other CALCulate[1..8]:LIMit commands).

**Unit:** DBM | W | DBUV

**Default unit:** DBM

**Value range:** -120 DBM to 90 DBM

**\*RST value:** 0 DBM

**CALCulate[1..8]:LIMit:UPPer[:DATA]:RATio[?] <float\_value>**

This command sets an upper limit for the measured power ratios (unit DB, DPCT or O). The R&S NRP can respond when this limit is exceeded (see other CALCulate[1..8]:LIMit commands).

**Unit:** DB | DPCT | O

**Default unit:** DB

**Value range:** -200 DB to 200 DB

**\*RST value:** 0 DB

**CALCulate[1..8]:LIMit:UPPer:STATe[?] ON | OFF**

This command switches the monitoring function for the upper limit on or off.

**\*RST value:** OFF



**CALCulate[1..8]:MATH[:EXPRession][?] <string>**

The <string> parameter may assume the following values (1, 2, 3 and 4 for  $n$  and  $m$ ). A sensor must be connected to the respective channel.

<string>	Meaning
" ( SENS1 ) " " ( SENS2 ) " " ( SENS3 ) " " ( SENS4 ) "	The calculate block outputs the measured value of sensor A. The calculate block outputs the measured value of sensor B. The calculate block outputs the measured value of sensor C. The calculate block outputs the measured value of sensor D.
" ( SENS $n$ -SENS $m$ ) "	The calculate block outputs the difference between the measured values of sensor $n$ and sensor $m$ .
" ( SENS $n$ +SENS $m$ ) "	The calculate block outputs the sum of the measured values of sensor $n$ and sensor $m$ .
" ( SENS $n$ / SENS $m$ ) "	The calculate block outputs the quotient of the values measured by sensor $n$ and $m$ .
" SWR ( SENS $n$ , SENS $m$ ) "	$\frac{1 + \sqrt{SENSm / SENSn}}{1 - \sqrt{SENSm / SENSn}}$ If sensor $n$ measures the forward power of a wave and sensor $m$ the reflected power, the calculate block outputs the standing wave ratio of this wave. The output unit is set to percent (UNIT : RAT PCT).
" REFL ( SENS $n$ , SENS $m$ ) "	$\sqrt{SENSm / SENSn}$ If sensor $n$ measures the forward power of a wave and sensor $m$ the reflected/transmitted power, the calculate block outputs the reflection coefficient/transmission factor of a DUT. The output unit is set to percent (UNIT : RAT PCT).
" RLOS ( SENS $n$ , SENS $m$ ) "	$-20 \log_{10} \sqrt{SENSm / SENSn}$ If sensor $n$ measures the forward power of a wave and sensor $m$ the reflected/transmitted power, the calculate block outputs the return loss/transmission loss of a DUT. This function principally supplies the same result as the (SENS $n$ /SENS $m$ ) function. The difference is that the output unit is automatically set to dB. (UNIT : RAT DB).

This command selects a measurement function that processes one sensor or two together. The result of this calculation is made available as a measured value and can be queried with FETch[1..8]? or CALCulate[1..8]:DATA?.

**\*RST value:** CALC1:MATH " ( SENS1 ) ",  
 CALC2:MATH " ( SENS2 ) ",  
 CALC3:MATH " ( SENS3 ) ",  
 CALC4:MATH " ( SENS4 ) ",  
 CALC5:MATH " ( SENS1 ) ",  
 CALC6:MATH " ( SENS1 ) ",  
 CALC7:MATH " ( SENS1 ) ",  
 CALC8:MATH " ( SENS1 ) ".

#### Error messages:

-151 "Invalid string data": An invalid <string> parameter was transmitted.

**CALCulate[1..8]:MATH[:EXPRession]:CATalog?**

Lists all supported calculation functions. All functions are sent in the form of strings which are allowed as parameters for the CALCulate[1..8]:MATH:EXPRession command.

**CALCulate[1..8]:RELative[:MAGNitude][?] <float\_value>**

This command determines a value that is used as a divisor (logarithmic subtraction) for all measured values of the calculate block in the CALC:REL:STAT ON state. The unit of this value is equal to the unit of the output value of the calculate block and is defined according to [Table 6-3](#):

Table 6-3: Output unit of measured value of calculate block.

CALC:MATH?	CALC:REL:STAT OFF	CALC:REL:STAT ON
"(SENSn)"	DBM   W   DBUV	DB   DPCT   O
"(SENSn-SENSm)"	DBM   W   DBUV	DB   DPCT   O
"(SENSn+SENSm)"	DBM   W   DBUV	DB   DPCT   O
"(SENSn/SENSm)"	DB   DPCT   O	DB   DPCT   O
"SWR(SENSn,SENSm)"	O	-
"REFL(SENSn,SENSm)"	O	-
"RLOS(SENSn,SENSm)"	DB	-

The value range depends on the current output unit of the measured value of the calculate block.

Unit of measured value	W	DBM	DBUV	DPCT	DB	O
Value range	-9.99999E5 .. 9.99999E5	-120 .. 90	-13.0103 .. 196.897	-100 .. 999.99	-200 .. 200	-1E20 .. 1E20

Unit: → [Table 6-3](#).

\*RST value: 0 DBM or 0 DB

**CALCulate[1..8]:RELative:POWer[:MAGNitude] [?] <float\_value>**

Has the same direct effect as CALC:REL on the reference value for measured values that share the unit of a power.

**Unit:** DBM | W

**Default unit:** DBM

**Value range:** 1e-18..1e18 W | -150..210 DBM

**\*RST value:** 0 DBM

**CALCulate[1..8]:RELative:RATio[:MAGNitude] [?] <float\_value>**

Has the same direct effect as CALC:REL on the reference value for measured values that share the unit of a power ratio.

**Unit:** DB | PCT

**Default unit:** DB

**Value range:** -200..200 DB | 1e-18..1e22 PCT

**\*RST value:** 0 DB

**CALCulate[1..8]:RELative[:MAGNitude]:AUTO[?] OFF | ONCE**

Sets the current measured value as the reference value. When used as a setting command, this command can only be called by the parameter ONCE. OFF will be ignored. OFF is always returned in response to a query.

**\*RST value:** OFF

**Error messages:**

-230 "Data corrupt or stale": The current measured value is invalid.

**CALCulate[1..8]:RELative:STATE[?] ON | OFF**

Determines whether a reference value is used. If this command is called with ON, all results of the calculate block are divided by the reference value set with CALCulate[1..8]:RELative[:MAGNitude].

**\*RST value:** OFF

## CALibration

Table 6-4: Commands of the CALibration system

Command	Parameter	Unit	Remark
CALibration[1..4]:ALL			
:ZERO			
:AUTO[?]	ON OFF ONCE		
:DATA[?]	<block_data>		

**CALibration[1..4]:ALL]:ZERO:AUTO[?] ON | OFF | ONCE**

The CALibration[1..4]:ZERO:AUTO ONCE command performs zeroing using the signal at the sensor input. The sensor must be disconnected from all power sources. If the signal at the input considerably deviates from 0 W, an error message is issued and the command is aborted (SCPI error - 231, "Data questionable; ZERO ERROR").

When used as a setting command, CAL[1..4]:ZERO:AUTO accepts only the parameter ONCE (start of zeroing); OFF is ignored and ON is not accepted. A query returns ON if a calibration is running, in all other cases OFF.

The command is overlapping, i.e. other commands can be sent to the R&S NRP while one or more calibrations are running.

Zeroing is recommended if

- the temperature has varied by more than about 5 °C,
- the sensor has been replaced,
- no zeroing was performed in the last 24 hours,
- signals of very low power are to be measured, for instance, if the expected measured value is less than 10 dB above the lower measurement range limit.

**\*RST value:** OFF

### Error messages:

-224 "Illegal parameter value": The transfer parameter is a numeric value unequal 0 (corresponds to OFF).

**CALibration[1..4]:ALL]:DATA[?] <block\_data>**

This command is used to read and write binary calibration data sets for the sensors.

## DISPlay

The DISPlay command system is mainly used to configure the display of windows on the R&S NRP. The WINDow commands are assigned to the calculate blocks 1 to 4. The values calculated from the sensor values by the respective calculate block with the aid of the measurement function are displayed.

Table 6-5: Commands of the DISPlay system

Command	Parameter	Unit	Remark
DISPlay			
:ILLumination[?]	<boolean>	-	
:ERRorlist[:STATE][?]	<boolean>	-	
:MESSage			
[:STATE][?]	-	-	
:TEXT			
:CLEar	-	-	No query
[:DATA]	-	-	No query
:TYPE[?]	QUERy MESSage	-	
:PIXMap?	-	-	Query only
:UPDate[?]	NORMal SLOW FREeze	-	
[:WINDow][1..4]			
:AVALue[?]	MINimum   MAXimum   PTPeak   OFF	-	
:FORMat[?]	DIGital ANALog  GRAPhical	-	
:METer   :ANALog			
:AUTO[?]	ONCE OFF	-	
:LOWer[?]	<float_value>	-	The value range of the parameter depends on the output unit of the measured value.
:POWER[?]	<float_value>	DBM  W DBUV	
:RATio[?]	<float_value>	DB  DPCT O	
:UPPer[?]	<float_value>	-	The value range of the parameter depends on the output unit of the measured value.
:POWER[?]	<float_value>	DBM  W DBUV	
:RATio[?]	<float_value>	DB  DPCT O	
:NAME[?]	<string>	-	
:RESolution[?]	1 0.1 0.01 0.001	-	
[:STATE][?]	ON OFF	-	
:TRACe			
:LOWer[?]	<float_value>	DBM  W DBUV	
:UPPer[?]	<float_value>	DBM  W DBUV	
:TSLot[?]	<int_value>	-	
:WINDow			
:SELect[?]	1 2 3 4	-	
:SIZE[?]	NORMal ZOOMed	-	

### DISPlay:ILLumination[?] ON | OFF<sup>3</sup>

This command switches the backlighting (ON) or (OFF). Backlighting is switched on again in case of a reset.

**\*RST value:** ON

<sup>3</sup> DISP:ILL is identical to DISP:ENABLE. See Annex "Compatibility Information".

**DISPlay:ERRorlist[?] ON | OFF**

Displays (ON) or removes (OFF) a windows which contains the contents of the SCPI error queue. The queue may be deleted by pressing the **(DEL)** key.

**\*RST-Value:** OFF

**DISPlay:MESSage[:STATe][?] ON | OFF**

Displays a window containing a user-defined message. The message text is defined via `DISP:MESS:TEXT`. In addition, `DISP:MESS:TYPE` can select between two types of message windows. Calling the command with the OFF parameter is ignored if `DISP:MESS:TYPE QUERY` is set, because in this case a window must be closed by pressing the **(↓MENU)** key.

**\*RST value:** OFF

**DISPlay:MESSage:TEXT:CLear**

Deletes the stored text for user-defined messages.

**DISPlay:MESSage:TEXT[:DATA] <string>**

Defines the text that can be displayed in a message window. The text can contain ASCII characters from code 32 (" ") to code 126 ("~"). The string "\n" is interpreted as a line break. Up to 4 lines (`DISP:MESS:TYPE MESS`) or up to 2 lines (`DISP:MESS:TYPE QUERY`) can be shown. The length of a line depends on the characters used, because a proportional font is used. Lines that are too long are cut off, which is indicated by "..." at the end of the line.

**\*RST value:** none

**DISPlay:MESSage:TYPE QUERY | MESSAGE**

Sets the mode for the expected user response, if the window with the user-defined message is displayed:

**QUERY**            The message window must be closed by pressing the **(↓MENU)** key. The execution of remote control commands is blocked until this has been done.

**MESSAGE**          Remote control command processing is immediately continued. The message window must be closed with `DISP:MESS OFF` if it is no longer needed.

**\*RST value:** MESSAGE

**DISPlay:PIXMap? <block\_data>**

Supplies the display content as binary block data. The content is sent line by line with one bit corresponding exactly to one pixel.

**Example:**

DISP:PIXM? returns: #49600xxxxxxxxx...x, with x in binary format comprising the display contents.

**DISPlay:UPDate[?] NORMAl | SLOW | FREeze**

Adjust the update frequency of the measured values in the display. In case of discontinuities in the voltage progress at the analog outputs display updates may be suspended with DISPlay:UPD FREeze. The display won't consume CPU time in this state.

\*RST-Value: NORMAl

**DISPlay[:WINDow][1..4]:AVALue[?] MINimum | MAXimum |  
PTPeak | OFF**

Determines which additional information about the measured values is shown in the display.

**MINimum** Minimum/Maximum of all measured values since the last CALC:EXTR:RES or Power On, respectively.  
**MAXimum**

**PTPeak** Differenz (linear units) or logarithmic ratio (logarithmic units) of maximum and minimum of all measured values since the last CALC:EXTR:RES or Power On, respectively.

**OFF** No additional information is displayed.

\*RST-Wert: OFF

**DISPlay[:WINDow][1..4]:FORMat[?] DIGital | ANALog | GRAPHical**

Selects the display mode for measured data.

**DIGital** Measured values are displayed in numeric format.

**ANALog** Measured values are indicated by a marker on a scale. The values at the upper and lower scale end as well as the type of scaling (linear or logarithmic) are set with the following :METer commands.

**GRAPHical** Measured values are plotted over time. This kind of presentation is possible only if the Primary Channel is operated in Scope mode.

\*RST value: DIGital

**DISPlay[:WINDow][1..4]:METer[:ANALog:AUTO[?]] ONCE | OFF**

DISP:AUTO ONCE automatically determines scaling for the analog display. The upper and the lower limit value of the display is set as a function of the current measurement data. Only the ONCE parameter is permissible; a query always supplies the value OFF.

**\*RST value:** OFF

**DISPlay[:WINDow][1..4]:METer[:ANALog:LOWer[?]] <float\_value>**

Sets the lower limit value of the analog scale.

The value range depends on the current output unit of the measured value of the window.

Unit of measured value	W	DBM	PCT	DB
Value range for <float_value>	1e-18..1e18	-150..210	1e-18..1e22	-200..200

**Unit:** → [Table 6-3](#) on page [6.27](#).

**\*RST value:** -90 DBM or -120 DB

**DISPlay[:WINDow][1..4]:METer[:ANALog:LOWer:POWER[?]] <float\_value>**

Sets the lower limit value of the analog scale. This value is used if the unit of the measurement result is Watt, dBm or dBµV, i.e. the measurement result is a power.

**Unit:** DBM | W | DBUV

**Default unit:** DBM

**Value range:** see DISPlay[:WINDow]:METer[:ANALog:LOWer[?]]

**\*RST value:** -90 DBM

**DISPlay[:WINDow][1..4]:METer[:ANALog:LOWer:RATio[?]] <float\_value>**

Sets the lower limit value of the analog scale. This value is used if the unit of the measurement result is dB, percent or the number 1, i.e. the measurement result is a power ratio.

**Unit:** DB | DPCT | O

**Default unit:** DB

**Value range:** see DISPlay[:WINDow]:METer[:ANALog:LOWer[?]]

**\*RST value:** -120 DB



**DISPlay[:WINDow][1..4]:METer|:ANALog:UPPer[?] <float\_value>**

Sets the upper limit value of the analog scale.

The value range depends on the current output unit of the measured value of the window.

Unit of measured value	W	DBM	DBUV	DPCT	DB	O
Value range	-9.99999E5 .. 9.99999E5	-120 .. 90	-13.0103 .. 196.897	-100 .. 999.99	-200 .. 200	-1E20 .. 1E20

**Unit:** → [Table 6-3](#) on page 6.27.

**\*RST value:** 30 DBM or 60 DB

**DISPlay[:WINDow][1..4]:METer|:ANALog:UPPer:POWer[?] <float\_value>**

Sets the upper limit value of the analog scale. This value is used if the unit of the measurement result is Watt, dBm or dBµV, i.e. the measurement result is a power.

**Unit:** DBM | W | DBUV

**Default unit:** DBM

**Value range:** see `DISPlay[:WINDow]:METer|:ANALog:UPPer[?]`

**\*RST value:** 30 DBM

**DISPlay[:WINDow][1..4]:METer|:ANALog:UPPer:RATio[?] <float\_value>**

Sets the upper limit value of the analog scale. This value is used if the unit of the measurement result is dB, percent or the number 1, i.e. the measurement result is a power ratio.

**Unit:** DB | DPCT | O

**Default unit:** DB

**Value range:** see `DISPlay[:WINDow]:METer|:ANALog:UPPer[?]`

**\*RST value:** 60 DB

**DISPlay[:WINDow][1..4]:NAME[?] <string>**

Determines the string to be displayed in the titlebar of the respective window. The reset values depend on the window ( $n = 1, 2, 3$  or  $4$ ).

**\*RST value:** ""

**Example:**

DISP1:NAME "Power In"

DISP2:NAME "Power Out"

The measured values in the display are now visually assigned to the different test points in the test setup. (Input power in window 1, output power in window 2).

**DISPlay[:WINDow][1..4]:RESolution[?] 1 | 0.1 | 0.01 | 0.001**

Specifies the number of significant places of the mantissa when the measurement result is displayed on a linear scale. The R&S NRP tries to adjust the averaging filter range so that the display noise decreases with increasing resolution. The values of the transfer parameter have the following meaning:

Parameter	Linear scale of measurement result	Logarithmic scale of measurement result
1	1 significant place	No decimal place
0.1	2 significant places	1 decimal place
0.01	3 significant places	2 decimal places
0.001	4 significant places	3 decimal places



**Note:** Automatic filter ranging must be switched on (*SENSe[1..4]:AVERage:COUNT:AUTO ON*). *DISP[1..8]:RES* has an effect on the setting *SENSe[1..4]:AVER:COUNT:AUTO:RES* of the sensors used in the measurement function (*CALC[1..8]:MATH*). However, the resolution setting of the sensors does not affect the resolution of values in the display.

This command corresponds to the <resol uti on> option of the high-level measurement commands *CONFi gure*, *FETCH*, *READ* and *MEASure*.

**\*RST value:** 0.01

#### Error messages:

-127 "Invalid numeric data": An invalid number was specified for the resolution.

#### Example:

*DISP:WIND1:RES 0.1*

With a measured value of 123.456789 W, the first two places are free of noise and thus 120 W is displayed.

**DISPlay[:WINDow][1..4][:STATe][?] ON | OFF**

Opens or closes a window. When a window is closed the other windows are automatically expanded so that the free space is utilized. Likewise, open windows become smaller when a new one is opened.

**\*RST value:** ON (Window 1)  
OFF (Window 2,3,4)

**DISPlay[:WINDow][1..4]:TRACe:LOWer[?] <float\_value>**

Sets the lower limit for the power axis in the Scope mode. The value range depends on the unit.

Unit of measured value	W	DBM	DBUV
Value range	-999.999E3 .. 999.999E3	-120 .. 90	-13.010 .. 136.990

**Default unit:** DBM

**Unit:** DBM | W | DBUV

**Value range:** see above

**\*RST value:** -120 DBM

**DISPlay[:WINDow][1..4]:TRACe:UPPer[?] <float\_value>**

Sets the upper limit for the power axis in the Scope mode. The value range depends on the unit.

Unit of measured value	W	DBM	DBUV
Value range	-999.999E3 .. 999.999E3	-120 .. 90	-13.010 .. 136.990

**Default unit:** DBM

**Unit:** DBM | W | DBUV

**Value range:** see above

**\*RST value:** 30 DBM

**DISPlay[:WINDow][1..4]:TSlot[?] <int\_value>**

Sets the displayed timeslot, if the primary or secondary channel is operated in the Timeslot mode.

**Value range:** depends on sensor

**\*RST value:** 1

**DISPlay:WINDow:SElect[?] 1 | 2 | 3 | 4**

Selects a window.

**\*RST value:** 1

**DISPlay:WINDow:SIZE[?] NORMal | ZOOMed**

Sets the window size.

**NORMal**      The window size is determined automatically and depends on the total number of open windows.

**ZOOMed**      The selected window (**DISP:WIND:SEL[?]**) is set to maximum size, regardless of the the number of visible windows. Any other open windows are covered.

**\*RST value:** NORMal

## FORMat

The FORMat command system sets the format of numeric data (measured values) that is exchanged between the remote control computer and the R&S NRP if high-level measurement commands are used.

Table 6-6: Commands of the FORMat command system

Command	Parameter	Unit	Remark
FORMat[:READings]			
:BORDER[?]	NORMal   SWAPped	-	
[:DATA][?]	ASCii   REAL	-	

### FORMat[:READings]:BORDER[?] NORMal | SWAPped

Influences the order of bytes in 64-bit binary data.

**NORMal** The 1st byte is the MSB (most significant byte), the 8th byte the LSB (least significant byte).  
This fulfills the Big Endian convention (Big Endian: "the big end comes first").

**SWAPped** The 1st byte is the LSB (least significant byte), the 8th byte the MSB (most significant byte).  
This fulfills the Little Endian convention.

**\*RST value:** NORMal

### FORMat[:READings][:DATA][?] ASCii | REAL

Specifies whether numeric data is sent as block data in binary form (REAL) or as character strings in plain text (ASCII).

**\*RST value:** ASCii

## MEMory

The MEMory system is used for storing device states (:STATE) and correction tables (:TABLE).

- :STATE** To allow a rapid and convenient changeover between device setups for different applications, up to 20 setups can be stored in the device. The setup with the number 0 is the default setup made in the factory. This setup can neither be changed nor cleared.
- :TABLE** Tables can be stored for a frequency-dependent correction of measured values. Up to 10 tables with two columns and up to 80 entries (lines) can be created. Thus, not only the sensors but also the frequency response of various test assemblies can be compensated for during the measurement.  
 The tables are selected with [SENSe[1..4]]:CORRection:FDOt[:SElect] and then activated and deactivated with [SENSe[1..4]]:CORRection:FDOt[:STATE].  
 Names can be assigned to the tables. Some commands which do not specify a table name affect the table currently selected with MEM:TABLE:SEL <name>.



**Note:** Stored data is not affected by an \*RST command.

Table 6-7: Commands of the MEMory system

Command	Parameter	Unit	Remark
MEMory			
:CATalog			
[:ALL]?	-	-	Query only
:STATE?	-	-	Query only
:TABLE?	-	-	Query only
:CLEar			
[:NAME]	<name>	-	No query
:TABLE	-	-	No query
:FREE			
[:ALL]?	-	-	Query only
:STATE?	-	-	Query only
:TABLE?	-	-	Query only
:NSTates?	-	-	Query only
:STATE			
:CATalog?	-	-	Query only
:DEFine :MAP[?]	<string>, 0..19	-	
:TABLE			
:FREQuency[?]	<Nrf>{ , <Nrf>}	HZ	
:POINts?	-	-	Query only
:GAIN			
[:MAGNitude][?]	<Nrf>{ , <Nrf>}	DB PCT	
:POINts?	-	-	Query only
:MAP[?]	<string>, 0..9	-	
:MOVE	<string>, <string>	-	No query
:SElect[?]	<string>	-	

**MEMory:CATalog[:ALL]?**

Lists the names of all stored device states and correction tables. The length of the response depends on how many device states and tables are stored. It has the following format:

```
<NR1>, <NR1> {,"<string>"}
```

The first two values denote the length in bytes of the occupied RAM and of the RAM still available for storing states and tables. These values are followed by a string for each stored state and then for each stored table; this string again consists of two strings and a numeric value:

```
<string>, <type>, <NR1>
```

<string> gives the name of the stored data item, <type> the type (TABL or STAT) and <NR1> the length of the data item in bytes.

**Example:**

The response to query MEM:CAT? could be:

```
956,99044,"REFL,STAT,408","NRPZ21,TABL,432","SPLITTER1,TABL,116"
```

**MEMory:CATalog:STATE?**

This query only gives a list of stored device states and is otherwise identical with MEMory:CATalog[:ALL]?

**MEMory:CATalog:TABLE?**

This query only gives a list of stored correction tables and is otherwise identical with MEMory:CATalog[:ALL]?

**MEMory:CLEar[:NAME] <string>**

Clears the content of the correction table or the stored device state with the designation <name>. The table is maintained but does not contain entries.



**Caution:** *This command cannot be cancelled. Cleared values are irretrievably lost.*

**MEMory:CLEar:TABLE**

This command may be used as an alternative to MEMory:CLEar[:NAME] <string>. The content of the table currently selected with MEMory:TABLE:SElect[?] <string> is cleared.

**MEMory:FREE[:ALL]?**

Returns the number of bytes available in memory for storing correction tables and device states as well as the memory already used.

**MEMory:FREE:STATE?**

Returns the number of bytes available in memory for storing device states as well as the memory already used for device states.

**MEMory:FREE:TABLE?**

Returns the number of bytes available in memory for storing device states as well as the memory already used for device states.

**MEMory:NStates?**

Returns the number of storable device states. Since 20 device states can be stored, 20 is always returned.

**MEMory:STATE:CATalog?**

Returns a list of names of stored device states in the format

```
<string>{,<string>}
```

**MEMory:STATE:DEFine|:MAP <string>, 1..19**  
**MEMory:STATE:DEFine|:MAP? <string>**

The value 0 to 19 are assigned to the memory locations of the device states, where the memory location with the number 0 is the factory-set state and cannot be changed. Names (<string>) can be assigned to these numbers with MEM:STAT:DEF (except for the factory-set state). The command MEM:CLE[:NAME] expects parameters that are actually strings rather than the numbers of the memory locations. The default names of these memory locations are "Setup 0" to "Setup 19". The name may contain the characters A to Z, a to z, 0 to 9 and "\_".

The query of this command returns the number of the memory location with the name of <string>.

**MEMory:TABLE:FREQuency[?] <Nrf>{,<Nrf>}**

This command enters frequencies in the first column of the table selected with MEM:TABLE:SEL. Existing data for frequencies will be overwritten. The number of frequencies should match the number of offset values. If the number of frequencies differs from the number of offset values, the shorter column length will be used.

SENS[1..4]:FREQ can be used to determine a frequency for which a correction factor is then defined by means of the offset table. If the exact frequency selected is not in the table, the values in the table are interpolated. If the selected frequency is outside the specified frequency range, the first or last offset value of the table is selected. Interpolation is linear in the units HZ and DB.

**Unit:** HZ

**\*RST values:** Tables are not changed in case of a \*RST.



**MEMory:TABLE:FREQuency:POINTs?**

Returns the number of entries (lines) in the table selected with MEM:TABLE:SEL <name>.

**MEMory:TABLE:GAIN[:MAGNitude][?] <NRf>{,<NRf>}**

This command enters offset values in the second column of the table selected with MEM:TABLE:SEL. Existing data for offset values will be overwritten. The number of frequencies should match with the number of offset values. If the number of frequencies differs from the number of offset values, the shorter column length will be used.

A frequency can be determined with SENS[1..4]:FREQ, for which a correction factor is then calculated by means of the offset table. If the exact frequency selected is not in the table, the values in the table are interpolated. If the selected frequency is outside the specified frequency range, the first or last offset value of the table is selected. Interpolation is linear in the units HZ and DB.

**Unit:** DB | PCT

**Default unit:** DB

**\*RST values:** Tables are not changed in case of \*RST.

**MEMory:TABLE:GAIN:POINTs?**

Returns the number of entries (lines) in the table selected with MEM:TABLE:SEL <string>.

**MEMory:TABLE:MAP <string>, 1..9****MEMory:TABLE:MAP? <string>**

The numbers 0 to 9 are permanently assigned to the memory locations for device states. Names (<string>) can be assigned to the numbers with MEM:TABLE:MAP. The MEM:CLEAR[:NAME], MEM:TABLE:MOVE and MEM:TABLE:SEL commands expect these names as parameters, not the numbers of the memory locations. By default the tables are assigned the names "Table 1" to "Table 10". The name can contain the characters "A" to "Z", "a" to "z", "0" to "9" and "\_".

The query form of this command returns the number of the memory location with the name <string>.

**MEMory:TABLE:MOVE <string>,<string>**

This command allows tables to be renamed. The first parameter specifies the old name, the second the new name. No data is copied, i.e. only the name of the table changes.

**Example:**

The command MEM:TABLE:MOVE "Table 1","Test setup" renames the table "Table 1" into "Test setup".

**MEMory:TABLE:SElect[?] <string>**

Selects the table name < string>. The following commands affect this table:

- MEMory:CLEar[:NAME] <string>
- MEMory:CLEar:TABLE
- all MEMory:TABLE commands

The selection is not changed in case of an \*RST or a SYSTem:PRESet.

\*RST value: none

**Error messages:**

-256 **"File name not found"**: A table named <stri ng> is not known.

## OUTPut

The OUTPut system serves for generator configuration. The R&S NRP can be equipped with an optional RF test generator which produces a reference power of 1 mW at 50 MHz. Moreover, the analog outputs at the rear of the power meter can be configured.

Table 6-8: Commands of the OUTPut system

Command	Parameter	Unit	Remark
OUTPut			
:RECOOrder[1 2]			
:FEED[?]	<string>	-	
:LIMit			
:LOWer[?]	<float_value>	-	The value range of the parameter depends on the output unit of the measured value.
:POWer[?]	<float_value>	DBM  W DBUV	
:RATio[?]	<float_value>	DB  DPCT O	
:UPPer[?]	<float_value>	-	The value range of the parameter depends on the output unit of the measured value.
:POWer[?]	<float_value>	DBM  W DBUV	
:RATio[?]	<float_value>	DB  DPCT O	
:STATe[?]	ON OFF	-	
:ROSCillator			
[:STATe][?]	ON OFF	-	Option R&S NRP-B1
:CALibration			
:READ?	<NR1>	-	Option R&S NRP-B1
:WRITe	<NR1>, <NR1>	-	Option R&S NRP-B1
:TTL[1]			
:ACTive[?]	LOW HIGH	-	
:FAIL[?]	HIGH LOW	-	
:FEED[?]	<string>	-	
:HVOLTage	<float_value>	V	
:LVOLTage	<float_value>	V	
:STATe[?]	ON OFF	-	

### OUTPut:RECOOrder[1..2]:FEED[?] <string>

Assigns a calculate block to one of the two analog outputs. On the basis of the set characteristic, the measured value is converted to a DC voltage that can be tapped at the appropriate output.

**Value range:** "CALC1", "CALC2", "CALC3", "CALC4"

**\*RST value:** output 1: "CALC1"  
output 2: "CALC2"

OUTPut:REcOrder[1..2]:LIMit:LOWer[?] <float\_value>

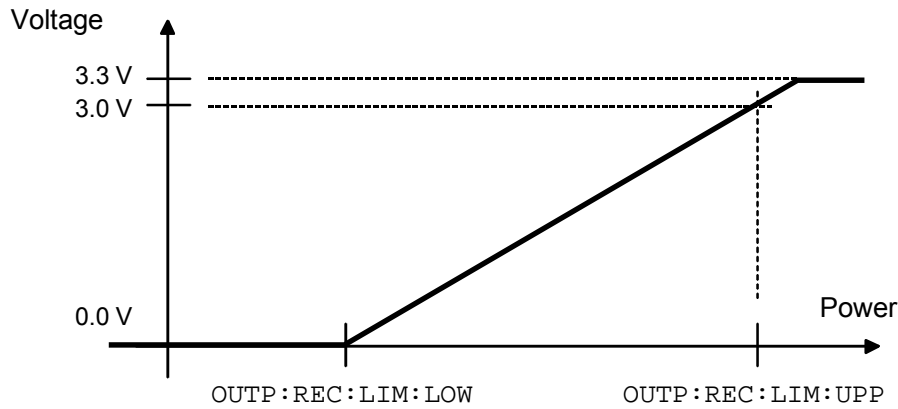

Figure 6-5: Characteristic of analog outputs

Specifies the lower power limit of the characteristic for one of the two analog outputs (→[Figure 6-5](#)). The unit corresponds to the output unit of the measured value.

The value range also depends on which output unit the measured value in the window currently has:

Unit of measured value	W	DBM	DBUV	DPCT	DB	O
Value range	-9.99999E5 .. 9.99999E5	-120 .. 90	-13.0103 .. 196.897	-100 .. 999.99	-200 .. 200	-1E20 .. 1E20

Unit: → [Table 6-3](#) on page [6.27](#).

\*RST value: -20 DBM or 0 DB



**Note:** The characteristic is linear in the selected unit of the measured value.

OUTPut:REcOrder[1..2]:LIMit:LOWer:POWer[?] <float\_value>

Specifies the lower power limit of the characteristic for one of the two analog outputs if the associated calculate block returns a power (unit DBM, W or DBUV) as measured value (→[Figure 6-5](#)).

Value range: -120 DBM to 90 DBM

Unit: DBM | W | DBUV

Default unit: DBM

\*RST value: -20 DBM

**OUTPut:RECOOrder[1..2]:LIMit:LOWer:RATio[?]** <float\_value>

Specifies the lower power limit of the characteristic for one of the two analog outputs if the associated calculate block returns a power ratio (unit DB, DPCT or O) as the measured value (→[Figure 6-5](#)).

**Value range:** -200 DB .. 200 DB

**Unit:** DB | DPCT | O

**Default unit:** DB

**\*RST value:** 0 DB

**OUTPut:RECOOrder[1..2]:LIMit:UPPer[?]** <float\_value>

Specifies the upper power limit of the characteristic for one of the two analog outputs (→[Figure 6-5](#)). The unit corresponds to the output unit of the measured value.

The value range also depends on the current output unit of the measured value in the window:

Unit of measured value	W	DBM	DBUV	DPCT	DB	O
Value range	-9.99999E5 .. 9.99999E5	-120 .. 90	-13.0103 .. 196.897	-100 .. 999.99	-200 .. 200	-1E20 .. 1E20

**Unit:** → [Table 6-3](#) on page [6.27](#).

**\*RST value:** 20 DBM or 10 DB

**OUTPut:RECOOrder[1..2]:LIMit:UPPer:POWER[?]** <float\_value>

Specifies the upper power limit of the characteristic for one of the two analog outputs if the associated calculate block returns a power (unit DBM, W or DBUV) as the measured value (→[Figure 6-5](#)).

**Value range:** -120 DBM to 90 DBM

**Unit:** DBM | W | DBUV

**Default unit:** DBM

**\*RST value:** 20 DBM

**OUTPut:RECOOrder[1..2]:LIMit:UPPer:RATio[?]** <float\_value>

Specifies the upper power limit of the characteristic for one of the two analog outputs if the associated calculate block returns a power ratio (unit DB, DPCT or O) as the measured value (→[Figure 6-5](#)).

**Value range:** -200 DB .. 200 DB

**Unit:** DB | DPCT | O

**Default unit:** DB

**\*RST value:** 10 DB

**OUTPut:REcOrder[1..2]:STATe[?] ON | OFF**

Switches the analog outputs (OUT1 and OUT2/TRIG on rear panel) ON or OFF. The magnitude of the output voltage (0 V to 3.3 V) depends on the measured power of the assigned calculate block (OUTP:REC:FEED) and the configuration of the characteristic (OUTP:REC:LIM). As in manual operation, this setting is coupled to other operating modes of the outputs. Only one mode can be active at any one time:

Connector	Analog output (OUTP:REC)	TTL output (OUTP:TTL)	Off	Ext. Trigger In
OUT1	x	x	x	-
OUT2/TRIG	x	-	-	x

\*RST value: output 1: ON  
output 2: OFF

**OUTPut:ROSCillator[:STATe][?] ON | OFF**

The command switches the optional RF generator (ON) or (OFF).

\*RST value: OFF

**OUTPut:ROSCillator:CALibration:READ? <NR1>**

Reads the setting of one of the internal electronic potentiometers of the test generator (option R&S NRP-B1). The number of the potentiometer (1 to 4) is indicated with the parameter <NR1>. The response is an 8-bit integer with a sign (-128 to 127).

\*RST value: none

**OUTPut:ROSCillator:CALibration:WRite <NR1>,<NR1>**

Sets the test generator (option R&S NRP-B1). Refer to the following table for the meaning of the two parameters:

1st parameter <NR1>	01: Generator on/off (2nd parameter 0: on / 1: off) 02: Power stage (2nd parameter 0: -20 dBm, 1: 0 dBm) 03: LED state (2nd parameter 0: off, 1: on, 0x02: blinking) 04: Start of calibration 05: Setting of potentiometer 1 (2nd parameter -128 to 127) 06: Setting of potentiometer 2 (2nd parameter -128 to 127) 07: Setting of potentiometer 3 (2nd parameter -128 to 127) 08: Setting of potentiometer 4 (2nd parameter -128 to 127) 09: Confirm calibration 10: Abort calibration
2nd parameter <NR1>	Data if 1st parameter 01, 02, 03, 05, 06, 07 or 08. 0 if 1st parameter 04, 09 or 10.

\*RST value: none

**OUTPut:TTL[1]:ACTive[?] LOW | HIGH**

Specifies whether the value set via `OUTP:TTL:LVOL` (LOW) or via `OUTP:TTL:HVOL` (HIGH) should be applied if the measured value causes a limit violation at the TTL output.

**\*RST value:** LOW

**OUTPut:TTL[1]:FAIL[?] LOW | HIGH**

Specifies whether the value set via `OUTP:TTL:LVOL` (HIGH) or via `OUTP:TTL:HVOL` (LOW) should be applied if the measured value causes a limit violation at the TTL output.

**\*RST value:** HIGH



**Note:** *The `OUTP:TTL:ACT` and `OUTP:TTL:FAIL` commands are identical, except for the opposite meaning of the parameters.*

**OUTPut:TTL[1]:FEED[?] <string>**

Sets the calculate block whose limit handling controls the TTL voltage. If the measured value of this calculate block violates a limit and limit monitoring is active, the voltage specified in → [Table 6-9](#) (first line) is output.

**Value range:** "CALC1:LIM", "CALC2:LIM", "CALC3:LIM", "CALC4:LIM"

**\*RST value:** "CALC1:LIM"

**OUTPut:TTL[1]:HVOLtage[?] <float\_value>**

Sets the high voltage for the TTL output.

**Unit:** V

**Value range:** 0 V to 3.3 V

**\*RST value:** 3.3 V

**OUTPut:TTL[1]:LVOLtage[?] <float\_value>**

Sets the low voltage for the TTL output.

**Unit:** V

**Value range:** 0 V to 3.3 V

**\*RST value:** 0 V



**Note:** *The value for the lower TTL level may be greater than the value for the upper TTL level.*

**OUTPut:TTL[1]:STATE[?] ON | OFF**

Activates (ON) or deactivates (OFF) the TTL operating mode of the OUT1 connector (rear panel). The magnitude of the two possible output voltages can range from 0 V to 3.3 V (OUTP:TTL:HVOL and OUTP:TTL:LVOL). Refer to →Table 6-9 and → Figure 6-6 to determine which voltage is available at the output:

	OUTP:TTL:ACT LOW (OUTP:TTL:FAIL HIGH)	OUTP:TTL:ACT HIGH (OUTP:TTL:FAIL LOW)
<b>Measured value violates limit</b>	OUTP:TTL:LVOL	OUTP:TTL:HVOL
<b>Measured value is within limit</b>	OUTP:TTL:HVOL	OUTP:TTL:LVOL

Table 6-9: Voltage at TTL output

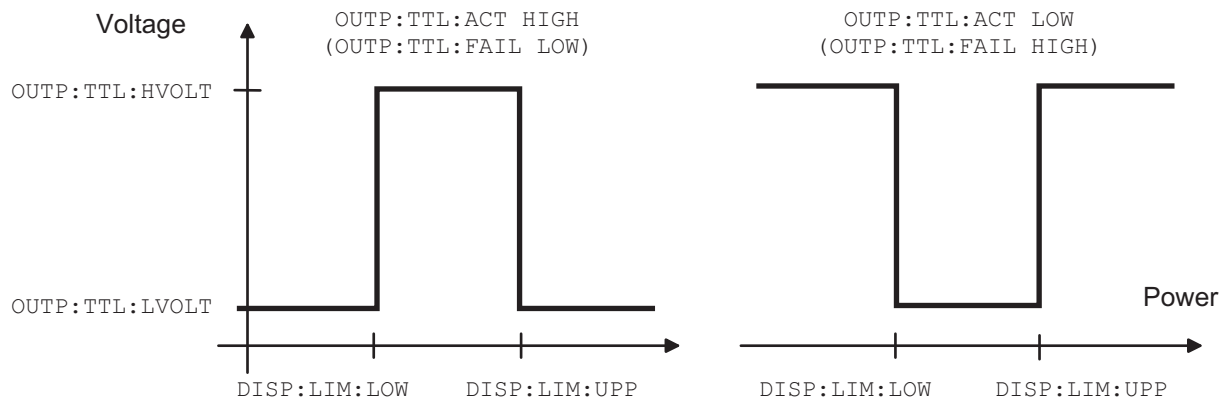

Figure 6-6: Voltage at TTL output

**\*RST value:** OFF



### SENSE (Sensor Commands)

The commands of the SENSE group configure the power sensors with the exception of the trigger system. This includes the measurement modes (ContAv, Burst, Timeslot or Scope), the offset corrections and the filter settings.



**Note:** When the sensors are connected to the R&S NRP, they inform the device about the SENSE and TRIGGER commands supported and about the value ranges for parameters. This applies to both numeric and text parameters. For this reason, no fixed ranges are specified with these commands; the ranges can be obtained from the respective sensor manual.

Table 6-10: Commands of the SENSE system

Command	Parameter	Unit	Remark
[SENSE[1..4]]			
:AVERAGE			
[:STATE][?]	ON OFF	-	
:COUNT[?]	<int_value>	-	
:AUTO[?]	ON OFF ONCE	-	
:MTIME[?]	<float_value>	S	
:RESOLUTION[?]	1 2 3 4	-	
:SLOT	<int_value>	-	
:NSRATIO[?]	<float_value>	DB PCT	
:TYPE[?]	RESOLUTION NSR	-	
:RESET	-	-	no query
[:STATE][?]	ON OFF	-	
:TCONTROL[?]	MOVING REPEAT	-	
:CORRECTION			
:OFFSET[?]	<float_value>	DB PCT	
:STATE[?]	ON OFF	-	
:DCYCLE			
[:INPUT][:MAGNITUDE][?]	<float_value>	PCT	
:STATE[?]	ON OFF	-	
:FDOFFSET			
[:INPUT][:MAGNITUDE]?	-	DB	
:FDOTABLE			
[:SELECT][?]	<string>	-	
:STATE[?]	ON OFF	-	
:SPDEVICE:STATE[?]	ON OFF	-	
:FREQUENCY[:CW :FIXED][?]	<float_value>	HZ	
:FUNCTION[:ON][?]	<string>	-	
[:POWER]			
[:AVG]			
:APERTURE[?]	<float_value>	S	
:BUFFER:SIZE[?]	<int_value>	-	
:BUFFER:STATE[?]	ON OFF	-	
:RANGE[?]	0 1 2	-	
:AUTO[?]	ON OFF	-	
:AUTO:CLEVEL[?]	<float_value>	DB PCT	
:SMOOTHING:STATE[?]	ON OFF	-	
:TGATE[1..4]			
:OFFSET:TIME[?]	<float_value>	S	
:TIME[?]	<float_value>	S	
:TGATE:SELECT[?]	1 2 3 4		
:TSLot			
:COUNT[?]	<int_value>	-	
:WIDTH[?]	<float_value>	S	

Command	Parameter	Unit	Remark
:BURSt			
:DTOLerance[?]	<float_value>	S	
:SAMPLing[?]	FREQ1 FREQ2	-	
:SGAMma			
[:MAGNitude][?]	<float_value>	-	
:PHASe[?]	<float_value>	-	
:CORRection:STATe[?]	ON OFF	-	
:TRACe			
:AVERAge			
[:STATe][?]	ON OFF	-	
:COUNT[?]	<int_value>	-	
:AUTO[?]	ON OFF ONCE	-	
:MTIME[?]	<float_value>	S	
:RESolution[?]	1 2 3 4	-	
:POINT[?]	<int_value>	-	
:NSRatio[?]	<float_value>	DB PCT	
:TYPE[?]	RESolution NSR	-	
:TCONTRol[?]	MOVing REPeat	-	
:OFFSet:TIME[?]	<float_value>	S	
:POINTs[?]	<int_value>	-	
:REALtime[?]	ON OFF	-	
:TIME[?]	<float_value>	S	
:TIMing:EXCLude			
:START[?]	<float_value>	S	
:STOP[?]	<float_value>	S	

### [SENSe[1..4]]:AVERAge[:STATe][?] ON | OFF

This command switches the filter function of a sensor on or off. When the filter is switched on, the number of measured values set with [SENSe[1..4]]:AVERAge:COUNT is averaged. This reduces the effect of noise so that more reliable results are obtained.

\*RST value: depending on sensor

### [SENSe[1..4]]:AVERAge:COUNT[?] <int\_value>

This command sets the filter length i.e. the number of readings to be averaged for one measured value.. The higher the count the lower the noise and the longer it takes to obtain a measured value.

Unit: -

Value range: depending on sensor

\*RST value: depending on sensor

### [SENSe[1..4]]:AVERAge:COUNT[?]:AUTO[?] ON | OFF | ONCE

This command can be used to automatically determine a value for the filter length [SENSe[1..4]]:AVERAge:COUNT. If the command is called with the parameter ONCE, the filter length is automatically detected during the next measurement and set to that value. Thereafter automatic filter length detection is switched off. The setting can then be queried via SENS[1..4]:AVER:COUNT?. If the automatic switchover is activated with the ON parameter, the sensor always defines a suitable filter length which can also be queried via SENS[1..4]:AVER:COUNT?.

\*RST value: depending on sensor

**[SENSe[1..4]]:AVERage:COUNT:AUTO:MTIME[?] <float\_value>**

If the R&S NRP has to determine the filter length automatically, the filter length can become large and thus also the measurement time.

An upper time limit can be set via `SENS[1..4]:AVER:COUN:AUTO:MTIME` (maximum time). It should never be exceeded. Undesired long measurement times can thus be prevented (in the `SENS:AVER:COUN:AUTO:TYPE NSR` mode) if the automatic filter length switchover is on.

**Unit:** s

**Value range:** depending on sensor

**\*RST value:** depending on sensor

**[SENSe[1..4]]:AVERage:COUNT:AUTO:RESolution[?] 1 | 2 | 3 | 4**

Defines the number of significant places for linear units and the number of decimal places for logarithmic units which should be free of noise in the measurement result. This setting is also performed by the `DISP[1..4]:RES` command (→ page 6.35) that tries to set the sensors involved in the measurement results accordingly. (For further details, see Chapter 4.)

The setting is only taken into account, if `SENS:AVER:COUN:AUTO:TYPE` is set to `RES` and `SENS:AVER:COUN:AUTO` is `ON`.

However, `SENS[1..4]:AVER:COUN:AUTO:RES` does not affect the `DISPlay` command. The parameters of the two commands are different but have the same meaning.

<code>SENS[1..4]:AVER:COUN:AUTO:RES</code>	1	2	3	4
<code>DISP[1..4]:RES</code>	1	0.1	0.01	0.001

**Unit:** -

**Value range:** depending on sensor

**\*RST value:** depending on sensor

**[SENSe[1..4]]:AVERage:COUNT:AUTO:SLOT[?] <int\_value>**

Sets a timeslot whose measured value is used to automatically determine the filter length.

**Unit:** -

**Value range:** depending on sensor

**\*RST value:** depending on sensor

**[SENSe[1..4]]:AVERage:COUNT:AUTO:NSRatio[?] <float\_value>**

Indicates the maximum noise ratio in the measurement result. Achieving the same result by filter length setting is attempted only if

SENS[1..4]:AVER:COUN:AUTO ON and SENS[1..4]:AVER:COUN:AUTO:TYPE NSR are set.

**Unit:** DB | PCT

**Default unit:** DB

**Value range:** depending on sensor

**\*RST value:** depending on sensor

**[SENSe[1..4]]:AVERage:COUNT:AUTO:TYPE[?] RESolution | NSR**

Selects a method by which the automatic filter length switchover can operate:

SENS[1..4]:AVER:COUN:AUTO:TYPE	Setting taken into account
RESolution	SENS[1..4]:AVER:COUN:AUTO:RES
NSR	SENS[1..4]:AVER:COUN:AUTO:NSR

**\*RST value:** depending on sensor

**[SENSe[1..4]]:AVERage:RESet**

Initializes the digital filter by deleting the stored measured values.

**\*RST value:** none

**[SENSe[1..4]]:AVERage:TCONtrol[?] MOVing | REPeat**

As soon as a new single value is determined, the filter window is advanced by one value so that the new value is taken into account by the filter and the oldest value is forgotten.

[SENSe[1..4]]:AVERage:TCONtrol (terminal control) then determines whether a new result is calculated immediately after a new measured value is available (MOVing) or only after an entire range of new values is available for the filter (REPeat).

**\*RST-Wert:** **PRES** and SYST:PRES: MOV

\*RST: REP



**Note:** In the MOVing mode, data from a point of time before the start of the current measurement can influence the measurement result if the data is still in the filter.

**[SENSE[1..4]]:CORREction:OFFSet[?] <float\_value>**

With this command a fixed offset value can be defined for multiplying (logarithmically adding) the measured value of a sensor. If the parameters are specified without a unit, the unit set by UNIT:POW:RAT will be used.

**Unit:** DB | PCT

**Default unit:** DB

**Value range:** depending on sensor

**\*RST value:** depending on sensor

**[SENSE[1..4]]:CORREction:OFFSet[?]:STATE ON | OFF**

This command switches the offset correction on or off.

**\*RST value:** depending on sensor

**[SENSE[1..4]]:CORREction:DCYCLE[:INPut][:MAGNitude][?] <float\_value>**

This command informs the R&S NRP about the duty cycle of the power to be measured. The duty cycle correction is only applied in the ContAv mode where measurements are performed continuously without taking the timing of the signal into account.

**Unit:** PCT

**Value range:** depending on sensor

**\*RST value:** depending on sensor

**[SENSE[1..4]]:CORREction:DCYCLE:STATE[?] ON | OFF**

This command switches duty cycle correction for the measured-value on or off.

**\*RST value:** depending on sensor

**[SENSE[1..4]]:CORREction:FDOFFset[:INPut][:MAGNitude]? <float\_value>**

This command is a query only. The frequency-dependent measured-value correction is set by selecting a table with the [SENSE[1..4]]:CORREction:FDOTable[:SElect] and [SENSE[1..4]]:CORREction:FDOTable:STATE ON commands. The respective frequency-dependent correction factor is determined by means of the active tables (if necessary by interpolation) and can be queried with [SENSE[1..4]]:CORREction:FDOFFset[:INPut][:MAGNitude]? (frequency-dependent offset).

**Unit:** DB

**\*RST value:** none

**[SENSE[1..4]]:CORREction:FDOtable[:SElect][?] <string>**

The name of the current frequency-dependent offset table can be set or queried by the [SENSE[1..4]]:CORREction:FDOtable[:SElect][?] command. The R&S NRP can manage up to ten such tables (MEMory commands). The frequency-dependent offset tables consist of two columns; the first containing the frequencies, the second the associated correction values. When the R&S NRP is informed about the signal frequency with command [SENSE[1..4]]:FREQuency[:CW|:FIXed] <float\_value>, an appropriate correction factor is determined by means of the table. If the table was activated with [SENSE[1..4]]:CORREction:FDOtable:STATe[?] ON, the measurement result obtained by the sensor is multiplied by this factor.

**\*RST value:** Settings are not changed in case of \*RST.

**Error messages:**

-256 "File name not found": A table named <name> is not known.

**[SENSE[1..4]]:CORREction:FDOtable:STATe[?] ON | OFF**

This command activates and deactivates the current frequency-dependent offset table. The current table is selected with the [SENSE[1..4]]:CORREction:FDOtable[:SElect] command. Only one table can be active at a time.

**\*RST value:** OFF

**[SENSE[1..4]]:CORREction:SPDevice:STATe[?] ON | OFF**

Instructs the sensor to perform a measured-value correction by means of the stored s-parameter device.

**\*RST value:** depending on sensor

**[SENSE[1..4]]:FREQuency[:CW|:FIXed][?] <float\_value>**

This command informs the R&S NRP about the frequency of the power to be measured since this frequency is not automatically determined. The frequency is used to determine a frequency-dependent correction factor for the measurement results.

**Unit:** HZ

**Value range:** depending on sensor

**\*RST value:** depending on sensor

[SENSE[1..4]]:FUNCTION[:ON][?] <string>

This command sets the sensor to one of the measurement modes of Table 6-11.

Table 6-11: Measurement modes

<string>	Measurement mode
"POWer:AVG"	<b>ContAv</b> After a trigger event, the power is integrated over a time interval (averaging) set with SENS:POW:APER.
"POWer:TSLot:AVG"	<b>Timeslot</b> The power is simultaneously measured in up to 26 time windows. The number of time windows is set with SENS:POW:TSL:COUN. The length of a time window is determined via SENS:POW:TSL:WIDT. The measurement result is represented by a vector that can contain up to 26 indices and contains the power of a time window at each index.
"POWer:TGATe:AVG"	<b>Timegate</b> The Timegate mode is a pseudo-mode. It is used to determine accurate measured values in the gates defined with the aid of the Scope mode in manual operation. If one of the four gates is selected (SENS:TRAC:SEL), the sensor is internally put into the Timeslot mode and configured such that it determines the average power in this gate with high accuracy.
"POWer:BURSt:AVG"	<b>Burst</b> In remote control, this measurement mode is very similar to the ContAv mode. The integration time is, however, not predefined but determined by the sensor with the aid of a burst detector. The start of a burst is detected when the measurement signal rises above the set trigger level. The end is set when the signal drops below the trigger threshold. SENS:POW:BURSt:DTOL defines the time interval during which a signal drop below the trigger level is not interpreted as the end of the burst. In the Burst mode, the set trigger source is ignored and TRIG:SOUR INT is implicitly assumed.
"XTIME:POWer"	<b>Scope</b> A sequence of measurements is performed. The individual measured values are determined as in the ContAv mode. The length of an individual measurement is determined from the ratio of the total time (SENS:TRAC:TIME) and the number of individual test points (SENS:TRAC:POIN).

In remote control, the timing (SENS:TIM:EXCL:STAR and -:STOP) and the trigger system of all measurement modes (except the Burst mode) are user-selectable.



**Note:** *To increase measurement accuracy, the sensors measure each signal twice in the Burst, Timeslot and Scope measurement modes (exception: in the Scope mode, with SENS:TRAC:REAL ON). As long as the trigger system is set to internal or external triggering, this is usually of no importance to the user. If TRIG:SOUR HOLD or BUS is used, however, then each measurement must be triggered twice (with \*TRG or TRIG:IMM).*

\*RST value: depending on sensor

**Error messages:**

- 24 "Sensor mode not supported": A sensor does not support a measurement mode.
- 28 "Sensor not idle": The sensor is not in the IDLE state.
- 151 "Invalid string data": An invalid parameter was transmitted for <string>.

**[SENSE[1..4]][:POWER][:AVG]:APERTure[?] <float\_value>**

This command determines the integration time for a single measurement in the ContAv mode. To increase the measurement accuracy, this integration is followed by a second averaging procedure in a window with a selectable number of values. The filter window is configured with the [SENSE[1..4]]:AVERage commands.

**Unit:** s

**Value range:** depending on sensor

**\*RST value:** depending on sensor

**[SENSE[1..4]][:POWER][:AVG]:BUFFEr:SIZE[?] <int\_value>**

Sets the number of desired values for the buffered ContAv mode.

**Unit:** -

**Value range:** 1..400000

**\*RST value:** depending on sensor

**[SENSE[1..4]][:POWER][:AVG]:BUFFEr:STATE[?] ON | OFF**

Switches on the buffered ContAv mode, after which data blocks rather than single measured values are then returned. In this mode a higher data rate is achieved than in the non-buffered ContAv mode.

The number of desired measured values is set with the SENSE[1..4]:POWER:ARR:SIZE command.

**\*RST value:** depending on sensor

**[SENSE[1..4]][:POWER][:AVG]:RANGe[?] 0 | 1 | 2**

Selects a measurement range in which the corresponding sensor is to perform a measurement. This setting will only become effective if SENS[1..4]:RANG:AUTO ON is set.

**\*RST value:** depending on sensor

**[SENSE[1..4]][:POWER][:AVG]:RANGe:AUTO[?] ON | OFF**

Sets the automatic selection of a measurement range to ON or OFF.

**\*RST value:** depending on sensor

**[SENSE[1..4]][:POWER][:AVG]:RANGe:AUTO:CLevel[?] <float\_value>**

Sets the cross-over level. Shifts the transition ranges between the measurement ranges. This may improve the measurement accuracy for special signals, i.e. signals with a high crest factor.

**Unit:** DB | PCT

**Default unit:** DB

**Value range:** depending on sensor

**\*RST value:** depending on sensor



**[SENSe[1..4]][:POWer][:AVG]:SMOothing:STATe[?] ON | OFF**

Activates digital lowpass filtering of the sampled video signal.

The problem of instable display values due to a modulation of a test signal described under `SENS[1..4]:SAMP` can also be eliminated by lowpass filtering of the video signal. The lowpass filter eliminates the variations of the display even in case of unperiodic modulation and does not require any other setting.

If the modulation is periodic, the setting of the sampling window is the better method since it allows for shorter measurement times.

**\*RST value:** depending on sensor

**[SENSe[1..4]][:POWer]:BURSt:DTOLerance[?] <float\_value>**

The end of a burst (power pulse) is recognized when the signal level drops below the trigger level. Especially with modulated signals, this may also happen for a short time within a burst. To prevent the supposed end of the burst from being recognized too early or incorrectly at these positions, a time interval can be defined via `SENS[1..4]:BURSt:DTOL` (drop-out tolerance) in which the pulse end is only recognized if the signal level no longer exceeds the trigger level. This is shown in [Fig. 6-7](#): the drop-out time, i.e. the time in which the signal remains below the trigger level, is shorter than the drop-out tolerance. The burst end is thus recognized correctly.

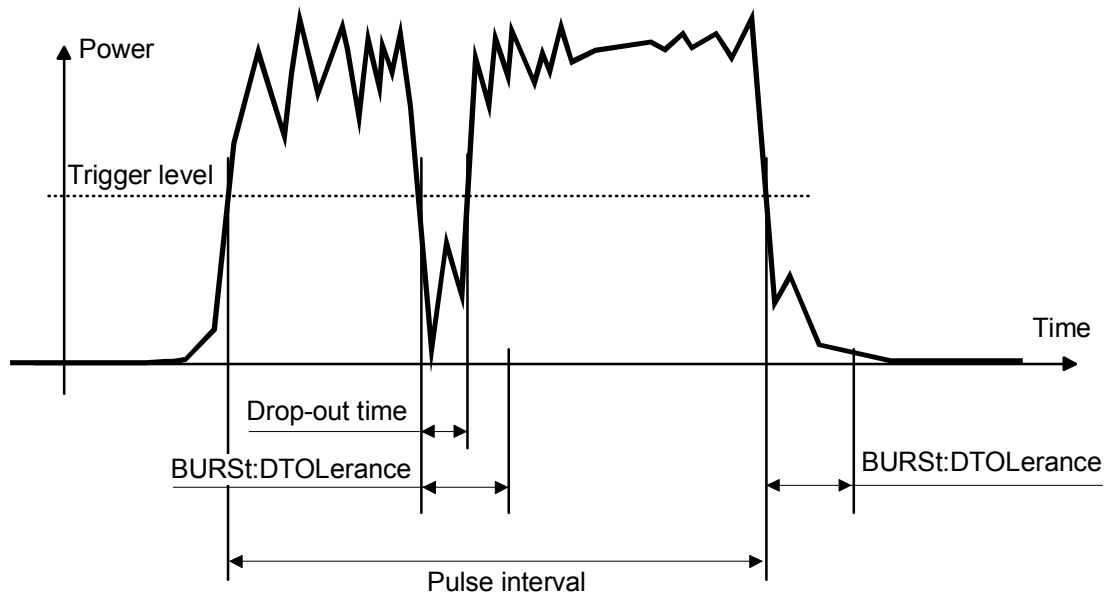

Fig. 6-7: Meaning of drop-out Tolerance.

**Unit:** s

**Value range:** depending on sensor

**\*RST value:** depending on sensor

**[SENSE[1..4]][:POWER]:TGATE[1..4]:OFFSet:TIME[?] <float\_value>**

This command is used for configuring the Timegate mode. It specifies the start of one of the four gates (sweeps) relative to the delayed trigger point. If this value is negative, the gate starts before the trigger point. This is possible because the sensor stores samples of the measured powers and can thus transfer the start of a measurement to the past. In manual operation, the start and duration of the gates can also be defined graphically if the sensor is operated in the Scope mode.

**Unit:** s

**Value range:** depending on sensor

**\*RST value:** depending on sensor

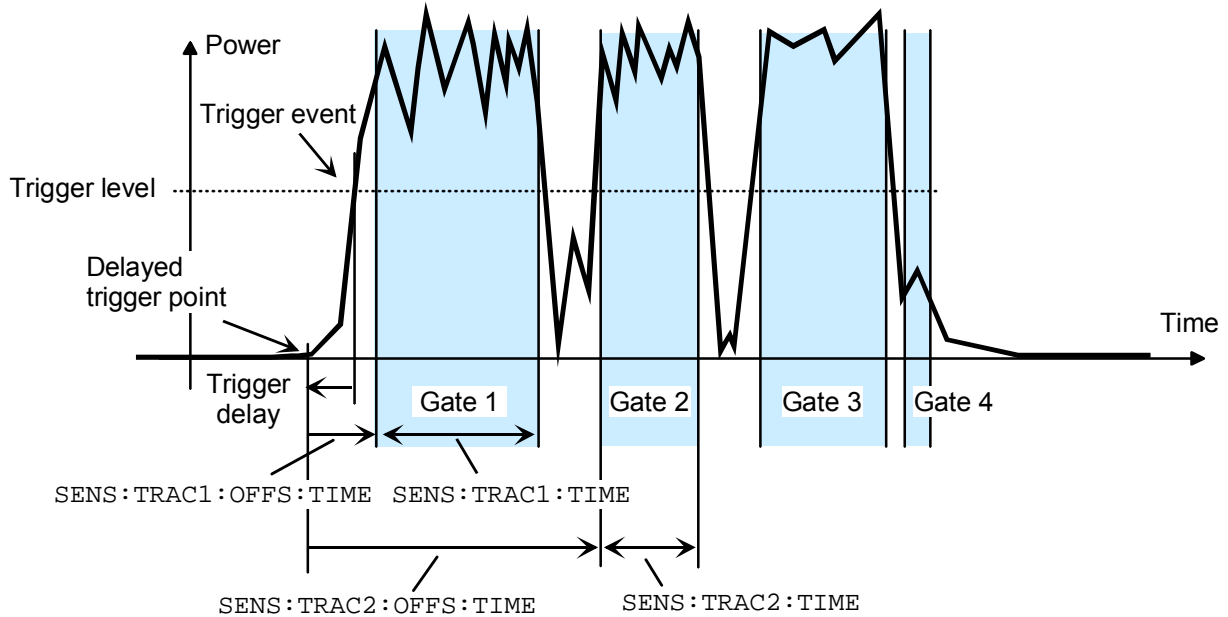

Figure 6-8: Timing parameters for the Timegate mode.

**[SENSE[1..4]][:POWER]:TGATE:SElect[?] 1 | 2 | 3 | 4**

This command selects one of the four gates in which the average power is measured if the Timegate mode is selected.

**\*RST value:** 1

**[SENSE[1..4]][:POWER]:TGATE[1..4]:TIME[?] <float\_value>**

This command is used for configuring the Timegate mode. It specifies the duration of one of the four gates (sweeps) relative to the delayed trigger point. In manual operation, the start and duration of the gates can also be defined graphically if the sensor is operated in the Scope mode.

**Unit:** s

**Value range:** depending on sensor

**\*RST value:** depending on sensor

**[SENSE[1..4]][:POWER]:TSLot:COUNT[?] <int\_value>**

Sets the number of simultaneously measured timeslots in the Timeslot mode.

**Unit:** -

**Value range:** depending on sensor

**\*RST value:** depending on sensor

**[SENSE[1..4]][:POWER]:TSLot:[AVG]:WIDTH[?] <float\_value>**

Sets the length of the timeslot in the Timeslot mode.

**Unit:** s

**Value range:** depending on sensor

**\*RST value:** depending on sensor

**[SENSE[1..4]]:SAMPLing[?] FREQ1 | FREQ2**

If the signal to be measured has modulation sections just above the video bandwidth of the sensor used, measurement errors might be caused due to aliasing effects. In this case, the sampling rate of the sensor can be set to a safe lower value (FREQ2). However, the measurement time required to obtain noise-free results is extended compared to the normal sampling rate (FREQ1).

**\*RST value:** depending on sensor

**[SENSE[1..4]]:SGAMma[:MAGNitude][?] <float\_value>**

The R&S NRP can perform a measured-value correction taking the complex reflection coefficient (source gamma) of the signal source into account. SENS[1..4]:SGAM:CORR:STAT ON must be set. The magnitude of the reflection coefficient is set with SENS[1..4]:SGAM[:MAGN].

**Unit:** -

**Value range:** depending on sensor

**\*RST value:** depending on sensor

**[SENSE[1..4]]:SGAMma:PHASe[?] <float\_value>**

The R&S NRP can perform a measured-value correction taking the complex reflection coefficient (source gamma) of the signal source into account. SENS[1..4]:SGAM:CORR:STAT ON must be set. The phase angle of the reflection coefficient is set with SENS[1..4]:SGAM:PHAS.

**Unit:** - (Degree is assumed as unit)

**Value range:** depending on sensor

**\*RST value:** depending on sensor

**[SENSE[1..4]]:SGAMma:CORRection:STATe[?] ON | OFF**

Switches the measured-value correction of the reflection coefficient effect of the source gamma ON or OFF.

**\*RST value:** depending on sensor

**[SENSE[1..4]]:TRACe:AVERAge[:STATe][?] ON | OFF**

For the Scope mode, this command switches the filter function of a sensor on or off. When the filter is switched on, the number of measured values set with [SENSE[1..4]]:AVERAge:COUNT is averaged. This reduces the effect of noise so that more reliable results are obtained.

\*RST value: depending on sensor

**[SENSE[1..4]]:TRACe:AVERAge:COUNT[?] <int\_value>**

This command sets the length of the filter for the Scope mode. The wider the filter, the lower the noise and the longer it takes to obtain a measured value.

<int\_value> can only be 1, 2, 4, 8, 16,...,  $2^n$ . If <int\_value> is not a power of two, the value is rounded to the next  $2^n$  value without an error message.



**Note:** The SENS:TRAC:AVER:COUN command switches the automatic filter length switchover off (SENS:TRAC:AVER:COUN:AUTO OFF).

**Unit:** -

**Value range:** depending on sensor

\*RST value: depending on sensor

**[SENSE[1..4]]:TRACe:AVERAge:COUNT[?]:AUTO[?] ON | OFF | ONCE**

This command can be used to automatically determine a value for [SENSE[1..4]]:AVERAge:COUNT for the Scope mode. If the command is called with the parameter ONCE, automatic switchover is deactivated (setting OFF) and the suitable filter length will then be defined and set automatically. The setting can then be queried via SENS[1..4]:AVER:COUN?. If the automatic switchover is activated with the ON parameter, the sensor always defines a suitable filter length which can also be queried via SENS[1..4]:AVER:COUN?.

\*RST value: depending on sensor

**[SENSE[1..4]]:TRACe:AVERAge:COUNT:AUTO:MTIME[?] <float\_value>**

If the R&S NRP has to determine the filter length automatically in the Scope mode, the filter length can become large and thus also the time to fill the filter. An upper time limit (maximum time) can be set via SENS[1..4]:AVER:COUN:AUTO:MTIME. It should never be exceeded. Undesired long measurement times can thus be prevented (in the SENS:AVER:COUN:AUTO:TYPE NSR mode) if the automatic filter length switchover is on.

**Unit:** s

**Value range:** depending on sensor

\*RST value: depending on sensor

**[ SENSE[1..4] ] : TRACe : AVERage : COUNt : AUTO : RESolution[?] 1 | 2 | 3 | 4**

Defines the number of significant places for the Scope mode for linear units and the number of decimal places for logarithmic units which should be free of noise in the measurement result. This setting is also performed by the DISP[1..4]:RES command (→ page 6.35) which tries to set the sensors involved in the measurement result accordingly. (For further details, see Chapter 4.) However, SENS[1..4]:AVER:COUN:AUTO:RES does not affect the DISPLAY command. The parameters of the two commands are different but have the same meaning.

<b>SENS[1..4]:AVER:COUN:AUTO:RES</b>	1	2	3	4
<b>DISP[1..4]:RES</b>	1	0.1	0.01	0.001

**Unit:** -

**Value range:** depending on sensor

**\*RST value:** depending on sensor

**[ SENSE[1..4] ] : TRACe : AVERage : COUNt : AUTO : POINT[?] <int\_value>**

Specifies the measured value in the Scope mode used for the automatic determination of the filter length.

**Unit:** -

**Value range:** depending on sensor

**\*RST value:** depending on sensor

**[ SENSE[1..4] ] : TRACe : AVERage : COUNt : AUTO : NSRatio[?] <float\_value>**

Indicates the maximum noise ratio in the measurement result for the Scope mode. The setting is taken into account only if SENS[1..4]:TRAC:AVER:COUN:AUTO ON and SENS[1..4]:TRAC:AVER:COUN:AUTO:TYPE NSR are set.

**Unit:** DB | PCT

**Default unit:** DB

**Value range:** depending on sensor

**\*RST value:** depending on sensor

**[SENSe[1..4]]:TRACe:AVERage:COUNT:AUTO:TYPE[?] RESolution | NSR**

Selects a method for the Scope mode by which the automatic filter length switchover can operate:

SENS[1..4]:AVER:COUN:AUTO:TYPE	Setting taken into account
RESolution	SENS[1..4]:AVER:COUN:AUTO:RES
NSR	SENS[1..4]:AVER:COUN:AUTO:NSR SENS[1..4]:AVER:COUN:AUTO:MTIM

\*RST value: depending on sensor

**[SENSe[1..4]]:TRACe:AVERage:TCONtrol[?] MOVing | REPeat**

As soon as a new single value is determined, the filter window is advanced by one value so that the new value is taken into account by the filter and the oldest value is forgotten. [SENSe[1..4]]:AVERage:TCONtrol (terminal control) then determines in the Scope mode whether a new result will be calculated immediately after a new measured value is available (MOVing) or only after an entire range of new values is available for the filter (REPeat).

\*RST-Wert: **(PRES)** and SYST:PRES: MOV  
\*RST: REP

**[SENSe[1..4]]:TRACe:OFFSet:TIME[?] <float\_value>**

This command determines the relative position of the trigger event in relation to the beginning of the Scope measurement sequence.

**Unit:** s

**Value range:** depending on sensor

\*RST value: depending on sensor

**[SENSe[1..4]]:TRACe:POINts <int\_value>**

Sets the number of desired values per Scope sequence.

**Unit:** -

**Value range:** depending on sensor

\*RST value: depending on sensor

Error messages:

28 "**Sensor not idle**": The sensor is not in the IDLE state.

**[SENSE[1..4]]:TRACe:REALtime[?] ON | OFF**

In the default state (OFF), each measurement from the sensor is averaged. With [SENSE[1..4]]:TRACe:REALtime ON, this behaviour can be switched off, which may increase the measurement speed. This ensures that the measured values of an individual measurement are immediately delivered. (See also Chapter 4.)

\*RST value: depending on sensor

**[SENSE[1..4]]:TRACe:TIME[?] <float\_value>**

Sets the time to be covered by the Scope sequence.

**Unit:** s

**Value range:** depending on sensor

\*RST value: depending on sensor

**[SENSE[1..4]]:TIMing:EXCLude:START[?] <float\_value>**

Sets a time that is to be excluded at the beginning of the integration (→ [Fig. 6-9](#)).

**Unit:** s

**Value range:** depending on sensor

\*RST value: depending on sensor

**[SENSE[1..4]]:TIMing:EXCLude:STOP[?] <float\_value>**

Sets a time that is to be excluded at the beginning of the integration (→ [Fig. 6-9](#)).

**Unit:** s

**Value range:** depending on sensor

\*RST value: depending on sensor

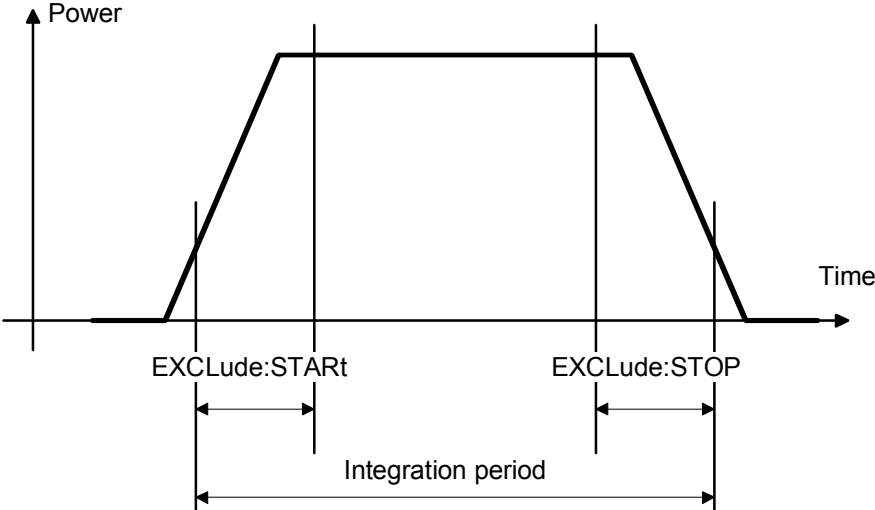

Fig. 6-9: Effect of commands SENS[ 1 . . 4 ] : TIM : EXCL : STAR and : STOP



## SERvice

The commands of the SERvice system are used for maintenance or test purposes. They were implemented primarily to support device development. The numeric suffix refers to the sensors.



**Note:** Before commands of the SERvice system can be sent to a sensor, they must be enabled via the SERvice:UNLock 1234 command.

Table 6-12: Commands of the SERvice command system

Command	Parameter	Unit	Remark
SERvice[1..4]			
:CALibration			
:TEST?	<NR1>	-	Query only
:TEMP	ONCE	-	No query
:TEMP:DATA?	<NR1 >	Kelvin	Query only
:RCOunt[?]	<NR1>	-	
:RESult[?]	<NR1>	-	
:UNLock[?]	1234	-	

### SERvice[1..4]:CALibration:TEST? <NR1>

Tests the consistency of the calibration data set according to three criteria:

If the following bit is set in <NR1>,	the following action is executed.
0	The serial number of the calibration data set is tested.
1	The checksum of the calibration data set is tested.
2	The header of the calibration data set is tested.

If an inconsistency of the data set is detected, the query returns a 1, otherwise a 0.

**Value range:** 0 to 255

**\*RST value:** none

### SERvice[1..4]:CALibration:TEMP ONCE

Initiates a temperature measurement of the sensor in question. The temperature can be queried with SERvice:CAL:TEMP:DATA?.

### SERvice[1..4]:CALibration:TEMP:DATA? <NR1>

Returns the temperature of the sensor in Kelvin if a temperature measurement was previously initiated by means of SERvice:CAL:TEMP ONCE.

```
SERvice[1..4]:RCOunt[?] <NR1>
SERvice[1..4]:RESult[?] <NR1>
```

These commands allow simulated measured values to be specified for test purposes. `SERV:RCO` specifies the number of `SERV:RES` pairs to follow. The first `SERV:RES` command specifies the measured value in watts, the second `SERV:RES` command determines how often the measured value should be obtained. The measurement sequences defined in this way are repeated until the sensor is disconnected from the R&S NRP and reconnected.

**Example:**

The command sequence

```
SERV2:RCO 2
SERV2:RES 3
SERV2:RES 2
SERV2:RES 4
SERV2:RES 1
```

makes sensor 2 return the measured values 3 W, 3 W, 4 W (, 3 W, 3 W, 4W, ....) from now on.

**\*RST value:** none. The simulation mode is not exited in the case of \*RST.

```
SERvice[1..4]:UNLock[?] 1234
```

Before other `SERVice` system commands are accepted, they must be enabled with `SERV:UNL 1234`.

## STATUS

The status registers of the R&S NRP can be read and configured with commands of the STATUS system. The R&S NRP uses the following status registers:

- Standard Event Status Register (specified in IEEE 488.2. Reading and configuring with \*ESR? and \*ESE. This register is not handled by the STATUS system.)
- Device Status Register
- Questionable Status Register
- Questionable Power Status Register
- Questionable Window Status Register
- Questionable Calibration Status Register
- Operation Status Register
- Operation Calibrating Status Register
- Operation Measuring Status Register
- Operation Trigger Status Register
- Operation Sense Status Register
- Operation Lower Limit Fail Status Register
- Operation Upper Limit Fail Status Register

Except for the Standard Event Status Register, each of these registers comprises five subregisters with which the function of the register can be configured. These subregisters are called

- EVENT
- CONDition
- NTRansition
- PTRansition
- ENABle

The registers are 16 bits wide but only the lower 15 bits are used. This prevents problems with programs that cannot handle integers without sign.

For the sake of conciseness, not all commands are listed here. For a complete → [List of Remote Control Commands](#) see page 6.109. The STATUS system uses the following types of commands:

**Queries** return a decimal value between 0 and 32767 ( $=2^{15}-1$ ).

**Configuration commands** set the ENABle, PTRansition, NTRansition registers of a status register and thus determine the response of the register to status changes in the R&S NRP.

## Queries

Table 6-13: Queries for status registers

Command	Status register
STATUS	
:DEVICE?	Device Status
:OPERATION?	Operation Status
:CALIBRATING[:SUMMARY]?	Operation Calibrating
:LLFAIL[:SUMMARY]?	Operation Lower Limit Fail
:ULFAIL[:SUMMARY]?	Operation Upper Limit Fail
:MEASURING[:SUMMARY]?	Operation Measuring
:SENSE[:SUMMARY]?	Operation Sense
:TRIGGER[:SUMMARY]?	Operation Trigger
:QUESTIONABLE?	Questionable Status
:CALIBRATION[:SUMMARY]?	Questionable Calibration
:POWER[:SUMMARY]?	Questionable Power
:WINDOW[:SUMMARY]?	Questionable Window

## Configuration Commands

If the status register queries are extended by the character strings [:EVENT], :CONDITION, :ENABLE, :PTRANSITION OR NTRANSITION (without a question mark "?" at the end), the respective subregisters can be accessed. The enable and transition registers can also be set with these commands. The effect of the status reporting system can thus be adapted to user requirements. The parameters have the following meaning:

**<status\_register\_summary\_command>** One of the status register queries from [Table 6-13](#) is to be used here (without a terminating question mark "?").

**<NR1>** Is a decimal value between 0 and 32767. The values DEFAULT, MINIMUM and MAXIMUM are not permissible.

**<non-decimal numeric>** Is a non-decimal value in one of the following formats, where the decimal value must be between 0 and 32767:

- binary (e. g. #b0111010101001110 or #B0111010101001110)
- hexadecimal (e.g. #h754e or #H754E)
- octal (e.g. #q72516 or #Q75216)

Table 6-14: Commands for the configuration of status registers

Command	Parameter	Remark
<status_register_summary_command>		
[:EVENT]?		Query only
:CONDITION?		Query only
:ENABLE[?]	0..32767   <non-decimal numeric>	
:NTRANSITION[?]	0..32767   <non-decimal numeric>	
:PTRANSITION[?]	0..32767   <non-decimal numeric>	
STATUS:PRESet		→ <a href="#">Table 6-30</a>

The status reporting system stores all information about the current operating status of the device and errors that occur. The information is stored in the status registers and the error queue. The contents of the status registers and error queue can be queried via the IEC/IEEE bus. The information is hierarchically structured. The highest level is formed by the Status Byte Register (STB) defined by IEEE 488.2 and the associated Service Request Enable (SRE) register. The STB receives its information from the Standard Event Status Register (ESR) also defined by IEEE 488.2 and the associated Standard Event Status Enable (ESE) Register, as well as from the SCPI-defined Operation Status Register and the Questionable Status Register, which contain detailed information on the device, and from the Device Status Register.

The status reporting system also includes the IST flag (Individual Status) and the Parallel Poll Enable Register (PPE) assigned to it. The IST flag, like the SRQ, combines the complete device status in a single bit. The PPE has the same function for the IST flag as the SRE has for the service request.

The output buffer (output queue) contains the messages the device returns to the controller. It is not part of the status reporting system but since it determines the value of the MAV bit in the STB it is also shown in Fig. 6-11.

### Structure of SCPI Status Register

Each SCPI register consists of five 16-bit registers which have different functions (→ Fig. 6-10). The individual bits are independent of each other, i.e. each hardware status is assigned a bit number which is the same for all five registers. For instance, bit 4 of the operation status register is assigned to the hardware status "Measurement" in all five registers. Bit 15 (the most-significant bit) is set to zero in all registers. This prevents problems some controllers have with the processing of unsigned integers.

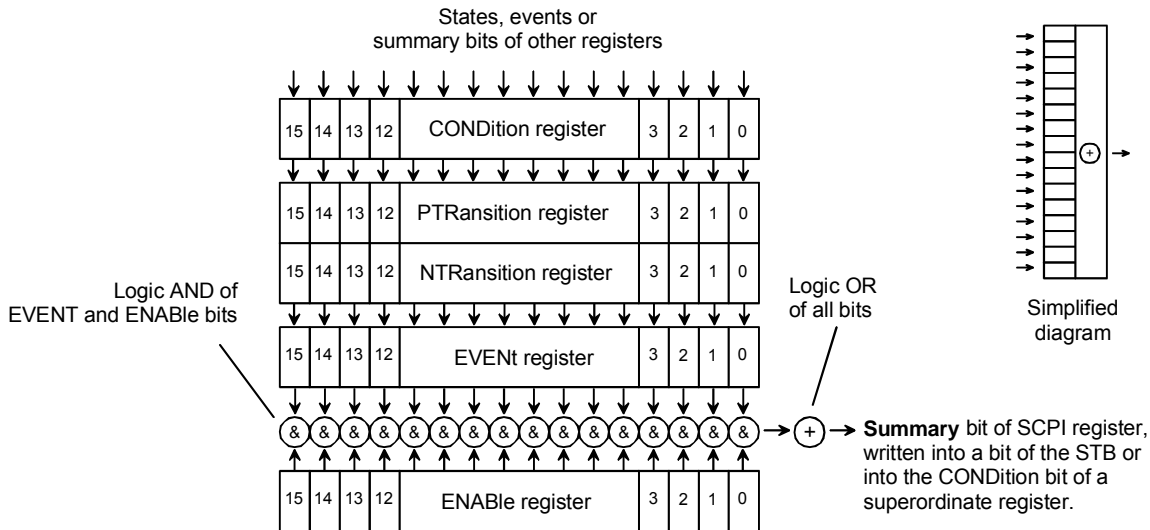

Fig. 6-10: Standard SCPI status register

Table 6-15: Decimal value of individual bits in the SCPI status register

Bit No.	Decimal value	Bit No.	Decimal value	Bit No.	Decimal value	Bit No.	Decimal value
0	1	4	16	8	256	12	4096
1	2	5	32	9	512	13	8192
2	4	6	64	10	1024	14	16384
3	8	7	128	11	2048	15	32768

**CONDition register**

The CONDition register is directly written by the hardware or the summary bit of the next lower register. Its content reflects the current device status.

This register can only be read; it cannot be written to or cleared. Reading the register does not change its contents.

**PTRansition register**

The Positive TRansition register acts as a transition filter. When a bit of the CONDition register changes from 0 to 1, the associated PTR bit determines whether the EVENT bit will be set to 1.

PTR bit = 1: the EVENT bit is set.

PTR bit = 0: the EVENT bit is not set.

This register can be written to and read. Reading the register does not change its contents.

**NTRansition register**

The Negative TRansition register also acts as a transition filter. Upon transition of a bit of the CONDition register from 1 to 0, the associated NTR bit determines whether the EVENT bit is set to 1.

NTR bit = 1: the EVENT bit is set.

NTR bit = 0: the EVENT bit is not set.

This register can be written to and read. Reading the register does not change its contents.

With the aid of these two transition filter registers the user can define the status change of the CONDition register (none, 0 to 1, 1 to 0 or both) that is to be recorded in the EVENT register.

**EVENT register**

The EVENT register reports whether an event has occurred since its last reading; it is the "memory" of the CONDition register. It only registers events that have been reported by the transition filters. The EVENT register is continuously updated by the device.

It can only be read by the user. Reading this register clears its contents.

This register is frequently referred to as the overall register.

**ENABLE register** The ENABLE register determines whether the associated EVENT bit influences the summary bit (see below). Each bit of the EVENT register is ANDed (symbol '&') with the associated ENABLE bit. The events of all logical operations of this register are ORed (symbol '+') and passed on to the summary bit.

ENABLE bit = 0: the associated EVENT bit does not affect the summary bit. bit = 1: if the associated EVENT bit is "1", the summary bit is also set to "1".

This register can be written to and read as required. Reading the register does not change its contents.

**Summary bit** As stated above, the summary bit for each register is derived from the EVENT and ENABLE registers. The result is entered into a bit of the CONDition register of the next higher register. The device automatically generates the summary bit for each register. An event may thus cause a service request through all hierarchical levels.



**Note:** *The Service Request Enable register (SRE) defined by IEEE488.2 can be viewed as the ENABLE register of the STB. Accordingly, the ESE can be viewed as the ENABLE register of the ESR.*

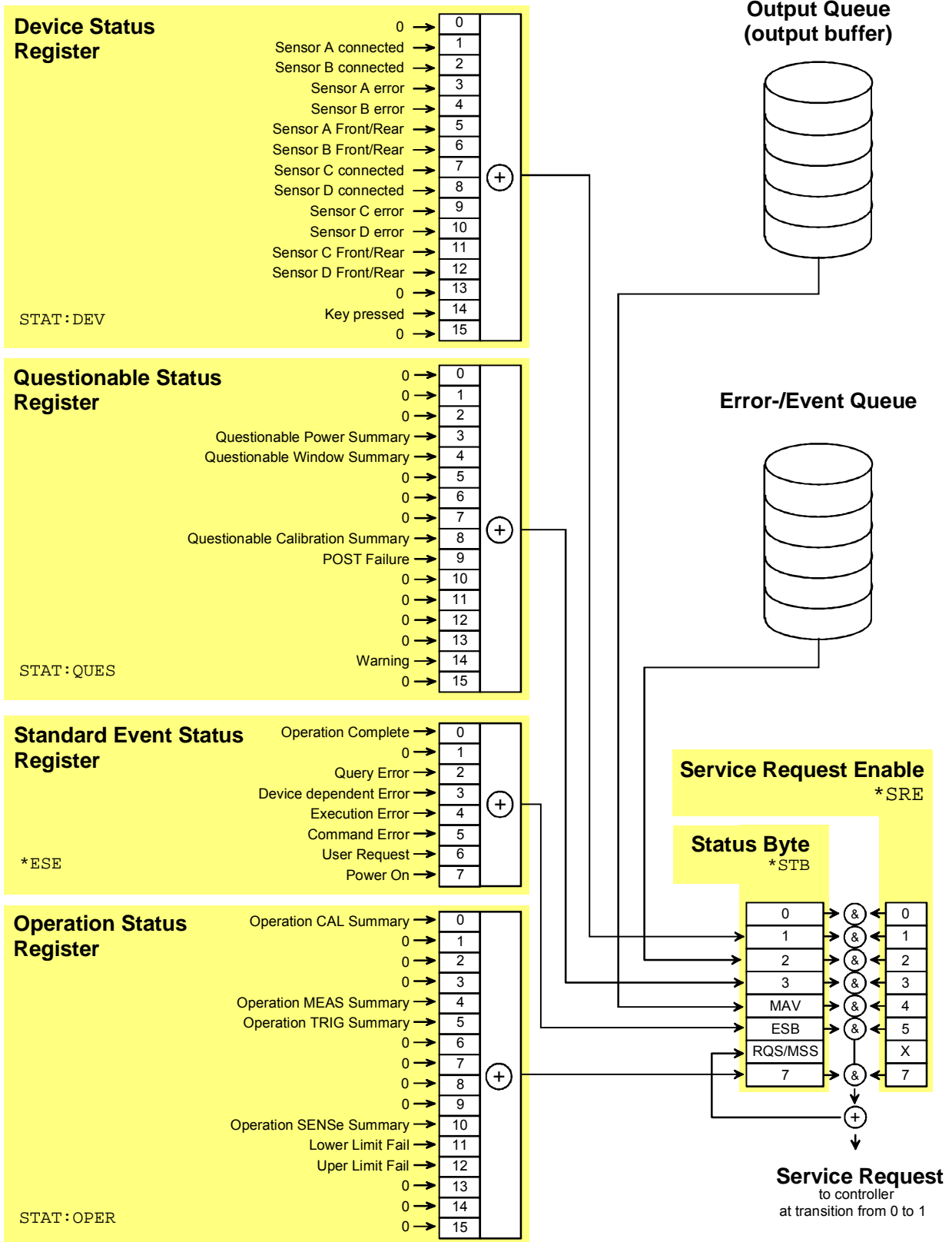

Fig. 6-11: Overview on structure of Status Reporting System



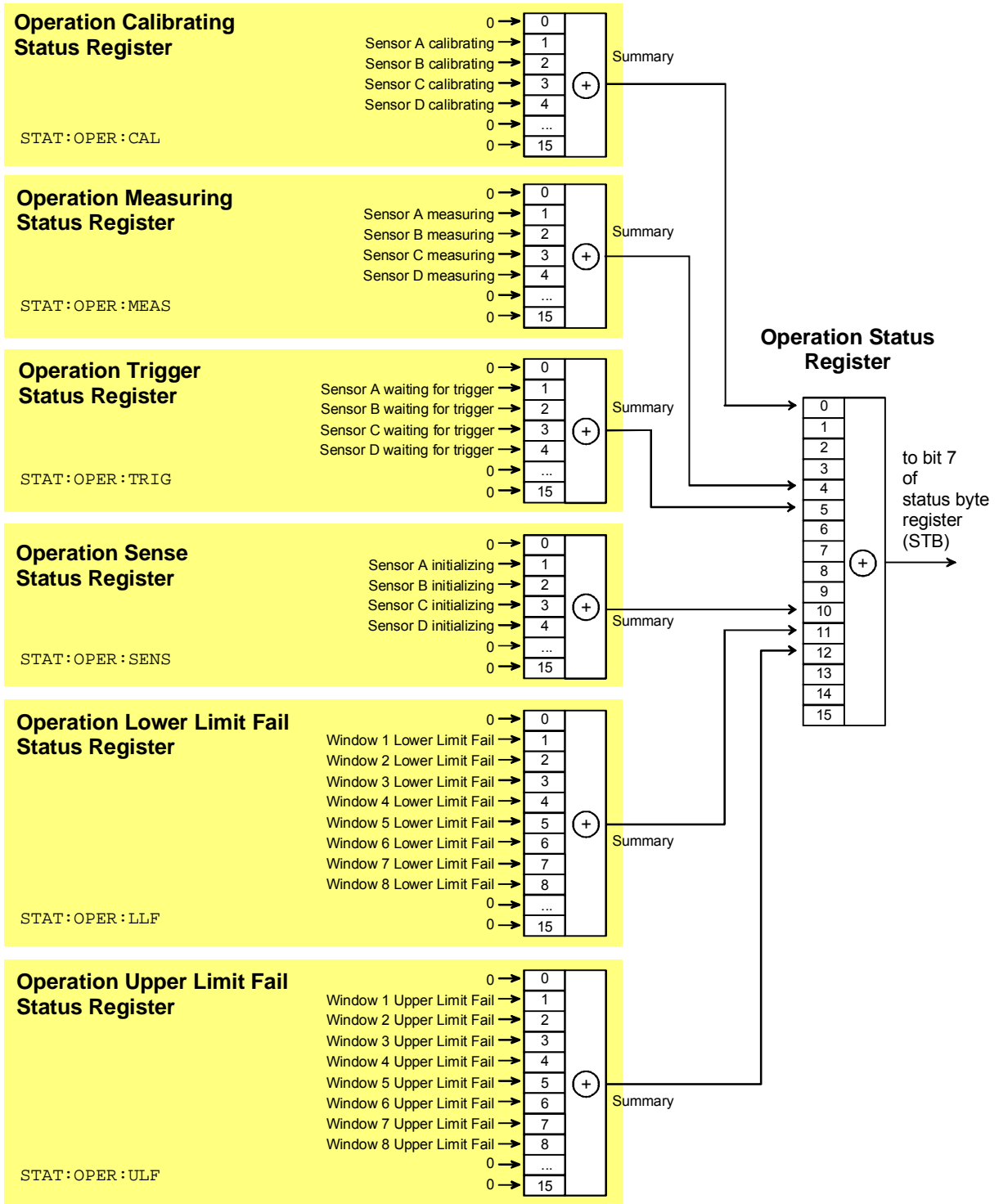

Fig. 6-12: Operation Status Register

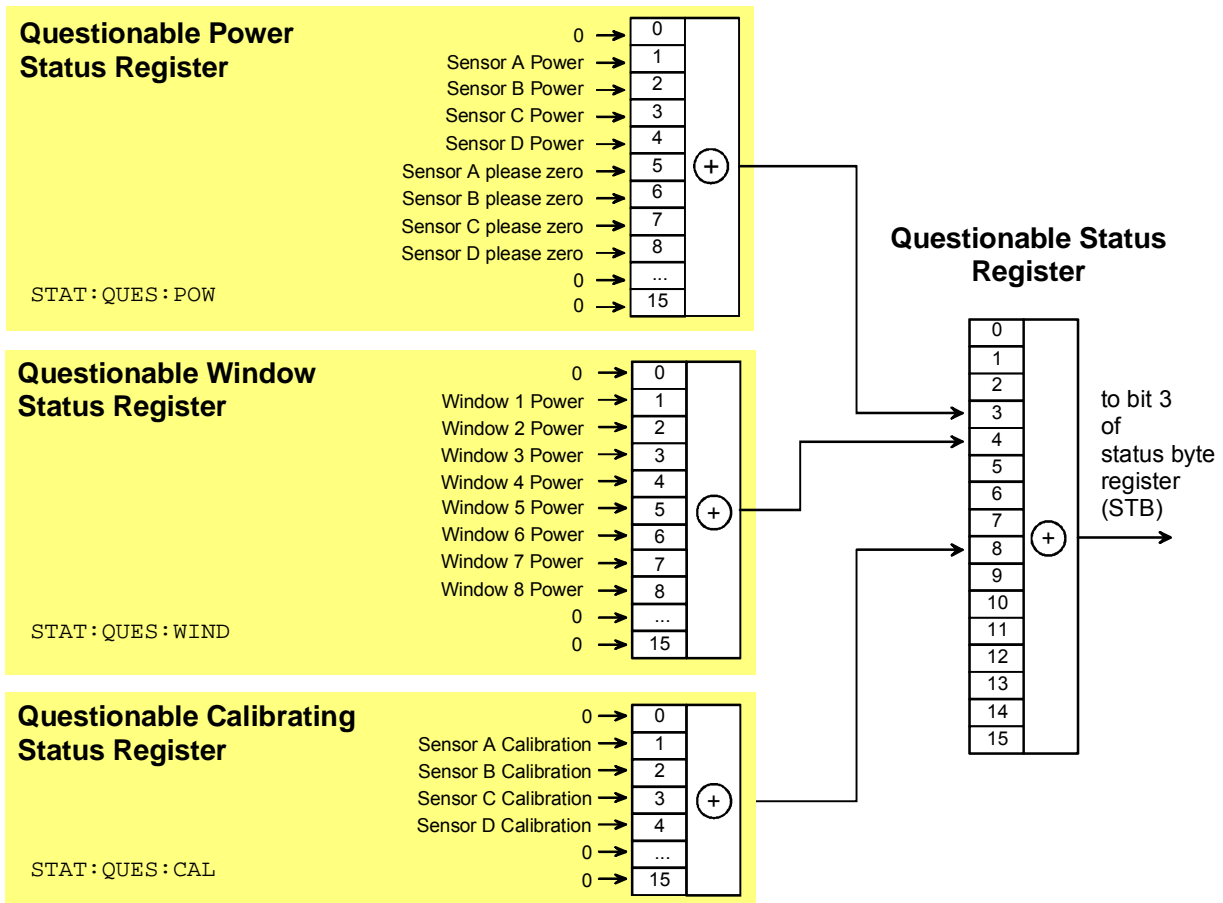

Fig. 6-13: Questionable Status Register

## Description of Status Registers

In the following sections the SCPI status registers shown in Fig. 6-11 to Fig. 6-13 are described in detail:

- Status Byte (STB)
- Service Request Enable Register (SRE)
- Device Status Register
- Questionable Status Register
- Standard Event Status Register (ESR) with ENABLE register (ESE)
- Operation Status Register
- Operation Calibrating Status Register
- Operation Measuring Status Register
- Operation Trigger Status Register
- Operation Sense Status Register
- Operation Lower Limit Fail Status Register
- Operation Upper Limit Fail Status Register
- Questionable Power Status Register
- Questionable Window Status Register
- Questionable Calibration Status Register

## Status Byte (STB) and Service Request Enable Register (SRE)

The STB is already defined in IEEE 488.2. It gives a rough overview of the device status, collecting information from the lower-level registers. It is comparable with the CONDition register of a SCPI-defined register and is at the highest level of the SCPI hierarchy. Its special feature is that bit 6 acts as the summary bit of all other bits of the Status Byte Register.

The status byte is read by the query `*STB?` or a serial poll. The SRE is associated with the STB. The function of the SRE corresponds to that of the ENABLE register of the SCPI registers. Each bit of the STB is assigned a bit in the SRE. Bit 6 of the SRE is ignored. If a bit is set in the SRE and the associated bit in the STB changes from 0 to 1, a service request (SRQ) will be generated on the IEC/IEEE bus, which triggers an interrupt in the controller configured for this purpose, and can be further processed by the controller.

The SRE can be set by the command `*SRE` and read by the query `*SRE?`.

Table 6-16: Meaning of bits used in the status byte

Bit No.	Meaning
0	Not used
1	<b>Device Status Register summary bit</b> Depending on the configuration of the device status register, this bit is set when a sensor is connected or disconnected, when an error has occurred in a sensor or when a key has been pressed.
2	<b>Error Queue not empty</b> The bit is set if the error queue has an entry. If this bit is enabled by the SRE, each entry of the error queue will generate a service request. An error can thus be recognized and specified in detail by querying the error queue. The query yields a conclusive error message. This procedure is recommended since it considerably reduces the problems of IEC/IEEE-bus control.
3	<b>Questionable Status Register summary bit</b> This bit is set if an EVENT bit is set in the QUESTionable Status Register and the associated ENABLE bit is set to 1. A set bit denotes a questionable device status which can be specified in greater detail by querying the QUESTionable Status Register.
4	<b>MAV-Bit (Message available)</b> This bit is set if a readable message is in the output queue. This bit may be used to automate reading of data from the device into the controller.
5	<b>ESB: Standard Event Status Register summary bit</b> This bit is set if one of the bits in the Standard Event Status Register is set and enabled in the Event Status Enable Register. Setting this bit denotes a serious error which can be specified in greater detail by querying the Standard Event Status Register.
6	<b>MSS: Master-Status summary bit</b> This bit is set if the device triggers a service request. This is the case if one of the other bits of this register is set together with its enable bit in the Service Request Enable register SRE.
7	<b>Operation Status Register summary bit</b> This bit is set if an EVENT bit is set in the Operation Status Register and the associated ENABLE bit is set to 1. A set bit denotes that an action is being performed by the device. Information on the type of action can be obtained by querying the Operation Status Register.

## IST Flag and Parallel Poll Enable Register (PPE)

Similar to the SRQ, the IST flag combines the complete status information in a single bit. It can be queried by a parallel poll (→ section [Parallel Poll](#), page 6.91) or by the `*IST?` command.

The Parallel Poll Enable Register (PPE) determines which bits of the STB affect the IST flag. The bits of the STB are ANDed with the corresponding bits of the PPE; bit 6 is also used - in contrast to the SRE. The IST flag is obtained by ORing all results together.

The PPE can be set by the `*PRE` command and read by the `*PRE?` query.

## Device Status Register

This register contains information on current device states (CONDition register) or states that occurred since the last query (EVENT register).

The register can be read by the queries `STATus:DEvice:CONDition?` or `STATus:DEvice[:EVENT]?`.

Table 6-17: Meaning of bits used in the Device Status Register

Bit No.	Meaning
0	Not used
1	<b>Sensor A connected</b>
2	<b>Sensor B connected</b>
3	<b>Sensor A error</b> Sensor A is erroneous.
4	<b>Sensor B error</b> Sensor B is erroneous.
5	<b>Sensor A Front/Rear</b> Indicates whether sensor A is connected at the front (bit is not set) or rear (bit is set) of the device.
6	<b>Sensor B Front/Rear</b> Indicates whether sensor B is connected at the front (bit is not set) or rear (bit is set) of the device.
7	<b>Sensor C connected</b>
8	<b>Sensor D connected</b>
9	<b>Sensor C error</b> Sensor C is erroneous.
10	<b>Sensor D error</b> Sensor D is erroneous.
11	<b>Sensor C Front/Rear</b> Indicates whether sensor C is connected at the front (bit is not set) or rear (bit is set) of the device.

Bit No.	Meaning
12	<b>Sensor D Front/Rear</b> Indicates whether sensor D is connected at the front (bit is not set) or rear (bit is set) of the device.
13	Not used
14	<b>Key pressed</b> This bit is always set if a key on the front panel is pressed (CONDition) or was pressed (EVENT).
15	Bit 15 will never be used.

## Questionable Status Register

This register contains information on questionable device states. Such states may occur when the device is not operated in compliance with its specifications. The register can be read by the queries `STATUS:QUESTionable:CONDition?` or `STATUS:QUESTionable[:EVENT]?`.

Table 6-18: Meaning of bits used in the Questionable Status Register

Bit No.	Meaning
0 to 2	Not used
3	<b>Questionable Power Status Register summary bit</b> Corresponds to the summary bit of the Questionable Power Status Register.
4	<b>Questionable Window Status Register summary bit</b> Corresponds to the summary bit of the Questionable Windows Status Register.
5 to 7	Not used
8	<b>Questionable Calibration Status Register summary bit</b> Corresponds to the summary bit of the Questionable Calibration Status Register.
9	<b>POST Failure</b> The built-in test of the R&S NRP carried out automatically upon power-up has generated an error.
10 to 13	Not used
14	<b>Warning</b>
15	Bit 15 will never be used.

## Standard Event Status Register (ESR) Standard Event Status Enable Register (ESE)

The ESR is already defined in the IEEE 488.2 standard. It is comparable to the EVENT register of an SCPI register. The Standard Event Status Register can be read out by the query \*ESR?.

The ESE forms the associated ENABLE register. It can be set by the command \*ESE and read out by the query \*ESE?.

Table 6-19: Meaning of bits used in the Standard Event Status Register

Bit No.	Meaning
0	<b>Operation Complete</b> When the *OPC command is received, this bit is set if all previous commands have been executed.
1	Not used
2	<b>Query Error</b> This bit is set in either of the two following cases: the controller wants to read data from the device but has not sent a query, or it sends new commands to the device before it retrieves existing requested data. A frequent cause is a faulty query which cannot be executed.
3	<b>Device-dependent Error</b> This bit is set if a device-dependent error occurs. An error message with a number between -300 and -399 or a positive error number denoting the error in greater detail will be entered in the error queue.
4	<b>Execution Error</b> This bit is set if the syntax of a received command is correct but the command cannot be executed due to various marginal conditions. An error message with a number between -200 and -300 denoting the error in greater detail will be entered in the error queue.
5	<b>Command Error</b> This bit is set if an undefined command or a command with incorrect syntax is received. An error message with a number between -100 and -200 denoting the error in greater detail will be entered in the error queue.
6	<b>User Request</b> This bit is set upon pressing the [LOCAL] key, i.e. when the device is switched to manual control.
7	<b>Power On</b> This bit is set when the device is switched on.

## Operation Status Register

The CONDition register contains information on the operations currently being performed by the device, while the EVEnt register contains information on the operations performed by the device since the last readout of the register.

These two registers can be read by the queries `STATus:OPERation:CONDition?` or `STATus:OPERation[:EVENT]?`.

Table 6-20: Meaning of bits used in the Operation Status Register

Bit No.	Meaning
0	<b>Operation Calibrating Status Register summary bit</b> This bit is set if one of the sensors is being calibrated.
1 to 3	Not used
4	<b>Operation Measuring Status Register summary bit</b> This bit is set if one of the sensors is performing a measurement.
5	<b>Operation Trigger Status Register summary bit</b> This bit is set if a sensor is in the WAIT_FOR_TRG state, i.e. waiting for a trigger event.
6	Not used
7 to 9	Not used
10	<b>Operation Sense Status Register summary bit</b> This bit is set if a sensor is initialized.
11	<b>Operation Lower Limit Fail Status Register</b> This bit is set if a displayed value has dropped below a lower limit value.
12	<b>Operation Upper Limit Fail Status Register</b> This bit is set if a displayed value has exceeded an upper limit value.
13 to 14	Not used
15	Bit 15 will never be used.

## Operation Calibrating Status Register

The CONDition register contains information as to whether a sensor is currently being calibrated and, depending on the configuration of the transition register, the EVENt register indicates whether a calibration was started or completed since the last readout of this register.

The Operation Calibration Status Register can be read by the following commands:

STATus:OPERation:CALibrating[:SUMMary]:CONDition?

STATus:OPERation:CALibrating[:SUMMary][:EVENT]?

Table 6-21: Meaning of bits used in the Operation Calibrating Status Register

Bit No.	Meaning
0	Not used
1	<b>Sensor A is being calibrated</b>
2	<b>Sensor B is being calibrated</b>
3	<b>Sensor C is being calibrated</b>
4	<b>Sensor D is being calibrated</b>
5 to 14	Not used
15	Bit 15 will never be used.



## Operation Measuring Status Register

The CONDition register contains information as to whether a measurement is being performed by a sensor and, depending on the configuration of the transition register, the EVENT register indicates whether a measurement was started or completed since the last readout of this register.

The Operation Measuring Status Register can be read by the following commands:

STATus:OPERation:MEASuring[:SUMMARY]:CONDition?

STATus:OPERation:MEASuring[:SUMMARY][:EVENT]?

Table 6-22: Meaning of bits used in the Operation Measuring Status Register

Bit No.	Meaning
0	Not used
1	<b>Sensor A measuring</b> Sensor A is performing a measurement.
2	<b>Sensor B measuring</b> Sensor B is performing a measurement.
3	<b>Sensor C measuring</b> Sensor C is performing a measurement.
4	<b>Sensor D measuring</b> Sensor D is performing a measurement.
5 to 14	Not used
15	Bit 15 will never be used.

## Operation Trigger Status Register

The CONDition register contains information as to whether a sensor is currently in the WAIT\_FOR\_TRG state, i.e. expecting a trigger event and, depending on the configuration of the transition register, the EVENT register indicates whether the WAIT\_FOR\_TRG state was entered or quit by a sensor since the last readout of the register.

The Operation Trigger Status Register can be read by the following commands:

```
STATUS:OPERation:TRIGger[:SUMMARY]:CONDition?
```

```
STATUS:OPERation:TRIGger[:SUMMARY][:EVENT]? .
```

Table 6-23: Meaning of bits used in the Operation Status Register

Bit No.	Meaning
0	Not used
1	<b>Sensor A waiting for trigger</b> Sensor A is in the WAIT_FOR_TRG state and is waiting for a trigger event that will change it to the MEASURING state.
2	<b>Sensor B waiting for trigger</b> Sensor B is in the WAIT_FOR_TRG state and is waiting for a trigger event that will change it to the MEASURING state.
3	<b>Sensor C waiting for trigger</b> Sensor C is in the WAIT_FOR_TRG state and is waiting for a trigger event that will change it to the MEASURING state.
4	<b>Sensor D waiting for trigger</b> Sensor D is in the WAIT_FOR_TRG state and is waiting for a trigger event that will change it to the MEASURING state.
5 to 14	Not used
15	Bit 15 will never be used.

## Operation Sense Status Register

The CONDition register contains information as to whether a sensor is currently being initialized and, depending on the configuration of the transition register, the EVENt register indicates whether a sensor initialization was started or completed since the last readout of this register. This status is assumed by a sensor if one of the following conditions is met:

- the supply voltage is switched on (power up)
- the sensor was just connected
- a reset was performed (\*RST or SYSTem:PRESet)

The Operation Sense Status Register can be read by the following commands:

STATus:OPERation:SENSe[:SUMMary]:CONDition?

STATus:OPERation:SENSe[:SUMMary][:EVENT]?

Table 6-24: Meaning of bits used in the Operation Sense Status Register

Bit No.	Meaning
0	Not used
1	<b>Sensor A initializing</b> Sensor A is being initialized.
2	<b>Sensor B initializing</b> Sensor B is being initialized.
3	<b>Sensor C initializing</b> Sensor C is being initialized.
4	<b>Sensor D initializing</b> Sensor D is being initialized.
5 to 14	Not used
15	Bit 15 will never be used.

## Operation Lower Limit Fail Status Register

The CONDition register contains information as to whether a displayed value is currently below a configured lower limit and the EVENT register indicates whether a measured value dropped below a limit value since the last readout of the Operation Lower Limit Fail Status Register. Details of the behaviour are defined by the transition register.

The limit value can be set with the command `CALC:LIM:LOW:DATA <float_value>`. Command `CALC:LIM:LOW:STAT ON` configures the PTRansition and NTRansition registers so that the corresponding bit is set in the EVENT register when the displayed value drops below the limit.

The Operation Lower Limit Fail Status Register can be read by the following commands:

`STATus:OPERation:LLIMit[:SUMMary]:CONDition?`

`STATus:OPERation:LLIMit[:SUMMary][:EVENT]?`

Table 6-25: Meaning of bits used in the Operation Lower Limit Fail Status Register

Bit No.	Meaning
0	Not used
1	<b>Window 1 Lower Limit Fail</b> The measured value returned by the first Calculate block drops below the lower limit value.
2	<b>Window 2 Lower Limit Fail</b> The measured value returned by the second Calculate block drops below the lower limit value.
3	<b>Window 3 Lower Limit Fail</b> The measured value returned by the third Calculate block drops below the lower limit value.
4	<b>Window 4 Lower Limit Fail</b> The measured value returned by the fourth Calculate block drops below the lower limit value.
5	<b>Window 5 Lower Limit Fail</b> The measured value returned by the fifth Calculate block drops below the lower limit value.
6	<b>Window 6 Lower Limit Fail</b> The measured value returned by the sixth Calculate block drops below the lower limit value.
7	<b>Window 7 Lower Limit Fail</b> The measured value returned by the seventh Calculate block drops below the lower limit value.
8	<b>Window 8 Lower Limit Fail</b> The measured value returned by the eighth Calculate block drops below the lower limit value.
9 to 14	Not used
15	Bit 15 will never be used.

## Operation Upper Limit Fail Status Register

The CONDition register contains information as to whether a displayed value is currently above a configured upper limit and the EVENt register indicates whether a limit value was exceeded since the last readout of the Operation Upper Limit Fail Status Register. Details of the behaviour are defined by the transition register. The limit value can be set with the command `CALC:LIM:UPP:DATA <float_value>`. Command `CALC:LIM:UPP:STAT ON` configures the PTRansition and NTRansition registers so that the corresponding bit is set in the EVENt register when the displayed value exceeds the upper limit value.

The Operation Upper Limit Fail Status Register can be read by the commands `STATus:OPERation:ULIMit[:SUMMary]:CONDition?` and `STATus:OPERation:ULIMit[:SUMMary][:EVENT]?`.

Table 6-26: Meaning of bits used in the Operation Upper Limit Fail Status Register

Bit No.	Meaning
0	Not used
1	<b>Window 1 Upper Limit Fail</b> The measured value returned by the first Calculate block exceeds the upper limit value.
2	<b>Window 2 Upper Limit Fail</b> The measured value returned by the second Calculate block exceeds the upper limit value.
3	<b>Window 3 Upper Limit Fail</b> The measured value returned by the third Calculate block exceeds the upper limit value.
4	<b>Window 4 Upper Limit Fail</b> The measured value returned by the fourth Calculate block exceeds the upper limit value.
5	<b>Window 5 Upper Limit Fail</b> The measured value returned by the fifth Calculate block exceeds the upper limit value.
6	<b>Window 6 Upper Limit Fail</b> The measured value supplied by the sixth Calculate block exceeds the upper limit value.
7	<b>Window 7 Upper Limit Fail</b> The measured value supplied by the seventh Calculate block exceeds the upper limit value.
8	<b>Window 8 Upper Limit Fail</b> The measured value supplied by the eighth Calculate block exceeds the upper limit value.
9 to 14	Not used
15	Bit 15 will never be used.

## Questionable Power Status Register

The CONDition register contains information as to whether the measured power values are questionable.

The Questionable Power Status Register can be read by the following commands:

```
STATus:QUESTionable:POWer[:SUMMary]:CONDition?
```

```
STATus:QUESTionable:POWer[:SUMMary][:EVENT]?
```

Table 6-27: Meaning of bits used in the Questionable Power Status Register

Bit No.	Meaning
0	Not used
1	<b>Sensor A Power</b> The measurement data of sensor A is corrupt.
2	<b>Sensor B Power</b> The measurement data of sensor B is corrupt.
3	<b>Sensor C Power</b> The measurement data of sensor C is corrupt.
4	<b>Sensor D Power</b> The measurement data of sensor D is corrupt.
5	<b>Sensor A please zero</b> The zero correction for sensor A is no longer correct and should be repeated.
6	<b>Sensor B please zero</b> The zero correction for sensor B is no longer correct and should be repeated.
7	<b>Sensor C please zero</b> The zero correction for sensor C is no longer correct and should be repeated.
8	<b>Sensor D please zero</b> The zero correction for sensor D is no longer correct and should be repeated.
9 to 14	Not used
15	Bit 15 will never be used.

The sensor power bit is set when error -230, "Data corrupt or stale", or -231, "Data questionable", occurs in the respective sensor.

## Questionable Window Status Register

The CONDition register contains information as to whether the displayed data or the power calculated by the calculate blocks is questionable.

The Questionable Window Status Register can be read by the following commands:

```
STATus:QUESTionable:WINDow[:SUMMary]:CONDition?
```

```
STATus:QUESTionable:WINDow[:SUMMary][:EVENT]?
```

Table 6-28: Meaning of bits used in the Questionable Window Status Register

Bit No.	Meaning
0	Not used
1	<b>Window 1 Power</b> The measured values returned by Calculate block 1 are corrupt.
2	<b>Window 2 Power</b> The measured values returned by Calculate block 2 are corrupt.
3	<b>Window 3 Power</b> The measured values returned by Calculate block 3 are corrupt.
4	<b>Window 4 Power</b> The measured values returned by Calculate block 4 are corrupt.
5	<b>Window 5 Power</b> The measured values returned by Calculate block 5 are corrupt.
6	<b>Window 6 Power</b> The measured values returned by Calculate block 6 are corrupt.
7	<b>Window 7 Power</b> The measured values returned by Calculate block 7 are corrupt.
8	<b>Window 8 Power</b> The measured values returned by Calculate block 8 are corrupt.
9 to 14	Not used
15	Bit 15 will never be used.

A bit is set if the error -231, "Data questionable", occurs in the respective calculate block.

## Questionable Calibration Status Register

The EVENT register and the CONDITION register contain information as to whether the zero offset of a sensor is still valid.

The Questionable Calibration Status Register can be read by the following commands:

```
STATUS:QUESTIONABLE:CALIBRATION[:SUMMARY]:CONDITION?
andSTATUS:QUESTIONABLE:CALIBRATION[:SUMMARY][:EVENT]?
```

Table 6-29 Meaning of bits used in the Questionable Calibration Status Register

Bit No.	Meaning
0	Not used
1	<b>Sensor A Calibration</b> Zeroing of sensor A was not successful.
2	<b>Sensor B Calibration</b> Zeroing of sensor B was not successful.
3	<b>Sensor C Calibration</b> Zeroing of sensor C was not successful.
4	<b>Sensor D Calibration</b> Zeroing of sensor D was not successful.
5 to 14	Not used
15	Bit 15 will never be used.

## Use of Status Reporting System

For an efficient use of the status reporting system, the information it contains has to be transferred to the controller and further processed. There are various methods which are described in the following.



## Service Request, Use of the Hierarchical Structure

Under certain conditions, the device may send a service request (SRQ) to the controller. This service request usually causes an interrupt at the controller to which the controller program can respond by suitable actions. As shown in Fig. 6-11, an SRQ will always be triggered if one or several of the bits 2, 3, 4, 5 or 7 have been set in the Status Byte Register and enabled in the SRE. Each of these bits combines the information from another register, from the error queue or the output buffer. If the ENABLE registers of the status registers are set accordingly, any bit in any status register will be able to trigger an SRQ. To utilize the possibilities of the service request, all bits in the enable registers SRE and ESE should be set to "1".

**Examples** (see also Fig. 6-11):

Use the \*OPC command to generate an SRQ:

- Set bit 0 (operation complete) in the ESE.
- Set bit 5 (ESB) in the SRE.
- The device generates an SRQ upon completion of its settings.

Informing the controller by an SRQ that a measurement has been completed:

- Set bit 7 (summary bit of Status Operation Register) in the SRE.
- Set bit 4 (measuring) in the ENABLE register of the Status Operation Register.
- Set bit 4 in the NTRansition register of the Status Operation Register to ensure that the transition of measuring bit 4 from 1 to 0 (end of measurement) is also recorded in the EVENT register.
- The device generates an SRQ when the measurement is completed.

The SRQ is the only way for the device to become active of its own. Each controller program should set the device such that a service request is triggered in case of malfunctions. The program should respond accordingly to the service request.

## Serial Poll

Like the \*STB? command, the serial poll is used to query the status byte of a device. Querying is implemented by interface messages, however, and is therefore much quicker. The serial poll method has already been defined in the IEEE 488.1 standard, and used to be the only standard method of querying the Status Byte Register. This method also works with devices that conform neither to SCPI nor to IEEE 488.2. Serial poll is mainly used to obtain a quick overview of the device status of several devices connected to the IEC/IEEE bus.

## Parallel Poll

In case of a parallel poll, up to eight devices are simultaneously requested by the controller to transmit one bit of information on the data line, i.e. to set the data line assigned to each device to logical 0 or 1. Analogously to the SRE register, which determines the conditions for generating an SRQ, a Parallel Poll Enable Register (PPE) is available which is ANDed bit-by-bit with the STB (taking into account bit 6). The results are ORed and the result is then sent (possibly in inverted format) to the controller as a response to a parallel poll. The result can also be read without a parallel poll by the query \*I ST?.

The parallel poll mode is mainly used to quickly find out which of the many devices connected to the IEC/IEEE bus caused an SRQ. For this purpose, SRE and PPE must be set to the same value.

## Queries

Each part of a status register can be read out by queries. The queries are specified in the description of the SCPI commands (command system STATus). The queries always yield a number representing the bit pattern of the queried register. This number is evaluated by the controller program.

Queries are mainly used after an SRQ to obtain detailed information about the cause of the SRQ.

## Error Queue Query

Each error in the device causes an entry in the error queue. The entries in the error queue are error messages in plain text. If a sensor is connected, sensor-specific errors can be seen via manual control in the menu File→Error List or in remote control via "Error List...". Usually, the error queue is read with the SCPI query `SYSTem:ERRor?`. Each `SYSTem:ERRor?` query is answered by an entry from the error queue. If there are no more error messages in the error queue, 0 = "No error" is returned by the device.

The error queue should be queried in the controller program after each SRQ since the queue entries provide a more precise description of the error cause than the status registers. In particular, in the test phase of a controller program the error queue should be queried at regular intervals since it also registers faulty commands from the controller to the device.

## Initialization of the SCPI Status Registers

The commands `*RST`, `*DCL` and `SYSTEM:PRESet` as well as powering on the device also affect the status reporting system. Table 6-30 contains the various commands and events causing a reset of the status reporting system. None of the commands, with the exception of `*RST` and `SYSTEM:PRESet`, affects the functional device settings. In particular, `DCL` does not clear the device settings.

Table 6-30: Initialization of device status

Effect	Power On		DCL, SDC (Device Clear, Selected Device Clear)	*RST or SYSTEM:PRESet	STATus:PRESet	*CLS
	Power-On- Status Clear (*PSC)					
	0	1				
Clear STB (Status Byte) and ESR (Standard Event Status Register)	--	yes	--	--	--	yes
Clear SRE (Service Request Enable) and ESE (Standard Event Status Enable)	--	yes	--	--	--	--
Clear PPE (Parallel Poll Enable)	--	yes	--	--	--	--
Clear EVENT register	--	yes	--	--	--	yes
Clear ENABLE register of all OPERATION and QUESTIONABLE registers	--	yes	--	--	yes	--
Fill PTRansition register with "1", delete NTRansition register	--	yes	--	--	yes	--
Clear error/event queue	yes	yes	--	--	--	yes
Clear output queue	yes	yes	yes	1)	1)	1)
Stop command processing (parser) and clear input queue	yes	yes	yes	--	--	--

1) Any command sent to a non-empty output queue causes the error -410, "Query interrupted".

**SYSTEM**

With the aid of the SYSTem system, administrative device settings can be made and queried. This includes:

- list of error messages
- IEC/IEEE-bus address
- resetting the R&S NRP
- setting the date and time
- audible signals
- version numbers of hardware and software
- setting the system speed

Table 6-31: Commands of the SENSE system

Command	Parameter	Unit	Remark
SYSTem			Query only
:BEEPer			
[:IMMediate]	-		No query
:NOTify			
:OVERload[?]	ON   OFF	-	
:KEY[?]	ON   OFF	-	
:STOP	-	-	No query
:TIME	<NRf>	S	No query
:COMMunicate			
:GPIB			
[:SELF]:ADDRESS	0..30		No query
:DATE[?]	<year>, <month>, <day>		
:INFO?	[<string >]		Query only
:ERRor?	-		Query only
:KEY	<NR1>   character_value		No query
:PRESet	-		No query
:SENSor[1..4]			
:INFO?	[<string >]		Query only
:RESet	-		No query
:TEST?	-	-	Query only
:SPEed	NORMal   FAST		No query
:STANdard			
:CATalog?	-	-	No query
:PRESet	<string>	-	No query
:PWSettings[?]	ON OFF	-	
:TRIGger:SOURce[?]	INT EXT	-	
:TIME[?]	<hour>, <minute>, <second>		
:VERSion?	-		Query only

**SYSTem:BEEPer[:IMMediate]**

Generates an audible signal via the built-in loudspeaker. The duration of the signal is set with SYST:BEEP:TIME. Frequency and volume cannot be changed. The signal is only output if it is not switched off with SYS:BEEP:STAT OFF.

**SYSTem:BEEPer:NOTify:OVERload[?] ON | OFF**

Determines if the R&S NRP shall emit an acoustic signal when the power at a sensor exceeds the power limit.

\*RST-Wert: OFF

**SYSTem:BEEPer:NOTify:KEY[?] ON | OFF**

Enables (ON) or disables (OFF) acoustic key clicks, respectively.

**\*RST-Wert:** OFF

**SYSTem:BEEPer:STOP**

Stops the output of an audible signal.

**SYSTem:BEEPer:TIME <NRf>**

Sets the length in milliseconds of the audible signal output with `SYS:BEEP`.

**Value range:** 1..60

**Unit:** S

**\*RST value:** This setting is not changed by \*RST.

**SYSTem:COMMunicate:GPIB[:SELF]:ADDRESS <NR1>**

Sets the address with which the R&S NRP can be addressed via the IEC/IEEE bus. The address is factory-set to 20 and is not changed by a reset.

**Value range:** 0..30

**\*RST value:** This setting is not changed by \*RST.

**SYSTem:DATE[?] <year>, <month>, <day>**

Parameter	Value range
<year>	2000 ... 2100
<month>	1 (January) ... 12 (December)
<day>	1 ... 31

Sets the date. Since the R&S NRP has no battery-backed clock, the date has to be reset if the clock was not set after the last power-on of the R&S NRP.

**\*RST value:** This setting is not changed by \*RST.

**SYSTem:INFO? [<string>]**

Returns information about the system. <string\_value> is used to query a specific information item. If called without parameters, the command returns all available information in the form of a list of strings separated by commas. <string\_value> can have the following values. No difference is made between upper-case and lower-case letters:

<string_value>	Meaning
"Manufacturer "	Manufacturer of device
"Type "	Type (R&S NRP)
"Stock Number "	Order No. of R&S NRP
"Serial "	Serial number
"HWVersion"	Hardware version
"SW Build"	Firmware version
"BootloadVer "	Version of boot loader
"KeybCtrlVer "	Version of keyboard controller
"Options"	Installed options
"MACAddr "	MAC address of the R&S NRP if Ethernet option has been installed
"RAMSize "	RAM size
"ROMSize "	ROM size
"CPUClock "	Clock frequency of processor
"CPLDVersion "	Version of CPLD chip
"PICVersion "	Version of PIC-Chip

**SYSTem:ERRor?**

This query returns error numbers and text from the error/event queue of the R&S NRP. A specific error number with text is entered in the error/event queue for each error that occurs in the R&S NRP. The queue functions according to the FIFO principle. The message entered first in the queue is also output first when a `SYST:ERR?` query is sent. Querying clears the message.

Up to 30 errors can be stored in the error/event queue. If further errors occur, the most recent error is overwritten by the message -350, "Queue overflow".

If the error/event queue is empty, the message 0, "No error" is returned as a response.

The queue is cleared by `*CLS`. It is not changed by `*RST`.

For further information on the error/event queue see section →"[STATus](#)", page 5.1.

**SYSTem:ERRor:EXTended[:STATe][?] <boolean>**

SYST:ERR:EXT ON activates extended error messages (SYST:ERR?). The location of errors in the parsed command strings is also shown.

\*RST-Wert: OFF







**SYSTem:KEY <NR1> | <character\_value>**

This command is used for testing purposes only and simulates a single stroke of an R&S NRP front-panel key.

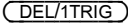
The key to be simulated is described either in plain text (<character\_value>) or by a key code (<NR1>) (→ [Table 6-32](#)).

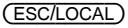
Table 6-32: Valid parameter values for the SYSTem:KEY command.

Simulated front-panel key	<character_value>	<NR1>
Softkey toggle 1 left	SK1L	1
Softkey toggle 1 right	SK1R	2
Softkey toggle 2 left	SK2L	3
Softkey toggle 2 right	SK2R	4
Softkey toggle 3 left	SK3L	5
Softkey toggle 3 right	SK3R	6
Softkey toggle 4 left	SK4L	7
Softkey toggle 4 right	SK4R	8
Softkey toggle 5 left	SK5L	9
Softkey toggle 5 right	SK5R	10
Softkey toggle 6 left	SK6L	11
Softkey toggle 6 right	SK6R	12
	PRESet	13
	ZERO	14
	FREQ	15
	CONTrast	16
	POWer	17

Simulated front-panel key	<character_value>	<NR1>
	DELeTe	18
	ENTer	19
	ESCaPe	20
	UP	21
	DOWN	22
	LEFT	23
	RIGHT	24



**Note:** *The R&S NRP can be switched off via remote control by means of the `SYST:KEY POWER` command.*



**SYSTEM:PRESet**

Resets the R&S NRP to default (\*RST) values. No difference is made between reset and preset values (exceptions: INIT:CONT, SENS:AVER:TCON und SENS:TRAC:AVER:TCON). For preset values see [Table 6-33](#).

Table 6-33: Preset and \*RST value

Command	Preset and *RST value	Remark
CALC[1..8]:FEED[1..2]	"POW:AVER"	The calculate block processes average power values ("Average").
CALC[1..8]:LIM:BEEP	OFF	No audible signal in case of limit violations.
CALC[1..8]:LIM:CLE:AUTO	OFF	No automatic reset of the limit monitoring function when a measurement is started.
CALC[1..8]:LIM:FAIL?	0	Limit violation.
CALC[1..8]:LIM:F00?	0	Number of limit violations is reset.
CALC[1..8]:LIM:UPP:DATA	0 W or 0 DB	Upper limit value for measurements.
CALC[1..8]:LIM:UPP:STAT	OFF	No monitoring function for upper limit value.
CALC[1..8]:LIM:LOW:DATA	0 W or 0 DB	Lower limit value for measurements.
CALC[1..8]:LIM:LOW:STAT	OFF	No monitoring function for lower limit value.
CALC[1..8]:MATH	→ For command description see <a href="#">6.26</a>	The calculate block returns the measured value of the sensor assigned to the primary channel.
CALC[1..8]:REL	0 DBM or 0 DB	-
CALC[1..8]:REL:POW	0 DBM	-
CALC[1..8]:REL:RAT	0 DB	-
CALC[1..8]:REL:STAT	OFF	Measurements are not converted into a reference value.
DISP:ILL	-	Display lighting remains unchanged and can be activated by pressing  .
DISP[1..4]:AVAL	OFF	Dont show additional information on measured values.
DISP:MESS	OFF	Do not display messages.
DISP:MESS:TEXT	-	No change.
DISP:MESS:TYPE	MESS	Messages cannot be confirmed manually.
DISP[1..4]:FORM	DIG	Digital result display.
DISP[1..4]:MET:LOW	-90 DBM -120 DB	Lower limit value for analog result display.
DISP[1..4]:MET:UPP	70 DBM 60 DB	Upper limit value for analog result display.
DISP[1..4]:NAME	" "	Text to be displayed in result window.
DISP[1..4]:RES	0.01	Measurement accuracy and display accuracy.
DISP:SEL	1	Selection of first result window.
DISP:SIZE	NORM	Automatic window sizes.
DISP[1..4]	ON   OFF	A window will automatically be opened for each sensor.
DISP[1..4]:TRAC:LOW	-120 DBM	Lower limit of power axis in Scope mode

Command	Preset and *RST value	Remark
DISP[1..4]:TRAC:UPP	30 DBM	Upper limit of power axis in Scope mode
DISP[1..4]:TSL	1	First timeslot
DISP[1..4]:UPD	NORM	Frequent display updates.
FORM	ASC	Measured data in ASCII format.
FORM:BORD	NORM	"Big-Endian" byte sequence of measured data, if FORM REAL.
MEM:...	-	The settings in the MEMory command system will not be affected.
OUTP:REC1:FEED	"CALC1"	Analog outputs are fed by the first calculate block.
OUTP:REC2:FEED	"CALC2"	Analog outputs are fed by the second calculate block.
OUTP:REC[1..2]:LIM:LOW	-20 DBM or 0 DB	0 V equivalent at analog output.
OUTP:REC[1..2]:LIM:UPP	20 DBM or 10 DB	3 V equivalent at analog output.
OUTP:REC1:STAT	ON	Analog output active.
OUTP:REC2:STAT	OFF	Trigger input active.
OUTP:ROSC	OFF	Test generator is switched off.
OUTP:TTL:ACT	LOW	OUTP:TTL:LVOLT is applied to the TTL output if a limit is violated.
OUTP:TTL:FAIL	HIGH	OUTP:TTL:HVOLT is applied to the TTL output if a limit is violated.
OUTP:TTL:FEED	"CALC1:LIM"	The TTL output is fed by the limit monitoring function of calculate block 1.
OUTP:TTL:HVOLT	3.3 V	High voltage at TTL output
OUTP:TTL:LVOLT	0.0 V	Low voltage at TTL output
SENS[1..4]:AVER	ON   OFF	Depending on sensor.
SENS[1..4]:AVER:COUN	<NR1>	Depending on sensor.
SENS[1..4]:AVER:COUN:AUTO	OFF	Depending on sensor.
SENS[1..4]:AVER:COUN:AUTO:MTIME	<NRf>	Depending on sensor.
SENS[1..4]:AVER:COUN:AUTO:RES	<NRf>	Depending on sensor.
SENS[1..4]:AVER:COUN:AUTO:SLOT	<NR1>	Depending on sensor.
SENS[1..4]:AVER:COUN:AUTO:NSR	<NRf>	Depending on sensor.
SENS[1..4]:AVER:COUN:AUTO:TYPE	RES   NSR	Depending on sensor.
SENS[1..4]:AVER:TCON	MOV REP	(PRES) and SYST: PRES. *RST.
SENS[1..4]:CORR:DCYC	<NRf>	Depending on sensor.
SENS[1..4]:CORR:DCYC:STAT	ON   OFF	Depending on sensor.
SENS[1..4]:CORR:FDOT	-	No change.
SENS[1..4]:CORR:FDOT:STAT	OFF	
SENS[1..4]:CORR:OFFS	<NRf>	Depending on sensor.
SENS[1..4]:CORR:OFFS:STAT	ON   OFF	Depending on sensor.
SENS[1..4]:FREQ	-	No change.
SENS[1..4]:FUNC	"POW:AVG"   "POW:BURS:AVG"   "POW:TSL:AVG"   "XTIM:POW"	Depending on sensor.

Command	Preset and *RST value	Remark
SENS[1..4]:APER	<Nrf>	Depending on sensor.
SENS[1..4]:BUFF:STAT	ON   OFF	Depending on sensor.
SENS[1..4]:BUFF:SIZE	<NR1>	Depending on sensor.
SENS[1..4]:TGAT:OFFS:TIME	<Nrf>	Depending on sensor.
SENS[1..4]:TGAT:SEL	1	
SENS[1..4]:TGAT:TIME	<Nrf>	Depending on sensor.
SENS[1..4]:TSL:COUNT	<NR1>	Depending on sensor.
SENS[1..4]:TSL:WIDTH	<Nrf>	Depending on sensor.
SENS[1..4]:BURS:DTOL	<Nrf>	Depending on sensor.
SENS[1..4]:RANG	1   2   3	Depending on sensor.
SENS[1..4]:RANG:AUT	ON   OFF	Depending on sensor.
SENS[1..4]:RANG:CLEV	<Nrf>	Depending on sensor.
SENS[1..4]:SAMP	FREQ1   FREQ2	Depending on sensor.
SENS[1..4]:SMO:STAT	ON   OFF	Depending on sensor.
SENS[1..4]:AC:RANG	1   2   3	Depending on sensor.
SENS[1..4]:AC:RANG:AUT	ON   OFF	Depending on sensor.
SENS[1..4]:AC:RANG:CLEV	<Nrf>	Depending on sensor.
SENS[1..4]:TRAC:AVER	ON   OFF	Depending on sensor.
SENS[1..4]:TRAC:AVER:COUN	<NR1>	Depending on sensor.
SENS[1..4]:TRAC:AVER:COUN:AUTO	OFF	Depending on sensor.
SENS[1..4]:TRAC:AVER:COUN:AUTO:MTIME	<Nrf>	Depending on sensor.
SENS[1..4]:TRAC:AVER:COUN:AUTO:RES	<Nrf>	Depending on sensor.
SENS[1..4]:TRAC:AVER:COUN:AUTO:POIN	<NR1>	Depending on sensor.
SENS[1..4]:TRAC:AVER:COUN:AUTO:NSR	<Nrf>	Depending on sensor.
SENS[1..4]:TRAC:AVER:COUN:AUTO:TYPE	RES   NSR	Depending on sensor.
SENS[1..4]:TRAC:AVER:TCON	MOV REP	(PRES) and SYST: PRES. *RST.
SENS[1..4]:TRAC:OFFS:TIME	<Nrf>	Depending on sensor.
SENS[1..4]:TRAC:POINT	<NR1>	Depending on sensor.
SENS[1..4]:TRAC:TIME	<Nrf>	Depending on sensor.
SENS[1..4]:TRAC:REAL	ON   OFF	Depending on sensor.
SENS[1..4]:TIMing:EXCL:START	<Nrf>	Depending on sensor.
SENS[1..4]:TIMing:EXCL:STOP	<Nrf>	Depending on sensor.
SYST:BEEP:NOT:KEY	OFF	No key click.
SYST:BEEP:NOT:OVER	OFF	No warning on sensor overload.
SYST:ERR:EXT	OFF	Keine erweiterte Fehlermeldungen für SYST:ERR?
SYST[1..4]:SPEEd	NORM	Depending on sensor.
SYST:STAN:PWS	OFF	Window
SYST:STAN:TRIG:SOUR	INT	Internal triggering.
INIT[1..4 :ALL]:CONT	ON OFF	(PRES) and SYST: PRES. *RST.
INIT[1..4 :ALL]:DIS	OFF	
TRIG:ALL:SYNC	OFF	
TRIG[1..4 :ALL]:ATR	ON   OFF	Depending on sensor.
TRIG[1..4 :ALL]:COUN	<NR1>	Depending on sensor.
TRIG[1..4 :ALL]:DElay	<Nrf>	Depending on sensor.
TRIG[1..4 :ALL]:DEL:AUTO	ON   OFF	Depending on sensor.
TRIG[1..4 :ALL]:HOLD	<Nrf>	Depending on sensor.
TRIG[1..4 :ALL]:HYST	<Nrf>	Depending on sensor.

Command	Preset and *RST value	Remark
TRIG[1..4]:ALL:LEV	<Nrf>	Depending on sensor.
TRIG[1..4]:ALL:SLOP	POS   NEG	Depending on sensor.
TRIG[1..4]:ALL:SOUR	IMM   HOLD   EXT   INT   BUS	Depending on sensor.
UNIT[1..8]:POW	DBM	Logarithmic result scaling.
UNIT[1..8]:POW:RAT	DB	Logarithmic result scaling.

### **SYSTem:SENSor[1..4]:INFO? [<string>]**

Returns information on a sensor. <string> is used to query a specific information item. If called without parameters, the command returns all available information in the form of a list of strings separated by commas. The permissible values for <string> depend on the sensor. For details refer to the documentation of the corresponding sensor.

**Value range:** depending on sensor

### **SYSTem:SENSor[1..4]:RESet**

From the point of view of the R&S NRP base unit, the sensors are stand-alone measuring devices. They communicate with the R&S NRP via a command set complying with SCPI.

SYST:SENS[1..4]:RES prompts the base unit to send an \*RST to the sensor in question. Measurements in progress are interrupted.

### **SYSTem:SENSor[1..4]:TEST?**

Performs a sensor test and returns a list of strings separated by commas. The contents of this test protocol is sensor-specific. For its meaning, please refer to the sensor documentation.

### **SYSTem:SPEEd NORMAl | FAST**

The data processing speed of the R&S NRP can be increased when FAST is selected. The display is switched off and the measured values are no longer displayed since the continuous update of the screen content requires computation time.

**\*RST value:** NORM

### **SYSTem:STANdard:CATalog?**

Returns a list of stored standards containing a series of strings separated by commas. The strings can be used as parameters for the SYSTem:STANdard:PRESet <string> command.

**\*RST value:** none

**SYSTEM:STANDARD:PRESet <string>**

The R&S NRP can be easily configured for measuring standardized signals (e.g. mobile radio standards). For this purpose, the standards listed in the Annex (→ [Standard Configurations](#)) are stored in the R&S NRP. The `SYST:STAN:PREs` command sets the listed parameters and, if desired, also configures front-panel display windows (if `SYST:STAN:PWS ON`).

**\*RST value:** none

**SYSTEM:STANDARD:PWSettings ON | OFF**

If `SYST:STAN:PREs <string>` is used, `SYST:STAN:PWS` (Preserve Window Settings) determines whether the window system is also configured with the calculate blocks (`OFF`) or whether exclusively sensor parameters are set (`ON`).

**\*RST value:** OFF

**SYSTEM:STANDARD:TRIGger:SOURce INT | EXT**

If `SYST:STAN:PREs <string>` is used, this command determines whether the sensors are set to internal (`INT`) or external (`EXT`) triggering.

**\*RST value:** INT

**SYSTEM:TIME[?] <hour>,<minute>,<second>**

Parameter	Value range
<hour>	0 ... 24
<minute>	0 ... 59
<second>	0 ... 59

Sets the time. Since the R&S NRP has no battery-backed clock, the time has to be reset if the clock was not set after the last power-on of the R&S NRP. (→ [SYSTEM:DATE\[?\] <year>,<month>,<day>](#)).

**SYSTEM:VERSion?**

Returns a string that contains the current version number of the SCPI standard.

## TRIGger

The trigger commands are used to configure the timing conditions for the start of a measurement.



**Note:** When the sensors are connected to the R&S NRP, they inform the device about the SENSE and TRIGger commands supported and about the value ranges for parameters. This applies to both numeric and text parameters. For this reason, no fixed ranges are specified with these commands; the ranges can be obtained from the respective sensor manual.

Table 6-34: Commands for setting the trigger system of a sensor

Command	Parameter	Unit	Remark
ABORT[1..4 :ALL]			No query
INITiate[1..4 :ALL]			
:CONTinuous[?]	ON   OFF	-	
:DISable[?]	ON   OFF	-	
[:IMMediate]	-	-	No query
TRIGger:ALL			
:SYNChronize[:STATe][?]	ON   OFF	-	
TRIGger[1..4 :ALL]			
:ATRigger[:STATe][?]	ON   OFF	-	
:COUNT[?]	<int_value>	-	
:DELay[?]	<float_value>	S	
:AUTO[?]	ON   OFF	-	
:HOLDoff[?]	<float_value>	S	
:HYSteresis[?]	<float_value>	DB PCT	
[:IMMediate]	-	-	No query
:LEVel[?]	<float_value>	DBM W	
:SLOPe[?]	POSitive   NEGative	-	
:SOURce[?]	BUS   EXTeRnal   HOLD   IMMEDIATE   INTernal	-	

### ABORT[1..4|:ALL]

Immediately sets the respective sensors to the IDLE state. Measurements in progress are interrupted. If INIT:CONT ON is set, a new measurement is immediately started since the trigger system is not influenced.

### INITiate[1..4|:ALL]:CONTinuous[?] ON | OFF

Selects either single-shot or continuous (free-running) measurement cycles. In the course of a measurement cycle, a sensor passes through the IDLE, INITIATED, WAIT\_FOR\_TRG and MEASURING states before it is again set to the IDLE (INIT:CONT OFF) or the INITIATED (INIT:CONT ON) state. The settings are not changed when control is switched from manual to remote. INIT:CONT ON is set when remote control is switched back to manual control.

**INIT:CONT ON** Continuous measurements are performed. If a measurement is completed, the respective sensors do not return to the IDLE state but are immediately set to INITIATED and then to WAIT\_FOR\_TRG.

**INIT:CONT OFF** A measurement cycle is only performed once. After completion, the sensors remain in the IDLE state. INIT:CONT OFF has no effect when the sensor is already in the IDLE state. A measurement in progress is completed.

**\*RST-Wert:** (PRES) and SYST:PRES: ON  
 \*RST: OFF

**INITiate[1..4|:ALL]:DISable[?] ON | OFF**

This command prevents the execution of the `INIT:IMM` command for one or more sensors. It can thus suppress the start of a measurement for specific sensors if the `INIT:ALL:IMM` command is used.

**\*RST value:** OFF

**INITiate[1..4|:ALL][:IMMediate][?]**

This command starts a single-shot measurement. The respective sensor goes to the INITIATED state. The command is completely executed when the sensor returns to the IDLE state. The command is ignored when the sensor is not in the IDLE state or when continuous measurements are selected (`INIT:CONT ON`). The command is only fully executed when the measurement is completed and the trigger system has again reached the IDLE state. Besides `CAL:ZERO:AUTO INIT` is the only remote control command that permits overlapping execution. Other commands can be received and processed while the command is being executed.



**Note:** `INIT:IMM` invalidates all previous measuring results. A `FETCh?` command following `INIT` will thus always return a new measurement result.

#### Error messages:

28 "Sensor not idle": The sensor is not in the IDLE state.

**TRIGger:ALL:SYNChronize[:STATE][?] ON | OFF**

Using this command one can assure, that measurements with externally triggered sensors start synchronously. As the initiation of measurements in the sensors is serialised in the R&S NRP it is possible that a sensor is triggered before another sensor is initiated (if synchronisation is off). Sensors to be synchronised are required to have the same `TRIG:SLOP` setting, otherwise a SCPI error -221, "Settings conflict" occurs on `TRIG:ALL:SYNC ON`.

#### Example (synchronised measurement with 2 heads):

```
*RST
TRIG:ALL:SLOP POS
TRIG:ALL:SOUR EXT
TRIG:ALL:SYNC ON
INIT:ALL
FETCh1?; FETCh2?
```

**\*RST-Value:** OFF

**TRIGger[1..4|:ALL]:ATRigger[:STATE][?] ON | OFF**

When `TRIG:ATR` is set to ON, the `WAIT_FOR_TRG` state is automatically exited when no trigger event occurs within a period that corresponds to the reciprocal of the display update rate.

**\*RST value:** depending on sensor

**TRIGger[1..4]:ALL:COUNT[?] <int\_value>**

Sets the number of measurement cycles to be performed when the measurement is started with `INIT`.

**Unit:** 1

**Value range:** depending on sensor

**\*RST value:** depending on sensor

**TRIGger[1..4]:ALL:DElay[?] <float\_value>**

Defines the delay between the trigger event and the beginning of the actual measurement (integration).

**Unit:** s

**Value range:** depending on sensor

**\*RST value:** depending on sensor

**TRIGger[1..4]:ALL:DElay:AUTO[?] ON | OFF**

`TRIG:DEL:AUTO ON` ensures by means of an automatically determined delay that a measurement is started only after the sensor has settled. This is important when thermal sensors are used. The automatically determined delay is ignored when a longer period was set with `TRIG[1..4]:DEL`.

**\*RST value:** depending on sensor

**TRIGger[1..4]:ALL:HOLDoFF[?] <float\_value>**

Defines a period after a trigger event within which all further trigger events are ignored.

**Unit:** s

**Value range:** depending on sensor

**\*RST value:** depending on sensor

**TRIGger[1..4]:ALL:HYSteresis[?] <float\_value>**

This command is used to specify how far the signal level has to drop below the trigger level before a new signal edge can be detected as a trigger event. Thus, this command can be used to eliminate the effects of noise in the signal on the edge detector of the trigger system.

**Unit:** DB | PCT

**Default unit:** DB

**Value range:** depending on sensor

**\*RST value:** depending on sensor



**TRIGger[1..4]:ALL[:IMMediate]**

Performs triggering and ensures that the sensor directly changes from the WAIT\_FOR\_TRG state to the MEASURING state irrespective of the selected trigger source (TRIG:SOUR). A trigger delay set with TRIG:DEL is ignored but not the automatic delay determined when TRIG:DEL:AUTO:ON is set. When the trigger source is HOLD, a measurement can only be started with TRIG.

Error messages:

-211 **"Trigger ignored"**: The sensor is not in the WAIT\_FOR\_TRG state.

**TRIGger[1..4]:ALL:LEVel[?] <float\_value>**

Determines the power a trigger signal must exceed (TRIG:SLOP POS) or fall short of (TRIG:SLOP NEG) before a trigger event is detected. This setting is only used for the trigger signal source (TRIG:SOUR) INTernal.

**Unit:** DBM | W

**Default unit:** DBM

**Value range:** depending on sensor

**\*RST value:** depending on sensor

**TRIGger[1..4]:ALL:SLOPe[?] POSitive | NEGative**

This command determines whether the rising (POSitive) or the falling (NEGative) edge of the signal is used for triggering.

**\*RST value:** depending on sensor

**TRIGger[1..4|:ALL]:SOURce[?]**  
**BUS | EXTernal | HOLD | IMMEDIATE | INTernal**

Sets the trigger signal source for the WAIT\_FOR\_TRG state.

**BUS** The trigger event is initiated by TRIG:IMM or \*TRG. In this case, the other trigger setting are meaningless.

**EXTernal** Triggering is performed with an external signal applied to the trigger connector. The TRIG:SLOP command determines whether the rising or the falling edge of the signal is to be used for triggering. Waiting for a trigger event can be skipped by TRIG:IMM.

**IMMEDIATE** The sensor does not remain in the WAIT\_FOR\_TRG state but immediately changes to the MEASURING state.

**HOLD** A measurement can only be triggered when the command TRIG:IMM is executed.

**INTernal** The sensor determines the trigger time by means of the signal to be measured. When this signal exceeds (TRIG:SLOP POS) or fall short of (TRIG:SLOP NEG) the power set by TRIG:LEV, the measurement is started after the time set by TRIG:DEL. Similar to TRIG:SOUR EXT, waiting for a trigger event can also be skipped by TRIG:IMM.

**\*RST value:** depending on sensor

## UNIT

Table 6-35: Commands of the UNIT system

Command	Parameter	Unit	Remark
UNIT[1..8] :POWER[?]	DBM   W	-	
:RATio[?]	DB   PCT	-	

**UNIT[1..8]:POWER[?] DBM | W | DBUV**

Selects the output unit for the measured power values. This setting also determines the unit for the parameters of the following commands:

- CALC:REL
- CALC:LIM:UPP
- CALC:LIM:LOW
- DISP:MET:UPP
- DISP:MET:LOW
- OUTP:REC:LIM:LOW
- OUTP:REC:LIM:UPP

**\*RST value:** DBM

**UNIT[1..8]:POWER:RATio[?] DB | DPCT | O**

Selects the output unit for the measured power ratio values. This setting also determines the unit for the parameters of the following commands:

- CALC:REL
- CALC:LIM:UPP
- CALC:LIM:LOW
- DISP:MET:UPP
- DISP:MET:LOW
- OUTP:REC:LIM:LOW
- OUTP:REC:LIM:UPP

**\*RST value:** DB

**Error messages:** If the compute function of the associated calculate block is :SWR, :RLOSs or :REFlection, then the unit cannot be changed and error message 26,"State not supported", is output.

## List of Remote Control Commands

The R&S NRP supports remote control commands to the SCPI 1999.0 standard.

Command	Page
<b>High-level measurement commands</b>	
CONFigure[1..8]?	<a href="#">6.11</a>
CONFigure[1..8][:SCALar][:POWer][:AVG]	<a href="#">6.11</a>
CONFigure[1..8][:SCALar][:POWer][:AVG]:RELative	<a href="#">6.11</a>
CONFigure[1..8][:SCALar][:POWer][:AVG]:DIFference	<a href="#">6.11</a>
CONFigure[1..8][:SCALar][:POWer][:AVG]:DIFference:RELative	<a href="#">6.11</a>
CONFigure[1..8][:SCALar][:POWer][:AVG]:SUM	<a href="#">6.11</a>
CONFigure[1..8][:SCALar][:POWer][:AVG]:SUM:RELative	<a href="#">6.11</a>
CONFigure[1..8][:SCALar][:POWer][:AVG]:RATio	<a href="#">6.11</a>
CONFigure[1..8][:SCALar][:POWer][:AVG]:RATio:RELative	<a href="#">6.11</a>
CONFigure[1..8][:SCALar][:POWer][:AVG]:SWR	<a href="#">6.11</a>
CONFigure[1..8][:SCALar][:POWer][:AVG]:RLOSS	<a href="#">6.11</a>
CONFigure[1..8][:SCALar][:POWer][:AVG]:REFlection	<a href="#">6.11</a>
CONFigure[1..8][:SCALar][:POWer]:TSLot[:AVG]	<a href="#">6.11</a>
CONFigure[1..8][:SCALar][:POWer]:TSLot[:AVG]:RELative	<a href="#">6.11</a>
CONFigure[1..8][:SCALar][:POWer]:TSLot[:AVG]:DIFference	<a href="#">6.11</a>
CONFigure[1..8][:SCALar][:POWer]:TSLot[:AVG]:DIFference:RELative	<a href="#">6.11</a>
CONFigure[1..8][:SCALar][:POWer]:TSLot[:AVG]:SUM	<a href="#">6.11</a>
CONFigure[1..8][:SCALar][:POWer]:TSLot[:AVG]:SUM:RELative	<a href="#">6.11</a>
CONFigure[1..8][:SCALar][:POWer]:TSLot[:AVG]:RATio	<a href="#">6.11</a>
CONFigure[1..8][:SCALar][:POWer]:TSLot[:AVG]:RATio:RELative	<a href="#">6.11</a>
CONFigure[1..8][:SCALar][:POWer]:TSLot[:AVG]:SWR	<a href="#">6.11</a>
CONFigure[1..8][:SCALar][:POWer]:TSLot[:AVG]:RLOSS	<a href="#">6.11</a>
CONFigure[1..8][:SCALar][:POWer]:TSLot[:AVG]:REFlection	<a href="#">6.11</a>
CONFigure[1..8][:SCALar][:POWer]:BURSt[:AVG]	<a href="#">6.11</a>
CONFigure[1..8][:SCALar][:POWer]:BURSt[:AVG]:RELative	<a href="#">6.11</a>

CONFigure[1..8][:SCALar][:POWer]:BURSt[:AVG]:DIFFerence	6.11
CONFigure[1..8][:SCALar][:POWer]:BURSt[:AVG]:DIFFerence:RELative	6.11
CONFigure[1..8][:SCALar][:POWer]:BURSt[:AVG]:SUM	6.11
CONFigure[1..8][:SCALar][:POWer]:BURSt[:AVG]:SUM:RELative	6.11
CONFigure[1..8][:SCALar][:POWer]:BURSt[:AVG]:RATio	6.11
CONFigure[1..8][:SCALar][:POWer]:BURSt[:AVG]:RATio:RELative	6.11
CONFigure[1..8][:SCALar][:POWer]:BURSt[:AVG]:SWR	6.11
CONFigure[1..8][:SCALar][:POWer]:BURSt[:AVG]:RLOSS	6.11
CONFigure[1..8][:SCALar][:POWer]:BURSt[:AVG]:REFLectioN	6.11
CONFigure[1..8]:ARRAy[:POWer][:AVG]	6.11
CONFigure[1..8]:ARRAy[:POWer][:AVG]:RELative	6.11
CONFigure[1..8]:ARRAy[:POWer][:AVG]:DIFFerence	6.11
CONFigure[1..8]:ARRAy[:POWer][:AVG]:DIFFerence:RELative	6.11
CONFigure[1..8]:ARRAy[:POWer][:AVG]:SUM	6.11
CONFigure[1..8]:ARRAy[:POWer][:AVG]:SUM:RELative	6.11
CONFigure[1..8]:ARRAy[:POWer][:AVG]:RATio	6.11
CONFigure[1..8]:ARRAy[:POWer][:AVG]:RATio:RELative	6.11
CONFigure[1..8]:ARRAy[:POWer][:AVG]:SWR	6.11
CONFigure[1..8]:ARRAy[:POWer][:AVG]:RLOSS	6.11
CONFigure[1..8]:ARRAy[:POWer][:AVG]:REFLectioN	6.11
CONFigure[1..8]:XTIME[:POWer]	6.11
FETCh[1..8]?	6.11
FETCh[1..8][:SCALar][:POWer][:AVG]	6.11
FETCh[1..8][:SCALar][:POWer][:AVG]:RELative	6.11
FETCh[1..8][:SCALar][:POWer][:AVG]:DIFFerence	6.11
FETCh[1..8][:SCALar][:POWer][:AVG]:DIFFerence:RELative	6.11
FETCh[1..8][:SCALar][:POWer][:AVG]:SUM	6.11
FETCh[1..8][:SCALar][:POWer][:AVG]:SUM:RELative	6.11
FETCh[1..8][:SCALar][:POWer][:AVG]:RATio	6.11
FETCh[1..8][:SCALar][:POWer][:AVG]:RATio:RELative	6.11

FETCh[1..8][:SCALar][:POWer][:AVG]:SWR	6.11
FETCh[1..8][:SCALar][:POWer][:AVG]:RLOSS	6.11
FETCh[1..8][:SCALar][:POWer][:AVG]:REFLECTION	6.11
FETCh[1..8][:SCALar][:POWer]:TSLot[:AVG]	6.11
FETCh[1..8][:SCALar][:POWer]:TSLot[:AVG]:RELATIVE	6.11
FETCh[1..8][:SCALar][:POWer]:TSLot[:AVG]:DIFFERENCE	6.11
FETCh[1..8][:SCALar][:POWer]:TSLot[:AVG]:DIFFERENCE:RELATIVE	6.11
FETCh[1..8][:SCALar][:POWer]:TSLot[:AVG]:SUM	6.11
FETCh[1..8][:SCALar][:POWer]:TSLot[:AVG]:SUM:RELATIVE	6.11
FETCh[1..8][:SCALar][:POWer]:TSLot[:AVG]:RATIO	6.11
FETCh[1..8][:SCALar][:POWer]:TSLot[:AVG]:RATIO:RELATIVE	6.11
FETCh[1..8][:SCALar][:POWer]:TSLot[:AVG]:SWR	6.11
FETCh[1..8][:SCALar][:POWer]:TSLot[:AVG]:RLOSS	6.11
FETCh[1..8][:SCALar][:POWer]:TSLot[:AVG]:REFLECTION	6.11
FETCh[1..8][:SCALar][:POWer]:BURSt[:AVG]	6.11
FETCh[1..8][:SCALar][:POWer]:BURSt[:AVG]:RELATIVE	6.11
FETCh[1..8][:SCALar][:POWer]:BURSt[:AVG]:DIFFERENCE	6.11
FETCh[1..8][:SCALar][:POWer]:BURSt[:AVG]:DIFFERENCE:RELATIVE	6.11
FETCh[1..8][:SCALar][:POWer]:BURSt[:AVG]:SUM	6.11
FETCh[1..8][:SCALar][:POWer]:BURSt[:AVG]:SUM:RELATIVE	6.11
FETCh[1..8][:SCALar][:POWer]:BURSt[:AVG]:RATIO	6.11
FETCh[1..8][:SCALar][:POWer]:BURSt[:AVG]:RATIO:RELATIVE	6.11
FETCh[1..8][:SCALar][:POWer]:BURSt[:AVG]:SWR	6.11
FETCh[1..8][:SCALar][:POWer]:BURSt[:AVG]:RLOSS	6.11
FETCh[1..8][:SCALar][:POWer]:BURSt[:AVG]:REFLECTION	6.11
FETCh[1..8]:ARRay[:POWer][:AVG]	6.11
FETCh[1..8]:ARRay[:POWer][:AVG]:RELATIVE	6.11
FETCh[1..8]:ARRay[:POWer][:AVG]:DIFFERENCE	6.11
FETCh[1..8]:ARRay[:POWer][:AVG]:DIFFERENCE:RELATIVE	6.11
FETCh[1..8]:ARRay[:POWer][:AVG]:SUM	6.11

FETCh[1..8]:ARRAy[:POWer][:AVG]:SUM:RELAtive	6.11
FETCh[1..8]:ARRAy[:POWer][:AVG]:RATio	6.11
FETCh[1..8]:ARRAy[:POWer][:AVG]:RATio:RELAtive	6.11
FETCh[1..8]:ARRAy[:POWer][:AVG]:SWR	6.11
FETCh[1..8]:ARRAy[:POWer][:AVG]:RLOSS	6.11
FETCh[1..8]:ARRAy[:POWer][:AVG]:REFLectioN	6.11
FETCh[1..8]:XTIME[:POWer]	6.11
READ[1..8]?	6.11
READ[1..8][:SCALar][:POWer][:AVG]	6.11
READ[1..8][:SCALar][:POWer][:AVG]:RELAtive	6.11
READ[1..8][:SCALar][:POWer][:AVG]:DIFFerence	6.11
READ[1..8][:SCALar][:POWer][:AVG]:DIFFerence:RELAtive	6.11
READ[1..8][:SCALar][:POWer][:AVG]:SUM	6.11
READ[1..8][:SCALar][:POWer][:AVG]:SUM:RELAtive	6.11
READ[1..8][:SCALar][:POWer][:AVG]:RATio	6.11
READ[1..8][:SCALar][:POWer][:AVG]:RATio:RELAtive	6.11
READ[1..8][:SCALar][:POWer][:AVG]:SWR	6.11
READ[1..8][:SCALar][:POWer][:AVG]:RLOSS	6.11
READ[1..8][:SCALar][:POWer][:AVG]:REFLectioN	6.11
READ[1..8][:SCALar][:POWer]:TSLot[:AVG]	6.11
READ[1..8][:SCALar][:POWer]:TSLot[:AVG]:RELAtive	6.11
READ[1..8][:SCALar][:POWer]:TSLot[:AVG]:DIFFerence	6.11
READ[1..8][:SCALar][:POWer]:TSLot[:AVG]:DIFFerence:RELAtive	6.11
READ[1..8][:SCALar][:POWer]:TSLot[:AVG]:SUM	6.11
READ[1..8][:SCALar][:POWer]:TSLot[:AVG]:SUM:RELAtive	6.11
READ[1..8][:SCALar][:POWer]:TSLot[:AVG]:RATio	6.11
READ[1..8][:SCALar][:POWer]:TSLot[:AVG]:RATio:RELAtive	6.11
READ[1..8][:SCALar][:POWer]:TSLot[:AVG]:SWR	6.11
READ[1..8][:SCALar][:POWer]:TSLot[:AVG]:RLOSS	6.11
READ[1..8][:SCALar][:POWer]:TSLot[:AVG]:REFLectioN	6.11

READ[1..8][:SCALar][:POWer]:BURSt[:AVG]	6.11
READ[1..8][:SCALar][:POWer]:BURSt[:AVG]:RELative	6.11
READ[1..8][:SCALar][:POWer]:BURSt[:AVG]:DIFFeRence	6.11
READ[1..8][:SCALar][:POWer]:BURSt[:AVG]:DIFFeRence:RELative	6.11
READ[1..8][:SCALar][:POWer]:BURSt[:AVG]:SUM	6.11
READ[1..8][:SCALar][:POWer]:BURSt[:AVG]:SUM:RELative	6.11
READ[1..8][:SCALar][:POWer]:BURSt[:AVG]:RATio	6.11
READ[1..8][:SCALar][:POWer]:BURSt[:AVG]:RATio:RELative	6.11
READ[1..8][:SCALar][:POWer]:BURSt[:AVG]:SWR	6.11
READ[1..8][:SCALar][:POWer]:BURSt[:AVG]:RLOSs	6.11
READ[1..8][:SCALar][:POWer]:BURSt[:AVG]:REFlection	6.11
READ[1..8]:ARRAy[:POWer][:AVG]	6.11
READ[1..8]:ARRAy[:POWer][:AVG]:RELative	6.11
READ[1..8]:ARRAy[:POWer][:AVG]:DIFFeRence	6.11
READ[1..8]:ARRAy[:POWer][:AVG]:DIFFeRence:RELative	6.11
READ[1..8]:ARRAy[:POWer][:AVG]:SUM	6.11
READ[1..8]:ARRAy[:POWer][:AVG]:SUM:RELative	6.11
READ[1..8]:ARRAy[:POWer][:AVG]:RATio	6.11
READ[1..8]:ARRAy[:POWer][:AVG]:RATio:RELative	6.11
READ[1..8]:XTIME[:POWer]	6.11
MEASure[1..8]?	6.11
MEASure[1..8][:SCALar][:POWer][:AVG]	6.11
MEASure[1..8][:SCALar][:POWer][:AVG]:RELative	6.11
MEASure[1..8][:SCALar][:POWer][:AVG]:DIFFeRence	6.11
MEASure[1..8][:SCALar][:POWer][:AVG]:DIFFeRence:RELative	6.11
MEASure[1..8][:SCALar][:POWer][:AVG]:SUM	6.11
MEASure[1..8][:SCALar][:POWer][:AVG]:SUM:RELative	6.11
MEASure[1..8][:SCALar][:POWer][:AVG]:RATio	6.11
MEASure[1..8][:SCALar][:POWer][:AVG]:RATio:RELative	6.11
MEASure[1..8][:SCALar][:POWer][:AVG]:SWR	6.11



MEASure[1..8][:SCALar][:POWer][:AVG]:RLOSs	6.11
MEASure[1..8][:SCALar][:POWer][:AVG]:REFLection	6.11
MEASure[1..8][:SCALar][:POWer]:TSLot[:AVG]	6.11
MEASure[1..8][:SCALar][:POWer]:TSLot[:AVG]:RELative	6.11
MEASure[1..8][:SCALar][:POWer]:TSLot[:AVG]:DIFFerence	6.11
MEASure[1..8][:SCALar][:POWer]:TSLot[:AVG]:DIFFerence:RELative	6.11
MEASure[1..8][:SCALar][:POWer]:TSLot[:AVG]:RATio	6.11
MEASure[1..8][:SCALar][:POWer]:TSLot[:AVG]:RATio:RELative	6.11
MEASure[1..8][:SCALar][:POWer]:BURSt[:AVG]	6.11
MEASure[1..8][:SCALar][:POWer]:BURSt[:AVG]:RELative	6.11
MEASure[1..8][:SCALar][:POWer]:BURSt[:AVG]:DIFFerence	6.11
MEASure[1..8][:SCALar][:POWer]:BURSt[:AVG]:DIFFerence:RELative	6.11
MEASure[1..8][:SCALar][:POWer]:BURSt[:AVG]:RATio	6.11
MEASure[1..8][:SCALar][:POWer]:BURSt[:AVG]:RATio:RELative	6.11
MEASure[1..8]:SWR	6.11
MEASure[1..8]:REFLection	6.11
MEASure[1..8]:RLOSs	6.11
MEASure[1..8]:ARRay[:POWer][:AVG]	6.11
MEASure[1..8]:ARRay[:POWer][:AVG]:RELative	6.11
MEASure[1..8]:ARRay[:POWer][:AVG]:DIFFerence	6.11
MEASure[1..8]:ARRay[:POWer][:AVG]:DIFFerence:RELative	6.11
MEASure[1..8]:ARRay[:POWer][:AVG]:RATio	6.11
MEASure[1..8]:ARRay[:POWer][:AVG]:RATio:RELative	6.11
MEASure[1..8]:XTIME[:POWer]	6.11
<b>CALCulate commands</b>	
CALCulate[1..8]:DATA?	6.21
CALCulate[1..8]:MINimum:DATA?	6.21
CALCulate[1..8]:MAXimum:DATA?	6.21
CALCulate[1..8]:PTPeak:DATA?	6.21
CALCulate[1..8]:EXTRemes:RESet	6.22

CALCulate[1..8]:LIMit:BEEP	6.22
CALCulate[1..8]:LIMit:CLEar[:IMMediate]	6.23
CALCulate[1..8]:LIMit:FAIL?	6.23
CALCulate[1..8]:LIMit:FCOunt?	6.24
CALCulate[1..8]:LIMit:UPPer[:DATA][?]	6.24
CALCulate[1..8]:LIMit:UPPer:STATe[?]	6.25
CALCulate[1..8]:LIMit:LOWer[:DATA][?]	6.24
CALCulate[1..8]:LIMit:LOWer:STATe[?]	6.25
CALCulate[1..8]:MATH[:EXPRession][?]	6.26
CALCulate[1..8]:MATH[:EXPRession]:CATalog?	6.27
CALCulate[1..8]:RELative[:MAGNitude][?]	6.27
CALCulate[1..8]:RELative[:MAGNitude]:AUTO[?]	6.28
CALCulate[1..8]:RELative:POWER[:MAGNitude][?]	6.28
CALCulate[1..8]:RELative:RATio[:MAGNitude][?]	6.28
CALCulate[1..8]:RELative:STATe[?]	6.28
<b>CALibration command</b>	
CALibration[1..4]:ZERO:AUTO[?]	6.29
<b>DISPlay command</b>	
DISPlay:ILLumination[?]	6.30
DISPlay:ERRorlist:STATe[?]	6.31
DISPlay:MESSage[:STATe][?]	6.31
DISPlay:MESSage:TEXT:CLEar	6.31
DISPlay:MESSage:TEXT[:DATA]	6.31
DISPlay:MESSage:TYPE	6.31
DISPlay:PIXMap?	6.31
DISPlay:UPDate[?]	6.32
DISPlay[:WINDow][1..4]:AVALue[?]	6.32
DISPlay[:WINDow][1..4]:FORMat[?]	6.32
DISPlay[:WINDow][1..4]:METer :ANALog:AUTO[?]	6.33
DISPlay[:WINDow][1..4]:METer :ANALog:LOWer[?]	6.33

DISPlay[:WINDow][1..4]:METer[:ANALog:UPPer[?]]	6.33
DISPlay[:WINDow][1..4]:NAME[?]	6.34
DISPlay[:WINDow][1..4]:RESolution[?]	6.35
DISPlay[:WINDow][1..4]:SElect[?]	6.36
DISPlay[:WINDow][1..4]:SIZE[?]	6.37
DISPlay[:WINDow][1..4][:STATe][?]	6.35
<b>MEMory commands</b>	
MEMory:CATalog[:ALL]?	6.40
MEMory:CATalog:STATe?	6.40
MEMory:CATalog:TABLE?	6.40
MEMory:CLEar[:NAME]	6.40
MEMory:CLEar:TABLE	6.40
MEMory:FREE[:ALL]?	6.40
MEMory:FREE:STATe?	6.41
MEMory:FREE:TABLE?	6.41
MEMory:NSTATes?	6.41
MEMory:STATe:CATalog?	6.41
MEMory:STATe:DEFine[?]	6.41
MEMory:TABLE:FREQuency[?]	6.41
MEMory:TABLE:FREQuency:POINTs?	6.42
MEMory:TABLE:GAIN[:MAGNitude][?]	6.42
MEMory:TABLE:GAIN[:MAGNitude]:POINTs?	6.42
MEMory:TABLE:MOVE	6.42
MEMory:TABLE:SElect[?]	6.43
<b>OUTPut command</b>	
OUTPut:ROSCillator[:STATe][?]	6.47
<b>SENSe commands</b>	
[SENSe[1..4]]:AVERage[:STATe][?]	6.51
[SENSe[1..4]]:AVERage:COUNT[?]	6.51
[SENSe[1..4]]:AVERage:COUNT:AUTO[?]	6.51

[SENSE[1..4]]:AVERAGE:COUNT:AUTO:MTIME[?]	6.52
[SENSE[1..4]]:AVERAGE:COUNT:AUTO:RESOLUTION[?]	6.52
[SENSE[1..4]]:AVERAGE:COUNT:AUTO:SLOT[?]	6.52
[SENSE[1..4]]:AVERAGE:COUNT:AUTO:NSRATIO[?]	6.53
[SENSE[1..4]]:AVERAGE:COUNT:AUTO:TYPE[?]	6.53
[SENSE[1..4]]:AVERAGE:RESET	6.53
[SENSE[1..4]]:AVERAGE:TCONTROL[?]	6.53
[SENSE[1..4]]:CORRECTION:DCYCLE[:INPUT][:MAGNITUDE][?]	6.54
[SENSE[1..4]]:CORRECTION:DCYCLE:STATE[?]	6.54
[SENSE[1..4]]:CORRECTION:FDOFFSET[:INPUT][:MAGNITUDE]?	6.54
[SENSE[1..4]]:CORRECTION:FDDOT[:SELECT][?]	6.55
[SENSE[1..4]]:CORRECTION:FDDOT:STATE[?]	6.55
[SENSE[1..4]]:CORRECTION:OFFSET[?]	6.54
[SENSE[1..4]]:CORRECTION:OFFSET:STATE	6.54
[SENSE[1..4]]:FREQUENCY[:CW :FIXED][?]	6.55
[SENSE[1..4]]:FUNCTION[:ON][?]	6.56
[SENSE[1..4]]:[POWER][:AVG]:APERTURE[?]	6.57
[SENSE[1..4]]:[POWER][:AVG]:BUFFER:SIZE[?]	6.57
[SENSE[1..4]]:[POWER][:AVG]:BUFFER:STATE[?]	6.57
[SENSE[1..4]]:[POWER]:TSLot:[AVG]:COUNT[?]	6.57
[SENSE[1..4]]:[POWER]:TSLot:[AVG]:WIDTH[?]	6.60
[SENSE[1..4]]:[POWER]:BURST:DTOLERANCE[?]	6.58
[SENSE[1..4]]:[POWER][:AVG]:RANGE[?]	6.57
[SENSE[1..4]]:[POWER][:AVG]:RANGE:AUTO[?]	6.57
[SENSE[1..4]]:[POWER][:AVG]:RANGE:AUTO:CLEVEL[?]	6.57
[SENSE[1..4]]:[POWER][:AVG]:SMOOTHING:STATE[?]	6.58
[SENSE[1..4]]:[POWER][:AVG]:SAMPLING[?]	6.59
[SENSE[1..4]]:SGAMMA[:MAGNITUDE][?]	6.60
[SENSE[1..4]]:SGAMMA:PHASE[?]	6.60
[SENSE[1..4]]:SGAMMA:CORRECTION:STATE[?]	6.60

[SENSE[1..4]]:TRACe:AVERAge[:STATe][?]	6.61
[SENSE[1..4]]:TRACe:AVERAge:COUNT[?]	6.61
[SENSE[1..4]]:TRACe:AVERAge:COUNT:AUTO[?]	6.61
[SENSE[1..4]]:TRACe:AVERAge:COUNT:AUTO:MTIME[?]	6.61
[SENSE[1..4]]:TRACe:AVERAge:COUNT:AUTO:RESolution[?]	6.62
[SENSE[1..4]]:TRACe:AVERAge:COUNT:AUTO:POINT[?]	6.62
[SENSE[1..4]]:TRACe:AVERAge:COUNT:AUTO:NSRatio[?]	6.62
[SENSE[1..4]]:TRACe:AVERAge:COUNT:AUTO:TYPE[?]	6.63
[SENSE[1..4]]:TRACe:AVERAge:TCONTRol[?]	6.63
[SENSE[1..4]]:TRACe:OFFSet:TIME[?]	6.63
[SENSE[1..4]]:TRACe:POINTs[?]	6.63
[SENSE[1..4]]:TRACe:REALtime[?]	6.64
[SENSE[1..4]]:TRACe:TIME[?]	6.64
[SENSE[1..4]]:TIMing:EXCLude:START[?]	6.64
[SENSE[1..4]]:TIMing:EXCLude:STOP[?]	6.64
<b>STATus commands</b>	
STATus:DEVIce[:EVENT]?	6.69
STATus:DEVIce:CONDition?	6.69
STATus:DEVIce:ENABle[?]	6.69
STATus:DEVIce:NTRansition[?]	6.69
STATus:DEVIce:PTRansition[?]	6.69
STATus:OPERation[:EVENT]?	6.69
STATus:OPERation:CONDition?	6.69
STATus:OPERation:ENABle[?]	6.69
STATus:OPERation:NTRansition[?]	6.69
STATus:OPERation:PTRansition[?]	6.69
STATus:OPERation:CALibrating[:SUMMARY][:EVENT]?	6.69
STATus:OPERation:CALibrating[:SUMMARY]:CONDition?	6.69
STATus:OPERation:CALibrating[:SUMMARY]:ENABle[?]	6.69
STATus:OPERation:CALibrating[:SUMMARY]:NTRansition[?]	6.69

STATus:OPERation:CALibrating[:SUMMARY]:PTRansition[?]	6.69
STATus:OPERation:LLFail[:SUMMARY][:EVENT]?	6.69
STATus:OPERation:LLFail[:SUMMARY]:CONDition?	6.69
STATus:OPERation:LLFail[:SUMMARY]:ENABle[?]	6.69
STATus:OPERation:LLFail[:SUMMARY]:NTRansition[?]	6.69
STATus:OPERation:LLFail[:SUMMARY]:PTRansition[?]	6.69
STATus:OPERation:ULFail[:SUMMARY][:EVENT]?	6.69
STATus:OPERation:ULFail[:SUMMARY]:CONDition?	6.69
STATus:OPERation:ULFail[:SUMMARY]:ENABle[?]	6.69
STATus:OPERation:ULFail[:SUMMARY]:NTRansition[?]	6.69
STATus:OPERation:ULFail[:SUMMARY]:PTRansition[?]	6.69
STATus:OPERation:MEASuring[:SUMMARY][:EVENT]?	6.69
STATus:OPERation:MEASuring[:SUMMARY]:CONDition?	6.69
STATus:OPERation:MEASuring[:SUMMARY]:ENABle[?]	6.69
STATus:OPERation:MEASuring[:SUMMARY]:NTRansition[?]	6.69
STATus:OPERation:MEASuring[:SUMMARY]:PTRansition[?]	6.69
STATus:OPERation:SENSe[:SUMMARY][:EVENT]?	6.69
STATus:OPERation:SENSe[:SUMMARY]:CONDition?	6.69
STATus:OPERation:SENSe[:SUMMARY]:ENABle[?]	6.69
STATus:OPERation:SENSe[:SUMMARY]:NTRansition[?]	6.69
STATus:OPERation:SENSe[:SUMMARY]:PTRansition[?]	6.69
STATus:OPERation:TRIGger[:SUMMARY][:EVENT]?	6.69
STATus:OPERation:TRIGger[:SUMMARY]:CONDition?	6.69
STATus:OPERation:TRIGger[:SUMMARY]:ENABle[?]	6.69
STATus:OPERation:TRIGger[:SUMMARY]:NTRansition[?]	6.69
STATus:OPERation:TRIGger[:SUMMARY]:PTRansition[?]	6.69
STATus:QUEStionable[:EVENT]?	6.69
STATus:QUEStionable:CONDition?	6.69
STATus:QUEStionable:ENABle[?]	6.69
STATus:QUEStionable:NTRansition[?]	6.69

STATus:QUESTionable:PTRansition[?]	6.69
STATus:QUESTionable:CALibration[:SUMMARY][:EVENT]?	6.69
STATus:QUESTionable:CALibration[:SUMMARY]:CONDition?	6.69
STATus:QUESTionable:CALibration[:SUMMARY]:ENABle[?]	6.69
STATus:QUESTionable:CALibration[:SUMMARY]:NTRansition[?]	6.69
STATus:QUESTionable:CALibration[:SUMMARY]:PTRansition[?]	6.69
STATus:QUESTionable:POWer[:SUMMARY][:EVENT]?	6.69
STATus:QUESTionable:POWer[:SUMMARY]:CONDition?	6.69
STATus:QUESTionable:POWer[:SUMMARY]:ENABle[?]	6.69
STATus:QUESTionable:POWer[:SUMMARY]:NTRansition[?]	6.69
STATus:QUESTionable:POWer[:SUMMARY]:PTRansition[?]	6.69
STATus:QUESTionable:WINDow[:SUMMARY][:EVENT]?	6.69
STATus:QUESTionable:WINDow[:SUMMARY]:CONDition?	6.69
STATus:QUESTionable:WINDow[:SUMMARY]:ENABle[?]	6.69
STATus:QUESTionable:WINDow[:SUMMARY]:NTRansition[?]	6.69
STATus:QUESTionable:WINDow[:SUMMARY]:PTRansition[?]	6.69
STATus:PRESet	6.69
<b>SYSTEM commands</b>	
SYSTEM:BEEPer[:IMMEDIATE]	6.93
SYSTEM:BEEPer:NOTify:OVERload[?]	6.93
SYSTEM:BEEPer:NOTify:KEY[?]	6.94
SYSTEM:BEEPer:TIME	6.93
SYSTEM:COMMunicate:GPIB[:SELF]:ADDRESS	6.94
SYSTEM:DATE[?]	6.94
SYSTEM:INFO?	6.95
SYSTEM:ERRor?	6.95
SYSTEM:KEY	6.96
SYSTEM:PRESet	6.98
SYSTEM:SENSor[1..4]:INFO?	6.101
SYSTEM:SENSor[1..4]:RESet	6.101

SYSTem:SPEEd	6.101
SYSTem:TIME[?]	6.101
SYSTem:VERSion?	6.102
<b>Trigger system</b>	
ABORT[1..4]:ALL]	6.103
INITiate[1..4]:ALL]:CONTinuous[?]	6.103
INITiate[1..4]:ALL][:IMMediate][?]	6.103
TRIGger:ALL:SYNChronize[:STATe][?]	
TRIGger[1..4]:ALL]:ATRigger[:STATe][?]	6.104
TRIGger[1..4]:ALL]:COUNT[?]	6.105
TRIGger[1..4]:ALL]:DELay[?]	6.105
TRIGger[1..4]:ALL]:DELay[?]:AUTO	6.105
TRIGger[1..4]:ALL]:HOLDoff[?]	6.105
TRIGger[1..4]:ALL]:HYSTeresis[?]	6.105
TRIGger[1..4]:ALL][:IMMediate]	6.106
TRIGger[1..4]:ALL]:LEVel[?]	6.106
TRIGger[1..4]:ALL]:SLOPe[?]	6.106
TRIGger[1..4]:ALL]:SOURce[?]	6.107
<b>UNIT commands</b>	
UNIT[1..8]:POWer[?]	6.108
UNIT[1..8]:RATio[?]	6.108



## Compatibility Information

This section contains information regarding the compatibility of the R&S NRP remote control commands with those of the E4418B and E4419B power meters from Agilent.

The R&S NRP is largely downward-compatible to the above-mentioned devices but offers additional capabilities.

Table 6-36: Compatibility information about remote control commands

E4418B/E4419B command	Compatibility information
*DDT	Is not implemented in the R&S NRP.
CONFigure?	Returns the current configuration. The R&S NRP returns the last setting made with CONFigure, as specified by the SCPI standard.
CALCulate:GAIN	Is not implemented in the R&S NRP.
CALCulate:PHOLD	Is implemented in the R&S NRP and has the same effect as CALC:EXTR:RES.
CALibration :ECONtrol :RCALibration :RFACTor	Is not implemented in the R&S NRP.
DISPlay:ENABle[?]	Is implmented in the R&S NRP and has the same effect as DISPlay:ILLUmination.
DISPlay:SCREen:FORMat [:NUMeric[1] 2]	Is not implemented in the R&S NRP.
INITiate :CONTinuous:SEQUence[1] 2 :IMMEDIATE:SEQUence[1] 2	The :SEQUence node is not implemented in the R&S NRP.
MEMory:TABLE:GAIN	Agilent specifies the values without a unit; the unit PCT (percent) is implicitly assumed. The units DB (dB), DPCT (Δ%) and O (unit 1) can be specified in the R&S NRP. The default unit is DB.
OUTPut:TRIGger:STATE	Is not implemented in the R&S NRP.
SENSe :BANDwidth :AVERage:COUNT:AUTO:SDETECT :DETECTOR:FUNCTion :MRATE :SPEEd :V2P	Is not implemented in the R&S NRP.
SENSe[1 2]:CORRection :CSET[1] CSET2[:SElect] and SENSe[1 2]:CORRection :CSET[1] CSET2:STATE	The R&S NRP does not recognize any tables with frequency-dependent calibration values since the sensors have to be calibrated only once in production. For this reason, there is no compliance with CSET1. Tables with frequency-dependent offset correction values can be defined and addressed via :CSET2 (Agilent and R&S NRP) or :FDOTable (R&S NRP only).
SENSe[1 2]:CORRection:GAIN[1]?	Has the same effect as SENSe[1..2]:CORRection:CFACTor?

SENSE[1 2]:CORRection:GAIN2[?]	Has the same effect as SENSE[1..2]:CORRection:OFFSet[?]. With :GAIN2, no unit may be specified. Unit 1 is valid.
SENSE[1 2]:CORRection:LOSS2[?]	Corresponds to the reciprocal of SENSE[1..2]:CORRection:OFFSet[?]. With :LOSS2, no unit may be specified. Unit 1 is valid.
SENSE[1 2]:CORRection:GAIN3[?]	Has the same effect as SENSE[1..2]:CORRection:DCYClE[?]. With :GAIN3, no unit may be specified. Unit 1 is valid.
SENSE[1 2]:CORRection:GAIN4?	Has the same effect as SENSE[1..2]:CORRection:FDOFFset[:INPut][:MAGNitude]?
SENSE:SWEep:OFFSet:TIME[?]	Is implemented in the R&S NRP and has the same effect as SENSE:TGATe:OFFSet:TIME[?]
SENSE:SWEep:TIME[?]	Is implemented in the R&S NRP and has the same effect as SENSE:TGATe:TIME[?]
SYSTEM :COMMunicate:SERial :HELP:HEADers? :LOCal :REMote :RINterface :RWLock	Is not implemented in the R&S NRP.
TRACe:STATe	Is not implemented in the R&S NRP.
TRACe:DATA?	Is not implemented in the R&S NRP in this form. Data of the Scope mode can only be queried via the high-level commands (FETCh?, REAd?, MEAS?) and CALC:DATA?.
TRACe:UNIT?	The UNIT node is only globally available in the R&S NRP and affects all measurement results (including Scope data) and the unitless command parameters of the commands CALC:LIM:LOW, CALC:LIM:UPP, DISP:MET :ANAL:LOW, DISP:MET :ANAL:UPP, OUTP:REC:LIM:LOW and OUTP:REC:LIM:UPP.
TRIGger[:SEQUence[1] 2]	The R&S NRP does not recognize the:SEQUence header and uses no TRIGger command globally but only on a sensor-by-sensor basis. If TRIGger or SENSE commands are to have a global effect, the:ALL header must be used instead of the numeric suffix.
UNIT:POWer	The R&S NRP recognizes the units W, DBM and DBUV.
UNIT:POWer:RATio	The R&S NRP recognizes the units DB, DPCT and O.
:AC	Agilent recognizes the keyword :AC of some high-level commands and SENSE commands: CONFigure   REAd   MEASure   FETCh [:SCALar][:POWer:AC] :RELative :DIFFerence :DIFFerence:RELative :RATio :RATio:RELative SENSE:POWer:AC:RANGe:AUTO The R&S NRP also recognizes these commands but :AVG should be used instead of :AC since R&S NRP sensors eventually also measure DC components and the designation in the R&S NRP is not used in the sense of SCPI.

## Interfaces

### IEC/IEEE Bus Interface

The R&S NRP is fitted with an IEC/IEEE bus interface as standard. The connector in line with IEEE 488 is located on the rear panel. A controller can be connected to this interface for remote control. A shielded cable is used for the connection.

#### Characteristics of the Interface

- 8-bit parallel data transmission
- Bidirectional data transmission
- Three-wire handshake
- Data transmission rate up to 350 Kbyte/s
- Connection of up to 15 devices
- Max. length of connecting cables: 15 m (length of single cable: 2 m)
- Wired OR links when several devices are connected in parallel.

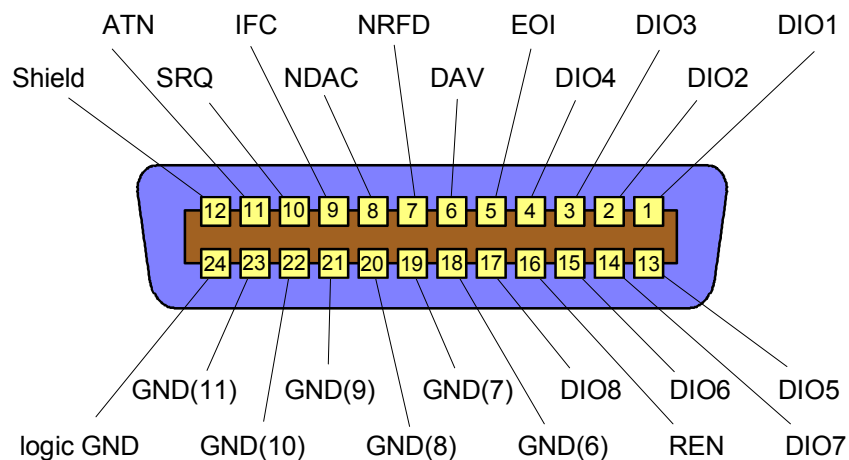

Fig. 6-14: Pin assignment of IEC/IEEE-bus interface

#### Bus Lines

##### 1. Data bus with 8 lines DIO 1 to DIO 8

Transmission is bit-parallel and byte-serial in ASCII/ISO code. DIO 1 is the least-significant and DIO 8 the most-significant bit.

##### 2. Control bus with 5 lines

###### IFC (Interface Clear)

Active LOW resets the interfaces of connected devices to the default state.

**ATN** (Attention)

Active LOW indicates the transmission of interface messages;  
non-active HIGH indicates the transmission of device messages.

**SRQ** (Service Request)

Active LOW enables a device to send a service request to the controller.

**REN** (Remote Enable)

Active LOW allows switchover to the remote control mode.

**EOI** (End or Identify)

together with ATN has two functions:

ATN = HIGH: active LOW marks the end of data transmission.

ATN = LOW: active LOW triggers a parallel poll.

**3. Handshake bus with three lines****DAV** (Data Valid)

Active LOW signals a valid data byte on the data bus.

**NRFD** (Not Ready For Data)

Active LOW signals that one of the connected devices is not ready to accept data.

**NDAC** (Not Data Accepted)

Active LOW until the connected device has accepted the data on the bus.

## Interface Functions

Devices remote-controlled via an IEC/IEEE-bus may be equipped with different interface capabilities. [Table 6-37](#) shows the IEC/IEEE bus capabilities of the R&S NRP.

For coding of the different capabilities see the IEEE488 standard.

Table 6-37: Interface functions of IEC/IEEE bus

IEEE488 Standard Code	Interface capabilities
<b>SH1</b>	Source handshake
<b>AH1</b>	Acceptor handshake
<b>L3</b>	Listener function, Listen-Only mode, unaddressed for MSA and TPAS, recognizes END and EOS.
<b>LE3</b>	Extended Listener function, Listen-Only mode, unaddressed for MSA and TPAS, recognizes END and EOS.
<b>T5</b>	Talker function, capability to respond to serial poll, Talk-Only mode, unaddressed on MLA, sends END or EOS.
<b>TE5</b>	Extended talker function, capability to respond to serial poll, Talk-Only mode, unaddressed for MLA and LPAS, sends END or EOS.
<b>SR1</b>	Service request function
<b>PP1</b>	Remote parallel-poll function
<b>PP2</b>	Local parallel-poll function
<b>RL1</b>	Remote/local switchover function
<b>DC1</b>	Device clear
<b>E2</b>	3-state driver (open-collector driver during parallel poll)
<b>DT1</b>	Device trigger
<b>C0</b>	No controller capabilities

## Interface Messages

Interface messages are transmitted to the device on data lines, where the ATN is set to active LOW. They are used for communication between the controller and the R&S NRP.

## Common Commands

Common commands are in the code range 0x10 to 0x1F. They affect all devices on the bus without any addressing being required.

Table 6-38: Common commands

Command	Effect on device
DCL (Device Clear)	Interrupts processing of received commands and sets the command processing software to a defined initial state. This command does not change the device setting.
IFC (Interface Clear)	Resets the interfaces to their initial condition.
LLO (Local Lockout)	Manual switchover to LOCAL is disabled.
SPE (Serial Poll Enable)	Ready for serial poll.
SPD (Serial Poll Disable)	End of serial poll.
PPU (Parallel Poll Unconfigure)	End of parallel poll query status.

## Addressed Commands

Addressed commands are in the code range 0x00 to 0x0F hex. They only affect devices addressed as a listener.

Table 6-39: Addressed commands

Command	Effect on device
SDC (Selected DeviceClear)	Interrupts processing of received commands and sets the command processing software to a defined initial state. This command does not change the device setting.
GTL (Go to Local)	Change to local mode (manual control).
PPC (Parallel Poll Configure)	Configures device for parallel poll.

## Standard Configurations

The following tables list the settings that can be made when configuring the R&S NRP with the `SYST:STAN:PRE <string>` remote control command. The following values are provided for the `<string>` parameter.

- "GSM/EDGE "
- "NADC/UPLINK "
- "NADC/DOWNLINK "
- "PDC/UPLINK "
- "PDC/DOWNLINK "
- "DECT "
- "WCDMA/3GPP FDD "
- "WCDMA/3GPP TDD DL "
- "WCDMA/3GPP TDD UL "
- "TD-SCDMA "
- "Bluetooth DH1 "
- "Bluetooth DH3 "
- "Bluetooth DH5 "
- "CDMA2000 "

**Note:**

*The tables list only the sensor parameters. If `SYSTEM:STANDARD:PWSettings OFF` is set, the calculate blocks (`CALCulate:...`), the window system (`DISPlay:...`) and the output unit (`UNIT:...`) are also configured.*

<b>"GSM/EDGE"</b>		
<b>Sensor parameter</b>	<b>Remote control command in short form</b>	<b>Value</b>
Sensor Mode	SENS : FUNC	" POW : XTIM "
Integration Time	SENS : APER	4.615 ms
Duty Cycle	SENS : DCYC	11.762 %
Duty Cycle Correction	SENS : DCYC : STAT	ON
Smoothing	SENS : SMO	OFF
Dropout Tolerance	SENS : BURST : DTOL	577 $\mu$ s
Exclude Time Start	SENS : TIM : EXCL : STAR	20 $\mu$ s
Exclude Time End	SENS : TIM : EXCL : STOP	30 $\mu$ s
Number Of Timeslots	SENS : TSL : COUN	8
Timeslot Width	SENS : TSL : WIDT	577 $\mu$ s
Timegate Offset	SENS : TGAT : OFFS : TIME	1: 20 $\mu$ s 2: 2.328 ms
Timegate Time	SENS : TGAT : TIME	1: 527 $\mu$ s 2: 527 $\mu$ s
Scope Offset Time	SENS : TRAC : OFFS : TIME	-100 $\mu$ s
Scope Capture Time	SENS : TRAC : TIME	5 ms
Scope Number Of Points	SENS : TRAC : POIN	312
Scope Realtime	SENS : TRAC : REAL	OFF
Trigger Delay	TRIG : DEL	0 s
Trigger Level	TRIG : LEV	-30 dBm
Trigger Source	TRIG : SOUR	INT
Trigger Slope	TRIG : SLOP	POS
Trigger Holdoff	TRIG : HOLD	27 ms
Trigger Hysteresis	TRIG : HYST	3 dB



"NADC/DOWNLINK"		
Sensor parameter	Remote control command in short form	Value
Sensor Mode	SENS : FUNC	" POW : AVG "
Integration Time	SENS : APER	40 ms
Duty Cycle Correction	SENS : DCYC : STAT	OFF
Smoothing	SENS : SMO	OFF
Trigger Source	TRIG : SOUR	EXT

<b>"NADC/UPLINK"</b>		
<b>Sensor parameter</b>	<b>Remote control command in short form</b>	<b>Value</b>
Sensor Mode	SENS : FUNC	" POW : XTIM "
Integration Time	SENS : APER	40 ms
Duty Cycle	SENS : DCYC	16.267 %
Duty Cycle Correction	SENS : DCYC : STAT	ON
Smoothing	SENS : SMO	OFF
Dropout Tolerance	SENS : BURST : DTOL	3 ms
Exclude Time Start	SENS : TIM : EXCL : STAR	130 $\mu$ s
Exclude Time End	SENS : TIM : EXCL : STOP	140 $\mu$ s
Number Of Timeslots	SENS : TSL : COUN	6
Timeslot Width	SENS : TSL : WIDT	6.667 ms
Timegate Offset	SENS : TGAT : OFFS : TIME	1: 130 $\mu$ s 2: 20.130 ms
Timegate Time	SENS : TGAT : TIME	1: 6.390 ms 2: 6.390 ms
Scope Offset Time	SENS : TRAC : OFFS : TIME	-500 $\mu$ s
Scope Capture Time	SENS : TRAC : TIME	42 ms
Scope Number Of Points	SENS : TRAC : POIN	312
Scope Realtime	SENS : TRAC : REAL	OFF
Trigger Delay	TRIG : DEL	0 s
Trigger Level	TRIG : LEV	-30 dBm
Trigger Source	TRIG : SOUR	INT
Trigger Slope	TRIG : SLOP	POS
Trigger Holdoff	TRIG : HOLD	79 ms
Trigger Hysteresis	TRIG : HYST	3 dB

"PDC/DOWNLINK"		
Sensor parameter	Remote control command in short form	Value
Sensor Mode	SENS : FUNC	" POW : AVG "
Integration Time	SENS : APER	40 ms
Duty Cycle Correction	SENS : DCYC : STAT	OFF
Smoothing	SENS : SMO	OFF
Trigger Source	TRIG : SOUR	EXT

<b>"PDC/UPLINK"</b>		
<b>Sensor parameter</b>	<b>Remote control command in short form</b>	<b>Value</b>
Sensor Mode	SENS : FUNC	" POW : XTIM "
Integration Time	SENS : APER	40 ms
Duty Cycle	SENS : DCYC	16.25 %
Duty Cycle Correction	SENS : DCYC : STAT	ON
Smoothing	SENS : SMO	OFF
Dropout Tolerance	SENS : BURST : DTOL	3 ms
Exclude Time Start	SENS : TIM : EXCL : STAR	125 $\mu$ s
Exclude Time End	SENS : TIM : EXCL : STOP	135 $\mu$ s
Number Of Timeslots	SENS : TSL : COUN	6
Timeslot Width	SENS : TSL : WIDT	6.667 ms
Timegate Offset	SENS : TGAT : OFFS : TIME	1: 125 $\mu$ s 2: 20.125 ms
Timegate Time	SENS : TGAT : TIME	1: 6.406 ms 2: 6.406 ms
Scope Offset Time	SENS : TRAC : OFFS : TIME	-500 $\mu$ s
Scope Capture Time	SENS : TRAC : TIME	42 ms
Scope Number Of Points	SENS : TRAC : POIN	312
Scope Realtime	SENS : TRAC : REAL	OFF
Trigger Delay	TRIG : DEL	0 s
Trigger Level	TRIG : LEV	-30 dBm
Trigger Source	TRIG : SOUR	INT
Trigger Slope	TRIG : SLOP	POS
Trigger Holdoff	TRIG : HOLD	79 ms
Trigger Hysteresis	TRIG : HYST	3 dB

<b>"DECT"</b>		
<b>Sensor parameter</b>	<b>Remote control command in short form</b>	<b>Value</b>
Sensor Mode	SENS : FUNC	" POW : XTIM "
Integration Time	SENS : APER	10 ms
Duty Cycle	SENS : DCYC	3.7 %
Duty Cycle Correction	SENS : DCYC : STAT	ON
Smoothing	SENS : SMO	OFF
Dropout Tolerance	SENS : BURST : DTOL	416.7 $\mu$ s
Exclude Time Start	SENS : TIM : EXCL : STAR	15 $\mu$ s
Exclude Time End	SENS : TIM : EXCL : STOP	25 $\mu$ s
Number Of Timeslots	SENS : TSL : COUN	24
Timeslot Width	SENS : TSL : WIDT	416.667 $\mu$ s
Timegate Offset	SENS : TGAT : OFFS : TIME	1: 15 $\mu$ s 2: 5.015 ms
Timegate Time	SENS : TGAT : TIME	1: 348.055 ms 2: 348.000 ms
Scope Offset Time	SENS : TRAC : OFFS : TIME	-200 $\mu$ s
Scope Capture Time	SENS : TRAC : TIME	10.250 ms
Scope Number Of Points	SENS : TRAC : POIN	312
Scope Realtime	SENS : TRAC : REAL	OFF
Trigger Delay	TRIG : DEL	0 s
Trigger Level	TRIG : LEV	-30 dBm
Trigger Source	TRIG : SOUR	INT
Trigger Slope	TRIG : SLOP	POS
Trigger Holdoff	TRIG : HOLD	39.9 ms
Trigger Hysteresis	TRIG : HYST	3 dB

"WCDMA/ 3GPP FDD"		
Sensor parameter	Remote control command in short form	Value
Sensor Mode	SENS : FUNC	" POW : AVG "
Integration Time	SENS : APER	10 ms
Duty Cycle Correction	SENS : DCYC : STAT	OFF
Smoothing	SENS : SMO	OFF
Filter	SENS : AVER : COUN : AUTO	OFF
Filter Length	SENS : AVER : COUN	16
Trigger Source	TRIG : SOUR	EXT

<b>"WCDMA/3GPP TDD DL"</b>		
<b>Sensor parameter</b>	<b>Remote control command in short form</b>	<b>Value</b>
Sensor Mode	SENS : FUNC	" POW : XTIM "
Integration Time	SENS : APER	10 ms
Duty Cycle	SENS : DCYC	6.667 %
Duty Cycle Correction	SENS : DCYC : STAT	ON
Smoothing	SENS : SMO	OFF
Dropout Tolerance	SENS : BURST : DTOL	666.667 $\mu$ s
Exclude Time Start	SENS : TIM : EXCL : STAR	25 $\mu$ s
Exclude Time End	SENS : TIM : EXCL : STOP	40 $\mu$ s
Number Of Timeslots	SENS : TSL : COUN	15
Timeslot Width	SENS : TSL : WIDT	666.667 $\mu$ s
Timegate Offset	SENS : TGAT : OFFS : TIME	1: 25 $\mu$ s 2: 5.358 ms
Timegate Time	SENS : TGAT : TIME	1: 601.667 $\mu$ s 2: 602 $\mu$ s
Scope Offset Time	SENS : TRAC : OFFS : TIME	-200 $\mu$ s
Scope Capture Time	SENS : TRAC : TIME	10.250 ms
Scope Number Of Points	SENS : TRAC : POIN	312
Scope Realtime	SENS : TRAC : REAL	OFF
Trigger Delay	TRIG : DEL	0 s
Trigger Level	TRIG : LEV	-30 dBm
Trigger Source	TRIG : SOUR	INT
Trigger Slope	TRIG : SLOP	POS
Trigger Holdoff	TRIG : HOLD	19.9 ms
Trigger Hysteresis	TRIG : HYST	3 dB

<b>"WCDMA/3GPP TDD UL"</b>		
<b>Sensor parameter</b>	<b>Remote control command in short form</b>	<b>Value</b>
Sensor Mode	SENS : FUNC	" POW : XTIM "
Integration Time	SENS : APER	10 ms
Duty Cycle	SENS : DCYC	6.420 %
Duty Cycle Correction	SENS : DCYC : STAT	ON
Smoothing	SENS : SMO	OFF
Dropout Tolerance	SENS : BURST : DTOL	666.667 $\mu$ s
Exclude Time Start	SENS : TIM : EXCL : STAR	15 $\mu$ s
Exclude Time End	SENS : TIM : EXCL : STOP	40 $\mu$ s
Number Of Timeslots	SENS : TSL : COUN	15
Timeslot Width	SENS : TSL : WIDT	666.667 $\mu$ s
Timegate Offset	SENS : TGAT : OFFS : TIME	1: 15 $\mu$ s 2: 5.348 ms
Timegate Time	SENS : TGAT : TIME	1: 611.667 $\mu$ s 2: 612 $\mu$ s
Scope Offset Time	SENS : TRAC : OFFS : TIME	-200 $\mu$ s
Scope Capture Time	SENS : TRAC : TIME	10.250 ms
Scope Number Of Points	SENS : TRAC : POIN	312
Scope Realtime	SENS : TRAC : REAL	OFF
Trigger Delay	TRIG : DEL	0 s
Trigger Level	TRIG : LEV	-30 dBm
Trigger Source	TRIG : SOUR	INT
Trigger Slope	TRIG : SLOP	POS
Trigger Holdoff	TRIG : HOLD	19.9 ms
Trigger Hysteresis	TRIG : HYST	3 dB



"TD-SCDMA "		
Sensor parameter	Remote control command in short form	Value
Sensor Mode	SENS : FUNC	" POW : XTIM "
Integration Time	SENS : APER	5 ms
Duty Cycle	SENS : DCYC	13.250 %
Duty Cycle Correction	SENS : DCYC : STAT	ON
Smoothing	SENS : SMO	OFF
Timegate Offset	SENS : TGAT : OFFS : TIME	1: 20 $\mu$ s 2: 710 $\mu$ s 3: 835 $\mu$ s 4: 5.970 ms
Timegate Time	SENS : TGAT : TIME	1: 620 $\mu$ s 2: 30 $\mu$ s 3: 85 $\mu$ s 4: 620 $\mu$ s
Scope Offset Time	SENS : TRAC : OFFS : TIME	-200 $\mu$ s
Scope Capture Time	SENS : TRAC : TIME	10.250 ms
Scope Number Of Points	SENS : TRAC : POIN	312
Scope Realtime	SENS : TRAC : REAL	OFF
Trigger Delay	TRIG : DEL	0 s
Trigger Level	TRIG : LEV	-30 dBm
Trigger Source	TRIG : SOUR	INT
Trigger Slope	TRIG : SLOP	POS
Trigger Holdoff	TRIG : HOLD	19.9 ms
Trigger Hysteresis	TRIG : HYST	3 dB

<b>"Bluetooth DH1"</b>		
<b>Sensor parameter</b>	<b>Remote control command in short form</b>	<b>Value</b>
Sensor Mode	SENS : FUNC	" POW : XTIM "
Integration Time	SENS : APER	1.25 ms
Duty Cycle	SENS : DCYC	29.28 %
Duty Cycle Correction	SENS : DCYC : STAT	ON
Smoothing	SENS : SMO	OFF
Dropout Tolerance	SENS : BURST : DTOL	366 $\mu$ s
Exclude Time Start	SENS : TIM : EXCL : STAR	10 $\mu$ s
Exclude Time End	SENS : TIM : EXCL : STOP	15 $\mu$ s
Timegate Offset	SENS : TGAT : OFFS : TIME	1: 10 $\mu$ s 2: 660 $\mu$ s
Timegate Time	SENS : TGAT : TIME	1: 341 $\mu$ s 2: 341 $\mu$ s
Scope Offset Time	SENS : TRAC : OFFS : TIME	-30 $\mu$ s
Scope Capture Time	SENS : TRAC : TIME	1.280 ms
Scope Number Of Points	SENS : TRAC : POIN	312
Scope Realtime	SENS : TRAC : REAL	OFF
Trigger Delay	TRIG : DEL	0 s
Trigger Level	TRIG : LEV	-30 dBm
Trigger Source	TRIG : SOUR	INT
Trigger Slope	TRIG : SLOP	POS
Trigger Holdoff	TRIG : HOLD	2.480 ms
Trigger Hysteresis	TRIG : HYST	3 dB

<b>"Bluetooth DH3"</b>		
<b>Sensor parameter</b>	<b>Remote control command in short form</b>	<b>Value</b>
Sensor Mode	SENS : FUNC	" POW : XTIM "
Integration Time	SENS : APER	2.50 ms
Duty Cycle	SENS : DCYC	64.88 %
Duty Cycle Correction	SENS : DCYC : STAT	ON
Smoothing	SENS : SMO	OFF
Dropout Tolerance	SENS : BURST : DTOL	1.622 ms
Exclude Time Start	SENS : TIM : EXCL : STAR	10 $\mu$ s
Exclude Time End	SENS : TIM : EXCL : STOP	15 $\mu$ s
Timegate Offset	SENS : TGAT : OFFS : TIME	1: 10 $\mu$ s 2: 1.885 ms
Timegate Time	SENS : TGAT : TIME	1: 1.597 ms 2: 351 $\mu$ s
Scope Offset Time	SENS : TRAC : OFFS : TIME	-30 $\mu$ s
Scope Capture Time	SENS : TRAC : TIME	2.530 ms
Scope Number Of Points	SENS : TRAC : POIN	312
Scope Realtime	SENS : TRAC : REAL	OFF
Trigger Delay	TRIG : DEL	0 s
Trigger Level	TRIG : LEV	-30 dBm
Trigger Source	TRIG : SOUR	INT
Trigger Slope	TRIG : SLOP	POS
Trigger Holdoff	TRIG : HOLD	4.980 ms
Trigger Hysteresis	TRIG : HYST	3 dB

<b>"Bluetooth DH5"</b>		
<b>Sensor parameter</b>	<b>Remote control command in short form</b>	<b>Value</b>
Sensor Mode	SENS : FUNC	" POW : XTIM "
Integration Time	SENS : APER	3.75 ms
Duty Cycle	SENS : DCYC	76.533 %
Duty Cycle Correction	SENS : DCYC : STAT	ON
Smoothing	SENS : SMO	OFF
Dropout Tolerance	SENS : BURST : DTOL	2.870 ms
Exclude Time Start	SENS : TIM : EXCL : STAR	10 $\mu$ s
Exclude Time End	SENS : TIM : EXCL : STOP	15 $\mu$ s
Timegate Offset	SENS : TGAT : OFFS : TIME	1: 10 $\mu$ s 2: 3.135 ms
Timegate Time	SENS : TGAT : TIME	1: 2.845 ms 2: 351 $\mu$ s
Scope Offset Time	SENS : TRAC : OFFS : TIME	-30 $\mu$ s
Scope Capture Time	SENS : TRAC : TIME	2.530 ms
Scope Number Of Points	SENS : TRAC : POIN	312
Scope Realtime	SENS : TRAC : REAL	OFF
Trigger Delay	TRIG : DEL	0 s
Trigger Level	TRIG : LEV	-30 dBm
Trigger Source	TRIG : SOUR	INT
Trigger Slope	TRIG : SLOP	POS
Trigger Holdoff	TRIG : HOLD	7.480 ms
Trigger Hysteresis	TRIG : HYST	3 dB

"CDMA2000"		
Sensor parameter	Remote control command in short form	Value
Sensor Mode	SENS : FUNC	" POW : AVG "
Integration Time	SENS : APER	80 ms
Duty Cycle Correction	SENS : DCYC : STAT	OFF
Smoothing	SENS : SMO	OFF
Filter	SENS : AVER : COUN : AUTO	OFF
Filter Length	SENS : AVER : COUN	16
Trigger Source	TRIG : SOUR	EXT

## Table of Contents

<b>I Programming Measurements with the R&amp;S NRP</b> .....	I.1
<b>Measuring with high-level commands</b> .....	I.1
The simplest measurement .....	I.1
Relative measurements .....	I.2
Processing the results of two sensors .....	I.3
Selecting a measurement mode .....	I.4
Selecting the output unit for measured values .....	I.6
Division of MEAS? .....	I.7
<b>Trigger state system</b> .....	I.9
<b>Logic relationship of command systems SENSE, CALCulate and UNIT</b> .....	I.11
<b>Measuring with low-level commands</b> .....	I.12
The simplest measurement .....	I.12
Configuration of the trigger system .....	I.12
Configuration of sensor settings .....	I.16
Configuration of CALCulate blocks .....	I.20
<b>Optimization of measurement speed</b> .....	I.21

**Figs.**

Fig. I-1: Overview of basic relationships in the trigger state system ..... I.10  
Fig. I-2: Processing of measured values in the R&S NRP ..... I.11  
Fig. I-3: Meaning of settings for TRIG:HOLD and TRIG:DEL ..... I.14

# I Programming Measurements with the R&S NRP

## Measuring with high-level commands

The R&S NRP is based on the instrument model defined in the SCPI 1999.0 standard. This model provides a number of logic blocks that can be configured via remote-control commands. The R&S NRP is provided with high-level measurement commands that automatically perform the most important settings and simplify measurements, thus making it unnecessary to completely configure these blocks for each measurement. Only the high-level commands are described, starting with the simplest command, which is expanded in the following sections.

Note the following for the syntax of commands: There is a short and a long form for the commands. The short form is normally used. However, commands are sometimes indicated in their long form so that their meaning is easier to understand. The R&S NRP makes no distinction between upper case and lower case letters; they are only used to distinguish between the short and long form.

### The simplest measurement

The simplest way to obtain a measured value is to use the high-level measurement command

```
MEAS? ,
```

which configures sensor 1 in the ContAv mode, starts a measurement and always outputs a result that is stored in the output queue. The following settings are performed:

- INIT:CONT OFF
- TRIG:SOUR IMM
- TRIG:COUN 1
- TRIG:DEL:AUTO ON
- SENS:AVER:STAT ON
- SENS:AVER:COUN:AUTO ON
- SENS:AVER:COUN:AUTO:TYPE RES
- SENS:AVER:COUN:AUTO:RES 3
- CALC:MATH "(SENS1)"
- CALC:REL:STAT OFF

The command can also be used with a list of parameters, which are separated by a comma and allow the measurement accuracy and the addressed sensor to be selected:

```
MEAS? DEF, <resolution>, <source_list>
```

The first parameter should always assume the DEF value; it is ignored and is available only for reasons of compatibility.

The second parameter may assume the values 1, 2, 3 and 4. It specifies the number of places up to which the measurement result should be noise-free. With linear units, the setting corresponds to the number of significant places that are noise-free; with logarithmic units, 1, 2, 3 and 4 correspond to a resolution of 1, 0.1, 0.01 and 0.001 (number of decimal places). With a <resolution> of 3, two decimal places are thus noise-free with logarithmic display. The default setting is 3.

The third parameter selects a sensor. It has the syntax (@*n*), where *n* can assume the values 1 to 4. The default setting is (@1).



## Relative measurements

If the measurement results are to be output not as absolute values, but relative to a reference value, the keyword `:RELative` can be added to the measurement command. The result is then divided by a value that was previously set by means of `CALC:REL:POW` or `CALC:REL:AUTO ONCE`.

```
MEAS?  
CALC:REL:AUTO ONCE  
MEAS:REL?
```

The first `MEAS` command determines the reference value, which is acquired and stored with `CALC:REL:AUTO ONCE`. The second measurement command `MEAS:REL?` and all other `MEAS:REL?` commands will divide the absolute measured value by the stored reference value.

`CALC:REL:POW <float_value>` is used to define such a reference value.

```
CALC:REL:POW 0 DBM  
MEAS:REL?
```

All measured values are then divided by 0 dBm (1 mW) prior to being transferred to the user.

The following section describes an extension of the `MEAS` command in which the result no longer carries a power unit, but represents a power ratio. The reference value also must have a power unit and be set with `CALC:REL:RAT`. The R&S NRP stores the reference values for power values and power ratios independently of each other and automatically uses the correct reference value depending on the unit of the measurement result.

The `CALC:REL` command is available for entering the reference value. It assumes a numeric parameter whose unit is determined from the current device settings. This command is provided only for reasons of compatibility and should not be used unless avoidable.

## Processing the results of two sensors

The R&S NRP offers measurement commands for processing the results of two sensors. The calculated result can also be partly referenced to a stored reference value.

The measurement commands are obtained by adding one of the following keywords:

```
:DIFF      (difference)
:DIFF:REL  (difference with reference value)
:RAT       (ratio)
:RAT:REL   (ratio with reference value)
:SWR       (standing wave ratio)
:RLOS      (return loss)
:REFL      (reflection coefficient)
```

The list of parameters is modified for these commands since two sensors have to be entered in the <source\_list>.

### Example:

```
MEAS:RAT DEF,3,(@1),(@4)
```

A CALCulate block is used for processing the measured values. Each CALCulate block has two input channels called the primary and secondary channel. In the above example, the primary channel is assigned sensor 1 and the secondary channel sensor 4 via the <source\_list>. The measurement result is the ratio of the results from sensors 1 and 4.

### Example:

```
MEAS:SWR DEF,2,(@1),(@2)
```

It is assumed that sensor 1 delivers the forward power of a wave and sensor 2 the reflected power of a wave. The measurement result represents the SWR of the two power values:

$$P = \frac{1 + \sqrt{(@2)/(@1)}}{1 - \sqrt{(@2)/(@1)}}$$

Note that the unit is automatically set to percent (refer to Selecting the output unit for measured values).

## Selecting a measurement mode

Other MEAS commands are available for measurements to be performed in a mode other than the ContAv mode. The short form of these commands is obtained by adding a keyword for the measurement mode to keyword MEAS.

### Timeslot measurement:

MEAS:TSLot? <tslot\_width>, <no\_slots>, <start\_exclude>, <stop\_exclude>

### BurstAv measurement:

MEAS:BURSt? <dtolerance>, <start\_exclude>, <stop\_exclude>

### Scope measurement:

MEAS:XTIME? (<scope\_size>), <capture\_time>

### Measurement in the ContAv mode with data buffering:

MEAS:ARRay? <tslot\_width>, <no\_slots>, <start\_exclude>, <stop\_exclude>



**Note:** *In the Timeslot mode, the trigger source is set to EXTERNAL. In the BurstAv mode, it is not modified but ignored. Triggering in response to the signal is performed as if TRIGGER:SOURCE INTERNAL were set.*

These commands have the specified parameters, whose meanings are explained in the operating manual. In addition, parameters DEF, <resolution>, <source\_list> can be optionally specified as for the MEAS? command.

### Examples:

MEAS:TSLot? 577 us, 8, 18 us, 18 us

A timeslot measurement of a GSM signal is performed (8 timeslots with a length of 577  $\mu$ s each). 18  $\mu$ s at the beginning and the end of the timeslots are ignored. The measurement is carried out with sensor 1 (default). The instrument is triggered by an external signal, which must be routed to the R&S NRP rear panel via the trigger input. The measurement result is a list of 8 measured values separated by a comma for the timeslots.

MEAS:BURSt? 5 us, 10 us, 0 us, DEF, 3, (@2)

Sensor 2 measures in the BurstAv mode. Triggering (in response to a rising edge) is internal. At the beginning of the power pulse, 10  $\mu$ s are ignored to avoid overshoots in the signal, which could distort the measurement result. If the power falls below the trigger level but does not exceed 5  $\mu$ s (dropout time) the measurement will not be stopped. The measurement result is noise-free within the first 3 places and it is measured with sensor 2 (@2).

MEAS:XTIME? (256), 577 us

Within the next 577  $\mu$ s, 256 measured values are recorded and displayed with respect to time in the same manner as with an oscilloscope in order to display the power characteristics. There is no triggering (TRIG:SOUR IMM); the measurements are started after the command is received from the R&S NRP. After a partial measurement has been completed, the next one is started. If the trigger source setting is to be changed, MEAS:XTIME? must be replaced by the CONF:XTIME and READ:XTIME? commands, between which user-defined settings can be performed. Dividing MEAS? into the CONF and READ? commands is described further down. The measurement result is a list of 256 measured values separated by a comma.

MEAS:ARRay? (1000)

1000 measured values are recorded in the ContAv mode. After termination of the last measurement, the results are stored in the output queue. There is no triggering as in the ContAv mode. The measurement result is a list of 1000 measured values separated by a comma.

The keywords for processing two sensors can be added to the MEAS:TSL, MEAS:BURS and MEAS:ARRay commands, but the :SWR, :RLOS and :REFL functions are not available.

**Example:**

MEAS:TSL:RAT? 577 us, 8, 18 us, 18 us, DEF, 3, (@1), (@3)

The above timeslot example is extended to two sensors. The measurement result is a list of 8 measured values separated by a comma for the 8 timeslots; these values were obtained by division from the measured values of sensors 1 and 3.

## Selecting the output unit for measured values

So far, no information has been given on the unit of the measured values. It is possible to modify the output unit of the measured values. A distinction is made as to whether the result represents a power or a power ratio. Relative measurements always deliver power ratios. This also applies to the :RATio, :SWR, :RLOS and :REFL functions. The units are set by means of the following commands:

```
UNIT:POWer DBM | W | DBUV and
UNIT:RATio DB | DPCT | O
```

The default settings are DBM for power values and DB for power ratios.

Physical unit	SCPI notation	Meaning
dBm	DBM	Power in dB referenced to 1 mW: $x / W = 10 \log ( x / (1 \text{ mW}) ) / \text{dBm}$
Watt	W	
dB $\mu$ V	DBUV	Power in dB referred to $(1\mu\text{V})^2 / 50 \Omega$ : $x \text{ dBm} \approx (x + 107) \text{ dB}\mu\text{V}$
dB	DB	
$\Delta\%$	DPCT	Deviation from 100% in %: $x \Delta\% = (x + 100) \%$
1	O	

When the :SWR, :RLOS and :REFL functions are used, the output unit, however, is implicitly set by the MEAS command:

Measurement function	Output unit
:SWR	O
:RLOS	DB
:REFL	O



**Note:** *The UNIT commands affect the parameters of the following commands: CALC:LIMit:UPPer, CALC:LIMit:LOWer, CALC:RELative, DISP:METER:UPPer and DISP:METER:LOWer.*

## Division of MEAS?

MEAS? can be divided into other high-level measurement commands.

```
MEAS?      ↔      CONF [<parameters list>]
              READ? [<parameters list>]
```

The CONF command configures the measurement, whereas READ? starts the measurement, and calculates and provides the result. This division offers two advantages:

1. The measurement has to be configured only once and several measurements (with several READ? commands) can be performed in succession. This means better performance as compared to measurements performed with MEAS?, since the time for configuring the measurement is only used once.
2. After CONF, settings can be adapted to user's requirements by means of low-level commands (see below).



**Note:** *If a list of parameters is indicated for the READ command, it must correspond to the list for the preceding CONF command.*

After a measurement has been completed, i.e. the data from the sensors is available, it is sometimes interesting to evaluate this data several times without starting a new measurement each time. Since this is not possible with the above commands, the READ? command can be replaced by the INIT and FETCh? commands.

```
READ?      ↔      INIT
              FETCh? [<list of parameters>]
```

FETCh? evaluates existing data if the data is valid. FETCh? may select another calculation function if the measurement can be evaluated with the available measured data.

### Example:

The following sequence of commands provides the difference between measured values from sensors 1 and 2 by means of FETCh:DIFF?, which measure in the ContAv mode as the default setting.

```
CONF:DIFF
INIT:ALL
FETCh:DIFF?   (OK)
FETCh:RAT?    (OK)
FETCh:BURst?  (→ -221, "Settings conflict")
```

The FETCh:RAT? command then delivers the ratios of the two measured values. This is possible without a new measurement, since the required data is available. The last FETCh command requires a result that was measured in the BurstAv mode. Such a measured value is not available and thus, this command will generate a SCPI error (-221, "Settings conflict").

FETCh? immediately delivers a measured value if a valid result is available. If no measured value is available, the R&S NRP waits for such a value and then answers the query. During this time, no other command should be sent to the R&S NRP, since the query has to be answered first. If a command is sent to the R&S NRP, the SCPI error -410, "Query interrupted", is output.

However, FETCh? should wait only if a measurement result is expected, since command processing is blocked if a command is not answered. If FETCh? is executed although no measured values are expected, the SCPI error -214, "Trigger deadlock", is output. This may occur if the trigger source is set to BUS or HOLD with low-level TRIG:SOUR and FETCh? immediately follows INIT.

**Example:**

CONF

TRIG:SOUR BUS

INIT

FETCh? ( → -214, "Trigger deadlock", \*TRG or GET is not possible if FETCh? is waiting).

## Trigger state system

The accuracy of a result largely depends on how accurately the sequence of a measurement can be determined. The R&S NRP manages a trigger state system to SCPI 1999.0 for each sensor to define the exact start and stop time of a measurement. This system defines the sequence of a measurement cycle. 4 different device states are defined in the trigger state system implemented in the R&S NRP.

- IDLE**                    The R&S NRP is in the idle state and performs no measurement. On power-up of the R&S NRP, it is in the LOCAL mode and in the IDLE state. All connected sensors are set to `INIT:CONT ON` to allow measurements to be continuously displayed. Thus, the IDLE state is exited and the instrument is again in this state if `INIT:CONT OFF` is sent via the remote control.
- INITIATED**            This state is a transition state, which is exited immediately after it has been entered. It has been defined so as to allow the user to decide whether the next measurement cycle is to be immediately started (`INIT:CONT ON` or all cycles defined via `TRIG:COUNT` have not yet been processed) or the R&S NRP returns to the IDLE state. The state is only entered internally and is not noticed by the user.
- WAIT\_FOR\_TRG**        The R&S NRP waits for a trigger event. The source for this event is set via `TRIG:SOUR`. When the event defined in this way occurs, the R&S NRP enters the MEASURING state.
- MEASURING**            As long as the R&S NRP measures data, it remains in this state and exits it immediately after completion of the measurement.



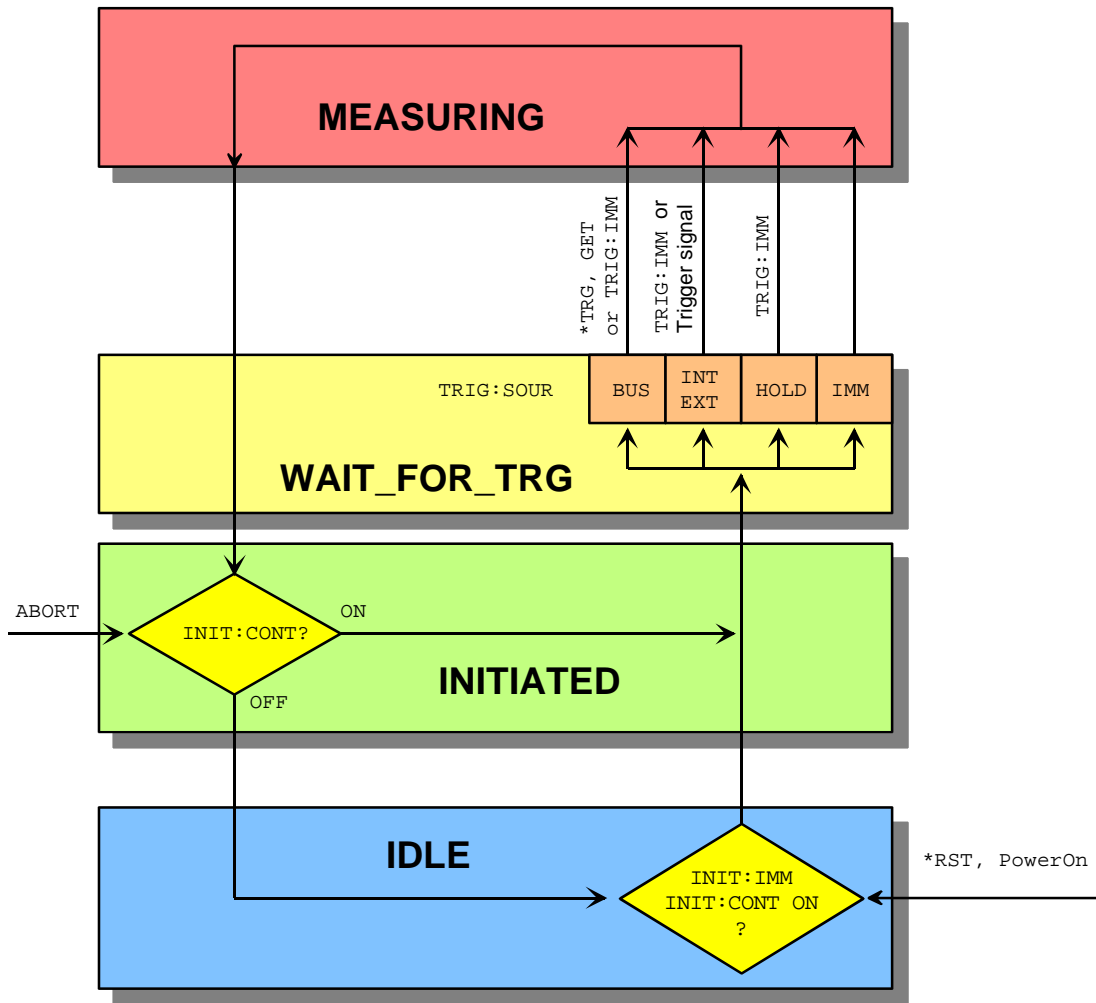

Fig. I-1: Overview of basic relationships in the trigger state system

Fig. I-1: Overview of basic relationships in the trigger state system shows the basic structure of the trigger system. It is possible to improve the sequence of measurement using the commands from the TRIGger command system.

## Logic relationship of command systems SENSE, CALCulate and UNIT

The following section provides an overview of the measurement procedure of the R&S NRP. The commands are mentioned as examples. These commands are described in detail in chapter 6.

To perform measurements with the R&S NRP, the user should have a good understanding of the trigger system and be familiar with the result processing. The measured values delivered by the sensors cannot be directly queried. As shown in Fig. I-2: Processing of measured values in the R&S NRP, the raw data is first determined in the sensors taking into account the SENSE settings. It is then transferred to the CALCulate blocks where the measured values of up to two sensors are processed and made available to the user in the unit defined by UNIT.

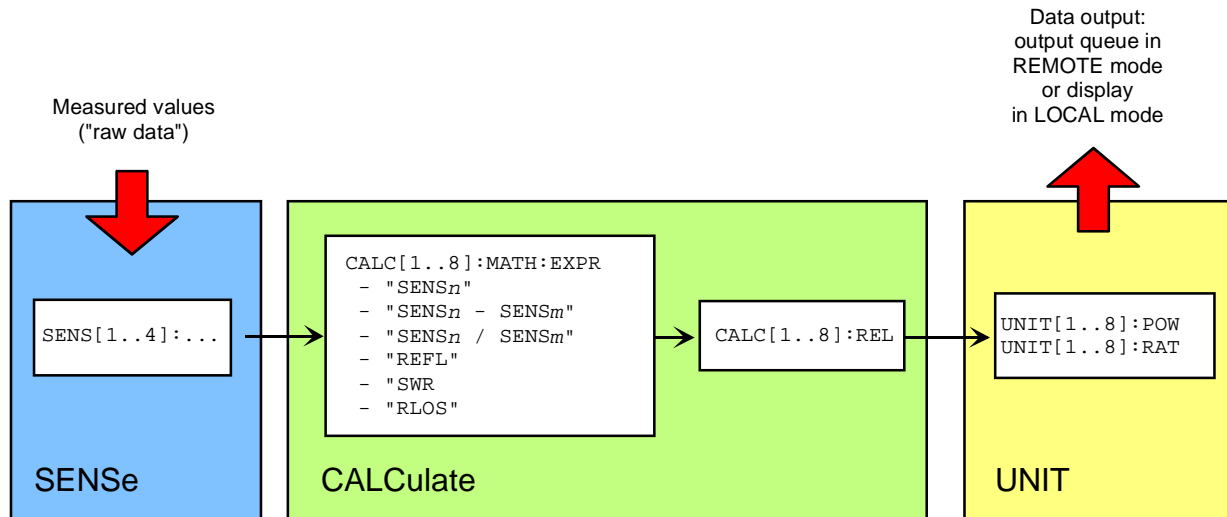

Fig. I-2: Processing of measured values in the R&S NRP



**Note:**

The high-level commands and the SENSE block allow indices to be specified. These indices refer to the connected sensors (indices 1 to 4) for the SENSE commands whereas the indices of the high-level commands select the CALCulate blocks (indices 1 to 8). Depending on the configuration of the first CALCulate block, `FETCh?` (same meaning as `FETCh1?`) may not deliver the measured value of sensor 1 in contrast to the above examples. After `*RST`, the first CALCulate block delivers the measured value of sensor 1 (`CALC1:MATH "(SENS1)"`) and the second one the measured value of sensor 2, etc. (see command `SYSTEM:PRESet`).

## Measuring with low-level commands

Low-level commands allow the user to perform the most important modifications on the measurement configuration. In the present context, low-level commands are all commands that do not belong to high-level commands. These are in particular the commands of the SENSE, TRIGGER and CALCULATE systems. Since the high-level commands combine different low-level commands, they allow a simpler configuration of measurements.

Each measurement configuration should begin with the \*RST command, which sets the R&S NRP to a defined output state. The accurate settings are described in the documentation of remote control command SYSTem:PRESet. The most important settings are listed below:

- Continuous measurements are stopped (INIT:CONT OFF)
- Offset correction are deactivated (SENSe:CORRection:OFFSet:STATe OFF, SENSe:CORRection:DCYClE:STATe OFF, SENSe:CORRection:FDOFFset:STATe OFF).
- All other settings of the SENSE system depend on the sensor used and are specified in the corresponding manual.
- The first 4 CALCulate blocks are set to sensors 1 to 4 (CALCulate:n:MATH "(SENSn)").
- The values are measured as absolute values (CALulate:RELative:STATe OFF).
- Logarithmic units are used (UNIT:POWer dBm and UNIT:RATio dB).

### The simplest measurement

The fastest way to obtain a result is to use the following sequence of commands

```
*RST
INIT
FETCh?
```

Normally, \*RST will set the ContAv mode. The concept of smart-sensor technology provides that each sensor determines the reset values of the assigned SENSE and TRIGGER block. Thus, another mode than ContAv may come after \*RST with future sensors. Information is provided in the operating manual of the sensor used.

INIT initiates the measurement. After \*RST, the trigger system is set to "straight through" (TRIG:SOUR IMM) so that the trigger system state changes to MEASURING via INITIATED and WAIT\_FOR\_TRG. After the measurement has been completed, FETCh? delivers the result to the output queue from which it can be fetched.

### Configuration of the trigger system

#### Trigger source

After a measurement is started with INIT, the state WAIT\_FOR\_TRG is entered. This is a preliminary stage to the measurement, which has been initiated so that the measurement may start with high accuracy at a defined point in time. For this purpose, different sources can be defined for the trigger event, which triggers the measurement. In manual operation, a trigger event is not expected in the ContAv mode. Since the measurement is to be performed continuously, the trigger source (TRIGGER:SOURce) is set to IMMEDIATE.

If triggering needs to occur in response to a rising signal edge, the trigger system has to be configured with `TRIG:SOUR INT` and `TRIG:SLOP POS`:

```
*RST
TRIG:SOUR INT (triggering in response to a signal edge)
TRIG:SLOP POS (triggering in response to a rising signal edge)
INIT
FETCh?
```



**Note:** *The settings of commands `TRIG:SOUR` and `TRIG:SLOP` are ignored in the `BurstAv` mode. In this mode the beginning and the end of the power pulse are automatically recognized. For this reason, the instrument always triggers `INTernal` even if `TRIG:SOUR` has a different setting.*

If a trigger signal is to be routed to the instrument rear panel via the external trigger connector, the trigger source has to be configured with `TRIG:SOUR EXT`.

```
*RST
TRIG:SOUR EXT (triggering in response to the edge of an external signal)
TRIG:SLOP POS (triggering in response to a rising signal edge)
INIT
FETCh?
```

`TRIG:SOUR BUS` can be set if measurements are to be started with `*TRG` or `GET`. This procedure is provided by standard IEEE 488.2, which stipulates that `*TRG` or `GET` can also be used to perform complete measurements. This includes the generation of an answer, the measurement result. In the R&S NRP, `*TRG` does not have this meaning: `*TRG` only executes a trigger event and thus only causes the status transitions from `WAIT_FOR_TRG` to `MEASURING`. `*TRG` delivers no measurement result and has no effect if `TRIG:SOUR` is not set to `BUS` or if the instrument is not in the state `WAIT_FOR_TRG`. The latter situation applies, for example, if the R&S NRP is `IDLE`, i.e. `INIT:CONT ON` is not set nor was `INIT` executed.

### ***Delay, holdoff and exclude***

Normally, the measurement immediately starts after the trigger event has been executed. This may not be desirable if the measurement is to be started before or after the trigger point. The start of the measurement with reference to the trigger point can be offset using the `TRIG:DEL` command. A negative sign means that the measurement begins before the trigger point. This is possible because the sensors store sampling values for a while and can use past values when the measurement is started. The command is also used when overshoots are to be ignored at the beginning of a power pulse.

**Example:**

```

*RST
TRIG:SOUR INT
TRIG:DEL 50 us      (starts measurement 50 µs after the trigger event)
TRIG:HOLD 800 us   (starts next trigger event 800 µs after the trigger event at the earliest)
INIT
FETCh?

```

Another way to modify the trigger system timing is to set a holdoff time (TRIG:HOLD). After a trigger event, all following trigger events are ignored if they occur within the holdoff time. This is to prevent signal components that have not yet decayed from causing triggering by mistake after the measurement has been completed. This makes sense especially with internal triggering (BurstAv mode).

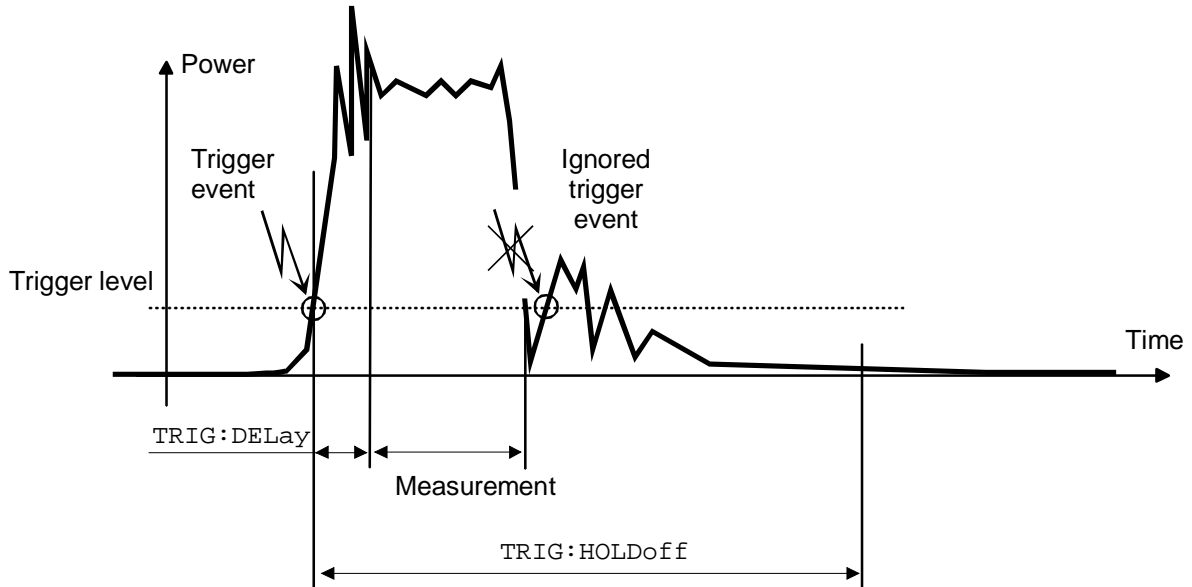

Fig. I-3: Meaning of settings for TRIG:HOLD and TRIG:DEL

It is also possible to exclude time domains from the integration of the measured value at the beginning and the end of the measurement (SENS:TIM:EXCL:START and SENS:TIM:EXCL:STOP):

**Example:**

```

*RST
SENS:FUNC "POW:BURS:AVG"
SENS:TIM:EXCL:STAR 10 US (ignores 10 µs at the beginning of the measurement)
SENS:TIM:EXCL:STOP 10 US (ignores 10 µs at the end of the measurement)
INIT
FETCh?

```

**Level, hysteresis and dropout time**

With internal and external triggering (`TRIG:SOUR INT | EXT`), a trigger event is recognized when the level of a trigger signal exceeds a specific value. This value is the trigger level and can be set with `TRIG:LEV`. With internal triggering, the end of the measurement is recognized when the power level falls below the trigger level. This is not desirable with modulated signals or short interruptions and also when the level just falls slightly below the trigger level:

- `SENS:BURS:DTOL` is used to define a time span during which the power to be measured in the BurstAv mode must remain below the trigger level so that the end of the burst can be detected.
- `TRIG:HYST` is used to specify a value in dB by which the signal must fall below the trigger level so that the end of a burst can be detected.

## Configuration of sensor settings

The sensor settings are controlled by the SENSE command system. The sensors tell the basic unit which commands they understand and which parameters are allowed. As a result, the commands described below cannot be used for some sensors.

### Selecting a measurement mode

The most important sensor-dependent setting is the selection of a measurement mode:

- **ContAv mode** (SENS:FUNC "POW:AVG"): Continuous measurement with only one integration time specified (SENS:APER), within which the power is integrated as a measurement result.

**Example:**

```
*RST
SENS:FUNC "POW:AVG"
SENS:APER 10 MS
INIT
FETCh?
```

- **Timeslot mode** (SENS:FUNC "POW:TSL:AVG"): After the trigger event, the power is measured in timeslots, the number of which is defined with SENS:TSL:COUN. The length of the timeslots is set with SENS:TSL:WIDT.

**Example:**

```
*RST
SENS:FUNC "POW:TSL:AVG"
SENS:TSL:WIDT 577 US
SENS:TSL:COUN 8
TRIG:SOUR EXT
INIT
FETCh?
```

- **BurstAv mode** (SENS:FUNC "POW:BURS:AVG"): Measurement of power pulses (bursts) with automatic detection of the beginning and end of pulses. The trigger source setting is ignored. As described above, the conditions for the detection of the pulse end can be set with commands SENS:BURS:DTOL and TRIG:HYST.

**Example:**

```
*RST
SENS:FUNC "POW:BURS:AVG"
SENS:BURS:DTOL 100 MS
TRIG:HYST 3 DB
INIT
FETCh?
```

- **Scope mode** (`SENS:FUNC "XTIM:POW"`): This mode is used to determine a large number of measured values in succession. The number of required measured values is set with `SENS:SWE:POIN` and the total measurement time with `SENS:SWE:TIM`. Note that each measurement must be triggered separately. This point is a difference between the Scope mode and the Timeslot mode, in which it is only necessary to start the measurement for measuring the power in all timeslots.

**Example:**

```
*RST
SENS:FUNC "XTIM:POW"
SENS:SWE:POIN 256
SENS:SWE:TIM 600 us
TRIG:COUN 256    (change to IDLE state after the 256th measurement)
INIT
FETCh?
```

**Averaging/filters**

The power values to be measured are sampled by the sensors. The sampling values then undergo two-stage filtering before they are made available as measured values.

The first filter stage is a time integration. The integration time is either set explicitly (ContAv mode: `SENS:APER`, Timeslot mode: `SENS:TSL:WIDT` and Scope mode: `SENS:SWE:POIN` and `-:TIME`) or determined automatically (BurstAv mode).

Filtering (averaging) is the second filter stage, which is configured via the command path `SENS:AVERage`. These settings are used to obtain a stable (noise-free) result up to a required accuracy. This is done by means of a digital filter, which has a variable length: the longer the filter, the more stable the result.

- **Manual filter setting:** The filter-length automatic mode is deactivated and the filter length is set in power-of-two numbers.

**Example:**

```
*RST
SENS:AVER:STAT ON          (activates filtering)
SENS:AVER:COUN:AUTO OFF   (switches off filter-length automatic mode)
SENS:AVER:COUN 4          (permanently sets filter length to 4 = 22)
INIT
FETCh?
```



**Automatic filter setting:** `SENS:AVER:COUN:AUTO:TYPE NSR | RES` is used to select whether the noise component should remain below a specific threshold (NSR) or the measurement result should be stable up to a specific accuracy (RES). To avoid long measurement times, `SENS:AVER:COUN:AUTO:MTIM` can be used to specify a maximum measurement time. The maximum filter length is set such that the measurements do not exceed this time, even if the desired stability has not yet been obtained.

**Example:**

```
*RST
SENS:AVER:STAT ON           (activates filtering)
SENS:AVER:COUN:AUTO ON     (switches on filter-length automatic mode)
SENS:AVER:COUN:AUTO:TYPE RES (sets automatic mode to RESolution)
SENS:AVER:COUN:AUTO:RES 3   (maintains 3 places noise-free in the result)
INIT
FETCh?
```

**Example:**

```
*RST
SENS:AVER:STAT ON           (activates filtering)
SENS:AVER:COUN:AUTO ON     (switches on filter-length automatic mode)
SENS:AVER:COUN:AUTO:TYPE NSR (sets automatic mode to NSRatio)
SENS:AVER:COUN:AUTO:NSR 0.01 DB (maximum noise component in the result)
SENS:AVER:COUN:AUTO:MTIM 10 S (but does not measure more than 10 s)
INIT
FETCh?
```

All intermediate pushed values delivered by the first filter stage are stored in the filter. The earliest measured value is ousted out of the filter, since the filter has only a limited length. `SENS:AVER:TCON MOV | REP` is used to set when the filter algorithm is to be applied to the filter. With the setting `MOVing`, a new measure value is calculated for each new intermediate measured value. This is the default setting in the LOCAL mode. `SENS:AVER:TCON REPeat` is set in the REMOTE mode. In this particular case, new measured values are calculated when all intermediate measured values have been replaced by new ones.



**Note:** *Changing from `SENS:AVER:TCON MOV` to `REP` in the LOCAL-REMOTE transition causes the update rate of measured values to be reduced, since the filter must be completely filled for each new measured value.*

### Measured-value corrections

The R&S NRP offers different options for correcting measured values in the instrument. These options all require an existing knowledge of the test setup or the time structure of the signal. Offsets in the result can be corrected globally and depending on the frequency, and it is possible to consider the duty cycle of a signal and the influence of the complex reflection coefficient ( $\Gamma$ ) of the power source.

- **Global offset correction:** All measured values are multiplied by a correction factor (logarithmically added).

**Example:**

```
*RST
SENS:CORR:OFFS:STAT ON      (global offset correction ON)
SENS:CORR:OFFS 20 DB       (corrects result by +20 dB)
INIT
FETCh?
```

- **Frequency-dependent offset correction:** Two-column tables can be entered in which frequencies and correction values can be stored. A frequency-dependent correction value is determined by linear interpolation in the units Hz and dB using the signal frequency (defined with SENS:FREQ). The interpolated correction value can be queried with SENS:FDOF? for checking purposes.

**Example:**

```
*RST
MEM:TABL:MOVE "Table 1" "Splitter"  (renames first table)
MEM:TABL:SEL "Splitter"              (selects table)
MEM:TABL:CLEAr                       (deletes selected table)
MEM:TABL:FREQ 0,1e4,5e4,1e5,1e9      (interpolation points on the frequency axis)
MEM:TABL:GAIN 3.1,3.1,3.0,2.9,2.9    (associated offset values)
SENS:FREQ 900 MHZ                    (signal frequency)
SENS:CORR:FDOF:STAT ON               (activates frequency-dependent offset correction)
SENS:CORR:FDOF "Splitter"            (selects an offset table)
SENS:CORR:FDOF?                      (queries correction value used)
INIT
FETCh?
```

This example assumes that a table called "Table 1" is available.

- **Duty cycle:** If the duty cycle of a pulsed signal (SENS:DCYC) is reported to the R&S NRP, the R&S NRP delivers the average power in the pulse.

**Example:**

```
*RST
SENS:CORR:DCYC:STAT ON      (duty-cycle correction ON)
SENS:CORR:DCYC 30 PCT      (duty cycle of 30%)
INIT
FETCh?
```

- **Reflection coefficient of the source (source gamma,  $\Gamma$ ):** Reflections at the power source may distort the result. If the reflection coefficient of the source is known, it can be specified for the measured-value correction via command path SENS : SGAM.

**Example:**

```
*RST
SENS:SGAM:CORR:STAT ON      (considers the reflection coefficient  $\Gamma$  of the source)
SENS:SGAM:MAGN 0.01         (magnitude of  $\Gamma$ )
SENS:SGAM:PHAS 1.79         (phase angle of  $\Gamma$ )
INIT
FETCh?
```

**Configuration of CALCulate blocks**

The function of the CALCulate blocks has already been explained. Its most important task is the calculation and provision of measurement results.

**Calculation function and relative measurement**

The calculation functions mentioned in connection with high-level commands are internally implemented via commands CALC : MATH and CALC : REL : STAT.

Keyword for selecting a calculation function with high-level commands	Corresponding low-level commands (n,m=1,2,3,4)
:DIFF (Difference)	CALC:MATH "(SENSn-SENSm)"; REL:STAT OFF
:DIFF:REL (Difference with reference value)	CALC:MATH "(SENSn-SENSm)"; REL:STAT ON
:RAT (Ratio)	CALC:MATH "(SENSn/SENSm)"; REL:STAT OFF
:RAT:REL (Ratio with reference value)	CALC:MATH "(SENSn/SENSm)"; REL:STAT ON
:SWR (Standing wave ratio)	CALC:MATH "SWR(SENSn)"; REL:STAT OFF
:RLOS (Return loss)	CALC:MATH "RLOS(SENSn)"; REL:STAT OFF
:REFL (Reflection coefficient)	CALC:MATH "REFL(SENSn)"; REL:STAT OFF

**Example:**

```
*RST
CALC:MATH "(SENS1/SENS2)"      (processes sensors 1 and 2)
CALC:REL:STAT ON              (relative measurement)
CALC:REL 23 dB                 (sets reference value)
INIT:ALL                       (starts measurements on all sensors)
FETCh?
```

## Optimization of measurement speed

The duration of a message can be reduced by making the following setting:

SYST:SPEEd FAST (deactivates screen content !!!)

The following settings also affect the measurement speed to a greater or lesser extent. Which of these settings are possible, however, depends on what is to be measured. For example, if measurement accuracy is important, filtering may also have to be activated, which can reduce the measurement speed. The length of the integration time also directly affects the measurement time and should therefore be kept as short as possible if a short measurement time is desired. Consequently, the following list can only serve as a guideline for minimizing the measurement time.

SYST:SPEEd FAST	(deactivates screen content)
SENS:AVER:STAT OFF	(deactivates filtering of measured values)
SENS:FUNC "POW:AVG"	(ContAv mode)
SENS:BUFF:STAT OFF	(no buffered measurements)
SENS:APER MIN	(integration time as short as possible)
SENS:RANG:AUTO OFF	(automatic range selection OFF)
SENS:CORR:OFFS:STAT OFF	(no global offset correction)
SENS:CORR:DCYC:STAT OFF	(no duty cycle correction)
SENS:CORR:FDOF:STAT OFF	(no frequency-dependent offset correction)
SENS:SGAM:CORR:STAT OFF	(no measured-value correction for reflection coefficient of source)
TRIG:DEL 0	(no delay on triggering)
TRIG:DEL:AUTO OFF	(no delay on triggering)
CALC1:MATH "(SENS1)"	(only uses the first CALCulate block)
CALC2:MATH "(SENS2)"	
CALC3:MATH "(SENS2)"	
CALC4:MATH "(SENS2)"	
CALC5:MATH "(SENS2)"	
CALC6:MATH "(SENS2)"	
CALC7:MATH "(SENS2)"	
CALC8:MATH "(SENS2)"	

**Table of Contents**

**8 Maintenance ..... 8.1**

**Sensor test ..... 8.1**

**Instrument selftest..... 8.1**

**Cleaning the exterior ..... 8.1**

**Storage..... 8.1**

## 8 Maintenance

Under normal operating conditions the R&S NRP does not require any regular maintenance except for occasional cleaning of the front panel.

### Sensor test

The sensor selftest is described in Chapter 4 in the section "Selftest".

### Instrument selftest

The R&S NRP carries out a selftest during booting. This selftest is described in Chapter 1 in the section titled "Welcome screen and function test".

### Cleaning the exterior

To clean the exterior, use a soft, lintfree cloth and an alcohol-free solvent, e.g. a commercially available dishwashing liquid.

### Storage

The R&S NRP has a storage temperature range of  $-20\text{ °C}$  to  $+70\text{ °C}$ .

## Contents

<b>9</b>	<b>SCPI Error Messages</b> .....	9.1
	<b>SCPI-Specific Error Messages</b> .....	9.1
	No error .....	9.1
	Command Error.....	9.1
	Execution Error .....	9.3
	Device-Specific Errors.....	9.4
	Query Errors.....	9.5
	<b>Device-Dependent Errors</b> .....	9.5

## 9 SCPI Error Messages

The list below contains all error messages that may occur in the instrument. Negative error numbers are defined in the SCPI standard, positive error numbers identify device-specific errors.

The left column of the following table gives the error code. In the right column, the text of the error message displayed or entered in the error/event queue is printed in bold. An additional explanation is given below this text.

### SCPI-Specific Error Messages

#### No error

Error code	Error text returned upon queue query Explanations
0	<b>No error</b> This message is displayed if the error queue is empty.

#### Command Error

Command errors; causes bit 5 in the ESR to be set.

Error code	Error text returned upon queue query Explanations
-100	<b>Command error</b> Command faulty or invalid.
-101	<b>Invalid character</b> The command contains a character which is invalid for that type.
-102	<b>Syntax error</b> The command is invalid.
-103	<b>Invalid separator</b> Command contains an illegal character where a separator is expected.
-104	<b>Data type error</b> Command contains an invalid data element.
-108	<b>Parameter not allowed</b> The command contains too many parameters.
-109	<b>Missing parameter</b> The command contains fewer parameters than required.
-111	<b>Header separator error</b> The header contains an illegal delimiter.



Error code	Error text returned upon queue query Explanations
-112	<b>Program mnemonic too long</b> The header contains more than 12 characters.
-113	<b>Undefined header</b> The header is not defined for the device.
-114	<b>Header suffix out of range</b> The header contains an illegal numeric suffix.
-120	<b>Numeric data error</b> The command contains a faulty numeric parameter.
-121	<b>Invalid character in number</b> A numeric contains an invalid character.
-123	<b>Exponent too large</b> The magnitude of the exponent is larger than 32000.
-124	<b>Too many digits</b> The numeric contains too many digits.
-127	<b>Invalid numeric data</b>
-128	<b>Numeric data not allowed</b> The command contains a numeric data element in a position where it is not accepted.
-131	<b>Invalid suffix</b> The suffix is invalid for this device. The suffix is the index that indexes the sensor with the SENSE commands (1-4), the CALCulate block with the high-level measurement commands (1-4) and the window with the DISPLAY commands (1-4).
-134	<b>Suffix too long</b> The suffix contains more than 12 characters.
-138	<b>Suffix not allowed</b> A suffix is not allowed for this command or at this position in the command.
-141	<b>Invalid character data</b> Either the character data element contains an invalid character or the particular element received is not valid for this command.
-144	<b>Character data too long</b> The character data element contains too many characters.
-148	<b>Character data not allowed</b> The character data element used is not allowed for this command or at this position of the command.
-151	<b>Invalid string data</b> The command contains invalid string data.
-158	<b>String data not allowed</b> The command contains a valid string data element at a position where it is not allowed.
-161	<b>Invalid block data</b> The command contains invalid block data.
-168	<b>Block data not allowed</b> The command contains a legal block data element at a point where it is not allowed.

Error code	Error text returned upon queue query Explanations
-171	<b>Invalid expression</b> The command contains an invalid mathematical expression data element.
-178	<b>Expression data not allowed</b> The command contains mathematical expression data at a point where they are not allowed.

## Execution Error

Execution errors; cause bit 4 in the ESR register to be set

Error code	Error text returned upon queue query Explanations
-200	<b>Execution error</b> An error occurred upon command execution.
-203	<b>Command protected</b> An attempt was made to execute a protected command.
-210	<b>Trigger error</b> Error on triggering the device.
-211	<b>Trigger ignored</b> A *TRG or a triggering signal was ignored.
-213	<b>Init ignored</b> A request for a measurement initialization was ignored as another measurement was already in progress.
-214	<b>Trigger deadlock</b> A measurement could not be started or a result query could not be processed since the device would otherwise enter a deadlock state. This occurs under the following conditions: (1) TRIG:SOUR BUS;:INIT;:FETCh?: A *TRG or TRIG:IMM would be required for triggering but these commands cannot be executed since FETCh? blocks the entry. But FETCh? waits until the measured values are available. (2) FETCh? was called but no valid result was available and the trigger system of the sensor is IDLE. FETCh? blocks the entry so that a measurement cannot be started with INIT either.
-220	<b>Parameter error</b> The command contains a faulty or invalid parameter.
-221	<b>Settings conflict</b> There is a setting conflict between two or more parameters.
-222	<b>Data out of range</b> A program data element is outside the legal range as defined by the device.
-223	<b>Too much data</b> A valid parameter is received but it contains more data than the device can handle.
-224	<b>Illegal parameter value</b> The parameter value is invalid.

Error code	Error text returned upon queue query Explanations
-225	<b>Out of memory</b> The device has insufficient memory to perform the required operation.
-226	<b>Lists not same length</b> A list of offset values and frequencies has not the same length as an associated list of frequency and offset values.
-230	<b>Data corrupt or stale</b> The data are incomplete or invalid.
-240	<b>Hardware error</b> The command cannot be executed because of a hardware problem in the device.
-241	<b>Hardware missing</b> The command cannot be executed because of missing device hardware.

## Device-Specific Errors

Device-specific error; causes bit 5 to be set in the ESR register

Error code	Error text returned upon queue query Explanations
-300	<b>Device-specific error</b> Generic device-dependent error that cannot be defined more precisely.
-310	<b>System error</b> Indicates that some system error has occurred. Please contact the R&S service center.
-311	<b>Memory error</b> An error was detected in the device's memory.
-314	<b>Save/recall memory lost</b> Indicates that the nonvolatile data saved by the *SAV? command has been lost.
-315	<b>Configuration memory lost</b> Indicates that nonvolatile configuration data saved by the device has been lost.
-330	<b>Self-test failed</b> The self-test could not be executed.
-341	<b>Zeroing failed</b> The zeroing of a sensor (CALibration:ZERO:AUTO ONCE) has failed. The most frequent cause for this error is a signal that is applied to the sensor input and prevents zeroing.
-350	<b>Queue overflow</b> This code is entered into the queue in lieu of the code that caused the error. It indicates that an error occurred but was not recorded. Five entries are accepted in the queue.
-363	<b>Input buffer overrun</b> More commands were sent to the device than can be simultaneously executed or stored.

## Query Errors

Query errors; cause bit 2 in the ESR register to be set

Error code	Error text returned upon queue query Explanations
-400	<b>Query error</b> Generic query error that cannot be defined more precisely.
-410	<b>Query INTERRUPTED</b> The query was interrupted. Example: The query is followed by new data before the response was completely sent.
-420	<b>Query UNTERMINATED</b> An incomplete query was received.
-430	<b>Query DEADLOCKED</b> The query cannot be processed.
-440	<b>Query UNTERMINATED after indefinite response</b> A query is received in the same program message after a query requesting an indefinite response.

## Device-Dependent Errors

Device-dependent error; causes bit 5 to be set in the ESR register

Error code	Error text returned upon queue query Explanations
1	<b>Device-dependent error</b> This error message is sent when the device cannot detect a more specific error.
2	<b>IEEE 1174 error (unknown emulation code)</b> An invalid IEEE-1174 emulation mode was selected for the Ethernet link.
22	<b>IEEE1174 mode 488.1 not allowed</b> Setting the IEEE 1174.1 mode is not permissible.
24	<b>Sensor mode not supported</b> An attempt was made to set the sensor to a measurement mode which is not supported.
25	<b>Not supported</b> A command is not supported (by the sensor).
26	<b>State not supported</b> Attempt was made to set an invalid value. The permissible values for sensor-dependent commands can be declared as impermissible by a sensor depending on the context.
27	<b>Sensor not present</b> A command could not be executed because the required sensor is not connected.

Error code	Error text returned upon queue query Explanations
28	<b>Sensor not idle</b> A command could not be executed because the respective sensor was not in the IDLE state at that time.
29	<b>Measurement aborted while waiting for data</b> A measurement was aborted while the device was waiting for measurement results.
30	<b>No extremes available in this mode</b> Extreme values (minimum, maximum und peak-to-peak values) are not calculated in the set measurement mode.
39	<b>Sensor removed while waiting for result</b> A sensor was disconnected while the device was waiting for measurement results.
42	<b>Failed to initialize sensor</b> A sensor could not be initialized.
43	<b>Error in receiving calibration data from sensor</b> An error occurred in receiving calibration data from the sensor (command CALibration[1..4]:DATA?).
44	<b>Error in sending calibration data to sensor</b> An error occurred in sending calibration data to the sensor (command CALibration[1..4]:DATA <block_data>).
45	<b>Command not supported by sensor</b> Attempt was made to send a command to a sensor that does not support this command. This may depend on the current sensor status. The sensors can inform the R&S NRP at any point which commands they support or do not support. This mainly concerns commands of the Sense and Trigger systems.
46	<b>Sensor failure: no command receipt</b> A sensor did not acknowledge any command.
47	<b>Error in receiving battery data</b> An error occurred in receiving battery data (command SYSTem:BATTery:STATus?).
48	<b>Error in sending battery data</b> An error occurred in sending battery data (command SYSTem:BATTery:MODE <block_data>).
50	<b>Fatal sensor error</b> A sensor signalled a serious error. If the problem persists, please contact the R&S servicing center.
51	<b>Overload</b> A sensor signalled that the signal applied has exceeded the permissible maximum power. CAUTION! Sensor overload can destroy the electronic measurement system.
52	<b>Overrange</b> This error is signalled if a sensor detects that one of its measurement channels is overranged. The result is then probably incorrect. This error can occur if the automatic range function is deactivated (SENSe:RANGe:AUTO OFF) and the manually selected measurement channel is not suitable or the cross-over level (SENSe:RANGe:AUTO:CLeVel) was incorrectly selected.
53	<b>Truncated measurement</b> In the BurstAv mode, the samples for the power are stored in an internal buffer until the end of the power pulse is detected. If the buffer overflows the measurement is terminated and error 53 "Truncated measurement" is generated.

Error code	Error text returned upon queue query Explanations
54	<b>Sample error</b> Samples were lost while sampling the signal applied. The measured value can thus be incorrect.
55	<b>Sensor hardware error</b> A sensor signalled an error in the sensor hardware. If the problem persists, please contact the R&S servicing center.
56	<b>Filter truncated</b> With the automatic filter function activated, a sensor tries to set the filter length such that the required accuracy is obtained. If the measurement time required for this exceeds the value set with <code>SENSE:AVERAGE:COUNT:AUTO:MTIME</code> (max. time), the filter length is shortened such that a measurement does not last more than the max. time and error message 56 "Filter truncated" is generated.
57	<b>Standard settings incomplete</b> The R&S NRP can be configured for measuring standardized signals with <code>SYSTEM:STANDARD:PRESet</code> <string>. This command sets a number of predefined parameters. If a sensor does not support a specific parameter (e.g. a measurement mode), execution error message 57 "Standard settings incomplete" is generated.