

Keysight Technologies

Infiniium Oscilloscope Probes and Accessories

Data Sheet

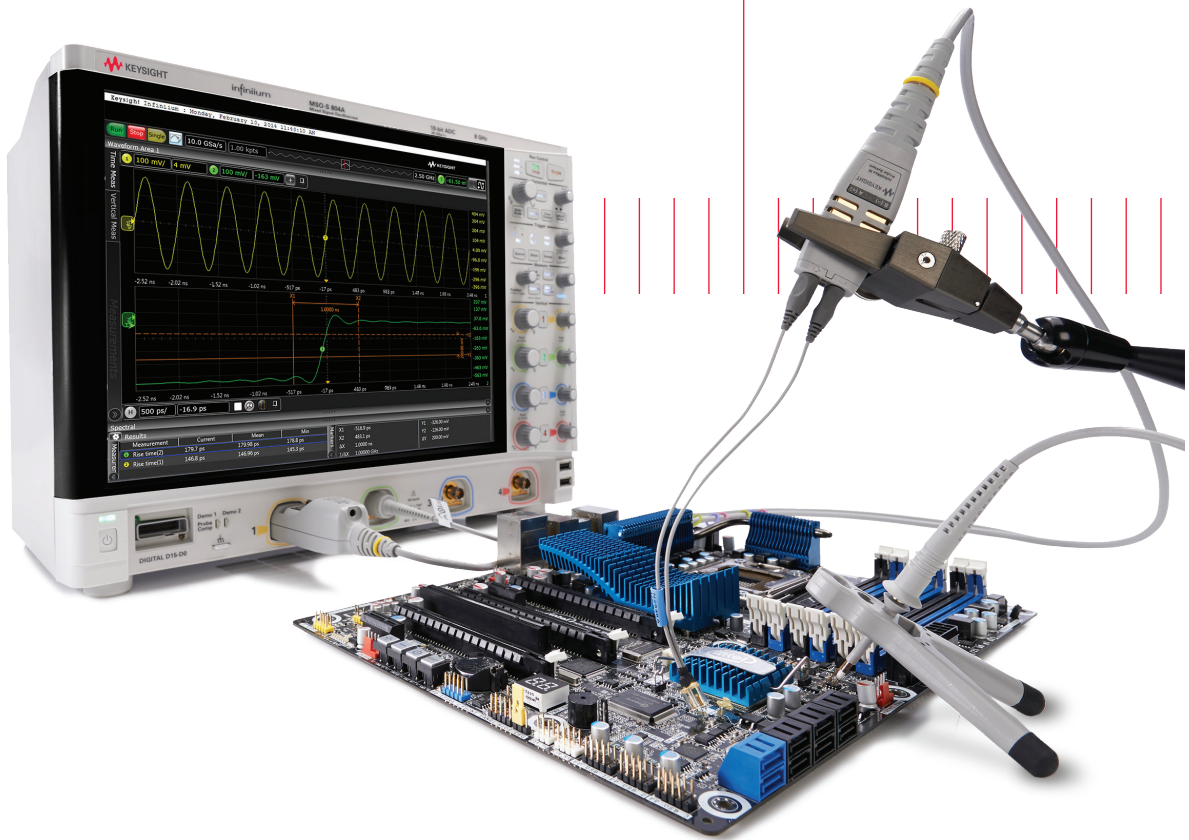

To get the most out of your Infiniium oscilloscope, you need the right probes and accessories for your particular applications. Whether you need the high bandwidth and low loading of an active probe, an easy way to connect to surface mount ICs, or a passive probe to measure high voltages, there's a wide selection of high-quality probes and accessories for your Infiniium oscilloscope.

Table of Contents

Probe Compatibility Table	3
InfiniiMax Active Probe System Overview	4
InfiniiMax III/III+ probing system	6
InfiniiMax II probing system.....	14
InfiniiMax I probing system	21
Active Termination Adapter	25
InfiniiMode Active Probes	27
N2750A/51A/52A InfiniiMode probes	27
Single-Ended Active Probes	30
N2795A/96A/97A active probes.....	30
N7020A power rail probe	32
General Purpose Differential Active Probes	34
N2790A/91A/891A high-voltage differential probes	34
N2804/05A high voltage differential probes	35
1153A/41A low-noise differential probes.....	36
N2818A/19A general-purpose differential probes.....	37
AC/DC Current Probes	38
1146B low-cost AC/DC current probe.....	38
1147B/N2893A AC/DC current probe	39
N2780B/81B/82B/83B/83L AC/DC current probes	40
High-Sensitivity Current Probes	41
General Purpose Passive Probes.....	43
N2870A-76A passive probes.....	43
1165A passive probe	46
54006A high bandwidth passive probe	48
High Voltage Passive Probes.....	49
10076C 100:1 passive probe.....	49
N2771B 1000:1 passive probe	50
Mixed Signal Oscilloscope Logic Probes and Accessories.....	51
Probing Accessories	53
InfiniiMax probe accessories	53
N2744A T2A probe interface adapter.....	54
N2784A/85A/86A/87A probe positioners	54
Wedge probe adapters.....	56
Fine pitch and PC board accessories.....	57
E2697A high impedance adapter	57
Related Literature	58

Probe Compatibility Table

For ordering information when replacing your probe or probe accessory:
Refer directly to the page number listed in the table of contents for your probe model.

To assist you in selecting the proper probe for your application:
Use our probe compatibility table below to find the probes that are recommended for use with your Infiniium scope.

Or refer to our probe overview page at the beginning of each section in the table of contents explaining what the different probe types are and the models available for your Infiniium.

	9000 Series	S-Series	90000/90008A Series*	V-Series, 90000X/Q, Z-Series
Scope bandwidth	600 MHz - 4 GHz	500 MHz - 8 GHz	2.5 GHz - 13 GHz	8 GHz - 33 GHz (V-Series) 13 GHz - 33 GHz (90000X) 16 GHz - 63 GHz (90000Q) 20 GHz - 63 GHz (90000Z)
Probe interfac	AutoProbe	AutoProbe	AutoProbe	AutoProbe II
Standard probe	N2873A	N2873A		
InfiniiMax active probing system, page 5	1130A/31A/32A	N2830A/31A/32A, 1130A/31A/32A/34A, 1168A/69A	N2830A/31A/32A, 1131A/32A/34A, 1168A/69A	N2800A/81A/82A/83A, N7000A/71A/72A/73A
Active termination adapter, page 25	–	–	–	N7010A (except for 90000X)
InfiniiMode active probes, page 26	N2750A/51A/52A	N2750A/51A/52A	N2750A/51A /52A	N2750A/51A/52A with N5442A
Single-ended active probes, page 29	N2795A/96A/97A, N7020A	N2795A/96A/97A, N7020A	N2795A/96A/97A	N2795A/96A/97A with N5442A
General purpose differential active probes, page 32	N2790A/91A, N2818A/19A, 1141A, N2804A/05A	N2790A/91A, N2818A/19A, 1141A, N2804A/05A	N2791A/N2891A with E2697A, 1141A, N2818A/19A /04A/05A	N2790A/91A/891A with N5449A, N2818A/19A/04A/05A with N5442A
Current probes, page 35	1146B/47B, N2780B/81B/82B/83B/N2893A, N2820A/21A	1146B/47B, N2780B/81B/82B/83B/ N2893A, N2820A/21A	1146B, N2780B/81B/82B/83B with E2697A	1147B, N2893A with N5449A
General purpose passive probes, page 40	N2870A-76A, 10073D, 10070D, 1165A	N2870A-76A, 10073D, 10070D, 1165A	N2870A-76A, 10073D, 10070D, 1165A with E2697A	N2873A with N5449A (N5449A includes one N2873A)
High voltage passive probes, page 46	10076C, N2771B	10076C, N2771B	10076C, N2771B with E2697A	10076C, N2771B with N5449A

* The 1147B, N2790A and N2893A are not compatible with 80000, 90000 and 90008 Series scopes.



InfiniiMax Active Probe System Overview

The InfiniiMax probing system offers you the highest performance available for measuring differential and single-ended signals, with flexible connectivity solutions for today’s high-density ICs and circuit boards. Keysight Technologies, Inc. pioneered “probe head” type probes starting with the InfiniiMax I probe system in 2003. InfiniiMax I boasted a 7 GHz bandwidth and provided both differential and single-ended probe heads to fit multiple use models. The “probe head” topology allows higher performance. It allows more flexibility in the use models accommodating browser, solder-in, SMA etc.

In 2005 Keysight released InfiniiMax II 1168A/69A Series. This continued the probe head style probe topology while boosting the bandwidth to 13 GHz. The technology used for InfiniiMax II is the same as the one for InfiniiMax I except for the use of a new 70 GHz SiGe bipolar IC process. InfiniiMax II set new standards for performance, low noise, and low loading.

While the 13 GHz bandwidth of the InfiniiMax II probe system is still very adequate for many measurement needs, the extreme speeds of emerging serial data and communication technologies has driven the need for even higher performance levels. To respond to this need, Keysight has developed the InfiniiMax III 30 GHz probing system. A wide range of probe heads allows connection using a browser, ZIF (zero insertion force) tip, 2.92-mm or 3.5-mm SMA cable, or solder-in tips.

The new InfiniiMax III+ probe system is greatly expanding the measurement capability and usability of probes capable of measuring all the components of a differential signal. With a single connection, InfiniiMax III+ can be set to measure the differential or single-ended A or B, or the common mode component of a differential signal.



	InfiniiMax I 1130A-34A	InfiniiMax II 1168A/69A	InfiniiMax III N2800A-03A	InfiniiMax III+ N2830A-32A	InfiniiMax III+ N7000A-03A
Probe interface	AutoProbe I	AutoProbe I	AutoProbe II	AutoProbe I	AutoProbe II
1.5 GHz	1130A (D, SE)				
3.5 GHz	1131A (D, SE)				
4 GHz				N2830A (IM)	
5 GHz	1132A (D, SE)				
7 GHz	1134A (D, SE)				
8 GHz				N2831A (IM)	N7000A (IM)
10 GHz		1168A (D, SE)			
13 GHz		1169A (D, SE)		N2832A (IM)	N7001A (IM)
16 GHz			N2800A (D, SE)		N7002A (IM)
20 GHz			N2801A (D, SE)		N7003A (IM)
25 GHz			N2802A (D, SE)		
30 GHz			N2803A (D, SE)		

D: Differential, SE: Single-ended, IM: InfiniiMode

Modern high speed digital applications have pushed the limit of high bandwidth and high performance probing solutions. Keysight offers four different Infiniium probe families to meet today's challenging high speed measurement needs -- Infiniium I/II/III/III+.

Each of these solutions has its own, unique value. The principle difference is found in the key performances, functions and tasks that optimize each for its intended applications.

Note that Infiniium I and II probe probe heads are compatible to each other, but they are not compatible with Infiniium III/III+ and vice versa.

	Infiniium I/II	Infiniium III+	Infiniium III
Bandwidth	1.5 – 12 GHz	4 – 20 GHz	16 – 30 GHz
Probe loading	50 k Ω diff at DC	100 k Ω diff at DC 1 k Ω diff at > 10 kHz	100 k Ω diff at DC 1 k Ω diff at > 10 kHz
InfiniiumMode	No	Yes	No
Available probe heads/tips	Browser (diff, SE), Solder-in (diff, SE), ZIF (diff), QuickTip (diff), (Socketted (diff), SMA (diff))	Browser (diff), Solder-in (InfiniiumMode, diff), ZIF (diff), QuickTip (InfiniiumMode w/Infiniium III+, diff with Infiniium III), 2.92mm/SMA (InfiniiumMode w/Infiniium III+)	
Probe interface	AutoProbe I	AutoProbe I (N2830A Series) AutoProbe II (N7000A Series)	AutoProbe II
When to use	<12 GHz	InfiniiumMode	High speed signals with low source impedance or with embedded clock
When not to use	>12 GHz, InfiniiumMode	Signal with “high Z” typically found in mobile device communication standards and devices (e.i., MIPI d-phy, LP DDR, eMMC etc)	

InfiniiMax Active Probe System Overview – InfiniiMax III/III+ Probing System

Key features

- Full 30 GHz bandwidth to the probe tip
- InfiniiMode probing for making differential, single-ended and common mode measurements with a single probe (InfiniiMax III+)
- Industry’s highest fidelity and accuracy due to bandwidth and extremely low loading
- Probe amplifiers loaded with measured S-parameters for more accurate response correction
- Bandwidth upgradeable (InfiniiMax III only)
- Variety of probe heads for different use models with maximum usability

Scope compatibility

Scope family	Compatible probes
V-Series, 90000X/Q, Z-Series	N2800A, N2801A, N2802A, N2803A, N7000A, N7001A, N7002A, N7003A
S-Series, 90000A Series	N2830A, N2831A, N2832A

The InfiniiMax III/III+ probing system provides the highest performance and low loading to allow for a completely new level of signal fidelity and accuracy. Eleven different InfiniiMax III/III+ probe amplifiers ranging from 4 GHz to 30 GHz are available for matching your probing solution to your performance and budget requirements. The InfiniiMax III+ probing system is the next generation of InfiniiMax probing. It greatly expands the measurement capability and usability of probes capable of measuring all components of a differential signal with the built-in InfiniiMode technology.

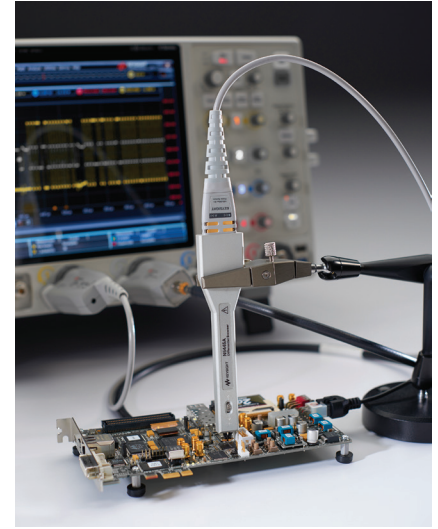

InfiniiMax III amp with ZIF head/tips

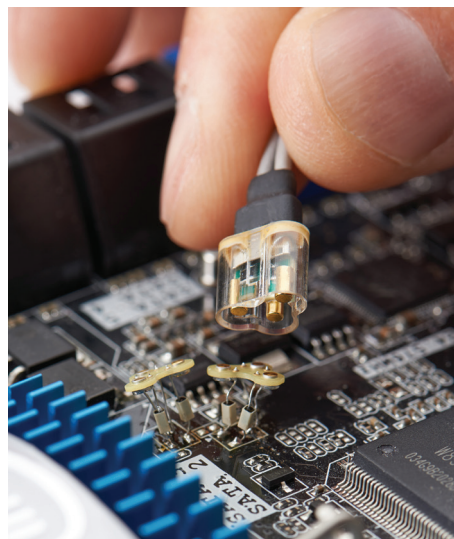

QuickTip head and tip

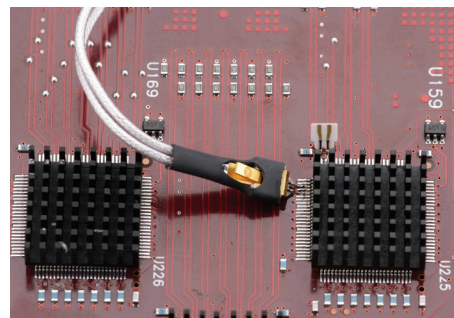

InfiniiMax III ZIF head and tip



N2830A InfiniiMax III+ amp with QuickTip head

InfiniiMax Active Probe System Overview – InfiniiMax III/III+ Probing System (continued)

Characteristics performance plots: N2803A 30-GHz probe amp with N5445A 30-GHz browser

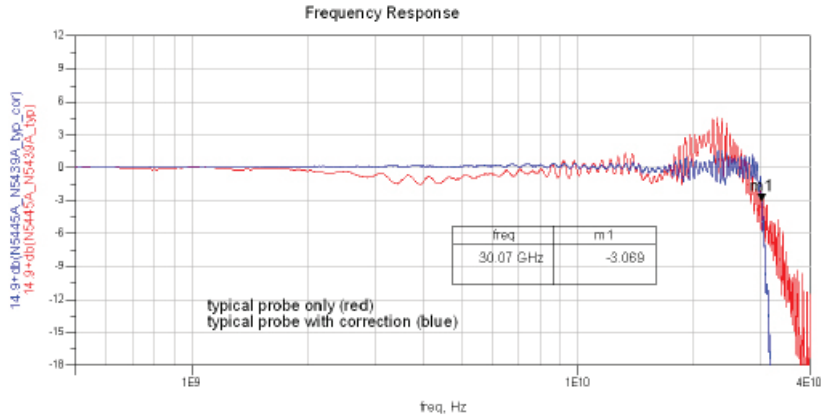

Frequency response plot with 1 mm span

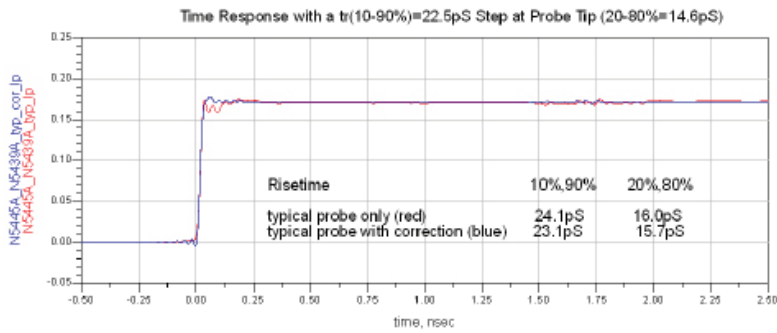

Time domain response plot with 1 mm span

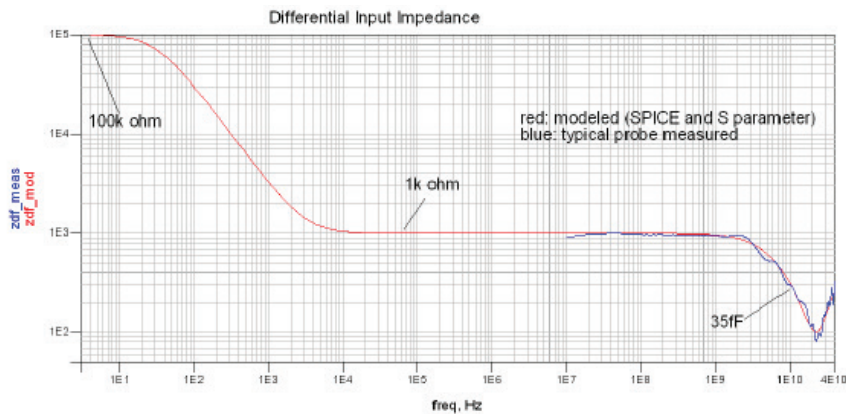





Differential input impedance

InfiniMax Active Probe System Overview – InfiniMax III/III+ Probing System (continued)

InfiniMax III/III+ probe heads

InfiniMax III/III+ probe heads are recommended for InfiniMax III N2800A/01A/02A/03A and InfiniMax III+ N2830A/31A/32A and N7000A/01A/02A/03A probe amplifiers. Any probe heads for InfiniMax I or II are not compatible with InfiniMax III or III+ amplifier and vice versa.

Probe heads	Model numbers	BW and input loading	Key features
Differential browser head 	N5445A	30 GHz, Cdiff = 35 fF, Cse = 50 fF, Rdiff = 100 k Ω , Rse = 50 k Ω	Z axis compliance and variable spacing from 20 mil to 125 mils, integrated LED lighting
ZIF probe head/tips 	N5439A head, N2838A 450 Ω PCB tip, N5440A 450 Ω ceramic tip, N5447A 200 Ω ceramic tip	28 GHz, Cdiff = 95 fF, Cse = 130 fF, with N2838A: Cdiff = 32 fF, Cse = 44 fF, with N5440A: Rdiff = 100 k Ω , Rse = 50 k Ω N5447A: Rdiff = 50 k Ω , Rse = 25 k Ω with N5440A/N2838A	Extremely low loading, Variable spacing from 5 mil to 80mil, User replaceable damping resistor tips (N2838A only)
2.92 mm/3.5 mm/SMA probe head 	N5444A	28 GHz, N/A, 55 Ω to Vterm	Provides termination voltage of ± 4 V controlled by scope or externally. Supports InfiniMode with InfiniMax III+ amp
Solder-in head 	N5441A N2836A	16 GHz, Cdiff = 77 fF, Cse = 105 fF, Rdiff=100 k Ω , Rse = 50 k Ω 26 GHz, Cdiff = 108 fF, Cse = 140 fF, Rdiff=100 k Ω , Rse=50 k Ω	Economical and semi-permanent connection, variable span of leads ranges from 5 mil to 80 mil, user replaceable damping resistor tips (N2836A only). N2836A supports InfiniMode with InfiniMax III+ amp
Quick tip 	N2848 QuickTip head for InfiniMax III/III+, N2849A QuickTip tips	16 GHz (with InfiniMax III/III+), 13 GHz (with InfiniMax II), Cdiff = 340 fF, Cse = 200 fF	Compatible with I/II/III/III+ amp. Supports InfiniMode with InfiniMax III+ amp. For using QuickTip with InfiniMax I/II amp, choose the N2851A QuickTip head for InfiniMax I/II and N2849A QuickTip tips.

InfiniMax Active Probe System Overview – InfiniMax III/III+ Probing System (continued)

InfiniMax III/III+ probing system family diagram

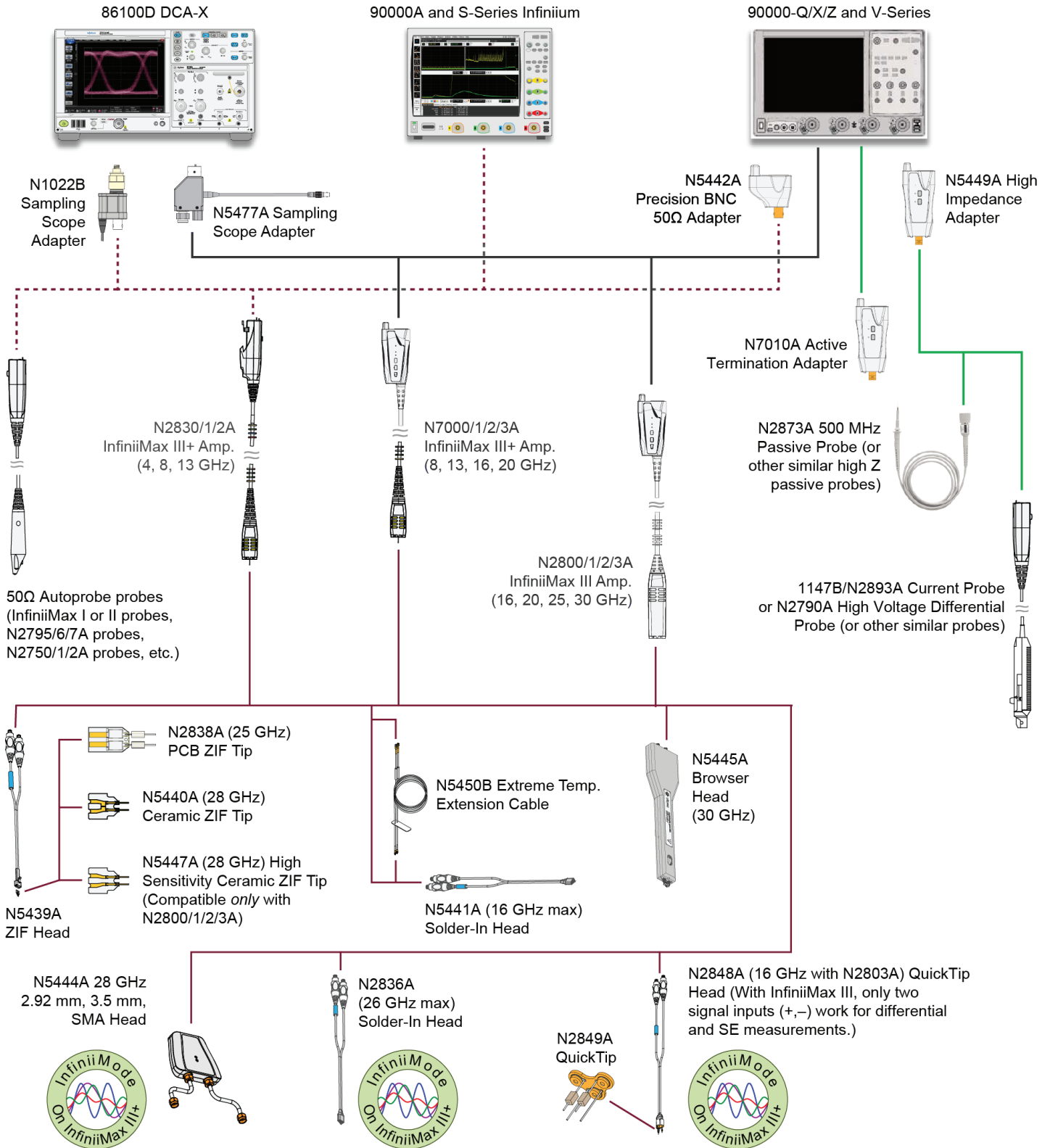

InfiniiMax Active Probe System Overview – InfiniiMax III/III+ Probing System (continued)

Performance specifications and characteristics

InfiniiMax III/III+ warranted specifications

Probe head	Probe amp	Bandwidth	DC input
N5440A_N5439A ceramic 450 Ω ZIF tip and ZIF probe head	N2803A 30 GHz probe amp	26 GHz	Rdiff = 100 kΩ ± 2%, Rse = 50 kΩ ± 2%
N5445A 450 Ω browser	N2803A 30 GHz probe amp	28 GHz	Rdiff = 100 kΩ ± 2%, Rse = 50 kΩ ± 2%
N2836A 450 Ω solder-in probe head vertical orientation with no ground wires	Differential mode N2832A 13-GHz probe amp	13 GHz	Rdiff = 100 kΩ ± 2%, Rse = 50 kΩ ± 2%

InfiniiMax III/III+ probe head characteristics

These characteristics are mainly determined by the probe head. Performance numbers listed are: -3 dB bandwidth/10-90% transition time/20-80% transition time. Performance listed is with the highest bandwidth probe amp models in each family. Performance with lower bandwidth amps is the lower of the: AmpBW, (.434/AmpBW), (.308/AmpBW), or bandwidth measured with the highest bandwidth amp in the family.

Probe head	Input C	InfiniiMax III N2803A 30-GHz probe amp	InfiniiMax III+ N7003A 20-GHz probe amp		
		Differential mode	Differential mode	Single-ended mode	Common mode
N5440A_N5439A ceramic 450 Ω ZIF tip and ZIF probe head	Cdiff=32 fF; Cse=44 fF	28 GHz, 15.5 pS, 11.0 pS	20 GHz, 21.7 pS, 15.4 pS	n/a	
N5447A_N5439A ceramic 200 Ω ZIF tip and ZIF probe head	Cdiff=32 fF; Cse=44 fF	28 GHz, 15.5 pS, 11.0 pS	n/a		
N5445A 450 Ω browser	Cdiff=35 fF; Cse=50 fF	30 GHz, 14.5 pS, 10.3 pS	20 GHz, 21.7 pS, 15.4 pS	n/a	
N5441A 450 Ω solder-in probe head	Cdiff = 77 fF; Cse = 105 fF	17.2 GHz, 34.8 pS, 26.6 pS	20 GHz, 21.7 pS, 15.4 pS	n/a	
N2838A_N5439A PC board 450 Ω ZIF tip and ZIF probe head	Cdiff=95 fF; Cse=130 fF	25 GHz, 17.4 pS, 12.3 pS	20 GHz, 21.7 pS, 15.4 pS	n/a	
N2836A 450 Ω solder-in probe head vertical orientation with no ground wires	Cdiff=108 fF; Cse=140 fF	27 GHz, 16.1 pS, 11.4 pS	20 GHz, 21.7 pS, 15.4 pS	n/a	
N2836A 450 Ω solder-in probe head flat orientation with minimum length ground wires	Cdiff=108 fF; Cse=140 fF	27 GHz, 16.1 pS, 11.4 pS	Differential: 20 GHz, 21.7 pS, 15.4 pS Single-ended: 20 GHz, 21.7 pS, 15.4 pS Common mode: 20 GHz, 21.7 pS, 15.4 pS		
N2849A_N2848A 450 Ω QuickTip and QuickTip probe head with ground wires connected	Cdiff=200 fF; Cs=340 fF	16 GHz, 27.1 pS, 19.3 pS	Differential: 20 GHz, 21.7 pS, 15.4 pS Single-ended: 13 GHz, 33.4 pS, 23.7 pS Common mode: 13 GHz, 33.4 pS, 23.7 pS		
N5444A 2.92 mm, SMA, 3.5 mm probe head	n/a	28 GHz, 15.5 pS, 11.0 pS	Differential: 20 GHz, 21.7 pS, 15.4 pS Single-ended: 20 GHz, 21.7 pS, 15.4 pS Common mode: 20 GHz, 21.7 pS, 15.4 pS		

InfiniiMax Active Probe System Overview – InfiniiMax III/III+ Probing System (continued)

InfiniiMax III/III+ probe amp characteristics

These characteristics are mainly determined by the probe amp.

	N280XA InfiniiMax III probe amp		N700xA InfiniiMax III+ probe amp		
Features	450 Ω probe heads	200 Ω probe heads	N5444A 2.92 mm, SMA, 3.5 mm probe head	450 Ω probe heads	N5444A 2.92 mm, SMA, 3.5 mm probe head
DC input resistance	Rse=50 k Ω \pm 2% each input to ground, Rdiff=100 k Ω \pm 2% and Rcm=25 k Ω \pm 2%	Rse=50 k Ω \pm 2% each input to ground, Rdiff=100 k Ω \pm 2% and Rcm=25 k Ω \pm 2%	55 Ω to Vterm	Rse=50 k Ω \pm 2% each input to ground, Rdiff=100 k Ω \pm 2% and Rcm=25 k Ω \pm 2%	55 Ω to Vterm
Input resistance >10 kHz	Rse=500 Ω each input to ground, Rdiff=1 k Ω and Rcm=250 Ω	Rse=500 Ω each input to ground, Rdiff=1 k Ω and Rcm=250 Ω	50 Ω to .901*Vterm	Rse=500 Ω each input to ground, Rdiff=1 k Ω and Rcm=250 Ω	50 Ω to .901*Vterm
Input voltage range (differential or single-ended)	1.6 Vpp, \pm 0.8 V (HD2&3 < -34 dbc), 2.5 Vpp, \pm 1.25 V (HD2&3 < -38 dbc)	0.8 Vpp, \pm 0.4 V (HD2&3 < -34 dbc), 1.6 Vpp, \pm 0.8 V (HD2&3 < -38 dbc)	1.6 Vpp, \pm 0.8 V (HD2&3 < -34 dbc), 2.5 Vpp, \pm 1.25 V (HD2&3 < -38 dbc)	2.5 Vpp or \pm 1.25 V at 5:1 attenuation, 5.0 Vpp or \pm 2.50 V at 10:1 attenuation	2.5 Vpp or \pm 1.25 V at 5:1 attenuation, 5.0 Vpp or \pm 2.50 V at 10:1 attenuation without violating max input power
Max input power	n/a	n/a	125 mW calculated by $\{[rms(vin-vterm)]^2/55\}$ for each input	n/a	125 mW calculated by $\{[rms(vin-vterm)]^2/55\}$ for each input
Input common mode range	\pm 12 VDC to 250 Hz, \pm 1.25 V > 250 Hz	\pm 6 VDC to 250 Hz, \pm 0.65 V > 250 Hz	\pm 6 VDC to 250 Hz, \pm 1.25 V > 250 Hz without violating max input power	\pm 7 VDC to 100 Hz, \pm 1.25 V > 100 Hz at 5:1 attenuation, \pm 2.5 V > 100 Hz at 10:1 attenuation	\pm 6 VDC to 100 Hz, \pm 1.25 V > 100 Hz at 5:1 attenuation, \pm 2.5 V > 100 Hz at 10:1 attenuation without violating max input power
DC attenuation ratio	6:1	3:1	6:1	5:1 or 10:1 Automatically selected based on volts/division (all modes)	5:1 or 10:1 Automatically selected based on volts/division (all modes)
Offset range (for probing a single-ended signal)	\pm 16 V	\pm 8 V	\pm 6 V without violating max input power	\pm 16 V	\pm 6 V without violating max input power
Input referred noise spectral density	23.9 nV/rt (Hz)	12.0 nV/rt (Hz)	23.9 nV/rt (Hz)	Diff 5:1 atten 33.5 nV/rt(Hz), Diff 10:1 atten 53.9 nV/rt(Hz), SE A or B 5:1 atten 27.8 nV/rt(Hz), SE A or B 10:1 atten 47.7 nV/rt(Hz), CM 5:1 atten 21.8 nV/rt(Hz), CM 10:1 atten 38.4 nV/rt(Hz)	
Input referred noise example	4 mVrms with 28 GHz probe head and 30 GHz probe amp	2 mVrms with 28 GHz probe head and 30 GHz probe amp	4 mVrms	4.5 mVrms in diff mode 5:1 atten with \geq 18 GHz probe head and 13 GHz probe amp	4.5 mVrms in diff mode 5:1 atten with 28 GHz N5444A probe head and 13 GHz probe amp
Maximum input voltage	18 Vpeak Cat 1	18 Vpeak Cat 1	8 Vpeak without violating max input power	18 Vpeak Cat 1	8 Vpeak without violating max input power

Infiniium Active Probe System Overview – Infiniium III/III+ Probing System (continued)

Ordering information

Infiniium III/III+ probe amplifier models

Model number	Description	Recommended oscilloscope
N2803A	30 GHz Infiniium III probe amplifier	Infiniium 90000X/Q, Z-Series 28 GHz - 63 GHz models
N2802A	25 GHz Infiniium III probe amplifier	Infiniium 90000X/Q, Z-Series 25 GHz models
N7003A	20 GHz Infiniium III+ probe amplifier	Infiniium V-Series, 90000Q, Z-Series 20 GHz models
N2801A	20 GHz Infiniium III probe amplifier	Infiniium 90000X/Q, Z-Series 20 GHz models
N7002A	16 GHz Infiniium III+ probe amplifier	Infiniium V-Series, 90000X Series 16 GHz models
N2800A	16 GHz Infiniium III probe amplifier	Infiniium 90000X Series 16 GHz models
N7001A	13 GHz Infiniium III+ probe amplifier	Infiniium V-Series, 90000X Series 13 GHz models
N2832A	13 GHz Infiniium III+ probe amplifier	Infiniium 90000X 13 GHz and 90000A models
N7000A	8 GHz Infiniium III+ probe amplifier	Infiniium V-Series 8 GHz models
N2831A	8 GHz Infiniium III+ probe amplifier	Infiniium 90000A and S-Series
N2830A	4 GHz Infiniium III+ probe amplifier	Infiniium 90000A and S-Series

Note: Infiniium III and III+ probe amps are not compatible with existing Infiniium I or II probe heads.

Infiniium III/III+ probe heads

Model number	Description	Notes
N2848A	Infiniium III QuickTip probe head	Compatible with Infiniium III/III+ amp Supports InfiniiumMode with Infiniium III+ amp , Order N2849A QuickTip tips (set of 4)
N5445A	Infiniium III browser head	Order N5476A for replacement probe tips (set of 4)
N5439A	Infiniium III ZIF probe head	Order N2838A PC board ZIF (450 Ω), N5440A Ceramic ZIF (450 Ω) or N5447A Ceramic ZIF (200 Ω) for a set of 5 ZIF tips with plastic sporks
N5444A	Infiniium III 2.92 mm/3.5 mm/SMA probe head	Order N5448A 2.92 mm head flex cables to extend the cable length. Supports InfiniiumMode with Infiniium III+ amp
N5441A	Infiniium III 16 GHz solder-in probe head	
N2836A	Infiniium III 26 GHz solder-in probe head	Supports InfiniiumMode with Infiniium III+ amp

Note: N54xxA Infiniium III/III+ probe heads are not compatible with Infiniium I or II probe amps.

Infiniium III probe adapters

Model number	Description	Notes
N5442A	Precision BNC adapter (50 Ω)	For use with Infiniium I/II/III+ 1130A/31A/32A/34A/68A/69A and N2830A/31A/32A probes, N2750A-52A, N2795A/96A/97A, 1156A-58A etc.
N5449A	High impedance probe adapter	Includes one N2873A 500MHz 10:1 passive probe
N5477A	Sampling scope adapter	For Infiniium III amp to use with Keysight 86100C DCA-J sampling scope
N1022B	Probe adapter	For Infiniium III+ amp to use with 86100C DCA-J sampling scope
N5443A	Performance verification and deskew fixture	For Infiniium III and Infiniium III+ > 13 GHz
E2655C	Performance verification and deskew fixture	For Infiniium III+ <=13 GHz and Infiniium I/II

InfiniiMax Active Probe System Overview – InfiniiMax III/III+ Probing System (continued)

Ordering information (cont'd)

Probe bandwidth upgrade options (for InfiniiMax III only)

Model number	Description	Notes
N5446A-001	16 GHz to 20 GHz bandwidth upgrade	
N5446A-002	20 GHz to 25 GHz bandwidth upgrade	
N5446A-003	25 GHz to 30 GHz bandwidth upgrade	
N5446A-004	16 GHz to 25 GHz bandwidth upgrade	
N5446A-005	16 GHz to 30 GHz bandwidth upgrade	
N5446A-006	20 GHz to 30 GHz bandwidth upgrade	

Note: Purchase two or more upgrade options to go from 16 to 25 or 30 GHz and 20 to 30 GHz. To upgrade the probe bandwidth, you simply need to send the probe to the Keysight service center.

Other recommended accessories for InfiniiMax III/III+ probing system

Model number	Description	Notes
N2787A	3D probe positioner	For hands-free probing
N5450B	Extreme temperature extension cable	1 m long, use N5441A solder-in head for extreme temperature probing with InfiniiMax III/III+
N2812A	High performance input cable, 2.92 mm connectors, 1 m length	For use with Infiniium 90000-X/Q Series oscilloscope
MV-23	Carson Optical MagniVisor	www.carsonoptical.com/Magnifiers

InfiniiMax Active Probe System Overview – InfiniiMax II Probing System

Key features

- Up to 13 GHz bandwidth for differential, solder-in, browser and SMA connections
- Low noise and flat frequency response
- Industry's widest variety of differential probe head types

Scope compatibility

Scope family	Recommended probes
DSO90000, DSA90000, DS080000, DSA80000 Series	1168A, 1169A

The InfiniiMax II series 1168A/69A probing system designed to be used with Infiniium 80000A and 90000A Series oscilloscopes provides real-time bandwidth to 12 GHz specified and has 13 GHz typical performance. The innovative InfiniiMax probing system supports even the most demanding mechanical access requirements without sacrificing performance.

Characterized performance plots: 1169A with N5381A differential solder-in probe head

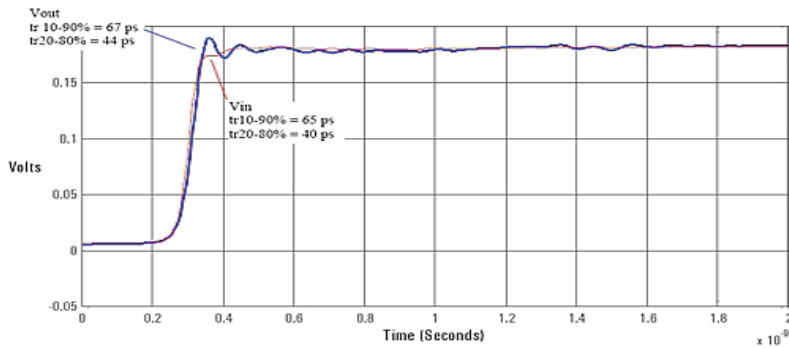

Graph of Vin and Vout of 1169A and N5381A solder-in head with a 25 Ω 58 psec step generator

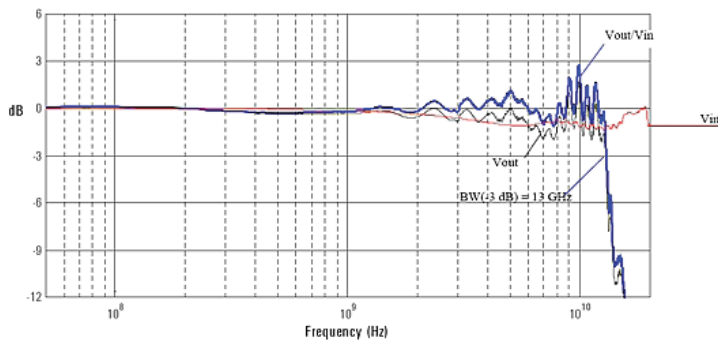

Frequency response of 1169A and N5381A with a 25 Ω source

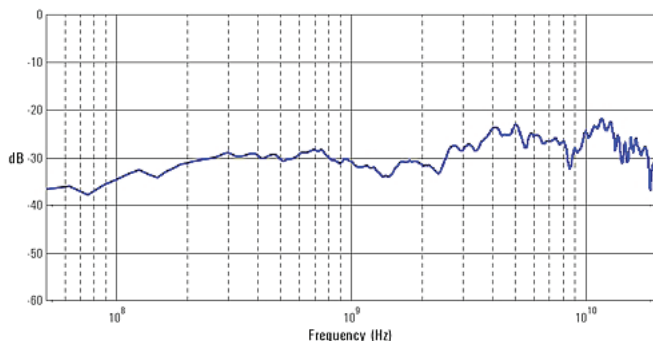

Common mode rejection ratio of 1169A

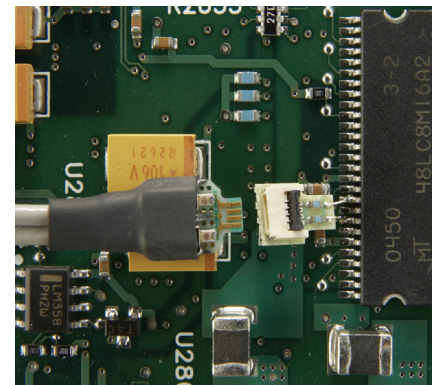
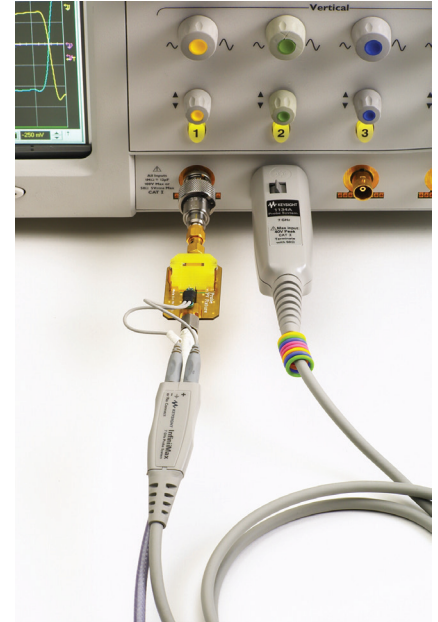

InfiniiMax Active Probe System Overview – InfiniiMax II Probing System (continued)

Ordering information

InfiniiMax II Series probe amplifiers

Model number	Bandwidth	Description
1169A	12 GHz (spec) 13 GHz (typical)	InfiniiMax II probe amplifier – order one or more probe heads
1168A	10 GHz	InfiniiMax II probe amplifier – order one or more probe heads

InfiniiMax probe amplifier specifications: Dynamic range = 3.3 V, DC offset range = ± 16 V, maximum voltage = ± 30 V

InfiniiMax II Series probe heads

InfiniiMax II Series probe heads are recommended for 1169A/68A probe amplifiers. When used with a DSO81304A or DSO91304A, the N5380B, N5381A, and N5382A will typically achieve 13 GHz bandwidth.

Probe head	Model number	Differential measurement (BW, input C, input R)	Single-ended measurement (BW, input C, input R)
Hi-BW differential SMA	N5380B	12 GHz	12 GHz
Hi-BW differential solder-in	N5381A	12 GHz, 0.21 pF, 50 k Ω	12 GHz, 0.35 pF, 25 k Ω
Hi-BW differential browser	N5382A	12 GHz, 0.21 pF, 50 k Ω	12 GHz, 0.35 pF, 25 k Ω
ZIF solder-in	N5425A		
	with N5426A	12 GHz, 0.33 pF, 50 k Ω	12 GHz, 0.53 pF, 25 k Ω
	with N5451A 7mm, 0 deg	9.9 GHz, – , 50 k Ω	9.9 GHz, 0.6 pF, 25 k Ω
	with N5451A 11mm, 0 deg	5 GHz, – , 50 k Ω	5 GHz, 0.68 pF, 25 k Ω
	with N2884A	12 GHz, 350 fF, 50 k Ω	12 GHz, 320 fF, 25k Ω

InfiniiMax I Series probe heads can be used with 1169A/68A probe amplifiers with limitations.

Probe head	Model number	Differential measurement (BW, input C, input R)	Single-ended measurement (BW, input C, input R)
Differential solder-in (Higher loading, high frequency response variation)	E2677A	12 GHz, 0.27 pF, 50 k Ω	12 GHz, 0.44 pF, 25 k Ω
Differential socket (Higher loading)	E2678B	12 GHz, 0.34 pF, 50 k Ω	12 GHz, 0.56 pF, 25 k Ω
Differential browser – wide span	E2675B	6 GHz, 0.32 pF, 50 k Ω	6 GHz, 0.57 pF, 25 k Ω
Single-ended solder-in (must bandlimit input to ≤ 6 GHz)	E2679A	N/A	6 GHz, 0.50 pF, 25 k Ω
Single-ended browser	E2676A	N/A	6 GHz, 0.67 pF, 25 k Ω

InfiniiMax Active Probe System Overview – InfiniiMax II Probing System (continued)

Overcoming measurement challenges with InfiniiMax probe

InfiniiMax probe is not just for Infiniium scope

The benefits of Keysight’s award winning InfiniiMax probes are not restricted to Keysight Infiniium oscilloscopes. A variety of accessories are available that allow you to use InfiniiMax probes with other test equipment, such as spectrum analyzers and sampling oscilloscopes.

To learn more about how to use the InfiniiMax probe with your test equipment other than Keysight Infiniium oscilloscopes, refer to the Keysight literature number 5989-1869EN.

Operating at high or low temperatures

You may need to monitor a system in a temperature chamber with an oscilloscope probe to verify performance over a wide range of operating temperatures, or to determine the cause of failures at high or low temperatures. Keysight InfiniiMax I/II probe amplifiers have a specified operating temperature range from 5 °C to 40 °C. However, the probe heads can be operated over a much wider range. You can use the Keysight N5450B extension cable set to physically separate the probe heads from the probe amplifiers. This will allow you to operate the probe heads inside a temperature chamber with the probe amplifier located outside the temperature chamber. To learn more about how to extend the operating range of the InfiniiMax probes in temperature, refer to the Keysight literature number 5989-7587EN.

Increasing the voltage dynamic range and offset range

The dynamic range of the InfiniiMax probes is 5 V p-p for InfiniiMax I and 3.3 V p-p for InfiniiMax II. For applications that need to measure larger signals with faster edges, the N2880A in-line coaxial attenuator kit allows you to increase the dynamic range of the probe system up to 50 Vpp and the offset range up to ± 30V, without affecting the bandwidth or rise time characteristics of the probe system. The N2881A DC blocking capacitors can be used in series with the N2880A InfiniiMax in-line attenuator to block out unwanted DC components of the input signal up to 30 V. To learn more about how to extend the operating range of the InfiniiMax probes in input range, refer to the Keysight literature number 5989-7587EN.

How would I measure small AC riding on top of large DC with InfiniiMax probe?

It is challenging to measure very small signals riding on top of large signals with scopes, as most scopes have limited dynamic ranges and offset ranges. Consider using an InfiniiMax active probe which provides a huge offset range that can allow you to make measurements you need. To learn more about how to use the InfiniiMax probe’s offset range, refer to the Keysight literature number 5990-8255EN and 5988-9264EN.

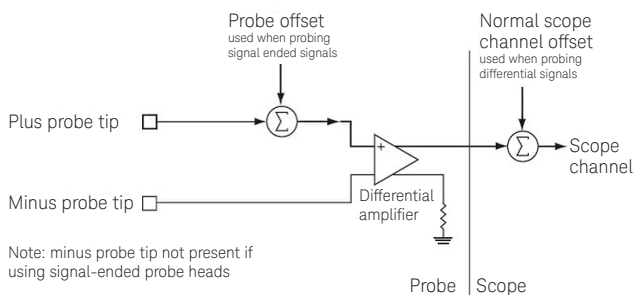
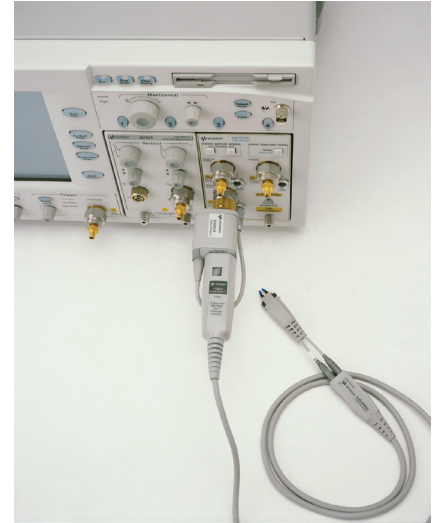

InfiniiMax Active Probe System Overview – InfiniiMax I and II Probing System

InfiniiMax offers you the highest performance available for measuring differential and single-ended signals, with flexible connectivity solutions for today’s high-density ICs and circuit boards.

InfiniiMax probes have fully characterized performance for all of their various probe heads. This includes:

- Swept frequency response plot
- Common mode rejection versus frequency plot
- Impedance versus frequency plot
- Time-domain probe loading plot
- Time-domain probe tracking plot

Controlled impedance transmission lines in every probe head deliver full performance versus the performance limitations introduced by traditional wire accessories.

Probe interface software allows you to save the calibration information for up to 10 different probe heads per channel and will automatically retrieve calibration data for a probe amplifier when attached to the scope.

High-input impedance active probes minimize loading, support differential measurements and DC offset, and can compensate for cable loss.

Probe calibration software delivers the most accurate probe measurements and linear phase response and allows various probe combinations to be deskewed to the same reference time.

A flat frequency response over the entire probe bandwidth eliminates the distortion and frequency-dependent loading effects that are present in probes that have an in-band resonance.

E2677A 12-GHz solder-in differential probe head can be attached to very-small-geometry circuits for measuring both single-ended and differential signals. External mini-coaxial resistors facilitate wider span but have increased high-frequency response variation relative to N5381A.

E2679A 6-GHz extremely small single-ended, solder-in probe heads for probing even the hardest-to-reach single-ended signals.

N5381A 13-GHz high-bandwidth solder-in differential probe head provides maximum bandwidth and minimizes capacitive loading to ≤ 210 fF. Variable spacing from 0.2 to 3.3 mm (8 to 130 mills).

N5425A 13-GHz high-bandwidth solder-in differential ZIF probe head and N5426A ZIF tip provides maximum bandwidth with the industry’s first lead-free solder-in probe solution in an economical replaceable tip form factor.

N5451A 9-GHz/5-GHz long-wire ZIF tip provides a high-bandwidth economical replaceable solder-in tip with extra reach (9 GHz with 7 mm and 5 GHz with 11 mm wire).

E2695A 8-GHz differential SMA probe head allows you to connect two SMA cables to make a differential measurement on a single scope channel. This probe head is discontinued. Use the N5380B as a replacement.

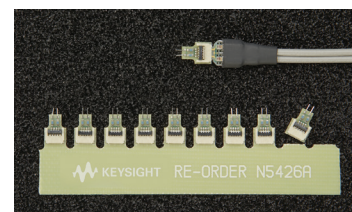

N5426A

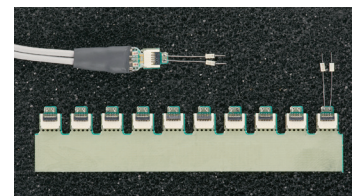

N5451A

InfiniiMax Active Probe System Overview – InfiniiMax I and II Probing System (continued)

Six different InfiniiMax probe amplifiers from 1.5 GHz to 13 GHz are available for matching your probing solution to your performance and budget requirements. The 1168/69A InfiniiMax II amplifiers offer up to 13 GHz of bandwidth and the lowest noise floors. The 1134/32/31/30A offer a more cost efficient solution and wider dynamic range.

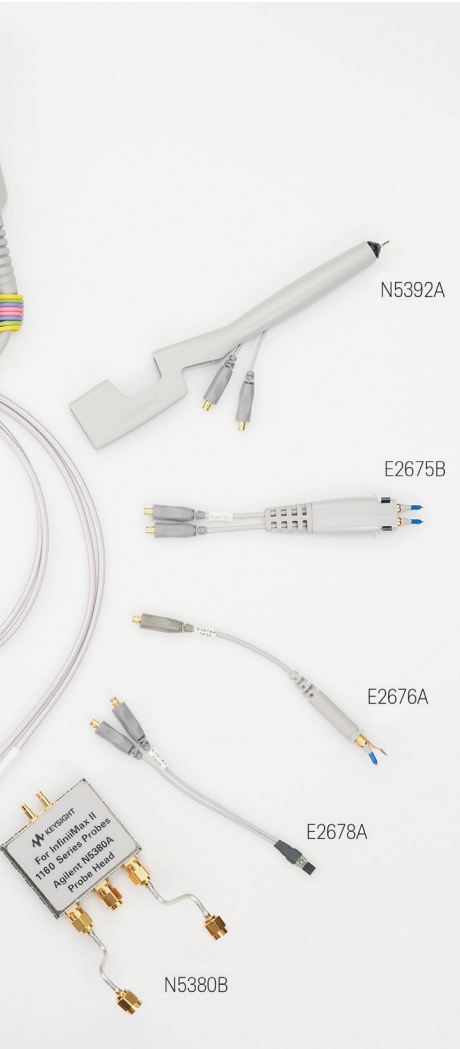

N5382A 13-GHz high-bandwidth differential browser provides maximum bandwidth for hand-held or probe holder use. Variable spacing from 0.2 to 3.3 mm (8 to 130 mills).

E2675B 6-GHz differential browser is the best choice for general-purpose trouble shooting of differential or single-ended signals with z-axis compliance and variable spacing from 0.25 - 5.80 mm (10 - 230 mills).

E2676A 6-GHz single-ended browser is the best choice for general-purpose probing of single-ended signals when the small size of the probe head is the primary consideration.

E2678B 12-GHz differential socket probe head can be used to measure either differential or single-ended signals via a plug-on socket connection.

N2880A In-line Attenuator Kit allows you to increase the dynamic range and the offset range of the InfiniiMax probe without affecting the bandwidth.

N2884A Differential Fine-wire Probing Tip InfiniiMax differential fine-wire probing tip is a high fidelity, high bandwidth solution for probing an active IC.

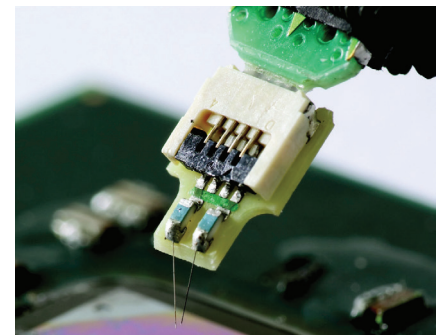

N2887A InfiniiMax Soft touch Pro Probe Adapter adapts from the Keysight Pro Series (36 ch) Soft touch connectorless logic analyzer foot print to the Keysight InfiniiMax I & II series probe amplifier input connectors.



N2888A InfiniiMax Soft touch half-channel Probe Adapter adapts from the Keysight half-channel (18 ch) Soft touch connectorless logic analyzer foot print to the Keysight InfiniiMax I & II series probe amplifier input connectors.

N5380B 13-GHz high-bandwidth differential SMA probe head provides maximum bandwidth for SMA-fixture differential pairs.

N5450B InfiniiMax extreme temperature extension cable provides extra reach into environmental chambers.



N2881A DC Blocking Capacitors can be used to in series with the N2880A InfiniiMax in-line attenuators to block out unwanted DC components of the input signal up to 30 V.

InfiniiMax Active Probe System Overview – InfiniiMax II Probing System (continued)

InfiniiMax II probing system tree diagram

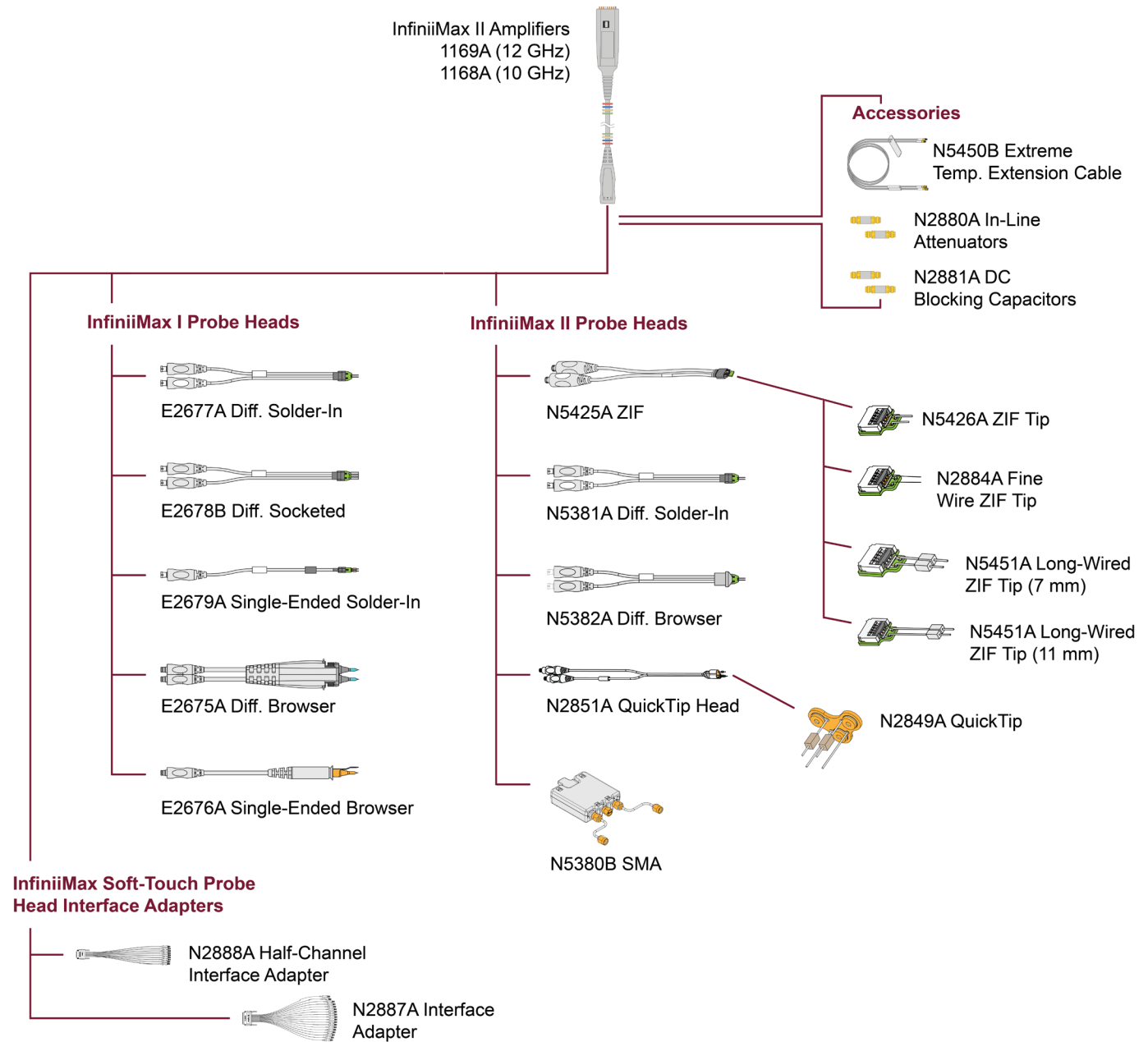

InfiniiMax Active Probe System Overview – InfiniiMax II Probing System (continued)

Performance characteristics

	1169A	1168A
Bandwidth*	1169A: > 12 GHz (13 GHz typical)	1168A: > 10 GHz
Rise and fall time		
Probe only	1169A: 28 ps (20 - 80%), 40 ps (10 - 90%)	1168A: 34 ps (20 - 80%), 48 ps (10 - 90%)
When phase compensated by 90000A Series oscilloscope	1169A w/91204A: 25 ps (20 - 80%) 36 ps (10 - 90%) 1169A w/91304A: 23 ps (20 - 80%) 33 ps (10 - 90%)	1168A w/90804A: 38 ps (20 - 80%) 54 ps (10 - 90%)
System bandwidth (-3 dB)	1169A w/91304A: 13 GHz (typical) 1169A w/91204A: 12 GHz	1168A w/90804A: 8 GHz
Input capacitance ¹	C _m = 0.09 pF C _g = 0.26 pF C _{diff} = 0.21 pF C _{se} = 0.35 pF	C _m is between tips C _g is to ground for each tip Differential mode capacitance = C _m + C _g /2 Single-ended mode capacitance = C _m + C _g
Input resistance*	Differential mode resistance = 50 k Ω \pm 2% Single-ended mode resistance = 25 k Ω \pm 2%	
Input dynamic range	3.3 V peak to peak, \pm 1.65 V	
Input common mode range	\pm 6.75 V dc to 100 Hz; \pm 1.25 V > \pm 100 Hz	
Maximum signal slew rate	25 V/ns when probing a single-ended signal 40 V/ns when probing a differential signal	
DC attenuation	3.45:1	
Zero offset error referred to input	\pm 1.5 mV	
Offset range	\pm 16.0 V when probing single-ended	
Offset gain accuracy	< \pm 1% of setting when probing single-ended	
Noise referred to input	2.5 mV rms, probe only	
Propagation delay	~6 ns (this delay can be deskewed relative to other signals)	
Maximum input voltage	30 V peak, CAT I	
ESD tolerance	> 8 kV from 100 pF, 300 Ω HBM	
Temperature	Operating: 5 °C to +40 °C Non-operating: 0 °C to +70 °C	

InfiniiMax Active Probe System Overview – InfiniiMax I Probing System

Key features

- Up to 7 GHz bandwidth for differential, solder-in, browser and SMA connections
- Low noise and flat frequency response
- Wide dynamic range (± 2.5 V) and offset range (± 12 V)



Scope compatibility

Scope family	Recommended probes
DSO/DSA90604A	1134A
DSO/DSA90404A, DSO/MSO9404A	1132A
DSO/DSA90254A, DSO/MSO9254A, 54845/46/53A/B	1131A
DSO/MSO9104A, 9064A, 8104A, 5483xB/D	1130A

For high-speed differential or single-ended probing in embedded designs, the InfiniiMax 1130A Series differential probe amplifiers are perfect complements to the Infiniium 600 MHz – 6 GHz oscilloscopes. Its extremely low input capacitance, flat frequency response and the patented resistor probe tip technology provide ultra low loading of the DUT and superior signal fidelity.

Characterized performance plots: with E2677A differential solder-in probe head

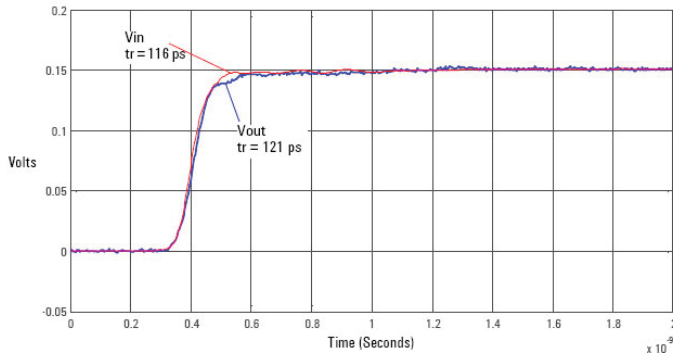

Vin and Vout of probe with a 25 Ω , 100 psec step signal

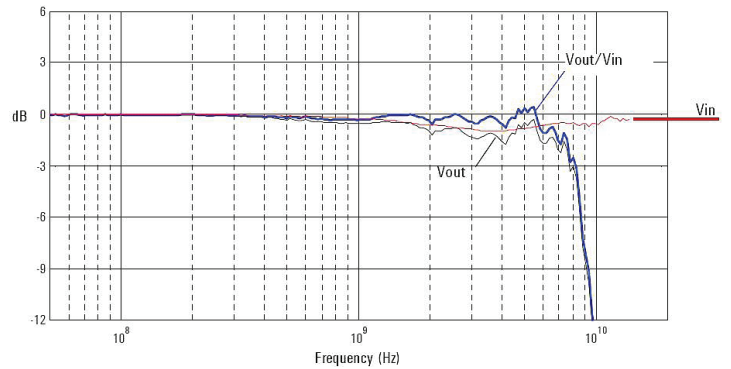

Swept frequency response with a 25 Ω source

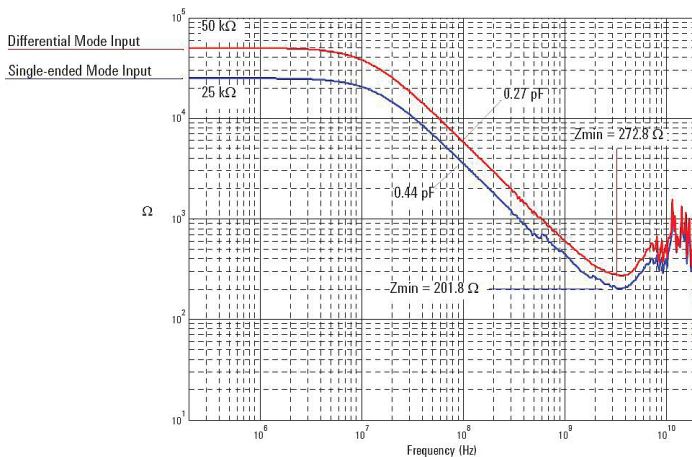

Probe input impedance vs. frequency

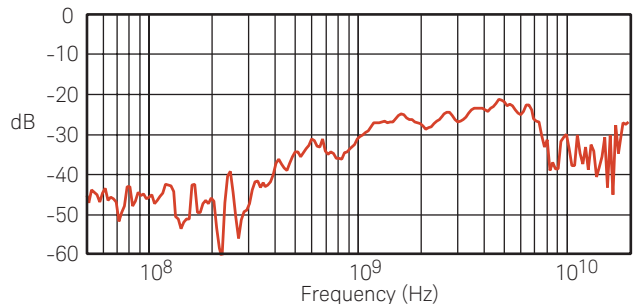

Common mode rejection versus frequency

InfiniiMax Active Probe System Overview – InfiniiMax I Probing System (continued)

Keysight 1130A/31A/32A/34A InfiniiMax high-performance active probe system

- InfiniiMax 7 GHz, 5 GHz, 3.5 GHz, and 1.5 GHz probing system
- Each InfiniiMax probe amplifier supports both differential and single-ended measurements for a more cost-effective solution
- Unrivaled InfiniiMax probing accessories support browsing, solder-in, and socket use models at the maximum performance available

The Keysight InfiniiMax 1134A, 1132A, 1131A and 1130A probe systems provide 7 GHz, 5 GHz, 3.5 GHz and 1.5 GHz of bandwidth respectively, and offer the following benefits:

- The probes have a flat frequency response over the entire bandwidth specification, eliminating the distortion and loading that affect probes with in-band resonance. The probing system enables engineers to utilize their oscilloscope's entire bandwidth without being limited to measuring only 50 Ω transmission lines or using passive resistive divider probes that produce voltage measurement error and circuit loading. Designers can achieve system measurement bandwidths of 4.5 to 6 GHz even when manually "browsing" with the probe. Solder-in probe heads and solder-in sockets provide even higher bandwidths.
- The Keysight InfiniiMax 1130A series probe system supports a wide variety of real-world applications with an extensive line up of probe heads and accessories. The accessories can meet the most demanding mechanical access requirements. Small probe heads can be placed between densely packed PC boards. Solder-in sockets are available for signals that need frequent measurement. A differential SMA probe head is available to connect to fixtures that have SMA connections. A smart ergonomic design allows users to set the spacing between the probe pins (variable span). When not concerned with minimum probe size, designers can use a browsing sleeve to make holding the probe more comfortable. Both probe tips of the differential probe can "flex" to support various probing angles and target system characteristics (z-axis compliance). Innovative damped-wire accessories compensate for the inductance and capacitance associated with the leads, and prevent distortion of the measured signal.
- The groundbreaking design of Keysight InfiniiMax 1130A probe system also enables users to make either single-ended or differential measurements from a single probe amplifier, depending on their choice of probe head and accessory. This can result in significant savings in cost and time. The common mode rejection of the differential probe head reduces a measurement's noise floor. Overall, the Keysight 1130 series probing system delivers unmatched performance, accuracy and connectivity.

InfiniiMax: The world's best high-speed oscilloscope probing system

EDN Magazine has awarded Keysight's InfiniiMax active probe system the 2002 Innovation of the Year Award.

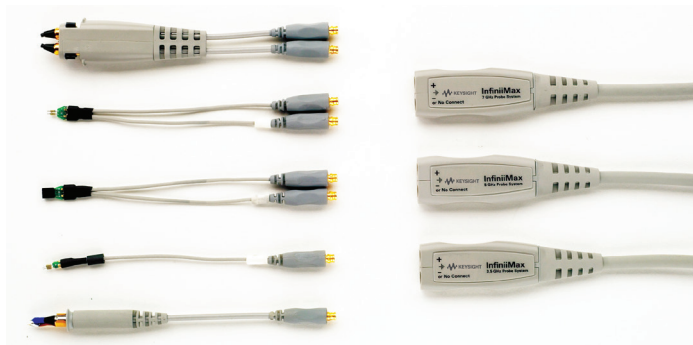

InfiniiMax offers you the highest performance available for measuring differential and single-ended signals

InfiniiMax Active Probe System Overview – InfiniiMax I Probing System (continued)

Performance characteristics

	1130A/31A/32A/34A
Probe Bandwidth*	1134A: > 7 GHz 1132A: > 5 GHz 1131A: > 3.5 GHz 1130A: > 1.5 GHz
Rise and fall time (10% to 90%)	1134A: 60 psec 1132A: 86 psec 1131A: 100 psec 1130A: 233 psec
System bandwidth (-3 dB)	1134A with DSO/DSA90604A: 6 GHz 1132A with DSO/DSA90404A, DSO/MSO9404A: 4 GHz 1131A with DSO/DSA90254A, DSO/MSO9254A: 2.5 GHz 1130A with DSO/MSO9104A: 1 GHz 1130A with DSO/MSO9064A: 600 MHz
Input capacitance**	C _m = 0.1 pF C _m is between tips. C _g = 0.34 pF C _g is to ground for each tip. C _{diff} = 0.27 pF Differential mode capacitance = C _m + C _g /2 C _{se} = 0.44 pF Single-ended mode capacitance = C _m + C _g
Input resistance*	Differential mode resistance = 50 kΩ ± 1% Single-ended mode resistance = 25 kΩ ± 1%
Input dynamic range	± 2.5 V
Input common mode range	± 6.75 V dc to 100 Hz; ± 1.25 V >100 Hz
Maximum signal slew rate	18 V/ns when probing a single-ended signal 30 V/ns when probing a differential signal
DC attenuation	10:1 ± 3% before calibration on oscilloscope 10:1 ± 1% after calibration on oscilloscope
Zero offset error referred to input	< 30 mV before calibration on oscilloscope < 5 mV after calibration on oscilloscope
Offset range*	± 12.0 V when probing single-ended
Offset accuracy	< 3 % setting before calibration on oscilloscope < 1 % setting after calibration on oscilloscope
Noise referred to input	3.0 mV _{rms}
Propagation delay	~6 nsec (This delay can be deskewed relative to other signals.)
Maximum input voltage*	30 V _{peak} , CAT I
ESD tolerance	> 8 kV from 100 pF, 300 Ω HBM

* Denotes warranted specifications, all others are typical.

** Measured using the probe amplifier and solder-in differential probe head with full bandwidth resistors.

InfiniiMax Active Probe System Overview – InfiniiMax I Probing System (continued)

Ordering information

InfiniiMax I probe amplifier models

Model number	Description	Quantity
1134A	7 GHz InfiniiMax Probe Amplifier (order one or more probe heads or connectivity kits per amplifier)	1
1132A	5 GHz InfiniiMax Probe Amplifier (order one or more probe heads or connectivity kits per amplifier)	1
1131A	3.5 GHz InfiniiMax Probe Amplifier (order one or more probe heads or connectivity kits per amplifier)	1
1130A	1.5 GHz InfiniiMax Probe Amplifier (order one or more probe heads or connectivity kits per amplifier)	1

InfiniiMax I connectivity kits models

Model number	Description	Quantity
E2669A	InfiniiMax connectivity kit for differential/single-ended measurements. Includes one differential browser, four solder-in differential probe heads and two socketed differential probe heads. Includes all necessary accessories.	1
E2668A	InfiniiMax connectivity kit for single-ended measurements. Includes one single-ended browser, one solder-in probe heads and one socketed probe heads. Includes all necessary accessories.	1

InfiniiMax I individual probe heads

Model number	Description	Quantity
E2675B	InfiniiMax differential browser probe head and accessories. Includes 20 replaceable tips and ergonomic handle. Order E2658A for replacement accessories.	1
E2676A	InfiniiMax single-ended browser probe head and accessories. Includes 2 ground collar assemblies, 10 replaceable tips, a ground lead socket and ergonomic handle. Order E2663A for replacement accessories.	1
E2677A	InfiniiMax differential solder-in probe head and accessories. Includes 20 full bandwidth and 10 medium bandwidth damping resistors. Order E2670B for replacement accessories.	1
E2678B	InfiniiMax single-ended/differential socketed probe head and accessories. Includes 48 full bandwidth damping resistors, 6 damped wire accessories, 4 square pin sockets and socket heatshrink. Order E2671A for replacement accessories.	1
E2679A	InfiniiMax single-ended solder-in probe head and accessories. Includes 16 full bandwidth and 8 medium bandwidth damping resistors and 24 zero ohm ground resistors. Order E2672A for replacement accessories.	1

InfiniiMax I adapters

Model number	Description	Quantity
N1022B	Adapts 113X/115X active probes to 86100 Infiniium DCA	1
N2887A	InfiniiMax Soft touch Pro probe adapter (36 channel, up to 4 GHz)	1
N2888A	InfiniiMax Soft touch half-channel probe adapter (18 channel, up to 4 GHz)	1

N7010A Active Termination Adapter

- 30-GHz single-ended active termination adapter supporting 2.92 mm/3.5 mm/SMA cable input
- Low attenuation setting (1.16:1) for high SNR, low noise measurements
- Ability to terminate signal to a 50 Ω non-ground voltage (VTERM)
- Compatible with Infiniium 90000Q, Z-Series, or V-Series installed with software version 5.30 or higher

To date, most oscilloscopes with 50 Ω inputs terminate to ground by definition. However, a particular communication system often requires the 50 Ω termination to a voltage rather than to ground. The Keysight N7010A active termination adapter is a 30-GHz single-ended adapter featuring a user-adjustable common termination voltage (VTERM) and extremely low noise performance. The termination voltage between -4.0 V to $+4.0$ V can be controlled internally by the oscilloscope. The N7010A is a single-ended adapter. Two scope channels and two adapters are needed for making differential measurement, which allow the A to GND, B to GND and differential (A-B) signals to be viewed in real time.

Utilizing low attenuation ratio setting (1.16:1), the adapter enables an extremely lower noise floor, especially at high-sensitivity vertical scales (< 400 mV) when compared to the Keysight Infiniium III probe with the N5444A SMA/2.92 mm head. The adapter is compatible with Infiniium 90000Q, Z-Series, or V-Series with AutoProbe II interface.



Key characteristics and specifications	N7010A
Bandwidth*	>30 GHz (warranted), >32 GHz (typical)
Rise time (10% - 90%)	14.5 psec
Attenuation ratio	1.16:1
Noise with oscilloscope	See chart
V _{in} max active signal	1.2 V _{pp} (not including DC component)
V _{term} range	-4V to +4V
V _{term} accuracy	± 2 mV
V _{offset} range	-4V to +4V
Input signal range (V _{in} - V _{term} difference)	$-0.6V \leq (V_{in} - V_{term}) \leq +0.6V$
Input resistance @DC*	50 $\Omega \pm 3\%$
Max non-destructive input voltage	± 8 V

* Warranted specifications



N7010A Active Termination Adapter (continued)

Noise of N7010A with Infiniium V-Series oscilloscopes

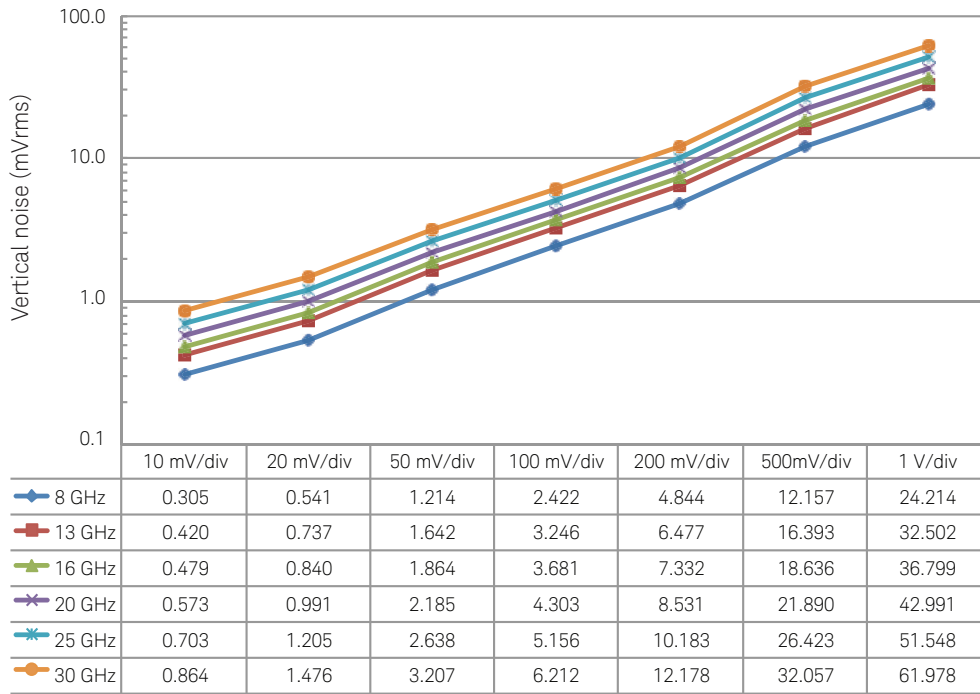

Eye diagram comparison with MIPI® M-PHY® Gear 3 data rate at 5.8304 Gb/s, amplitude swing: = 140 mVpp

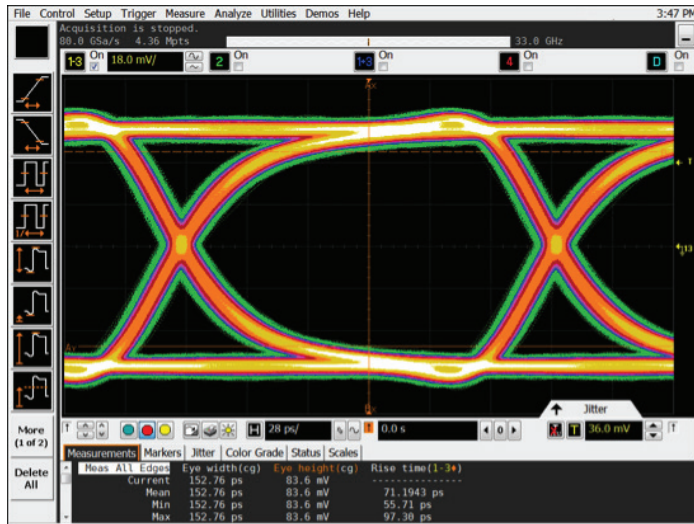

Figure 1. Direct signal connect to Infiniium scope

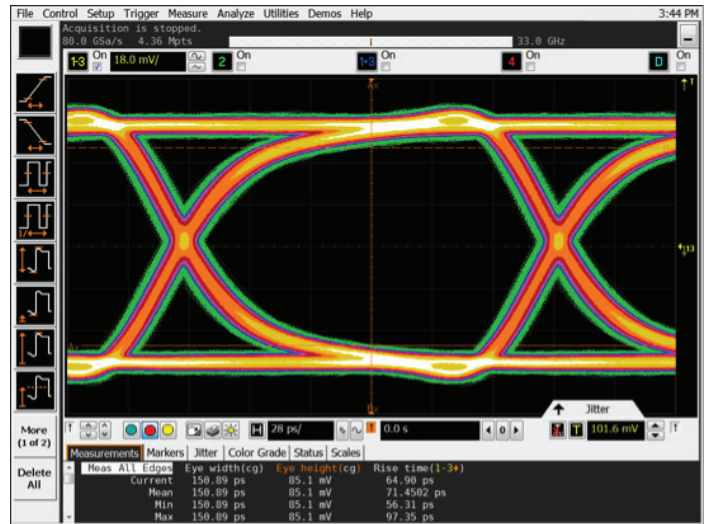

Figure 2. Signal through N7010A active termination adapter; N7010A doesn't inherently contribute noise

InfiniiMode Active Probes – N2750A/51A/52A InfiniiMode Probes

InfiniiMode active probes N2750A/51A/52A InfiniiMode probes

- 1.5 GHz, 3.5 GHz, and 6 GHz probe bandwidth models
- Dual attenuation ratio (2:1/10:1)
- High input resistance (200 k Ω differential, 100 k Ω single-ended)
- Wide input dynamic range (10 Vpp) and offset range (± 15 V)
- High CMRR (> 60 dB at 1 MHz)
- InfiniiMode probing for making differential, single-ended, and common mode measurements with a single probe
- Built-in quick action scope control for quick access to a variety of scope functions
- Built-in headlight
- Includes solder-in, browser, and socketed tips standard
- AutoProbe interface for auto configuration and probe power for Infiniium scopes



The N2750A Series InfiniiMode differential probes are a new generation of low-cost, 1.5 GHz, 3.5 GHz, and 6 GHz differential active probes compatible with Infiniium oscilloscope's AutoProbe interface.

Measurement versatility

The N2750A Series differential probes offer 2:1 and 10:1 dual attenuation settings, allowing them to be used for a broad range of applications. Dual attenuation range is automatically configured depending on the size of the input signal.

The new differential probes have an input resistance of 200 k Ω (differential) or 100 k Ω (each input to ground) and an extremely low input capacitance of 700 fF to minimize circuit loading. This, accompanied with superior signal fidelity, makes these probes useful for most digital design and debug applications. And with their wide dynamic range (10 Vpp) and offset range (± 15 V), these probes can be used in a wide variety of analog signal measurements as well.

InfiniiMode usability

The N2750A Series probes come with new InfiniiMode operation modes. The InfiniiMode allows convenient measurements of differential, single-ended, and common mode signals with a single probe tip without reconnecting the probe to change the connection. The N2750A probe's InfiniiMode provides the following modes of operation.

- A – B (differential),
- A – ground (single-ended A)
- B – ground (single-ended B)
- (A+B)/2 – ground (common mode)

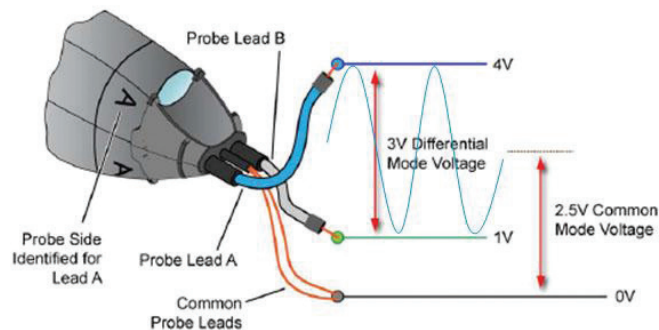

The InfiniiMode probe allows convenient measurements of differential, single-ended (A and B) and common mode signals with a single probe.

Quick action scope control

The N2750A Series differential probes provide convenient and quick access to various functions on the scope. You often have a need to control the scope while you hold a probe in your hand. With the quick action scope control feature built into the probe, you can turn the built-in headlight of the probe on and off or control some frequently used scope functions, such as RUN/STOP, auto scale, quick print, quick save, etc., with only the push of a button on the probe. Get control of your most needed function with a push of the quick action control button on the probe.

Flexibility in probe use models is also a vital necessity. The probes come standard with three different types of exchangeable probe tips that allow for easy connections to the circuit under test. These probe tips enable you to access multiple signals on anything from header connectors to hard-to-reach, high-density circuitry. The probes are equipped with a white LED headlight to illuminate the circuit under test which will help you see where you are probing.

The probes are powered directly by the Infiniium AutoProbe interface, eliminating the need for an additional power supply.

Infiniium Mode Active Probes – N2750A/51A/52A Infiniium Mode Probes (continued)

Characteristics and specifications			
Model number	N2750A	N2751A	N2752A
Probe bandwidth* (-3 dB)	1.5 GHz	3.5 GHz	6 GHz (warranted), 7 GHz (typical)
Rise time, probe only (10-90%)	233 psec	100 psec	58.3 psec
System bandwidth (with Keysight oscilloscope)	1 GHz (with Keysight's Infiniium oscilloscope)	2.5 GHz (with Keysight's Infiniium oscilloscope)	4/6 GHz (with Keysight's Infiniium oscilloscope)
Input resistance (@DC)*		200 kΩ ± 2% (differential mode) 100 kΩ ± 2% (single-ended mode) 50 kΩ ± 2% (common mode)	
Input capacitance		700 fF (with browser)	
Attenuation ratio (@DC)		2:1 / 10:1	
Input dynamic range		± 1 V, 2 Vpp (@2:1) / ± 5 V, 10 Vpp (@10:1)	
Input common mode range		± 15 V (from DC to 100 Hz), ± 2.5 V (for > 100 Hz) ****	
Offset range		± 15 V	
Offset accuracy**		< 3%	
Maximum non-destructive input voltage		± 30 V (DC + peak AC)	

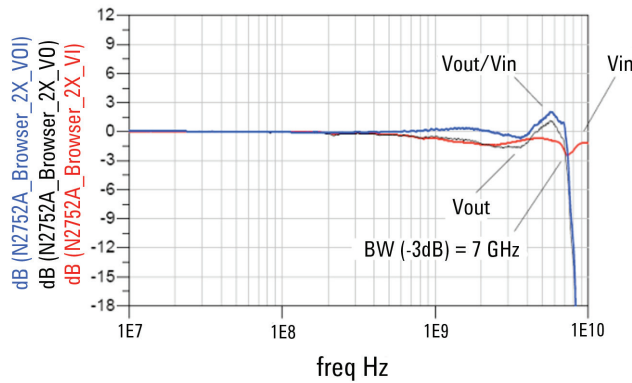

V_{out}/V_{in} frequency response of N2752A (at 2:1) with browser tip

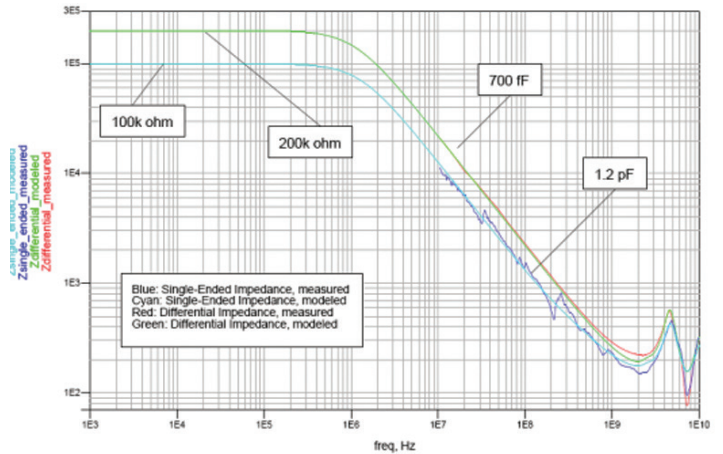

V_{out}/V_{in} frequency response of N2752A (at 2:1) with browser tip

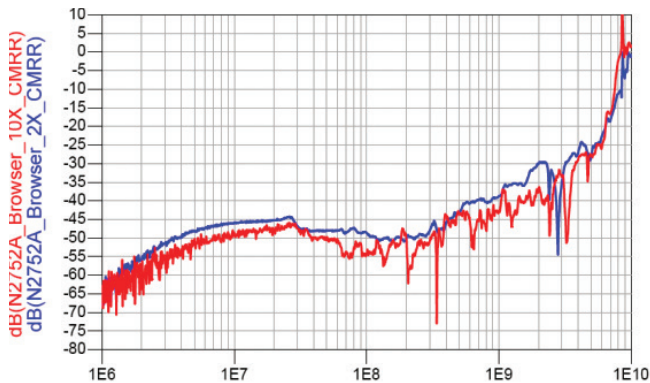

Common mode rejection ratio (red= 2:1, blue= 10:1)

InfiniiMode Active Probes – N2750A/51A/52A InfiniiMode Probes (continued)

Ordering information	
Model number	Description
N2750A	1.5 GHz InfiniiMode differential probe
N2751A	3.5 GHz InfiniiMode differential probe
N2752A	6 GHz InfiniiMode differential probe
N2776A	Differential browser tips (qty 3)
N2777A	InfiniiMode solder-in tips (qty 3)
N2778A	InfiniiMode socketed tips (qty 3)
N4822A	Socketed tip for USB/ethernet application fixtures (qty 1)

The N2750A/51A/52A InfiniiMode probes include two browser tips, two socketed tips, and two solder-in tips as standard. The N4822A is not included in the N2750A-52A probe.

Other recommended accessories	
Model number	Description
N2787A	3D probe positioner
E2655C	Performance verification and deskew fixture
N5442A	Precision BNC adapter for V-Series, 90000X/Q Series oscilloscopes



N2750A with N4822A socketed tip for application fixtures

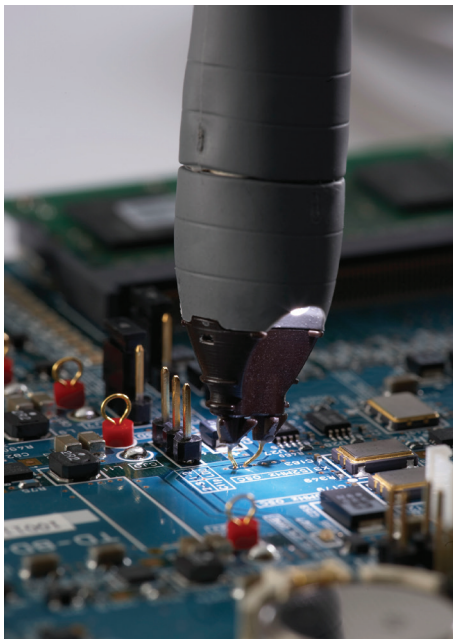

N2750A with browser tip

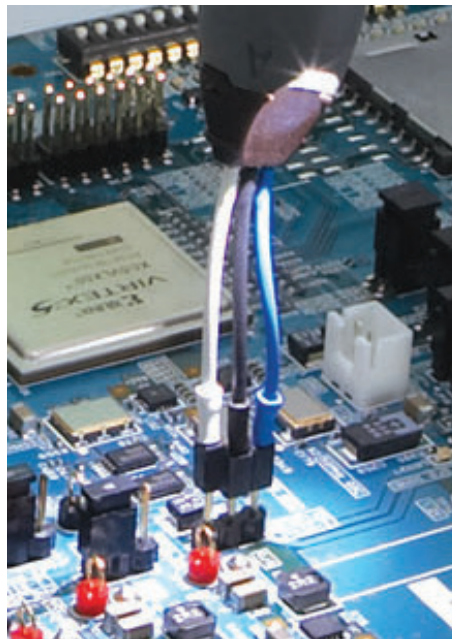

N2750A with socketed tip

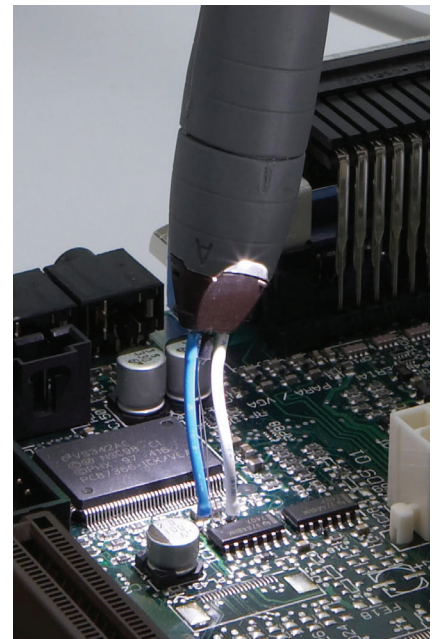

N2750A with solder-in tip

For more information about the N2750A Series InfiniiMode probes, refer to the data sheet with the Keysight literature number, 5991-0560EN.

Single-Ended Active Probes – N2795A/96A/97A Active Probes

- High resistance (1 M Ω) and low capacitance (1 pF) input for low loading
- Wide input dynamic range (± 8 V) and offset range (± 12 V for N2796A/97A, ± 8 V for N2795A)
- Built-in headlight
- Direct connection to AutoProbe interface (no power supply required)
- N2797A for extreme temperature environmental chamber testing at -40 to $+85$ °C

The N2795A/96A are a new generation of low-cost, 1 to 2 GHz single-ended active probes with the AutoProbe interface (compatible with Keysight's Infiniium family of oscilloscopes). These probes integrate many of the characteristics needed for today's general-purpose, high-speed probing—especially in digital system design, component design/characterization, and educational research applications. Its 1 M Ω input resistance and extremely low input capacitance (1 pF) provide ultra low loading of the DUT. This, accompanied with superior signal fidelity, makes these probes useful for most of today's digital logic voltages.

Testing devices over extreme temperature ranges is quite common these days. The N2797A 1.5 GHz single-ended active probe is the industry's first low-cost high input impedance active probe with rugged probe tips for environmental chamber testing of ICs and devices. The probe gives the ability to probe signals at drastic temperature swings ranging from -40 to $+85$ °C. The probe provides a 2 m long cable. Order N2798A for re-ordering accessories.

The N2795A/96A/97A are equipped with a white LED headlight to illuminate the circuit under test. The probes are powered directly by the Infiniium AutoProbe interface, eliminating the need for an additional power supply. The probes also come with a number of accessories that allow for easy connections to the circuit under test.

For more information about N2795A/96A/97A active probe, refer to the Keysight N2795A/96A/97A active probe data sheet literature number 5990-6480EN.

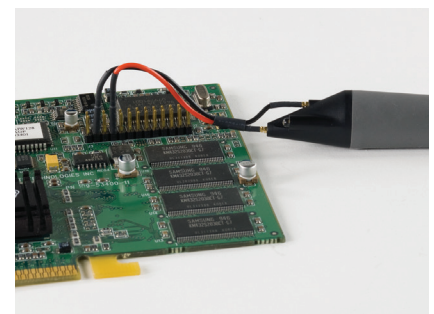
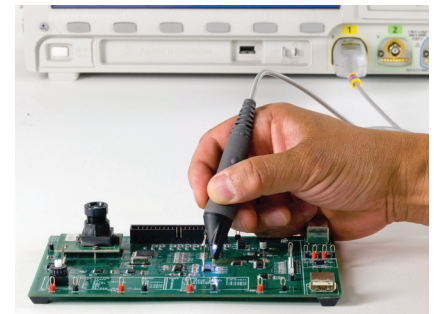
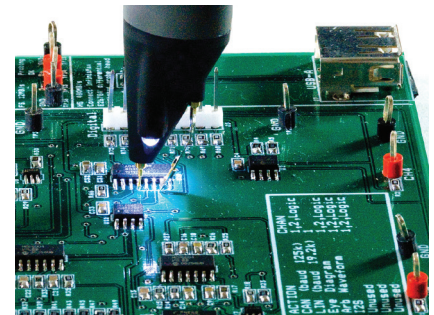

Characteristics for N2795A, N2796A and N2797A active probes

	N2795A	N2796A	N2797A
Probe bandwidth* (-3 dB)	1 GHz	2 GHz	1.5 GHz
Rise time	350 ps	175 ps	233 ps
System bandwidth	600 MHz (with Keysight's 600 MHz Infiniium oscilloscope)	1 GHz (with Keysight's 1 GHz Infiniium oscilloscope)	
Attenuation ratio (at dc)	10:1 \pm 0.5%		
Input dynamic range	-8 to $+8$ V (DC or peak AC)		
Non-destructive input voltage	-20 to $+20$ V		
Offset range	± 8 V	± 12 V	
DC offset error (output zero)	± 1 mV		
Low frequency accuracy	0.5% at 70 Hz, 1 Vpp		
Input resistance*	1 M Ω		
Input capacitance	1 pF		
Output impedance	50 Ω		

* Denotes warranted electrical specifications after 20 minute warm-up, all others are typical

Single-Ended Active Probes – N2795A/96A/97A Active Probes (continued)

Measurement plots

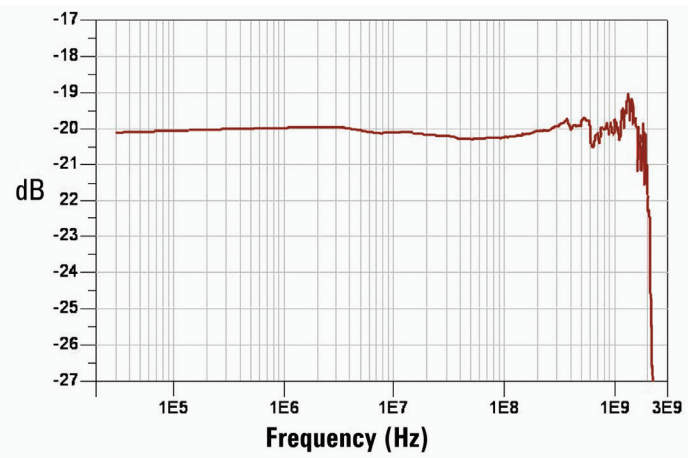

Frequency response of N2796A (Vout/Vin)



Time domain step response of N2796A (with Keysight MS09404A)

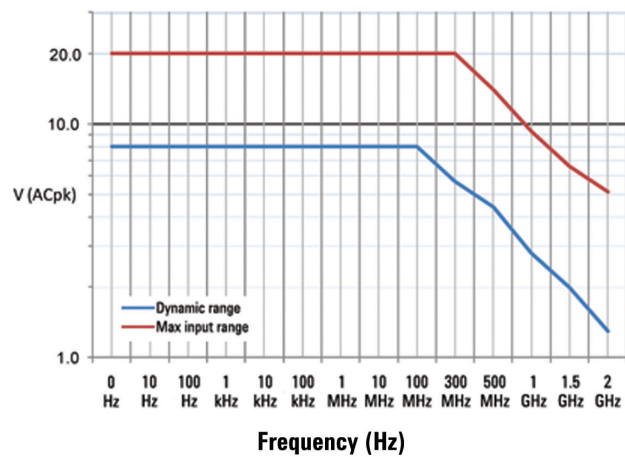

Voltage derating over frequency (N2796A)

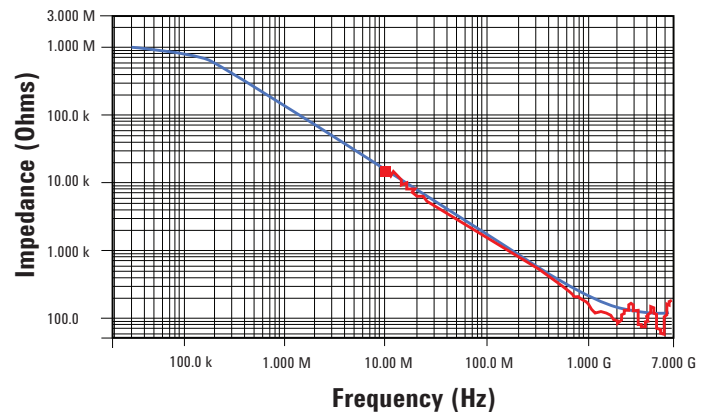

Input impedance over frequency (Red = measured, Blue = model)

Single-Ended Active Probes – N2795A/96A/97A Active Probes (continued)

Ordering information	
Model number	Description
N2795A	1 GHz single-ended active probe
N2796A	2 GHz single-ended active probe
N2797A	1.5 GHz single-ended active probe

Reorderable accessories		
Model number	Description	Quantity
N4839A	Dual-lead socketed adapter, 6 cm	2
N4840A	Dual-lead solder-in adapter, 5 cm	2
N4841A	Dual-lead socketed adapter, 9 cm	2
N4842A	Dual-pin PCB header	2
N4843A	Solderable tips	10
N4844A	Right angle ground lead, 5 cm	2
N4845A	Ground blade	2
N4846A	Offset ground	2



N4839A



N4840A



N4841A



N4842A



N4843A



N4844A



N4845A



N4846A

Single-Ended Active Probes – N7020A Power Rail Probe

- 2-GHz single-ended active probe for power rail noise measurement
- 1:1 attenuation ratio ensures low noise signal measurement
- ± 24 V of probe offset range enables effective elimination of DC component of a power supply.

The N7020A power rail probe is a low noise, large offset range oscilloscope probe that enables users to measure small signals riding on top of DC power supplies.

- Low noise: The N7020A power rail probe is a 1:1 attenuation ratio active probe. As a general rule, the higher a probes attenuation ratio, the noisier the signal will be on the oscilloscope.
- Large offset range: The N7020A power rail probe provides ± 24 V of probe offset. This enables users to center the signal on screen while placing the oscilloscope at its maximum vertical sensitivity and zoom-in on the signal.
- Low DC loading: The N7020A power rail probe has 50 k Ω input impedance at DC, minimizing the probe's DC loading of the power rail.
- Large input dynamic range: The N7020A power rail probes ± 850 mV input dynamic range means that users can measure up to 850 mV deviations of their DC supplies. This is very useful for measuring programmable supplies like those used in micro-controller power saving modes.

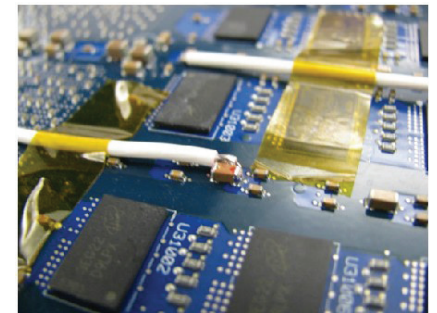

Characteristics and specifications	
Probe bandwidth (-3 dB)	2 GHz
Attenuation ratio	1:1
Offset range	± 24 V
Input impedance at DC	50 k Ω
At > 1 MHz	50 Ω
Input dynamic range	± 850 mV
Probe noise	10% of oscilloscope noise
Included accessories	N7021A coaxial probe head (qty 3), N7022A SMA main cable
Output impedance	50 Ω
Compatible oscilloscopes	Infiniium S-Series or 9000 Series with software rev 5.20 or higher

For more information about the N7020A power rail probe, check out the Keysight data sheet with the publication number 5992-0141EN.

General Purpose Differential Active Probes – N2790A/91A/891A High-Voltage Differential Probes

- 25 to 800 MHz bandwidth
- Switchable attenuation
- Measure up to 1,400 V CAT II and 7 kV CAT I

Oscilloscope users often need to make floating measurements where neither point of the measurement is at earth ground. Use N2790A, N2791A, or N2891A high voltage differential probes to make safe and accurate floating measurements with an oscilloscope. The N2790A, N2791A, and N2891A high voltage differential probes allow conventional earth-grounded Keysight oscilloscopes to be used for floating signal measurements.

Each probe offers user-selectable attenuation settings that make it highly versatile, allowing it to be used for a broad range of applications. The probe comes with probe tip accessories for use with small and large components in tight spaces.

The N2791A and N2891A are compatible with any oscilloscope with 1 M Ω BNC input. The N2791A and N2891A probe power is supplied by the included 4x AA batteries or the USB host port of the scope, or PC via a supplied USB power cable. The N2790A is compatible with the Keysight's AutoProbe interface where the probe power is supplied by the Keysight oscilloscope's probe interface. The N2790A is not compatible with 80000 and 90000 Series oscilloscope.

Characteristics for N2790A, N2791A and N2891A differential probe

	N2790A	N2791A	N2891A
Bandwidth	100 MHz	25 MHz	70 MHz
Rise time	3.5 ns	14 ns	5 ns
Attenuation ratio	50:1 / 500:1	10:1 / 100:1	100:1 / 1000:1
Input impedance (between inputs)	8 M Ω / 3.5 pF	8 M Ω / 8 pF	100 M Ω / 5 pF
Max input voltage to ground	\pm 1000 V (CAT II) \pm 600 V (CAT III)	\pm 700 V at 100:1 \pm 70 V at 10:1	\pm 7000 V at 1000:1 \pm 700 V at 100:1
Max input voltage between two inputs	\pm 1400 V at 500:1 \pm 140 V at 50:1	\pm 700 V at 100:1 \pm 70 V at 10:1	\pm 7000 V at 1000:1 \pm 700 V at 100:1



N2790A 100 MHz high voltage differential probe

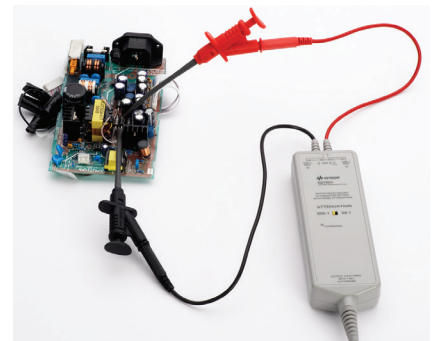

N2790A measuring a power supply signal



N2791A 25 MHz high voltage differential probe



N2891A 70 MHz high voltage differential probe

General Purpose Differential Active Probes – N2804A/05A High-Voltage High-Speed Differential Probes

- 200 - 300 MHz bandwidth
- Measures up to 300 V differential, 1 kV common mode
- Ideal for high speed power measurements

The N2804A and N2805A differential probes provide the superior general-purpose differential signal measurements that are required for high-speed power measurements such as measuring characteristics of switching power devices, DC-DC converters or class D amplifiers, vehicle bus measurements, and high-speed digital system designs.

The N2804A 300-MHz differential probe offers 100:1 attenuation ratio, allowing it to be used adequately for high voltage signal measurements. The differential probe has a differential input resistance of 4 M Ω and low input capacitance of 4 pF to minimize circuit loading. The probe comes with a pair of extension leads (30 cm long) with a damping resistor built in to damp out the in-band resonance and provide flat frequency response even while using the extension leads and probe tip accessories.

The N2805A is a 200-MHz differential probe designed to provide superior differential signal measurements with long cable length (5 m), making it ideal in an environment where extended cable length is required. This probe comes with an extensive set of probe tip accessories for use with small and large components in tight spaces.

	N2804A	N2805A
Bandwidth	300 MHz (without extension leads) 120 MHz (with extension leads)	200 MHz
Attenuation ratio	100:1	50:1
DC gain accuracy	$\pm 1\%$	$\pm 1\%$
Input impedance (between inputs)	4 M Ω / 4 pF	4 M Ω / 4 pF
Max input voltage (between two inputs)	± 300 V (DC+ peak AC) and ± 200 Vrms	± 200 V (DC+ peak AC) and ± 200 Vrms CAT II
Max input voltage	± 300 V (DC+ peak AC) and ± 200 Vrms CATII ± 1000 V (DC+ peak AC) and ± 1000 Vrms CATI	± 500 V (DC+ peak AC) and ± 500 Vrms CAT I ± 300 V (DC+ peak AC) and ± 200 Vrms CATII
Cable length	1.2 m	5 m
Compatible Infiniium oscilloscopes	Infiniium S-Series, 9000, 90000 Series with software 5.2 or higher	



N2804A 300 MHz differential probe



N2805A 200 MHz differential probe

General Purpose Differential Active Probes – 1153A/41A Low-Noise Differential Probes

The 1141A is a 1x FET differential probe with 200-MHz bandwidth and a 3000:1 CMRR. The probe has a high-input resistance and low-input capacitance of 7 pF to minimize circuit loading. The 1141A must be used with 1142A probe control and power module, which controls input coupling modes dc, dc with variable offset, and dc reject. Two attenuators, 10x and 100x are provided to expand the linear differential input range to ± 30 V. This probe works with any 50- Ω input oscilloscope.

The 1153A is the same 1:1 differential probe with 200 MHz as the 1141A except that it is compatible with the AutoProbe interface, which completely configures the Infiniium scope for the probe. The probe interface recognizes the probe and automatically sets up the proper power, coupling mode, 50 Ω impedance and offset range. The 1142A probe power supply is unnecessary with the 1153A. The probe works with Infiniium 9000, 90000A and 90000X with N5442A.

Characteristics for 1153A/41A differential probe

	1153A/41A
Bandwidth	200 MHz
Rise time	1.75 ns
Attenuation ratio	10:1 and 100:1 with attenuator
High CMRR	3000:1 at 1 MHz 10:1 at 100 MHz
Input impedance	Between inputs: 1 M Ω / 7 pF
Max input voltage	200 Vdc + peak ac (probe alone) 500 Vdc + peak ac (with attenuator)



1153A 1:1 FET differential probe with 200 MHz bandwidth

General Purpose Differential Active Probes – N2818A/19A General-Purpose Differential Probes

The N2818A 200-MHz and N2819A 800-MHz differential probes provide the superior general-purpose differential signal measurements required for today’s high-speed power measurements, vehicle bus measurements, and digital system designs.

The N2818A and N2819A probes offer a 10:1 attenuation setting and high input resistance and low input capacitance to minimize circuit loading.

Both probes are compatible with AutoProbe interface with 50 Ω BNC input.

Characteristics for N2818A and N2819A differential probes

	N2818A	N2819A
Bandwidth	200 MHz	800 MHz
Rise time	1.75 ns	437 ps
Attenuation ratio	10:1	10:1
Probe loading (between inputs)	1 MΩ / 3.5 pF	200 kΩ / 1 pF
Max input voltage to ground	± 60 V	± 40 V
Max input voltage between two inputs	± 20 V	± 15 V



N2818A 200-MHz, 20-V differential probe

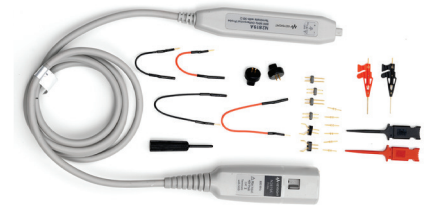

N2819A 800-MHz, 15-V differential probe

Ordering information for Keysight differential probes and power supply

Model number	Description
1141A	200-MHz differential probe
1142A	Probe control and power module for 1141A
1153A	200-MHz differential probe with AutoProbe interface
N2790A	100-MHz, 1.4 kV differential probe with AutoProbe interface
N2791A	25-MHz, 700-V differential probe
N2818A	200-MHz, 20-V differential probe with AutoProbe interface
N2819A	800-MHz, 15-V differential probe with AutoProbe interface
N2891A	70-MHz, 7,000-V differential probe
N4853A	Variable pitch browser for N2819A
N4854A	DC blocking capacitor for N2819A
N2804A	300-MHz high voltage differential probe
N2805A	200-MHz high voltage differential probe with extended cable length
N2816A	Probe tip accessory kit for N2804A including 2 each alligator clips, 2 each pincer clips, and 1 extension leads (30 cm)
N2817A	Probe tip accessory kit for N2805A including 2 each alligator clips, 2 each hook clips, 2 each pincer clips, and 2 each browser tips

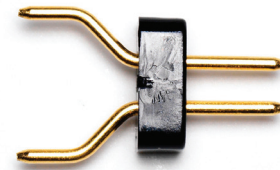

N4853A variable pitch browser

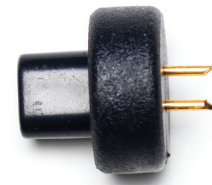

N4854A DC blocking capacitor

AC/DC Current Probes – 1146B Low-Cost AC/DC Current Probe

The 1146B ac/dc current probe provides accurate display and measurement of currents from 100 mA to 100 Arms, dc to 100 kHz, without breaking into the circuit. A battery level indicator and overload indicator help ensure proper readings. It connects directly to the scope through a 2-m coaxial cable with an insulated BNC. This probe works with any 1 M Ω input oscilloscope.



1146B 100 mA to 100 Arms, dc to 100 kHz probe

Operating characteristics of the 1146B current probe

1146B	
Bandwidth*	dc to 100 kHz (-3 dB)
Current range*	100 mV/A:100 mA to 10 A peak 10 mV/A:1 to 100 A peak
Output signal	1000 mV peak max
AC current accuracy*	
Range	100 mV/A (50 mA to 10 A peak)
Accuracy	3% of reading \pm 50 mA
Range	10 mV/A (500 mA to 40 A peak)
Accuracy	4% of reading \pm 50 mA
Range	10 mV/A (40 A to 100 A peak)
Accuracy	15% max at 100 A
Noise	Range 10 mV/A: 480 μ V Range 100 mV/A: 3 mV
Insertion impedance	0.01 Ω (50/60 Hz)
Maximum working voltage	600 Vrms CAT II or 300 Vrms CAT III
Maximum common mode voltage	600 Vrms CAT II or 300 Vrms CAT III
Influence of adjacent conductor	< 0.2 mA/A AC
Influence of conductor position	0.5% of reading at 1 kHz in jaw
Battery	9 V alkaline (NEDA 1604A, IEC 6LR61)
Low battery	Green LED on when \leq 6.5 V
Battery life	55 hours typical

Note: Reference conditions 23 \pm 5 $^{\circ}$ C, (73.4 \pm 41 $^{\circ}$ C) 20 to 75% relative humidity, dc to 1 kHz, probe zeroed, 1-minute warmup, batteries at 9 V + 0.1 V, external magnetic field <40 A/m, no dc component, no external current carrying conductor, 1 M Ω / 100 pF load, conductor centered in jaw.

* Characteristics marked with asterisks are specified performance. Others are typical characteristics.

Ordering information

Model number	Description
1146B	100-kHz current probe

AC/DC Current Probes – 1147B/N2893A AC/DC Current Probes

The 1147B/N2893A is a wide bandwidth, dc to 50-MHz/100-MHz current probe. The probe offers a flat frequency response across the entire dc to 50-MHz/100-MHz bandwidth, low noise (< -2.5 mArms), and low circuit insertion loss.

The 1147B/N2893A probe is compatible with the AutoProbe interface, which completely configures the oscilloscope for the probe when used with the Infiniium 9000 Series scope (1 M Ω input). Probe power is provided by the scope, so there is no need for an external power supply. The N2893A uniquely provides an auto demagnetization and offset elimination feature when used in conjunction with Infiniium scope. The 1147B and N2893A are not compatible with Infiniium 80000 and 90000 Series oscilloscope.

Operating characteristics of the 1147B/N2893A current probes

	1147B/N2893A
Bandwidth (-3 dB)	dc to 50 MHz (1147B) dc to 100 MHz (N2893A)
Rise time	7 ns or less
Maximum current (continuous)	15 A peak, 15 A DC, 10 Arms
Maximum peak current (non-continuous)	30 A peak
Output voltage rate	0.1 V/A
Amplitude accuracy	$\pm 1\%$ rdg, ± 10 mA (dc and 45 to 66 Hz, rated current)
Noise	Equivalent to 2.5 mArms or less (for 20 MHz bandwidth measuring instrument)
Temperature coefficient for sensitivity	$\pm 2\%$ or less (within a range of 0 to 40 °C or 32 to 104 °F)
Effect of external magnetic fields	Equivalent to a maximum of 20 mA (in a dc to 60 Hz, 400 A/m magnetic field)
Maximum rated power	3 VA (with rated current)
Maximum input voltage	300 V CAT I
Diameter of measurable conductors	5 mm dia. (0.2 in dia.)
Probe interface	AutoProbe interface (1 M Ω terminated)
Cable lengths	Sensor cable: Approx. 1.5 m (59.0 in) Power supply cable: Approx. 1 m (39.4 in)

Note: The above specifications are guaranteed at 23 ± 3 °C (or 73 ± 5 °F)



1147B 50-MHz current probe with AutoProbe interface



N2893A 100-MHz current probe with AutoProbe interface

Ordering information

Model number	Description
1147B	50-MHz current probe with AutoProbe interface
N2893A	100-MHz current probe with AutoProbe interface

AC/DC Current Probes – N2780B/81B/82B/83B/83L AC/DC Current Probes

The N2780B/L Series current probes are high bandwidth, active current probes, featuring flat bandwidth, low noise (2.5 mArms) and low circuit insertion loss. Compatible with any oscilloscope with a 1 M Ω BNC input, the N2780B/L Series current probes offer accurate and reliable solution for measuring DC and AC currents. Because of the split-core design, they can easily clip on and off of a wire. In conjunction with the power supply (model N2779A), this probe can be used with any oscilloscope with a high-impedance BNC input. The companion power supply N2779A (3 x 12 \pm Vdc output) lets you connect up to any three N2780B-83B/83L current probes to a single power supply.

The N2783L 80 MHz current probe offers 5 m long cable, which allows you to reach DUTs in long distance very easily. Other than the bandwidth performance, the N2783A and N2783L have the same electrical performance. The N2783L also requires the N2779A power supply to power the probe.

Operating characteristics of the N2780B/L Series current probes

N2780B/L Series	
Bandwidth (-3 dB)	dc to 2 MHz (N2780B) dc to 10 MHz (N2781B) dc to 50 MHz (N2782B) dc to 100 MHz (N2783B) dc to 80 MHz (N2783L)
Maximum current (continuous)	500 A (N2780B) 150 A (N2781B) 30 A (N2782B/N2783B/N2783L)
Maximum peak current (non-continuous)	700 A peak (N2780B) 300 A peak (N2781B) 50 A peak (N2782B/N2783B/N2783L)
Maximum input voltage**	300 V CAT I (N2782B, 83B, 83L) 300 V CAT III, 600 V CAT II (N2780B, 81B)
Output voltage rate	0.01 V/A (N2780B/N2781B) 0.1 V/A (N2782B/N2783B /N2783L)
Amplitude accuracy*	\pm 1.0 % rdg \pm 500 mA (N2780B) \pm 1.0 % rdg \pm 100 mA (N2781B) \pm 1.0 % rdg \pm 10 mA (N2782B) \pm 1.0 % rdg \pm 10 mA (N2783B/N2783L)

* The amplitude accuracy specification is guaranteed at 23 $^{\circ}$ C \pm 3 $^{\circ}$ C (or 73 $^{\circ}$ F \pm 5 $^{\circ}$ F).

** Insulated conductor should be used.

Ordering information

Model number	Description
N2780B	2-MHz current probe
N2781B	10-MHz current probe
N2782B	50-MHz current probe
N2783B	100-MHz current probe
N2779A	Power supply for the N2780B/81B/82B/83B/83L current probes
N2783L	80-MHz current probe with 5 m cable



N2783L with 5m long cable



N2780B Series current probes with N2779A power supply

High-Sensitivity Current Probes – N2820A/21A

- Measure AC/DC currents as low as 50 μ A
- Ideal for capturing and analyzing low level current flow in the DUT to characterize sub-circuits or measure current consumption of battery-powered devices or integrated circuits
- Simultaneous high- and low-gain views of the current waveform for more precise wide dynamic range measurement (with N2820A)

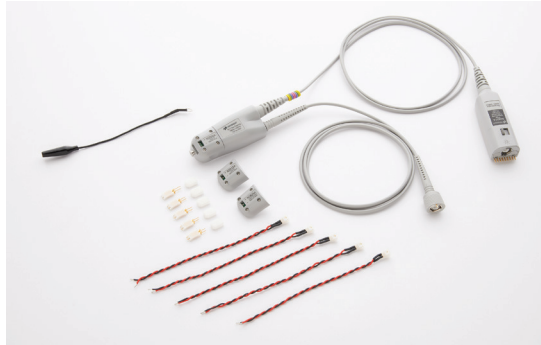

N2820A high-sensitivity 2-channel current probe

As modern battery-powered devices and integrated circuits become more green and energy efficient, there is a growing need to make high-sensitivity, low-level current measurements to ensure the current consumption of these devices is in acceptable limits. The N2820A high-sensitivity probe is engineered to make high-dynamic-range, high-sensitivity measurements to meet today's challenging current measurement needs.



The ultra-sensitive N2820A AC/DC current probe can support measurements from 50 μ A to 5 A on Keysight oscilloscopes. The N2820A interface uses a make-before-break (MBB) connector, allowing you to quickly probe multiple locations on your DUT without having to solder or unsolder the leads. The N2820A 2-channel current probe connects to two oscilloscope channels to provide simultaneous low- and high-gain views for wider dynamic range measurement, while the N2821A 1-channel current probe provides one user-selectable view at a time.

Use an area-under-the-curve measurement (Charge) on Infiniium oscilloscopes to easily calculate the integrated current consumptions over time in Ah.



The N2820A 2-channel current probe connects to two oscilloscope channels to provide simultaneous low- and high-gain views for wider dynamic range measurement.

High-Sensitivity Current Probes – N2820A/21A (continued)

Probe characteristics and specification	
Bandwidth (–3 dB)	Zoom-out channel: DC to 3 MHz
	Zoom-in channel: DC to 500 kHz
Rise time ($T_r = 0.35/\text{bandwidth}$, 10% - 90%)	Zoom-out channel: < 0.116 μsec
	Zoom-in channel: < 0.7 μsec
Minimum measurable current*	250 μA (with N2822A 20 m Ω , 500 mW)
	50 μA (with N2824A 100 m Ω , 500 mW)
	5 mA (with N2825A user-defined 1 m Ω , 500 mW)
	50 μA (with N2825A user-defined 1 k Ω , 500 mW)
Maximum measurable current	5 A (with N2822A 20 m Ω , 500 mW)
	2.2 A (with N2824A 100 m Ω , 500 mW)
	5 A** (with N2825A user-defined 1 m Ω , 500 mW)
	1.2 mA** (with N2825A user-defined 1 k Ω , 500 mW)
DC amplitude accuracy	$\pm 3\%$ or 10 μA (whichever is greater)
Gain***	Zoom-in channel: $300 \pm 3\%$
	Zoom-out channel: $1.97 \pm 3\%$
Max input voltage	$\pm 12\text{ V}$
Output impedance	1 M Ω
Standard accessories	– 1 each 20 m Ω resistor sensor head
	– 1 each 100 m Ω resistor sensor head
	– 1 each user defined resistor sensor head
	– 5 each twisted leads (22 AWG) with sockets
	– 5 each twisted leads (22 AWG) without sockets
	– 5 each MBB headers
	– 5 each MBB receptacles
	– 1 each ground lead
	– 1 each screw driver
	– 1 each passive cable (with N2820A only)
– 1 each user guide manual (English)	
Compatible InfiniiVision oscilloscopes	Infiniium 9000A/H with software version 4.2 or higher
	Infiniium S Series with software version 5.0 or higher

* V_{supply} is equal to 5 V, solder attached.

** Max current varies with max resistor power rating. The examples in the table assume 500 mW power rating.

*** Denotes warranted specification after 20-minute warm up. All others entries in the table are characteristics

Ordering information

Model numbers	Descriptions
N2820A	High-sensitivity 2-ch current probe
N2821A	High-sensitivity 1-ch current probe
Replacement part numbers	
N2822A	20 m Ω resistor tips
N2824A	100 m Ω resistor tips
N2825A	User-defined resistor tips
N2826A	Replacement wires (15.5 cm, 22 AWG bare wires) (qty 5)
N2827A	Passive cable (for N2820A secondary channel)
N2828A	Replacement MBB (Make Before Break) headers (qty 5)
N2829A	Replacement MBB (Make Before Break) receptacles and 15.5 cm, AWG 22 socketed wires (qty 5 each)

General Purpose Passive Probes – N2870A-76A Passive Probes

- Small 2.5 mm probe tip
- Replaceable spring-loaded probe tip for reliable contact
- 1:1, 10:1, 20:1 and 100:1 attenuation ratios with auto probe ID readout
- Wide compensation range for a variety of scope inputs
- Comes with various probe tip accessories
- Optional probe accessory kits
- N2873A, 500 MHz, 10:1 probe
- Ships with the 9000 Series Infiniium oscilloscope



N2873A 500 MHz passive probe with standard accessories

The N2870A Series passive probe family sets new standards in high performance probing of up to 1.5 GHz bandwidth. These general purpose probes and accessories offer high quality measurements at a very reasonable price.

Compact 2.5-mm probe head diameter, low input capacitance, and various fine-pitch probe tip accessories make the Keysight N2870A Series passive probes ideal for probing densely populated IC components or surface-mount devices used in today's high-speed digital applications. The sharp probe tip is spring loaded to help engineers keep the probe from slipping off the device under test. Insulating IC caps keep the small probe tip centered on the IC lead and keep it from shorting adjacent leads. Standard flat blade ground connector and self-adhesive copper ground pads help reduce ground inductance, while offering easy ground access. Optional probe tip accessories provide specialized capabilities for demanding applications.

The N2873A 500 MHz passive probe ships with Keysight's 9000 and S-Series Infiniium oscilloscope.

Electrical characteristics

Model number	Bandwidth (-3 dB)	Attenuation ratio*	Input C	Input R* (Scope and probe)	Max input voltage (AC RMS)	Scope input coupling	Scope comp range
N2870A	35 MHz	1:1	39 pF (+oscilloscope)	1 M Ω	55 V CAT II	1 M Ω	–
N2871A	200 MHz	10:1	9.5 pF	10 M Ω	400 V CAT I 300 V CAT II	1 M Ω	10-25 pF
N2872A	350 MHz	10:1	9.5 pF	10 M Ω	400 V CAT I 300 V CAT II	1 M Ω	10-25 pF
N2873A	500 MHz	10:1	9.5 pF	10 M Ω	400 V CAT I 300 V CAT II	1 M Ω	10-25 pF
N2874A	1.5 GHz	10:1	1.8 pF	500 Ω	8.5 V CAT I	50 Ω	–
N2875A	500 MHz	20:1	5.6 pF	20 M Ω	400 V CAT I 300 V CAT II	1 M Ω	7-20 pF
N2876A	1.5 GHz	100:1	2.2 pF	5 k Ω	21 V CAT I	50 Ω	–

* Denotes warranted specifications, all others are typical. Attenuation ratio = $\pm 2\%$ at DC, Input R (probe only, N2870A excluded) = $\pm 1\%$

Common to all

Probe ID readout: Compatible with Keysight's InfiniiVision and Infiniium Series oscilloscopes

General Purpose Passive Probes – N2870A-76A Passive Probes (continued)

Mechanical characteristics

- Weight (probe only): 48 g
- Cable length: 1.3 m
- Ground sleeve diameter: 2.5 mm

Environmental characteristics temperature

- Operating: 0 °C to +50 °C
- Non-operating: –40 °C to +70 °C

Altitude

- Operating: 2,000 m (6,561 ft)
- Non-operating: 15,000 (49,212 ft)

Humidity

- Operating: 80% room humidity for temperatures up to 31 °C, decreasing linearly to 40% at 50 °C

Pollution degree: 2

Optional accessory kits

Model number	Description
N2877A	Deluxe Accessory Kit
N2878A	General Purpose Accessory Kit
N2879A	Fine Pitch Accessory Kit
N2885A	PCB Socket Adapter Kit
N4829A	Probe tip kit (rigid and spring loaded), qty 10 each
N4831A	Sprung hook tip, qty 2 (for N2870A/71A/72A/73A/75A)
N4836A	Dual-lead adapter 2.5 mm, 10 cm, qty 2
N4837A	Ground lead 15 cm, qty 2
N4838A	2.5 mm ground spring, qty 2
N4863A	2.5 mm probe tip-to-PCB adapter, horizontal, qty 2
N4864A	2.5 mm probe tip-to-PCB adapter, vertical, qty 2

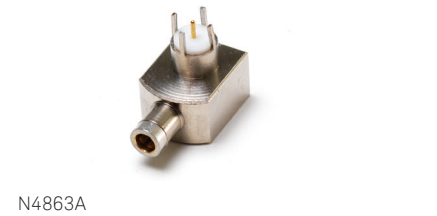
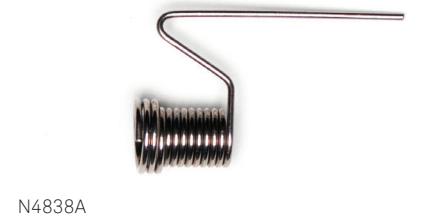
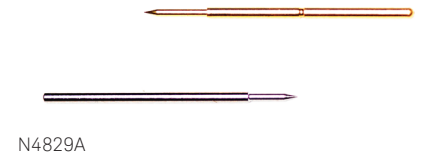

General Purpose Passive Probes – N2870A-76A Passive Probes (continued)

Standard accessories

	N2871A, N2872A, N2873A, N2875A	N2870A	N2874A, N2876A
Rigid probe tips, qty 2	■	■	■
Spring-loaded probe tips, qty 2	■	■	■
Sprung hook 2.5 mm	■	■	
Short sprung hook 2.5 mm			■
Ground blade 2.5 mm with 2 copper pads	■	■	■
IC cap 2.5-0.5 mm green	■	■	■
IC cap 2.5-0.65 mm blue	■	■	■
IC cap 2.5-0.8 mm gray	■	■	■
IC cap 2.5-1.0 mm brown	■	■	■
IC cap 2.5-1.27 mm black	■	■	■
Insulating cap 2.5 mm	■	■	■
Protection cap 2.5 mm	■	■	■
BNC adapter 2.5 mm	■	■	■
Ground spring 2.5 mm	■	■	■
Ground lead 15 cm	■	■	■
Trimmer tool	■		
Color coded rings 3x4	■	■	■
User's guide manual	■	■	■

Other replacement parts

Part number	Description
0960-2907	Short spring hook 2.5 mm for N2874A and N2876A 1.5 GHz passive probe
0960-2908	10 self-adhesive copper-pads 2X2 cm for N2870A Series probes

For other re-orderable accessories for N2870A-76A passive probes, check out the product web page on www.keysight.com/find/probes.

General Purpose Passive Probes – 1165A Passive Probe

- Standard passive probe for Infiniium 5483x Series
- Compact design, removable probe handle for tight probing areas

These general purpose replacement devices are built and tested for high reliability. Kevlar strengthener has been added to the probe cable for extra pull strength. Durable probe tips are replaceable.

The compact design significantly reduces the problem of probing densely populated integrated circuit components or the characteristically minute conductors on printed circuit boards. These small, lightweight probes allow measurements that were previously difficult, while reducing the danger of shorting. For tight probing areas, the probe handle can be unscrewed and pulled back along the cable.

When probing about the circuit in debug mode, the probes easily slip inside the included browsers. The browsers feature a crown point that digs into solder and avoids the danger of slipping off the test point and shorting to adjacent leads. A pogo pin allows hand movement on the probes without losing contact with the device under test.

A snap-on BNC connector simplifies attaching the probe to the scope. Leads are available for connecting to a wide variety of test points. See “Ordering Information” for a complete list.

Electrical characteristics

Model number	Type of probe	System bandwidth (scope+probe)	Division ratio	Input R	Input C	Scope input R	Comp range	Length
1165A	High impedance, passive	600 MHz typical with 54830B/31B/32B/33A 54830D/31D/32D/33D	10:1	10 MΩ	10 pF	1 MΩ	12 - 14 pF	1.5 m

Operating characteristics 1165A passive probe

	1165A
Approximate propagation delay	6.7 ns
Maximum input voltage	300 V (dc + peak ac), CAT II
Safety	Meets IEC1010-2-31
Pulling strength (BNC to barrel)	≤ 12 lb static pull
Net weight	2.6 oz

Environmental characteristics

	1165A
Temperature (operating)	0° C to +55° C
Humidity (operating)	Up to 95% relative humidity at 40° C
Altitude (operating)	Up to 4,600 meters (15,000 ft.)
Shock	50 g (400 g tip only)

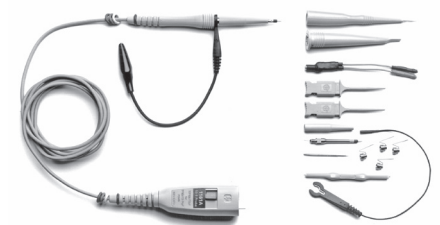

1165A 500 MHz passive probe



No-slip browser crown point

General Purpose Passive Probes – 1165A Passive Probe (continued)

Ordering information

Probes and accessories

Model number	Description	Quantity
1165A	10:1, 10 MΩ, 1.5 m, miniature passive probe	1
5063-2143	Probe tip to BNC (m) IC clips: See “Probing Accessories” Horizontal and vertical mini-probe sockets: See “Probing Accessories” Wedge Probe Adapters: See “Probing Accessories”	1

Replacement parts

Part number	Description	Quantity
5063-2135	General purpose retractable hook tip	2
5063-2140	Alligator ground lead	2
5063-2120	Socketed ground lead	1
5063-2115	Browser	1
5063-2147	Dual lead adapter	1
5063-2149	SMD clips	5
01160-68701	Accessory kit (includes four spring grounds, four browser pogo pins, four barrel insulators, one screwdriver)	1
5063-2137	1165A probe tip, brown	5

Probe parts supplied

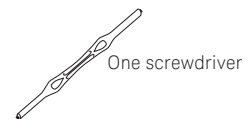
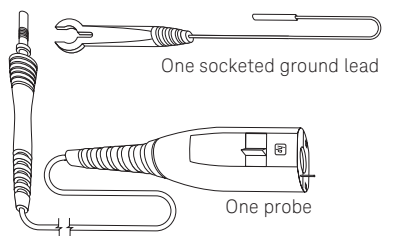
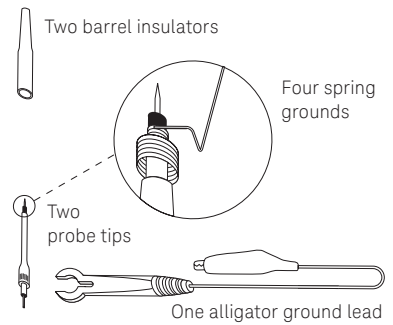
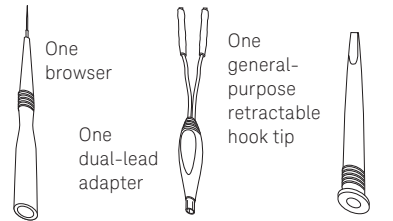
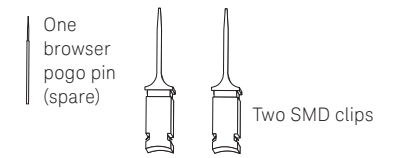

Includes user's guide and three-year warranty

General Purpose Passive Probes – 54006A High Bandwidth Passive Probe

- Useful in probing high-frequency signals with low source impedance
- Supplied with 10:1, 500 Ω and 20:1, 1 k Ω resistor dividers
- Low capacitive loading to extremely high frequencies

The Keysight 54006A allows you to probe signals up to 6 GHz using replaceable tips that provide either 10:1 division ratio with 500 Ω input resistance, or a 20:1 division ratio with 1 k Ω input resistance. This 6 GHz probe gives access to circuit nodes that are not 50 Ω or do not have 50 Ω connectors allowing you to see signals at specific points, such as the input to a gate. Keysight 54006A's input capacitive loading is approximately 0.25 pF, allowing you to get very accurate timing measurements for a wide bandwidths of signals.

The 54006A probe is a good, low-cost alternative for high-frequency probing where the higher resistive loading is not an issue and the other features of the InfiniiMax probing system are not needed (such as differential inputs and multiple connectivity options).

Operating characteristics the 54006A passive probe

	54006A
Bandwidth (-3 dB)	6 GHz
Attenuation ratio	10:1, 20:1
Input resistance	500 Ω , 1 k Ω
Input capacitance	0.25 pF
Max dc volts	20 V
Length in meters (feet)	0.9 m (3 ft)

Ordering information

Model number	Description	Quantity
54006A*	6 GHz resistor divider probe Includes: One 10:1 500 Ω probe body, six 450 Ω resistors, One 20:1, 1 k Ω probe body, six 950 Ω resistors, One 36 in, 50 Ω coaxial cable, SMA (m-m) One blocking cap, 10 GHz-26 GHz APC - 3,5 (m-f)	1

* Requires the 54855-67604 SMA to precision-BNC adapter to connect to BNC scope input

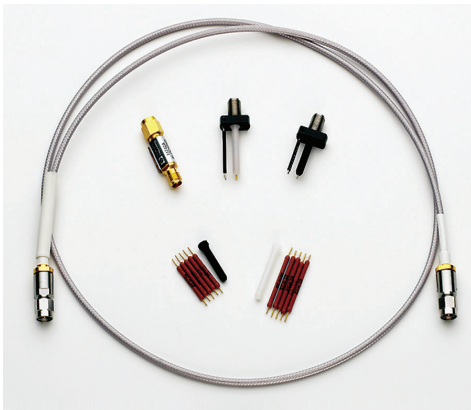

54006A for probing high frequency, up to 100 Ω impedance signals

High Voltage Passive Probes – 10076C 100:1 Passive Probe

- Ideal for measuring up to 30 kV
- Up to 500 MHz bandwidth
- 100:1 or 1000:1 attenuation

The Keysight 10076C 4 kV 100:1 passive probe gives you the voltage and bandwidth you need for making high-voltage measurements. Its compact design makes it easier to probe today’s small power electronics components and its rugged construction means it can withstand rough handling without breaking.

The 10076C is compatible with any oscilloscope with 1 MΩ BNC input. For use with the Infiniium 90000 Series scope, use the E2697A high impedance probe adapter. For use with the Infiniium 90000 X- and 90000 Q-Series scope, use the N5449A high impedance probe adapter.



10076C passive probe

Operating characteristics the 10076C 100:1 passive probe

	10076C
Bandwidth	500 MHz (-3 dB)
Rise time (calculated)	< 0.7 ns
Attenuation ratio	100:1
Input resistance	66.7 MΩ (when terminated into 1 MΩ)
Input capacitance	Approx 3 pF
Maximum input	4000 Vpk CAT I, 1000 Vpk CAT II
Compensation	6 to 20 pF range
Probe readout	Yes
Cable length	1.8 m



10077A accessory kit for 10076B/c

Ordering information

Model number	Description	Quantity
10076C	High-voltage probe: includes one retractable hook tip, one-ground-bayonet, one IC probing tip, one-alligator ground lead and a compensation screwdriver	1
10077A	Accessory kit for 10076B/C including 1x retractable hook pin, 1x ground lead, 1x insulation cap, 2x measuring pins and 8x ID tags	1
N2789A	Spring ground tip for 10076B/C	1



N2789A spring ground tip for 10076B/C

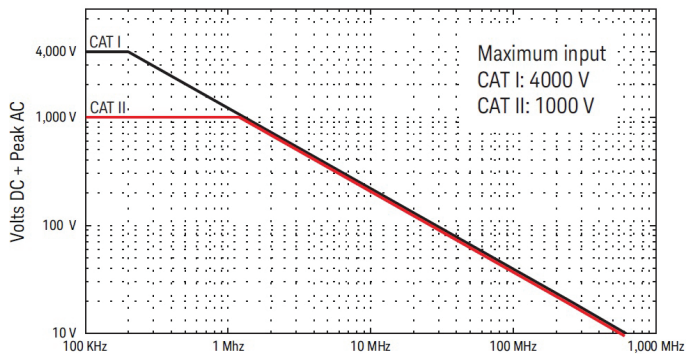

10076C derating curve

High Voltage Passive Probes – N2771B 1000:1 Passive Probe

- Ideal for measuring up to 30 kV
- Up to 250 MHz bandwidth
- 100:1 or 1000:1 attenuation

The N2771B is a 1000:1 divider probe for the measurement of fast high voltage signals up to 30 kV dc + peak ac, 10 kV rms.

The probe's large size and rugged construction provide superior protection. The ground lead is fed through the body of the probe and protrudes behind the safety barrier, keeping the ground connection away from the high voltage. Typical applications include PMTs, motor drives, high voltage switches, magnetrons, and modern projection systems.

The N2771B is compatible with any oscilloscope with 1 M Ω BNC input. For use with the Infiniium 90000 Series scope, use the E2697A high impedance probe adapter. For use with the Infiniium 90000X and 90000 Q-Series scope, use the N5449A high impedance probe adapter.

Operating characteristics the N2771B 1000:1 passive probe

	N2771B
Bandwidth	50 MHz (–3 dB)
Rise time	< 7 ns
Attenuation ratio	1000:1
Input resistance	100 M Ω (when terminated into 1 M Ω)
Input capacitance	1 pF
Compensation range	6 to 20 pF
Max. voltage	15 kV dc, 10 kV rms, 30 kV dc + peak ac
Operating temperature	0 to +50 °C, 80% RH
Storage temperature	–20 to +70 °C, 90% RH
Dimensions	2 cm (max width of probe stem after handle) x 33 cm 7.5 cm (max probe width probe handle) x 33 cm
Probe readout	No
Cable length	2 m

Ordering information

Model number	Description	Quantity
N2771B	High-voltage probe: includes alligator ground lead, 1-sharp-probe tip	1



N2771B high-voltage probe

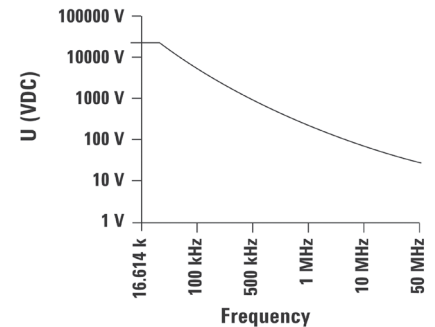

N2771B derating curve

Mixed Signal Oscilloscope Logic Probes and Accessories

- Compatible with all 40-pin logic probe
- Flying leads offer flexibility and convenience

MSO probes offer great value and performance

The logic probe for the MSO9000A and S-Series mixed signal oscilloscopes (MSOs) are the same one used with Keysight industry leading high-performance logic analyzers. This means we can offer the best performance, great value and access to the industry's broadest range of logic probing accessories.

The Infiniium MSO9000A and S-Series come with a 54826-68701 16-channel logic probe kit containing a 40-pin (F) to 40-pin (F) logic probe cable assembly (or external digital cable), 2-inch ground leads (qty 5), SMT IC clips (qty 20) and a 16-channel flying lead probe tip assembly. The standard cable gives the MSO the standard 40-pin female input connector that many Keysight logic analyzers have. With this cable, a user can connect a wide variety of logic analyzer probes such as Mictor, Samtec, and Soft Touch probes. For information on these probes, see Probing solutions for logic analyzers (with Keysight literature number 5968-4632E).

For optimal signal fidelity, connect ground at each logic probe, in addition to taking a common ground to all eight signals via a separate ground connector on the probe pod.



Eternal digital cable
(part number 54826-61605)



SMT IC clip
(part number 5090-4833)



Sixteen-channel probe lead set
(part number 54838-61608)

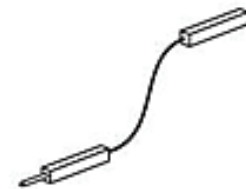

Ground leads contain 5 short ground leads
(part number 5959-9334)

Characteristics for Keysight 54826-68701 Logic Probe

Analog bandwidth of cable and flying leads	400 MHz
Input resistance	100 kΩ ± 2%
Input capacitance	8 pF at the tip

Kit parts supplied

16-channel probe set leads	x1
Ground leads	x5
SMT IC clips	x20
External digital cable	x1

Mixed Signal Oscilloscope Logic Probes and Accessories (continued)

The 9000 MSO digital channels were architected to be compatible with a wide variety of probing accessories developed over 20 years for logic analyzers. There's a good chance that the logic analyzer accessories you already own work with your MSO. With the standard 40-pin cable that comes with your MSO, the MSO accepts numerous logic analyzer accessories including:

- E5346A 34-channel Mictor connector probe
- E5385A 34-channel Samtec connector
- E5383A 16-channel flying lead set 01650-63203 16-channel termination adapter (also available as a bundle of both the termination adapter and the 40-pin cable with PN 10085-68701)
- E5404A 34-channel soft touch pro connectorless probe
- E5394A 34-channel soft touch connectorless probe
- E5396A 16-channel soft touch connectorless probe
- Any other accessory that connects to a logic analyzer via a 40-pin cable

For logic accessories of greater channel width than MSO digital channels (> 16 channels), there are two use models.

- Route up to 16 signals to the probe and don't use the additional probe channels.
- Route up to 32 signals to the probe and measure ½ of them at a time. Simply plug the 40-pin cable to the other side of the probe to see the other ½ of the signals.

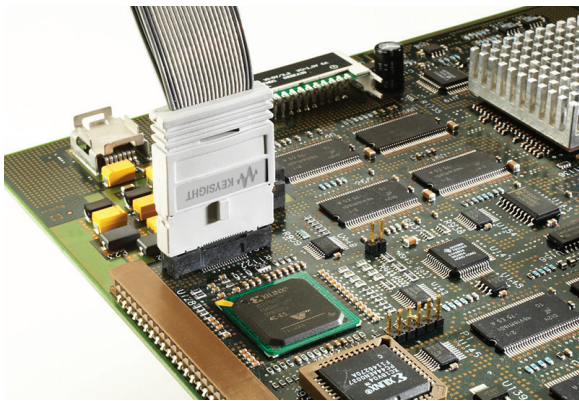

E5346A 34-channel Mictor connector probe

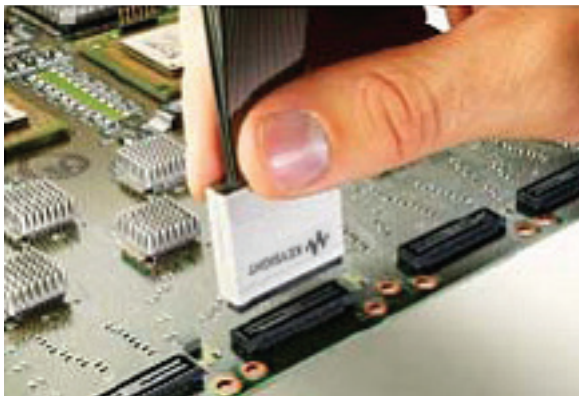

E5385A 34-channel Samtec connector probe



E5396A 16-ch (half size) soft touch connectorless probe

Probing Accessories – InfiniiMax Probe

InfiniiMax 1130A/31A/32A/34A and InfiniiMax II 1168A/69A probe accessories

Unrivaled InfiniiMax and InfiniiMax II probing accessories support browsing, solder-in, socket, and SMA use models at the maximum performance available

E2669A	InfiniiMax connectivity kit for differential/single-ended measurements	Fully compatible with 1130/31/32/34A InfiniiMax probe amplifier and compatible 1168A/69A InfiniiMax II probe amplifier with limitations
E2668A	InfiniiMax connectivity kit for single-ended measurements	
E2675B	InfiniiMax differential browser probe head and accessories (6-GHz BW)	
E2676A	InfiniiMax single-ended browser probe head and accessories (6-GHz BW)	
E2677A	InfiniiMax differential solder-in probe head and accessories (12-GHz BW)	
E2678B	InfiniiMax single-ended/differential socketed probe head and accessories (12-GHz BW)	
E2679A	InfiniiMax single-ended solder-in probe head and accessories (6-GHz BW)	
N2851A	InfiniiMax I/II QuickTip probe head (13-GHz BW, order N2849A QuickTip tips) (12-GHz BW)	
N5425A/N5426A	InfiniiMax differential ZIF solder-in probe head and ZIF probe tips (12-GHz BW)	
N2851A	InfiniiMax I/II QuickTip probe head (13-GHz BW, order N2849A QuickTip tips)	
N5451A	InfiniiMax long-wire ZIF probe tips (for use with N5425A ZIF probe head)	
N5450B	InfiniiMax extreme temperature extension cable (allows for probing in temperatures ranging from –55 to 150 °C)	
N2880A	InfiniiMax in-line attenuator kit (pairs of 6, 12, and 20 dB attenuators in a kit)	
N2881A	InfiniiMax DC blocking caps (a pair of 30-Vdc blocking caps)	
N2884A	InfiniiMax fine-wire probe tips for wafer probing (for use with N5425A ZIF head)	Recommended for use with InfiniiMax II 1168A/69A probe amplifier N5381A is compatible with InfiniiMax I amps, (select E2677A in the probe menu)
N5380B	InfiniiMax II differential SMA adapter (12-GHz BW)	
N5381A	InfiniiMax II differential solder-in probe head and accessories (12-GHz BW)	
N5382A	InfiniiMax II differential browser (12-GHz BW)	
N2887A	InfiniiMax Soft touch Pro probe interface adapter (4 GHz)	
N2888A	InfiniiMax Soft touch half-channel probe interface adapter (4 GHz)	

InfiniiMax III N2800A/01A/02A/03A and InfiniiMax III+ N2830A/31A/32A/N7000A/01A/02A/03A probe accessories

N5445A	InfiniiMax III browser head (30 GHz)	Order N5476A for replacement probe tips (set of 4)
N2848A	InfiniiMax III QuickTip probe head (16 GHz)	Supports InfiniiMode with InfiniiMax III+ amp. Order N2849A QuickTip tips (set of 4 tips)
N5439A	InfiniiMax III ZIF probe head (28 GHz)	Order N2838A (450 Ω), N5440A (450 Ω) or N5447A (200 Ω) for a set of 5 ZIF tips with plastic sporks
N5444A	InfiniiMax III 2.92 mm/3.5 mm/SMA probe head (28 GHz)	Order N5448A 3.5/2.92 mm head flex cable to extend the cable length. Supports InfiniiMode with InfiniiMax III+ amp
N2836A	InfiniiMax III solder-in probe head (26 GHz)	Supports InfiniiMode with InfiniiMax III+ amp
N5441A	InfiniiMax III solder-in probe head (16 GHz)	



InfiniiMax probe with N5450B extreme temperature extension cable



N2880A InfiniiMax in-line attenuator (probe amplifier and head not included)

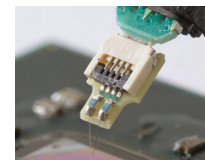

N2884A InfiniiMax fine-wire probe tip (ZIF probe head not included)

Probing Accessories – N2744A T2A Probe Interface Adapter

- Enables Tektronix TekProbe-BNC level 2 probes to connect to Keysight's AutoProbe interface on InfiniiVision 3000X, 4000X, 6000X, 5000, 6000, 7000, and Infiniium 9000, 90000, and S-Series oscilloscopes
- An easy-to-use plug-on adapter to the Keysight oscilloscope's AutoProbe interface
- Provides necessary probe power, calibration, and offset control as needed to the attached TekProbe probe



The N2744A T2A interface adapter enables selected TekProbe interface level 2 probes to be used with Keysight oscilloscopes with AutoProbe interface. Existing TekProbe-BNC probe types can simply be plugged into the T2A adapter, which is then plugged directly into any AutoProbe input channel on an InfiniiVision or Infiniium oscilloscope. Select the probe model in the scope menu and the Keysight oscilloscope sets up the attenuation factor and the probe type automatically. The T2A interface adapter supplies the necessary probe power, calibration (for selected models only), and offset control as used by the connected TekProbe probe. The adapter is targeted for customers using both Tek active probes with TekProbe-BNC level 2 interfaces and Keysight oscilloscopes with the AutoProbe interface.

Tek probe compatibility

The N2744A T2A adapter supports only the probes listed below with TekProbe interfaces.

AC/DC current probe

TCP202	50-MHz AC/DC current probe
--------	----------------------------

Single-ended active probes

P6243	Single-ended active probe, 1 GHz, 10:1 without offset control
P6245	Single-ended active probe, 1.5 GHz, 10:1 with offset control
P6205	Single-ended active probe, 750 MHz, 10:1 without offset control
P6241	Single-ended active probe, 4 GHz, 10:1 with offset control
P6249	Single-ended active probe, 4 GHz, 5:1 with offset control

Differential active probes

P5205/ P5205A	Differential probe, 100 MHz, 50:1/500:1 with offset control (works with InfiniiVision 3000X, 4000X, 6000X, 5000, 6000 and 7000 Series oscilloscopes. Choose P5205 in the listing when you use P5205A)
P5210/ P5210A	Differential probe, 50 MHz, 100:1/1000:1 with offset control (works with InfiniiVision 3000X, 4000X, 6000X, 5000, 6000 and 7000 Series oscilloscopes. Choose the P5210 in the listing when you use P5210A)
P6246	400 MHz, 10:1/1:1 with offset control
P6247	1 GHz, 10:1/1:1 with offset control
P6248	1.5 GHz, 10:1/1:1 with offset control
P6250	500 MHz, 50:1/5:1 with offset control
P6251	1 GHz, 50:1/5:1 with offset control

Keysight scope compatibility

- Keysight InfiniiVision 3000 X-Series with software version 1.10 or higher
- Keysight InfiniiVision 4000 X- and 6000 X-Series
- Keysight InfiniiVision 5000, 6000, and 7000 Series and future revisions (except 6000 100-MHz) with software version 06.16 or higher
- Keysight Infiniium 9000, V-Series, 90000A/X/Q, Z-Series (with N5442A) Series with software version 03.11 or higher
- Keysight Infiniium S-Series

Optical-to-electrical converters

(works with InfiniiVision 5000, 6000 and 7000 with version 6.16 software only)

P6701B	1 GHz Optical-to-electrical converter with FC/PC connector
P6703B	1.2 GHz Optical-to-electrical converter with FC/PC connector
P6711	250 MHz Optical-to-electrical converter
P6713	300 MHz Optical-to-electrical converter

Ordering information

N2744A	T2A probe interface adapter
--------	-----------------------------

Probing Accessories – N2784A/85A/86A/87A Probe Positioners

- Easy-to-manipulate probe arms for hands-free browsing
- One- or two-articulated arms with stable high-mass base (N2784A and N2785A)
- Quick and stable XY positioning (N2786A)
- Stable 3D probe positioning for hard-to-reach XYZ access
- Compatible with most scope probes
- Applications: Hands-free browsing for electronic components on PC board

The N2784A and N2785A probe positioners provide quick and stable X-Y positioning for PC boards and devices that require hands-free probing.

Unlike other probe positioners that require multiple adjustments to lock the probe holder into position, the N2784A and N2785A need only the “lift and drop” motion to put the probe in place. The weight stabilization technique used in these probe holders keeps constant pressure at the probing point so the probe tip stays in position even when the target board is bumped.

The N2786A is a low cost, easy-to-use XY axis probe holder for general purpose probing applications. The two-leffed positioner is designed to be easy to use—the positioner itself has no controls to positioner it in place.

The N2787A is a 3D probe positioner with a flexible, articulating arm that can be quickly positioned in a variety of configurations.

For more information about Keysight’s probe positioners, refer to literature number 5989-9131EN.

Ordering information

Product number	Description
N2784A*	1-arm probe positioner
N2785A*	2-arm probe positioner
N2786A	2-leg probe positioner
N2787A	3D probe positioner

* Includes 3x magnifying glass, arm strap, cable tie, probe rest, and manual



N2786A 2-leg probe positioner



N2787A 3D probe positioner

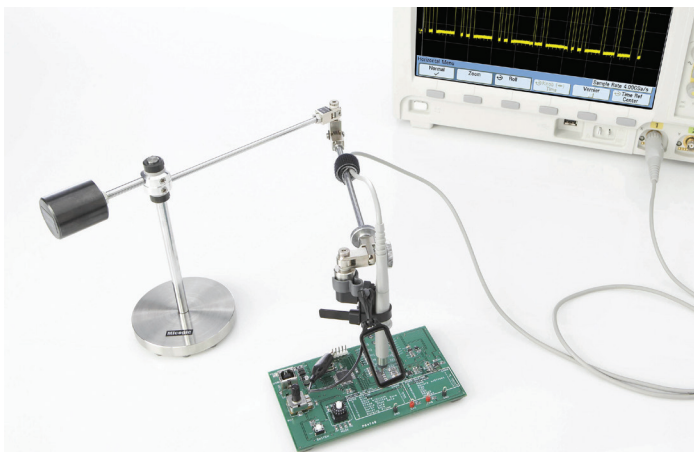

N2784A one-arm probe positioner

Probing Accessories – Wedge Probe Adapters

- Easy connection to surface mount ICs
- Safe, with no chance of shorting
- Mechanically non-invasive contact
- 3-, 8-, and 16-signal versions
- Supports 0.5 and 0.65-mm TQFP and PQFP packages

Problem-free probing

The Keysight wedge probe adapter eliminates many of the frustrations associated with probing surface mount components. If you've ever accidentally shorted IC pins together, experienced electrical and/or mechanical problems with soldering small wires onto leads, or gotten frustrated juggling multiple probes while you're trying to operate your scope, the Wedge was designed with you in mind.

Make the inaccessible accessible

When you use the Wedge, you don't have to worry about shorting IC pins together on a delicate component—or worse yet, on an irreplaceable prototype. The Wedge is easy to insert and it stays put. There's no need to solder small wires onto leads. The Wedge is mechanically non-invasive, so you won't damage the legs of the IC. Instead, you'll have easy access to hard-to-reach components.



Operating characteristics

E26xx Series wedge probe adapters	
Operating voltage	< 40 Vdc + peak ac
Operating current	0.5 A maximum
Capacitance between contacts	2 pF typical (all except Keysight-E2643A/44A) 4.33 pF typical at 1 MHz (Keysight-E2643A/44A)
Self-inductance	15 nH typical (all except Keysight E2643A/44A) 37 nH typical at 1 MHz (Keysight E2642A/44A)
Cross coupling	-31 dB typical at 100 MHz (Keysight E2643A/44A)
Contact resistance	< 0.1 Ω

Ordering information

Model number	Description	Quantity
E2613A	0.5 mm Wedge probe adapter, 3 signal	1
E2614A	0.5 mm Wedge probe adapter, 8 signal	1
E2643A	0.5 mm Wedge probe adapter, 16 signal	1
E2615A	0.65 mm Wedge probe adapter, 3 signal	1
E2616A	0.65 mm Wedge probe adapter, 8 signal	1
E2644A	0.65 mm Wedge probe adapter, 16 signal	1
10072A	SMT kit for 10070 probe family	
10075A	0.5 mm IC clip kit	

Electrical reliability

The Wedge makes two contact points with each leg of the IC. This redundant physical connection increases the electrical reliability of the connection. Also the Wedge's low capacitance and inductance provides superior performance to many other alternatives.

The Wedge probe adapter connects directly to 1145A/1155A active probes and the dual lead adapter provided with the 1160A-65A passive probe family and N2877A/N2879A accessory kits for use with N287xA Series passive probes.

IC clip kits

As an inexpensive solution for probing fine-pitch ICs, the 10072A SMT Kit includes 10 IC clips and 2 dual-lead adapters that connect the clips directly to 10070-family probes.

The 10075A 0.5-mm IC clip kit is ideal for connecting to IC's as fine as 0.5 mm. The clip body allows many clips to be mounted side-by-side. The kit includes four 0.5-mm IC clips and two dual-lead adapters that connect the IC clips directly to 10070-family probes.

Probing Accessories – Fine Pitch and PC Board Accessories

0.5 mm IC clips

- Extremely small size
- Thin body for mounting multiple clips side-by-side
- Connection to PQFP and SOIC SMT packages from 0.5 to 0.8 mm (0.020 in. to 0.032 in.) lead pitch

The 0.5 mm IC clips connect directly to the Infiniium MSO logic probe flying leads, N2870A-76A or 1160A-65A passive probe with dual lead adapter, and 1007x passive probe with optional 10072A or 10075A that contain the dual lead adapter. Maximum input voltage is +40 V.

Operating characteristics

0.5 IC Clips	
Length	31.75 mm (1.25 inch)
Tip diameter	0.75 mm (0.029 inch)
Pin diameter	0.75 mm (0.029 inch)

Ordering information

Part number	Description	Quantity
10467-68701	0.5 mm IC clips	4

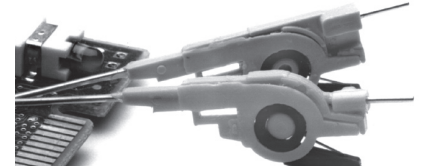

Extremely small-sized clips for probing PQFP and SOIC SMT packages

PC board mini-probe sockets

- Hands-free probing of through-hole devices
- Compatible with N2870A-76A and 1160A-65A family probes

The PC board mini-probe sockets are ideal for a reliable, convenient, high bandwidth connection between the N2870A-76A and 1160A-65A family passive probe tip, and the circuit under test.

Ordering information

Part number	Description	Quantity
N2766A	Horizontal mini-probe socket	25
N2768A	Vertical mini-probe socket	25

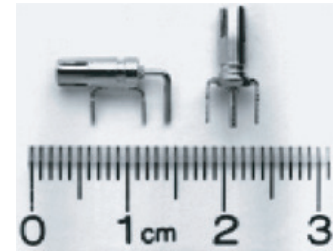

Horizontal and vertical versions of the PC board mini-probe socket make it easy to fit into your target board.

E2697A high impedance adapter

- Allows connection of high impedance probes to the 50 ohm input of Infiniium 54850, 80000 and 90000 Series oscilloscopes
- Includes 500 MHz passive probe (10073D)
- Provides switchable AC/DC coupling as well as 10:1 and 1:1 attenuation settings

Ordering information

Part number	Description	Quantity
N2697A	High impedance adapter	1



The E2697A high impedance adapter allows connection of probes that require a 1 M Ω high impedance input (e.g., passive probes, current probes) to the Infiniium 54850, 80000 and 90000 Series oscilloscopes. The E2697A high impedance adapter extends the capability of Keysight Infiniium high-performance oscilloscopes, making them ideal for a variety of general-purpose measurements such as power supplies, inverters, semiconductor devices, etc. The E2697A provides switchable AC/DC coupling, as well as 10:1 and 1:1 attenuation settings. Use the N5449A high impedance adapter with Infiniium 90000X and 90000Q Series scopes.

Related Literature

Publication title	Publication type	Publication number
<i>Keysight Oscilloscope Probes and Accessories</i>	Selection Guide	5989-6162EN
<i>InfiniiVision Oscilloscope Probes and Accessories</i>	Data Sheet	5968-8153EN
<i>8 Hints for Better Scope Probing</i>	Application Note	5989-7894EN
<i>Oscilloscope Probing for High-Speed Signals</i>	Application Note	5989-9177EN
<i>Performance Comparison of Differential and Single-ended Active Voltage Probes</i>	Application Note	5988-8006EN
<i>Improving Usability and Performance in High-Bandwidth Active Oscilloscope Probes</i>	Application Note	5988-8005EN
<i>Optimizing Oscilloscope Measurement Accuracy on High-Performance Systems with Keysight Active Probes</i>	Application Note	5988-5021EN
<i>Restoring Confidence in Your High-Bandwidth Probe Measurements</i>	Application Note	5988-7951EN
<i>The Truth About the Fidelity of High-Bandwidth Voltage Probes</i>	Application Note	5988-6515EN
<i>Extending the Range of Keysight InfiniiMax Probes</i>	Application Note	5989-7587EN
<i>Understanding and Using Offset in InfiniiMax Active Probes</i>	Application Note	5988-9264EN
<i>Tips for Making Low Current Measurements with an Oscilloscope and Current Probe</i>	Application Note	5989-7529EN
<i>Using Keysight InfiniiMax Probes with Test Equipment Other Than Oscilloscopes</i>	Application Note	5989-1869EN
<i>Why Oscilloscope Measurements may Require Extreme Probing</i>	Application Note	5990-4721EN
<i>Side by Side Comparison of Keysight and Tektronix Probing</i>	Application Note	5989-0553EN
<i>Tips and Techniques for Making Power Supply Noise Measurements with an Oscilloscope</i>	Application Note	5989-6755EN
<i>Time-Domain Response of Keysight InfiniiMax Probes</i>	Application Note	5988-9608EN
<i>How Offset, Dynamic Range and Compression Affect Measurements</i>	Application Note	5990-8255EN
<i>Keysight InfiniiMax Probes Impact on Lead-Free (ROHS) Compliance</i>	Application Note	5989-5179EN

myKeysight

myKeysight

www.keysight.com/find/mykeysight

A personalized view into the information most relevant to you.



www.axiestandard.org

AdvancedTCA® Extensions for Instrumentation and Test (AXIe) is an open standard that extends the AdvancedTCA for general purpose and semiconductor test. Keysight is a founding member of the AXIe consortium. ATCA®, AdvancedTCA®, and the ATCA logo are registered US trademarks of the PCI Industrial Computer Manufacturers Group.



www.lxistandard.org

LAN eXtensions for Instruments puts the power of Ethernet and the Web inside your test systems. Keysight is a founding member of the LXI consortium.



www.pxisa.org

PCI eXtensions for Instrumentation (PXI) modular instrumentation delivers a rugged, PC-based high-performance measurement and automation system.



Three-Year Warranty

www.keysight.com/find/ThreeYearWarranty

Keysight's committed to superior product quality and lower total cost of ownership. Keysight is the only test and measurement company with three-year warranty standard on all instruments, worldwide. And, we provide a full one-year warranty on all accessories, calibration devices, systems and custom products.



Keysight Assurance Plans

www.keysight.com/find/AssurancePlans

Up to five years of protection and no budgetary surprises to ensure your instruments are operating to specification so you can rely on accurate measurements.



www.keysight.com/go/quality

Keysight Technologies, Inc.
DEKRA Certified ISO 9001:2008
Quality Management System

Keysight Channel Partners

www.keysight.com/find/channelpartners

Get the best of both worlds: Keysight's measurement expertise and product breadth, combined with channel partner convenience.

MIPI® and M-PHY® are registered trademarks owned by the MIPI Alliance.

www.keysight.com/find/probe

For more information on Keysight Technologies' products, applications or services, please contact your local Keysight office. The complete list is available at: www.keysight.com/find/contactus

Americas

Canada	(877) 894 4414
Brazil	55 11 3351 7010
Mexico	001 800 254 2440
United States	(800) 829 4444

Asia Pacific

Australia	1 800 629 485
China	800 810 0189
Hong Kong	800 938 693
India	1 800 11 2626
Japan	0120 (421) 345
Korea	080 769 0800
Malaysia	1 800 888 848
Singapore	1 800 375 8100
Taiwan	0800 047 866
Other AP Countries	(65) 6375 8100

Europe & Middle East

Austria	0800 001122
Belgium	0800 58580
Finland	0800 523252
France	0805 980333
Germany	0800 6270999
Ireland	1800 832700
Israel	1 809 343051
Italy	800 599100
Luxembourg	+32 800 58580
Netherlands	0800 0233200
Russia	8800 5009286
Spain	800 000154
Sweden	0200 882255
Switzerland	0800 805353
	Opt. 1 (DE)
	Opt. 2 (FR)
	Opt. 3 (IT)
United Kingdom	0800 0260637

For other unlisted countries:
www.keysight.com/find/contactus
(BP-07-24-15)



www.keysight.com/go/quality

Keysight Technologies, Inc.
DEKRA Certified ISO 9001:2008
Quality Management System

This information is subject to change without notice.
© Keysight Technologies, 2012 - 2015
Published in USA, August 19, 2015
5968-7141EN
www.keysight.com