

Agilent N6700 Modular Power System Family

N6731B-N6784A DC Power Modules
N6700B-N6705B Mainframes

Specifications Guide



Agilent Technologies

Legal Notices

© Agilent Technologies, Inc. 2010 - 2012

No part of this document may be photocopied, reproduced, or translated to another language without the prior agreement and written consent of Agilent Technologies, Inc. as governed by United States and international copyright laws.

Warranty

The material contained in this document is provided "as is," and is subject to being changed, without notice, in future editions. Further, to the maximum extent permitted by applicable law, Agilent disclaims all warranties, either express or implied, with regard to this manual and any information contained herein, including but not limited to the implied warranties of merchantability and fitness for a particular purpose. Agilent shall not be liable for errors or for incidental or consequential damages in connection with the furnishing, use, or performance of this document or of any information contained herein. Should Agilent and the user have a separate written agreement with warranty terms covering the material in this document that conflict with these terms, the warranty terms in the separate agreement shall control.

Manual Editions

Manual Part Number: N6700-90001
Sixth Edition, February 2012
Available in electronic format only.

Updates of this manual containing minor corrections may have the same edition date. Revised editions are identified by a new edition date.

Certification

Agilent Technologies certifies that this product met its published specifications at time of shipment from the factory. Agilent Technologies further certifies that its calibration measurements are traceable to the United States National Institute of Standards and Technology, to the extent allowed by the Institute's calibration facility, and to the calibration facilities of other International Standards Organization members.

Technologies Licenses

The hardware and or software described in this document are furnished under a license and may be used or copied only in accordance with the terms of such license.

U.S. Government Restricted Rights

Software and technical data rights granted to the federal government include only those rights customarily provided to end user customers. Agilent provides this customary commercial license in Software and technical data pursuant to FAR 12.211 (Technical Data) and 12.212 (Computer Software) and, for the Department of Defense, DFARS 252.227-7015 (Technical Data – Commercial Items) and DFARS 227.7202-3 (Rights in Commercial Computer Software or Computer Software Documentation).

Declaration of Conformity

Declarations of Conformity for this product and for other Agilent products may be downloaded from the Web. Go to <http://regulations.corporate.agilent.com> and click on "Declarations of Conformity." You can then search by product number to find the latest Declaration of Conformity.

Regulatory Symbols



The CE mark shows that the product complies with all applicable European Directives.



The C-Tick mark is a registered trademark of the Australian Communications Authority.

ICES/NMB-001

This ISM device complies with Canadian ICES-001.

Cet appareil ISM est conforme à la norme NMB-001 du Canada.



This is the symbol for an Industrial, Scientific and Medical, Group 1 Class A product.



The CSA mark is a registered trademark of Intertek-etlsemko Inc.



This is the RoHS (Restriction of Hazardous Substances) symbol for electrical and electronic equipment.



This symbol indicates separate collection for electrical and electronic equipment mandated under EU law as of August 13, 2005. All electric and electronic equipment are required to be separated from normal waste for disposal (Reference WEEE Directive 2002/96/EC).

Where to Find More Information

This document provides specification and supplemental characteristic information for the following instruments:

- Agilent N6731B through N6784A Power Modules
- Agilent N6700B through N6705B Mainframes

For additional technical details and ordering information for the Agilent N6700 Modular Power System Family, refer to the following:

Document

Agilent N6700 Modular Power System Family: Low-Profile MPS Mainframe for Automated Test Environments

Description

The Agilent N6700 Low-Profile Modular Power System (MPS) is a 1U (rack unit) high, multiple-output programmable DC power supply system that enables test system integrators to optimize performance, power and price to match test needs.

Go to: <http://cp.literature.agilent.com/litweb/pdf/5989-1411EN.pdf>

Agilent N6700 Modular Power System Family: DC Power Analyzer Mainframe for R&D

The Agilent N6705 DC Power Analyzer represents an entirely new instrument category for R&D engineers. It provides unrivaled productivity gains when sourcing and measuring DC voltage and current into a DUT. Using the Agilent N6705 DC Power Analyzer, R&D engineers can gain insights into the DUT's power consumption in minutes, with all sourcing and measuring functions available from the front panel.

Go to: <http://cp.literature.agilent.com/litweb/pdf/5989-6319EN.pdf>

Agilent N6700 Modular Power System Family: N6780 Series Source/Measure Units

The Agilent N6781A and N6782A 2-quadrant SMUs offer advanced sourcing and measurement capabilities required to overcome test challenges associated with optimizing power consumption and maximizing battery life of battery-powered devices and their components. The Agilent N6784A 4-quadrant SMU offers advanced sourcing and measurement capabilities in four quadrants for general purpose applications.

Go to: <http://cp.literature.agilent.com/litweb/pdf/5990-5829EN.pdf>

Agilent N6700 Modular Power System Family: Battery Charge/Discharge Module

The Agilent N6783A-BAT battery charge/discharge module is a basic, 2-quadrant DC power module designed to be used by mobile device designers. Its 2-quadrant operation allows it to act as a programmable power supply to charge the battery or as a programmable electronic load to discharge the battery, all in one instrument.

Go to: <http://cp.literature.agilent.com/litweb/pdf/5990-8662EN.pdf>

Agilent N6700 Modular Power System Family: Mobile Communications DC Power Module

The Agilent N6783A-MFG mobile communications DC power module offers advanced features specifically for testing battery-powered (mobile) devices in manufacturing or automated test environments.

Go to: <http://cp.literature.agilent.com/litweb/pdf/5990-8643EN.pdf>

NOTE

You can contact Agilent Technologies at one of the following telephone numbers for warranty, service, or technical support information.

In the United States: (800) 829-4444

In Europe: 31 20 547 2111

In Japan: 0120-421-345

Or use our Web link for information on contacting Agilent in your country or specific location: www.agilent.com/find/assist

Or contact your Agilent Technologies Representative.

The web contains the most up to date version of this manual.

Go to <http://cp.literature.agilent.com/litweb/pdf/N6700-90001.pdf>.

Contents

1 - Power Module Differences.....	5
Power Module Differences—for Agilent N6700 Modular Power Systems.	6
Power Module Differences—for Agilent N6705 DC Power Analyzers	8
Power Module Option Characteristics	10
2 - Agilent N673xB, N674xB, N677xA DC Power Modules	11
Performance Specifications	12
Supplemental Characteristics	14
Output Quadrant Characteristic.....	16
Arbitrary Waveform Generator Maximum Bandwidth.....	16
3 - Agilent N675xA High Performance Power Modules	19
Performance Specifications	20
Supplemental Characteristics	21
Autoranging Characteristic.....	23
Output Impedance Graphs.....	23
Arbitrary Waveform Generator Maximum Bandwidth.....	26
4 - Agilent N676xA Precision Power Modules.....	27
Performance Specifications	28
Supplemental Characteristics	29
Autoranging Characteristic.....	31
Output Impedance Graphs.....	31
Arbitrary Waveform Generator Maximum Bandwidth.....	34
5 - Agilent N6781A, N6782A, N6784A Source/Measure Units.....	35
Performance Specifications	36
Supplemental Characteristics	37
Output Quadrant Characteristic.....	42
Output Impedance Graphs.....	42
6 - Agilent N6783A-BAT, N6783A-MFG Application-Specific Power Modules.....	43
Performance Specifications	44
Supplemental Characteristics	45
Output Quadrant Characteristic.....	46
7 - Agilent N6700 Modular Power System Mainframes.....	47
Supplemental Characteristics	48
Outline Diagrams.....	50



Chapter 1

Power Module Differences

Power Module Differences—for Agilent N6700 Modular Power Systems	6
Power Module Differences—for Agilent N6705 DC Power Analyzers	8
Power Module Option Characteristics	10

This chapter provides a brief overview of the basic differences between the Agilent N6700 series DC Power Modules. Note that the basic capabilities of a power module depend not only on its hardware capabilities, but also the on the hardware and firmware capabilities of the mainframe in which it is installed.

In addition to their primary output and measurement capabilities, power modules installed in an Agilent N6705 DC Power Analyzer have expanded capabilities such as front panel scope view, arbitrary waveform generation, and internal and external data logging.

Refer to the Agilent N6700 or N6705 User’s Guide for more information about the power module capabilities.

Power Module Differences—for Agilent N6700 Modular Power Systems

Agilent N6731B–N6777A Differences

Feature (● = available)	DC Power N673xB, N674xB, N677xA	High-Performance N675xA	Precision N676xA
50 W output rating	N6731B – N6736B	N6751A	N6761A
100 W output rating	N6741B – N6746B	N6752A	N6762A
300 W output rating	N6773A – N6777A	N6753A, N6754A	N6763A, N6764A
500 W output rating		N6755A, N6756A	N6765A, N6766A
Output disconnect relays	Option 761	Option 761	Option 761
Output disconnect/polarity reversal relays ^{NOTE 1}	Option 760	Option 760	Option 760
Autoranging output capability		●	●
Voltage or current turn-on priority			N6761A, N6762A
Precision voltage and current measurements			●
Low voltage and current output ranges			N6761A, N6762A
Low voltage and current measurement ranges			●
200 microampere measurement range ^{NOTE 2}			Option 2UA
Simultaneous voltage and current measurements			●
SCPI command output list capability ^{NOTE 3}	Option 054	Option 054	●
SCPI command array readback ^{NOTE 3}	Option 054	Option 054	●
SCPI command programmable sample rate ^{NOTE 3}	Option 054	Option 054	●
SCPI command external data logging ^{NOTE 3}	Option 054	Option 054	●
Double-wide (occupies 2 channel locations)		N6753A – N6756A	N6763A – N6766A

¹ Option 760 limits the output current to 10A maximum on Models N6742B and N6773A.

Option 760 is not available on Models N6741B, N6751A, N6752A, N6761A, and N6762A.

² Option 2UA is only available on Models N6761A and N6762A. It includes Option 761.

³ Only available when using the remote interfaces; not from the front panel.

Agilent N6781A–N6784A Differences

Feature (● = available)	Source/Measure Units (SMU)			Application-Specific	
	N6781A	N6782A	N6784A	N6783A-BAT	N6783A-MFG
Output rating	20 W	20 W	20 W	24 W	18 W
2-quadrant operation	●	●		●	●
4-quadrant operation			●		
Auxiliary voltage measurement input	●				
Output disconnect relays	●	●	●	Option 761	Option 761
Negative voltage protection	●	●	●	●	●
Voltage or current priority mode	●	●	●		
Programmable output resistance	●				
600 mV output range	●	●	●		
300 mA output range	●	●			
100 mA, 10 mA output ranges			●		
1 V, 100 mV measurement ranges	●	●	●		
100 mA, 1 mA, 10 μA measurement ranges	●	●	●		
150 mA measurement range				●	●
Simultaneous voltage and current measurements	●	●	●		
Seamless measurement autoranging	●	●			
SCPI command output list capability ^{NOTE 1, 2}	●	●	●	●	●
SCPI command array readback ^{NOTE 2}	●	●	●	●	●
SCPI command programmable sample rate ^{NOTE 2}	●	●	●	●	●
SCPI command external data logging ^{NOTE 2}	●	●	●	●	●

¹ List capability is not available on the negative current output on Model N6783A.

² Only available when using the remote interfaces; not the front panel.

Power Module Differences—for Agilent N6705 DC Power Analyzers

Agilent N6731B–N6777A Differences

Feature (● = available)	DC Power N673xB, N674xB, N677xA	High-Performance N675xA	Precision N676xA
50 W output rating	N6731B – N6736B	N6751A	N6761A
100 W output rating	N6741B – N6746B	N6752A	N6762A
300 W output rating	N6773A – N6777A	N6753A, N6754A	N6763A, N6764A
500 W output rating		N6755A, N6756A	N6765A, N6766A
Output disconnect relays	Option 761	Option 761	Option 761
Output disconnect/polarity reversal relays ^{NOTE 1}	Option 760	Option 760	Option 760
Arbitrary waveform generation	●	●	●
Autoranging output capability		●	●
Voltage or current turn-on priority			N6761A, N6762A
Precision voltage and current measurements			●
Low voltage and current output ranges			N6761A, N6762A
Low voltage and current measurement ranges			●
200 microampere measurement range ^{NOTE 2}			Option 2UA
Voltage or current scope traces	●	●	●
Simultaneous voltage and current scope traces			●
Simultaneous voltage and current data logging ^{NOTE 3}			●
Interleaved voltage and current data logging ^{NOTE 3}	●	●	
Dynamic current correction	●	N6751A, N6752A	N6761A, N6762A
SCPI command output list capability ^{NOTE 4}	●	●	●
SCPI command array readback ^{NOTE 4}	●	●	●
SCPI command programmable sample rate ^{NOTE 4}	●	●	●
SCPI command external data logging ^{NOTE 4}	●	●	●
Double-wide (occupies 2 channel locations)		N6753A – N6756A	N6763A – N6766A

¹ Option 760 limits the output current to 10A maximum on Models N6742B and N6773A.

Option 760 is not available on Models N6741B, N6751A, N6752A, N6761A, and N6762A.

² Option 2UA is only available on Models N6761A and N6762A. It includes Option 761.

³ Option 055 deletes the Data Logger function on Model N6705.

⁴ Only available when using the remote interfaces; not from the front panel.

Agilent N6781A–N6784A Differences

Feature (● = available)	Source/Measure Units (SMU)			Application-Specific	
	N6781A	N6782A	N6784A	N6783A-BAT	N6783A-MFG
Output rating	20 W	20 W	20 W	24 W	18 W
2-quadrant operation	●	●		●	●
4-quadrant operation			●		
Auxiliary voltage measurement input	●				
Output disconnect relays	●	●	●	Option 761	Option 761
Arbitrary waveform generation ^{NOTE 1}	●	●	●	●	●
Negative voltage protection	●	●	●	●	●
Voltage or current priority mode	●	●	●		
CC load/CV load	●	●	●		
Voltage/current measurement only	●	●	●		
Battery emulator/charger	●				
Programmable output resistance	●				
600 mV output range	●	●	●		
300 mA output range	●	●			
100 mA, 10 mA output ranges			●		
1 V, 100 mV measurement ranges	●	●	●		
100 mA, 1 mA, 10 μA measurement ranges	●	●	●		
150 mA measurement range				●	●
Voltage or current scope traces	●	●	●	●	●
Simultaneous voltage and current scope traces	●	●	●		
Simultaneous voltage and current data logging ^{NOTE 2}	●	●	●		
Interleaved voltage and current data logging ^{NOTE 2}				●	●
Seamless measurement autoranging	●	●			
SCPI command output list capability ^{NOTE 1, 3}	●	●	●	●	●
SCPI command array readback ^{NOTE 3}	●	●	●	●	●
SCPI command programmable sample rate ^{NOTE 3}	●	●	●	●	●
SCPI command external data logging ^{NOTE 3}	●	●	●	●	●
SCPI command histogram measurements ^{NOTE 3}	●	●			

¹ Arbitrary waveform generation and list capability are not available on the negative current output on Model N6783A.

² Option 055 deletes the Data Logger function on Model N6705.

³ Only available when using the remote interfaces; not the front panel.

Power Module Option Characteristics

Option 760 & 761

Option 761 provides output and sense disconnect relays. Option 760 provides polarity reversal in addition to output and sense disconnect. Note that models N678xA SMU have output and sense disconnect relays built in.

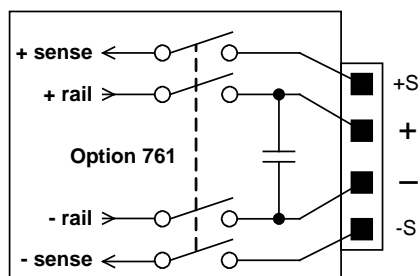

- Option 760 limits the output current to 10 A on Models N6742B and N6773A.

- Option 760 is not available on Models N6741B, N6751A, N6752A, N6761A, N6762A, and N6781A – N6784A

Although the plus and minus rail of the output power mesh are physically disconnected from the output terminals with options 760 and 761, a small AC network is still connected across the plus and minus output terminals (see figure).

Option 054

Option 054 (High-speed Test Extensions) include output list and digitized measurement capability. This option is separately orderable for Models N673xB, N674xB, N677xA, and N675xA when installed in an N6700 MPS mainframes. All other power modules as well as the N6705 DC Power Analyzer mainframes have output list and digitized measurement capability built in.

Output list:

- Maximum number of steps = 512
- Maximum dwell time in seconds = 262
- Maximum list repetitions = 256 or infinite

Digitized measurement:

- Maximum measurement points = 524,288
- Maximum sample rate = 97.656 kHz

Option 2UA

Option 2UA is a 200 microampere measurement range available on Models N6761A and N6762A only. It includes Option 761 relay capability.



Chapter 2

Agilent N673xB, N674xB, N677xA DC Power Modules

Performance Specifications	12
Supplemental Characteristics	14
Output Quadrant Characteristic	16
Arbitrary Waveform Generator Maximum Bandwidth	16

Unless otherwise noted, specifications are warranted over the ambient temperature range of 0 to 40°C after a 30-minute warm-up period. Specifications apply at the output terminals, with each module's sense terminals internally connected to its output terminals (local sensing).

Refer to the Agilent N6700 or N6705 Service Guide for the setup conditions for all performance specifications.

Supplemental characteristics are not warranted but are descriptions of performance determined either by design or by type testing. All supplemental characteristics are typical unless otherwise noted.

Performance Specifications

	N6731B/ N6741B	N6732B/ N6742B	N6733B/ N6743B	N6734B/ N6744B	N6735B/ N6745B	N6736B/ N6746B
DC Output Ratings:						
Voltage	0 - 5 V	0 - 8 V	0 - 20 V	0 - 35 V	0 - 60 V	0 - 100 V
Current ^{NOTE 1}	0-10 A / 0-20 A	0-6.25 A / 0-12.5 A	0-2.5 A / 0-5 A	0-1.5 A / 0-3 A	0-0.8 A / 0-1.6 A	0-0.5 A / 0-1 A
Power	50 W / 100 W	50 W / 100 W	50 W / 100 W	52.5W / 105W	50 W / 100 W	50 W / 100 W
Output Ripple and Noise (PARD): (from 20 Hz – 20 MHz)						
CV peak-to- peak	10 mV / 20 mV	12 mV	14 mV	15 mV	25 mV	30 mV
CV rms	2 mV	2 mV	3 mV	5 mV	9 mV	18 mV
Load Effect (Regulation): (Applies for any output load change, with a maximum load-lead drop of 1V/lead. The load lead drop reduces the maximum available voltage at the load.)						
Voltage	5 mV	6 mV	9 mV	11 mV	13 mV / 16 mV	20 mV / 30 mV
Current	2 mA	2 mA	2 mA	2 mA	2 mA	2 mA
Source Effect (Regulation):						
Voltage	1 mV	2 mV	2 mV	4 mV	6 mV	10 mV
Current	1 mA	1 mA	1 mA	1 mA	1 mA	1 mA
Programming Accuracy: (@ 23 °C ±5 °C after a 30 minute warm-up. Applies from minimum to maximum programming range at any load.)						
Voltage	0.1% + 19 mV	0.1% + 19 mV	0.1% + 20 mV	0.1% + 35 mV	0.1% + 60 mV	0.1% + 100 mV
Current	0.15% + 20 mA	0.15% + 20 mA	0.15% + 20 mA	0.15% + 20 mA	0.15% + 20 mA	0.15% + 10mA
Voltmeter/Ammeter Measurement Accuracy: (@ 23 °C ±5 °C. Applies when measuring the default value of 1024 data points with a 20.48 μs time interval.)						
Voltage	0.1% + 20 mV	0.1% + 20 mV	0.1% + 20 mV	0.1% + 35 mV	0.1% + 60 mV	0.1% + 100 mV
Current	0.15% + 20 mA	0.15% + 10 mA	0.15% + 5 mA	0.15% + 4 mA	0.15% + 4 mA	0.15% + 2 mA
Load Transient Recovery Time: (Time to recover to within the settling band following a load change from 50% to 100% and from 100% to 50% of full load.)						
Voltage settling band	^{NOTE 3} ±0.08 V / 0.1 V	^{NOTE 3} ±0.08 V / 0.1 V	± 0.2 V / 0.3 V	± 0.2 V / 0.3 V	± 0.4 V / 0.5 V	± 0.5 V / 1.0 V
Time	< 200 μs	< 200 μs	< 200 μs	< 200 μs	< 200 μs	< 200 μs

Performance Specifications (continued)

	N6773A	N6774A	N6775A	N6776A	N6777A
DC Output Ratings:					
Voltage	0 - 20 V	0 - 35 V	0 - 60 V	0 - 100 V	0 - 150 V
Current ^{NOTE 1}	0 - 15 A ^{NOTE 2}	0 - 8.5 A	0 - 5 A	0 - 3 A	0 - 2 A
Power	300 W	300 W	300 W	300 W	300 W
Output Ripple and Noise (PARD): (from 20 Hz – 20 MHz)					
CV peak-to- peak	20 mV	22 mV	35 mV	45 mV	68 mV
CV rms	3 mV	5 mV	9 mV	18 mV	27 mV
Load Effect (Regulation): (Applies for any output load change, with a maximum load-lead drop of 1V/lead. The load lead drop reduces the maximum available voltage at the load.)					
Voltage	13 mV	16 mV	24 mV	45 mV	68 mV
Current	6 mA	6 mA	6 mA	6 mA	6 mA
Source Effect (Regulation):					
Voltage	2 mV	4 mV	6 mV	10 mV	15 mV
Current	1 mA	1 mA	1 mA	1 mA	1 mA
Programming Accuracy: (@ 23 °C ±5 °C after 30 minute warm-up. Applies from minimum to maximum programming range at any load.)					
Voltage	0.1% + 20 mV	0.1% + 35 mV	0.1% + 60 mV	0.1% + 100 mV	0.1% + 150 mV
Current	0.15% + 60 mA	0.15% + 60 mA	0.15% + 60 mA	0.15% + 30 mA	0.15% + 30 mA
Voltmeter/Ammeter Measurement Accuracy: (@ 23 °C ±5 °C. Applies when measuring the default value of 1024 data points with a 20.48 μs time interval.)					
Voltage	0.1% + 20 mV	0.1% + 35 mV	0.1% + 60 mV	0.1% + 100 mV	0.1% + 150 mV
Current	0.15% + 15 mA	0.15% + 12 mA	0.15% + 12 mA	0.15% + 6 mA	0.15% + 6 mA
Load Transient Recovery Time: (Time to recover to within the settling band following a load change from 50% to 100% and from 100% to 50% of full load.)					
Voltage settling band	± 0.3 V ^{NOTE 4}	± 0.3 V ^{NOTE 4}	± 0.5 V	± 1.0 V	± 2.0 V
Time	< 250 μs	< 250 μs	< 250 μs	< 250 μs	< 250 μs

¹ Output current is derated 1% per °C above 40°C.

² When relay option 760 is installed on Models N6742B and N6773A, the output current is limited to 10 A.

³ When relay option 760 or 761 is installed, the settling band is ±0.10V/0.125 V.
Option 760 is not available on Model N6741B.

⁴ When relay option 760 or 761 is installed, the settling band is ±0.35 V.

Supplemental Characteristics

	N6731B/ N6741B	N6732B/ N6742B	N6733B/ N6743B	N6734B/ N6744B	N6735B/ N6745B	N6736B/ N6746B
Programming Ranges:						
Voltage	15 mV – 5.1 V	15 mV – 8.16 V	30 mV – 20.4 V	40 mV – 35.7 V	70 mV – 61.2 V	100 mV – 102 V
Current	60 mA – 10.2 A/ 60 mA – 20.4 A	40 mA – 6.375 A/ 40 mA – 12.75 A	10 mA – 2.55 A/ 10 mA – 5.1 A	5 mA – 1.53 A/ 5 mA – 3.06 A	2.5 mA – 0.85 A/ 2.5 mA – 1.7 A	1.5 mA – 0.51 A/ 1.5 mA – 1.02 A
Programming Resolution:						
Voltage	3.5 mV	4 mV	7 mV	10 mV	18 mV	28 mV
Current	7 mA	4 mA	3 mA	2 mA	1 mA	0.5 mA
Measurement Resolution:						
Voltage	3 mV	4 mV	10 mV	18 mV	30 mV	50 mV
Current	10 mA	7 mA	3 mA	2 mA	1 mA	0.5 mA
Programming Temperature Coefficient per °C:						
Voltage	0.005% + 0.1 mV	0.005% + 0.1 mV	0.005% + 0.2 mV	0.005% + 0.5 mV	0.005% + 0.5 mV	0.005% + 1 mV
Current	0.005% + 1 mA	0.005% + 0.5 mA	0.005% + 0.1 mA	0.005% + 0.05 mA	0.005% + 0.02 mA	0.005% + 0.02 mA
Measurement Temperature Coefficient per °C:						
Voltage	0.01% + 0.1 mV	0.01% + 0.1 mV	0.01% + 0.2 mV	0.01% + 0.2 mV	0.01% + 0.5 mV	0.01% + 0.5 mV
Current	0.01% + 1 mA	0.01% + 0.5 mA	0.01% + 0.1 mA	0.01% + 0.05 mA	0.01% + 0.02 mA	0.01% + 0.02 mA
N6705 Mainframe Oscilloscope Measurement Accuracy: (@t 23 °C ±5 °C; accuracy of any individual point in the trace)						
Voltage	0.1% + 25 mV	0.1% + 30 mV	0.1% + 45 mV	0.1% + 75 mV	0.1% + 130 mV	0.1% + 190 mV
Current—Correction On ^{NOTE 1}	0.15% + 50 mA	0.15% + 30 mA	0.15% + 15 mA	0.15% + 10 mA	0.15% + 9 mA	0.15% + 5 mA
Current	0.15% + 70 mA	0.15% + 40 mA	0.15% + 20 mA	0.15% + 14 mA	0.15% + 12 mA	0.15% + 7 mA
Up-programming and Down-programming Time with full resistive load:						
(Time from 10% to 90% of total voltage excursion; for voltage setting from 0V to full scale and full scale to 0V)						
	20 ms	20 ms	20 ms	20 ms	20 ms	20 ms
Up-programming and Down-programming Settling Time with full resistive load:						
(Time from start of voltage change to 0.1% of full-scale value; for voltage setting from 0V to full scale and full scale to 0V)						
	100 ms	100 ms	100 ms	100 ms	100 ms	100 ms
Over-voltage Protection:						
Accuracy	0.25% + 50 mV	0.25% + 50 mV	0.25% + 75 mV	0.25% + 100 mV	0.25% + 200 mV	0.25% + 250 mV
Accuracy with Opt. 760	0.25%+600mV	0.25% + 600 mV	0.25% + 350 mV	0.25% + 250 mV	0.25% + 300 mV	0.25% + 300 mV
Accuracy with Opt. 761	0.25%+600mV	0.25% + 600 mV	0.25% + 350 mV	0.25% + 250 mV	0.25% + 300 mV	0.25% + 300 mV
Maximum setting	7.5 V	10 V	22 V	38.5 V	66 V	110 V
Response time	50 μs from occurrence of over-voltage condition to start of output shutdown					
Output Ripple and Noise (PARD):						
CC rms	8 mA	4 mA	2 mA	2 mA	2 mA	2 mA
Common Mode Noise: (from 20 Hz – 20 MHz; from either output to chassis)						
Rms	1 mA	1 mA	1 mA	1 mA	1 mA	1 mA
Peak-to- peak	< 15 mA	< 10 mA	< 10 mA	< 10 mA	< 10 mA	< 10 mA
Remote Sense Capability:	Outputs can maintain specifications with up to a 1-volt drop per load lead. The load lead drop reduces the maximum available voltage at the load.					
Series and Parallel Operation:	Identically rated outputs can be operated directly in parallel or can be connected for straight series operation. Auto-series and auto-parallel operation is not available.					
Minimum Output Turn-On Delay: (Time from when any Output On command is received until the output starts turning on)						
Without relay option	32 ms	32 ms	32 ms	32 ms	32 ms	32 ms
With relay Option 760	58 ms	58 ms	58 ms	58 ms	58 ms	58 ms

Supplemental Characteristics (continued)

	N6773A	N6774A	N6775A	N6776A	N6777A
Programming Ranges:					
Voltage	30 mV – 20.4 V	40 mV – 35.7 V	70 mV – 61.2 V	100 mV – 102 V	145 mV – 153 V
Current	30 mA – 15.3 A	15 mA – 8.67 A	7.5 mA – 5.1 A	4.5 mA – 3.06 A	2.75 mA – 2.04 A
Programming Resolution:					
Voltage	7 mV	10 mV	18 mV	28 mV	43 mV
Current	9 mA	6 mA	3 mA	1.5 mA	1 mA
Measurement Resolution:					
Voltage	10 mV	18 mV	30 mV	50 mV	77 mV
Current	9 mA	6 mA	3 mA	1.5 mA	1 mA
Programming Temperature Coefficient per °C:					
Voltage	0.01% + 0.2 mV	0.01% + 0.5 mV	0.01% + 0.5 mV	0.01% + 1 mV	0.01% + 1 mV
Current	0.01% + 0.5 mA	0.01% + 0.5 mA	0.01% + 0.1 mA	0.01% + 0.1 mA	0.01% + 0.1 mA
Measurement Temperature Coefficient per °C:					
Voltage	0.01% + 0.2 mV	0.01% + 0.2 mV	0.01% + 0.5 mV	0.01% + 0.5 mV	0.01% + 0.5 mV
Current	0.01% + 0.5 mA	0.01% + 0.5 mA	0.01% + 0.05 mA	0.01% + 0.05 mA	0.01% + 0.05 mA
N6705 Mainframe Oscilloscope Measurement Accuracy: (@ 23 °C ±5 °C; accuracy of any individual point in the trace)					
Voltage	0.1% + 45 mV	0.1% + 75 mV	0.1% + 120 mV	0.1% + 160 mV	0.1% + 175 mV
Current – Correction On ^{NOTE 1}	0.15% + 35 mA	0.15% + 22 mA	0.15% + 19 mA	0.15% + 9 mA	0.15% + 9 mA
Current	0.15% + 45 mA	0.15% + 27 mA	0.15% + 22 mA	0.15% + 12 mA	0.15% + 12 mA
Up-programming and Down-programming Time with full resistive load: (Time from 10% to 90% of total voltage excursion; for voltage setting from 0V to full scale and full scale to 0V)					
	20 ms	20 ms	20 ms	20 ms	20 ms
Maximum Up-programming and Down-programming Settling Time with full resistive load: (Time from start of voltage change to 0.1% of full-scale value; for voltage setting from 0V to full scale and full scale to 0V)					
	100 ms	100 ms	100 ms	100 ms	100 ms
Over-voltage Protection:					
Accuracy	0.25% + 100 mV	0.25% + 130 mV	0.25% + 260 mV	0.25% + 650 mV	0.25% + 650 mV
Accuracy with Opt. 761	0.25% + 500 mV	0.25% + 350 mV	0.25% + 350 mV	0.25% + 650 mV	0.25% + 650 mV
Accuracy with Opt. 760	0.25% + 700 mV	0.25% + 700 mV	0.25% + 400 mV	0.25% + 650 mV	0.25% + 650 mV
Maximum setting	22 V	38.5 V	66 V	110 V	165 V
Response time	50 μs from occurrence of over-voltage condition to start of output shutdown				
Output Ripple and Noise (PARD):					
CC rms	6 mA	6 mA	6 mA	6 mA	6 mA
Common Mode Noise: (from 20 Hz – 20 MHz; from either output to chassis)					
Rms	2 mA	2 mA	2 mA	2 mA	2 mA
Peak-to-peak	< 20 mA	< 20 mA	< 20 mA	< 20 mA	< 20 mA
Remote Sense Capability: Outputs can maintain specifications with up to a 1-volt drop per load lead. The load lead drop reduces the maximum available voltage at the load.					
Series and Parallel Operation: Identically rated outputs can be operated directly in parallel or can be connected for straight series operation. Auto-series and auto-parallel operation is not available.					
Minimum Output Turn-On Delay: (Time from when any Output On command is received until the output starts turning on)					
Without relay option	32 ms	32 ms	32 ms	32 ms	32 ms
With relay Option 760	58 ms	58 ms	58 ms	58 ms	58 ms

¹ Correction On compensates for current flowing into the output capacitor during voltage transients.

Output Quadrant Characteristic

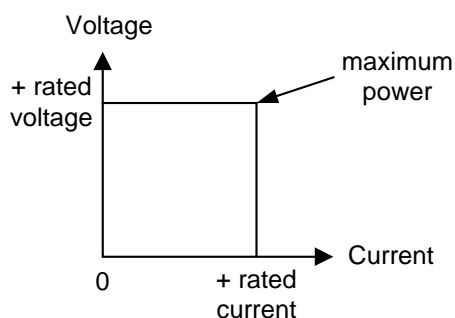

Arbitrary Waveform Generator Maximum Bandwidth

NOTE

The information in this section only applies when the power modules are installed in an Agilent N6705 DC Power Analyzer.

The following tables characterize the maximum bandwidth of the arbitrary waveform generator. The maximum bandwidth is based on a sine wave into a resistive load and applies to any output current.

The following definitions apply in the frequency tables:

- V p-p = Voltage peak-to-peak
- 3 dB max. = Max. frequency where the voltage drops to 3 dB below its setting
- 6 dB max. = Max. frequency where the voltage drops to 6 dB below its setting
- THD 3 dB = The total harmonic distortion at 3 dB max. frequency
- THD 6 dB = The total harmonic distortion at 6 dB max. frequency

Voltage	3 dB max	THD 3 dB	6 dB max	THD 6 dB
N6731B & N6741B				
0.1 Vp-p	175 Hz	1.0%	260 Hz	3.0%
0.1 Vp-p	125 Hz	1.0%	175 Hz	3.0%
0.3 Vp-p	75 Hz	6.0%	100 Hz	6.0%
0.5 Vp-p	40 Hz	9.0%	55 Hz	9.0%
5.0 Vp-p	20 Hz	10%	37 Hz	10%
N6732B & N6742B				
0.1 Vp-p	125 Hz	1.0%	200 Hz	3.0%
0.2 Vp-p	125 Hz	1.0%	180 Hz	3.0%
0.4 Vp-p	75 Hz	6.0%	100 Hz	6.0%
0.8 Vp-p	40 Hz	8.5%	60 Hz	8.5%
8.0 Vp-p	20 Hz	10%	37 Hz	10%

Arbitrary Waveform Generator Maximum Bandwidth (continued)

Voltage	3 dB max	THD 3 dB	6 dB max	THD 6 dB	3 dB max	THD 3 dB	6 dB max	THD 6 dB
	N6733B & N6743B				N6773A			
0.2 Vp-p	110 Hz	1.0%	190 Hz	3.0%	125 Hz	1.5%	210 Hz	4.0%
0.4 Vp-p	110 Hz	1.0%	160 Hz	3.0%	125 Hz	1.5%	180 Hz	4.0%
1.0 Vp-p	72 Hz	6.0%	95 Hz	6.0%	75 Hz	6.0%	95 Hz	6.0%
2.0 Vp-p	40 Hz	8.0%	55 Hz	8.5%	42 Hz	9.0%	60 Hz	9.0%
20 Vp-p	20 Hz	10%	37 Hz	10%	20 Hz	10%	37 Hz	10%
	N6734B & N6744B				N6774A			
0.4 Vp-p	125 Hz	1.0%	200 Hz	1.0%	125 Hz	1.0%	200 Hz	1.0%
0.7 Vp-p	125 Hz	1.0%	175 Hz	3.5%	125 Hz	1.0%	160 Hz	3.0%
1.8 Vp-p	72 Hz	6.0%	100 Hz	6.0%	75 Hz	6.0%	95 Hz	6.0%
3.5 Vp-p	40 Hz	8.0%	55 Hz	8.5%	40 Hz	8.5%	55 Hz	8.5%
35 Vp-p	20 Hz	8.0%	37 Hz	8.5%	20 Hz	10%	37 Hz	10%
	N6735B & N6745B				N6775A			
0.6 Vp-p	100 Hz	1.0%	180 Hz	1.0%	120 Hz	1.0%	200 Hz	1.0%
1.2 Vp-p	100 Hz	1.0%	160 Hz	3.0%	120 Hz	1.0%	160 Hz	3.0%
3.0 Vp-p	70 Hz	5.5%	92 Hz	5.5%	70 Hz	5.0%	95 Hz	6.0%
6.0 Vp-p	40 Hz	8.0%	55 Hz	8.0%	40 Hz	8.5%	55 Hz	8.5%
60 Vp-p	20 Hz	8.0%	37 Hz	8.0%	20 Hz	10%	35 Hz	10%
	N6736B & N6746B				N6776A			
1.0 Vp-p	90 Hz	1.0%	160 Hz	1.5%	75 Hz	1.0%	160 Hz	1.0%
2.0 Vp-p	90 Hz	1.0%	150 Hz	3.0%	75 Hz	1.0%	150 Hz	3.0%
5.0 Vp-p	62 Hz	4.5%	85 Hz	6.0%	55 Hz	4.0%	75 Hz	6.0%
10 Vp-p	37 Hz	8.0%	50 Hz	8.0%	35 Hz	8.0%	45 Hz	8.0%
100 Vp-p	20 Hz	8.0%	35 Hz	8.0%	N/A	N/A	35 Hz	8.0%
					N6777A			
1.5 Vp-p					70 Hz	1.0%	150 Hz	1.0%
3.0 Vp-p					55 Hz	5.0%	120 Hz	2.0%
7.5 Vp-p					55 Hz	5.0%	70 Hz	6.0%
15 Vp-p					35 Hz	7.0%	55 Hz	7.0%
150 Vp-p					N/A	N/A	30 Hz	1.0%

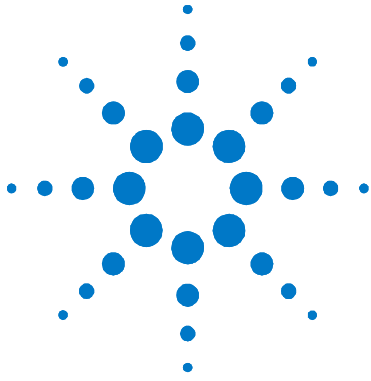

Chapter 3

Agilent N675xA High Performance Power Modules

Performance Specifications	20
Supplemental Characteristics	21
Autoranging Characteristic	23
Output Impedance Graphs	23
Arbitrary Waveform Generator Maximum Bandwidth	26

Unless otherwise noted, specifications are warranted over the ambient temperature range of 0 to 40°C after a 30-minute warm-up period. Specifications apply at the output terminals, with each module's sense terminals internally connected to its output terminals (local sensing).

Refer to the Agilent N6700 or N6705 Service Guide for the setup conditions for all performance specifications.

Supplemental characteristics are not warranted but are descriptions of performance determined either by design or by type testing. All supplemental characteristics are typical unless otherwise noted.

Performance Specifications

	N6751A/N6752A	N6753A/N6755A	N6754A/N6756A
DC Output Ratings:			
Voltage	0 - 50 V	0 - 20 V	0 - 60 V
Current ^{NOTE 1}	0 - 5 A / 0 - 10 A	0 - 50 A	0 - 20 A / 0 - 17A
Power	50 W / 100 W	300 W / 500 W	300 W / 500 W
Output Ripple and Noise (PARD): (from 20 Hz – 20 MHz)			
CV peak-to-peak	4.5 mV	5 mV	6 mV
CV rms	0.35 mV	1 mV	1 mV
Load Effect (Regulation): (Applies for any output load change, with a maximum load-lead drop of 1V/lead. The load lead drop reduces the maximum available voltage at the load.)			
Voltage	2 mV	2 mV	2 mV
Current	2 mA	12 mA	5 mA
Source Effect (Regulation):			
Voltage	1 mV	0.5 mV	1.2 mV
Current	1 mA	5 mA	2 mA
Programming Accuracy: (@ 23 °C ±5 °C after 30 minute warm-up. Applies from minimum to maximum programming range at any load.)			
Voltage	0.06% + 19 mV	0.06% + 10 mV	0.06% + 25 mV
Current	0.1% + 20 mA	0.1% + 30 mA	0.1% + 12 mA
Voltmeter/Ammeter Measurement Accuracy: (@ 23 °C ±5 °C. Applies when measuring the default value of 1024 data points with a 20.48 μs time interval.)			
Voltage	0.05% + 20 mV	0.05% + 10 mV	0.05% + 25 mV
Current	0.1% + 4 mA	0.1% + 30 mA	0.1% + 8 mA
Load Transient Recovery Time: (Time to recover to within the settling band following a load change - from 60% to 100% and from 100% to 60% of full load for model N6751A - from 50% to 100% and from 100% to 50% of full load for models N6752A through N6756A.)			
Voltage settling band	± 75 mV ^{NOTE 2}	± 30 mV ^{NOTE 3}	± 90 mV ^{NOTE 4}
Time	< 100 μs	< 100 μs	< 100 μs

¹ Output current is derated 1% per °C above 40°C.

² When relay option 761 is installed on Model N6752A, the settling band is ±125 mV.

³ When relay option 760 or 761 is installed on Model N6753A and N6755A, the settling band is ±200 mV.

⁴ When relay option 760 or 761 is installed on Model N6754A and N6756A, the settling band is ±350 mV.

Supplemental Characteristics

	N6751A / N6752A	N6753A / N6755A	N6754A / N6756A
Programming Ranges:			
Voltage	20 mV – 51 V	10 mV – 20.4 V	25 mV- 61.2 V
Current	10 mA – 5.1A/10 mA – 10.2A	50 mA – 51 A	20 mA – 20.4 A/20 mA – 17.3A
Programming Resolution:			
Voltage	3.5 mV	1.5 mV	4.2 mV
Current	3.25 mA	16.3 mA	6.5 mA
Measurement Resolution:			
Voltage	1.8 mV	0.8 mV	2.2 mV
Current	410 μ A	2.05 mA	0.82 mA
Programming Temperature Coefficient per °C:			
Voltage	18 ppm + 160 μ V	35 ppm + 100 μ V	35 ppm + 170 μ V
Current	100 ppm + 45 μ A	60 ppm + 500 μ A	60 ppm + 200 μ A
Measurement Temperature Coefficient per °C:			
Voltage	25 ppm + 35 μ V	50 ppm + 85 μ V	50 ppm + 100 μ V
Current	60 ppm + 3 μ A	60 ppm + 30 μ A	60 ppm + 12 μ A
N6705 Mainframe Oscilloscope Measurement Accuracy: (@ 23 °C \pm5 °C, accuracy of any individual point in the trace)			
Voltage	0.05% + 32 mV	0.05% + 15 mV	0.05% + 37 mV
Current– with Correction On ^{NOTE 1}	0.1% + 14 mA	N/A	N/A
Current	0.1% + 8 mA	0.1% + 52 mA	0.1% + 17 mA
Up-programming Time with full resistive load: (Time from 10% to 90% of total voltage excursion)			
Small voltage step	0 V to 10 V	0 V to 6 V/0 V to 10 V	0 V to 15 V/0 V to 29 V
Time	0.2 ms	0.4 ms/0.5 ms	0.35 ms/0.7 ms
Large voltage step	0 V to 50 V	0 V to 20 V	0 V to 60 V
Time	1.5 ms	1.5 ms	2 ms
Up-programming Settling Time with full resistive load: (Time from start of voltage change to 0.1% of full scale value)			
Small voltage step	0 V to 10 V	0 V to 6 V/0 V to 10 V	0 V to 15 V/0 V to 29 V
Time	0.5 ms	0.8 ms/1.0 ms	0.8 ms/1.4 ms
Large voltage step	0 V to 50 V	0 V to 20 V	0 V to 60 V
Time	4 ms	3 ms	4.2 ms
Down-programming Time with no load: (Time from start of voltage change to output voltage < 0.5 V)			
Small voltage step	10 V to 0 V	6 V to 0 V/10 V to 0 V	15 V to 0 V/29 V to 0 V
Time	0.3 ms	0.55 ms/1.0 ms	0.6 ms/1.2 ms
Large voltage step	50 V to 0 V	20 V to 0 V	60 V to 0 V
Time	1.3 ms	1.8 ms	2.2 ms
Down-programming Settling Time with no load: (Time from start of voltage change to 0.1% of full scale value)			
Small voltage step	10 V to 0 V	6 V to 0 V/10 V to 0 V	15 V to 0 V/29 V to 0 V
Time	0.45 ms	0.8 ms/1.3 ms	0.8 ms/1.5 ms
Large voltage step	50 V to 0 V	20 V to 0 V	60 V to 0 V
Time	1.4 ms	2 ms	2.3 ms

Supplemental Characteristics (continued)

	N6751A / N6752A	N6753A / N6755A	N6754A / N6756A
Down-programming Time with Capacitive load: (Time from start of voltage change to output voltage < 0.5 V)			
Small voltage step	10 V to 0 V	6 V to 0 V/10 V to 0 V	15 V to 0 V/29 V to 0 V
Time	2.1 ms	2.2 ms/4.5 ms	2.3 ms/5.5 ms
Large voltage step	50 V to 0 V	20 V to 0 V	60 V to 0 V
Time	11 ms	8.5 ms	10 ms
Capacitive load ^{NOTE 2}	1000 μ F	4700 μ F	680 μ F
Down-programming Capability:			
Continuous power	7 W	12.5 W	12.5 W
Peak current	7 A	15 A	6 A
Over-voltage Protection:			
Accuracy	0.25% + 0.25 V	0.25% + 0.15V	0.25% + 0.3V
Accuracy with Option 761	0.25% + 0.25 V	0.25% + 0.45V	0.25% + 0.6V
Accuracy with Option 760	N/A	0.25% + 0.45V	0.25% + 0.6V
Maximum setting	55 V	22 V	66 V
Response time	50 μ s from occurrence of over-voltage condition to start of output shutdown		
Output Ripple and Noise: (PARD)			
CC rms:	2 mA	10 mA	4 mA
Common Mode Noise: (from 20 Hz – 20 MHz; from either output to chassis)			
rms	500 μ A	500 μ A	750 μ A
peak-to-peak	< 2 mA	< 2 mA	< 3 mA
Remote Sense Capability: Outputs can maintain specifications with up to a 1-volt drop per load lead. The load lead drop reduces the maximum available voltage at the load.			
Series and Parallel Operation: Identically rated outputs can be operated directly in parallel or be connected for straight series operation. Auto-series and auto-parallel operation is not available.			
Minimum Output Turn-On Delay: (Time from when any Output On command is received until the output starts turning on)			
Without relay option	25 ms	18 ms	18 ms
With relay Option 760	51 ms	44 ms	44 ms

¹ Correction On compensates for current flowing into the output capacitor during voltage transients.

² Modules can discharge the specified capacitive load from full scale to 0V at a rate of 4 times/second.

Autoranging Characteristic

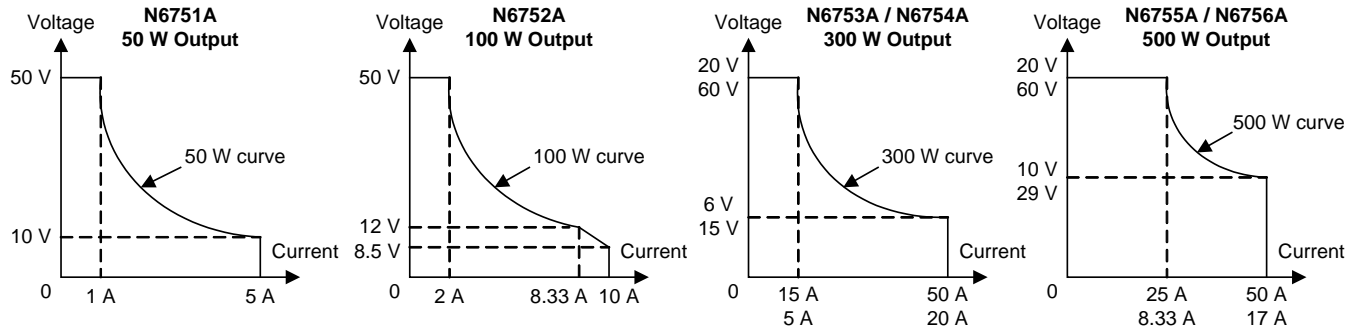

Output Impedance Graphs

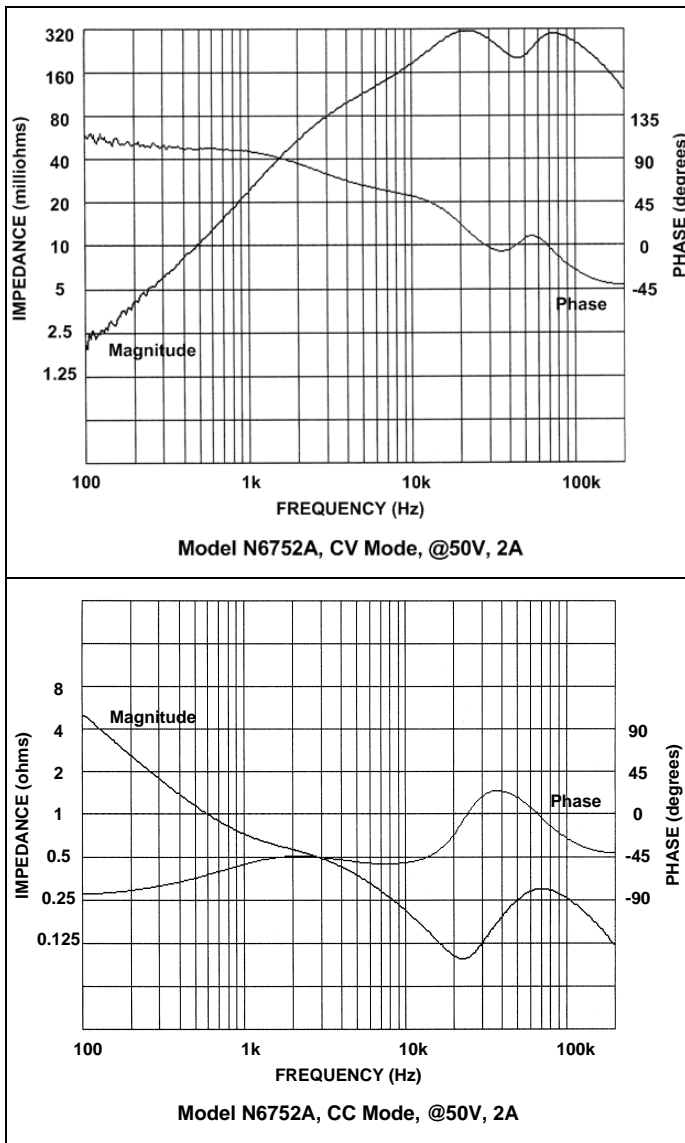

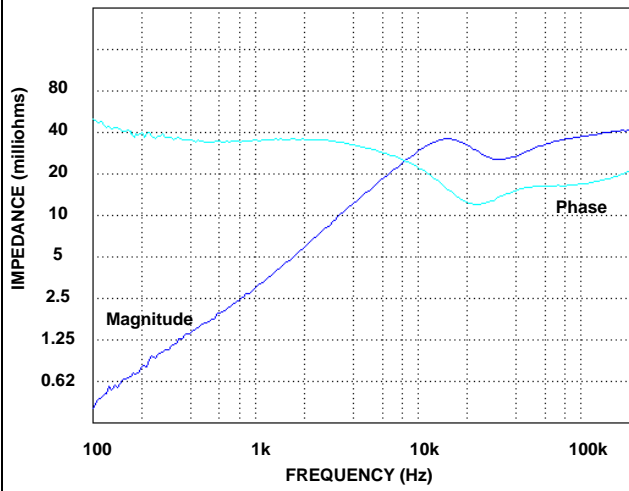

Model N6753A and N6755A, CV Mode, @20 V, 15A

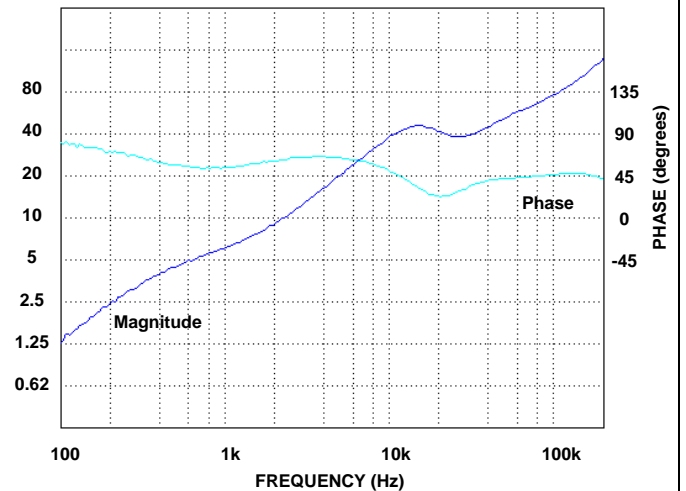

Model N6753A and N6755A, Option 760, CV Mode, @20 V, 15A

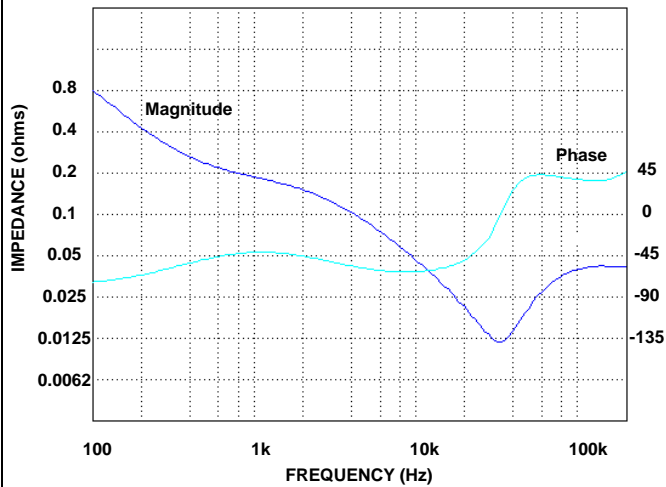

Model N6753A and N6755A, CC Mode, @20 V, 15A

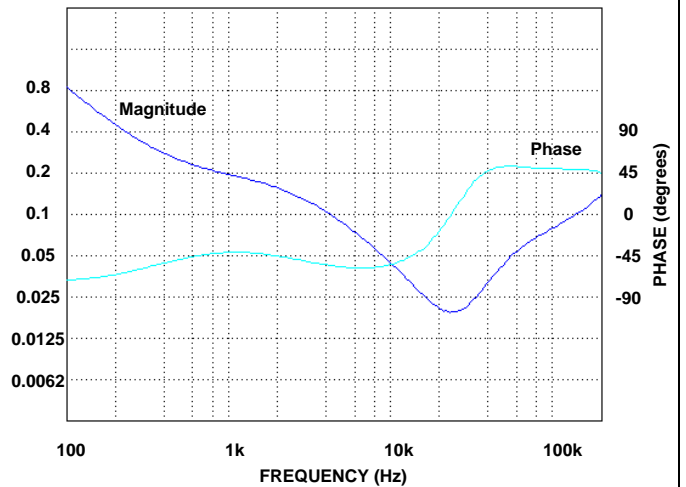

Model N6753A and N6755A, Option 760, CC Mode, @20 V, 15A

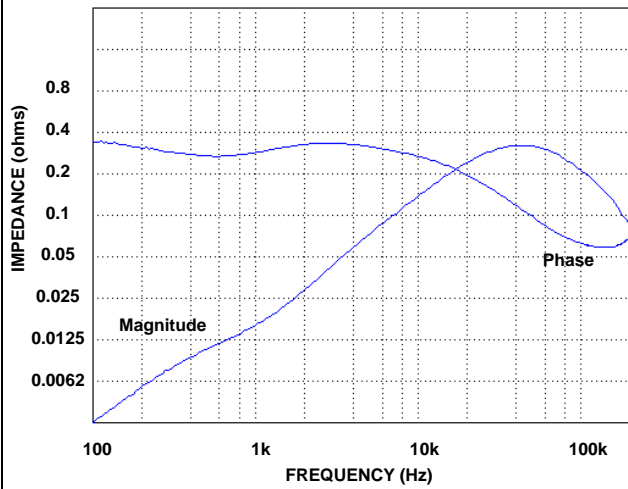

Model N6754A and N6756A, CV Mode, @60 V, 5A

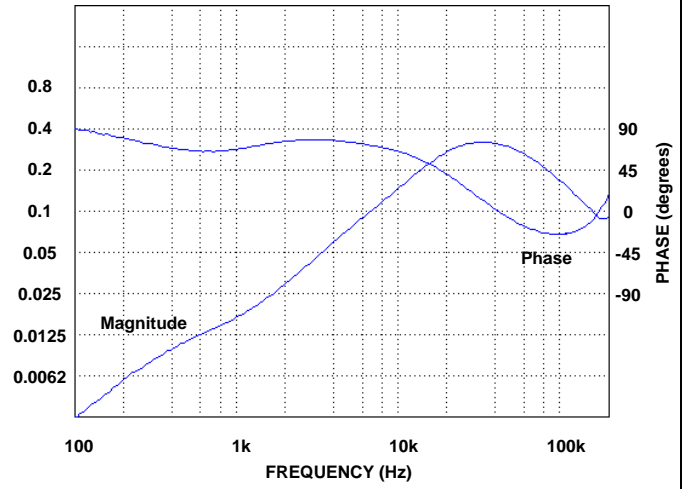

Model N6754A and N6756A, Option 760, CV Mode, @60 V, 5A

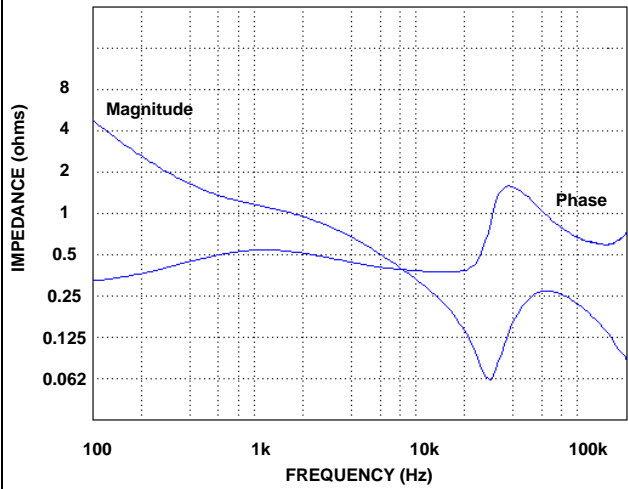

Model N6754A and N6756A, CC Mode, @60 V, 5A

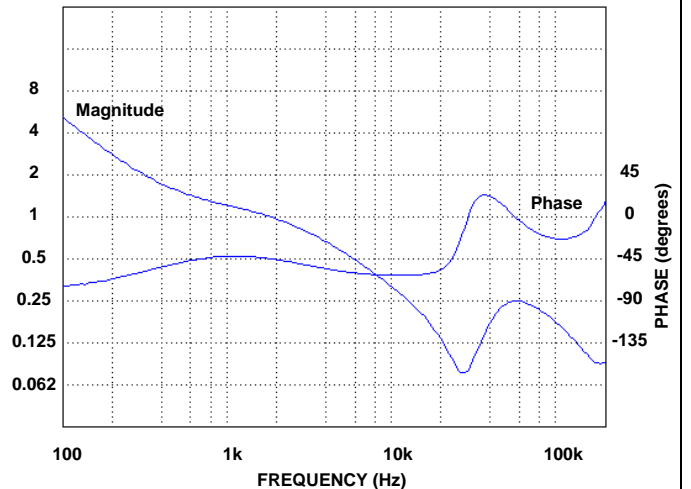

Model N6754A and N6756A, Option 760, CC Mode, @60 V, 5A

Arbitrary Waveform Generator Maximum Bandwidth

NOTE

The information in this section only applies when the power modules are installed in an Agilent N6705 DC Power Analyzer.

The following tables characterize the maximum bandwidth of the arbitrary waveform generator. The maximum bandwidth is based on a sine wave into a resistive load and applies to any output current. The following definitions apply in the frequency tables:

- V p-p = Voltage peak-to-peak
- 3 dB max. = Max. frequency where the voltage drops to 3 dB below its setting
- THD 3 dB = The total harmonic distortion at 3 dB max. frequency
- THD < 1.5% = The frequency below which the THD is less than 1.5%.

Voltage	3 dB max	THD 3 dB	THD < 1.5%
N6751A & N6752A			
0.5 Vp-p	4000 Hz	12%	440 Hz
1.0 Vp-p	2200 Hz	21%	440 Hz
2.5 Vp-p	900 Hz	25%	265 Hz
5.0 Vp-p	500 Hz	27%	160 Hz
50.0 Vp-p	340 Hz	22%	25 Hz
N6753A & N6755A			
0.2 Vp-p	2300 Hz	10%	1300 Hz
0.4 Vp-p	1500 Hz	15%	800 Hz
1.0 Vp-p	980 Hz	19%	480 Hz
2.0 Vp-p	580 Hz	21%	300 Hz
20.0 Vp-p	400 Hz	12%	32 Hz
N6754A & N6756A			
0.6 Vp-p	2800 Hz	8.0%	1600 Hz
1.2 Vp-p	1400 Hz	15%	800 Hz
3.0 Vp-p	600 Hz	17%	300 Hz
6.0 Vp-p	400 Hz	20%	200 Hz
60.0 Vp-p	344 Hz	12%	30 Hz



Chapter 4

Agilent N676xA Precision Power Modules

Performance Specifications	28
Supplemental Characteristics	29
Autoranging Characteristic	31
Output Impedance Graphs	31
Arbitrary Waveform Generator Maximum Bandwidth	34

Unless otherwise noted, specifications are warranted over the ambient temperature range of 0 to 40°C after a 30-minute warm-up period. Specifications apply at the output terminals, with each module's sense terminals internally connected to its output terminals (local sensing).

Refer to the Agilent N6700 or N6705 Service Guide for the setup conditions for all performance specifications.

Supplemental characteristics are not warranted but are descriptions of performance determined either by design or by type testing. All supplemental characteristics are typical unless otherwise noted.

Performance Specifications

	N6761A/N6762A	N6763A/N6765A	N6764A/N6766A
DC Ratings:			
Voltage	0 - 50 V	0 - 20 V	0 - 60 V
Current ^{NOTE 1}	0 - 1.5 A / 0 - 3 A	0 - 50 A	0 - 20 A / 0 - 17 A
Power	50 W / 100 W	300 W / 500 W	300 W / 500 W
Low programming ranges (V & I)	5.5 V; 100 mA	N/A	N/A
Low measurement ranges (V & I)	5.5 V; 100 mA	2 V; 1.5 A	6 V; 0.5 A
Output Ripple and Noise (PARD): (from 20 Hz – 20 MHz)			
CV peak-to-peak	4.5 mV	5 mV	6 mV
CV rms	0.35 mV	1 mV	1 mV
Load Effect (Regulation): (Applies for any output load change, with a maximum load-lead drop of 1V/lead. The load lead drop reduces the maximum available voltage at the load.)			
Voltage	0.5 mV	2 mV	2 mV
Current	30 μ A (@ 0 – 7 V) 65 μ A (@ 7 – 50V)	12 mA	5 mA
Source Effect (Regulation):			
Voltage	0.5 mV	0.5 mV	1.2 mV
Current	30 μ A	5 mA	2 mA
Programming Accuracy: (@ 23 °C \pm 5 °C after 30 minute warm-up. Applies from minimum to maximum programming range at any load.)			
Voltage, high range	0.016% + 6 mV	0.03% + 5 mV	0.03% + 12 mV
Voltage, low range	0.016% + 1.5 mV	N/A	N/A
Current, high range	0.04% + 200 μ A	0.1% + 15 mA	0.075% + 4 mA
Current, low range	0.04% + 30 μ A (@ 0 – 7 V) 0.04% + 55 μ A (@ 7 – 50 V)	N/A	N/A
Voltmeter/Ammeter Measurement Accuracy: (@ 23 °C \pm 5 °C. Applies when measuring 4096 data points with a 20.48 μ s time interval.)			
Voltage, high range	0.016% + 6 mV	0.03% + 10 mV	0.03% + 25 mV
Voltage, low range	0.016% + 1.5 mV	0.03% + 1.5 mV	0.03% + 5 mV
Current, high range	0.04% + 160 μ A	0.1% + 10 mA	0.1% + 5 mA
Current, low range	0.03% + 15 μ A (@ 0 – 7 V) 0.03% + 55 μ A (@ 7 – 50 V)	0.05% + 1.1 mA ^{NOTE 2}	0.05% + 0.75 mA ^{NOTE 2}
200 μ A current range (Option 2UA)	0.5% + 100 nA	N/A	N/A
Load Transient Recovery Time: (time to recover to within the settling band following a load change - from 60% to 100% and from 100% to 60% of full load for model N6761A - from 50% to 100% and from 100% to 50% of full load for model N6762A through N6766A)			
Voltage settling band	\pm 75 mV	\pm 30 mV ^{NOTE 3}	\pm 90 mV ^{NOTE 4}
Time	< 100 μ s	< 100 μ s	< 100 μ s

¹ Output current is derated 1% per °C above 40°C.

² Applies when measuring currents that remain within the low range. Due to thermal settling, when transitioning from measuring full-rated output current (the worst case), to measuring the current within the low range, the low range accuracy specification is typically met within 5 seconds after the current has transitioned into the low range. Accuracies within this 5 second settling period are typically 2X the specified accuracy or better.

³ When relay option 760 or 761 is installed on Models N6763A and N6765A, the settling band is \pm 200 mV.

⁴ When relay option 760 or 761 is installed on Models N6764A and N6766A, the settling band is \pm 350 mV.

Supplemental Characteristics

	N6761A / N6762A	N6763A / N6765A	N6764A / N6766A
Programming Ranges:			
Voltage, high range	15 mV – 51 V	10 mV – 20.4 V	25 mV- 61.2 V
Voltage, low range	12 mV – 5.5 V	N/A	N/A
Current, high range	1 mA – 1.53 A/1 mA – 3.06 A	50 mA – 51 A	20 mA – 20.4A/20 mA – 17.3A
Current, low range	0.1 mA – 0.1 A ^{NOTE 1}	N/A	N/A
Programming Resolution:			
Voltage, high range	880 μ V	1.5 mV	4.2 mV
Voltage, low range	90 μ V	N/A	N/A
Current, high range	60 μ A	16.3 mA	6.5 mA
Current, low range	2 μ A	N/A	N/A
Measurement Resolution:			
Voltage, high range	440 μ V	250 μ V	600 μ V
Voltage, low range	44 μ V	25 μ V	60 μ V
Current, high range	30 μ A	500 μ A	250 μ A
Current, low range	1 μ A	20 μ A	10 μ A
200 μ A current range (Option 2UA)	4 nA	N/A	N/A
Programming Temperature Coefficient per °C:			
Voltage, high range	18 ppm + 140 μ V	23 ppm + 95 μ V	23 ppm + 218 μ V
Voltage, low range	40 ppm + 70 μ V	N/A	N/A
Current, high range	33 ppm + 10 μ A	25ppm + 129 μ A	25ppm + 52 μ A
Current, low range	60 ppm + 1.5 μ A	N/A	N/A
Measurement Temperature Coefficient per °C:			
Voltage, high range	23 ppm + 40 μ V	23 ppm + 53 μ V	23 ppm + 73 μ V
Voltage, low range	30 ppm + 40 μ V	25 ppm + 53 μ V	25 ppm + 73 μ V
Current, high range	40 ppm + 0.3 μ A	25 ppm + 21 μ A	25 ppm + 7 μ A
Current, low range	50 ppm + 0.3 μ A	27 ppm + 21 μ A	27 ppm + 7 μ A
Current, 200 μ A range (Option 2UA)	100 ppm + 3 nA/°C	N/A	N/A
N6705 Mainframe Oscilloscope Measurement Accuracy: (@ 23 °C \pm5 °C, accuracy of any individual point in the trace)			
Voltage	0.016% + 16 mV	0.03% + 13 mV	0.03% + 32 mV
Current, high range – with Correction On ^{NOTE 2}	0.04% + 10 mA	N/A	N/A
Current, high range	0.04% + 1 mA	0.1% + 16 mA	0.1% + 8.4 mA
Current, low range	0.03% + 0.175 mA	0.05% + 6.6 mA	0.05% + 2.6 mA
Up-programming Time with full resistive load: (Time from 10% to 90% of total voltage excursion)			
Small voltage step	0 V to 10 V	0 V to 6 V/0 V to 10 V	0 V to 15 V/0 V to 29 V
Time	0.6 ms	0.4 ms/0.5 ms	0.35 ms/0.7 ms
Large voltage step	0 V to 50 V	0 V to 20 V	0 V to 60 V
Time	2.2 ms	1.5 ms	2 ms
Up-programming Settling Time with full resistive load: (Time from start of voltage change to 0.1% of full scale value)			
Small voltage step	0 V to 10 V	0 V to 6 V/0 V to 10 V	0 V to 15 V/0 V to 29 V
Time	0.9 ms	0.8 ms/1.0 ms	0.8 ms/1.4 ms
Large voltage step	0 V to 50 V	0 V to 20 V	0 V to 60 V
Time	4 ms	3 ms	4.2 ms

Supplemental Characteristics (continued)

	N6761A / N6762A	N6763A / N6765A	N6764A / N6766A
Down-programming Time with no load: (time from start of voltage change to output voltage < 0.5 V)			
Small voltage step	10 V to 0 V	6 V to 0 V/10 V to 0 V	15 V to 0 V/29 V to 0 V
Time	0.3 ms	0.55 ms/1.0 ms	0.6 ms/1.2 ms
Large voltage step	50 V to 0 V	20 V to 0 V	60 V to 0 V
Time	1.3 ms	1.8 ms	2.2 ms
Down-programming Settling Time with no load: (time from start of voltage change to 0.1% of full scale value)			
Small voltage step	10 V to 0 V	6 V to 0 V/10 V to 0 V	15 V to 0 V/29 V to 0 V
Time	0.45 ms	0.8 ms/1.3 ms	0.8 ms/1.5 ms
Large voltage step	50 V to 0 V	20 V to 0 V	60 V to 0 V
Time	1.4 ms	2 ms	2.3 ms
Down-programming Time with Capacitive load: (time from start of voltage change to output voltage < 0.5 V)			
Small voltage step	10 V to 0 V	6 V to 0 V/10 V to 0 V	15 V to 0 V/29 V to 0 V
Time	4.5 ms	2.2 ms/4.5 ms	2.3 ms/5.5 ms
Large voltage step	50 V to 0 V	20 V to 0 V	60 V to 0 V
Time	23 ms	8.5 ms	10 ms
Capacitive load ^{NOTE 3}	1000 μ F	4700 μ F	680 μ F
Down-programming Capability:			
Continuous power	7 W	12.5 W	12.5 W
Peak current	3.8 A	15 A	6 A
Over-voltage Protection:			
Accuracy	0.25% + 0.25 V	0.25% + 0.15 V	0.25% + 0.3 V
Accuracy with Option 761	0.25% + 0.25 V	0.25% + 0.45 V	0.25% + 0.6 V
Accuracy with Option 760	N/A	0.25% + 0.45 V	0.25% + 0.6 V
Maximum setting	55 V	22 V	66 V
Response time	50 μ s from occurrence of over-voltage condition to start of output shutdown		
Output Ripple and Noise: (PARD)			
CC rms:	2 mA	10 mA	4 mA
Common Mode Noise: (from 20 Hz – 20 MHz; from either output to chassis)			
rms	500 μ A	500 μ A	750 μ A
peak-to-peak	< 2 mA	< 2 mA	< 3 mA
Remote Sense Capability:	Outputs can maintain specifications with up to a 1-volt drop per load lead. The load lead drop reduces the maximum available voltage at the load.		
Series and Parallel Operation:	Identically rated outputs can be operated directly in parallel or be connected for straight series operation. Auto-series and auto-parallel operation is not available.		
Minimum Output Turn-On Delay: (Time from when any Output On command is received until the output starts turning on)			
Without relay option	32 ms ^{NOTE 4}	18 ms	18 ms
With relay Option 760	58 ms ^{NOTE 4}	44 ms	44 ms

¹ If you are operating the unit below 255 μ A in constant current mode, the output may become unregulated with the following load conditions: The load resistance is <175 m Ω and the load inductance is >20 μ H. If this occurs, an UNRegulated flag will be generated and the output current may rise above the programmed value but will remain less than 255 μ A.

² Correction On compensates for current flowing into the output capacitor during voltage transients

³ Modules can discharge the specified capacitive load from full scale to 0V at a rate of 4 times/second.

⁴ In Current priority mode, minimum delay is 23 ms without relays and 45 ms with relay Option 760.

Autoranging Characteristic

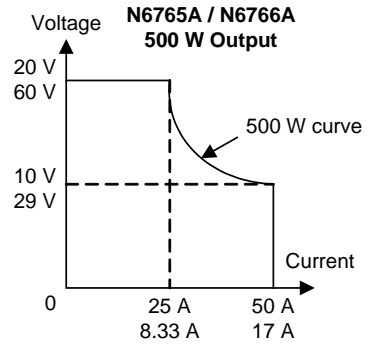
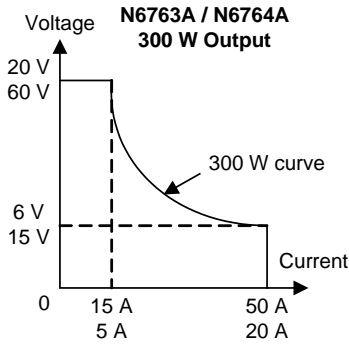
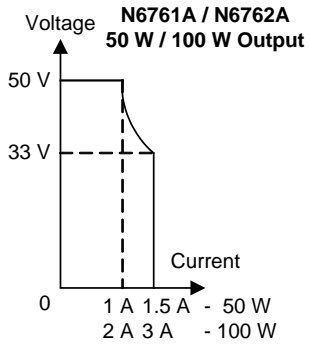

Output Impedance Graphs

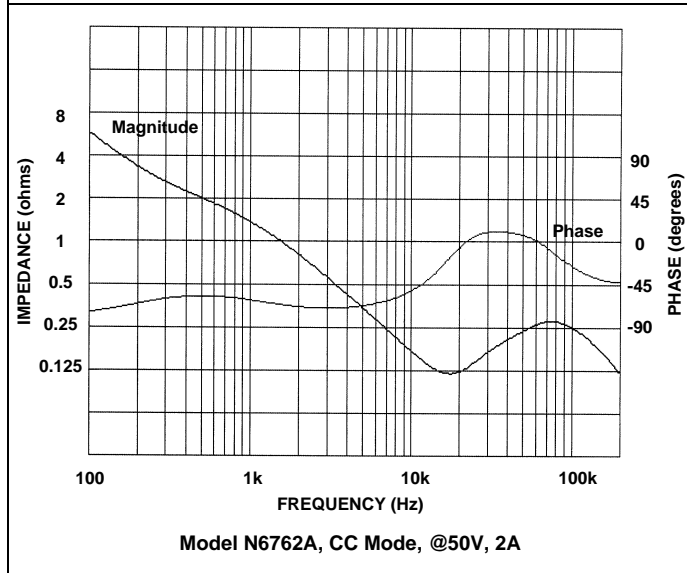
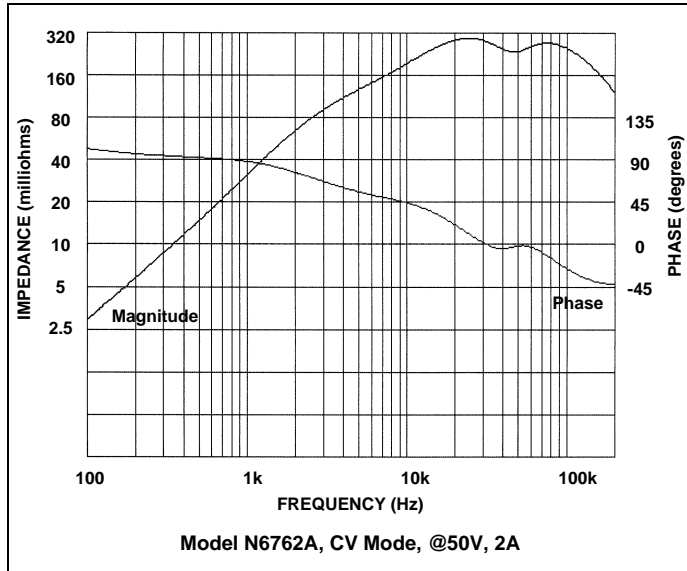

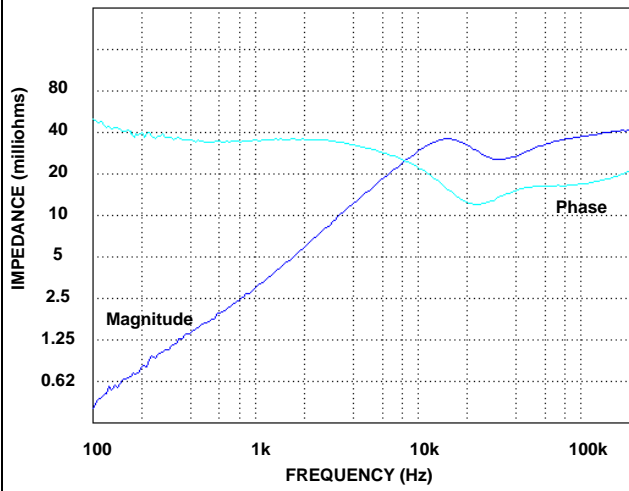

Model N6763A and N6765A, CV Mode, @20 V, 15A

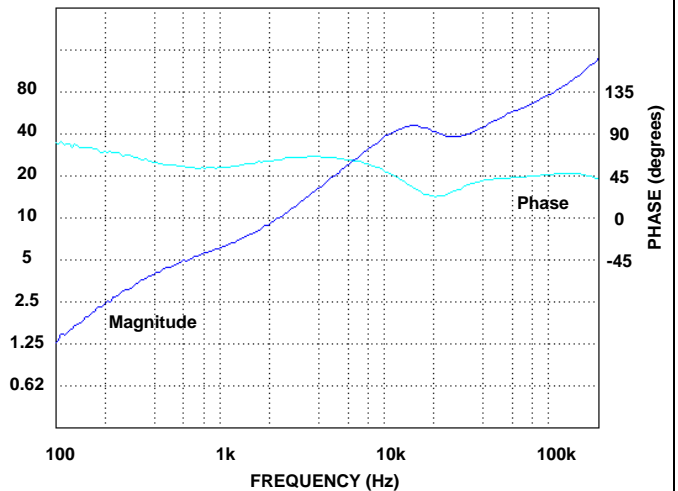

Model N6763A and N6765A, Option 760, CV Mode, @20 V, 15A

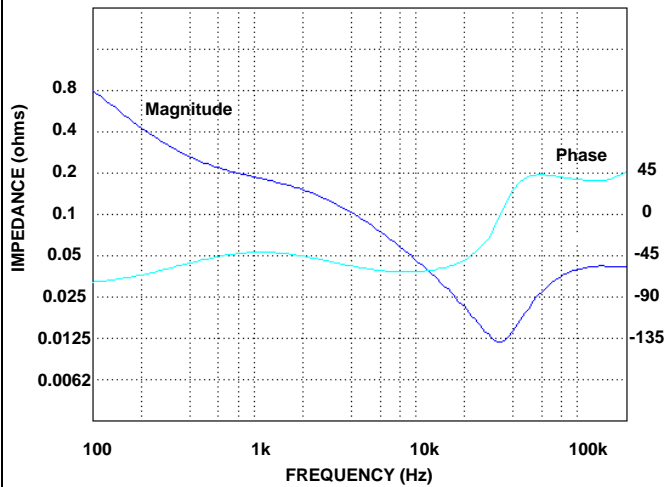

Model N6763A and N6765A, CC Mode, @20 V, 15A

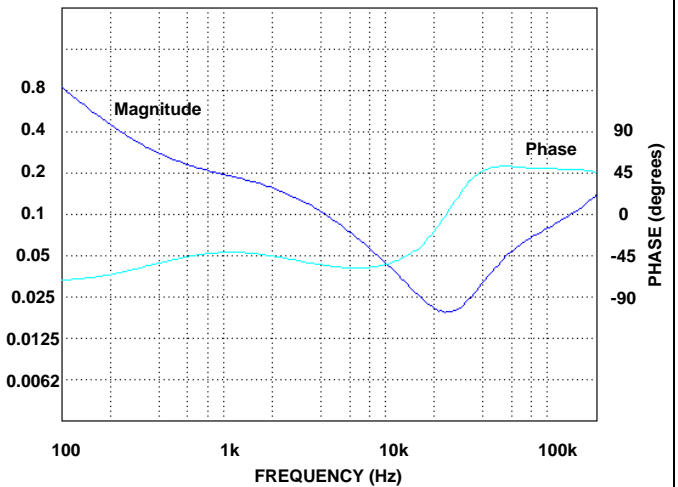

Model N6763A and N6765A, Option 760, CC Mode, @20 V, 15A

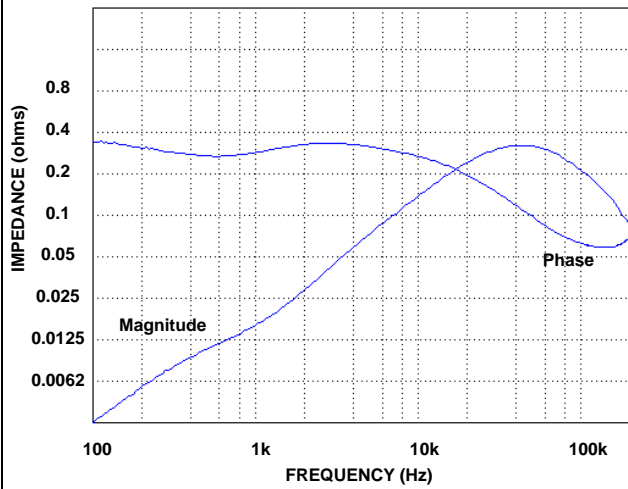

Model N6764A and N6766A, CV Mode, @60 V, 5A

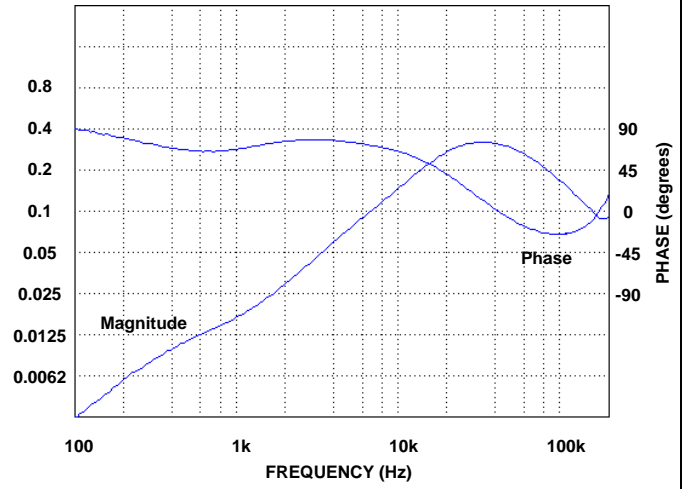

Model N6764A and N6766A, Option 760, CV Mode, @60 V, 5A

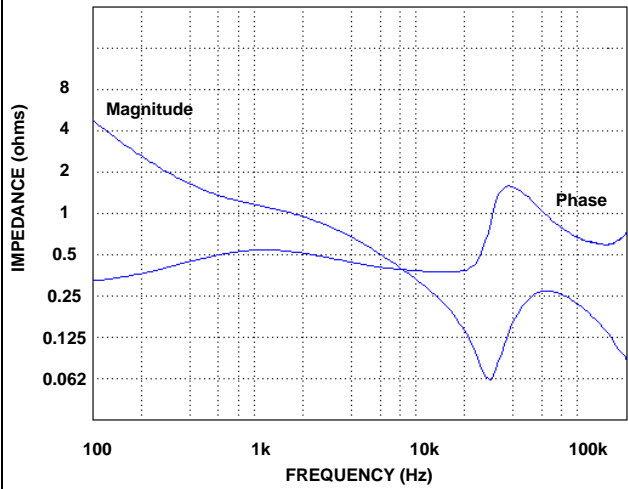

Model N6764A and N6766A, CC Mode, @60 V, 5A

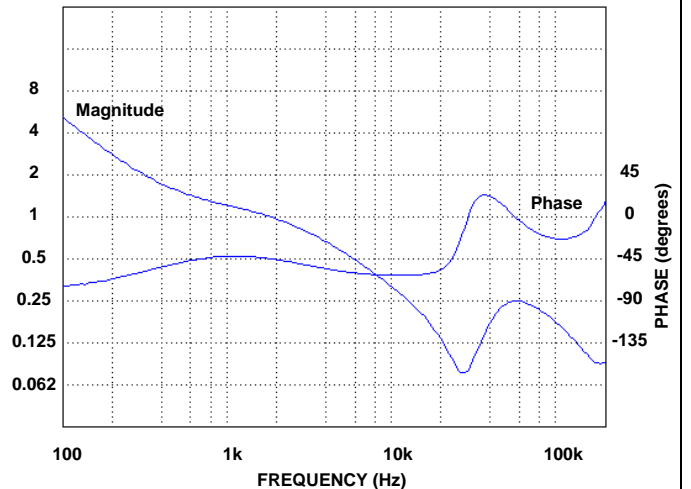

Model N6764A and N6766A, Option 760, CC Mode, @60 V, 5A

Arbitrary Waveform Generator Maximum Bandwidth

NOTE

The information in this section only applies when the power modules are installed in an Agilent N6705 DC Power Analyzer.

The following tables characterize the maximum bandwidth of the arbitrary waveform generator. The maximum bandwidth is based on a sine wave into a resistive load and applies to any output current. The following definitions apply in the frequency tables:

- V p-p = Voltage peak-to-peak
- 3 dB max. = Max. frequency where the voltage drops to 3 dB below its setting
- THD 3 dB = The total harmonic distortion at 3 dB max. frequency
- THD < 1.5% = The frequency below which the THD is less than 1.5%.

Voltage	3 dB max	THD 3 dB	THD < 1.5%
N6761A & N6762A			
0.5 Vp-p	4500 Hz	14%	450 Hz
1.0 Vp-p	3600 Hz	14%	450 Hz
2.5 Vp-p	1300 Hz	25%	340 Hz
5.0 Vp-p	600 Hz	25%	250 Hz
50.0 Vp-p	350 Hz	22%	30 Hz
N6763A & N6765A			
0.2 Vp-p	2300 Hz	10%	1300 Hz
0.4 Vp-p	1500 Hz	15%	800 Hz
1.0 Vp-p	980 Hz	19%	480 Hz
2.0 Vp-p	580 Hz	21%	300 Hz
20.0 Vp-p	400 Hz	12%	32 Hz
N6764A & N6766A			
0.6 Vp-p	2800 Hz	8.0%	1600 Hz
1.2 Vp-p	1400 Hz	15%	800 Hz
3.0 Vp-p	600 Hz	17%	300 Hz
6.0 Vp-p	400 Hz	20%	200 Hz
60.0 Vp-p	344 Hz	12%	30 Hz



Chapter 5

Agilent N6781A, N6782A, N6784A

Source/Measure Units

Performance Specifications	36
Supplemental Characteristics	37
Output Quadrant Characteristic	42
Output Impedance Graphs	42

Unless otherwise noted, specifications are warranted over the ambient temperature range of 0 to 30°C after a 30-minute warm-up period. Unless otherwise noted, specifications apply at the mainframe output terminals, with each module's sense terminals internally connected to its output terminals (local sensing).

Refer to the Agilent N6700 or N6705 Service Guide for the setup conditions for all performance specifications.

Supplemental characteristics are not warranted but are descriptions of performance determined either by design or by type testing. All supplemental characteristics are typical unless otherwise noted.

Performance Specifications

	N6781A	N6782A	N6784A
DC Ratings:			
Voltage	20 V / 6 V	20 V / 6 V	± 20 V / ± 6 V
Current ^{NOTE 1}	± 1 A / ± 3 A	± 1 A / ± 3 A	± 1 A / ± 3 A
Power	20 W	20 W	20 W
Auxiliary Voltage Measurement Input:	± 20 V	N/A	N/A
Output Voltage Ripple & Noise (PARD) from 20 Hz – 20 MHz: (Measured at front panel terminals, with full load, in Voltage Priority mode. Output Bandwidth setting = Low)			
CV peak-to-peak	12 mV	12 mV	12 mV
CV rms	1.2 mV	1.2 mV	1.2 mV
Load Effect (Load regulation): (For any load change, based on a load lead drop 1.0 V. The load lead drop reduces the maximum available voltage at the load.)			
Voltage, 20 V range	700 µV	700 µV	700 µV
Voltage, 6 V range	400 µV	400 µV	400 µV
Current, 3 A range	100 µA	100 µA	100 µA
Current, 1 A range	50 µA	50 µA	50 µA
Current 300 mA range	50 µA	50 µA	N/A
Current 100 mA & 10 mA range ^{NOTE 2}	N/A	N/A	5 µA
Source Effect (Line regulation):			
Voltage, all ranges	300 µV	300 µV	300 µV
Current, all ranges	60 µA	60 µA	60 µA
Programming Accuracy @ 23 °C ±5 °C: (After a 30 minute warm-up. Applies from minimum to maximum programming range at any load.)			
Voltage, 20 V range	0.025% + 1.8 mV	0.025% + 1.8 mV	0.025% + 1.8 mV
Voltage, 6V range	0.025% + 600 µV	0.025% + 600 µV	0.025% + 600 µV
Voltage 600 mV range ^{NOTE 2}	0.025% + 200 µV	0.025% + 200 µV	0.025% + 200 µV
Current 3 A & 1 A range	0.04% + 300 µA	0.04% + 300 µA	0.04% + 300 µA
Current 300 mA range ^{NOTE 2}	0.03% + 150 µA	0.03% + 150 µA	N/A
Current 100 mA range ^{NOTE 2}	N/A	N/A	0.03% + 12 µA
Current 10 mA range ^{NOTE 2}	N/A	N/A	0.025% + 5 µA
Resistance for 20 V, 1 A output range	0.1% + 3 mΩ	N/A	N/A
Resistance for 6 V, 3 A output range	0.1% + 1.5 mΩ	N/A	N/A
Measurement Accuracy @ 23 °C ±5 °C: (Applies when measuring the default value of 4883 data points with a 20.48 µs time interval.)			
Voltage 20 V range	0.025% + 1.2 mV	0.025% + 1.2 mV	0.025% + 1.2 mV
Voltage 1 V range	0.025% + 75 µV	0.025% + 75 µV	0.025% + 75 µV
Voltage 100 mV range	0.025% + 50 µV	0.025% + 50 µV	0.025% + 50 µV
Current 3 A range	0.03% + 250 µA	0.03% + 250 µA	0.03% + 250 µA
Current 100 mA range	0.025% + 10 µA	0.025% + 10 µA	0.025% + 10 µA
Current 1 mA range ^{NOTE 3}	0.025% + 100 nA (110 nA)	0.025% + 100 nA (110 nA)	0.025% + 100 nA (110 nA)
Current 10 µA range ^{NOTE 3}	0.025% + 8 nA (20 nA)	0.025% + 8 nA (20 nA)	0.025% + 8 nA (20 nA)
Auxiliary Voltage Measurement Input	0.025% + 5 mV	N/A	N/A
Load Transient Response Time in Voltage Priority mode: (Time to recover to within settling band for a load change from 0.1 A to 0.9 A in the 20 V range; from 0.1 A to 1.5 A in the 6 V range.)			
Settling band for 20 V, 1 A output range	± 10 mV	± 10 mV	± 10 mV
Settling band for 6 V, 3 A output range	± 20 mV	± 20 mV	± 20 mV
Recovery time	≤ 35 µs	≤ 35 µs	≤ 35 µs

¹ Output current is derated 1% per °C above 30°C.

² 600 mV range is only available in Voltage Priority mode;

300 mA, 100 mA, 10 mA ranges are only available in Current Priority mode.

³ Values in parentheses apply when power modules are installed in Agilent N6705A mainframes.

Supplemental Characteristics

	N6781A, N6782A	N6784A
Minimum Current and Voltage Compliance limits:		
Minimum current limit for 20 V range in Voltage Priority mode	10 mA	10 mA
Minimum current limit for 6 V range in Voltage Priority mode	20 mA	20 mA
Minimum voltage limit for 3 A range in Current Priority mode	10 mV	10 mV
Minimum voltage limit for 1 A range in Current Priority mode	20 mV	20 mV
Programming Range & Resolution:		
Voltage, 20 V range	0 to 20.4 V; 200 μ V	-20.4 V to 20.4 V; 200 μ V
Voltage, 6 V range	0 to 6.12 V; 60 μ V	-6.12 V to 6.12 V; 60 μ V
Voltage, 600 mV range	0 to 612 mV; 6 μ V	-612 mV to 612 mV; 6 μ V
Current, 3 A range	-3.06 A to 3.06 A; 50 μ A	-3.06 A to 3.06 A; 50 μ A
Current, 1 A range	-1.02 A to 1.02 A; 50 μ A	-1.02 A to 1.02 A; 50 μ A
Current, 300 mA range	-306 mA to 306 mA; 3 μ A	N/A
Current, 100 mA range	N/A	-102 mA to 102 mA; 1 μ A
Current, 10 mA range	N/A	-10.2 mA to 10.2 mA; 0.1 μ A
Resistance, for 20 V / 1 A range (N6781A only)	-40m Ω to +1 Ω ; 0.5m Ω	
Resistance, for 6 V / 3 A range (N6781A only)	-40m Ω to +1 Ω ; 0.25m Ω	
Programming Accuracy Temperature Coefficient (per $^{\circ}$C):		
Voltage, 20 V range	0.002% +120 μ V	0.002% +120 μ V
Voltage, 6 V range	0.0015% +40 μ V	0.0015% +40 μ V
Voltage, 600 mV range	0.0015% +10 μ V	0.0015% +10 μ V
Current, 3 A range	0.0025% +22 μ A	0.0025% +22 μ A
Current, 1 A range	0.0025% +22 μ A	0.0025% +22 μ A
Current, 300 mA range	0.0025% +14 μ A	N/A
Current, 100 mA range	N/A	0.0025% +1 μ A
Current, 10 mA range	N/A	0.0025% +0.5 μ A
Measurement Resolution:		
Voltage, 20 V range	200 μ V	200 μ V
Voltage, 1 V range	10 μ V	10 μ V
Voltage, 100 mV range	1 μ V	1 μ V
Current, 3 A range	50 μ A	50 μ A
Current, 100 mA range	1 μ A	1 μ A
Current, 1 mA range	10 nA	10 nA
Current, 10 μ A range	0.1 nA	0.1 nA
Auxiliary Voltage Measurement Input (N6781A only)	800 μ V	N/A
Measurement Accuracy Temperature Coefficient (per $^{\circ}$C):		
Voltage, 20 V range	0.0025% +25 μ V	0.0025% +25 μ V
Voltage, 1 V range	0.002% +2.5 μ V	0.002% +2.5 μ V
Voltage, 100 mV range	0.0025% +2.5 μ V	0.0025% +2.5 μ V

Supplemental Characteristics (continued)

	N6781A, N6782A				N6784A				
Measurement Accuracy Temperature Coefficient (continued)									
Current, 3 A range	0.0025% +14 μ A				0.0025% +14 μ A				
Current, 100 mA range	0.0025% +0.4 μ A				0.0025% +0.4 μ A				
Current, 1 mA range	0.002% +5 nA				0.002% +5 nA				
Current, 10 μ A range	0.002% +0.55 nA				0.002% +0.55 nA				
Auxiliary Voltage Measurement Input (N6781A only)	0.0007% +200 μ V				N/A				
Voltage Programming Speed & Settling Time:									
At the specified Bandwidth setting.	Low	High1	High2	High3	Low	High1	High2	High3	
Rise Time (from 10% to 90% of step)									
20 V range with a 0-10 V step	300 μ s	15 μ s	20 μ s	120 μ s	300 μ s	15 μ s	20 μ s	120 μ s	
6 V range with a 0-4 V step	300 μ s	20 μ s	22 μ s	50 μ s	300 μ s	20 μ s	22 μ s	50 μ s	
600mV range with a 0-500 mV step	400 μ s	75 μ s	30 μ s	50 μ s	400 μ s	75 μ s	30 μ s	50 μ s	
Settling Time (to 0.1% of step)									
20 V range with a 0-10 V step	850 μ s	45 μ s	65 μ s	240 μ s	850 μ s	45 μ s	65 μ s	240 μ s	
6 V range with a 0-4 V step	850 μ s	55 μ s	65 μ s	160 μ s	850 μ s	55 μ s	65 μ s	160 μ s	
600mV range with a 0-500 mV step	1.2 ms	220 μ s	85 μ s	170 μ s	1.2 ms	220 μ s	85 μ s	170 μ s	
High Frequency Output Voltage Noise:									
At the specified Bandwidth setting.	Low	High1	High2	High3	Low	High1	High2	High3	
CV peak-to-peak (from 20 Hz – 20 MHz;)									
20 V range with no load	12 mV	12 mV	4 mV	4 mV	12 mV	12 mV	4 mV	4 mV	
6 V & 600 mV range with no load	12 mV	12 mV	4 mV	3 mV	12 mV	12 mV	4 mV	3 mV	
CV rms (from 20 Hz – 20 MHz;)									
20 V range with no load	1.2 mV	1.2 mV	0.5 mV	0.5 mV	1.2 mV	1.2 mV	0.5 mV	0.5 mV	
6 V & 600 mV range with no load	1 mV	1 mV	0.3 mV	0.3 mV	1 mV	1 mV	0.3 mV	0.3 mV	
Low Frequency Output Voltage Noise:									
CV peak to peak (from 0.1 Hz – 10 Hz)									
20 V range			N/A				100 μ V		
6 V range			N/A				50 μ V		
600 mV range			N/A				20 μ V		
CV rms (from 0.1 Hz – 10 Hz)									
20 V range			N/A				20 μ V		
6 V range			N/A				10 μ V		
600 mV range			N/A				5 μ V		
Voltage Programming Small Signal Bandwidth: (All ranges)									
At the specified Bandwidth setting.	Low	High1	High2	High3	Low	High1	High2	High3	
3 dB typical									
with no load cap	DC to	1.4 kHz	29 kHz	N/A	N/A	1.4 kHz	29 kHz	N/A	N/A
with 1 μ F load cap	DC to	N/A	60 kHz	21 kHz	N/A	N/A	60 kHz	21 kHz	N/A
with 6.8 μ F load cap	DC to	N/A	N/A	40 kHz	8.6 kHz	N/A	N/A	40 kHz	8.6 kHz
with 150 μ F load cap	DC to	2.9 kHz	N/A	N/A	14 kHz	2.9 kHz	N/A	N/A	14 kHz
1 dB typical									
with no load cap	DC to	700 Hz	15 kHz	N/A	N/A	700 Hz	15 kHz	N/A	N/A
with 1 μ F load cap	DC to	N/A	22 kHz	11 kHz	N/A	N/A	22 kHz	11 kHz	N/A
with 6.8 μ F load cap	DC to	N/A	N/A	14 kHz	4.3 kHz	N/A	N/A	14 kHz	4.3 kHz
with 150 μ F load cap	DC to	1 kHz	N/A	N/A	6 kHz	1 kHz	N/A	N/A	6 kHz

Supplemental Characteristics (continued)

	N6781A, N6782A	N6784A
Voltage Measurement Noise:		
Peak value		
20 V range	3 mV	3 mV
1 V range	250 μ V	250 μ V
100 mV range	50 μ V	50 μ V
Voltage Measurement Settling Time: (All ranges)		
Settling Time with no range change	40 μ s	40 μ s
Voltage Measurement Small Signal Bandwidth: (All ranges)		
3 db typical with seamless ranging Off	DC to 30 kHz	DC to 30 kHz
with seamless ranging On	DC to 27 kHz	N/A
1 db typical with seamless ranging Off	DC to 17 kHz	DC to 17 kHz
with Seamless ranging On	DC to 15 kHz	N/A
Auxiliary Voltage Measurement Input: (N6781A only)		
Differential input resistance	10 M Ω	N/A
Maximum continuous differential input without damage	\pm 60 V	N/A
Maximum voltage from chassis common	\pm 240 VDC	N/A
Maximum conversion rate	100k samples/second	N/A
Voltage Priority Transient Characteristic: (6 V range only)		
At the specified Bandwidth setting.	Low High1 High2 High3	Low High1 High2 High3
At the specified Settling band.	40 mV 50 mV 30 mV 20 mV	40 mV 50 mV 30 mV 20 mV
Recovery time		
with no load cap	30 μ s 10 μ s N/A N/A	30 μ s 10 μ s N/A N/A
with 1 μ F load cap	N/A 20 μ s 10 μ s N/A	N/A 20 μ s 10 μ s N/A
with 6.8 μ F load cap	N/A N/A 25 μ s 15 μ s	N/A N/A 25 μ s 15 μ s
with 150 μ F load cap	140 μ s N/A N/A 35 μ s	140 μ s N/A N/A 35 μ s
Current Programming Speed & Settling Time:		
Rise Time (from 10% to 90% of step)		
3 A range with a 0-3 A step	2.8 μ s	2.8 μ s
1 A range with a 0-1 A step	3.2 μ s	3.2 μ s
300 mA range with a 0-300mA step	3.5 μ s	N/A
100 mA range with a 0-100mA step	N/A	4 μ s
10 mA range with a 0-10mA step	N/A	5 μ s
Settling Time (to 0.1% of step)		
3 A range with a 0-3 A step	30 μ s	30 μ s
1 A range with a 0-1 A step	30 μ s	30 μ s
300 mA range with a 0-300mA step	40 μ s	N/A
100 mA range with a 0-100mA step	N/A	30 μ s
10 mA range with a 0-10mA step	N/A	30 μ s
High Frequency Output Current Noise: (All ranges)		
CC rms (from 20 Hz – 20 MHz;)	200 μ A	200 μ A
Low Frequency Output Current Noise:		
CC rms (from 0.1 Hz – 10 Hz)		
3 A & 1 A ranges	N/A	2 μ A
100 mA range	N/A	50 nA

Supplemental Characteristics (continued)

	N6781A, N6782A	N6784A
Current Programming Small Signal Bandwidth: (All ranges)		
3 dB - for all except 100 mA & 10 mA ranges - for 100 mA & 10 mA ranges	DC to 120 kHz N/A	DC to 120 kHz DC to 100 kHz
1 dB - for all except 100 mA & 10 mA ranges - for 100 mA & 10 mA ranges	DC to 75 kHz N/A	DC to 75 kHz DC to 50 kHz
Current Measurement Noise:		
Peak value		
3 A range	400 μ A	400 μ A
100 mA	20 μ A	20 μ A
1 mA	2 μ A	2 μ A
10 μ A	20 nA	20 nA
Current Measurement Settling Time:		
Settling Time with no range change or when up-ranging		
3 A range	45 μ s	45 μ s
100 mA range	45 μ s	45 μ s
1 mA range	0.5 ms	0.5 ms
10 μ A range (up- ranging N/A)	1.5 ms	1.5 ms
Settling Time when down-ranging		
down-ranging to 100 mA range	45 μ s	45 μ s
down-ranging to 1 mA range	200 μ s	200 μ s
down-ranging to 10 μ A range	3.5 ms	3.5 ms
Current Measurement Small Signal Bandwidth: <small>NOTE 1</small>		
3 dB typical with seamless ranging Off		
3 A range	DC to 29 kHz	DC to 27 kHz
100 mA range	DC to 29 kHz	DC to 27 kHz
1 mA range	DC to 10 kHz	DC to 10 kHz
10 μ A range	DC to 750 Hz	DC to 750 Hz
3 dB typical with seamless ranging On		
3 A range	DC to 26 kHz	N/A
100 mA range	DC to 26 kHz	N/A
1 mA range	DC to 10 kHz	N/A
10 μ A range	N/A	N/A
1 dB typical with seamless ranging Off		
3 A range	DC to 16 kHz	DC to 16 kHz
100 mA range	DC to 16 kHz	DC to 16 kHz
1 mA range	DC to 6 kHz	DC to 6.5 kHz
10 μ A range	DC to 400 Hz	DC to 400 Hz
1 dB typical with seamless ranging On		
3 A range	DC to 14 kHz	N/A
100 mA range	DC to 14 kHz	N/A
1 mA range	DC to 6 kHz	N/A
10 μ A range	N/A	N/A
Common Mode Current from 20 Hz – 20 MHz: (With –output connected to chassis)		
CC peak-to-peak	< 1 mA	< 1 mA
CC rms	<100 μ A	<100 μ A

Supplemental Characteristics (continued)

	N6781A, N6782A	N6784A
Over-voltage Protection:		
Accuracy	0.05% + 20 mV	0.05% + 20 mV
Maximum setting	24 V	24 V
Response time (From occurrence of over-voltage to start of shutdown)	<30 μ s	<30 μ s
Current Priority Transient Characteristic: (3 A range)		
Voltage step	1 V to 4 V	1 V to 4 V
Current settling band	5 mA	5 mA
Recovery time ^{NOTE 2}	12 μ s (24 μ s) ²	12 μ s (24 μ s)
Current Priority Transient Characteristic: (1 A range)		
Voltage step	0.5 V to 20 V	0.5 V to 20 V
Current settling band	10 mA	10 mA
Recovery time ^{NOTE 2}	12 μ s (24 μ s)	12 μ s (24 μ s)
Remote Sense Capability:	Outputs can maintain specifications with up to a 1-volt drop per load lead. The load lead drop reduces the maximum available voltage at the load.	
Series and Parallel Operation:	Not supported	
Minimum Output Turn-on Delay: (Time from when any Output On command is received until the output starts turning on.)		
With output turn-off mode set to Low impedance	25.6 ms	25.6 ms
With output turn-off mode set to High impedance	24.7 ms	24.7 ms

¹ When using an Agilent N6705A mainframe and connecting through the front panel binding posts, additional output capacitance causes large measurement peaking/overshoots when the load impedance is greater than ~ 1 k Ω . This does not apply to Agilent N6705B mainframes. When using an N6705A or N6705B mainframe and connecting **directly** to the module connector, there are slight measurement peaking/overshoots when the load impedance is greater than ~ 10 k Ω .

² Values in parentheses apply when power modules are installed in Agilent N6705A mainframes.

Output Quadrant Characteristic

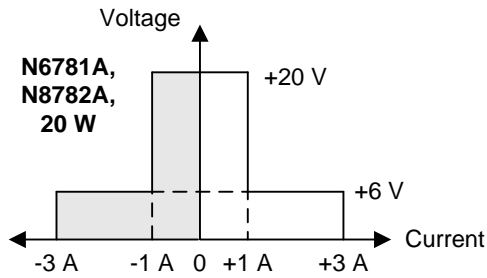

Key
 Sourcing power
 Sinking power

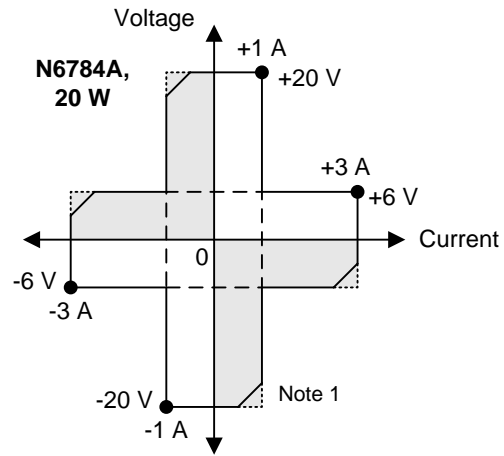

Note 1. When sinking power, Agilent Model N6784A can operate at the maximum rated output power for only a limited amount of time. The unit monitors the temperature of the internal power devices and latches the output off if the output power causes the temperature to exceed its safe limit. A protect clear is required to resume normal operation. The condition is announced by the OT status bit. Refer to the downprogrammer derating figure for the values of the safe limit boundaries.

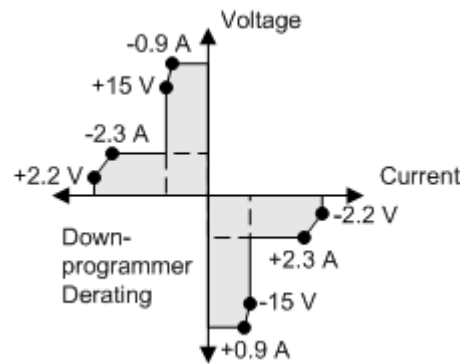

Output Impedance Graphs

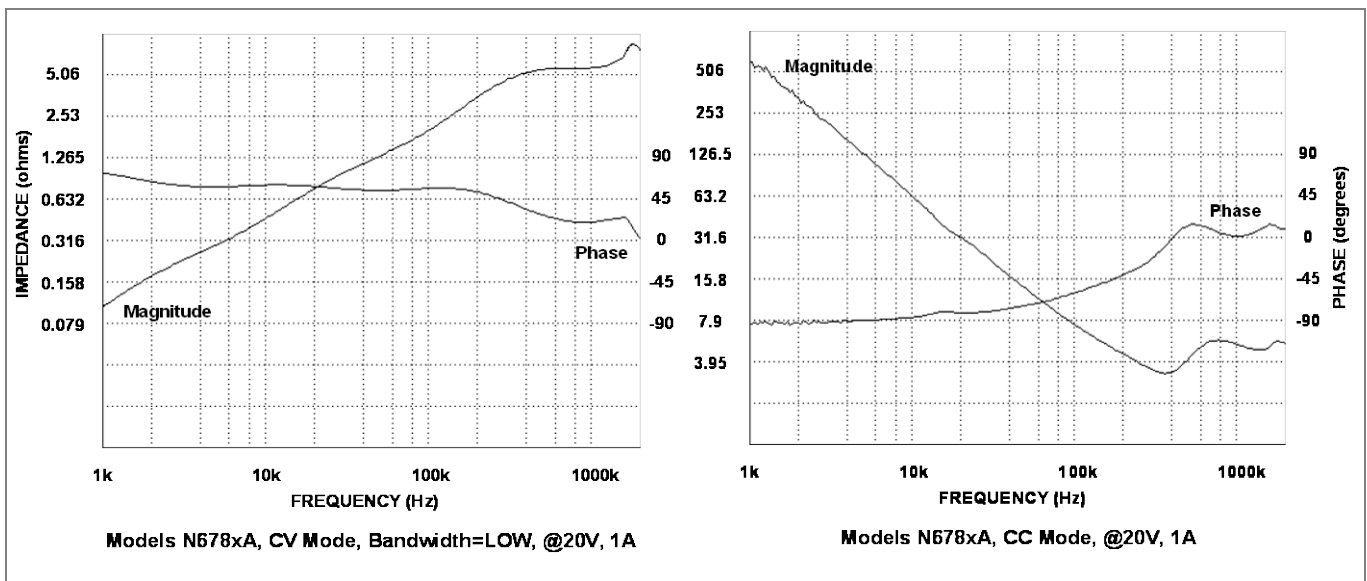



Chapter 6

Agilent N6783A-BAT, N6783A-MFG

Application-Specific Power Modules

Performance Specifications	44
Supplemental Characteristics	45
Output Quadrant Characteristic	46

Unless otherwise noted, specifications are warranted over the ambient temperature range of 0 to 40°C after a 30-minute warm-up period. Specifications apply at the output terminals, with each module's sense terminals internally connected to its output terminals (local sensing).

Refer to the Agilent N6700 or N6705 Service Guide for the setup conditions for all performance specifications.

Supplemental characteristics are not warranted but are descriptions of performance determined either by design or by type testing. All supplemental characteristics are typical unless otherwise noted.

Performance Specifications

	N6783A-BAT	N6783A-MFG
DC Ratings:		
Voltage	0 - 8 V	0 - 6 V
Current ^{NOTE 1}	- 2 to +3 A	- 2; 0 to +3 A
Power	24 W	18 W
Low current measurement range	150 mA	150 mA
Output Ripple and Noise (PARD): (from 20 Hz – 20 MHz)		
CV peak-to-peak	8 mV	8 mV
CV rms	1.5 mV	1.5 mV
Load Effect (Regulation): (For any output load change, with a maximum load-lead drop of 0.5V/lead. The load lead drop reduces the maximum available voltage at the load.)		
Voltage	6 mV	6 mV
Current	2 mA	2 mA
Source Effect (Regulation):		
Voltage	2 mV	2 mV
Current	1 mA	1 mA
Programming Accuracy: (@ 23 °C ±5 °C after a 30 minute warm-up. Applies from minimum to maximum programming range at any load.)		
Voltage	0.1% + 10 mV	0.1% + 10 mV
Positive Current	0.1% + 1.8 mA	0.1% + 1.8 mA
Negative Current @ -2 A	0.2% + 1.8 mA	N/A
Measurement Accuracy: (@ 23 °C ±5 °C. Applies when measuring the default value of 1024 data points with a 20.48 μs time interval.)		
Voltage	0.05% + 5 mV	0.05% + 5 mV
Current high range	0.1% + 600 μA	0.1% + 600 μA
Current low range	0.1% + 75 μA	0.1% + 75 μA
Load Transient Recovery (Time to recover to within settling band for a load change from 0.15 A to 1.5 A and from 1.5 A to 0.15 A at 6 V output)		
Voltage settling band ^{NOTE 2}	± 75 mV	± 75 mV
Time ^{NOTE 2}	< 45 μs	< 45 μs

¹ Output current is derated 1% per °C above 40°C.

² When relay Option 761 is installed, the settling band is ± 90 mV. The time is < 75 μs.

Supplemental Characteristics

	N6783A-BAT	N6783A-MFG
Programming Ranges:		
Voltage	15 mV to 8.16 V	15 mV to 6.12 V
Positive Current	5 mA to 3.06 A	5 mA to 3.06 A
Negative Current	- 5 mA to - 2 A	Fixed at - 2 A
Programming Resolution:		
Voltage	2.5 mV	2.5 mV
Positive Current	1 mA	1 mA
Negative Current	10 mA	N/A
Measurement Resolution:		
Voltage	300 μ V	300 μ V
Current high range	100 μ A	100 μ A
Current low range (\leq 0.150 A)	5 μ A	5 μ A
Programming Temperature Coefficient per $^{\circ}$C:		
Voltage	25 ppm + 50 μ V	25 ppm + 50 μ V
Current	25 ppm + 10 μ A	25 ppm + 10 μ A
Measurement Temperature Coefficient per $^{\circ}$C:		
Voltage	25 ppm + 40 μ V	25 ppm + 40 μ V
Current high range	25 ppm + 2.5 μ A	25 ppm + 2.5 μ A
Current low range (\leq 0.150 A)	25 ppm + 1.5 μ A	25 ppm + 1.5 μ A
Maximum Up-Programming and Down-Programming Time with Full Resistive Load (Time from 10% to 90% of total voltage excursion)		
Voltage Settling from 0V to Full Scale	4.0 ms	4.0 ms
Voltage Settling from Full Scale to 0V	4.0 ms	4.0 ms
Maximum Up-Programming and Down-Programming Settling Time with Full Resistive Load (Time from start of voltage change until voltage settles within 0.1% of the full-scale voltage of its final value)		
Voltage Settling from 0V to Full Scale	20 ms	20 ms
Voltage Settling from Full Scale to 0V	20 ms	20 ms
Over-voltage Protection:		
Accuracy without disconnect relays	0.25% + 75 mV	0.25% + 75 mV
Accuracy with disconnect relays	0.25% + 275 mV	0.25% + 275 mV
Nominal range	0 – 10 V	0 – 10 V
Programmable delay time	60 μ s – 5 ms	60 μ s – 5 ms
Over-Current Protection:		
Programmable delay time	0 – 255 ms	0 – 255 ms
Nominal Range	5 mA – 3.06 A	5 mA – 3.06 A
Output Ripple and Noise: (PARD)		
CC rms:	4 mA	4 mA
Common Mode Noise: (From 20 Hz – 20 MHz; from either output to chassis)		
Rms	1 mA	1 mA
Peak-to-peak	6 mA	6 mA

Supplemental Characteristics (continued)

	N6783A-BAT	N6783A-MFG
Remote Sense Capability:	Outputs can maintain DC specifications with up to a 0.5-volt drop per load lead. Maximum sense lead resistance is limited to 300mΩ/lead.	
Series and Parallel Operation:	Identically rated outputs can be operated directly in parallel. N6783A modules cannot be used in series with other N6783A modules or any other N67xx module. Auto-series and auto-parallel operation is not available.	
Down-programming Capability: (Current down-programming capability is reduced at output voltages below 0.5 V)		
Continuous power	12 W	12 W
Continuous current	2 A	2 A

Output Quadrant Characteristic

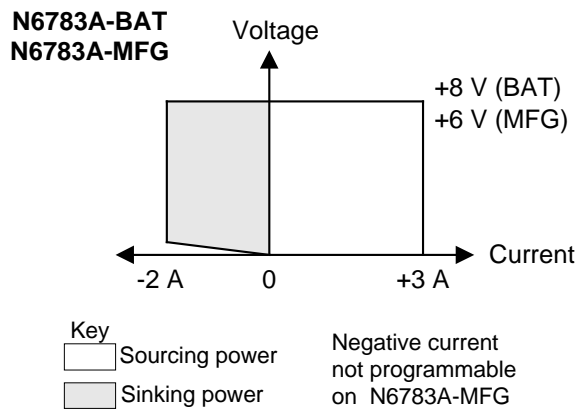

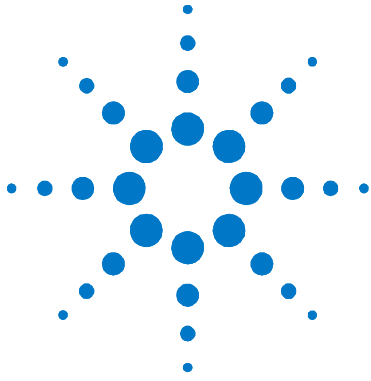

Chapter 7

Agilent N6700 Modular Power System Mainframes

Supplemental Characteristics	48
Outline Diagrams	50

Supplemental characteristics are not warranted but are descriptions of performance determined either by design or by type testing. All supplemental characteristics are typical unless otherwise noted.

NOTE

Refer to the following documents for information about using and servicing the Agilent N6700 Modular Power System Mainframes

Agilent Model N6705 DC Power Analyzer User's Guide

Go to <http://cp.literature.agilent.com/litweb/pdf/N6705-90001.pdf>.

Agilent Model N6705 DC Power Analyzer Service Guide

Go to <http://cp.literature.agilent.com/litweb/pdf/N6705-90010.pdf>.

Agilent Series N6700 Low-Profile Modular Power System User's Guide

Go to <http://cp.literature.agilent.com/litweb/pdf/5969-2937.pdf>.

Agilent Series N6700 Low-Profile Modular Power System Service Guide

Go to <http://cp.literature.agilent.com/litweb/pdf/5969-2938.pdf>.

Supplemental Characteristics

	N6700B, N6701A, N6702A	N6705A, N6705B
Maximum Power Available for Modules:		
Values represent combined power rating of all modules installed per mainframe.	400 W (for N6700B mainframes) 600 W (for N6701A mainframes) 1200 W (for N6702A mainframes)	600 W
Front Panel Output Terminals:		
Maximum current rating	N/A	20 A
BNC Trigger Connectors:		
I/O	N/A	Digital TTL level compatible
Maximum voltage	N/A	5 V
USB Current Ratings:		
Front panel USB connector	N/A	200 mA
Rear panel USB connector	N/A	300 mA
Data Storage:		
Internal flash memory	8 Mbyte	4 Gbyte (Earlier N6705 models have less memory)
Protection Response Characteristic:		
INH input	5 μ s from receipt of inhibit to start of shutdown	
Fault on coupled outputs	< 10 μ s from receipt of fault to start of shutdown	
Command Processing Time:		
	\leq 1 ms from receipt of command to start of output change	
Digital Port Characteristics:		
Maximum voltage ratings	+16.5 VDC/– 5 VDC between pins (pin 8 is internally connected to chassis ground).	
Pins 1 and 2 as FLT output	Maximum low-level output voltage = 0.5 V @ 4 mA Maximum low-level sink current = 4 mA Typical high-level leakage current = 1 mA @ 16.5 VDC	
Pins 1 - 7 as digital/trigger outputs (pin 8 = common)	Maximum low-level output voltage = 0.5 V @ 4 mA; 1 V @ 50 mA; 1.75 V @ 100 mA Maximum low-level sink current = 100 mA Typical high-level leakage current = 0.8 mA @ 16.5 VDC	
Pins 1 - 7 as digital/trigger inputs and pin 3 as INH input (pin 8 = common)	Maximum low-level input voltage = 0.8 V Minimum high-level input voltage = 2 V Typical low-level current = 2 mA @ 0 V (internal 2.2k pull-up) Typical high-level leakage current = 0.12 mA @ 16.5 VDC	
Interface Capabilities:		
GPIB	SCPI - 1993, IEEE 488.2 compliant interface	
LXI Compliance	Class C (only applies to units with LXI label on front panel)	
USB 2.0	Requires Agilent IO Library version M.01.01 or 14.0 and up	
10/100 LAN	Requires Agilent IO Library version L.01.01 or 14.0 and up	
Built-in Web server	Requires Internet Explorer 7+ or Firefox 2+	

Supplemental Characteristics (continued)

	N6700B, N6701A, N6702A	N6705A, N6705B
Regulatory Compliance:		
EMC	Complies with European EMC Directive for test and measurement products. <ul style="list-style-type: none"> ● IEC/EN 61326-1 ● CISPR 11, Group 1, class A ● AS/NZS CISPR 11 ● ICES/NMB-001 Complies with Australian standard and carries C-Tick mark. This ISM device complies with Canadian ICES-001. Cet appareil ISM est conforme à la norme NMB-001 du Canada.	
Safety	Complies with European Low Voltage Directive and carries the CE-marking. Conforms to UL 61010-1 and CSA C22.2 61010-1.	
Environmental Conditions		
Operating environment	Indoor use, installation category II (for AC input), pollution degree 2	
Temperature range	0°C to 55°C (output current is derated 1% per °C above 40°C ambient temperature)	
Relative humidity	Up to 95%	
Altitude	Up to 2000 meters	
Storage temperature	-30°C to 70°C	
Acoustic Noise Declaration:		
This statement is provided to comply with the requirements of the German Sound Emission Directive, from 18 January 1991.	Sound Pressure Lp <70 dB(A), At Operator Position, Normal Operation, According to EN 27779 (Type Test). Schalldruckpegel Lp <70 dB(A), Am Arbeitsplatz, Normaler Betrieb, Nach EN 27779 (Typprüfung).	
Output Terminal Isolation:		
Maximum rating	No output terminal may be more than ±240 VDC from any other terminal or chassis ground.	
N6781A Note	When using the AUX measurement input terminals on Model N6781A, no output or input terminal may be more than ±60 VDC from any other terminal and chassis ground.	
AC Input:		
Input Ratings	~ 100 VAC – 240 VAC; 50/60/400Hz	~ 100 VAC – 240 VAC; 50/60/400Hz
Power Consumption	1000 VA (N6700B) 1440 VA (N6701A) 1440 VA (N6702A @ < 180 VAC input) 2200 VA (N6702A @ > 180 VAC input)	1440 VA
Power Factor	0.99 @ nominal input and rated power	0.99 @ nominal input and rated power
Fuse	Internal fuse - not customer accessible.	Internal fuse - not customer accessible.
N6702A Note	AC mains circuits rated at 100-180 VAC cannot supply enough current to power the N6702A mainframe when operated at its full rated power. When connected to a 100-180 VAC mains, internal circuits will limit the power available to modules to 600 W maximum.	
Net Weight:		
Mainframe with 4 modules (typical)	N6700B 12.73 kg / 28 lbs N6701A 11.82 kg / 26 lbs N6702A 14.09 kg / 31 lbs	16 kg / 35 lbs
Single-wide power module (typical)	1.23 kg / 2.71 lbs	1.23 kg / 2.71 lbs

Dimensions:

Refer to the outline diagrams on the following page.

Outline Diagrams

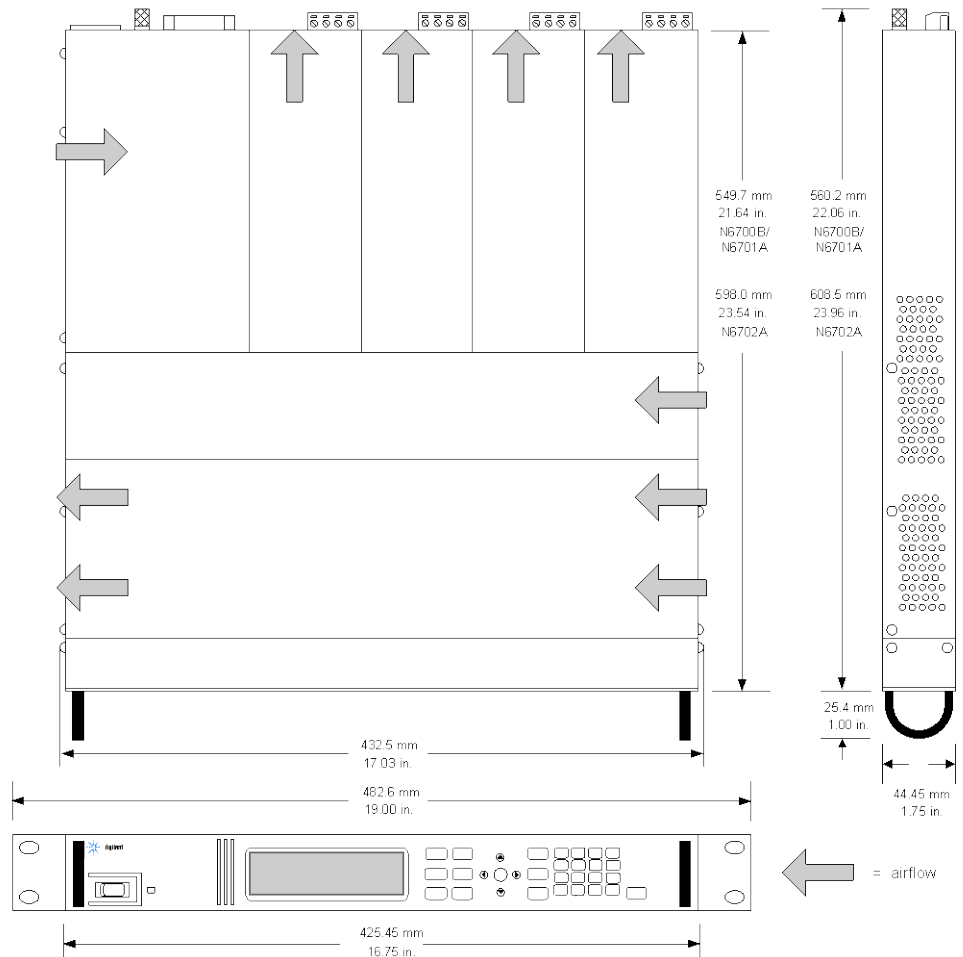
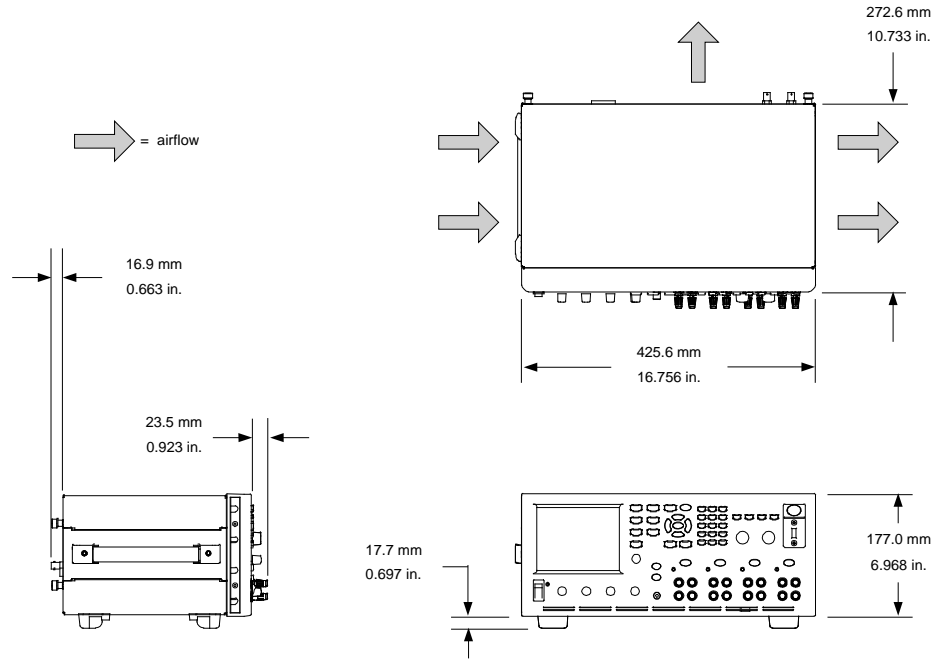

Manual Updates

The following updates have been made to this manual since its edition date.

03/20/12

The description of the Voltmeter/Ammeter Measurement Accuracy specification has been updated throughout.

The description of the Voltage Measurement Noise and Current Measurement Noise characteristic has been updated on pages 39 and 40.

The downprogrammer derating information has been updated on page 42.

06/15/12

External datalogging has been added as a feature on pages 6 and 7. Applies to N6705 firmware revision D.01.08 and up, and N6700 firmware revision. D.01.09 and up.

The CC mode graphs have been updated on pages 23 and 31.

The N6781A Auxiliary Voltage Measurement input characteristics have been updated on pages 38 and 39.

The dc output ratings have been edited to match the instrument labels.

06/30/14

The Option 054 information has been updated on page 10. The Load Effect specification for Model N6784A has been updated on page 36.