

Agilent Technologies
Modular Power System
Series N6700

User's Guide

Legal Notices

© Agilent Technologies, Inc. 2003 - 2005

No part of this document may be photocopied, reproduced, or translated to another language without the prior agreement and written consent of Agilent Technologies, Inc. as governed by United States and international copyright laws.

Warranty

The material contained in this document is provided "as is," and is subject to being changed, without notice, in future editions. Further, to the maximum extent permitted by applicable law, Agilent disclaims all warranties, either express or implied, with regard to this manual and any information contained herein, including but not limited to the implied warranties of merchantability and fitness for a particular purpose. Agilent shall not be liable for errors or for incidental or consequential damages in connection with the furnishing, use, or performance of this document or of any information contained herein. Should Agilent and the user have a separate written agreement with warranty terms covering the material in this document that conflict with these terms, the warranty terms in the separate agreement shall control.

Manual Editions

Manual Part Number: 5969-2908
Fifth Edition, January, 2005
Printed in Malaysia.

Reprints of this manual containing minor corrections and updates may have the same printing date. Revised editions are identified by a new printing date.

Certification

Agilent Technologies certifies that this product met its published specifications at time of shipment from the factory. Agilent Technologies further certifies that its calibration measurements are traceable to the United States National Institute of Standards and Technology, to the extent allowed by the Institute's calibration facility, and to the calibration facilities of other International Standards Organization members.

Exclusive Remedies

THE REMEDIES PROVIDED HEREIN ARE THE CUSTOMER'S SOLE AND EXCLUSIVE REMEDIES. AGILENT TECHNOLOGIES SHALL NOT BE LIABLE FOR ANY DIRECT, INDIRECT, SPECIAL, INCIDENTAL, OR CONSEQUENTIAL DAMAGES, WHETHER BASED ON CONTRACT, TORT, OR ANY OTHER LEGAL THEORY.

Assistance

This product comes with the standard product warranty. Warranty options, extended support contacts, product maintenance agreements and customer assistance agreements are also available. Contact your nearest Agilent Technologies Sales and Service office for further information on Agilent Technologies' full line of Support Programs.

Technologies Licenses

The hardware and or software described in this document are furnished under a license and may be used or copied only in accordance with the terms of such license.

U.S. Government Restricted Rights

Software and technical data rights granted to the federal government include only those rights customarily provided to end user customers. Agilent provides this customary commercial license in Software and technical data pursuant to FAR 12.211 (Technical Data) and 12.212 (Computer Software) and, for the Department of Defense, DFARS 252.227-7015 (Technical Data – Commercial Items) and DFARS 227.7202-3 (Rights in Commercial Computer Software or Computer Software Documentation).

Trademarks

Microsoft and Windows are U.S. registered trademarks of Microsoft Corporation.

Safety Notices

The following general safety precautions must be observed during all phases of operation of this instrument. Failure to comply with these precautions or with specific warnings or instructions elsewhere in this manual violates safety standards of design, manufacture, and intended use of the instrument. Agilent Technologies assumes no liability for the customer's failure to comply with these requirements.

General

Do not use this product in any manner not specified by the manufacturer. The protective features of this product may be impaired if it is used in a manner not specified in the operation instructions.

Before Applying Power

Verify that all safety precautions are taken. Make all connections to the unit before applying power. Note the instrument's external markings described under "Safety Symbols"

Ground the Instrument

This product is a Safety Class 1 instrument (provided with a protective earth terminal). To minimize shock hazard, the instrument chassis and cover must be connected to an electrical ground. The instrument must be connected to the ac power mains through a grounded power cable, with the ground wire firmly connected to an electrical ground (safety ground) at the power outlet. Any interruption of the protective (grounding) conductor or disconnection of the protective earth terminal will cause a potential shock hazard that could result in personal injury.

Fuses

The instrument contains an internal fuse, which is not customer accessible.

Do Not Operate in an Explosive Atmosphere

Do not operate the instrument in the presence of flammable gases or fumes.

Do Not Remove the Instrument Cover

Only qualified, service-trained personnel who are aware of the hazards involved should remove instrument covers. Always disconnect the power cable and any external circuits before removing the instrument cover.

Do Not Modify the Instrument

Do not install substitute parts or perform any unauthorized modification to the product. Return the product to an Agilent Sales and Service Office for service and repair to ensure that safety features are maintained.

In Case of Damage

Instruments that appear damaged or defective should be made inoperative and secured against unintended operation until they can be repaired by qualified service personnel.



















CAUTION

A **CAUTION** notice denotes a hazard. It calls attention to an operating procedure, practice, or the like that, if not correctly performed or adhered to, could result in damage to the product or loss of important data. Do not proceed beyond a **CAUTION** notice until the indicated conditions are fully understood and met.

WARNING

A **WARNING** notice denotes a hazard. It calls attention to an operating procedure, practice, or the like that, if not correctly performed or adhered to, could result in personal injury or death. Do not proceed beyond a **WARNING** notice until the indicated conditions are fully understood and met.

Safety Symbols

	Direct current
	Alternating current
	Both direct and alternating current
	Three phase alternating current
	Earth (ground) terminal
	Protective earth ground terminal.
	Frame or chassis terminal
	Terminal is at earth potential.
	Neutral conductor on permanently installed equipment
	Line conductor on permanently installed equipment.
	On supply
	Off supply
	Standby supply. Unit is not completely disconnected from ac mains when switch is off
	In position of a bi-stable push switch
	Out position of a bi-stable push switch
	Caution, risk of electric shock
	Caution, hot surface
	Caution, refer to accompanying description

In this Book

Specific chapters in this manual contain the following information:

- Quick Reference – Chapter 1 is a quick reference section that helps you quickly become familiar with your Agilent N6700 Modular Power System. It describes the differences between the various modules in the power system.
- Installation – Chapter 2 describes how to install your power system. It describes how to connect various loads to the output. It discusses remote sensing as well as parallel and series operation.
- Getting Started – Chapter 3 describes how to set the voltage, current, over-voltage protection, and turn on the output. It also describes how to configure the remote interface.
- Operating the Power System – Chapter 4 describes how to use the advanced features of the power system using the front panel menus and the corresponding SCPI commands.
- Introduction to Programming – Chapter 5 gives a brief overview of the SCPI command structure and basic programming concepts.
- Language Dictionary – Chapter 6 describes all of the SCPI programming commands.
- Programming Examples – Chapter 7 provides Visual Basic example programs that illustrate some common applications.
- Specifications – Appendix A describes specifications and supplemental characteristics.
- Verification and Calibration Procedures – Appendix B explains the verification and calibration procedures.
- Using the Digital Port – Appendix C describes how to configure and use the digital port on the back of the instrument.
- Service – Appendix D describes what to do if service is required.
- Compatibility – Appendix E documents the compatibility commands of the Agilent Series 662xA DC power supplies that are supported by the Agilent N6700 Modular Power System.

NOTE

You can contact Agilent Technologies at one of the following telephone numbers for warranty, service, or technical support information.

In the United States: (800) 829-4444

In Europe: 31 20 547 2111

In Japan: 0120-421-345

Or use our Web link for information on contacting Agilent in your country or specific location: www.agilent.com/find/assist

Or contact your Agilent Technologies Representative.

The web contains the most up to date version of the manual. Go to <http://www.agilent.com/find/N6700> to get the latest version of the manual.

Contents

1 Quick Reference

The Agilent N6700 Modular Power System – At a Glance.....	8
The Front Panel - At a Glance.....	10
The Rear Panel – At a Glance.....	10
Front Panel Display – At a Glance	11
Front Panel Keys – At a Glance.....	12
Front Panel Menu Reference	13

2 Installation

General Information.....	16
Inspecting the Unit	17
Installing the Unit.....	17
Connecting the Line Cord	19
Connecting the Outputs.....	20
Remote Sense Connections	24
Parallel Connections.....	25
Series Connections.....	26

3 Getting Started

Turning the Unit On	30
Selecting an Output Channel	30
Entering an Output Voltage Setting	30
Entering a Current Limit Setting	31
Enabling the Output.....	31
Using the Front Panel Menu	32
Connecting to the Interfaces	34

4 Operating the Power System

Programming the Output	46
Synchronizing Output Steps.....	49
Making Measurements	52
System Related Operations	53
Programming High-Speed Test Extensions	57

5 Introduction to Programming

SCPI Commands.....	68
SCPI Messages.....	70
SCPI Conventions and Data Formats.....	72
SCPI Command Completion	74

6 Language Dictionary	
SCPI Command Summary.....	76
Calibration Subsystem.....	80
Display Subsystem.....	82
Measurement Subsystem.....	83
Output Subsystem.....	86
Source Subsystem	89
Status Subsystem	96
System Commands	103
Trigger Subsystem	107
7 Programming Examples	
Output Programming Example.....	110
List Programming Example.....	112
Digitizer Programming Example.....	114
Appendix A Specifications	
Performance Specifications	118
Supplemental Characteristics	121
Autoranging Characteristic.....	128
Outline Diagram.....	128
Appendix B Verification and Calibration	
Verification	130
Calibration	151
Appendix C Using the Digital Port	
Digital Control Port	162
Configuring the Digital Control Port.....	166
Appendix D Service	
Returning an Instrument.....	170
Disassembly	171
Troubleshooting	176
Parts List and Parts Location.....	183
Error Messages	186
Appendix E Compatibility	
Differences – In General.....	192
Compatibility Command Summary	193
Differences in Earlier Agilent N6700A Mainframes.....	197
Index.....	201

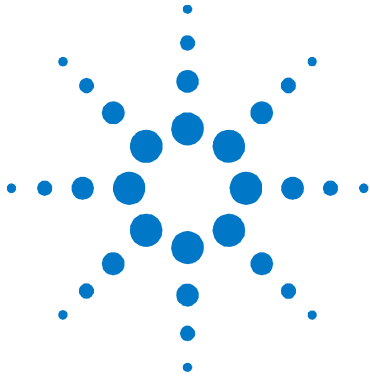

1

Quick Reference

The Agilent N6700 Modular Power System – At a Glance	8
The Front Panel - At a Glance	10
The Rear Panel – At a Glance	10
Front Panel Display – At a Glance	11
Front Panel Keys – At a Glance	12
Front Panel Menu Reference	13

This chapter concisely describes the operation of the Agilent N6700 Modular Power System (MPS).

This chapter does not describe every operating feature in detail. It is simply a quick reference guide to quickly become familiar with the essential operating features of the power system.

A quick reference programming command chart is included in the beginning of chapter 6.

NOTE

Unless otherwise noted, the Agilent N6700 Modular Power System will also be referred to as “MPS” and “power system” throughout this manual.

The Agilent N6700 Modular Power System – At a Glance

The Agilent N6700 Modular Power System is a configurable, 1U (rack unit) high platform that lets you mix and match power modules to create a power system optimized for your test system requirements.

Up to four power modules can be installed in each Agilent N6700A/B MPS mainframe. Power modules come in power levels of 50 and 100 Watts, have various voltage and current combinations, and provide the following output performance levels:

- The N675xA High-Performance, Autoranging DC Power Modules provide low noise, high accuracy, fast programming times, and advanced programming and measurement capabilities to speed test throughput.
- The N676xA Precision DC Power Modules provide precise control and measurements in the milli- and micro-ampere region with the ability to simultaneously digitize voltage and current and capture those measurements into an oscilloscope-like data buffer.
- The N673xA/B and N674xA/B DC Power Modules provide programmable voltage and current, measurement, and protection features, making these economical modules suitable for powering the device-under-test or system resources such as fixture controls.

The output and system features are described in the following sections. Not all output features are available on every power module. The “Model Differences” section describes the features that apply only to specific power modules.

Output Features

Programmable voltage and current	Full programming capability is provided for the entire range of output voltage and current. Outputs can operate as either constant voltage (CV) or constant current (CC) sources.
Fast command processing	Command processing time of less than 1 millisecond per command.
Fast up/down programming	1.5 millisecond response time from 10% to 90% of the output rating for autoranging and precision power modules. Refer to Appendix A for details.
Fast transient response	Transient response is less than 100 microseconds for autoranging and precision power modules. Refer to Appendix A for details.
Low output noise	Output noise is typically 4 mV peak-to-peak for autoranging and precision power modules, which is comparable to linear supplies. Refer to Appendix A for details.
Autoranging capability	Autoranging produces the maximum rated power over a wide and continuous range of voltage and current settings for autoranging and precision power modules. Refer to Appendix A for details.
Output On/Off sequencing	A turn-on/turn-off delay capability for each output allows output on/off sequencing.

Remote voltage sensing	Two remote sensing terminals are provided for each output. When shipped from the factory, the remote sense jumpers are included in a separate bag. Refer to Chapter 2 for details.
Voltage and current measurements	All power modules can measure their own output voltage and current.
Voltage, current, and temperature protection	Each output has over-voltage, over-current, and over-temperature protection. Over-voltage and over-current protection are programmable. When activated, the protection circuits cause the voltage to go to zero, the output to be disabled, and the protection status to be reported.

System Features

SCPI language	The instrument is compatible with the Standard Commands for Programmable Instruments (SCPI).
Choice of three interfaces	GPIB (IEEE-488), LAN, and USB (mini B) remote programming interfaces are built in.
Front panel I/O setup	Menus let you set up GPIB and LAN parameters from the front panel. Refer to Chapter 3 for details.
Built-in Web server	A built-in Web server lets you control the instrument directly from an internet browser on your computer. Refer to Chapter 3 for details.
Real-time status information	The front panel indicates the status of each output. It also indicates when a protection shut-down has occurred.
Module identification	Each module has identifying data stored in non-volatile memory. Information includes model number, serial number, and options. This information can be displayed on the front panel.

Model Differences

Feature	DC Power Modules (A+B)		Autoranging Modules		Precision Modules	
	N6731 - N6736	N6741 - N6746	N6751A	N6752A	N6761A	N6762A
Output power rating	50 W ¹	100 W ²	50 W	100 W	50 W	100 W
Autoranging output capability	NO	NO	YES	YES	YES	YES
Precision output and measurement capability	NO	NO	NO	NO	YES	YES
Low voltage output and measurement range	NO	NO	NO	NO	YES	YES
Low current output and measurement range	NO	NO	NO	NO	YES	YES
Simultaneous voltage and current measurement	NO	NO	NO	NO	YES	YES
Output list capability (Test Extensions)	NO	NO	Option	Option	YES	YES
Array readback capability (Test Extensions)	NO	NO	Option	Option	YES	YES
Programmable sample rate (Test Extensions)	NO	NO	Option	Option	YES	YES

¹Model N6735A has a maximum output of 40 W.

²Models N6742A and N6745A have a maximum output of 80 W.

The Front Panel - At a Glance

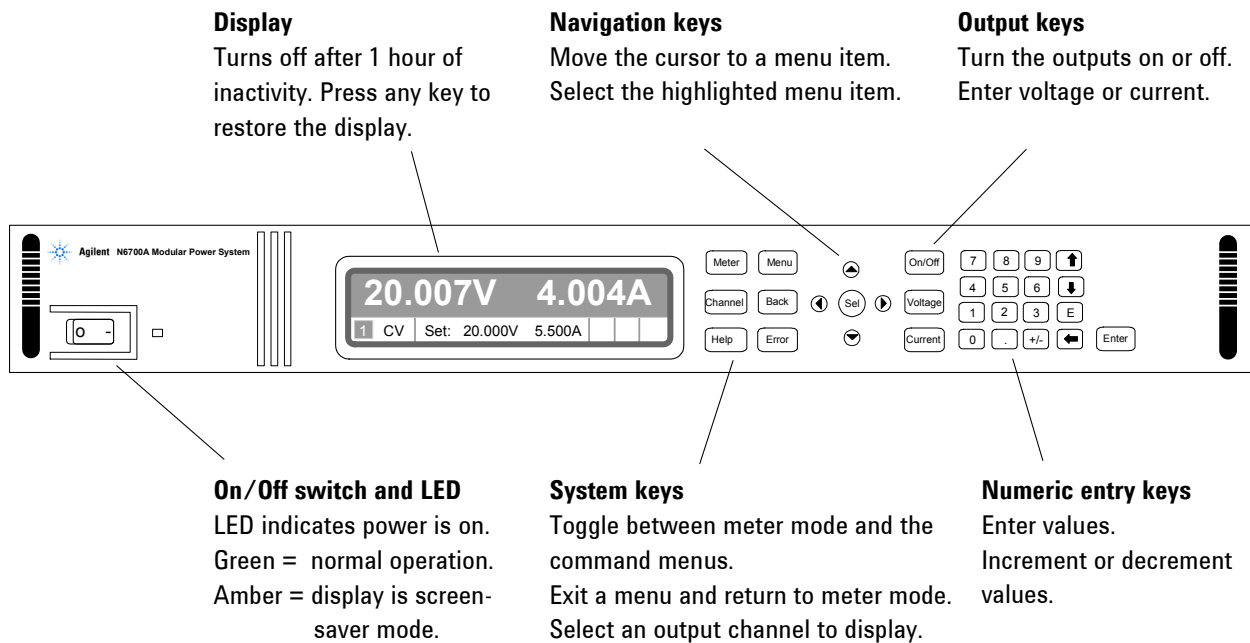

The Rear Panel – At a Glance

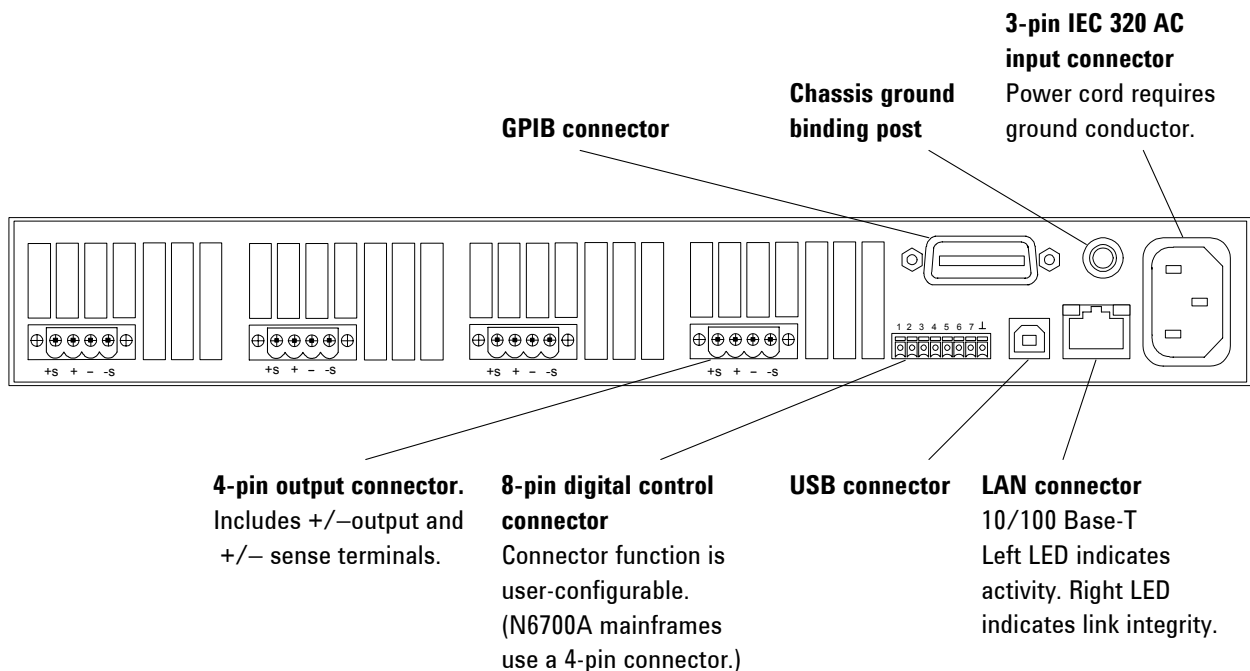

WARNING

SHOCK HAZARD The power cord provides a chassis ground through a third conductor. Be certain that your power outlet is of the three-conductor type with the correct pin connected to earth ground.

Front Panel Display – At a Glance

Single-channel View

Press the **Meter** key to toggle between views

Voltage measurement

Current measurement



Operating mode (CV = constant voltage mode)

Voltage and Current settings

Remote interface status (ALL, SRQ, ERR, IO)

Multiple-channel View

Press the **Meter** key to toggle between views

Voltage and Current measurements

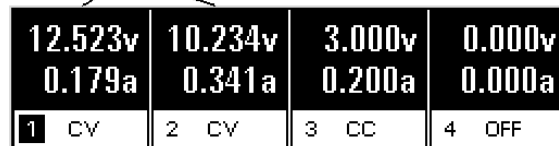

The highlighted channel is the active channel

Grouped-channel View

Refer to Chapter 4, under “System Related Operations” for more information

Channels 2 through 4 are connected in parallel and have been configured or grouped to act as a single, higher-power channel

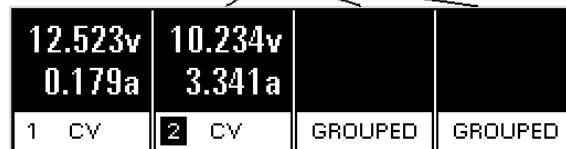

Grouped channels are addressed using the channel number of the **lowest** channel in the group

Front Panel Keys – At a Glance

System Keys



Meter returns the display to metering mode.

Menu accesses the command menu.

Channel selects or highlights a channel to control.

Back backs out of a menu without activating any changes.

Help accesses information about the displayed menu control.

Error displays any error messages in the error queue.

Navigation Keys

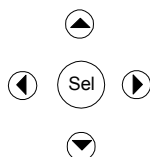

The Arrow keys let you move around in the command menus.

The Select key lets you make a selection in the command menus.

It also lets you enter edit mode for numeric parameters.

Output Keys

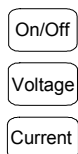

On/Off controls the selected output (or all outputs when ALL is lit).

This key is only active in Single- channel or Multiple-channel view.

Voltage lets you change the voltage setting of the selected channel.

Current lets you change the current setting of the selected channel.

Number Keys

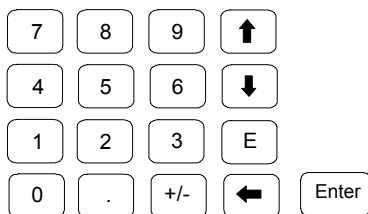

The number keys let you enter digits from 0 to 9 and a decimal point.

The minus sign is selected by the +/- key.

The exponent must be added to the right of the E symbol.

The backspace key deletes digits as it backspaces over them.

↑ ↓ arrow keys increment or decrement the value in certain fields.

They are also used to select letters in alphabetic entry fields.

The Enter key enters a value. If you exit a field without pressing the

Enter key, the value is ignored.

Front Panel Menu Reference

NOTE

Menu commands that appear grayed-out on the display are either not available for the power module that is being programmed, or are password protected. Refer to appendix E for information about the front panel menu commands for firmware revisions prior to B.00.00

Menu Command			Control Description		
Output	Voltage		Programs voltage setting and range.		
	Current		Programs current setting and range.		
	Delay		Programs Turn-on /Turn off delay.		
	Slew		Programs voltage slew rate.		
Measure	Range		Selects voltage and current measurement range.		
	Sweep		Specifies measurement points, time interval, and trigger offset.		
	Window		Selects measurement window: Rectangular, Hanning.		
	Control		Lets you abort a measurement in progress.		
Transient	Mode		Selects voltage or current transient mode: Fixed, Step, List.		
	Step		Programs voltage and current step value. Enables step triggers.		
	List	Pace		Specifies Dwell or Trigger paced list.	
		Repeat		Specifies number of list repetitions, or specifies continuous list.	
		Terminate		Specifies list settings when the list terminates.	
		Config		Configures list step voltage, current, dwell, and trigger signals.	
		Reset		Aborts the list and resets all list parameters.	
	TrigSource		Specify the trigger source: Bus, Tran 1-4, Pin 1-7.		
	Control		Initiates, Triggers, or Aborts output triggers. Displays trigger state.		
Protect	OVP		Configures over-voltage protection function.		
	OCP		Configures over-current protection function.		
	Inhibit		Configures the external inhibit signal: Off, Latching, Live		
	Coupling		Disables ALL output channels when a protection fault occurs.		
	Clear		Clears output protection. Displays output state.		
States	Reset		Resets the instrument to its reset (*RST) state.		
	SaveRecall		Saves or recalls an instrument state.		
	PowerOn		Selects the power-on state.		
System	I/O	LAN	ActiveSettings	Displays the LAN interface settings that are presently active.	
			Config	IP	Enables/disables DHCP and Auto IP. Also sets LAN addresses.
				Name	Configures the Dynamic DNS and NetBIOS naming service.
				Domain	Configures the Domain Name.
				DNS	Configures the DNS server.
				TCP	Configures the TCP keepalive function.
				Reset	Resets the LAN interface settings to the factory-shipped state.
			USB	Status	USB connect string - the instrument's unique USB identifier.
	Identification	Displays status, speed, packets received, and packets sent.			

1 Quick Reference

Menu Command		Control Description			
System	I/O	GPIB	Selects the GPIB address.		
		DigPort	Pin 1	Function Specifies the pin function: DigIO, TrigIn, TrigOut, DigIn, FaultOut. Polarity Specifies the pin polarity.	
			Pin 2	Function Specifies the pin function: DigIO, TrigIn, TrigOut, DigIn. Polarity Specifies the pin polarity.	
			Pin 3	Function Specifies the pin function: DigIO, TrigIn, TrigOut, DigIn, InhibitIn. Polarity Specifies the pin polarity.	
			Pin 4	Function Specifies the pin function: DigIO, TrigIn, TrigOut, DigIn. Polarity Specifies the pin polarity.	
			Pin 5	Function Specifies the pin function: DigIO, TrigIn, TrigOut, DigIn. Polarity Specifies the pin polarity.	
			Pin 6	Function Specifies the pin function: DigIO, TrigIn, TrigOut, DigIn. Polarity Specifies the pin polarity.	
			Pin 7	Function Specifies the pin function: DigIO, TrigIn, TrigOut, DigIn. Polarity Specifies the pin polarity.	
			Data	Sends/reads data from the digital I/O port function	
		Groups	Defines groups of output channels that are connected in parallel.		
Preferences	Display	Contrast	Configures the display contrast.		
		Saver	Configures the screen saver and wake-on I/O timer.		
		View	Selects 1-channel or 4-channel view at turn-on		
	Keys	Enables/disables key clicks and configures the On/Off key.			
	Lock	Locks front panel keys. Enter a password to unlock the front panel.			
Admin	Login/Logout		Enter a password to access the admin functions.		
	Cal	Function	VProg	High Enters measured data for the High calibration point. Low Enters measured data for the Low calibration point.	
			VMeas	Enters measured data.	
		CMRR	Calibrates common mode rejection ratio.		
		IProg	High Enters measured data for the High calibration point. Low Enters measured data for the Low calibration point.		
			IMeas	Enters measured data.	
		DPRog	Calibrates the downprogrammer.		
		IPeak	Calibrates I peak.		
		Date	Saves the calibration date for each channel.		
	Save	Saves the calibration data.			
		LAN	Enables/disables the LAN interface and the built-in Web server.		
	USB	Enables/disables the USB interface.			
	Nvram	Resets all non-volatile RAM settings to their factory defaults.			
	Password	Changes the password for the admin functions.			
About	Frame	Displays model, serial number, and firmware revisions.			
	Module	Displays model, serial number, options, voltage, current, power.			

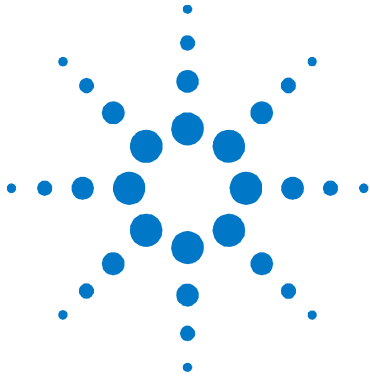

2 Installation



General Information	16
Inspecting the Unit	17
Installing the Unit	17
Connecting the Line Cord	19
Connecting the Outputs	20
Remote Sense Connections	24
Parallel Connections	25
Series Connections	26

This chapter describes how to install your power system. It discusses installation, rack mounting, and line cord connections.

This chapter discusses how to connect your load to the output terminals. It discusses what you need to know about wire sizes and how to compensate for voltage drops in the load leads. It also discusses various loads configurations and how to connect the output terminals in series and parallel.

Before installing the instrument, check the list under “Items Supplied” and verify that you have received these items with your instrument. If anything is missing, please contact your nearest Agilent Sales and Support Office.

General Information

Models

Agilent Model	Description
N6700A / N6700B	MPS Mainframe - without DC Power Modules
N6751A / N6752A	50 W / 100 W High-Performance Autoranging DC Power Module
N6761A / N6762A	50 W / 100 W Precision DC Power Module
N6731B / N6741B	50 W / 100 W 5 V DC Power Module
N6732B / N6742B	50 W / 100 W 8 V DC Power Module
N6733B / N6743B	50 W / 100 W 20 V DC Power Module
N6734B / N6744B	50 W / 100 W 35 V DC Power Module
N6735B / N6745B	50 W / 100 W 60 V DC Power Module
N6736B / N6746B	50 W / 100 W 100 V DC Power Module
N6731A	50 W 5 V DC Power Module
N6732A / N6742A	50 W / 80 W 8 V DC Power Module
N6733A / N6743A	50 W / 100 W 20 V DC Power Module
N6734A / N6744A	50 W / 100 W 35 V DC Power Module
N6735A / N6745A	40 W / 80 W 50 V DC Power Module
N6708A	Filler Module Kit (includes 3 filler modules)
N6709A	Rack Mount Kit (also available as Option 908)

Items Supplied

Item	Description	Agilent Part Number
Power Cord	A power cord appropriate for your location.	Call Agilent Sales & Support Office
Output Connector	A 4-pin connector for connecting power and remote sense leads.	1253-5826 or 1253-6211 (model N6741B only)
Sense Jumpers	Two jumpers per module for local sensing at the output connector.	8120-8821 or 0360-2935 (model N6741B only)
Digital Connector	An 8-pin connector for connecting signal lines to the digital port. (N6700A mainframes use a 4-pin connector.)	1253-6408 (8-pin) or 1253-5830 (4-pin)
Manual Set	Contains User's Guide and Product Reference CD-ROM.	5969-2916
Certificate of Calibration	A certificate of calibration referenced to the serial number.	N/A
Automation-Ready CD-ROM	Contains Agilent IO Libraries Suite.	E2094N
Filler Modules	Provided if there are less than four power modules installed.	N6708A

Options

Option	Description
054	High-speed Test Extensions. Includes digitized output measurements and output list capability. Available for Agilent Models N6751A/N6752A. Included with Agilent Models N6761A/N6762A.
761	Output relays. Includes 2 - DPDT galvanic-disconnect relays. Disconnects both output and sense terminals. Available for all Agilent Models.
908	Rack Mount Kit for mounting in a 19-inch EIA rack cabinet. Also available as Model N6709A.

Inspecting the Unit

When you receive your power system, inspect it for any obvious damage that may have occurred during shipment. If there is damage, notify the shipping carrier and nearest Agilent Sales and Support Office immediately. Refer to Appendix D for more information.

Until you have checked out the power system, save the shipping carton and packing materials in case the unit has to be returned.



Installing the Unit

Safety Considerations

This power system is a Safety Class 1 instrument, which means it has a protective earth terminal. That terminal must be connected to earth ground through a power source equipped with a ground receptacle.

Refer to the Safety Summary page at the beginning of this guide for general safety information. Before installation or operation, check the power system and review this guide for safety warnings and instructions. Safety warnings for specific procedures are located at appropriate places throughout this Guide.

Environment

WARNING

Do not operate the instrument in the presence of flammable gasses or fumes

The environmental conditions of the instrument are documented in Appendix A. Basically, the instrument should only be operated indoors in a controlled environment.

The dimensions of your instrument as well as an outline diagram are given in Appendix A. A fan cools the power system by drawing air through the sides and exhausting it out the side and back. The instrument must be installed in a location that allows sufficient space at the sides and back of the unit for adequate air circulation.

Rack Installation

Do not block the air intake and exhaust at the sides of the unit or the exhaust at the rear of the unit. Refer to the outline diagram in Appendix A.

CAUTION

You cannot use support rails for rack mounting your instrument as they would block the airflow needed for cooling. Use the Rack Mount kit (Option 908) to rack mount your instrument. The Rack Mount Kit is also available by ordering part number N6709A.

2 Installation

The Agilent N6700 MPS can be mounted in a 19-inch EIA rack cabinet. It is designed to fit in one rack unit (1U) of space. Install the rack mount kit as shown in the following figure.

- Step 1.** Install eight clip-nuts on the rack frame (2 in each corner) where your instrument will be located
- Step 2.** Install the two front ears and the two rear extender supports on the instrument as shown in the figure. Use six M3 x 8mm screws (a) for the front ears and four M3 x 6mm screws (b) for the extender supports. If the standard extender supports are either too short or too long, use the longer supports (c). Cut the supports if required (d).
- Step 3.** Install the two rear ears on the back of the instrument rack as shown in the figure. Use the four plain 10-32 screws to install the rear ears.
- Step 4.** Slide the instrument into the rack, making sure that the rear extender supports are aligned inside the rear ears.
- Step 5.** Attach the front ears to the front of the instrument rack using the four dress 10-32 screws provided.
- Step 6.** This is optional. Insert a plain 10-32 screw through the slot of the rear ear and extender support. Attach it with a clip-nut. Note that this will prevent the unit from being slid out of the front of the rack.

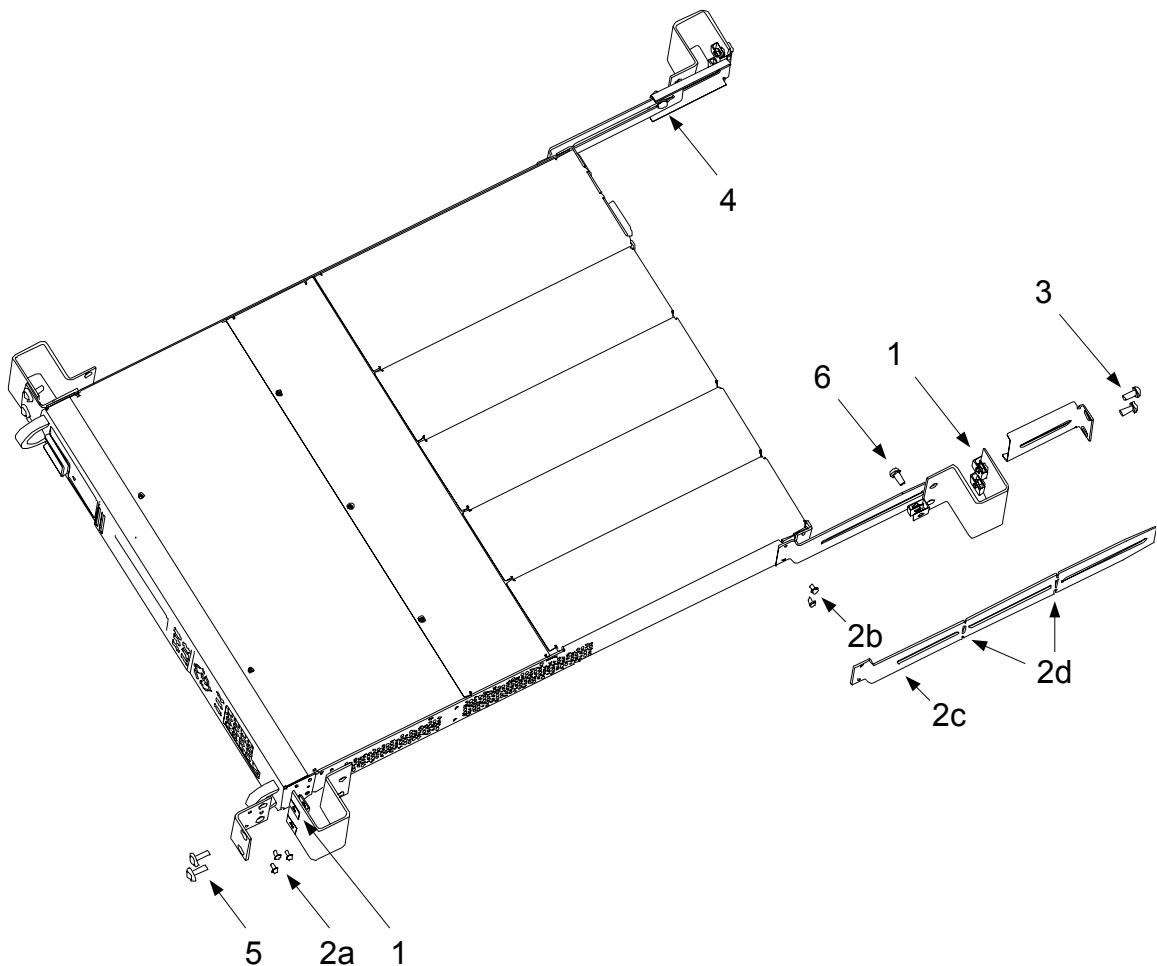

Bench Installation

Do not block the air intake and exhaust at the sides, or the exhaust at the rear of the unit. Refer to the outline diagram in Appendix A.

Minimum clearances for bench operation are 2 inches (51 mm) along the sides and back.

Channel Number

The channel number of a power module is determined by the location of that module in the mainframe. When viewed from the rear, the module next to the GPIB connector is always output channel one. Numbering continues sequentially to the left, from one to four.

If there are less than four modules, channel numbering corresponds to the actual number of installed power modules. Unused channel slots contain filler modules to ensure proper airflow for cooling.

NOTE

Power modules that are connected in parallel and have been configured or grouped to act as a single, higher-power channel, are addressed using the channel number of the **lowest** channel in the group.

Cleaning

WARNING

SHOCK HAZARD To prevent electric shock, unplug the unit before cleaning.

Use a dry cloth or one slightly dampened with water to clean the external case parts. Do not attempt to clean internally.

Connecting the Line Cord

WARNING

FIRE HAZARD Use only the power cord that was supplied with your instrument. Using other types of power cords may cause overheating of the power cord, resulting in fire.

SHOCK HAZARD The power cord provides a chassis ground through a third conductor. Be certain that your power outlet is of the three-conductor type with the correct pin connected to earth ground.

Connect the power cord to the IEC 320 connector on the rear of the unit. If the wrong power cord was shipped with your unit, contact your nearest Agilent Sales and Support Office.

The AC input on the back of your unit is a universal AC input. It accepts nominal line voltages in the range of 100 VAC to 240 VAC. The frequency can be 50 Hz, 60 Hz, or 400 Hz.

NOTE

The detachable power cord may be used as an emergency disconnecting device. Removing the power cord will disconnect ac input power to the unit.

400 Hz Operating Considerations

Power Factor

At 400 Hz operation, the unit's power factor is affected as follows:

- Under full load at 400 Hz, power factor drops from 0.99 (@120 VAC) to as low as 0.76 (@ 265 VAC)
- Power factor degrades further under no load conditions.

Redundant Ground Requirement

At 400 Hz operation, the leakage current of the unit exceeds 3.5 mA. This requires the installation of a permanent, redundant ground from the instrument chassis to earth ground. This ensures that ground will always be connected and that any leakage current will be diverted to ground. Appendix D describes how to connect the redundant ground.

Connecting the Outputs

WARNING

SHOCK HAZARD Turn off AC power before making rear panel connections. All wires and straps must be properly connected with the terminal block screws securely tightened.

Disconnect the connector plug to make your wire connections. The connector accepts wire sizes from AWG 12 to AWG 30. Note that wire sizes smaller than AWG 20 are not recommended. Each connector has four openings for attaching wires (see the figure below). Load connections are made at the + and - terminals. Sense connections are made on the +s and -s terminals. Securely fasten the wires by tightening the screw terminals.

After your wires are securely connected, insert the connector plug into the back of the unit and secure it by tightening the locking screws. A chassis ground binding post is available next to the AC input connector for your convenience.

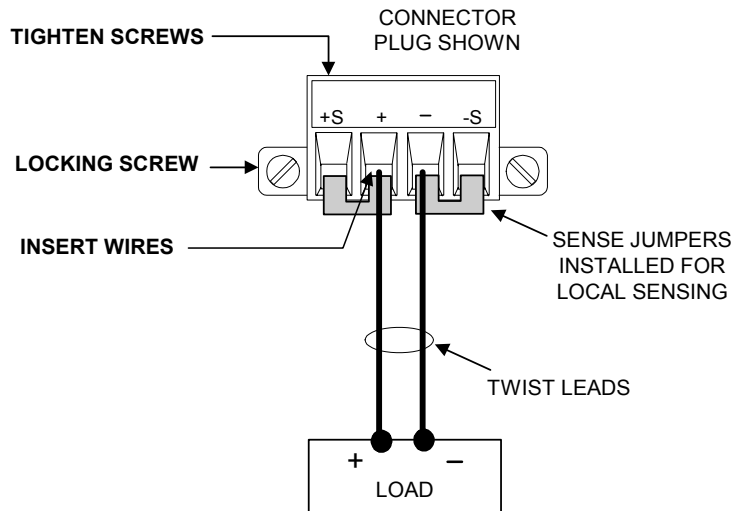

Wire Size

WARNING

FIRE HAZARD Select a wire size large enough to carry short-circuit current without overheating. To satisfy safety requirements, load wires must be heavy enough not to overheat while carrying the short-circuit output current of the unit (refer to the following chart).

Along with conductor temperature, you must also consider voltage drop when selecting wire sizes. The following chart lists the resistance for various wire sizes and the maximum lengths to limit the voltage drop to 1.0 volts for various currents.

Wire size	Current-carrying capacity (Amps)		Resistance	Max. Length to Limit Voltage to 1 V/Lead		
	2 wires bundled	4 wires bundled		for 5 A	for 10 A	for 20A
AWG	2 wires bundled	4 wires bundled	Ω/foot	Wire length in feet		
20	7.8	6.9	0.0102	20	10	5
18	14.5	12.8	0.0064	30	15	7.5
16	18.2	16.1	0.0040	50	25	12.5
14	29.3	25.9	0.0025	--	40	20
12	37.6	33.2	0.0016	--	--	30
Area in mm²	2 wires bundled	4 wires bundled	Ω/meter	Wire length in meters		
0.5	7.8	6.9	0.0401	5	2.4	1.2
0.75	9.4	8.3	0.0267	7.4	3.8	1.8
1	12.7	11.2	0.0200	10	5	2.6
1.5	15.0	13.3	0.0137	14.6	7.2	3.6
2.5	23.5	20.8	0.0082	--	12.2	6

- Notes: 1. Capacity for AWG wires derived from MIL-W-5088B. Max. ambient temp: 55°C. Max. wire temp: 105°C.
 2. Capacity for metric wires are derived from IE Publication 335-1.
 3. Capacity of aluminum wire is approximately 84% of that listed for copper wire.
 4. Because of wire inductance considerations, it is recommended that you keep your load leads twisted, tie wrapped, or bundled together and less than 50 feet (14.7 meters) in length per lead.

Note that the minimum wire size required to prevent overheating as shown in the above chart may not be large enough to prevent OV trip and to maintain good regulation. Under most conditions, the load wires should be heavy enough to limit the voltage drop to no more than 1.0 V per lead.

NOTE

To help prevent nuisance tripping of the over-voltage circuit, select a wire size sufficient to handle the FULL output current of the unit no matter what the intended load current or current limit setting

Load lead resistance is an important factor relating to the CV stability of the instrument when remote sensing capacitive loads. If high capacitance loads are expected, you should not use wire gauges heavier than 12 to 14 AWG for long runs of load lead.

Multiple Loads

If you are using local sensing and are connecting multiple loads to one output, connect each load to the output terminals using separate connecting wires (see the figure below). This minimizes mutual coupling effects and takes full advantage of the power system's low output impedance. Each pair of wires should be as short as possible and twisted or bundled to reduce lead inductance and noise pickup.

If load considerations require the use of distribution terminals that are located away from the instrument, connect the output terminals to the remote distribution terminals by a pair of twisted or bundled wires. Connect each load to the distribution terminals separately. Remote voltage sensing is recommended under these circumstances. Sense either at the remote distribution terminals or, if one load is more sensitive than the others, directly at the critical load.

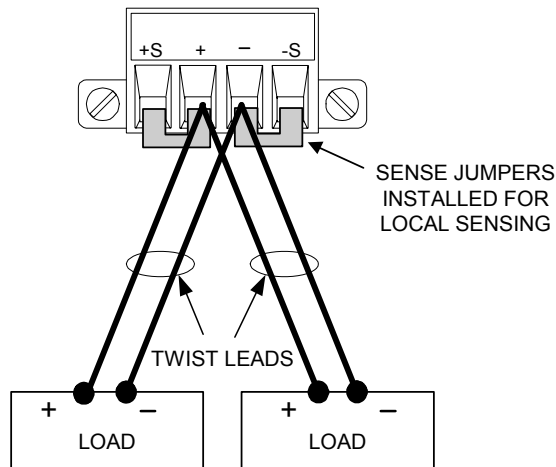

Positive and Negative Voltages

Either positive or negative voltages can be obtained from the output by grounding (or "commoning") one of the output terminals. Always use two wires to connect the load to the output regardless of where or how the system is grounded. The instrument can be operated with any output terminal ± 240 VDC including output voltage from ground.

Response Time with an External Capacitor

When programming with an external capacitor, voltage response time may be longer than that specified in Appendix A. Use the following formula to estimate the additional response time for up programming:

$$\text{Response Time} = \frac{(\text{Added Output Capacitor}) \times (\text{Change in } V_{\text{out}})}{\text{Current Limit Setting}}$$

Note that programming into an external output capacitor may cause the power system to briefly enter constant current or constant power operating mode, which adds additional time to the estimation.

Remote Voltage Sensing

Because of the unavoidable voltage drop developed in the load leads, the terminal block strapping patterns discussed thus far do not provide the best possible voltage regulation at the load. The remote sensing connections shown in the figure below improve the voltage regulation at the load by monitoring the voltage there instead of at the output terminals. This allows the power system to automatically compensate for the voltage drop in the load leads.

Remote sensing is especially useful for CV operation with load impedances that vary or have significant lead resistance. It has no effect during CC operation. Because sensing is independent of other power system functions, remote sensing can be used regardless of how the power system is programmed. Note that with remote sensing, the voltage readback circuit monitors the load voltage through the sense terminals.

NOTE

The OVP circuit senses at the main output terminals and not through the sense terminals. Due to the voltage drop in the load leads, the voltage sensed by the OVP circuit could be higher than the voltage being regulated at the load. Therefore, you must take into account the additional voltage drop in the load leads when setting the over-voltage trip point.

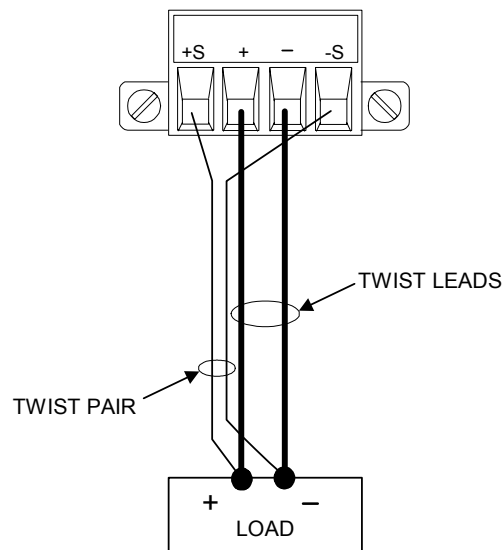

Remote Sense Connections

Remember to turn off the power system before making or changing any connections on the rear panel terminal blocks. Connect the unit for remote sensing by first disconnecting the straps between sense and load terminals. Make your connections as shown in the previous figure. Connect the sense leads as close to the load as possible. Refer to the “Wire Size” section for information about selecting the proper wire size. Best results are obtained by using the shortest load leads practical. It is recommended that you keep your load leads under 14.7 meters (50 feet) per lead because of inductance effects.

The sense leads carry only a few milliamperes of current and therefore, can be lighter gauge than the load leads. However, note that any voltage drop in the sense leads can degrade the voltage regulation of the instrument. Try to keep the sense lead resistance less than about 0.5Ω per lead (this requires 20 AWG or heavier for a 50 foot length).

Open Sense Leads

The sense leads are part of the output's feedback path. Connect them in such a way so that they do not inadvertently become open circuited. The power system includes protection resistors that reduce the effect of open sense leads during remote-sensing operation. If the sense leads open during operation, the power system returns to the local sensing mode, with the voltage at the output terminals approximately 1% higher than the programmed value.

Output Noise Considerations

Any noise picked up on the sense leads will appear at the output terminals and may adversely affect CV load regulation. Twist the sense leads or use a ribbon cable to minimize the pickup of external noise. In extremely noisy environments it may be necessary to shield the sense leads. Ground the shield at the power system end only; do not use the shield as one of the sensing conductors.

The noise specifications in Appendix A apply at the output terminals when using local sensing. However, voltage transients may be produced at the load by noise induced in the leads or by load current transients acting on the inductance and resistance of the load lead. If it is desirable to keep voltage transient levels to a minimum, place an aluminum or a tantalum capacitor, with an approximate value of $10\ \mu\text{F}$ per foot (30.5cm) of load lead, right across the load.

Parallel Connections

CAUTION

Only connect outputs that have identical voltage and current ratings in parallel.

Connecting outputs in parallel provides a greater current capability than can be obtained from a single output.

The following figures show how to connect two outputs in parallel. The figure on the left illustrates local sensing. If voltage drop in the load leads is a concern, the figure on the right shows how to connect the sense leads directly at the load. Note that in both cases, the remote sense terminals must be connected together.

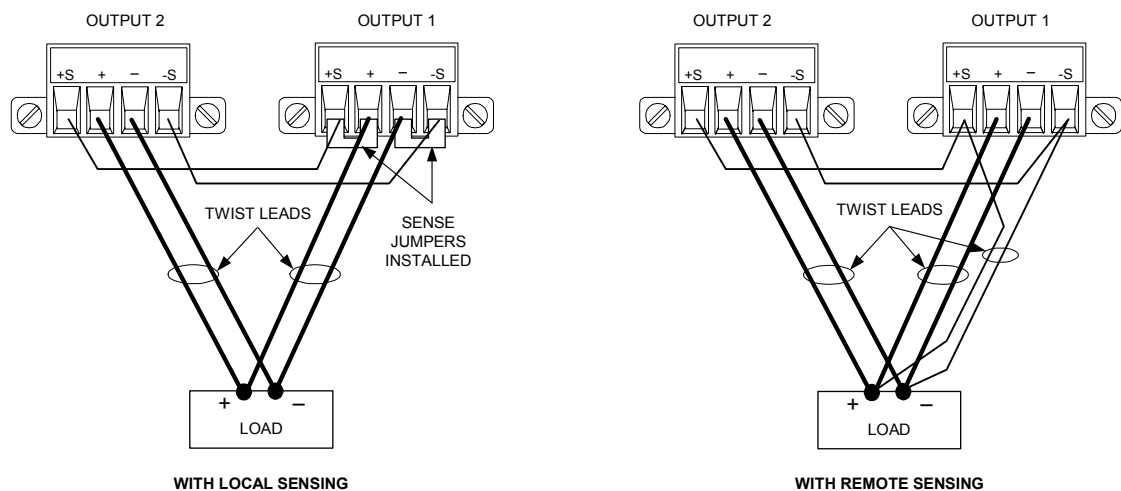

Grouping the Outputs

Once outputs have been connected in parallel, they can be configured or “grouped” to act as a single, higher-power channel. This applies when programming via the front panel or using SCPI commands. Information about how to group output channels that have been connected in parallel is provided in Chapter 4 under “System Related Operations” as well as Chapter 6 under “System Commands”.

NOTE

The ability to group outputs is only available on Agilent N6700 MPS mainframes with firmware revision B.00.00 and up. Almost all instrument functionality is supported by grouped channels, including voltage and current programming, measurements, status, step transients, and list transients.

To program paralleled outputs on units with earlier version firmware, first program both outputs to the desired output voltage. Then program the current limit point of each output. The current limit of the paralleled outputs will be the sum of both individual current limit points.

Effect on Specifications

Specifications for outputs operating in parallel can be obtained from the specifications for single outputs. Most specifications are expressed as a constant or as a percentage (or ppm) plus a constant. For parallel operation, the percentage portion remains unchanged while constant portions or any constants are changed as indicated below. For current readback accuracy and temperature coefficient of current readback, use the minus current specifications:

Current All parallel specifications referring to current are twice the single output specification except for programming resolution, which is the same for both single output and parallel output operation.

Voltage All parallel specifications referring to voltage are the same as for a single output except for CV load effect, CV load cross regulation, CV source effect, and CV short term drift. These are all twice the voltage programming accuracy (including the percentage portion) at all operating points.

Load Transient Recovery Time Load transient specifications are typically twice the single output.

Series Connections

WARNING

SHOCK HAZARD Floating voltages must not exceed 240 VDC. No output terminal may be more than 240 VDC from chassis ground.

CAUTION

Only connect outputs that have identical voltage and current ratings in series. Each output has reverse voltage protection diodes across its output terminals. The current conducted by this diode is not internally limited by the output. Never connect an output in such a way that the diodes will conduct current in excess of the rated current of the output since damage could result.

Connecting outputs in series provides a greater voltage capability than can be obtained from a single output. Because the current is the same through each element in a series circuit, outputs connected in series must have equivalent current ratings.

The following figure shows an example of how to connect two outputs in series to a single load with local sensing. Connecting the + S terminal of output 2 to the - S terminal of output 1 and removing the sense jumper (between + S and + V) on output 2 compensates for the IR drop in the load lead from output 2 to output 1.

If voltage drop in the load leads is a concern, connect the sense leads of output 1 and output 2 for remote sensing as shown in the figure on the right. Note that the + sense lead of output 2 must remain connected to the -sense terminal of output 1. The outputs may be set as previously described.

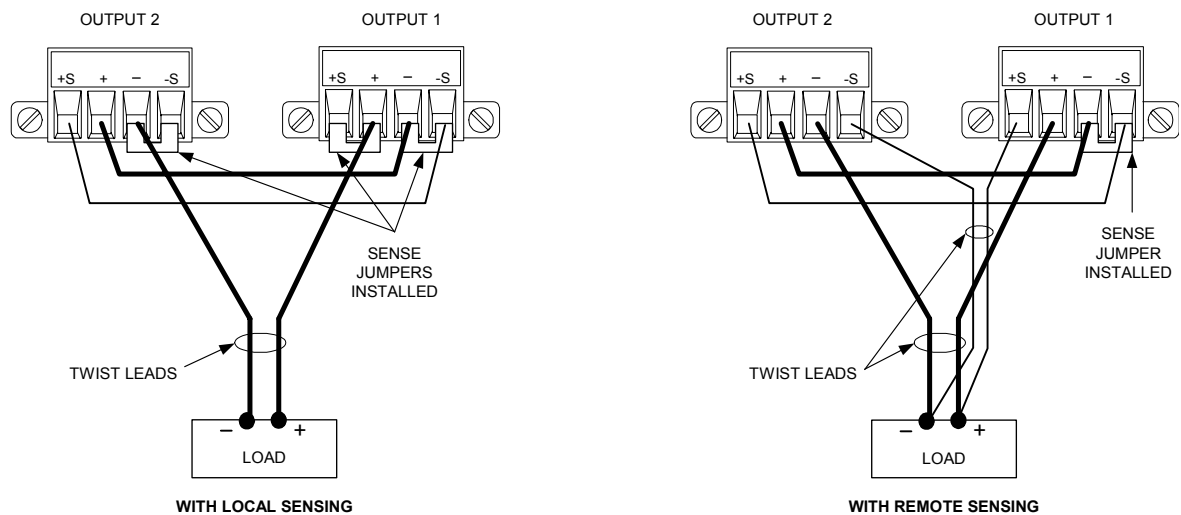

Setting the Outputs

Outputs connected together in series cannot be grouped.

To program outputs connected in series, first program the current limit of each output to the total desired current limit point. Then program the voltage of each output so that the sum of both voltages equals the total desired operating voltage. The simplest way to accomplish this is to program each output to one half of the total desired operating voltage.

NOTE

The operating mode of each output channel is determined by the channel's programmed settings, operating point, and load condition. Because these conditions may change during parallel operation, the status annunciators on the front panel will reflect these changes. This is normal. Momentary status changes are also normal.

Effect on Specifications

Specifications for outputs operating in series can be obtained from the specifications for single outputs. Most specifications are expressed as a constant or a percentage (or ppm) plus a constant. For series operation, the percentage portion remains unchanged while constant portions or any constants are changed as indicated.

Voltage All series specifications referring to voltage are twice the single output specification except for programming resolution, which is the same as for a single output.

Current All series specifications referring to current are the same as for a single output except for CC load effect, CC load cross regulation, CC source effect, and CC short term drift which are twice the current programming accuracy (including the percentage portion).

Load Transient Recovery Time Load transient specifications are typically twice the single output.

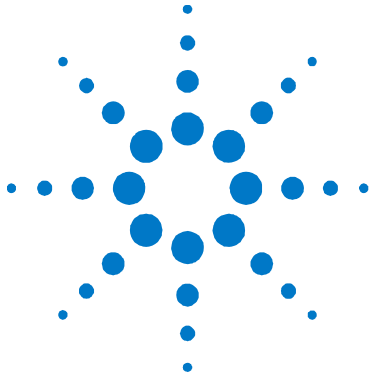

3

Getting Started

Turning the Unit On	30
Selecting an Output Channel	30
Entering an Output Voltage Setting	30
Entering a Current Limit Setting	31
Enabling the Output	31
Using the Front Panel Menu	32
Connecting to the Interfaces	34

This chapter describes how to get started using your power system. It discusses turning the unit on, using the front panel controls, and navigating the front panel command menu. A map of the front panel menu structure is found in chapter 1.

This chapter also contains information on how to configure the three remote interfaces that are provided on the back of the instrument.

NOTE

Detailed information on configuring the remote interfaces is included in the Agilent Technologies *USB/LAN/GPIB Interfaces Connectivity Guide*, which is available on the Automation-Ready CD-ROM included with this product.

Turning the Unit On

After you have connected the line cord, turn the unit on with the front panel power switch. The front panel display will light up after a few seconds.

A *power-on* self-test occurs automatically when you turn the unit on. This test assures you that the instrument is operational. If the self-test fails, the Err annunciator comes on. Press the Error key to display the list of errors on the front panel. Refer to Appendix D for further information.

When the front panel display appears, you can use the front panel controls to enter voltage and current values.

Selecting an Output Channel

Channel

Press the Channel key to select the output channel that you wish to program.

Entering an Output Voltage Setting

Method 1 – Use the Navigation and Arrow Keys

Navigation Keys

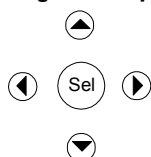

Use the left and right navigation keys to navigate to the setting that you wish to change. In the display below, channel 1's voltage setting is selected. Enter a value using the numeric keypad. Then press Enter.



Arrow Keys



You can also use the arrow keys to adjust the value up or down. When the output is on and the unit is operating in CV mode, the output voltage changes immediately. Otherwise, the value will become effective when the output is turned on.

Method 2 - Use the Voltage key to enter a value

Voltage

Use the **Voltage** key to select the voltage entry field. In the display below, channel 1's voltage setting is selected. Enter the desired setting using the numeric keypad. Then press Enter.

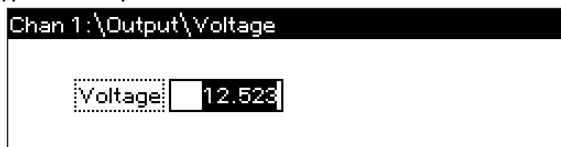

NOTE

If you make a mistake, either use the **←** backspace key to delete the number, press **Back** to back out of the menu, or press **Meter** to return to meter mode.

Entering a Current Limit Setting

Method 1 – Use the Navigation and Arrow Keys

Navigation Keys

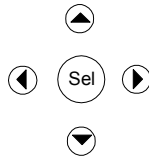

Use the left and right navigation keys to navigate to the setting that you wish to change. In the display below, channel 1's current setting is selected. Enter a value using the numeric keypad. Then press Enter.



Arrow Keys



You can also use the arrow keys to adjust the value up or down. When the output is on and the unit is operating in CC mode, the output current changes immediately. Otherwise, the value will become effective when the output is turned on.

Method 2 - Use the Current key to enter a value

Current

Use the **Current** key to select the current entry field. In the display below, channel 1's voltage setting is selected. Enter the desired setting using the numeric keypad. Then press Enter.

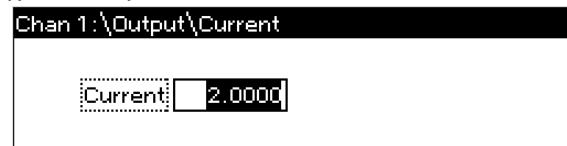

NOTE

If you make a mistake, either use the **←** backspace key to delete the number, press **Back** to back out of the menu, or press **Meter** to return to meter mode.

Enabling the Output

Use the On/Off key to enable the output

On/Off

If a load is connected to the output, the front panel display will indicate that it is drawing current. Otherwise, the current reading will be zero. The status indicator next to the channel number indicates the output's status. In this case, the output channel is in constant voltage mode.



NOTE

For a complete description of the status indicators, refer to Chapter 6 under "STATus:OPERation:EVENT?" and "STATus:QUEStionable:EVENT?"

Using the Front Panel Menu

The front panel command menu lets you access most of the power system's functions. The actual function controls are located at the lowest menu level. Briefly:

- Press the **Menu** key to access the command menu.
- Press the navigation keys to move across the menu commands.
- Press the center (**Sel**) key to select a command and move down to the next level in the menu.
- Press the **Help** key at the lowest menu level to display help information about the function controls.

A map of the front panel command structure is found in chapter 1. The following example shows you how to navigate the front panel command menu to program the over-voltage protection function.

Set the Over-Voltage Protection

The over-voltage protection function turns off the affected output if the output voltage reaches the programmed over-voltage limit.

Menu

Press the **Menu** key to access the front panel command menu.

The first line identifies the output channel that is being controlled followed by the menu path. Since the top level is displayed, the path is empty.

The second line indicates the commands that are available at the present menu level. In this case, the top-level menu commands are shown, with the Output command highlighted.

The third line indicates which commands are available under the Output command. The output command must be selected to access the next level.

```
Chan 1:\
Output Measure Transient Protect States System
Voltage, Current, Delay
```

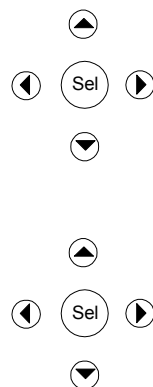

Press the right arrow ► navigation key to traverse the menu until the Protect command is highlighted. Press the **Sel** key to select the Protect command.

```
Chan 1:\
Output Measure Transient Protect States System
OVP, OCP, Inhibit, Coupling, Clear
```

The menu path now shows that the commands shown on the second line are located under the Protect command. The OVP command is highlighted. The third line indicates which functions are located under the OVP command.

Press the **Sel** key to select the OVP command.

```
Chan 1:\Protect
OVP OCP Inhibit Coupling Clear
Overvoltage protection settings.
```

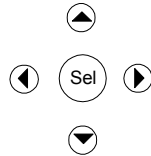
The command menu is now at the function control level. This is the lowest level in this path.

Use the navigation keys to highlight the OVP Level control as shown below. Enter the desired over-voltage level using the numeric keypad. Then press Enter.

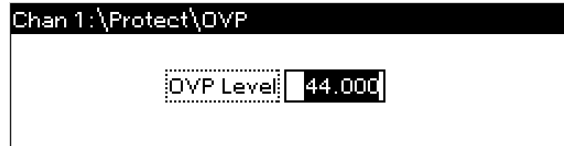

Channel

Press the Channel key at any time to select a different output channel. This can save time because you can directly access the OVP control of each channel without having to navigate through the menu levels.

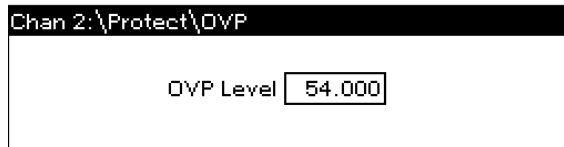

NOTE

If you program an over-voltage protection level that is lower than the present output voltage, the over-voltage protection circuit will trip and turn the output channel off. The status indicator will show OV.

Exiting the Command Menu

There are two ways to exit the command menu.

Meter

Press the Meter key to immediately return to the metering screen. This is the quickest way to return to metering mode.

Back

Press the Back key to back up one level at a time in the command menu. This method may be more convenient if there are other menu commands to be given.

Detailed instructions on how to use the power system's functions and capabilities are found in the next chapter. Detailed information about the SCPI programming commands are found in chapters 5 and 6.

In Case of Trouble

Press the **Help** key to obtain additional help about any function control menu level. Press the **Back** key to exit the Help menu.

The **Err** annunciator comes on if the self-test fails, or if other operating problems occur with your instrument. Press the **Error** key to display the list of errors. Refer to Appendix D for further information.

The **SRQ** annunciator comes on if the instrument is requesting service. Refer to Chapter 6 under "Status Subsystem" for more information about the conditions that can generate a service request.

Connecting to the Interfaces

CAUTION

Electrostatic discharges greater than 1 kV near the interface connectors may cause the unit to reset and require operator intervention.

The Agilent N6700 MPS supports GPIB, LAN, and USB interfaces. All three interfaces are live at power-on. The IO annunciator on the front panel comes on whenever there is activity on the remote interfaces.

GPIB Interface

NOTE

For detailed information about GPIB interface connections, refer to the Agilent Technologies *USB/LAN/GPIB Interfaces Connectivity Guide*, located on the Automation-Ready CD-ROM that is shipped with your product.

The following steps will help you quickly get started connecting your instrument to the General Purpose Interface Bus (GPIB). The following figure illustrates a typical GPIB interface system.

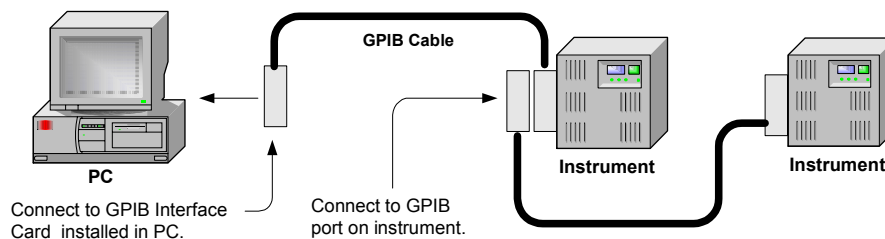

- 1 If you have not already done so, install the Agilent IO Libraries Suite from the Automation-Ready CD-ROM that is shipped with your product.
- 2 If you do not have a GPIB interface card installed on your computer, turn off your computer and install the GPIB card.
- 3 Connect your instrument to the GPIB interface card using a GPIB interface cable.
- 4 Use the Connection Expert utility of the Agilent IO Libraries Suite to configure the installed GPIB interface card's parameters.
- 5 The power system is shipped with its GPIB address set to 5. Use the front panel menu if you need to change the GPIB address.
 - a Press the **Menu** key, then use the navigation keys to select **System\I/O\GPIB**.
 - b Use the numeric keys to enter a new value. Valid addresses are from 0 to 30. Press the **Enter** key to enter the value. Press the **Meter** key to exit the menu.
- 6 You can now use Interactive IO within the Connection Expert to communicate with your instrument, or you can program your instrument using the various programming environments.

USB Interface

NOTE

For detailed information about USB interface connections, refer to the Agilent Technologies *USB/LAN/GPIB Interfaces Connectivity Guide*, located on the Automation-Ready CD-ROM that is shipped with your product.

The following steps will help you quickly get started connecting your USB-enabled instrument to the Universal Serial Bus (USB). The following figure illustrates a typical USB interface system.

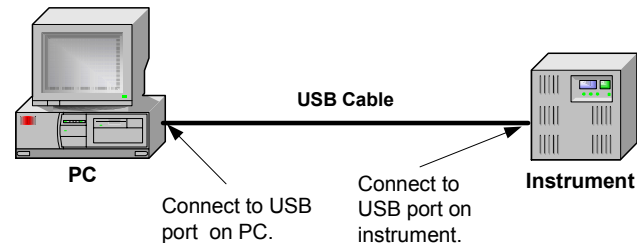

- 1 If you have not already done so, install the Agilent IO Libraries Suite from the Automation-Ready CD-ROM that is shipped with your product.
- 2 Connect your instrument to the USB port on your computer.
- 3 With the Connection Expert utility of the Agilent IO Libraries Suite running, the computer will automatically recognize the instrument. This may take several seconds. When the instrument is recognized, your computer will display the VISA alias, IDN string, and VISA address. This information is located in the USB folder.
- 4 Note that you can also view the instrument's VISA address from the front panel. Press the **Menu** key, then use the navigation keys to select **System\I/O\USB\Identification**.
- 5 You can now use Interactive IO within the Connection Expert to communicate with your instrument, or you can program your instrument using the various programming environments.

LAN Interface

NOTE

For detailed information about LAN interface connections, refer to the Agilent Technologies *USB/LAN/GPIB Interfaces Connectivity Guide*, located on the Automation-Ready CD-ROM that is shipped with your product.

The following steps will help you quickly get started connecting and configuring your instrument on a local area network (LAN). The two types of local area networks connections that are discussed in this section are site networks and private networks.

Connecting to a Site LAN

A site LAN is a local area network in which LAN-enabled instruments and computers are connected to the network through routers, hubs, and/or switches. They are typically large, centrally-managed networks with services such as DHCP and DNS servers.

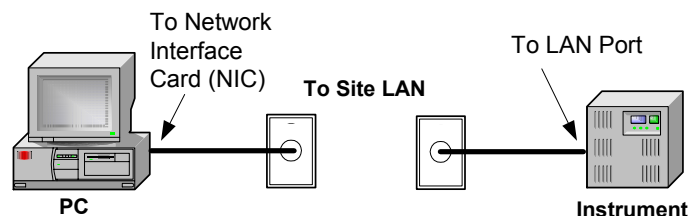

- 1 If you have not already done so, install the Agilent IO Libraries Suite from the Automation-Ready CD-ROM that is shipped with your product.
- 2 Connect the instrument to the site LAN. The factory-shipped instrument LAN settings are configured to automatically obtain an IP address from the network using a DHCP server (DHCP is set On). This may take one or two minutes. The DHCP server will register the instrument's hostname with the dynamic DNS server. The hostname as well as the IP address can then be used to communicate with the instrument.

NOTE

If you need to manually configure any instrument LAN settings, refer to "Configuring the LAN Parameters" later in this chapter for information about configuring the LAN settings from the front panel of the instrument.

- 3 Use the Connection Expert utility of the Agilent IO Libraries Suite to add the N6700 power system and verify a connection. To add the instrument, you can request the Connection Expert to discover the instrument. If the instrument cannot be found, you can add the instrument using the instrument's hostname or IP address.

NOTE

If this does not work, refer to the chapter on "Troubleshooting Guidelines" in the Agilent Technologies *USB/LAN/GPIB Interfaces Connectivity Guide*.

- 4 You can now use Interactive IO within the Connection Expert to communicate with your instrument, or you can program your instrument using the various programming environments. You can also use the Web browser on your computer to communicate with the instrument as described under "Using the Web Server" later in this chapter.

Connecting to a Private LAN:

A private LAN is a network in which LAN-enabled instruments and computers are directly connected, and not connected to a site LAN. They are typically small, with no centrally-managed resources.

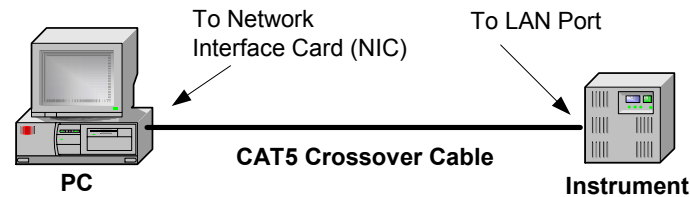

- 1 If you have not already done so, install the Agilent IO Libraries Suite from the Automation-Ready CD-ROM that is shipped with your product.
- 2 Connect the instrument to the computer using a LAN crossover cable. Alternatively, connect the computer and the instrument to a standalone hub or switch using regular LAN cables.

NOTE

Make sure your computer is configured to obtain its address from DHCP and that NetBIOS over TCP/IP is enabled. Note that if the computer had been connected to a site LAN, it may still retain previous network settings from the site LAN. Wait one minute after disconnecting it from the site LAN before connecting it to the private LAN. This allows Windows to sense that it is on a different network and restart the network configuration. If you are running Windows 98, you may need to manually release the previous settings.

- 3 The factory-shipped instrument LAN settings are configured to automatically obtain an IP address from a site network using a DHCP server. You can leave these settings as they are. Most Agilent products and most computers will automatically choose an IP address using auto-IP if a DHCP server is not present. Each assigns itself an IP address from the block 169.254.nnn. Note that this may take up to three minutes.

NOTE

Turning off DHCP reduces the time required to fully configure a network connection when the power system is turned on. To manually configure the instrument LAN settings, refer to "Configuring the LAN Parameters" later in this chapter.

- 4 Use the Connection Expert utility of the Agilent IO Libraries Suite to add the N6700 power system and verify a connection. To add the instrument, you can request the Connection Expert to discover the instrument. If the instrument cannot be found, you can add the instrument using the instrument's hostname or IP address.

NOTE

If this does not work, refer to the chapter on "Troubleshooting Guidelines" in the Agilent Technologies *USB/LAN/GPIB Interfaces Connectivity Guide*.

- 5 You can now use Interactive IO within the Connection Expert to communicate with your instrument, or you can program your instrument using the various programming environments. You can also use the Web browser on your computer to communicate with the instrument as described under “Using the Web Server” later in this chapter.

LAN Parameters

Viewing the Currently Active LAN Settings

To view the currently active LAN settings, press the **Menu** key, then use the navigation keys to select: **System\I/O\LAN\ActiveSettings**.

The currently active settings for the IP Address, Subnet Mask, and Default Gateway may be different from the front panel configuration menu settings - depending on the configuration of the network. If the settings are different, it is because the network has automatically assigned its own settings. The values entered in the configuration menu will be used during reboot if DHCP is OFF or is unavailable.

Configuring the LAN Parameters

NOTE

The power system must be rebooted for any LAN parameter modifications to take effect.

As shipped from the factory, the power system’s pre-configured settings should work in most LAN environments. If you need to manually configure these settings, press the **Menu** key, then use the navigation keys to select: **System\I/O\LAN\Config**.

In the **Config** menu you can then select from the following items: IP, Name, Domain, DNS, TCP, and Reset. Note that the Reset command resets the LAN settings to the factory-shipped state.

Select **IP** to configure the addressing of the instrument. The configurable parameters include:

- Enable DHCP** This parameter allows Dynamic Host Configuration Protocol (DHCP) to be enabled or disabled. DHCP is a protocol for assigning dynamic addresses to devices on a network. If DHCP is enabled (On), the instrument will try to obtain an IP address from a DHCP server. If a DHCP server is found, the DHCP server will assign an IP address, Subnet Mask and Default Gateway to the instrument. If DHCP is disabled (Off) or unavailable, the instrument will try to obtain an IP address using AutoIP.

NOTE

For improved performance when connected to a private LAN, turning off DHCP will reduce the time that the power system requires when it is turned on to fully configure a network connection. This normally takes several minutes.

Enable AutoIP	This parameter allows automatic IP addressing to be enabled or disabled. AutoIP automatically assigns addresses on networks that do not have a DHCP server. If AutoIP is enabled (On), an IP address, Subnet Mask and Default Gateway will automatically be assigned to the instrument. If AutoIP is disabled (Off), the instrument uses the IP Address, Subnet Mask and Default Gateway specified in the following fields during power-on.
IP Address	This value is the Internet Protocol (IP) address of the instrument. An IP address is required for all IP and TCP/IP communications with the instrument. An IP Address consists of 4 decimal numbers separated by periods. Each decimal number ranges from 0 through 255.
Subnet Mask	This value is used to enable the instrument to determine if a client IP address is on the same local subnet. When a client IP address is on a different subnet, all packets must be sent to the Default Gateway.
Default Gateway	This value is the IP Address of the default gateway that allows the instrument to communicate with systems that are not on the local subnet, as determined by the subnet mask setting. A value of 0.0.0.0 indicates that no default gateway is defined.

Select **Name** to configure the hostname of the instrument. If you want to change the hostname, you should do so before you connect the instrument to the network. Otherwise, the original hostname may be cached in the network for up to several hours. The configurable parameters include:

Hostname	This field registers the supplied name with the selected naming service. If the field is left blank, then no name is registered. A hostname may contain upper and lower case letters, numbers and dashes(-). The maximum length is 15 characters. Use the navigation keys to enter an alpha character. Use the up/down navigation or arrow keys to select a letter from the alphabetic choices as you scroll through the selections. Use the number keys to enter a number.
-----------------	-----------------------------------------------------------------------------------------------------------------------------------------------------------------------------------------------------------------------------------------------------------------------------------------------------------------------------------------------------------------------------------------------------------------------------------------------------------------------------

Each power system is shipped with a default hostname with the format: A-modelnumber-serialnumber, where *modelnumber* is the mainframe's 6-character model number (e.g. N6700B), and *serialnumber* is the last five characters of the 10-character mainframe serial number located on the label on the top of the unit (e.g. 45678 if the serial number is MY12345678).

A-N6700B-45678 is an example of a hostname.

Use Dynamic DNS naming service Registers the hostname using the Dynamic DNS naming system.

Use NetBIOS naming service Registers the hostname using the RFC NetBIOS naming protocol.

Select **Domain** if your DNS server requires an instrument to register not only the hostname, but also the domain name.

Domain name Registers the Internet domain for the instrument. The Domain must start with a letter and may contain upper and lower case letters, numbers, dashes(-) and dots(.). Use the navigation keys to enter an alpha character. Use the up/down navigation or arrow keys to select a letter from the alphabetic choices as you scroll through the selections. Use the number keys to enter a number.

Select **DNS** to configure the Domain Name System (DNS) setup of the instrument. DNS is an internet service that translates domain names into IP addresses. It is needed for the instrument to find and display its hostname assigned by the network.

Obtain DNS server from DHCP Select this item to obtain the DNS server address from DHCP. You must have enabled DHCP in the IP menu.

Use the following DNS server Select this item if you are not using DHCP or need to connect to a specific DNS server.

DNS Server This value is the address of the DNS server. It is used if you are not using DHCP or if you need to connect to a specific DNS server.

NOTE

For improved performance when connected to an isolated subnet, select **Use the following DNS server**. However, leave the **DNS server** address field blank.

Select **TCP** to configure the TCP keepalive settings of the instrument

Enable TCP Keepalive Check the Enable box to enable the TCP keepalive function. The instrument uses the TCP keepalive timer to determine if a client is still reachable. If there has been no activity on the connection after the specified time, the instrument will send keepalive probes to the client to determine if it is still alive. If not, the connection will be marked as down or "dropped." The instrument will release any resources that were allocated to that client.

TCP keepalive timeout This is the delay in seconds before TCP keepalive probes will be sent to the client. It is recommended that the largest value be used that still meets the application's need for unreachable client detection. Smaller keepalive timeout values will generate more keepalive probes (network traffic), using more of the available network bandwidth. Allowed values: 720 - 99999 seconds.

Communicating over the LAN

The Agilent IO Libraries Suite along with instrument drivers for specific programming environments can be used to communicate with your power system. You can also communicate with your power system using its built-in Web server, the Telnet utility, or sockets. These latter methods are a convenient way to communicate with the power system without using I/O libraries or drivers.

Using the Web Server

Your power system has a built-in Web server that lets you control it directly from an internet browser on your computer. With the Web server, you can access the front panel control functions including the LAN configuration parameters.

NOTE

The built-in Web server only operates over the LAN interface. It requires Internet Explorer 5+ or Netscape 6.2+. You also need the Java (Sun) plug-in. This is included in the Java Runtime Environment. Refer to Sun Microsystem's website.

The Web server is enabled when shipped. To launch the Web server:

- 1 Open the internet browser on your computer.
- 2 In the Tools menu, under Internet Options, select Connections, then LAN Settings, and make sure that the Bypass proxy server for local addresses box is checked.
- 3 Enter the instrument's hostname or IP address into the browser's Address field to launch the Web server. The following home page will appear:



- 4 Click on the Browser Web Control button in the navigation bar on the left to begin controlling your instrument.
- 5 For additional help about any of the pages, click on the Help with this Page button.

Using Telnet

In an MS-DOS Command Prompt box type: *telnet hostname 5024* where *hostname* is the N6700 hostname or IP address, and 5024 is the instrument's telnet port.

You should get a Telnet session box with a title indicating that you are connected to the power system. Type the SCPI commands at the prompt.

Using Sockets

Agilent instruments have standardized on using port 5025 for SCPI socket services. A **data socket** on this port can be used to send and receive ASCII/SCPI commands, queries, and query responses. All commands must be terminated with a newline for the message to be parsed. All query responses will also be terminated with a newline. The power system allows any combination of up to three simultaneous data socket and telnet connections to be made.

The socket programming interface also allows a **control socket** connection. The control socket can be used by a client to send device clear and to receive service requests. Unlike the data socket, which uses a fixed port number, the port number for a control socket varies and must be obtained by sending the following SCPI query to the data socket: SYSTem:COMMunicate:TCPip:CONTRol?

After the control port number is obtained, a control socket connection can be opened. As with the data socket, all commands to the control socket must be terminated with a newline, and all query responses returned on the control socket will be terminated with a newline.

To send a device clear, send the string "DCL" to the control socket. When the power system has finished performing the device clear it echoes the string "DCL" back to the control socket.

Service requests are enabled for control sockets using the Service Request Enable register. Once service requests have been enabled, the client program listens on the control connection. When SRQ goes true the instrument will send the string "SRQ +nn" to the client. The "nn" is the status byte value, which the client can use to determine the source of the service request.

Securing the Interfaces

Enable/Disable the USB, LAN, and Web Server

The USB interface, LAN interface, and the Web server are enabled when shipped.

To enable or disable the USB interface from the front panel, press the **Menu** key and select **System\Admin\USB**.

Enable USB Check this box to enable the USB.
Uncheck this box to disable the USB.

To enable or disable the LAN interface or Web server, press the **Menu** key and select the following menu commands: **System\Admin\LAN**.

Enable LAN Check this box to enable the LAN. Uncheck this box to disable the LAN.

Enable Web Server Check this box to enable the Web server. Uncheck this box to disable the Web server. The LAN must be enabled in order to enable the Web server.

If you cannot access the Admin menu, it may be password protected.

Password-Protecting the Interfaces, Factory Settings, and Calibration

You can password-protect access to the LAN and USB interfaces as well as the non-volatile RAM reset and the calibration functions. This capability is available in the **System\Admin** menu.

As shipped from the factory, the Admin menu password is 0 (zero). This means that you do not have to enter a password to access the Admin menu. Simply select **System\Admin>Login** and press Enter.

To password-protect the Admin menu, select **System\Admin>Password**. The password must be numeric, and up to 15 digits long. When done, log out of the Admin menu to activate the password. You can now only enter the Admin menu by providing the right password.

If the password is lost, access can be restored by setting an internal switch to reset the password to 0. If the message “Locked out by internal switch setting” or “Calibration is inhibited by switch setting” appears, the internal switch is set to prevent the password from being changed (Refer to Appendix D).

Non-volatile Factory Settings

Remote interface settings are stored in non-volatile memory. The factory-shipped interface settings documented in the following table are optimized for connecting your power system to a site network. They should also work well for other network configurations.

These factory-shipped LAN settings can be restored by selecting the Reset control in the **System\I/O\LAN\Config\Reset** menu.

All non-volatile settings including LAN, can be restored by selecting the Reset control located in the **System\Admin\Nvram** menu.

Factory-shipped non-volatile LAN settings			
DHCP	Enabled	Hostname	A-N6700B-xxxxx
AutoIP	Enabled	Use DNS naming service	Enabled
IP Address	169.254.67.0	Use NetBIOS naming service	Enabled
Subnet Mask	255.255.0.0	Domain Name	Blank
Default Gateway	0.0.0.0	TCP keepalive	Enabled
Obtain DNS server from DHCP	Enabled	TCP keepalive seconds	1800
DNS server	Blank		
Other factory-shipped non-volatile settings			
Admin/Calibration password	0 (zero)	On/Off key affects all channels	Disabled
Calibration date	March 5, 2003	Output Inhibit mode	Off
Channel grouping	No groups	Saved states	*RST command
Digital port function (all pins)	Digital In	Screen contrast	50%
Digital port polarity (all pins)	Positive	Screen saver	Enabled
Front panel lockout	Disabled	Screen saver delay	60 minutes
Front panel meter view	1-channel	USB interface	Enabled
GPIB Address	5	Wake on I/O	Enabled
Key clicks	Enabled	Web server	Enabled
LAN interface	Enabled		

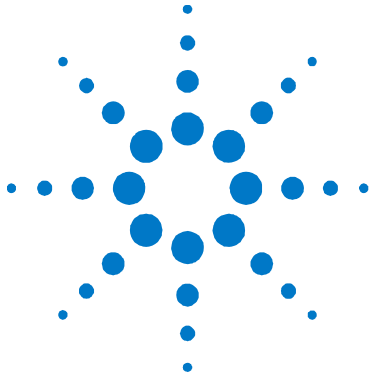

4 Operating the Power System

Programming the Output	46
Synchronizing Output Steps	49
Making Measurements	52
System Related Operations	53
Programming High-Speed Test Extensions	57

This chapter contains examples on how to operate your power system from the front panel and over the remote interface using SCPI commands. Refer to Chapters 5 and 6 for more information on programming your power system using SCPI commands.

The simple examples discussed in this chapter show you how to program:

- output voltage and current functions
- protection functions
- internal and external triggers
- measurement functions
- system functions

NOTE

This chapter shows what front panel menu controls as well as what SCPI commands are used to perform a particular function. Programming examples in the Visual Basic programming environment are provided in chapter 7.

Programming the Output

Select an Output Channel

Front Panel:	SCPI Command:
Press the Channel key to select an output channel.	Enter the selected channel(s) in the command's parameter list. (@1, 2)

Set the Output Voltage

Front Panel:	SCPI Command:
Press the Voltage key. Enter a value and press Select.	To set output 1 to 5 V: VOLT 5, (@1) To set all outputs to 10 V: VOLT 10, (@1:4)

For models with multiple ranges, you can select a lower range if you need better output resolution.

Front Panel:	SCPI Command:
Press the Voltage key. Select Low range and press Select.	To select the lower range, program a value that falls within the range: VOLT:RANG 5, (@1)

Set the Voltage Slew Rate

NOTE

The ability to program the voltage slew rate is only available on Agilent N6700 MPS mainframes with firmware revision B.00.00 and up.

Front Panel:	SCPI Command:
Select Output \ Slew Enter a slew rate in the Voltage Slew Rate field. Enter the value in volts/second. Check MAX to program the fastest slew rate.	To set the slew rate to 5 V/s VOLT:SLEW 5, (@1) To set the fastest slew rate: VOLT:SLEW MAX, (@1)

When MAXimum or INFinity is selected, the slew rate will be limited by the analog performance of the output circuit. Also, the slowest or MINimum slew rate is a function of the full-scale voltage range. Refer to Chapter 6 under "VOLTage:SLEW" for more information.

Set the Output Current

Front Panel:	SCPI Command:
Press the Current key. Enter a value and press Select.	To set output 1 to 1 A: CURR 1, (@1) To set all outputs to 2 A: CURR 2, (@1:4)

For models with multiple ranges, you can select a lower range if you need better output resolution.

Front Panel:	SCPI Command:
Press the Current key. Select Low range and press Select.	To select the lower range, program a value that falls within the range: CURR:RANG 1, (@1)

Enable the Output

Front Panel:	SCPI Command:
To enable the selected output, press the On/Off key.	To enable only output 1: OUTP ON, (@1)
To enable/disable ALL outputs with the On/Off key, select System\Preferences\Keys . Check On/Off affects all channels. The ON/Off key will now be active on ALL output channels.	To enable outputs 1-4: OUTP ON, (@1:4)

Because of internal circuit start-up procedures and any installed relay options, output on may take between 35 and 50 milliseconds to complete its function. Conversely, output off may take between 20 and 25 milliseconds to complete its function.

To mitigate these built-in delays, you can program the output to zero volts rather than using the output on/off function.

Sequence Multiple Outputs

You can specify a turn-on and turn-off delay to control the power-up and power-down sequencing of the output channels in relation to each other.

Front Panel:	SCPI Command:
Press the Channel key to select an output. Then select Output\Delay . Select either Turn-on or Turn-off. Enter a delay in seconds, then press Select.	To program a 50 millisecond turn-on delay for output 1 and a 100 millisecond turn-on delay for output 2: OUTP:DEL:RISE .05, (@1) OUTP:DEL:RISE .1, (@2)
Select System\Preferences\Keys . Check On/Off affects all channels.	To program a 200 millisecond turn-off delay for outputs 3 and 4: OUTP:DEL:FALL .2, (@3,4)

Output channel turn-on and turn-off characteristics vary across the three module types - DC Power, Autoranging, and Precision (Refer to Chapter 1, “Model Differences”). When output channels of the **same** module type are programmed on-to-off or off-to-on, output sequencing is precisely determined by the programmed delays.

However, when outputs of **different** module types are sequenced, there may be an additional offset of a few milliseconds from one output to another. This offset is the same for each module type and is repeatable. Once you have characterized this offset, using an oscilloscope for example, you can adjust the programmed delays to compensate for the offset and give the desired output sequencing.

Outputs within the same module type can also have an offset if one model has output relays (Option 761) and another does not. These offsets are also repeatable and can be compensated for by adjusting the programmed delay values.

Set the Over-Voltage Protection

The over-voltage protection function turns off the affected output if the output voltage reaches the programmed over-voltage limit.

Front Panel:	SCPI Command:
Select Protect\OVP . Enter a value in the OVP level box and press Select.	To set the OVP level for outputs 1 and 2 to 10 V: VOLT:PROT 10, (@1, 2)

Set the Over-Current Protection

When over-current protection is enabled, the power system will turn off its output if the output current reaches the current limit setting.

Front Panel:	SCPI Command:
Select Protect\OCP . Check the OCP enable box and press Select.	To enable OCP for outputs 1 and 2: CURR:PROT:STAT 1, (@1, 2)

Clear Output Protection Functions

If an over-voltage, over-current, over-temperature, inhibit signal, or a power-fail condition occurs, the power system turns off the affected output channel. The PROT annunciator on the front panel will be on. To clear the protection function and restore normal operation, first remove that condition that caused the protection fault.

Then, clear the protection function as follows:

Front Panel:	SCPI Command:
Select Protect\Clear . Select the Clear button.	To clear a protection fault on output 1: OUTP:PROT:CLE (@1)

Synchronizing Output Steps

The transient system lets you step the output voltage and current up or down in response to triggered events. To generate a triggered output step you must:

1. Enable the output to respond to trigger commands.
2. Set the voltage or current trigger levels.
3. Select the transient trigger source.
4. Initiate the trigger system and provide a trigger signal.

Enable the Output to Respond to Trigger Commands

First, you must enable the output to respond to trigger commands. Unless an output is enabled to respond to triggers, nothing will happen even if you have programmed a trigger level and generated a trigger for the output.

Use the following commands to enable an output to respond to triggers:

Front Panel:	SCPI Command:
Select Transient\Mode . For voltage step triggering, set the Voltage mode to Step. For current step triggering, set the Current mode to Step. Then press Select.	To enable the voltage function on output 1 to respond to triggers, use: VOLT:MODE STEP, (@1) To enable the current function on output 1 to respond to triggers, use: CURR:MODE STEP, (@1)

NOTE

In Step mode, the triggered value becomes the immediate value when the trigger is received. In Fixed mode, trigger signals are ignored; the immediate values remain in effect when a trigger is received.

Set the Voltage or Current Trigger Levels

Next, use the following commands to program an output trigger level. The output will go to this level when the trigger is received.

If you have a model that has multiple ranges, the selected triggered voltage and current settings must be within the **same** range that the output channel is presently operating in.

Front Panel:	SCPI Command:
Select Transient\Step . Select the Trig Voltage box to set the voltage. Select the Trig Current box to set the current. Enter a value and press Select.	To set a voltage and current trigger level for output 1 use: VOLT:TRIG 15, (@1) CURR:TRIG 1, (@1)

Select the Transient Trigger Source

NOTE

An immediate trigger command either from the front panel or over the bus will generate an immediate trigger regardless of the trigger source.

Unless you are using the front panel menu or a TRIG:TRAN command to trigger the output, select a trigger source from the following:

Bus	Selects GPIB device trigger, *TRG, or <GET> (Group Execute Trigger).
Pin <number>	Selects a pin on the external port connector as the trigger source. The selected pin must be configured as a Trigger Input in order to be used as a trigger source (see Appendix C)
Transient <channel>	Selects the output channel's transient system as the trigger source. <channel> specifies the channel. When you select a channel, you must also set up that channel's transient system to generate a trigger out signal. Refer to "Generating a Transient Trigger Signal".

Use the following commands to select a trigger source:

Front Panel:	SCPI Command:
To select Bus triggers, select Transient\TrigSource . Select Bus.	To select Bus triggers for output 1: TRIG:TRAN:SOUR BUS, (@1)
To select Digital pin triggers, select Transient\TrigSource . Then select one of the digital port pins.	To select Digital pin triggers: TRIG:TRAN:SOUR PIN<n>, (@1) where n is the pin number.
To select Transient output triggers, select Transient\TrigSource . Then select one of the output channels.	To select Transient output triggers: TRIG:TRAN:SOUR TRAN<n>, (@1) where n is the output channel that will generate the trigger signal.

Initiate the Transient Trigger System

Next, you must initiate or enable the transient trigger system.

When the power system is turned on, the trigger system is in the idle state. In this state, the trigger system is disabled, ignoring all triggers. Initiating the trigger system moves it from the idle state to the initiated state, which enables the power system to receive triggers. To initiate the trigger system, use:

Front Panel:	SCPI Command:
Select the Transient\Control . Scroll to Initiate and press Select.	To initiate the output trigger system for all four outputs: INIT:TRAN (@1:4)

After a trigger is received and the action completes, the trigger system returns to the idle state. Thus, it will be necessary to enable the system each time a triggered action is desired.

Trigger the Output

The trigger system is waiting for a trigger signal in the initiated state. You can immediately trigger the output as follows:

Front Panel:	SCPI Command:
Select Transient\Control . Select Trigger to generate an immediate trigger signal regardless of the trigger source setting.	To generate an immediate trigger on channel 1: TRIG:TRAN (@1) Alternatively, if the trigger source is BUS, you can also program a *TRG or an IEEE-488 <get> command

When a trigger is received, the triggered functions are set to their programmed trigger levels. When the triggered actions are completed, the trigger system returns to the idle state.

As previously discussed, a trigger can also be generated by another output channel or by a trigger signal applied to an input pin on the digital port connector. If any of these systems are configured as the trigger source, the instrument will wait indefinitely for the trigger signal. If the trigger does not occur, you must manually return the trigger system to the idle state.

The following commands return the trigger system to the idle state:

Front Panel:	SCPI Command:
Select the Transient\Control . Scroll to and select Abort.	ABOR:TRAN (@1)

Generating Trigger Out Signals

Each output channel can generate trigger signals that can be used by other output channels, or routed to a pin on the digital port that has been configured as a trigger output (TOUT). Use the following commands to program transient trigger signals that are generated when an output Step occurs:

Front Panel:	SCPI Command:
Use the Channel key to select the channel that is the trigger source. Select Transient\Step . Check Enable Trigger Output. Then press Select.	To program channel 3's step function to generate a trigger signal, use STEP:TOUT ON, (@3)

Making Measurements

Each output channel has its own measurement capability. The output voltage and current is measured by acquiring a number of samples at the selected time interval, applying a window function to the samples, and *averaging* the samples.

The power-on and *RST time interval and number of samples settings yield a measurement time of 21 milliseconds per reading (1024 data points at 20.48 μ s intervals). The output windowing function is Rectangular. Use the following commands to make a measurement:

Front Panel:	SCPI Command:
Select the Meter key.	To measure the average output voltage or current, use: MEAS : VOLT? (@1 : 4) MEAS : CURR? (@1 : 4)

Simultaneous Voltage and Current Measurements

Some models have simultaneous voltage and current measurement capability (Refer to Chapter 1, “Model Differences”). In this case BOTH voltage and current are acquired on any measurement, regardless of the parameter that is being measured. To return both values of a simultaneous measurement:

Front Panel:	SCPI Command:
Not available.	First, measure the output voltage (or current): MEAS : VOLT? (@1 : 4) Then Fetch the other parameter: FETC : CURR? (@1 : 4)

Measurement Ranges

Some models have two voltage and current measurement ranges. (Refer to Chapter 1, “Model Differences”). Selecting a lower measurement range provides greater measurement accuracy, provided that the measurement does not exceed the range.

Front Panel:	SCPI Command:
Select Measure\Range . Select the desired voltage or current range and press Select.	SENS : CURR : RANG 0.1, (@1) SENS : VOLT : RANG 5, (@1)

The maximum current that can be measured is the maximum rating of the range. Two examples of programming measurement ranges are:

- 0.1 A range** To select, program values $\leq 0.1A$.
- 3 A range** To select, program values $> 0.1A$ and $\leq 3A$.

System Related Operations

Self-Test

A *power-on* self-test occurs automatically when you turn on the power system. This test assures you that the instrument is operational. If the self-test is successful, the power system will continue to operate normally. If the self-test fails, the Err annunciator comes on. Press the Error key to display the list of errors on the front panel. Refer to Appendix D for further information.

Front Panel:	SCPI Command:
Cycle power.	*TST?

Instrument Identification

For Agilent N6700 MPS mainframes, you can return the model number, serial number, firmware revision, backup and active firmware. For power modules, you can return the model number, serial number, installed options, voltage, current and power rating.

Front Panel:	SCPI Command:
Select System\About\Frame .	*IDN?
or	SYST:CHAN:MOD? (@1)
Select System\About\Module .	SYST:CHAN:OPT? (@1)
	SYST:CHAN:SER? (@1)

Instrument State Storage

The power system has two storage locations in non-volatile memory to store instrument states. The locations are numbered 0 and 1. Any state previously stored in the same location will be overwritten.

Front Panel:	SCPI Command:
Select States\SaveRecall .	To save a state:
In the SaveRecall field, enter a location from 0 to 1, and press Select. Select Save to save the state or Recall to recall a state.	*SAV <n>
	To recall a state:
	*RCL <n>

When shipped from the factory, the power system is configured to automatically recall the reset (*RST) settings at power-on. However, you can configure the power system to use the settings stored in memory location 0 at power-on.

Front Panel:	SCPI Command:
Select States\PowerOn .	OUTP:PON:STAT RCL0
Select Recall State 0, then press Select.	

Output Groups

NOTE

The ability to group outputs is only available on Agilent N6700 MPS mainframes with firmware revision B.00.00 and up.

Output channels can be configured or “grouped” to create a single output with higher current and power capability. Almost all instrument functionality is supported by grouped channels, including voltage and current programming, measurements, status, step transients, and list transients. The following conditions apply when channels are grouped:

- Up to four output channels can be grouped per mainframe.
- Output channels that are grouped must also be connected in parallel as described in chapter 2.
- Grouped channels do not have to be adjacent, but they must have identical model numbers and options installed.
- The maximum output current is the sum of the maximum of each channel in the group.
- Low current measurement ranges should not be used with grouped channels, otherwise a measurement overload error will occur. Low current output ranges, however, *can* be used.
- Over-current protection delay has a slightly slower response time (~10 ms) and slightly less resolution than an ungrouped channel.
- When output channels have been grouped, they are addressed using the channel number of the **lowest** channel in the group. This is also referred to as the base channel.

Front Panel:	SCPI Command:
Select System\Groups . In the matrix that appears, select the channels you want to group. Each row defines a separate group.	To configure a group of channels: SYST:GRO:DEF (@2, 3, 4) This groups channels 2 through 4. To address the group, use channel 2.

To return grouped channels back to an ungrouped state, first remove the parallel connections between channels and proceed as follows:

Front Panel:	SCPI Command:
Select System\Groups . In the matrix, place each output channel in its own separate group.	To ungroup all channels: SYST:GRO:DEL:ALL

Reboot the unit for the grouping or ungrouping changes to take effect.

Front Panel:	SCPI Command:
Cycle AC power.	SYST:REB

Front Panel Keys

Lockout

NOTE

The ability to lock the front panel from the front panel is only available on Agilent N6700 MPS mainframes with firmware revision B.00.00 and up.

You can lock the front panel keys to prevent unwanted control of the instrument from the front panel. This is the most secure way of locking the front panel keys because you need a password to unlock the front panel. The lockout setting is saved in non-volatile memory so that the front panel remains locked even after AC power is cycled.

If the password is lost, a SCPI command is available to reset the front panel lockout password. Refer to Chapter 6 under “SYSTem:PASSword:FPANel:RESet” for more information.

Front Panel:	SCPI Command:
Select System\Preferences\Lock In the dialog box, enter the password that will be required to unlock the front panel. Then select Lock. The menu to unlock the front panel appears every time a key is pressed. Enter the password to unlock the front panel.	Not Available

NOTE

SCPI commands can also lock and unlock the front panel. The SCPI commands are completely independent of the front panel lockout function. If you use SCPI commands to lock the front panel, the front panel will be unlocked when AC power is cycled. Refer to chapter 6 under “SYST:COMM:RLST RWLock”.

Keys

You can enable or disable the front panel key clicks.

Front Panel:	SCPI Command:
Select System\Preferences\Keys Check Enable key clicks to enable key clicks. Uncheck to disable key clicks.	Not Available

You can configure the On/Off key to enable or disable ALL outputs.

Front Panel:	SCPI Command:
Select System\Preferences\Keys . Check On/Off key affects all channels. The ON/Off key will now be active on ALL output channels.	Not Available

Front Panel Display

Screen Saver

The power system has a front panel screen saver that significantly increases the life of the LCD display by turning it off during periods of inactivity. As shipped from the factory, the screen saver comes on one hour after activity on the front panel or interface has ceased.

When the screen saver is active, the front panel display turns off, and the LED next to the Line switch changes from green to amber.

To restore the front panel display, simply press one of the front panel keys. The first action of the key turns the display on. Subsequently, the key will revert to its normal function.

If the Wake on I/O function is selected, the display is restored whenever there is activity on the remote interface. This also resets the timer on the screen saver. As shipped, Wake on I/O is active.

Front Panel:	SCPI Command:
Select System\Preferences\Display\Saver Enable or disable the screen saver by checking or unchecking the Screen Saver checkbox. Then Press Select. Enter a value in minutes in the Saver Delay field to specify the time when the screen saver will activate. Check Wake on I/O to activate the display with I/O bus activity.	Not Available.

Contrast

You can set the contrast of the front panel display to compensate for ambient lighting conditions. The contrast can be set from 0% to 100% in increments of 1%. As-shipped, the contrast is set to 50%.

Front Panel:	SCPI Command:
Select System\Preferences\Display\Contrast Enter a contrast value in the Contrast box. Then Press Select.	Not available.

View

You can specify how the output channels are displayed at turn on.

Front Panel:	SCPI Command:
Select System\Preferences\Display\View Check 1-channel to display channel one. Check 4-channel to display all channels.	Not available.

Programming High-Speed Test Extensions

NOTE

The High-Speed Test Extensions described in this section are not available on all models (Refer to Chapter 1, “Model Differences”).

The List Function

Either output voltage or output current, or both together, may be list-controlled. List mode lets you generate complex sequences of output changes with rapid, precise timing, which may be synchronized with internal or external signals. Lists can contain up to 512 individually programmed steps and can be programmed to repeat themselves.

The voltage and current lists are paced by a separate list that defines the duration or dwell of each step. Each of the up to 512 steps can have an individual dwell time associated with it, which specifies the time in seconds that the list will remain at that step before moving on to the next step.

If you need an output list to closely follow external events, then a trigger-paced list is more appropriate. In a trigger-paced list, the list advances one step for each trigger received. As previously discussed, a number of trigger sources can be selected to generate triggers. With a trigger-paced list, you do not need to program a dwell time for each step. If you do program a dwell time, triggers that are received during the dwell period are ignored. The default dwell time is 0.001 seconds.

Voltage and current lists can also be configured to generate trigger signals at specified steps. This is accomplished by two additional lists: a beginning-of-step (BOST) and an end-of-step (EOST) list. These lists define which steps will generate a trigger signal and if the trigger occurs at the beginning or end of the step. These trigger signals can be used to synchronize other events with the list.

When either a voltage or current list is programmed, the associated dwell, BOST, and EOST lists must all be set to the same number of steps, otherwise an error will occur when the list is run. For convenience, a list may be programmed with only one step or value. In this case, a single-step list is treated as if it had the same number of steps as the other lists, with all values being equal to the one value.

NOTE

List data is not stored in non-volatile memory. This means that list data that is sent to the instrument either from the front panel or over the bus will be lost when the power system is turned off.

Program an Output Pulse or Pulse Train

The following procedure shows how to generate an output pulse train using the List function.

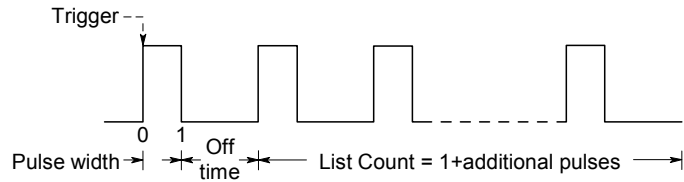

- Step 1.** Set the voltage or current function for which you want to generate a pulse to List mode. This example programs a voltage pulse.

Front Panel:	SCPI Command:
Select Transient\Volt\Mode . Scroll to List and press Select.	To program output 1, use VOLT:MODE LIST, (@1)

- Step 2.** Set the amplitude and width of the pulse. For example, to generate a pulse with an amplitude of 15 V and a pulse width of 1 second, use:

Front Panel:	SCPI Command:
Select Transient>List\Config . Select List Step 0 and enter a voltage value of 15. Press Select. Enter a dwell value of 1 for List Step 0 and Press Select.	To program output 1, use LIST:VOLT 15, (@1) LIST:DWEL 1, (@1)

- Step 3.** Set the list pacing to Auto, so that as each dwell time elapses, the next step is immediately output.

Front Panel:	SCPI Command:
Select Transient>List\Pace . Select Dwell and press Select.	LIST:STEP AUTO, (@1)

If you only wish to program a single pulse, skip steps 4 and 5 and go to step 6.

- Step 4.** If you want to generate a pulse train, you must specify the off time between pulses. To do this you must program another step. For a voltage list, you must specify an amplitude and an off time. For example, to program an off time of 2 seconds with an amplitude of 0 V between pulses, use:

Front Panel:	SCPI Command:
Select Transient>List\Config . Select List Step 1 and enter a voltage value of 0. Press Select. Enter a dwell value of 2 for List Step 1 and Press Select.	To program output 1, use LIST:VOLT 15, 0, (@1) LIST:DWEL 1, 2, (@1)

Step 5. To generate a pulse train, you can simply repeat the pulse as needed. For example, to program a pulse train of 50 pulses, use:

Front Panel:	SCPI Command:
Select Transient\List\Repeat . Enter the number of list repetitions (50) and Press Select.	To program output 1, use LIST:COUN 50, (@1)

Step 6. Specify if you want the output pulse to generate a trigger signal that can be used to trigger actions on other output channels or on any external equipment connected to the digital port. For example, to generate a trigger signal at the end of the pulse, use:

Front Panel:	SCPI Command:
Select Transient\List\Config . Select List Step 0 and check the Tout Step box. Press Select.	To program a trigger at the End of the pulse for output 1, use LIST:TOUT:EOST 1, 0, (@1) You must program a value of 0 (no trigger) for step 1 as a placeholder.

Step 7. Specify the output state after the pulse has completed. For example, to return the output to the state it was in before the pulse, use:

Front Panel:	SCPI Command:
Select Transient\List\Terminate . Select Return to Start. Press Select.	To program the output 1, use LIST:TERM 0, (@1)

Step 8. Select the trigger source that will generate the pulse or pulse train. For example, to select Bus triggers as the trigger source, use:

Front Panel:	SCPI Command:
Select Transient\TrigSource . Select Bus and press Select.	To program output 1, use: TRIG:SOUR BUS, (@1)

Step 9. Initiate the output trigger system. To enable the trigger system for one transient event or trigger use:

Front Panel:	SCPI Command:
Select the Transient\Control . Select Initiate and Press Select.	To program output 1, use INIT:TRAN, (@1)

Step 10. Trigger the output pulse or pulse train.

Front Panel:	SCPI Command:
Select Transient\Control . Select Trigger and Press Select.	*TRG

Program an Arbitrary List

The following procedure shows how to generate the list of voltage changes as illustrated in the following figure.

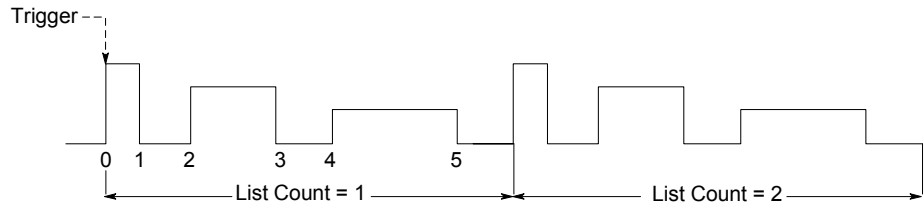

Step 1. Set the function, voltage or current, for which you want to generate a list to List mode. This example programs a voltage list.

Front Panel:	SCPI Command:
Select Transient\Mode\Volt . Scroll to List and press Select.	To program output 1, use VOLT:MODE LIST, (@1)

Step 2. Program the list of values for the List function. The order in which the values are entered determines the order in which the values will be output. To generate the voltage list shown in the figure, a list may include the following values: 9, 0, 6, 0, 3, 0

Front Panel:	SCPI Command:
Select Transient>List\Config . Select the List Step number and enter a voltage value. Press Select. Repeat this for each step. Use the ↑ ↓ keys to select the next step.	To program output 1, use LIST:VOLT 9,0,6,0,3,0, (@1)

Step 3. Determine the time interval, in seconds, that the output remains at each step in the list before it advances to the next step. To specify the six dwell intervals in the figure, a list may include the following values: 2, 3, 5, 3, 7, 3

Front Panel:	SCPI Command:
Select Transient>List\Config . Select the List Step number and enter a dwell value. Press Select. Repeat this for each step. Use the ↑ ↓ keys to select the next step.	To program output 1, use LIST:DWEL 2,3,5,3,7,3, (@1)

NOTE

The number of dwell steps must equal the number of voltage steps. If a dwell list has only one value, that value will be applied to all steps in the list.

Step 4. Determine how the list is paced. To pace the list by dwell time, set the list pacing to Dwell-paced on the front panel menu. (Set the LIST:STEP command to AUTO.) As each dwell time elapses, the next step is immediately output.

Front Panel:	SCPI Command:
Select Transient\List\Pace . Select Dwell-paced. Press Select.	LIST:STEP AUTO, (@1)

In a trigger-paced list, the list advances one step for each trigger received. To enable trigger-paced lists, select Trigger-paced on the front panel menu. (Set the LIST:STEP command to ONCE.)

The dwell time associated with each step determines the minimum time that the output remains at the step. If a trigger is received before the dwell time completes, the trigger is ignored. To ensure that no triggers are lost in a trigger-paced list, set the dwell time to zero.

Step 5. Specify if you want the list to generate trigger signals that can be used to trigger actions on other output channels or on external equipment connected to the digital port.

Front Panel:	SCPI Command:
Select Transient\List\Config . Select the List Step number. To generate a trigger, enter a 1 in the Tout Begin Step or Tout End Step field. If a zero is entered, no trigger is generated for the step. Repeat this for each step. Use the ↑ ↓ keys to select the next step.	To program a trigger at the beginning of step 4 for output 1, use LIST:TOUT:BOST 0,0,0,0,1,0, @1 To program a trigger at the end of step 0, 2, and 4 for output 1, use LIST:TOUT:EOST 1,0,1,0,1,0, @1

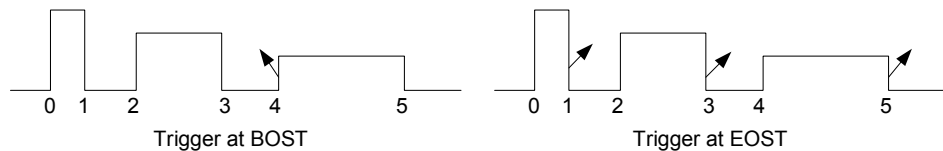

Step 6. Specify how you want the list to terminate.

Front Panel:	SCPI Command:
Select Transient\List\Terminate . Select Stop Last Step. Press Select.	To program the output 1 list to remain at the last list step when finished, use LIST:TERM:LAST 1, (@1)

Step 7. If applicable, specify how many times you want the list to repeat. Sending the INFinity parameter in the SCPI command makes the list repeat indefinitely. At reset, the list count is set to 1.

Front Panel:	SCPI Command:
Select the Transient\List\Count . Enter a value in the Count field and press Select.	To program the output 1 list to repeat 2 times, use LIST:COUN 2, (@1)

Step 8. Select a trigger source, initiate, and trigger the list. This is described in detail under "Synchronizing Output Steps".

The Digitizer Function

The digitizer function lets you access the enhanced voltage and current measurement capabilities of the power system. These include:

- Adjusting the measurement sample rate - to a maximum of 50 kHz.
- Adjusting measurement triggers to capture pre-trigger transients.
- Selecting a measurement window that can attenuate ac noise.
- Retrieving arrays that contain the digitized output current or output voltage.
- Synchronizing measurements with a Bus, Transient, or external trigger.

Programming the Digitizer

Adjust the Measurement Sample Rate

The following figure illustrates the relationship between measurement samples (or points), and the time interval between samples in a typical measurement.

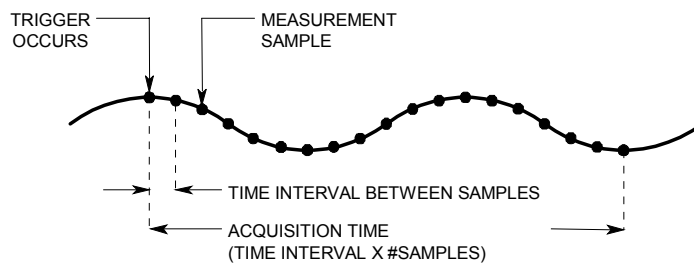

Ripple rejection is a function of the number of cycles of the ripple frequency contained in the acquisition window. More cycles in the acquisition window results in better ripple rejection. You can vary the measurement data sampling rate using the following commands:

Front Panel:	SCPI Command:
Select Measure\Sweep\Points .	For example, to set the time interval to 60 μ s* with 4096 samples, use:
Enter a value and press Select.	SENS:SWE:TINT 60E-6, (@1)
Then scroll to Time Interval, enter a value and press Select again.	SENS:SWE:POIN 4096, (@1)

*The time interval is rounded to the nearest 20.48 μ s interval, which is 61.44 μ s.

Acquire Pre-trigger Data

The measurement system lets you capture data before, after, or at the trigger signal. As shown in the following figure, you can move the block of data being read into the acquisition buffer with reference to the trigger. This allows pre- or post-trigger data sampling.

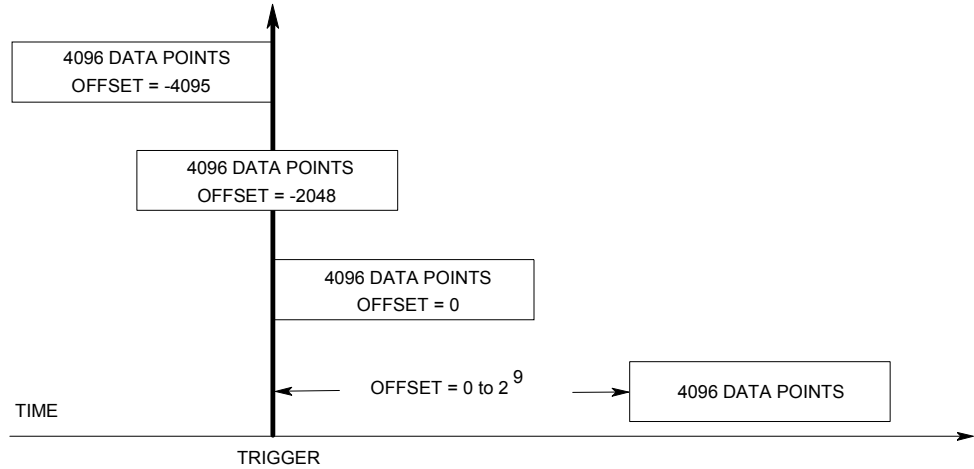

To offset the beginning of the acquisition buffer relative to the acquisition trigger, use:

Front Panel:	SCPI Command:
Select Measure\Sweep\Offset . Enter an offset value and press Select.	To offset the measurement on channel 1 by 100 points use: <code>SENS:SWE:OFFS:POIN 100, (@1)</code>

With a negative offset, values at the beginning of the buffer represent samples taken prior to the trigger. When the value is 0, all values are taken after the trigger. Values greater than 0 can be used to program a delay time from the receipt of the trigger until the values entered into the buffer are valid. (Delay time = offset x sample period).

NOTE

If, during a pre-trigger data acquisition, a trigger occurs before the pre-trigger data count is completed, the measurement system ignores this trigger. This will prevent the completion of the measurement if another trigger is not generated.

Specify a Window Function

Windowing is a signal conditioning process that reduces the error in average measurements made in the presence of periodic signals and noise. Two window functions are available: Rectangular and Hanning. At power-on, the measurement window is Rectangular.

The Rectangular window calculates average measurements without any signal conditioning. However, in the presence of periodic signals such as ac line ripple, a Rectangular window can introduce errors when calculating average measurements. This can occur when a non-integral number of cycles of data has been acquired due to the last partial cycle of acquired data.

One way of dealing with AC line ripple is to use a Hanning window. The Hanning window applies a \cos^4 weighting function to the data when calculating average measurements. This attenuates the AC noise in the measurement window. The best attenuation is achieved when at least three or more waveform cycles are in the measurement.

To select a window function, use:

Front Panel:	SCPI Command:
Select Measure\Window. Then select either Rectangular or Hanning and press Select.	To set the sense window to Hanning for output 1 use: SENS:WIND HANN, (@1)

Retrieve Measurement Array Data

Array queries return all values in the voltage and current measurement buffer. No averaging is applied, only raw data is returned from the buffer. The following commands initiate and trigger a measurement and return the measurement array:

Front Panel:	SCPI Command:
Not Available	MEAS:ARR:VOLT? (@1:4) MEAS:ARR:CURR? (@1:4)

Once a measurement finishes, you may wish to retrieve the array data without initiating a new measurement. Use FETCh queries to return the array data from the last measurement.. Fetch queries do not alter the data in the measurement buffer. The commands are:

Front Panel:	SCPI Command:
Not Available	FETC:ARR:VOLT? (@1:4) FETC:ARR:CURR? (@1:4)

If a FETCh query is sent before the measurement is started or before it is finished, the response will be delayed until the measurement trigger occurs and the acquisition completes. This may tie up the computer if the measurement trigger does not occur immediately.

Synchronizing Digitizer Measurements

Use the measurement trigger system to synchronize the acquisition of measurements with a Bus, Transient, or an external trigger. Then use FETCh commands to return voltage or current information from the acquired data. Briefly, to make a triggered measurement:

1. Select the measurement function to trigger.
2. Select the trigger source.
3. Initiate the trigger system and generate a trigger.
4. Fetch the triggered measurements.

Select the Measurement Function to Trigger

Some models have two measurement converters, which allow simultaneous voltage and current measurements (Refer to Chapter 1, “Model Differences”). If a power model has only one converter and a triggered measurement is initiated, the parameter that it measures (either voltage or current) must be specified.

To trigger measurements on models that do not have simultaneous voltage and current measurement capability, select the measurement function as follows.

Front Panel:	SCPI Command:
Not Available	To select the measurement function: ¹ SENS:FUNC "VOLT", (@1:4) SENS:FUNC "CURR", (@1:4)

If a model has simultaneous voltage and current measurements capability, then BOTH voltage and current are acquired on any triggered measurement, regardless of the setting of the SENSE:FUNCTION command.

Select the Measurement Trigger Source

NOTE

An immediate trigger command over the bus will generate an immediate trigger regardless of the trigger source.

Unless you are using a TRIG:ACQ command to trigger the measurement, select a trigger source from the following:

- Bus** Selects GPIB device trigger, *TRG, or <GET> (Group Execute Trigger).
- Pin <number>** Selects a pin on the external port connector as the trigger source. The selected pin must be configured as a Trigger Input in order to be used as a trigger source (see Appendix C)
- Transient <channel>** Selects the output channel’s transient system as the trigger source. <channel> specifies the channel.

When you select a channel, you must also set up that channel’s transient system to generate a trigger out signal. Refer to “Generating Trigger Out Signals” and “Program an Arbitrary List” earlier in this chapter.

Use the following commands to select a trigger source:

Front Panel:	SCPI Command:
Not Available	To select Bus triggers for output 1: TRIG:ACQ:SOUR BUS, (@1) To select Digital pin triggers: TRIG:ACQ:SOUR PIN<n>, (@1) where n is the pin number. To select Transient output triggers: TRIG:ACQ:SOUR TRAN<n>, (@1) where n is the output channel that will generate the trigger signal.

Initiate the Measurement Trigger System

Next, you must initiate or enable the measurement trigger system.

When the power system is turned on, the trigger system is in the idle state. In this state, the trigger system is disabled, ignoring all triggers. The INITiate commands enable the measurement system to receive triggers. To initiate the measurement trigger system, use:

Front Panel:	SCPI Command:
Not Available	To initiate the measurement trigger system for all four outputs: INIT:ACQ (@1:4)

After a trigger is received and the data acquisition completes, the trigger system will return to the idle state. Thus, it will be necessary to initiate the measurement system each time a triggered measurement is desired.

Trigger the Measurement

The trigger system is waiting for a trigger signal in the initiated state. You can immediately trigger the measurement as follows:

Front Panel:	SCPI Command:
Not Available	To generate a measurement trigger on output 1: TRIG:ACQ (@1) Alternatively, if the trigger source is BUS, you can also program a *TRG or an IEEE-488 <get> command.

As previously discussed, a trigger can also be generated by another output channel or an input pin on the digital port connector. If any of these systems are configured as the trigger source, the instrument will wait indefinitely for the trigger signal. If the trigger does not occur, you must manually return the trigger system to the idle state.

The following commands return the trigger system to the idle state:

Front Panel:	SCPI Command:
Select Measure\Control . Then select the Abort control.	ABOR:ACQ (@1)

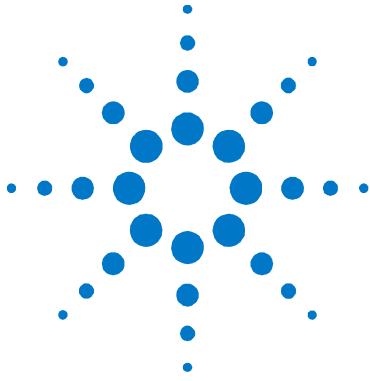

5 Introduction to Programming

SCPI Commands	68
SCPI Messages	70
SCPI Conventions and Data Formats	72
SCPI Command Completion	74

This chapter contains a brief introduction to the SCPI Programming language. SCPI (Standard Commands for Programmable Instruments) is a programming language for controlling instrument functions over the GPIB.

SCPI provides instrument control with a standardized command syntax and style, as well as a standardized data interchange format for various classes of instruments..

SCPI Commands

SCPI has two types of commands, common and subsystem.

- Common commands generally control overall power system functions, such as reset, status, and synchronization. All common commands consist of a three-letter mnemonic preceded by an asterisk: *RST *IDN? *SRE 8
- Subsystem commands perform specific power system functions. They are organized into an inverted tree structure with the "root" at the top. The following figure shows a portion of a subsystem command tree, from which you access the commands located along the various paths.

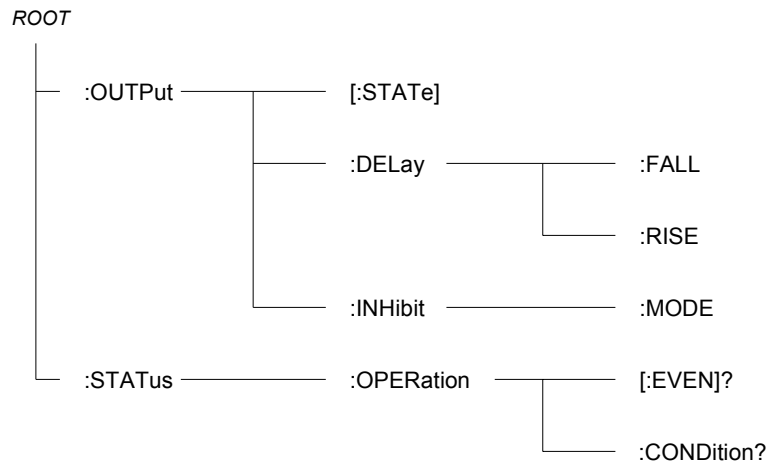

Multiple Commands in a Message

Multiple SCPI commands can be combined and sent as a single message with one message terminator. There are two important considerations when sending several commands within a single message:

- Use a semicolon to separate commands within a message.
- There is an implied header path that affects how commands are interpreted by the power system.

The header path can be thought of as a string that gets inserted **before** each command within a message. For the first command in a message, the header path is a null string. For each subsequent command the header path is defined as the characters that make up the headers of the previous command in the message up to and including the last colon separator. An example of a message with two commands is:

```
OUTPut:STATe ON, (@1);PROTection:CLear (@1)
```

which shows the use of the semicolon separating the two commands, and also illustrates the header path concept. Note that with the second command, the leading header "OUTPut" was omitted because after the "OUTPut:STATe ON" command, the header path became

defined as "OUTPut" and thus the instrument interpreted the second command as:

```
OUTPut:PROTection:CLEar (@1)
```

In fact, it would have been syntactically incorrect to include the "OUTP" explicitly in the second command, since the result after combining it with the header path would be:

```
OUTPut:OUTPut:PROTection:CLEar (@1)
```

which is incorrect.

Moving Among Subsystems

In order to combine commands from different subsystems, you need to be able to reset the header path to a null string within a message. You do this by beginning the command with a colon (:), which discards any previous header path. For example, you could clear the output protection and check the status of the Operation Condition register in one message by using a root specifier as follows:

```
OUTPut:PROTection:CLEar (@1);:STATe:OPERation:CONDition? (@1)
```

The following message shows how to combine commands from different subsystems as well as within the same subsystem:

```
VOLTage:LEVel 7.5, (@1);PROTection 10, (@1);:CURRent:LEVel 0.5, (@1)
```

Note the use of the optional header LEVel to maintain the correct path within the subsystems, and the use of the root specifier to move between subsystems.

Including Common Commands

You can combine common commands with system commands in the same message. Treat the common command as a message unit by separating it with a semicolon (the message unit separator). Common commands *do not affect the header path*; you may insert them anywhere in the message.

```
OUTPut OFF, (@1);*RCL 1;OUTPut ON, (@1)
```

Using Queries

Observe the following precautions with queries:

- Add a blank space between the query indicator (?) and any subsequent parameter such as a channel list.
- Allocate the proper number of variables for the returned data.
- Read back all the results of a query before sending another command to the power system. Otherwise, a *Query Interrupted* error will occur and the unreturned data will be lost.

Coupled Commands

When commands are coupled it means that the value sent by one command is affected by the settings of another command. The following commands are coupled:

- [SOURce:] CURRent and [SOURce:] CURRent:RANGe.
- [SOURce:] VOLTage and [SOURce:] VOLTage:RANGe.

If a range command is sent that places an output on a range with a lower maximum setting than the present level, an error is generated. This also occurs if a level is programmed with a value too large for the present range.

These types of errors can be avoided by sending the both level and range commands as a set, in the same SCPI message. For example,

```
CURRent 10, (@1) ; :RANGe 10, (@1) <NL>
```

will always be correct because the commands are not executed until the message terminator is received. Because the range and setting information is received as a set, no range/setting conflict occurs.

SCPI Messages

There are two types of SCPI messages, program and response.

- A *program message* consists of one or more properly formatted SCPI commands sent from the controller to the power system. The message, which may be sent at any time, requests the power system to perform some action.
- A *response message* consists of data in a specific SCPI format sent from the power system to the controller. The power system sends the message only when commanded by a program message "query."

The following figure illustrates the SCPI message structure.

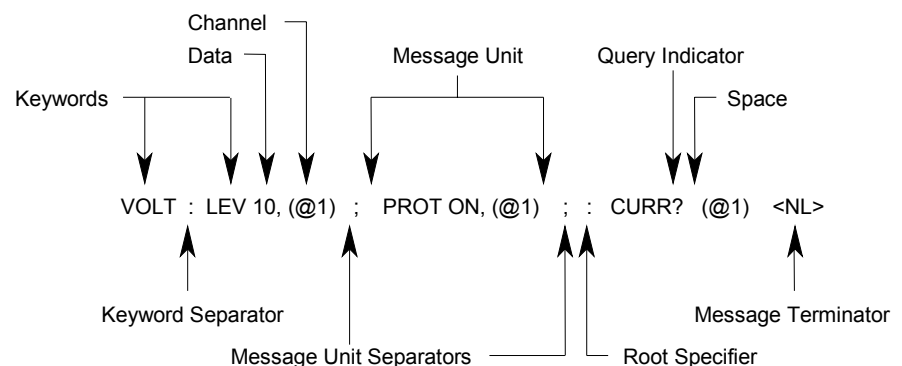

The Message Unit

The simplest SCPI command is a single message unit consisting of a command header (or keyword) followed by a message terminator such as a newline. The message unit may include a parameter after the header. The parameter can be numeric or a string.

```
*RST<NL>
VOLTage 20, (@1) <NL>
```

Channel List Parameter

The channel parameter is required to address one or more channels. It has the following syntax:

```
(@<channel> [, <channel>] [, <channel>] [, <channel>])
```

You can also specify a range of sequential channels as follows:

```
<start_channel>:<end_channel>
```

For example, (@2) specifies channel 2 and (@1:3) specifies channels 1 through 3. A maximum of 4 channels may be specified through a combination of single channels and ranges. Query results are channel list order-sensitive. Results are returned in the order they are specified in the list.

NOTE

When adding a channel list parameter to a query, you must include a space character between the query indicator (?) and the channel list parameter. Otherwise error -103, Invalid separator will occur.

Headers

Headers, also referred to as keywords, are instructions recognized by the power system. Headers may be in the long form or in the short form. In the long form, the header is completely spelled out, such as VOLTAGE, STATUS, and DELAY. In the short form, the header has only the first three or four letters, such as VOLT, STAT, and DEL.

When the long form notation is used in this document, the capital letters indicate the equivalent short form. For example, MEASure is the long form, and MEAS indicates the short form equivalent.

Query Indicator

Following a header with a question mark turns it into a query (VOLTage?, VOLTage:TRIGgered?). The ? is the query indicator. If a query contains a parameter, place the query indicator at the end of the last header, before the parameter.

```
VOLTage:TRIGgered? MAX, (@1)
```

Message Unit Separator

When two or more message units are combined into a compound message, separate the units with a semicolon.

```
STATus:OPERation? (@1) ;QUEStionable? (@1)
```

Root Specifier

When it precedes the first header of a message unit, the colon becomes the root specifier. It tells the command parser that this is the root or the top node of the command tree.

Message Terminator

A terminator informs SCPI that it has reached the end of a message. The following messages terminators are permitted:

- newline <NL>, which is ASCII decimal 10 or hex 0A.
- end or identify <END> (EOI with ATN false)
- both of the above <NL><END>
- also <CR><NL>

In the examples of this guide, there is an assumed message terminator at the end of each message.

SCPI Conventions and Data Formats

Conventions

The following SCPI conventions are used throughout this guide.

Angle brackets < >	Items within angle brackets are parameter abbreviations. For example, <NR1> indicates a specific form of numerical data.
Vertical bar	Vertical bars separate alternative parameters. For example, VOLT CURR indicates that either "VOLT" or "CURR" can be used as a parameter.
Square brackets []	Items within square brackets are optional. The representation [SOURce:]VOLTage means that SOURce: may be omitted.
Braces { }	Braces indicate parameters that may be repeated zero or more times. It is used especially for showing arrays. The notation <A>{} shows that parameter "A" must be entered, while parameter "B" may be omitted or may be entered one or more times.
Parentheses ()	Items within parentheses are used in place of the usual parameter types to specify a channel list. The notation (@1:3) specifies a channel list that includes channels 1, 2, and 3. The notation (@1,3) specifies a channel list that includes only channels 1 and 3.

Data Formats

Data programmed or queried from the power system is ASCII. The data may be numerical or character string.

Numeric Data Formats

Symbol	Response Formats
<NR1>	Digits with an implied decimal point assumed at the right of the least-significant digit. Examples: 273
<NR2>	Digits with an explicit decimal point. Example: .0273
<NR3>	Digits with an explicit decimal point and an exponent. Example: 2.73E+2
Parameter Formats	
<NRf>	Extended format that includes <NR1>, <NR2> and <NR3>. Examples: 273 273. 2.73E2
<NRf+>	Expanded decimal format that includes <NRf> and MIN MAX. Examples: 273 273. 2.73E2 MAX. MIN and MAX are the minimum and maximum limit values that are implicit in the range specification for the parameter.
<Bool>	Boolean Data. They can be numeric (0, 1), or named (ON, OFF).
<SPD>	String program data. String parameters enclosed in single or double quotes.

Suffixes and Multipliers

Class	Suffix	Unit	Unit with Multiplier
Current	A	ampere	MA (milliampere)
Amplitude	V	volt	MV (millivolt)
Time	S	second	MS (millisecond)
Common Multipliers			
1E3	K	kilo	
1E-3	M	milli	
1E-6	U	micro	

Response Data Types

Symbol	Response Formats
<CRD>	Character Response Data. Permits the return of character strings.
<AARD>	Arbitrary ASCII Response Data. Permits the return of undelimited 7-bit ASCII. This data type has an implied message terminator.
<SRD>	String Response Data. Returns string parameters enclosed in single or double quotes.

SCPI Command Completion

SCPI commands sent to the power system are processed either sequentially or in parallel. Sequential commands finish execution before a subsequent command begins. Parallel commands allow other commands to begin executing while the parallel command is still executing.

The following is a list of parallel commands. You should use some form of command synchronization as discussed in this section before assuming that these commands have completed.

OUTPut:STATE	INITiate
VOLTage	OUTPut:PROTEction:CLEar
CURRent	FUNCTion:MODE

The *WAI, *OPC, and *OPC? common commands provide different ways of indicating when all transmitted commands, including any parallel ones, have completed their operations. Some practical considerations for using these commands are as follows:

***WAI** This command prevents the power system from processing subsequent commands until all pending operations are completed. For example, the *WAI command can be used to make a current measurement after an output on command has completed:

```
OUTPut ON, (@1); *WAI; :MEASure:CURRent? (@1)
```

***OPC?** This command places a 1 in the Output Queue when all pending operations have completed. Because it requires your program to read the returned value before executing the next program statement, *OPC? can be used to cause the controller to wait for commands to complete before proceeding with its program.

***OPC** This command sets the OPC status bit when all pending operations have completed. Since your program can read this status bit on an interrupt basis, *OPC allows subsequent commands to be executed.

NOTE

The trigger subsystem must be in the Idle state for the status OPC bit to be true. As far as triggers are concerned, OPC is false whenever the trigger subsystem is in the Initiated state.

Device Clear

You can send a Device Clear at any time to abort a SCPI command that may be hanging up the GPIB interface. Device Clear clears the input and output buffers of the power system and prepares the power system to accept a new command string. The status registers, error queue, and all configuration states are left unchanged by Device Clear. The following statement shows how to send a device clear over the GPIB interface using *Agilent Basic*:

```
CLEAR 705          IEEE-488 Device Clear
```

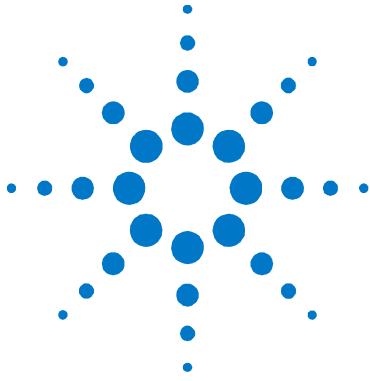

6 Language Dictionary

SCPI Command Summary	76
Calibration Subsystem	80
Display Subsystem	82
Measurement Subsystem	83
Output Subsystem	86
Source Subsystem	89
Status Subsystem	96
System Commands	103
Trigger Subsystem	107

This section gives the syntax and parameters for all the IEEE 488.2 SCPI commands and the Common commands used by the power system. It is assumed that you are familiar with the material in chapter 5, which explains the terms, symbols, and syntactical structures used here and gives an introduction to programming. You should also be familiar with chapter 4, in order to understand how the power system functions.

Subsystem commands are specific to instrument functions. They can be a single command or a group of commands. The groups are comprised of commands that extend one or more levels below the root. The subsystem commands are arranged alphabetically according to the function they perform.

Common commands are defined by the IEEE 488.2 standard to perform common interface functions. They begin with an * and consist of three letters (command) or three letters and a ? (query). Common commands are grouped along with the subsystem commands according to the function they perform.

SCPI Command Summary

Subsystem Commands

NOTE

Some [optional] commands have been included for clarity. All settings commands have a corresponding query. Not all commands apply to all models.

SCPI Command	Description
ABORt	
:ACQuire (@chanlist)	Resets the measurement trigger system to the Idle state
:TRANsient (@chanlist)	Resets the transient trigger system to the Idle state
CALibrate	
:CURRent	
[:LEVel] <NRf>, (@channel)	Calibrates the output current programming
:MEASure <NRf>, (@channel)	Calibrates the current measurement
:PEAK (@channel)	Calibrates the peak current limit (Agilent N6751A/52A/61A/62A)
:DATA <NRf>	Enters the calibration value
:DATE <SPD>, (@channel)	Sets the calibration date
:DPRog (@channel)	Calibrates the current downprogrammer
:LEVel P1 P2 P3	Advances to the next calibration step
:PASSword <NRf>	Sets the numeric calibration password
:SAVE	Saves the new cal constants in non-volatile memory
:STATE <Bool> [, <NRf>]	Enables/disables calibration mode
:VOLTage	
[:LEVel] <NRf>, (@channel)	Calibrates the output voltage programming
:CMRR (@channel)	Calibrates common mode rejection ratio (N6751A/52A/61A/62A)
:MEASure <NRf>, (@channel)	Calibrates the voltage measurement
DISPlay[:WINDow]:VIEW METER1 METER4	Selects 1-channel or 4-channel meter view
FETCh (Note 1) MEASure	
[:SCALar]	
:CURRent [:DC]? (@chanlist)	Returns the average output current
:VOLTage [:DC]? (@chanlist)	Returns the average output voltage
:ARRay	(Array commands only on Agilent N6761A/62A and Option 054)
:CURRent [:DC]? (@chanlist)	Returns the instantaneous output current
:VOLTage [:DC]? (@chanlist)	Returns the instantaneous output voltage
INITiate	
[:IMMediate]	(Acquire command only on Agilent N6761A/62A and Option 054)
:ACQuire (@chanlist)	Enables the measurement system to receive triggers
:TRANsient (@chanlist)	Enables the output transient system to receive triggers
:CONTinuous	
:TRANsient <Bool>, (@chanlist)	Enables/disables continuous transient triggers
OUTPut	
[:STATE] <Bool> [, NORelay], (@chanlist)	Enables/disables the specified output channel(s)
:DELay	
:FALL <NRf+>, (@chanlist)	Sets the output turn-off sequence delay
:RISE <NRf+>, (@chanlist)	Sets the output turn-on sequence delay
:INHibit	
:MODE LATCHing LIVE OFF	Sets the remote inhibit input

SCPI Command	Description
OUTPut (continued)	
:PON	
:STATe RST RCL0	Programs the power-on state
:PROTection	
:CLEAr (@chanlist)	Resets latched protection
:COUPle <Bool>	Enables/disables channel coupling for protection faults
:DELAy <NRf+>, (@chanlist)	Sets over-current protection programming delay
SENSe	
:CURRent [:DC]	
:RANGe [:UPPer] <NRf+>, (@chanlist)	Selects the current measurement range (Agilent N6761A/62A)
:FUNCTion "VOLTage" "CURRent", (@chanlist)	Selects the measurement function
:SWEep	(Sweep commands only on Agilent N6761A/62A and Option 054)
:OFFSet:POINts <NRf+>, (@chanlist)	Defines the trigger offset in the measurement sweep
:POINts <NRf+>, (@chanlist)	Defines the number of data points in the measurement
:TINTerval <NRf+>, (@chanlist)	Sets the measurement sample interval
:VOLTage [:DC]	
:RANGe [:UPPer] <NRf+>, (@chanlist)	Selects the voltage measurement range (Agilent N6761A/62A)
:WINDow [:TYPE] HANNing RECTangular, (@chanlist)	Selects the measurement window (N6761A/62A and Option 054)
[SOURce:]	
CURRent	
[:LEVel]	
[:IMMEDIATE][:AMPLitude] <NRf+>, (@chanlist)	Sets the output current
:TRIGgered [:AMPLitude] <NRf+>, (@chanlist)	Sets the triggered output current
:MODE FIXed STEP LIST, (@chanlist)	Sets the current trigger mode
:PROTection	
:STATe <Bool>, (@chanlist)	Enables/disables over-current protection on the selected output
:RANGe <NRf+>, (@chanlist)	Sets the output current range (Agilent N6761A/62A)
DIGital	
:INPut:DATA?	Reads the state of the digital port pins
:OUTPut:DATA <NRf>	Sets the digital port
:PIN1 :PIN2 :PIN3 :PIN4 :PIN5 :PIN6 :PIN7	
:FUNCTion DIO DINP TOUT TINP FAUL ¹ INH ²	Sets the selected pin's function (¹ PIN1 only; ² PIN3 only)
:POLarity POSitive NEGative	Sets the selected pin's polarity
LIST	
:COUNt <NRf+> INFIinity, (@chanlist)	Sets the list repeat count
:CURRent [:LEVel] <NRf> {,<NRf>}, (@chanlist)	Sets the current list
:POINts? (@chanlist)	Returns the number of current list points
:DWELI <NRf> {,<NRf>}, (@chanlist)	Sets the list of dwell times
:POINts? (@chanlist)	Returns the number of dwell list points
:STEP ONCE AUTO, (@chanlist)	Specifies how the list responds to triggers
:TERMIate	
:LAST <Bool>, (@chanlist)	Sets the list termination mode
:TOUtput	
:BOSTep[:DATA] <Bool> {,<Bool>}, (@chanlist)	Sets the steps to generate triggers at the Begin Of Step
:POINts? (@chanlist)	Returns the number of beginning of step list points
:EOSTep[:DATA] <Bool> {,<Bool>}, (@chanlist)	Sets the steps to generate triggers at the End Of Step
:POINts? (@chanlist)	Returns the number of end of step list points
:VOLTage[:LEVel] <NRf> {,<NRf>}, (@chanlist)	Sets the voltage list
:POINts? (@chanlist)	Returns the number of voltage level points
STEP	
:TOUtput <Bool>, (@chanlist)	Generate a trigger output on the voltage or current step transient

SCPI Command	Description
[SOURce:] (continued)	
VOLTage	
[:LEVel]	
[:IMMEDIATE][:AMPLitude] <NRf+>, (@chanlist)	Sets the output voltage
:TRIGgered [:AMPLitude] <NRf+>, (@chanlist)	Sets the triggered output voltage
:MODE FIXed STEP LIST, (@chanlist)	Sets the voltage trigger mode
:PROtection	
[:LEVel] <NRf+>, (@chanlist)	Sets the over-voltage protection level
:RANGe <NRf+>, (@chanlist)	Sets the output voltage range (Agilent N6761A/62A)
:SLEW <NRf+> INfinity, (@chanlist)	Sets the output voltage slew rate
STATus	
:OPERation	
[:EVENT]? (@chanlist)	Returns the value of the operation event register
:CONDition? (@chanlist)	Returns the value of the operation condition register
:ENABle <NRf>, (@chanlist)	Enables specific bits in the Event register
:NTRansition <NRf>, (@chanlist)	Sets the Negative transition filter
:PTRansition <NRf>, (@chanlist)	Sets the Positive transition filter
:PRESet	Presets all enable and transition registers to power-on
:QUESTionable	
[:EVENT]? (@chanlist)	Returns the value of the questionable event register
:CONDition? (@chanlist)	Returns the value of the questionable condition register
:ENABle <NRf>, (@chanlist)	Enables specific bits in the Event register
:NTRansition <NRf>, (@chanlist)	Sets the Negative transition filter
:PTRansition <NRf>, (@chanlist)	Sets the Positive transition filter
SYSTem	
:CHANnel	
[:COUNt]?	Returns the number of output channels in a mainframe
:MODEl? (@chanlist)	Returns the model number of the selected channel
:OPTion? (@chanlist)	Returns the option installed in the selected channel
:SERial? (@chanlist)	Returns the serial number of the selected channel
:COMMunicate	
:RLState LOCal REMote RWLock	Specifies the Remote/Local state of the instrument
:TCPIP:CONTRol?	Returns the control connection port number
:ERRor?	Returns the error number and error string
:GROup	
:CATalog?	Returns the groups that have been defined
:DEFine (@chanlist)	Group multiple channels together to create a single output
:DElete (channel)	Removes the specified channel from a group
:ALL	Ungroups all channels
:PASSword:FPANel:RESet	Resets the front panel lock password to zero
:REBoot	Returns the unit to its power-on state
:VERSion?	Returns the SCPI version number
TRIGger	
:ACQuire	(Acquire commands only on Agilent N6761A/62A and Option 054)
[:IMMEDIATE] (@chanlist)	Triggers the measurement immediately
:SOURce BUS PIN<pin> TRAN<chan>, (@chanlist)	Sets the measurement trigger source
:TRANsient	
[:IMMEDIATE] (@chanlist)	Triggers the output immediately
:SOURce BUS PIN<pin> TRAN<chan>, (@chanlist)	Sets the output trigger source

Common Commands

Command	Description	Command	Description
*CLS	Clear status	*RDT?	Return output channel descriptions
*ESE <NRf>	Standard event status enable	*RST	Reset
*ESE?	Return standard event status enable	*SAV <NRf>	Saves an instrument state
*ESR?	Return event status register	*SRE <NRf>	Set service request enable register
*IDN?	Return instrument identification	*SRE?	Return service request enable register
*OPC	Enable "operation complete" bit in ESR	*STB?	Return status byte
*OPC?	Return a "1" when operation complete	*TRG	Trigger
*OPT?	Return option number	*TST?	Performs self-test, then returns result
*RCL <NRf>	Recalls a saved instrument state	*WAI	Pauses additional command processing until all device commands are done

*RST Settings

These settings are set by the *RST (Reset) command

Calibration Function (Note 1)		Measurement (continued)	
CAL:STAT	OFF	SENS:SWE:OFFS:POIN	0
Current Function		SENS:SWE:TINT	20.48E-6
[SOUR:]CURR	80 mA	SENS:VOLT:RANG	MAX
[SOUR:]CURR:MODE	FIX	SENS:WIND	RECT
[SOUR:]CURR:PROT:STAT	OFF	Output Function	
[SOUR:]CURR:RANG	MAX	OUTP	OFF
[SOUR:]CURR:TRIG	MIN	OUTP:DEL:FALL	0
Digital Function		OUTP:DEL:RISE	0
[SOUR:]DIG:OUTP:DATA	0	OUTP:PROT:COUP	OFF
Display Function		OUTP:PROT:DEL	0.02
DISP:VIEW	METER1	OUTP:REL	OFF
List Function (Note 1)		Step Function	
[SOUR:]LIST:COUN	1	[SOUR:]STEP:TOUT	FALSE
[SOUR:]LIST:CURR	MIN	Trigger Function	
[SOUR:]LIST:DWEL	0.001	INIT:CONT:TRAN	OFF
[SOUR:]LIST:STEP	AUTO	TRIG:ACQ:SOUR	BUS
[SOUR:]LIST:TERM:LAST	OFF	TRIG:TRAN:SOUR	BUS
[SOUR:]LIST:TOUT:BOST	OFF	Voltage Function	
[SOUR:]LIST:TOUT:EOST	OFF	[SOUR:]VOLT	MIN
[SOUR:]LIST:VOLT	MIN	[SOUR:]VOLT:MODE	FIX
Measurement Function		[SOUR:]VOLT:PROT:LEV	MAX
SENS:CURR:RANG	MAX	[SOUR:]VOLT:RANG	MAX
SENS:FUNC	"VOLT"	[SOUR:]VOLT:SLEW	MAX
SENS:SWE:POIN	1024	[SOUR:]VOLT:TRIG	MIN

Note 1 The calibration state and all list settings are not saved by the *SAV command.

Calibration Subsystem

The calibration subsystem lets you calibrate the power system. Only one channel can be calibrated at a time. Refer to Appendix B for details.

NOTE

If calibration mode has not been enabled with CALibrate:STATE, the calibration commands will generate an error. Use CALibrate:SAVE to save any changes, otherwise all changes will be lost when you exit calibration mode.

CALibrate:CURRENT[:LEVel] <value>, (@<channel>)

This command initiates calibration of the output current. The value that you enter selects the range that is being calibrated.

CALibrate:CURRENT:MEASure <value>, (@<channel>)

This command initiates calibration of the current measurement range. The value that you enter selects the range that is being calibrated.

CALibrate:CURRENT:PEAK (@<channel>)

This command initiates calibration of the peak current limit.

CALibrate:DATA <value>

This command enters a calibration value that you obtain by reading an external meter. You must first select a calibration level (with CALibrate:LEVel) for the value being entered. Data values are expressed in base units - either volts or amperes, depending on which function is being calibrated.

CALibrate:DATE <"date">, (@<channel>)

CALibrate:DATE?

This command stores the date that the power module was last calibrated. The calibration date is stored in nonvolatile memory. Enter any ASCII string up to 16 characters. The query returns the date.

NOTE

The firmware does not interpret the string format. The information is not used by the firmware. The command is only provided to store the calibration date.

CALibrate:DPRog (@<channel>)

This command initiates calibration of the current downprogrammer.

CALibrate:LEVel P1 | P2 | P3

This command is used to advance to the next level in the calibration. **P1** is the first calibration level; **P2** is the second level; **P3** is the third level.

NOTE

Some calibration sequences may require some settling time after sending CAL:LEV but before reading the data from the DVM and sending CAL:DATA.

CALibrate:PASSword <password>

This command lets you change the calibration password. A new password is automatically stored in nonvolatile memory and does not have to be stored with CALibrate:SAVE. If the password is set to 0, password protection is removed and the ability to enter calibration mode is unrestricted. The factory-default password 0 (zero).

CALibrate:SAVE

This command saves calibration constants in non-volatile memory after the calibration procedure has been completed. If calibration mode is exited by programming CALibration:STate OFF without first saving the new constants, the previous constants are restored.

**CALibrate:STate ON | OFF [, <password>]
CALibrate:STate?**

This command enables or disables calibration mode. Calibration mode must be enabled for the power system to accept any calibration commands. The first parameter specifies the ON (1) or OFF (0) state. The second parameter is the password.

A numeric password is required if calibration mode is being enabled and the existing password is not 0. If the password is not entered or is incorrect, an error is generated and the calibration mode remains disabled. The query returns only the state, not the password.

The *RST value = OFF.

NOTE

When the calibration state is changed from enabled to disabled, new calibration constants are lost unless they have already been stored with CALibrate:SAVE.

CALibrate:VOLTage[:LEVel] <value>, (@<channel>)

This command initiates calibration of the output voltage. The value that you enter selects the range that is being calibrated.

CALibrate:VOLTage:CMRR (@<channel>)

This command initiates calibration of the voltage common mode rejection ratio.

CALibrate:VOLTage:MEASure <value>, (@<channel>)

This command initiates calibration of the voltage measurement range. The value that you enter selects the range that is being calibrated.

Display Subsystem

The display subsystem lets you control the front panel display.

DISPlay[:WINDow]:VIEW METER1 | METER4
DISPlay[:WINDow]:VIEW?

This command selects the output channel view of the front panel display. METER1 displays one output channel. METER4 displays all output channels up to a maximum of four.

The *RST value = METER1.

Measurement Subsystem

The measurement subsystem consists of Measure, Fetch, and Sense commands.

Measure commands measure the output voltage or current. They trigger the acquisition of new data before returning the reading. Measurements are performed by digitizing the instantaneous output voltage or current for a specified time interval, storing the results in a buffer, and calculating the average value. Use Measure commands when the measurement does not need to be synchronized with any other event.

Fetch commands return a reading computed from previously acquired data. If you take a voltage measurement, you can fetch only voltage data. If you take a current measurement, you can fetch only current data. Use Fetch commands when it is important that the measurement be synchronized with a triggered event.

Sense commands control the current measurement range, the bandwidth detector of the power system, and the data acquisition sequence.

Agilent Models N6761A and N6762A have simultaneous voltage and current measurement capability. In this case BOTH voltage and current are acquired, regardless of the parameter that is being measured. To return both values of a simultaneous measurement, first use the MEASure command to measure either the output voltage or current. Then use the FETCh command to return the other parameter.

NOTE

The FETCh:ARRay, MEASure:ARRay, and SENSE commands do not apply to all models (Refer to chapter 1, "Model Differences").

FETCh:ARRay:CURRent[:DC]? (@<chanlist>)

FETCh:ARRay:VOLTag[:DC]? (@<chanlist>)

MEASure:ARRay:CURRent[:DC]? (@<chanlist>)

MEASure:ARRay:VOLTag[:DC]? (@<chanlist>)

These queries return an array containing the digitized output current in amperes or output voltage in volts. The data returned by the FETCh command is the result of the last measurement command or acquisition trigger. The data is valid until the next MEASure or INITiate command occurs.

The output voltage or current is digitized whenever a measurement command is sent or an acquisition trigger occurs. The sampling rate is set by SENSE:SWEp:TINterval. The position of the trigger relative to the beginning of the data buffer is determined by SENSE:SWEp:OFFSet. The number of points returned is set by SENSE:SWEp:POINts.

```
FETCh[:SCALar]:CURRent[:DC]? (@<chanlist>)
FETCh[:SCALar]:VOLTage[:DC]? (@<chanlist>)
```

```
MEASure[:SCALar]:CURRent[:DC]? (@<chanlist>)
MEASure[:SCALar]:VOLTage[:DC]? (@<chanlist>)
```

These queries return the DC output current in amperes or output voltage in volts. The data returned by the FETCh command is the result of the last acquisition. The data is valid until the next MEASure or INITiate command occurs.

The output voltage or current is digitized whenever a measurement command is sent or an acquisition trigger occurs. The time interval is set by SENSE:SWEep:TINterval. The position of the trigger relative to the beginning of the data buffer is determined by SENSE:SWEep:OFFSet. The number of points returned is set by SENSE:SWEep:POINts.

```
SENSE:CURRent[:DC]:RANGe[:UPPer] <value>|MIN|MAX, (@<chanlist>)
SENSE:CURRent[:DC]:RANGe[:UPPer]? [MIN|MAX,] (@<chanlist>)
```

This command selects a DC current measurement range on models that have multiple ranges. The value that you enter must be higher than the maximum current that you expect to measure. Units are in amperes. The instrument selects the range with the best resolution for the value entered. When queried, the returned value is the maximum DC current that can be measured on the range that is presently set.

Refer to Appendix A for the available ranges for each model.

The *RST value = the highest available range.

```
SENSE:FUNCTion "VOLTage"|"CURRent", (@<chanlist>)
SENSE:FUNCTion? (@<chanlist>)
```

This command selects a measurement function on models that do not have simultaneous voltage and current measurement capability. This command is required so that the acquisition system knows which measurement function to acquire when a measurement is triggered.

The *RST value = "VOLTage".

```
SENSE:SWEep:OFFSet:POINts <points>|MIN|MAX, (@<chanlist>)
SENSE:SWEep:OFFSet:POINts? [MIN|MAX,] (@<chanlist>)
```

This command defines the offset in a data sweep when an acquire trigger is used on models that have measurement controls. Programmed values can range from -4095 through 2,000,000,000 (2E9). Negative values represent data samples taken prior to the trigger. Positive values represent the delay after the trigger occurs but before the samples are acquired.

The *RST value = 0.

```
SENSe:SWEEp:POINtS <points>|MIN|MAX, (@<chanlist>)
SENSe:SWEEp:POINtS? [MIN|MAX,] (@<chanlist>)
```

This command defines the number of points in a measurement on models that have measurement controls. Programmed values can range from 1 to 4096.

The *RST value = 1024.

```
SENSe:SWEEp:TINterval <interval>|MIN|MAX, (@<chanlist>)
SENSe:SWEEp:TINterval? [MIN|MAX,] (@<chanlist>)
```

This command defines the time period between samples in seconds on models that have measurement controls. Programmed values can range from 0.00002048 to 40000 seconds. Values are rounded to the nearest 20.48 microsecond increment.

The *RST value = 20.48 microseconds.

```
SENSe:VOLTage[:DC]:RANGe[:UPPer] <value>|MIN|MAX, (@<chanlist>)
SENSe:VOLTage[:DC]:RANGe[:UPPer]? [MIN|MAX,] (@<chanlist>)
```

This command selects a DC voltage measurement range on models that have multiple ranges. The programmed value must be the maximum voltage that you expect to measure. Units are in volts. The instrument selects the range with the best resolution for the value entered. When queried, the returned value is the maximum DC voltage that can be measured on the range that is presently set.

Refer to Appendix A for the available ranges for each model.

The *RST value = the highest available range.

```
SENSe:WINDow[:TYPE] HANNing|RECTangular, (@<chanlist>)
SENSe:WINDow[:TYPE]? (@<chanlist>)
```

This command sets the window function used in DC measurement calculations on models that have measurement controls. Select from:

HANNing A signal conditioning window that reduces errors in DC measurement calculations in the presence of periodic signals such as AC line ripple. The Hanning window multiplies each point in the sample by the function \cos^4 .

RECTangular A window that returns measurement calculations with no signal conditioning.

Note that neither window function alters the instantaneous voltage or current data returned in the measurement array.

The *RST value = RECTangular.

Output Subsystem

The Output subsystem controls the output, power-on, protection, and relay functions.

```
OUTPut[:STATE] ON|OFF [,NORelay], (@<chanlist>)
OUTPut[:STATE]? (@<chanlist>)
```

This command enables or disables the specified output channel(s). The enabled state is ON (1); the disabled state is OFF (0). The state of a disabled output is a condition of zero output voltage and a zero source current. If output and sense relays are installed (Option 761), they will open when the output is disabled and close when the output is enabled. The query returns 0 if the output is off, and 1 if the output is on.

The optional NORelay parameter lets you turn the output state on or off and leave the state of the relays unchanged. When not specified, the relays open and close as the output is turned off and on.

Separate delays can be programmed for the off-to-on and the on-to-off transition using OUTPut:DElay:RISE and OUTPut:DElay:FALL.

The *RST value = OFF.

NOTE

Because of internal circuit start-up procedures and any installed relay options, the output on command may take between 35 and 50 milliseconds to complete its function. Conversely, the output off command may take between 20 and 25 milliseconds to complete its function. To mitigate this built-in delay, you can program the output to zero volts rather than using the output on/off command.

```
OUTPut[:STATE]:DElay:FALL <delay>|MIN|MAX, (@<chanlist>)
OUTPut[:STATE]:DElay:FALL? [MIN|MAX,] (@<chanlist>)
```

This command sets the delay in seconds that the instrument waits before disabling the specified output. It affects on-to-off transitions including changes in the OUTPut:STATE as well as transitions due to changes in the voltage range or current range. It does NOT affect transitions to off caused by protection functions. Delay times can range from 0 to 1.023 seconds in increments of 1 millisecond.

This command allows multiple output channels to turn off in sequence. Each output will not turn off until its delay time has elapsed.

The *RST value = 0.

NOTE

Output channel turn-on and turn-off characteristics vary across the three module types - DC Power, Autoranging, and Precision (Refer to chapter 1, "Model Differences"). When several channels of the **same** module type are programmed by this command, output sequencing is precisely determined by the programmed delays.

However, when outputs of **different** module types are sequenced using this command, there may be an additional offset of a few milliseconds from one output to another. This offset is the same for each module type and is repeatable. Once you have characterized this offset, using an oscilloscope for example, you can adjust the programmed delays to compensate for the offset and give the desired output sequencing.

Outputs within the same module type can also have an offset if one model has output relays (Option 761) and another does not. These offsets are also repeatable and can be compensated for by adjusting the programmed delay values.

OUTPut[:STATE]:DElay:RISE <delay> | MIN | MAX, (@<chanlist>)
OUTPut[:STATE]:DElay:RISE? [MIN | MAX,] (@<chanlist>)

This command sets the delay in seconds that the instrument waits before enabling the specified output. It affects all off-to-on transitions including changes in the OUTPut:STATE as well as transitions due to OUTPut:PROtection:CLEar. Delay times can range from 0 to 1.023 seconds in increments of 1 millisecond.

This command allows multiple output channels to turn on in sequence. Each output will not turn on until its delay time has elapsed.

The *RST value = 0.

NOTE

Refer to the note under OUTPut:DElay:FALL, which also applies to OUTPut:DElay:RISE.

OUTPut:INHibit:MODE LATCHing | LIVE | OFF
OUTPut:INHibit:MODE?

This command selects the mode of operation of the Inhibit input (INH). The inhibit function shuts down ALL output channels in response to an external signal on the Inhibit input. If an output channel has been turned off by OUTPut:STATE, the inhibit function does not affect the output channel while it is in the OFF state. The Inhibit mode setting is stored in non-volatile memory.

The following modes can be selected:

- LATCHing** Causes a logic-true transition on the Inhibit input to disable all outputs. The outputs remain disabled until the Inhibit input is returned to logic-false and the latched INH status bit is cleared by sending the OUTP:PROT:CLE command or a protection clear command from the front panel.
- LIVE** Allows the enabled outputs to follow the state of the Inhibit input. When the Inhibit input is true, the outputs are disabled. When the Inhibit input is false, the outputs are re-enabled.
- OFF** The Inhibit input is ignored.

OUTPut:PON:STATe RST | RCL0
OUTPut:PON:STATe?

This command determines if the power-on state is set to the *RST (RST) state or the instrument state stored in memory location 0 (RCL0). The parameter is saved in non-volatile memory. Instrument states can be stored using the *SAV command.

Refer to *RST and *RCL under “System Commands” for more information.

OUTPut:PROTection:CLEar (@<chanlist>)

This command clears the latched protection status that disables the output when an over-voltage, over-temperature, over-current, power-fail, or Inhibit status condition is detected. All conditions that generate the fault must be removed before the latched status can be cleared. The output is restored to the state it was in before the fault condition occurred.

NOTE

If a protection shutdown occurs during an output list, the list continues running even though the output is disabled. When the protection status is cleared and the output becomes enabled again, the output will be set to the values of the step that the list is presently at.

OUTPut:PROTection:COUPlE ON | OFF
OUTPut:PROTection:COUPlE?

This command enables/disables output coupling for protection faults. When enabled, ALL output channels are disabled when a protection fault occurs on any output channel. The enabled state is On (1); the disabled state is Off (0). When disabled, only the affected output channel is disabled when a protection fault is triggered.

The *RST value = OFF.

OUTPut:PROTection:DELay <delay> | MIN | MAX, (@<chanlist>)
OUTPut:PROTection:DELay? [MIN | MAX,] (@<chanlist>)

This command sets the over-current protection programming delay. This prevents momentary changes in status that can occur during reprogramming from triggering the over-current protection function. Programmed values can range from 0 to 255 milliseconds.

The *RST value = 20 ms.

Source Subsystem

The Source subsystem programs the current, digital, list, step, and voltage functions.

NOTE

The `SOURce:CURRent:RANge`, `SOURce:VOLTage:RANge`, and `SOURce:LIST` commands do not apply to all models (Refer to Chapter 1, “Model Differences”).

```
[SOURce:] CURRent[:LEVel] [:IMMEdiate] [:AMPLitude] <value>|MIN|MAX (@<chanlist>)
[SOURce:] CURRent[:LEVel] [:IMMEdiate] [:AMPLitude]? [MIN|MAX,] (@<chanlist>)
[SOURce:] CURRent[:LEVel]:TRIGgered[:AMPLitude] <value>|MIN|MAX, (@<chanlist>)
[SOURce:] CURRent[:LEVel]:TRIGgered[:AMPLitude]? [MIN|MAX,] (@<chanlist>)
```

These commands set the immediate and the triggered current level of the output channel. The values are programmed in amperes. The immediate level is the output current setting. The triggered level is a stored value that is transferred to the output when a Step transient is triggered. This command is coupled with `[SOURce:]CURRent:RANge`.

The *RST value = MIN.

```
[SOURce:] CURRent:MODE FIXEd|STEP|LIST, (@<chanlist>)
[SOURce:] CURRent:MODE? (@<chanlist>)
```

These commands determine what happens to the output current when the transient system is initiated and triggered.

FIXed The output voltage remains at the immediate value.

STEP The output goes to the triggered level when a trigger occurs.

LIST The output follows the programmed step value when a trigger occurs. This function does not apply to all models (see Chapter 1, “Model Differences”).

The *RST value = FIXed.

```
[SOURce:] CURRent:PROTection:STATE ON|OFF, (@<chanlist>)
[SOURce:] CURRent:PROTection:STATE? (@<chanlist>)
```

This command enables or disables the over-current protection (OCP) function. The enabled state is On (1); the disabled state is Off (0). If the over-current protection function is enabled and the output goes into constant current operation, the output is disabled and the Questionable Condition status register OCP bit is set.

The current limit setting determines when the output channel goes into constant current operation. An over-current condition can be cleared with `OUTPut:PROTection:CLEar` after the cause of the condition is removed.

The *RST value = OFF.

[SOURce:] CURRENT:RANGe <value> | MIN | MAX, (@<chanlist>)
 [SOURce:] CURRENT:RANGe? [MIN | MAX,] (@<chanlist>)

This command only applies to models that have programmable ranges. Refer to Appendix A for the available ranges for each model.

This command sets the output current range. Units are in amperes. The instrument selects the range with the best resolution for the value entered. When queried, the returned value is the maximum DC current that can be output on the range that is presently set.

This command is coupled with the [SOURce:]CURRENT command. This means that if a range command is sent that places an output on a range with a lower maximum current than the present current level, an error is generated. This also occurs if a current level is programmed with a value too large for the present range.

These types of errors can be avoided by sending the both level and range commands in the same SCPI message. When the range and setting information is received as a set, no range/setting conflict occurs.

The *RST value = the highest available range.

NOTE

If programming a range value causes a range change to occur while the output is enabled, the output will be temporarily disabled while the range switch occurs. The transition from on-to-off and then from off-to-on will also be delayed by the settings of OUTPUT:DElay:FALL and OUTPUT:DElay:RISE.

[SOURce:] DIGital:INPut:DATA?

This query reads the state of the digital control port. The query returns the state of pins 1 through 7 in bits 0 through 6 respectively.

[SOURce:] DIGital:OUTPut:DATA <value>
 [SOURce:] DIGital:OUTPut:DATA?

This command sets the output data on the digital control port when that port is configured for Digital I/O operation. The port has seven signal pins and a digital ground pin. In the binary-weighted value that is written to the port, the pins are controlled according to the following bit assignments.

Pin	Bit	Pin	Bit
1	0	4	3
2	1	5	4
3	2	6	5
		7	6

The query returns the last programmed value of the bits. To read the actual state of the pin, use [SOURce:]DIGital:INPut:DATA?

```
[SOURCE:] DIGital:PIN1:FUNction DIO | DINPut | TOUTput | TINPut | FAULt
[SOURCE:] DIGital:PIN2:FUNction DIO | DINPut | TOUTput | TINPut
[SOURCE:] DIGital:PIN3:FUNction DIO | DINPut | TOUTput | TINPut | INHibit
[SOURCE:] DIGital:PIN4:FUNction DIO | DINPut | TOUTput | TINPut
[SOURCE:] DIGital:PIN5:FUNction DIO | DINPut | TOUTput | TINPut
[SOURCE:] DIGital:PIN6:FUNction DIO | DINPut | TOUTput | TINPut
[SOURCE:] DIGital:PIN7:FUNction DIO | DINPut | TOUTput | TINPut
[SOURCE:] DIGital:PIN<1-7>:FUNction?
```

These commands set the functions of the digital port pins. The pin functions are saved in non-volatile memory.

DIO The pin is a general-purpose ground-referenced digital input/output. The output can be set with [SOURCE:]DIGital:OUTPut:DATA <value>.

DINPut The pin is in digital input-only mode. The digital output data of the corresponding pin is ignored.

TOUTput The pin is configured as a trigger output. When configured as a trigger output, the pin will only generate output triggers if the Step or List transient system has been configured to generated trigger signals.

TINPut The pin is configured as a trigger input. When configured as a trigger input, the pin can be selected as a source of measurement and transient trigger signals.

FAULt Applies only to pin 1. Setting FAULt means that pin 1 functions as an isolated fault output. The fault signal is true when any output is in a protected state (from OCP, OVP, OT, PF, or INH). Note also that Pin 2 serves as the isolated common for pin 1. When pin 1 is set to the FAULt function, the instrument ignores any commands to program pin 2. Queries of pin 2 will return FAULt. If pin 1 is changed from FAULt to another function, pin 2 is set to DINPut.

INHibit Applies only to pin 3. When pin 3 is configured as an inhibit input, a true signal at the pin will disable all output channels.

```
[SOURCE:] DIGital:PIN1:POLarity POSitive | NEGative
[SOURCE:] DIGital:PIN2:POLarity POSitive | NEGative
[SOURCE:] DIGital:PIN3:POLarity POSitive | NEGative
[SOURCE:] DIGital:PIN4:POLarity POSitive | NEGative
[SOURCE:] DIGital:PIN5:POLarity POSitive | NEGative
[SOURCE:] DIGital:PIN6:POLarity POSitive | NEGative
[SOURCE:] DIGital:PIN7:POLarity POSitive | NEGative
[SOURCE:] DIGital:PIN<1-7>:POLarity?
```

These commands set the polarity of the digital port pins. The pin polarities are saved in non-volatile memory.

Setting a polarity to POSitive means that a logical true signal is a voltage high at the pin. Setting the polarity NEGative means that a logical true signal is a voltage low at the pin. For trigger inputs and outputs, POSitive means a rising edge; NEGative means a falling edge.

[SOURCE:] LIST:COUNT <count> | MIN | MAX | INF, (@<chanlist>)
 [SOURCE:] LIST:COUNT? [MIN | MAX,] (@<chanlist>)

This command sets the number of times that the list is executed before it is completed. Applies only to models with list capability. The range is 1 through 256. Use INFINITY to execute a list indefinitely. In this case, use ABORT:TRANSient to stop the list.

The *RST value = 1.

[SOURCE:] LIST:CURRENT[:LEVEL] <curr> {,<curr>}, (@<chanlist>)
 [SOURCE:] LIST:CURRENT[:LEVEL]? (@<chanlist>)

This command specifies the current setting for each list step in amperes. Applies only to models with list capability. A comma-delimited list of up to 512 steps may be programmed.

The *RST value = 1 step with a value of MIN.

[SOURCE:] LIST:CURRENT:POINTS? (@<chanlist>)

This query returns the number of points (steps) programmed in the current list. Applies only to models with list capability.

[SOURCE:] LIST:DWELL <time> {,<time>}, (@<chanlist>)
 [SOURCE:] LIST:DWELL? (@<chanlist>)

This command specifies the dwell time for each list step. Applies only to models with list capability. A comma-delimited list of up to 512 steps may be programmed. Dwell time is the time that the output will remain at a specific step. Dwell times can be programmed from 0 to 262.143 seconds with the following resolution:

Range in seconds	Resolution
0 to 0.262143	1 microsecond
0 to 2.62143	10 microseconds
0 to 26.2143	100 microseconds
0 to 262.143	1 millisecond

At the end of the dwell time, the output state of the unit depends upon the LIST:STEP program settings. See LIST:STEP

The order in which the values are entered determines the sequence when the list executes.

The *RST value = 1 step with a value of 0.001.

[SOURCE:] LIST:DWELL:POINTS? (@<chanlist>)

This query returns the number of points (steps) in the dwell list. Applies only to models with list capability.

[SOURCE:] LIST:STEP ONCE|AUTO, (@<chanlist>)
 [SOURCE:] LIST:STEP? (@<chanlist>)

This command specifies how the list responds to triggers. Applies only to models with list capability.

ONCE Causes the output to remain at the present step until a trigger advances it to the next step. Triggers that arrive during the dwell time are ignored.

AUTO Causes the output to automatically advance to each step, after the receipt of an initial starting trigger. The steps are paced by the dwell list. As each dwell time elapses, the next step is immediately output.

The *RST value = AUTO.

[SOURCE:] LIST:TERMinate:LAST ON|OFF, (@<chanlist>)
 [SOURCE:] LIST:TERMinate:LAST? (@<chanlist>)

This command determines the output value when the list terminates. Applies only to models with list capability. The state is either ON (1) or OFF (0). When ON, the output voltage or current remains at the value of the last list step. The value of the last voltage or current list step becomes the IMMEDIATE value when the list completes. When OFF, and also when the list is aborted, the output returns to the settings it was at before the list started.

The *RST value = OFF.

[SOURCE:] LIST:TOUTput:BOStep[:DATA] ON|OFF {,ON|OFF}, (@<chanlist>)
 [SOURCE:] LIST:TOUTput:BOStep[:DATA]? (@<chanlist>)

This command specifies which list steps generate a trigger out signal at the beginning of the list step (BOStep). Applies only to models with list capability. A comma-delimited list of up to 512 steps may be programmed. The state is either ON (1) or OFF (0). A trigger is only generated when the state is set to ON.

The *RST value = 1 step with a value of OFF.

[SOURCE:] LIST:TOUTput:EOStep[:DATA] ON|OFF {,ON|OFF}, (@<chanlist>)
 [SOURCE:] LIST:TOUTput:EOStep[:DATA]? (@<chanlist>)

This command specifies which list steps generate a trigger out signal at the end of the list step's (EOStep) dwell time. Applies only to models with list capability. A comma-delimited list of up to 512 steps may be programmed. The state is either ON (1) or OFF (0). A trigger is only generated when the state is set to ON.

The *RST value = 1 step with a value of OFF.

[SOURCE:] LIST:VOLTage[:LEVel] <volt> {,<volt>}, (@<chanlist>)
 [SOURCE:] LIST:VOLTage[:LEVel]? (@<chanlist>)

This command specifies the voltage setting for each list step in volts. Applies only to models with list capability. Up to 512 steps may be programmed. The values are separated by commas.

The *RST value = 1 step with a value of MIN.

[SOURCE:] LIST:VOLTage:POINTs? (@<chanlist>)

This query returns the number of points (steps) in the voltage list, not the point values. Applies only to models with list capability.

[SOURCE:] STEP:TOUTput ON|OFF, (@<chanlist>)

[SOURCE:] STEP:TOUTput? (@<chanlist>)

This command specifies whether an output trigger signal is generated when a transient voltage or current step occurs. The state is either ON (1) or OFF (0). A trigger is generated when the state is True.

The *RST value = OFF.

[SOURCE:] VOLTage[:LEVel] [:IMMediate] [:AMPLitude] <value>|MIN|MAX, (@<chanlist>)

[SOURCE:] VOLTage[:LEVel] [:IMMediate] [:AMPLitude]? [MIN|MAX,] (@<chanlist>)

[SOURCE:] VOLTage[:LEVel]:TRIGgered[:AMPLitude] <value>|MIN|MAX, (@<chanlist>)

[SOURCE:] VOLTage[:LEVel]:TRIGgered[:AMPLitude]? [MIN|MAX,] (@<chanlist>)

These commands set the immediate and the triggered voltage level of the output channel. The values are programmed in volts. The immediate level is the output voltage setting. The triggered level is a stored value that is transferred to the output when a Step transient is triggered. This command is coupled with [SOURCE:]VOLTage:RANGe.

The *RST value = MIN.

[SOURCE:] VOLTage:MODE FIXEd|STEP|LIST, (@<chanlist>)

[SOURCE:] VOLTage:MODE? (@<chanlist>)

These commands determine what happens to the output voltage when the transient system is initiated and triggered.

FIXEd The output voltage remains at the immediate value.

STEP The output goes to the triggered level when a trigger occurs.

LIST The output follows the programmed list step value when a trigger occurs. This function does not apply to all models (see Chapter 1, "Model Differences").

The *RST value = FIXEd.

[SOURCE:] VOLTage:PROTection:LEVel <value>|MIN|MAX, (@<chanlist>)

[SOURCE:] VOLTage:PROTection:LEVel? [MIN|MAX,] (@<chanlist>)

This command sets the over-voltage protection (OVP) level of the output channel. The values are programmed in volts. If the output voltage exceeds the OVP level, the output is disabled and the Questionable Condition status register OV bit is set. An over-voltage condition can be cleared with the Output Protection Clear command after the condition that caused the OVP trip is removed.

The *RST value = MAX.

[SOURce:] VOLTage:RANGe <value> | MIN | MAX, (@<chanlist>)
 [SOURce:] VOLTage:RANGe? [MIN | MAX,] (@<chanlist>)

This command only applies to models that have programmable ranges. Refer to Appendix A for the available ranges for each model.

This command sets the output voltage range. Units are in volts. The instrument selects the range with the best resolution for the value that is entered. When queried, the returned value is the maximum voltage that can be output on the range that is presently set.

This command is coupled with the [SOURce:]VOLTage command. This means that if a range command is sent that places an output on range with a lower maximum voltage than the present voltage level, an error is generated. This also occurs if a voltage level is programmed with a value too large for the present range.

These types of errors can be avoided by sending the both level and range commands in the same SCPI message. When the range and setting information is received as a set, no range/setting conflict occurs.

The *RST value = the highest available range.

NOTE

If programming a range value causes a range change to occur while the output is enabled, the output will be temporarily disabled while the range switch occurs. The transition from on-to-off and then from off-to-on will also be delayed by the settings of OUTPUT:DElay:FALL and OUTPUT:DElay:RISE.

[SOURce:] VOLTage:SLEW[:IMMediate] <value> | MIN | MAX | INF, (@<chanlist>)
 [SOURce:] VOLTage:SLEW[:IMMediate]? [MIN | MAX,] (@<chanlist>)

This command sets the voltage slew rate in volts per second. The slew rate setting affects all programmed voltage changes, including those due to the output state turning on or off. The slew rate can be set to any value between 0 and 9.9E37. For very large values, the slew rate will be limited by the analog performance of the output circuit. The keywords MAXimum or INFinity set the slew rate to maximum.

Internally, the slew rate is controlled by a 24-bit register. The slowest or minimum slew rate is a function of the full-scale voltage range. For a model with a 50 V range, the minimum slew rate is about 4.76 V/s. For other voltage ranges the minimum slew rate is proportional to this value, so for a model with a 5 V range the minimum slew rate is about 0.476 V/s. The unit accepts slew rates as low as 0 V/s, but values sent to the 24-bit register will be limited at 1 count.

The query returns the value that was sent, unless the value was less than the minimum slew rate, in which case the minimum value is returned. The LSB weight of the 24-bit register can be queried using VOLT:SLEW? MIN. The exact value varies slightly according to the voltage calibration.

The *RST value = 9.9E37.

Status Subsystem

Status register programming lets you determine the operating condition of the power system at any time. The power system has three groups of status registers; Operation, Questionable, and Standard Event. The Operation and Questionable status groups each consist of the Condition, Enable, and Event registers as well as NTR and PTR filters.

The Standard Event status group is also programmed using Common commands. Common commands control additional status functions such as the Service Request Enable and the Status Byte registers.

Operation Status Group

The Operation Status registers record signals that occur during normal operation. As shown below, the group consists of a Condition, PTR/NTR, Event, and Enable register. The outputs of the Operation Status register group are logically-ORed into the OPERation summary bit (7) of the Status Byte register.

Questionable Status Group

The Questionable Status registers record signals that indicate abnormal operation. As shown below, the group consists of the same register types as the Status Operation group. The outputs of the Questionable Status group are logically-ORed into the QUEStionable summary bit (3) of the Status Byte register.

Standard Event Status Group

The Standard Event registers are programmed by Common commands. The Standard Event event register latches events relating to communication status. It is a read-only register that is cleared when read. The Standard Event enable register functions similarly to the enable registers of the Operation and Questionable status groups.

Status Byte Register

This register summarizes the information from all other status groups as defined in the *IEEE 488.2 Standard Digital Interface for Programmable Instrumentation*.

MSS and RQS Bits

MSS is a real-time (unlatched) summary of all Status Byte register bits that are enabled by the Service Request Enable register. MSS is set whenever the power system has one or more reasons for requesting service. *STB? reads the MSS in bit position 6 of the response but does not clear any of the bits in the Status Byte register.

The RQS bit is a latched version of the MSS bit. Whenever the power system requests service, it sets the SRQ interrupt line true and latches RQS into bit 6 of the Status Byte register. When the controller

does a serial poll, RQS is cleared inside the register and returned in bit position 6 of the response. The remaining bits of the Status Byte register are not disturbed.

MAV Bit and Output Queue

The Output Queue is a first-in, first-out (FIFO) data register that stores power system-to-controller messages until the controller reads them. Whenever the queue holds one or more bytes, it sets the MAV bit (4) of the Status Byte register.

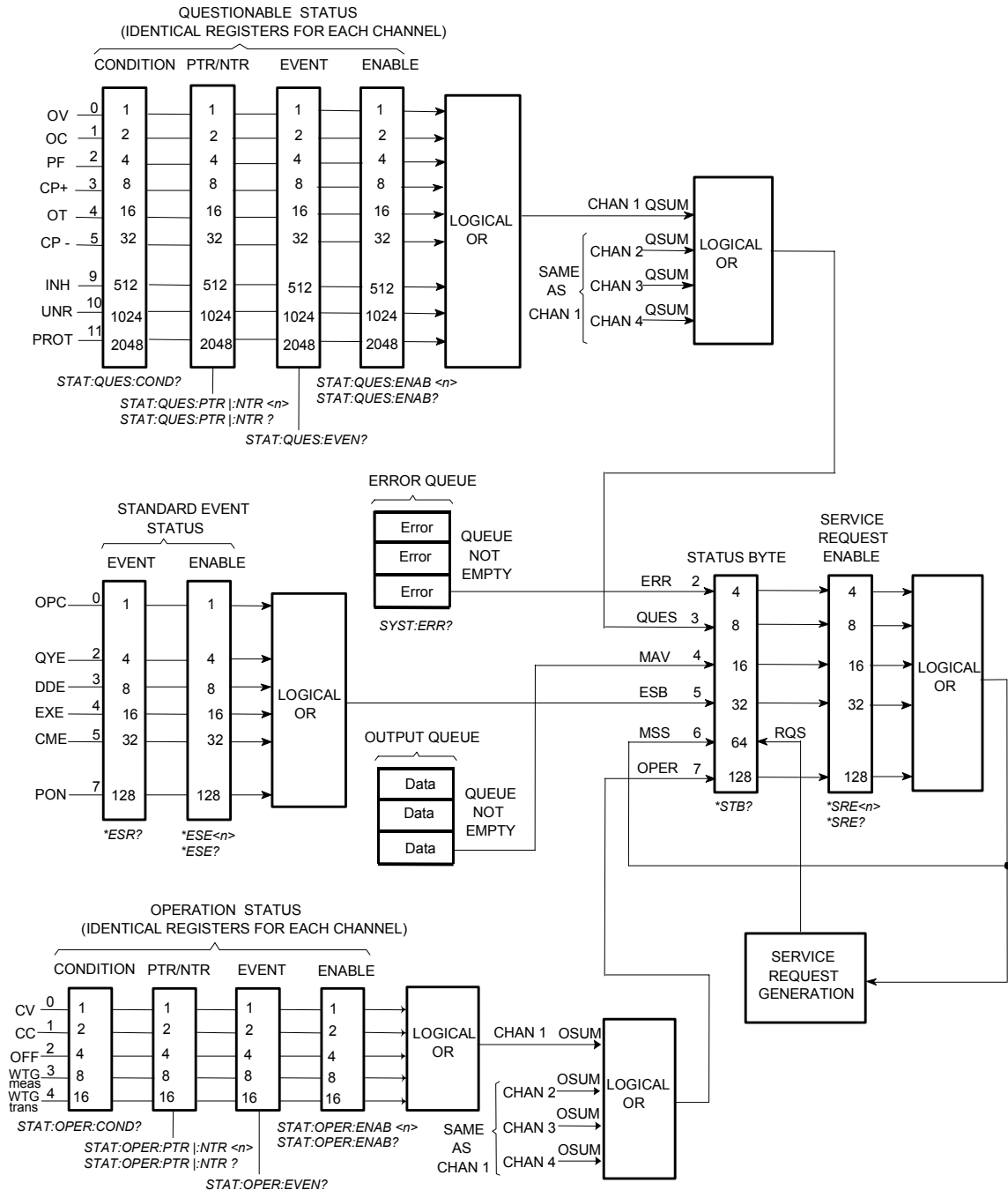

```

STATUS:OPERation:NTRansition <value>, (@<chanlist>)
STATUS:OPERation:PTRansition <value>, (@<chanlist>)
STATUS:OPERation:NTRansition? (@<chanlist>)
STATUS:OPERation:PTRansition? (@<chanlist>)

```

These commands set and read the value of the Operation NTR (Negative-Transition) and PTR (Positive-Transition) registers. These registers serve as polarity filters between the Operation Condition and Operation Event registers to cause the following actions:

- When a bit in the Operation NTR register is set to 1, then a 1-to-0 transition of the corresponding bit in the Operation Condition register causes that bit in the Operation Event register to be set.
- When a bit of the Operation PTR register is set to 1, then a 0-to-1 transition of the corresponding bit in the Operation Condition register causes that bit in the Operation Event register to be set.
- If the same bits in both NTR and PTR registers are set to 1, then any transition of that bit at the Operation Condition register sets the corresponding bit in the Operation Event register.
- If the same bits in both NTR and PTR registers are set to 0, then no transition of that bit at the Operation Condition register can set the corresponding bit in the Operation Event register.

```

STATUS:QUESTionable[:EVENT]? (@<chanlist>)

```

This query returns the value of the Questionable Event register. The Event register is a read-only register, which stores (latches) all events that are passed by the Questionable NTR and/or PTR filter. Reading the Questionable Event register clears it. The bit configuration of the Questionable status registers is as follows:

Bit Position	15-12	11	10	9	8-6	5	4	3	2	1	0
Bit Value	–	2048	1024	512	–	32	16	8	4	2	1
Bit Name	–	PROT	UNR	INH	–	CP–	OT	CP+	PF	OC	OV

PROT = The output has been disabled because it is coupled to a protection condition that occurred on another channel.

UNR = The output is unregulated

INH = The output is inhibited by an external signal

CP– = The output is limited by the negative power limit

OT = The over-temperature protection has tripped

CP+ = The output is limited by the positive power limit

PF = The output is disabled by the power-fail - which may be caused by a low-line or brownout condition on the AC line

OC = The output is disabled by the over-current protection

OV = The output is disabled by the over-voltage protection

```

STATUS:QUESTionable:CONDition? (@<chanlist>)

```

This query returns the value of the Questionable Condition register. That is a read-only register, which holds the real-time (unlatched) questionable status of the power system.

STATUS:QUESTIONABLE:ENABLE <value>, (@<chanlist>)
STATUS:QUESTIONABLE:ENABLE? (@<chanlist>)

This command and its query set and read the value of the Questionable Enable register. This register is a mask for enabling specific bits from the Questionable Event register to set the questionable summary bit (QUES) of the Status Byte register. This bit (bit 3) is the logical OR of all the Questionable Event register bits that are enabled by the Questionable Status Enable register.

STATUS:QUESTIONABLE:NTRANSITION <value>, (@<chanlist>)
STATUS:QUESTIONABLE:PTRANSITION <value>, (@<chanlist>)
STATUS:QUESTIONABLE:NTRANSITION? (@<chanlist>)
STATUS:QUESTIONABLE:PTRANSITION? (@<chanlist>)

These commands set or read the value of the Questionable NTR (Negative-Transition) and PTR (Positive-Transition) registers. These registers serve as polarity filters between the Questionable Condition and Questionable Event registers to cause the following actions:

- When a bit of the Questionable NTR register is set to 1, then a 1-to-0 transition of the corresponding bit of the Questionable Condition register causes that bit in the Questionable Event register to be set.
- When a bit of the Questionable PTR register is set to 1, then a 0-to-1 transition of the corresponding bit in the Questionable Condition register causes that bit in the Questionable Event register to be set.
- If the same bits in both NTR and PTR registers are set to 1, then any transition of that bit at the Questionable Condition register sets the corresponding bit in the Questionable Event register.
- If the same bits in both NTR and PTR registers are set to 0, then no transition of that bit at the Questionable Condition register can set the corresponding bit in the Questionable Event register.

***CLS**

This command causes the following actions on the status system:

- Clears the Standard Event Status, Operation Status Event, and Questionable Status Event registers
- Clears the Status Byte and the Error Queue
- If *CLS immediately follows a program message terminator (<NL>), then the output queue and the MAV bit are also cleared.

***ESE**
***ESE?**

This command programs the Standard Event Status Enable register bits. The programming determines which events of the Standard Event Status Event register (see *ESR?) are allowed to set the ESB (Event Summary Bit) of the Status Byte register. A "1" in the bit position enables the corresponding event.

All of the enabled events of the Standard Event Status Event Register are logically ORed to cause the Event Summary Bit (ESB) of the Status Byte Register to be set. The query reads the Standard Event Status Enable register. The bit configuration of the Standard Event register is as follows:

Bit Position	7	6	5	4	3	2	1	0
Bit Value	128	–	32	16	8	4	–	1
Bit Name	PON	–	CME	EXE	DDE	QUE	–	OPC
PON = Power-on has occurred				DDE = Device-dependent error				
CME = Command error				QUE = Query error				
EXE = Execution error				OPC = Operation complete				

***ESR?**

This query reads the Standard Event Status Event register. Reading the register clears it. The bit configuration is the same as the Standard Event Status Enable register (see *ESE).

***OPC**
***OPC?**

The command is mainly used for program synchronization. It causes the instrument to set the OPC bit (bit 0) of the Standard Event Status register when the instrument has completed all pending operations sent before the *OPC command. *Pending operations* are complete when:

- All commands sent before *OPC, including paralleled commands, have been completed. Most commands are sequential and are completed before the next command is executed. Commands that affect output voltage, current, or state, relays, and trigger actions are executed in parallel with subsequent commands. *OPC provides notification that all parallel commands have completed.
- All triggered actions are completed

*OPC does not prevent processing of subsequent commands, but the OPC bit will not be set until all pending operations are completed.

*OPC? causes the instrument to place an ASCII "1" in the Output Queue when all pending operations are completed. *OPC? does not suspend processing of commands.

SRE**SRE?**

This command sets the value of the Service Request Enable Register. This register determines which bits from the Status Byte Register are summed to set the Master Status Summary (MSS) bit and the Request for Service (RQS) summary bit. A 1 in any Service Request Enable Register bit position enables the corresponding Status Byte Register bit. All such enabled bits are then logically ORed to cause the MSS bit (bit 6) of the Status Byte Register to be set.

When the controller conducts a serial poll in response to SRQ, the RQS bit is cleared, but the MSS bit is not. When *SRE is cleared (by programming it with 0), the power system cannot generate an SRQ to the controller. The query returns the current state of *SRE.

***STB?**

This query reads the Status Byte register, which contains the status summary bits and the Output Queue MAV bit. Reading the Status Byte register does not clear it. The input summary bits are cleared when the appropriate event registers are read. The MAV bit is cleared at power-on, by *CLS, or when there is no more response data available.

A serial poll also returns the value of the Status Byte register, except that bit 6 returns Request for Service (RQS) instead of Master Status Summary (MSS). A serial poll clears RQS, but not MSS. When MSS is set, it indicates that the power system has one or more reasons for requesting service.

Bit Position	7	6	5	4	3	2	1 – 0
Bit Value	128	64	32	16	8	4	–
Bit Name	OPER	MSS (RQS)	ESB	MAV	QUES	ERR	–

OPER = Operation status summary MAV = Message available
MSS = Master status summary QUES = Questionable status summary
(RQS) = Request for service ERR = Error queue not empty
ESB = Event status byte summary

***WAI**

This command instructs the power system not to process any further commands until all pending operations are completed. Pending operations are as defined under the *OPC command. *WAI can be aborted only by sending the power system a Device Clear command.

System Commands

System commands control system functions that are not directly related to output control, measurement, or status functions. Common commands are also used to control system functions.

SYSTem:CHANnel[:COUNT]?

This query returns the number of output channels in a mainframe.

SYSTem:CHANnel:MODEl? (@<chanlist>)

This query returns the model numbers of the selected output channels. Model numbers are comma-delimited.

SYSTem:CHANnel:OPTion? (@<chanlist>)

This query returns a list of options installed in each channel given in the channel list. The list of options for each channel is surrounded by double quotes. If there are no options installed in a channel, an empty pair of double quotes is returned.

SYSTem:CHANnel:SERial? (@<chanlist>)

This query returns the serial numbers of the selected output channels. Serial numbers are comma-delimited.

SYSTem:COMMunicate:RLState LOCAL | REMote | RWLock SYSTem:COMMunicate:RLState?

This command configures the remote/local state of the instrument according to the following settings.

LOCAL The instrument is set to front panel and remote interface control.

REMOte The instrument is set to front panel and remote interface control.

RWLock The front panel keys are disabled. The instrument can only be controlled via the remote interface. This programmable setting is completely independent from the front panel lock/unlock function that is available from the front panel menu.

The remote/local state can also be set by interface commands over the GPIB and some other I/O interfaces. When multiple remote programming interfaces are active, the interface with the most recently changed remote/local state determines the instrument's remote/local state.

The remote/local state is unaffected by *RST or any commands other than SYSTem:COMMunicate:RLState. At power-on, the state is LOCAL.

SYSTem:COMMunicate:TCPip:CONTrol?

This query returns the control connection port number. This is used to open a control socket connection to the instrument. Refer to chapter 3 under "Using Sockets" for more information.

SYSTEM:ERRor?

This query returns the next error number and its corresponding message string from the error queue. The queue is a FIFO (first-in, first-out) buffer that stores errors as they occur. As it is read, each error is removed from the queue. When all errors have been read, the query returns 0, "No error". If more errors are accumulated than the queue can hold, the last error in the queue will be -350, "Too many errors" (see Appendix D for error codes).

SYSTEM:GRoup:CATalog?

This query returns information about channels that are grouped. The defined groups are enclosed in quotes. For example, the returned string "1,2,3", "4" indicates that channels 1, 2, and 3 are grouped. Channel 4 is not grouped, as it appears by itself in the quote string.

SYSTEM:GRoup:DEFine (@<chanlist>)

This command defines a list of output channels as a paralleled group. This effectively creates a single output with higher current and power capability. You can group up to four channels per mainframe. Channels must have identical model numbers and options installed.

After the channels are wired in parallel and defined as a group, they can be addressed using any of the channel-specific SCPI commands by sending the channel number of the **lowest** channel in the group.

Group channel lists are stored in non-volatile memory and are unaffected by *RST or *RCL. But the group channel settings (voltage, current, etc.) **are** set and saved by *RST or *RCL.

This command deletes any previously saved states. However, for the group changes to take effect, you must also reboot the unit. Either cycle AC power or send the SYSTEM:REBoot command.

SYSTEM:GRoup:DElete <channel>

This command removes the indicated channel from a group. It leaves the other channels in the group intact. When ungrouping a channel, you must also remove the parallel connections between the output and sense terminals of that channel.

This command deletes any previously saved states. However, for the group changes to take effect, you must also reboot the unit. Either cycle AC power or send the SYSTEM:REBoot command.

SYSTEM:GRoup:DElete:ALL

This command restores a group of channels that have been grouped back to an ungrouped state. When ungrouping channels, you must also remove all paralleled connections between channels.

This command deletes any previously saved states. However, for the group changes to take effect, you must also reboot the unit. Either cycle AC power or send the SYSTEM:REBoot command.

SYSTem:PASSword:FPANel:RESet

This command resets the front panel lockout password to the factory-shipped setting, which is zero (0). This command does not reset the calibration password.

NOTE

The front panel password can also be reset to 0 by setting an internal switch on the unit. This switch will also reset the calibration password to 0. Refer to Appendix B under "Calibration Switches" for more information.

SYSTem:REBoot

This command causes the instrument to reboot to its power-on state.

SYSTem:VERSion?

This query returns the SCPI version number to which the instrument complies. The returned value is of the form YYYY.V, where YYYY represents the year and V is the revision number for that year.

***IDN?**

This query requests the power system to identify itself. It returns a string of four fields separated by commas.

Field	Information
Agilent Technologies	Manufacturer
N67xxA	Mainframe model number followed by a letter suffix
0	Zero or mainframe serial number if available
<A>.xx.xx	Revision levels of firmware

***OPT?**

This query requests the mainframe to identify any installed options. A 0 indicates no options are installed.

***RCL <state>**

This command restores the power system to a state that was previously stored in memory locations 0 through 1 with the *SAV command. All instrument states are recalled except for the following:

- The trigger system is set to the Idle state by an implied ABORT command (this cancels any uncompleted trigger actions).
- Calibration is disabled by setting CALibration:STATE to OFF.
- All list settings are set to their *RST values.
- All status registers are set to their PRESet values.

NOTE

The device state stored in location 0 is automatically recalled at power turn-on when the Output Power-On state is set to RCL 0.

***RDT?**

This query returns a description of the output channels installed in a mainframe. Semicolons separate multiple channel descriptions.

Field	Information
CHAN <c> description	Channel number Description of the output channel

***RST**

This command resets the volatile memory of the power system to a factory-defined state (see “*RST Settings” at the beginning of this chapter).

*RST also forces the ABORt:ACQuire and ABORt:TRANsient commands. This cancels any measurement or output trigger actions presently in process, and resets the two WTG bits in the Status Operation Condition register.

SAV <state>*CAUTION**

This command causes a write cycle to nonvolatile memory. Nonvolatile memory has a finite maximum number of write cycles. Programs that repeatedly cause write cycles to nonvolatile memory can eventually exceed the maximum number of write cycles and cause the memory to fail.

This command stores the present state of the power system to the specified location in non-volatile memory. Up to 2 states can be stored - in locations 0 and 1. Any state previously stored in the same location will be overwritten. Use the *RCL command to retrieve instrument states. Refer to “*RST Settings” at the beginning of this chapter for a list of instrument settings that can be saved.

If a particular state is desired at power-on, it should be stored in location 0. It will then be automatically recalled at power turn-on if the Output Power-On state is set to RCL0.

Note that list data (and the calibration state) is not saved as part of the *SAV operation. This means that all list data that is sent to the instrument will be lost when the power system is turned off.

Also, data saved in non-volatile memory, described in the Non-volatile Factory Settings table at the end of chapter 3, is not affected by the *SAV command.

***TST?**

This query causes the power system to do a self-test and report any errors. A 0 indicates the power system passed self-test. A 1 indicates one or more tests failed. Selftest errors are written to the error queue (see Appendix D). Note that *TST? also forces an *RST command.

Trigger Subsystem

The Trigger subsystem consists of the Abort, Initiate, and Trigger commands.

Abort commands cancel any triggered actions.

Initiate commands initialize the trigger system. This enables the trigger system to receive triggers.

Trigger commands control the remote triggering of the power system. They specify the trigger source for the transient and the measurement system and also generate software triggers.

ABORt:ACQuire (@<chanlist>)
ABORt:TRANsient (@<chanlist>)

These commands cancel any measurement or transient trigger actions presently in process. The two WTG bits in the Status Operation Condition register are also reset. These commands are executed at power-on and upon execution of *RST.

INITiate[:IMMediate]:ACQuire (@<chanlist>)
INITiate[:IMMediate]:TRANsient (@<chanlist>)

These commands control the enabling of both measurement and transient triggers. When a trigger is initiated, an event on a selected trigger source causes the specified triggering action to occur. If the trigger system is not initiated, all triggers are ignored.

It takes a few milliseconds for the power supply to be ready to receive a trigger signal after receiving the INITiate command, and it can take longer if the value of SENSE:SWEep:OFFSet is negative. If a trigger occurs before the trigger system is ready for it, the trigger will be ignored. The user can test the WTG_MEAS bit in the operation status register to know when the power supply is ready to receive a trigger after initiating.

INITiate:CONTinuous:TRANsient ON|OFF, (@<chanlist>)
INITiate:CONTinuous:TRANsient? (@<chanlist>)

This command continuously initiates the output trigger system. The enabled state is ON (1); the disabled state is OFF (0). With continuous triggering disabled, the output trigger system must be initiated for each trigger using the INITiate:TRANsient command.

The *RST value = OFF.

TRIGger:ACQuire[:IMMediate] (@<chanlist>)

This command sends an immediate trigger to the measurement system. When the trigger system is initiated, a measurement trigger causes the power system to measure the output voltage or current and store the results in a buffer. The measured quantity, voltage or current is specified by the SENSE:FUNcTION command.

TRIGger:ACQuire:SOURce BUS | PIN<pin> | TRANsient<chan>, (@<chanlist>)
TRIGger:ACQuire:SOURce? (@<chanlist>)

This command selects the trigger source for the measurement trigger system. The following trigger sources can be selected:

BUS GPIB device trigger, *TRG, or <GET> (Group Execute Trigger).

PIN<pin> Selects an output port connector pin. Pins 1 – 3 can be configured as external trigger sources. [SOURce:]DIGital:PIN<n>:FUNctIon programs the function of each pin. [SOURce:]DIGital:PIN<n>:POLarity programs the polarity of each pin.

TRANsient<chan> Selects the transient system of an output channel as the trigger source. To generate triggers from the transient system use: [SOURce:]STEP:TOUTput, [SOURce:]LIST:TOUTput:BOStep, and [SOURce:]LIST:TOUTput:EOStep.

The *RST value = BUS.

TRIGger:TRANsient[:IMMediate] (@<chanlist>)

This command generates an immediate transient trigger regardless of the selected trigger source. Output triggers affect the following functions: voltage, current, and current limit. You must initiate the output trigger system before you can send any triggers.

When sent, the output trigger will:

- Initiate an output change as specified by the Current Triggered or Voltage Triggered commands.
- Clears the WTG-tran bit in the Status Operation Condition register after the transient trigger sequence has completed.

TRIGger:TRANsient:SOURce BUS | PIN<pin> | TRANsient<chan>, (@<chanlist>)
TRIGger:TRANsient:SOURce? (@<chanlist>)

This command selects the trigger source for the output trigger system. The following trigger sources can be selected:

BUS GPIB device trigger, *TRG, or <GET> (Group Execute Trigger).

PIN<pin> Selects an output port connector pin. Pins 1 – 3 can be configured as external trigger sources. [SOURce:]DIGital:PIN<n>:FUNctIon programs the function of each pin. [SOURce:]DIGital:PIN<n>:POLarity programs the polarity of each pin.

TRANsient<chan> Selects the transient system of an output channels as the trigger source. To generate triggers from the transient system use: [SOURce:]STEP:TOUTput, [SOURce:]LIST:TOUTput:BOStep, and [SOURce:]LIST:TOUTput:EOStep.

The *RST value = BUS.

*TRG

This command generates a trigger when the trigger subsystem has BUS selected as its source. The command has the same affect as the Group Execute Trigger (<GET>) command.

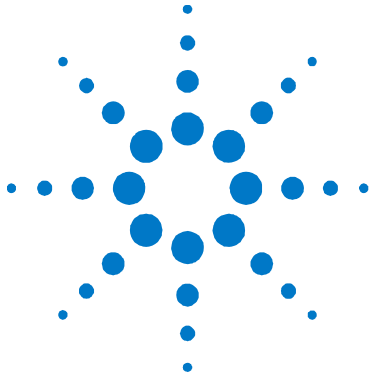

7

Programming Examples

Output Programming Example	110
List Programming Example	112
Digitizer Programming Example	114

This chapter contains several example programs to help you develop programs for your own application. The example programs are for illustration only, and are provided with the assumption that you are familiar with the programming language being demonstrated and the tools used to create and debug procedures. See Chapter 6, “Language Dictionary” for the SCPI command syntax.

You have a royalty-free right to use, modify, reproduce and distribute the example programs (and/or any modified version) in any way you find useful, provided you agree that Agilent Technologies has no warranty, obligations, or liability for any example programs.

The example programs are written in Microsoft Visual Basic 6.0 using the VISA COM IO library. The VISA COM library must be downloaded from the Automation-Ready CD-ROM to use these programs. For information about using VISA COM in another Visual Basic project, refer to “Programming Your Instruments” in the *USB/LAN/GPIB Interfaces Connectivity Guide*, also included on the Automation-Ready CD-ROM.

NOTE

Example programs for the following programming environments are also included on the Product-Reference CD-ROM located at the back of this guide:

- Microsoft Visual Basic 6.0
- Microsoft Visual C++ 6.0
- Microsoft Excel
- Agilent VEE Pro

The CD also contains IVI-COM and VXIplug&play drivers for your power system.

Output Programming Example

This is a simple program that sets a voltage, current, over-voltage, and the status of over-current protection. When done, the program checks for instrument error and gives a message if there is an error.

```
Sub output_programming_example()
  Dim IDN As String
  Dim GPIBaddress As String
  Dim ErrString As String

  ' This variable controls the channel number to be programmed
  Dim channel As String

  ' This variable controls the voltage
  Dim VoltSetting As Double

  ' This variable measures the voltage
  Dim MeasureVoltString As String

  ' This variable controls the current
  Dim CurrSetting As Double

  ' This variable controls the over voltage protection setting
  Dim overVoltSetting As Double

  'These variables are necessary to initialize the VISA COM.
  Dim ioMgr As AgilentRMLib.SRMCLs
  Dim Instrument As VisaComLib.FormattedIO488

  ' The following command line provides the program with the VISA name of the
  ' interface that it will communicate with. It is currently set to use GPIB.
  GPIBaddress = "GPIB0::5::INSTR"

  ' Use the following line instead for LAN communication
  ' TCPIPAddress="TCPIP0::141.25.36.214"

  ' Use the following line instead for USB communication
  ' USBaddress = "USB0::2391::1799::US00000002"

  ' Initialize the VISA COM communication
  Set ioMgr = New AgilentRMLib.SRMCLs
  Set Instrument = New VisaComLib.FormattedIO488
  Set Instrument.IO = ioMgr.Open(GPIBaddress)

  ' The next three command lines set the voltage, current, and over voltage
  VoltSetting = 3
  CurrSetting = 1.5                      ' amps
  overVoltSetting = 10

  ' This variable can be changed to program any channel in the mainframe
  channel = "@1"                          ' channel 1

  With Instrument
    ' Send a power reset to the instrument
    .WriteString "*RST"

    ' Query the instrument for the IDN string
    .WriteString "*IDN?"
    IDN = .ReadString
  End With
End Sub
```

```

' Set the voltage
.WriteString "VOLT" & Str$(VoltSetting) & "," & channel

' Set the over voltage level
.WriteString "VOLT:PROT:LEV " & Str$(overVoltSetting) & "," & channel

' Set current level
.WriteString "CURR " & Str$(CurrSetting) & "," & channel

' Turn on over current protection
.WriteString "CURR:PROT:STAT ON," & channel

' Turn the output on
.WriteString "OUTP ON," & channel

' Wait for previous commands to complete.
.WriteString "*OPC?"
.ReadString

' Measure the voltage
.WriteString "MEAS:VOLT? " & channel
MeasureVoltString = .ReadString
MsgBox "Measured Voltage is " & MeasureVoltString & "At channel" & channel

' Check instrument for any errors
.WriteString "Syst:err?"
ErrString = .ReadString

' give message if there is an error
If Val(ErrString) Then
    MsgBox "Error in instrument!" & vbCrLf & ErrString
End If
End With
End Sub

```

List Programming Example

This program executes a 10 point current and voltage list. It also specifies 10 different dwell times. When done, the program checks for instrument error and gives a message if there is an error.

```

Sub list_programming_example()
  Dim IDN As String
  Dim GPIBAddress As String
  Dim ErrString As String
  Dim channel As String

  'These variable are necessary to initialize the VISA COM.
  Dim ioMgr As AgilentRMLib.SRMCLs
  Dim Instrument As VisaComLib.FormattedIO488

  ' The following command line provides the program with the VISA name of the
  ' interface that it will communicate with. It is currently set to use GPIB.
  GPIBAddress = "GPIB1::5::INSTR"

  ' Use the following line instead for LAN communication
  ' TCPIPAddress="TCPIP0::141.25.36.214"

  ' Use the following line instead for USB communication
  ' USBAddress = "USB0::2391::1799:US00000002"

  ' Initialize the VISA COM communication
  Set ioMgr = New AgilentRMLib.SRMCLs
  Set Instrument = New VisaComLib.FormattedIO488
  Set Instrument.IO = ioMgr.Open(GPIBAddress)

  ' These next three strings are the points in the list.
  ' All three strings are the same length.
  ' The first one controls voltage, the second current, and the third dwell time
  Const voltPoints = "1,2,3,4,5,6,7,8,9,10"
  Const currPoints = "0.5,1,1.5,2,2.5,3,3.5,4,4.5,5"
  Const dwellPoints = "1,2,0.5,1,0.25,1.5,0.1,1,0.75,1.2"

  ' This variable can be changed to program any channel in the mainframe
  channel = "@1" ' channel 1

  With Instrument
    ' Send a power reset to the instrument
    .WriteString "*RST"

    ' Query the instrument for the IDN string
    .WriteString "*IDN?"
    IDN = .ReadString

    ' Set the voltage mode to list
    .WriteString "VOLT:MODE LIST," & channel

    ' Set the current mode to list
    .WriteString "CURR:MODE LIST," & channel

    ' Send the voltage list points
    .WriteString "LIST:VOLT " & voltPoints & "," & channel

    ' Send the Current list points
    .WriteString "LIST:CURR " & currPoints & "," & channel
  End With
End Sub

```



```
' Send the dwell points
.WriteString "LIST:DWEL " & dwellPoints & "," & channel

' Turn the output on
.WriteString "OUTP ON," & channel

' Wait for output to settle in the ON state.
.WriteString "*OPC?"
.ReadString

' Set the trigger source to bus
.WriteString "TRIG:TRAN:SOUR BUS," & channel

' Initiate the transient system
.WriteString "INIT:TRAN " & channel

' Trigger the unit
.WriteString "*TRG"

' Check instrument for any errors
.WriteString "Syst:err?"
ErrString = .ReadString

' give message if there is an error
If Val(ErrString) Then
    MsgBox "Error in instrument!" & vbCrLf & ErrString
End If
End With
End Sub
```

Digitizer Programming Example

This program uses the voltage in step mode and also demonstrates how to set up and use the digitizer. When done, the program checks for instrument error and gives a message if there is an error.

```

Sub digitizer_programming_example()
  Dim IDN As String
  Dim GPIBaddress As String
  Dim ErrString As String
  Dim channel As String
  Dim measPoints As Long
  Dim measOffset As Long
  Dim VoltSetting As Double
  Dim finalVoltage As Double
  Dim timeInterval As Double
  Dim VoltPoints() As Variant
  Dim i As Long
  Const WTG_MEAS = 8
  Const WTG_TRANS = 16

  'These variables are necessary to initialize the VISA COM.
  Dim ioMgr As AgilentRMLib.SRMCLs
  Dim Instrument As VisaComLib.FormattedIO488

  ' The following command line provides the program with the VISA name of the
  ' interface that it will communicate with. It is currently set to use GPIB.
  GPIBaddress = "GPIB0::5::INSTR"

  ' Use the following line instead for LAN communication
  ' TCPIPAddress="TCPIP0::141.25.36.214"

  ' Use the following line instead for USB communication
  ' USBAddress = "USB0::2391::1799::US00000002"

  ' Initialize the VISA COM communication
  Set ioMgr = New AgilentRMLib.SRMCLs
  Set Instrument = New VisaComLib.FormattedIO488
  Set Instrument.IO = ioMgr.Open(GPIBaddress)

  ' This controls the number of points the measurement system measures
  measPoints = 100

  ' This controls the number of points to offset the measurement (positive for
  ' forward, negative for reverse)
  measOffset = 0

  ' This sets the time between points
  timeInterval = 0.0025

  ' This controls the voltage
  VoltSetting = 5

  ' This is the final voltage that will be triggered
  finalVoltage = 10

  ' This variable can be changed to program any channel in the mainframe
  channel = "@1"          ' channel 1

```

```

With Instrument
' Send a power reset to the instrument
.WriteString "*RST"

' Query the instrument for the IDN string
.WriteString "*IDN?"
IDN = .ReadString

' Put the Voltage into step mode which causes it to transition from one
' voltage to another upon receiving a trigger
.WriteString "VOLT:MODE STEP," & channel

' Set the voltage
.WriteString "VOLT" & Str$(VoltSetting) & "," & channel

' Go to final value
.WriteString "VOLT:TRIG" & Str$(finalVoltage) & "," & channel

' Turn the output on
.WriteString "OUTP ON," & channel

' Wait for output to turn on.
.WriteString "*OPC?"
.ReadString

' Set the bus as the transient trigger source
.WriteString "TRIG:TRAN:SOUR BUS," & channel

' Set the number of points for the measurement system to use as an offset
.WriteString "SENS:SWE:OFFS:POIN" & Str$(measOffset) & "," & channel

' Set the number of points that the measurement system uses
.WriteString "SENS:SWE:POIN" & Str$(measPoints) & "," & channel

' Set the time interval between points
.WriteString "SENS:SWE:TINT" & Str$(timeInterval) & "," & channel

' Set the measurement trigger source
.WriteString "TRIG:ACQ:SOUR BUS," & channel

' Initiate the measurement trigger system
.WriteString "INIT:ACQ " & channel

' Initiate the transient trigger system
.WriteString "INIT:TRAN " & channel

' Wait for INITiate commands to complete
Do
    .WriteString "STAT:OPER:COND? " & channel
    Status = .ReadString
Loop Until (Status And (WTG_MEAS + WTG_TRANS)) = (WTG_MEAS + WTG_TRANS)

' Trigger the unit
.WriteString "*TRG"

' Read back the voltage points
.WriteString "FETC:ARR:VOLT? " & channel
VoltPoints = .ReadList

' Print the first 10 voltage points
For i = 0 To 9
    Debug.Print i, VoltPoints(i)
Next i

```

7 Programming Examples

```
' Check instrument for any errors
.WriteString "Syst:err?"
ErrString = .ReadString

' give message if there is an error
If Val(ErrString) Then
    MsgBox "Error in instrument!" & vbCrLf & ErrString
End If
End With

End Sub
```

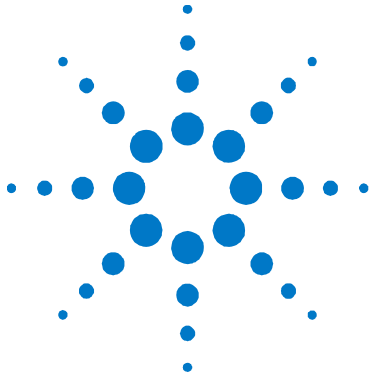

Appendix A Specifications

Performance Specifications	118
Supplemental Characteristics	121
Autoranging Characteristic	128
Outline Diagram	128

This chapter lists the specifications and supplemental characteristics of the Agilent N6700 Modular Power System. A dimensional line drawing of the mainframe is included at the end of the chapter.

Unless otherwise noted, specifications are warranted over the ambient temperature range of 0 to 55°C. Sensing is at the output terminals of the power system after a 30-minute warm-up period. Sense terminals must be externally jumpered to their respective output terminals.

Supplemental characteristics are not warranted but are descriptions of performance determined either by design or type testing. All supplemental characteristics are typical unless otherwise noted.

Performance Specifications

Agilent Models N6751A/N6752A and N6761A/N6762A

	N6751A / N6752A	N6761A / N6762A
DC Output Ratings:		
Voltage	50 V	50 V
Current (derated 1% per °C above 40°C)	5 A / 10A	1.5 A / 3 A
Power	50 W / 100 W	50 W / 100 W
Output Ripple and Noise (PARD): (from 20 Hz – 20 MHz)		
CV peak-to-peak ^{NOTE 1}	6 mV	6 mV
CV rms	1 mV	1 mV
Load Effect (Regulation) (for any output load change, with a maximum load-lead drop of 1V/lead)		
Voltage	2 mV	0.5 mV
Current (@ 0 - 7 V)	2 mA	30 μ A ^{NOTE 2}
(@ 0 - 50 V)	2 mA	65 μ A
Source Effect (Regulation):		
Voltage	1 mV	0.5 mV
Current	1 mA	30 μ A
Programming Accuracy: (@ 23 °C \pm 5 °C after 30 min. warm-up. Applies from min. to max. programming range)		
Voltage high range	0.06% + 19 mV	0.016% + 6 mV
Voltage low range (\leq 5.5 V)	N/A	0.016% + 1.5 mV
Current high range	0.1% + 20 mA	0.04% + 200 μ A
Current low range (\leq 100 mA, @ 0 - 7 V)	N/A	0.04% + 15 μ A
(\leq 100 mA, @ 0 - 50 V)	N/A	0.04% + 55 μ A
Measurement Accuracy: (at 23 °C \pm 5 °C)		
Voltage high range	0.05% + 20 mV	0.016% + 6 mV
Voltage low range (\leq 5.5 V)	N/A	0.016% + 1.5 mV
Current high range	0.1% + 4 mA	0.04% + 160 μ A
Current low range (\leq 100 mA, @ 0 - 7 V)	N/A	0.03% + 15 μ A ^{NOTE 2}
(\leq 100 mA, @ 0 - 50 V)	N/A	0.03% + 55 μ A
Load Transient Recovery Time: (time to recover to within the settling band following a load change - from 60% to 100% and from 100% to 60% of full load for models N6751A & N6761A - from 50% to 100% and from 100% to 50% of full load for models N6752A & N6762A.)		
Voltage settling band	\pm 75 mV ^{NOTE 3}	\pm 75 mV
Time	< 100 μ s	< 100 μ s

¹ For typical values, refer to Supplemental Characteristics.

² Applies when measuring 4096 data points (SENSe:SWEep:POINts = 4096).

³ Settling band is \pm 125 mV for Model N6752A when relay option 761 is installed.

Agilent Models N6731A - N6735A and N6742A - N6745A

	N6731A	N6732A/N6742A	N6733A/N6743A	N6734A/N6744A	N6735A/N6745A
DC Output Ratings:					
Voltage	5 V	8 V	20 V	35 V	50 V
Current ^{NOTE 1}	10 A	6.25 A / 10 A	2.5 A / 5 A	1.5 A / 3 A	0.8 A / 1.6 A
Power	50 W	50 W / 80 W	50 W / 100 W	52.5 W / 105 W	40 W / 80 W
Output Ripple and Noise (PARD): (from 20 Hz – 20 MHz)					
CV peak-to- peak	10 mV	12 mV	14 mV	15 mV	20 mV
CV rms	2 mV	2 mV	3 mV	5 mV	9 mV
Load Effect (Regulation): (with output change from no load to full load, up to a maximum load-lead drop of 1V/lead)					
Voltage	2 mV	2 mV	2 mV	4 mV	6 mV
Current	2 mA	2 mA	2 mA	2 mA	2 mA
Source Effect (Regulation):					
Voltage	1 mV	2 mV	2 mV	4 mV	6 mV
Current	1 mA	1 mA	1 mA	1 mA	1 mA
Programming Accuracy: (@ 23 °C ±5 °C after 30 minute warm-up. Applies from minimum to maximum programming range)					
Voltage	0.1% + 19 mV	0.1% + 19 mV	0.1% + 20 mV	0.1% + 35 mV	0.1% + 60 mV
Current	0.15% + 20 mA	0.15% + 20 mA	0.15% + 20 mA	0.15% + 20 mA	0.15% + 20 mA
Measurement Accuracy: (at 23 °C ±5 °C)					
Voltage	0.1% + 20 mV	0.1% + 20 mV	0.1% + 20 mV	0.1% + 35 mV	0.1% + 60 mV
Current	0.15% + 20 mA	0.15% + 10 mA	0.15% + 5 mA	0.15% + 4 mA	0.15% + 4 mA
Load Transient Recovery Time: (time to recover to within the settling band following a load change from 50% to 100% and from 100% to 50% of full load.)					
Voltage settling band	± 80mV	± 80mV	± 200mV	± 200mV	± 200mV
Time	< 200 μs	< 200 μs	< 200 μs	< 200 μs	< 200 μs

¹ Output current is derated 1% per °C above 40°C.

Agilent Models N6731B - N6736B and N6741B - N6746B

	N6731B/ N6741B	N6732B/ N6742B	N6733B/ N6743B	N6734B/ N6744B	N6735B/ N6745B	N6736B/ N6746B
DC Output Ratings:						
Voltage	5 V	8 V	20 V	35 V	60 V	100 V
Current ^{NOTE 1}	10 A / 20 A	6.25 A / 12.5 A	2.5 A / 5 A	1.5 A / 3 A	0.8 A / 1.6 A	0.5 A / 1 A
Power	50 W / 100 W	50 W / 100 W	50 W / 100 W	52.5W / 105W	50 W / 100 W	50 W / 100 W
Output Ripple and Noise (PARD): (from 20 Hz – 20 MHz)						
CV peak-to- peak	10 mV / 11mV	12 mV	14 mV	15 mV	25 mV	30 mV
CV rms	2 mV	2 mV	3 mV	5 mV	9 mV	18 mV
Load Effect (Regulation): (with output change from no load to full load, up to a maximum load-lead drop of 1V/lead)						
Voltage	5 mV	6 mV	9 mV	11 mV	13 mV / 16 mV	20 mV / 30 mV
Current	2 mA	2 mA	2 mA	2 mA	2 mA	2 mA
Source Effect (Regulation):						
Voltage	1 mV	2 mV	2 mV	4 mV	6 mV	10 mV
Current	1 mA	1 mA	1 mA	1 mA	1 mA	1 mA
Programming Accuracy: (@ 23 °C ±5 °C after 30 minute warm-up. Applies from minimum to maximum programming range)						
Voltage	0.1% + 19 mV	0.1% + 19 mV	0.1% + 20 mV	0.1% + 35 mV	0.1% + 60 mV	0.1% +100 mV
Current	0.15% + 20 mA	0.15% + 20 mA	0.15% + 20 mA	0.15% + 20 mA	0.15% + 20 mA	0.15% + 10mA
Measurement Accuracy: (at 23 °C ±5 °C)						
Voltage	0.1% + 20 mV	0.1% + 20 mV	0.1% + 20 mV	0.1% + 35 mV	0.1% + 60 mV	0.1% +100 mV
Current	0.15% + 20 mA	0.15% + 10 mA	0.15% + 5 mA	0.15% + 4 mA	0.15% + 4 mA	0.15% + 2 mA
Load Transient Recovery Time: (time to recover to within the settling band following a load change from 50% to 100% and from 100% to 50% of full load.)						
Voltage settling band	± 0.08V / 0.1 V	± 0.08V / 0.1 V	± 0.2 V / 0.3 V	± 0.2 V / 0.3 V	± 0.4 V / 0.5 V	± 0.5 V / 1.0 V
Time	< 200 μs	< 200 μs	< 200 μs	< 200 μs	< 200 μs	< 200 μs

¹ Output current is derated 1% per °C above 40°C.

Supplemental Characteristics

Agilent Models N6751A/N6752A and N6761A/N6762A

	N6751A / N6752A	N6761A / N6762A
Programming Ranges:		
Voltage high range	20 mV – 51 V	15 mV – 51 V
Voltage low range (≤ 5.5 V)	N/A	12 mV – 5.5 V
Current high range	10 mA - 5.1A/10 mA- 10.2A	1 mA - 1.53 A/1 mA - 3.06 A
Current low range (≤ 0.1 A)	N/A	0.1 mA – 0.1 A ^{NOTE 1}
Programming Resolution:		
Voltage high range	3.5 mV	880 μ V
Voltage low range (≤ 5.5 V)	N/A	90 μ V
Current high range	3.25 mA	60 μ A
Current low range (≤ 0.1 A)	N/A	2 μ A
Measurement Resolution:		
Voltage high range	1.8 mV	440 μ V
Voltage low range (≤ 5.5 V)	N/A	44 μ V
Current high range	410 μ A	30 μ A
Current low range (≤ 0.1 A)	N/A	1 μ A
Programming Temperature Coefficient per °C:		
Voltage high range	18 ppm + 160 μ V	18 ppm + 140 μ V
Voltage low range (≤ 5.5 V)	N/A	40 ppm + 70 μ V
Current high range	100 ppm + 45 μ A	33 ppm + 10 μ A
Current low range (≤ 0.1 A)	N/A	60 ppm + 1.5 μ A
Measurement Temperature Coefficient per °C:		
Voltage high range	25 ppm + 35 μ V	23 ppm + 40 μ V
Voltage low range (≤ 5.5 V)	N/A	30 ppm + 40 μ V
Current high range	60 ppm + 3 μ A	40 ppm + 0.3 μ A
Current low range (≤ 0.1 A)	N/A	50 ppm + 0.3 μ A
Output Ripple and Noise (PAR):		
CV peak-to-peak (typical value)	4 mV	4 mV
CC rms:	2 mA	2 mA
Common Mode Noise: (from 20 Hz – 20 MHz; from either output to chassis)		
rms	500 μ A	500 μ A
peak-to-peak	< 2 mA	< 2 mA
Over-voltage Protection:		
Accuracy	0.25% + 250 mV	0.25% + 250 mV
Maximum setting	55 V	55 V
Response time	50 μ s from occurrence of over-voltage condition to start of output shutdown	

¹ If you are operating the unit below 255 μ A in constant current mode, the output may become unregulated with the following load conditions: The load resistance is <175 m Ω and the load inductance is >20 μ H. If this occurs, an UNRegulated flag will be generated and the output current may rise above the programmed value but will remain less than 255 μ A.

Agilent Models N6751A/N6752A and N6761A/N6762A (continued)

	N6751A / N6752A	N6761A / N6762A
Maximum Up-programming Time with full resistive load: (time from 10% to 90% of total voltage excursion)		
Voltage setting from 0 V to 10 V	0.2 ms	0.6 ms
Voltage setting from 0 V to 50 V	1.5 ms	2.2 ms
Maximum Up-programming Settling Time with full resistive load: (time from start of voltage change to within 50mV of final value)		
Voltage setting from 0 V to 10 V	0.5 ms	0.9 ms
Voltage setting from 0 V to 50 V	4.0 ms	4.0 ms
Maximum Down-programming Time with no load: (time from start of voltage change to output voltage < 0.5 V)		
Voltage setting from 10 V to 0 V	0.3 ms	0.3 ms
Voltage setting from 50 V to 0 V	1.3 ms	1.3 ms
Maximum Down-programming Settling Time with no load: (time from start of voltage change to output voltage within 50mV of final value)		
Voltage setting from 10 V to 0 V	0.45 ms	0.45 ms
Voltage setting from 50 V to 0 V	1.4 ms	1.4 ms
Down-programming Time with 1000 μF load: ^{NOTE 2} (time from start of voltage change to output voltage < 0.5 V)		
Voltage setting from 10 V to 0 V	2.1 ms	4.5 ms
Voltage setting from 50 V to 0 V	11 ms	23 ms
Down-programming Capability:		
Continuous power	7 W	7 W
Peak current	7 A	3.8 A
Remote Sense Capability:		
Outputs can maintain specifications with up to a 1-volt drop per load lead.		
Series and Parallel Operation:		
Identically rated outputs can be operated directly in parallel or can be connected for straight series operation. Auto-series and auto-parallel operation is not available.		
Load Cross Regulation:		
Voltage, from no load to full load	1 mV	0.5 mV
Current, from no load to full load	1 mA	5 μ A

² Modules can discharge a 1000 μ F capacitor from 50V to 0V at a rate of 4 times/second.

Agilent Models N6751A/N6752A and N6761A/N6762A Output Impedance Graphs

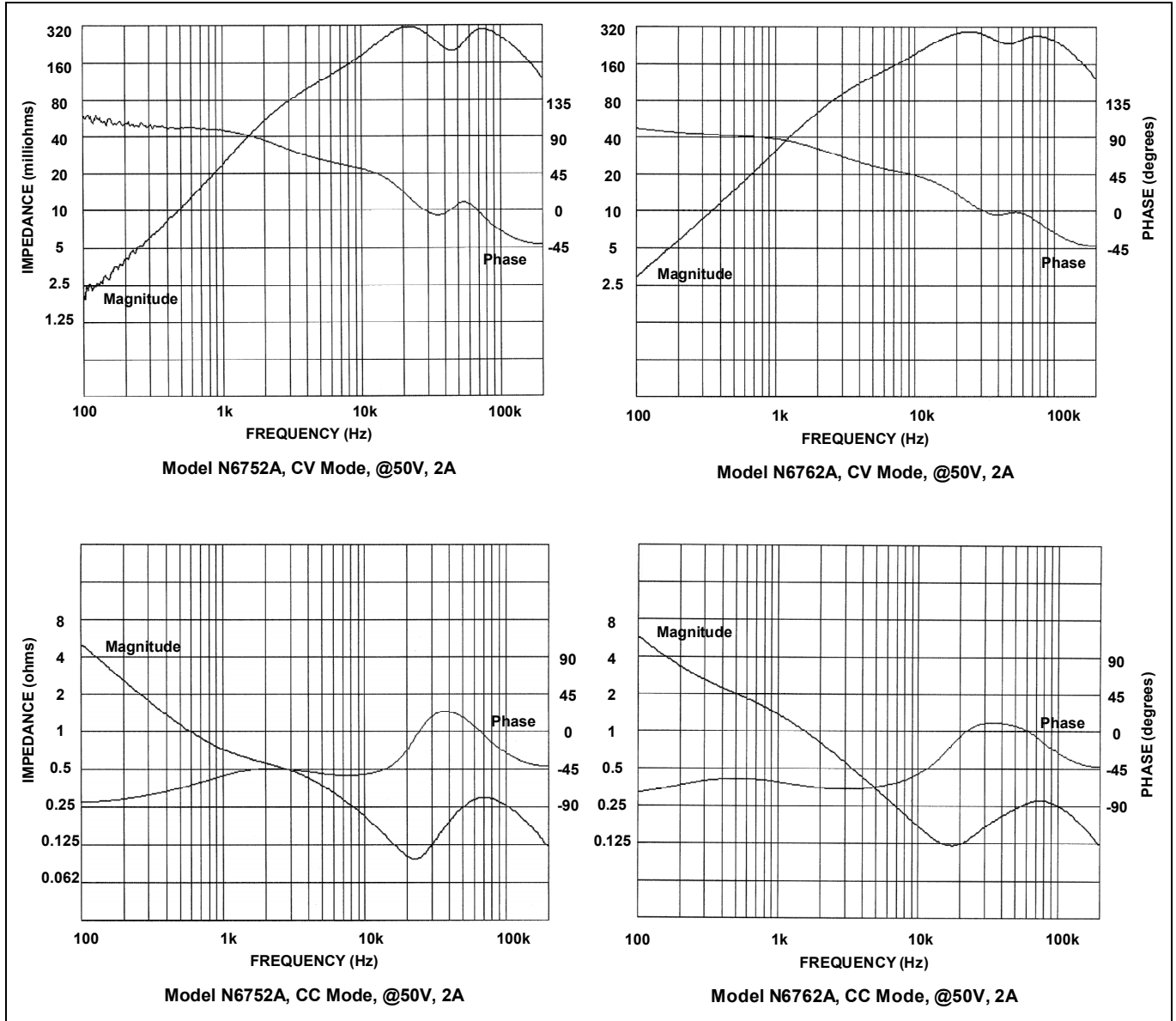

Agilent Models N6731A - N6735A and N6742A - N6745A

	N6731A	N6732A/N6742A	N6733A/N6743A	N6734A/N6744A	N6735A/N6745A
Programming Ranges:					
Voltage	20 mV – 5.1 V	20 mV – 8.16 V	20 mV – 20.4 V	20 mV – 35.7 V	20 mV – 51 V
Current	10 mA – 10.2 A	10 mA – 6.375 A/ 10 mA – 10.2 A	10 mA – 2.55 A/ 10 mA – 5.1 A	10 mA – 1.53 A/ 10 mA – 3.06 A	10 mA – 0.816 A/ 10 mA – 1.63 A
Programming Resolution:					
Voltage	3.5 mV	4 mV	5 mV	9 mV	13 mV
Current	5 mA	3.25 mA	3.25 mA	3.25 mA	3.25 mA
Measurement Resolution:					
Voltage	3 mV	4 mV	10 mV	18 mV	30 mV
Current	10 mA	7 mA	3 mA	2 mA	1 mA
Output Ripple and Noise (PARD):					
CC rms	8 mA	4 mA	2 mA	2 mA	2 mA
Common Mode Noise: (from 20 Hz – 20 MHz; from either output to chassis)					
Rms	1 mA	1 mA	1 mA	1 mA	1 mA
peak-to-peak	< 10 mA	< 10 mA	< 10 mA	< 10 mA	< 10 mA
Over-voltage Protection:					
Accuracy	0.25% + 250 mV	0.25% + 250 mV	0.25% + 250 mV	0.25% + 250 mV	0.25% + 300 mV
Maximum setting	7 V	10 V	22 V	38.5 V	55 V
Response time	50 μ s from occurrence of over-voltage condition to start of output shutdown				
Maximum Up-programming and Down-programming Time with full resistive load: (time from 10% to 90% of total voltage excursion)					
Voltage setting from 0 V to full scale and full scale to 0V	10 ms	10 ms	10 ms	10 ms	10 ms
Maximum Up-programming and Down-programming Settling Time with full resistive load: (time from start of voltage change until voltage settles within 0.1% of the full-scale voltage of its final value)					
Voltage setting from 0 V to full scale and full scale to 0V	100 ms	100 ms	100 ms	100 ms	100 ms
Remote Sense Capability:					
Outputs can maintain specifications with up to a 1-volt drop per load lead.					
Series and Parallel Operation:					
Identically rated outputs can be operated directly in parallel or can be connected for straight series operation. Auto-series and auto-parallel operation is not available.					

Agilent Models N6731B - N6736B and N6741B - N6746B

	N6731B/ N6741B	N6732B/ N6742B	N6733B/ N6743B	N6734B/ N6744B	N6735B/ N6745B	N6736B/ N6746B
Programming Ranges:						
Voltage	15 mV – 5.1 V	15 mV – 8.16 V	30 mV – 20.4 V	40 mV – 35.7 V	70 mV – 61.2 V	100 mV – 102 V
Current	60 mA – 10.2 A/ 60 mA – 20.4 A	40 mA – 6.375 A/ 40 mA – 12.75 A	10 mA – 2.55 A/ 10 mA – 5.1 A	5 mA – 1.53 A/ 5 mA – 3.06 A	2.5 mA – 0.85 A/ 2.5 mA – 1.7 A	1.5 mA – 0.51 A/ 1.5 mA – 1.02 A
Programming Resolution:						
Voltage	3.5 mV	4 mV	7 mV	10 mV	18 mV	28 mV
Current	7 mA	4 mA	3 mA	2 mA	1 mA	0.5 mA
Measurement Resolution:						
Voltage	3 mV	4 mV	10 mV	18 mV	30 mV	50 mV
Current	10 mA	7 mA	3 mA	2 mA	1 mA	0.5 mA
Output Ripple and Noise (PARD):						
CC rms	8 mA	4 mA	2 mA	2 mA	2 mA	2 mA
Common Mode Noise: (from 20 Hz – 20 MHz; from either output to chassis)						
Rms	1 mA	1 mA	1 mA	1 mA	1 mA	1 mA
Peak-to- peak	< 15 mA	< 10 mA	< 10 mA	< 10 mA	< 10 mA	< 10 mA
Over-voltage Protection:						
Accuracy	0.25% + 50mV	0.25% + 50 mV	0.25% + 75 mV	0.25% + 100 mV	0.25% + 200 mV	0.25% + 250 mV
Maximum setting	7.5 V	10 V	22 V	38.5 V	66 V	110 V
Response time	50 μ s from occurrence of over-voltage condition to start of output shutdown					
Maximum Up-programming and Down-programming Time with full resistive load: (time from 10% to 90% of total voltage excursion)						
Voltage setting from 0 V to full scale and full scale to 0V	20 ms	20 ms	20 ms	20 ms	20 ms	20 ms
Maximum Up-programming and Down-programming Settling Time with full resistive load: (time from start of voltage change until voltage settles within 0.1% of the full-scale voltage of its final value)						
Voltage setting from 0 V to full scale and full scale to 0V	100 ms	100 ms	100 ms	100 ms	100 ms	100 ms
Remote Sense Capability: Outputs can maintain specifications with up to a 1-volt drop per load lead.						
Series and Parallel Operation: Identically rated outputs can be operated directly in parallel or can be connected for straight series operation. Auto-series and auto-parallel operation is not available.						

Agilent N6700A/B MPS Mainframe

N6700A/B

Command Processing Time:

From receipt of command to start of the output change ≤ 1 ms

Protection Response Characteristics:

INH input 5 μs from receipt of inhibit to start of shutdown
 Fault on coupled outputs < 10 μs from receipt of fault to start of shutdown

Digital Control Characteristics: NOTE 1

Maximum voltage ratings +16.5 VDC/– 5 VDC between pins (pin 8 is internally connected to chassis ground).

Pins 1 and 2 as FLT output
 Maximum low-level output voltage = 0.5 V @ 4 mA
 Maximum low-level sink current = 4 mA
 Typical high-level leakage current = 0.14 mA @ 16.5 VDC

Pins 1 - 7 as digital/trigger outputs (pin 8 = common)
 Maximum low-level output voltage = 0.5 V @ 4 mA; 1 V @ 50 mA; 1.75 V @ 100 mA
 Maximum low-level sink current = 100 mA
 Typical high-level leakage current = 0.12 mA @ 16.5 VDC

Pins 1 - 7 as digital/trigger inputs and pin 3 as INH input (pin 8 = common)
 Maximum low-level input voltage = 0.8 V
 Minimum high-level input voltage = 2 V
 Typical low-level current = 2 mA @ 0 V (internal 2.2k pull-up)
 Typical high-level leakage current = 0.12 mA @ 16.5 VDC

Interface Capabilities:

GPIB: SCPI - 1993, IEEE 488.2 compliant interface
 USB 2.0: Requires Agilent IO Library version M.01.01 and up, or 14.0 and up
 10/100 LAN: Requires Agilent IO Library version L.01.01 and up, or 14.0 and up
 Built-in Web server: Requires Internet Explorer 5+ or Netscape 6.2+

Environmental Conditions

Operating environment Indoor use, installation category II (for AC input), pollution degree 2
 Temperature range 0°C to 55°C (current is derated 1% per °C above 40°C ambient temperature)
 Relative humidity Up to 95%
 Altitude Up to 2000 meters
 Storage temperature -30°C to 70°C
 LED statement Any LEDs used in this product are Class 1 LEDs as per IEC 825-1

¹ Agilent N6700A mainframes have only 4 digital control pins. Refer to Appendix D for pin assignments.

Agilent N6700A/B MPS Mainframe

N6700A/B

Regulatory Compliance:

EMC	Complies with the European EMC directive 89/336/EEC for Class A test and measurement products. Complies with the Australian standard and carries the C-Tick mark. This ISM device complies with Canadian ICES-001. Cet appareil ISM est conforme à la norme NMB-001 du Canada. Electrostatic discharges greater than 1 kV near the I/O connectors may cause the unit to reset and require operator intervention.
Safety	Complies with the European Low Voltage Directive 73/23/EEC and carries the CE-marking. This product also complies with the US and Canadian safety standards for test and measurement products.

Acoustic Noise Declaration:

This statement is provided to comply with the requirements of the German Sound Emission Directive, from 18 January 1991.	Sound Pressure Lp <70 dB(A), * At Operator Position, * Normal Operation, * According to EN 27779 (Type Test). Schalldruckpegel Lp <70 dB(A) * Am Arbeitsplatz, * Normaler Betrieb, * Nach EN 27779 (Typprüfung).
--------------------------------------------------------------------------------------------------------------------------	---------------------------------------------------------------------------------------------------------------------------------------------------------------------------------------------------------------------------

Output Terminal Isolation:

Maximum rating	No output terminal may be more than 240 VDC from any other terminal or chassis ground.
----------------	----------------------------------------------------------------------------------------

AC Input:

Nominal Input Ratings	100 VAC – 240 VAC; 50/60Hz/400Hz
Input Range	86 VAC – 264 VAC
Power Consumption	1000 VA typical (1100 VA maximum with power factor correction)
Fuse	Internal fuse (not customer accessible)

Dimensions:

Height	44.45 mm / 1.75 in.
Width	432.5 mm / 17.03 in.
Depth	596.9 mm / 23.5 in.

Weight:

With 4 installed modules	Net: 12.78 kg; 28 lbs.
Single power module	Net: 1.23 kg; 2.71 lbs

Power Module Option Characteristics

Output Relays (Option 761):	Output Lists (Option 054):	Digitized Measurements (Option 054):
Type = Double-pole, double-throw	Maximum number of steps = 512	Maximum measurement points = 4096
Location = output & sense terminals	Maximum dwell time in seconds = 262	Maximum sample rate = 50 kHz
	Maximum list repetitions = 256, or infinite	

Autoranging Characteristic

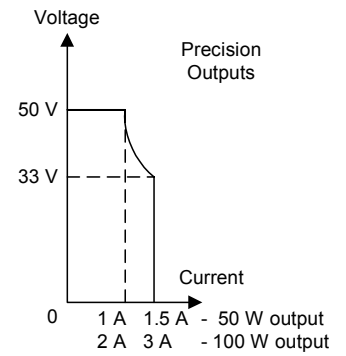
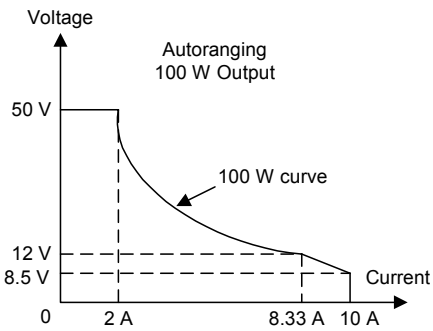
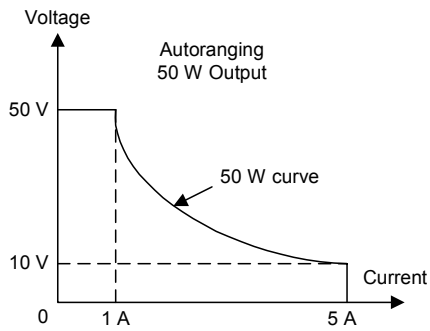

Outline Diagram

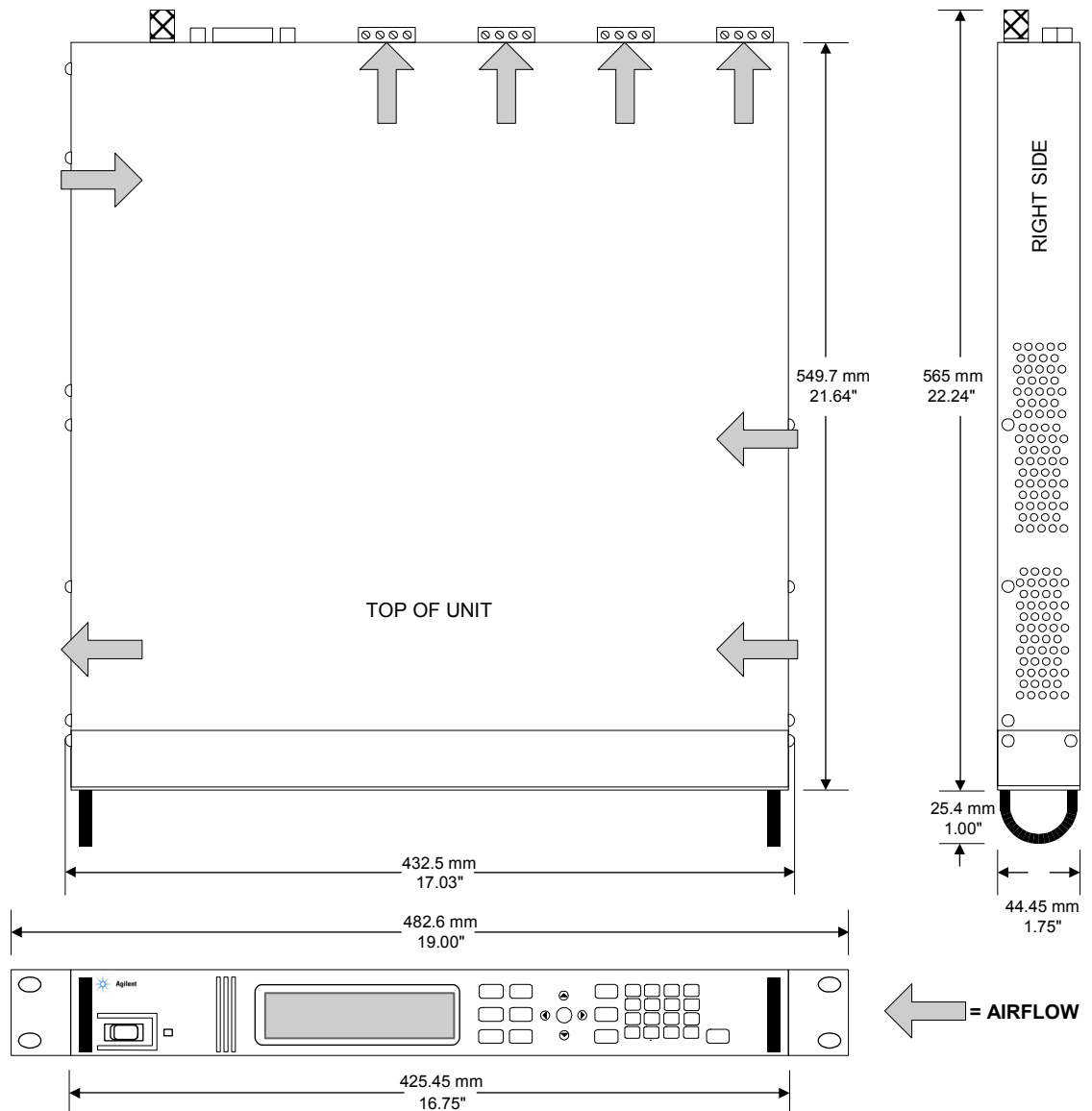

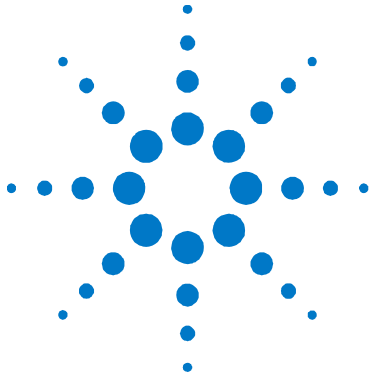

Appendix B

Verification and Calibration

Verification	130
Calibration	151

The verification procedures described in this appendix verify that the Agilent N6700 Modular Power System is operating normally and is within published specifications.

This appendix also includes calibration procedures for the power system. Instructions are given for performing the procedures from either the front panel or a controller over the GPIB.

NOTE

Perform the verification tests before calibrating your power system. If the power system passes the verification tests, the unit is operating within its calibration limits and does not need to be re-calibrated.

The recommended calibration interval for Agilent N67xxA/B power modules is one year. Agilent N6700 MPS mainframes do not require calibration.

Verification

Verification procedures perform two primary functions:

- Performance Tests** These tests verify that the power system is operating normally and meets the specifications published in Appendix A.
- Calibration Tests** These tests verify that the power system is operating within its calibration limits.

If the power system fails any of the tests or if abnormal test results are obtained, try calibrating the unit. If calibration is unsuccessful, return the unit to an Agilent Technologies repair facility (see Appendix D).

Equipment Required

The equipment listed in the following table, or the equivalent to this equipment, is required for the calibration and performance tests. A test record sheet may be found at the back of this section.

Type	Specifications	Recommended Model
Digital Voltmeter	Resolution: 10 nV @ 1V; Readout: 8 1/2 digits Accuracy: 20 ppm	Agilent 3458A or equivalent
Current Monitor	15 A (0.1 ohm), TC=4ppm/°C (all models except N6741B) 30 A (0.1 ohm), TC=4ppm/°C (model N6741B only)	Guidline 9230A/15R Guidline 9230A/30
Load Resistors	50 Ω, 250 W, 1%, TC<100 ppm/°C (CV noise) 25 Ω, 250 W, 1%, TC<100 ppm/°C (CV noise & calibration) 4 Ω, 250 W, 1%, TC<100 ppm/°C (calibration)	Vishay NH-250-50Ω-1% Vishay NH-250-25Ω-1% Vishay NH-250-4Ω-1%
Electronic Load	20 V, 5 A minimum, with transient capability and a slew rate of 833 kA/s or better.	Agilent N3300A mainframe, with N330xA module
GPIB Controller	Full GPIB capabilities (only required if you are calibrating the unit over the GPIB)	Agilent 82350B or equivalent
Oscilloscope	Sensitivity: 1 mV Bandwidth Limit: 20 MHz Probe: 1:1 with RF tip	Agilent Infiniium or equivalent
RMS Voltmeter	True RMS Bandwidth: 20 MHz Sensitivity: 100 μV	Rhode and Schwartz Model URE3 or equivalent
Differential Amplifier	Bandwidth: 20 MHz	LaCroy 1855A, DA1850A, or equivalent
Terminations	1 – 50 Ω BNC termination 2 – 50 Ω, 1/8 W termination resistors	
Variable-voltage Transformer or AC source	Adjustable to highest rated input voltage range. Power: 500 VA	Agilent 6813B or equivalent

Measurement Techniques

Electronic Load

Many of the test procedures require the use of a variable load capable of dissipating the required power. If a variable resistor is used, switches should be used to connect, disconnect, or short the load resistor. For most tests, an electronic load can be used. The electronic load is considerably easier to use than load resistors, but it may not be fast enough to test transient recovery time and may be too noisy for the noise (PARD) tests.

Fixed load resistors may be used in place of a variable load, with minor changes to the test procedures. Also, if computer controlled test setups are used, the relatively slow (compared to computers and system voltmeters) settling times and slew rates of the power system may have to be taken into account. "Wait" statements can be used in the test program if the test system is faster than the power system.

Current-Monitoring Resistor

The 4-terminal current shunt is used to eliminate output current measurement error caused by voltage drops in the load leads and connections. It has special current-monitoring terminals inside the load connection terminals. Connect the voltmeter directly to these current-monitoring terminals.

Test Set-up

The following figure illustrates the test set-ups used for the verification procedures.

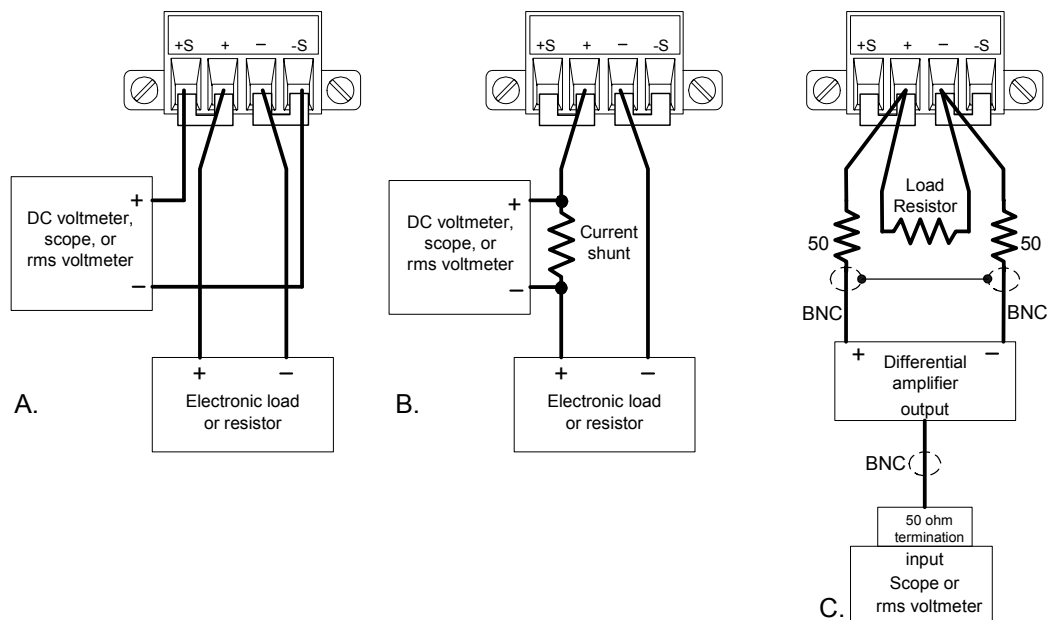

Constant Voltage Tests

NOTE

Test each output channel individually. Refer to the appropriate test record form for the instrument settings of the model you are checking.

Voltage Programming and Readback Accuracy

Test category = performance, calibration

This test verifies that the voltage programming and measurement functions are within specifications.

- 1 Turn off the power system and connect a DVM directly across the sense terminals as shown in Test Setup figure (A). Do not connect a load.
- 2 Turn on the power system and program the instrument settings as described in the test record form under “Voltage Programming & Readback, Min Voltage” with the load off. The CV annunciator should be on and the output current should be close to zero.
- 3 Record the output voltage readings on the digital voltmeter (DVM) and the front panel display. The readings should be within the limits specified in the test record form for the appropriate model under “Voltage Programming & Readback, Min Voltage”.
- 4 Program the instrument settings as described in the test record form under “Voltage Programming & Readback, High Voltage”.
- 5 Record the output voltage readings on the DVM and the front panel display. The readings should be within the limits specified in the test record form for the appropriate model under “Voltage Programming and Readback, High Voltage”.
- 6 *For Agilent Models N6761A and N6762A only.* Repeat steps 4 - 5 for the low voltage range. Program the instrument settings as described in the test record form under “Voltage Programming & Readback, Low Voltage”. The readings should be within the limits specified in the test record form for the appropriate model under “Voltage Programming and Readback, Low Voltage”.

CV Load Effect

Test category = performance

This test measures the change in output voltage resulting from a change in output current from full load to no load.

- 1 Turn off the power system and connect a DVM and an electronic load as shown in Test Setup figure (A).
- 2 Turn on the power system and program the instrument settings as described in the test record form under “CV Load Effect”.
- 3 Set the electronic load for the output channel’s current as described in the test record form under “CV Load Effect”. The CV annunciator on the front panel must be on. If it isn’t, adjust the load so that the output current drops slightly.
- 4 Record the output voltage reading from the DVM.

- 5 Open the load. Record the voltage reading from the DVM again. The difference between the DVM readings in steps 4 and 5 is the load effect, which should not exceed the value listed in the test record form for the appropriate model under “CV Load Effect”.

CV Source Effect

Test category = performance

This test measures the change in output voltage that results from a change in AC line voltage from the minimum to maximum value within the line voltage specifications.

- 1 Turn off the power system and connect the ac power line through a variable voltage transformer or an AC source.
- 2 Connect a DVM and an electronic load as shown in Test Setup figure (A). Set the variable voltage transformer or AC source to nominal line voltage.
- 3 Turn on the power system and program the instrument settings as described in the test record form under “CV Source Effect”.
- 4 Set the electronic load for the output channel’s current as described in the test record form under “CV Source Effect”. The CV annunciator on the front panel must be on. If it isn’t, adjust the load so that the output current drops slightly.
- 5 Adjust the transformer or AC source to the lowest rated line voltage (86 VAC).
- 6 Record the output voltage reading from the DVM.
- 7 Adjust the transformer or AC source to the highest rated line voltage (264 VAC).
- 8 Record the output voltage reading on the DVM. The difference between the DVM reading in steps 6 and 8 is the source effect, which should not exceed the value listed in the test record form for the appropriate model under “CV Source Effect”.

CV Ripple and Noise

Test category = performance

Periodic and random deviations in the output combine to produce a residual AC voltage superimposed on the DC output voltage. This residual voltage is specified as the rms or peak-to-peak output voltage in the frequency range specified in Appendix A.

- 1 Turn off the power system and connect the load resistor, differential amplifier, and an oscilloscope (ac coupled) to the output as shown in Test Setup figure (C). Use the 50 Ω load for 50 W outputs; use the 25 Ω load for 100 W outputs.
- 2 As shown in the diagram, use two BNC cables to connect the differential amplifier to the + and – output terminals. Each cable should be terminated by a 50 Ω resistor. The shields of the two BNC cables should be connected together. Connect the output of the differential amplifier to the oscilloscope with a 50 Ω termination at the input of the oscilloscope.

- 3 Set the differential amplifier to multiply by ten, divide by one, and 1 Megohm input resistance. The positive and negative inputs of the differential amplifier should be set to AC coupling. Set the oscilloscope's time base to 5 ms/div, and the vertical scale to 10 mV/div. Turn the bandwidth limit on (usually 20 or 30 MHz), and set the sampling mode to peak detect.
- 4 Program the power supply to the settings indicated in the in the test record form for the appropriate model under "CV Ripple and Noise" and enable the output. Let the oscilloscope run for a few seconds to generate enough measurement points. On the Agilent Infiniium scope, the maximum peak-to-peak voltage measurement is indicated at the bottom of the screen on the right side. Divide this value by 10 to get the CV peak-to-peak noise measurement. The result should not exceed the peak-to-peak limits in the test record form for the appropriate model under "CV Ripple and Noise, peak-to-peak".
(If the measurement contains any question marks, clear the measurement and try again. This means that some of the data received by the scope was questionable.)
- 5 Disconnect the oscilloscope and connect an rms voltmeter in its place. Do not disconnect the 50 ohm termination. Divide the reading of the rms voltmeter by 10. The result should not exceed the rms limits in the test record form for the appropriate model under "CV Ripple and Noise, rms".

Transient Recovery Time

Test category = performance

This test measures the time for the output voltage to recover to within the specified value following a 50% change in the load current.

- 1 Turn off the power system and connect the output as in Test Setup figure (A) with the oscilloscope across the sense terminals.
- 2 Turn on the power system and program the program the instrument settings as described in the test record form under "Transient Response".
- 3 Set the electronic load to operate in constant current mode. Program its load current to the lower current value indicated in the test record form under "Transient Response".
- 4 Set the electronic load's transient generator frequency to 100 Hz and its duty cycle to 50%.
- 5 Program the load's transient current level to the higher current value indicated in the test record form under "Transient Response", and turn the transient generator on.
- 6 Adjust the oscilloscope for a waveform similar to that shown in the following figure.
- 7 The output voltage should return to within the specified voltage at the specified time following the 50% load change. Check both loading and unloading transients by triggering on the positive and negative slope. Record the voltage at time "t" in the performance test record form under "Transient Response".

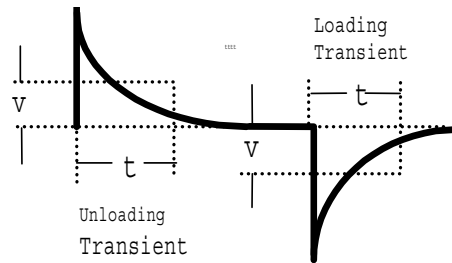

Constant Current Tests

NOTE

Test each output channel individually. Refer to the appropriate test record form for the instrument settings of the model you are checking.

Current Programming and Readback Accuracy

Test category = performance, calibration

This test verifies that the current programming and measurement functions are within specifications.

- 1 Turn off the power system and connect the current shunt directly across the output terminals. Connect the DVM directly across the current shunt as shown in Test Setup figure (B). Note that the electronic load is not used in this portion of the test.
- 2 Turn on the power system and program the instrument settings as described in the test record form under “Current Programming & Readback, Min Current”. The CC annunciator should be on and the output voltage reading should be approximately zero.
- 3 Divide the voltage drop (DVM reading) across the current shunt by the shunt resistance to convert to amps and record this value (I_{out}). Also, record the current reading on the front panel display. The readings should be within the limits specified in the test record form for the appropriate model under “Current Programming and Readback, Min Current”.
- 4 Program the instrument settings as described in the test record form under “Current Programming & Readback, High Current”.
- 5 Divide the voltage drop (DVM reading) across the current shunt by the shunt resistance to convert to amps and record this value (I_{out}). Also, record the current reading on the front panel display. The readings should be within the limits specified in the test record form for the appropriate model under “Current Programming and Readback, High Current”.
- 6 *For Agilent Models N6761A and N6762A only.* Repeat steps 4 - 5 for the low current range. Program the instrument settings as described in the test record form under “Current Programming & Readback, Low Current”. The readings should be within the limits specified in the test record form for the appropriate model under “Current Programming and Readback, Low Current”.

CC Load Effect

Test category = performance

This test measures the change in output current resulting from a change in output voltage from full scale to short circuit.

- 1 Turn off the power system and connect the current shunt, DVM, and electronic load as shown in Test Setup figure (B). Connect the DVM directly across the current shunt.
- 2 To ensure that the values read during this test are not the instantaneous measurement of the AC peaks of the output current ripple, several DC measurements should be made and averaged. If you are using an Agilent 3458A DVM, you can set up the voltmeter to do this automatically. From the instrument's front panel, program 100 power line cycles per measurement. Press NPLC 100 ENTER.
- 3 Turn on the power system and program the instrument settings as described in the test record form under "CC Load Effect".
- 4 Set the electronic load for CV mode and program it to the output channel's voltage as described in the test record form under "CC Load Effect". The CC annunciator on the front panel must be on. If it isn't, adjust the load so that the output voltage drops slightly.
- 5 Divide the voltage drop (DVM reading) across the current monitoring resistor by its resistance to convert to amps and record this value (I_{out}).
- 6 Short the electronic load. Divide the voltage drop (DVM reading) across the current monitoring resistor by its resistance to convert to amps and record this value (I_{out}). The difference in the current readings in steps 4 and 5 is the load effect, which should not exceed the value listed in the test record form for the appropriate model under "CC Load Effect".

CC Source Effect

Test category = performance

This test measures the change in output current that results from a change in AC line voltage from the minimum to maximum value within the line voltage specifications.

- 1 Turn off the power system and connect the ac power line through a variable voltage transformer or AC source.
- 2 Connect the current shunt, DVM, and electronic load as shown in Test Setup figure (B). Connect the DVM directly across the current shunt. Set the variable voltage transformer or AC source to nominal line voltage.
- 3 To ensure that the values read during this test are not the instantaneous measurement of the AC peaks of the output current ripple, several DC measurements should be made and averaged. If you are using an Agilent 3458A DVM, you can set up the voltmeter to do this automatically. From the instrument's front panel, program 100 power line cycles per measurement. Press NPLC 100 ENTER.

- 4** Turn on the power system and program the instrument settings as described in the test record form under “CC Source Effect”.
- 5** Set the electronic load for the output channel’s voltage under “CC Source Effect”. The CC annunciator on the front panel must be on. If it isn’t, adjust the load so that the output voltage drops slightly.
- 6** Adjust the transformer or AC source to the lowest rated line voltage (86 VAC).
- 7** Divide the voltage drop (DVM reading) across the current monitoring resistor by its resistance to convert to amps and record this value (I_{out}).
- 8** Adjust the transformer or AC source to the highest rated line voltage (264 VAC).
- 9** Divide the voltage drop (DVM reading) across the current monitoring resistor by its resistance to convert to amps and record this value (I_{out}). The difference between the DVM reading in steps 6 and 8 is the source effect, which should not exceed the value listed in the test record form for the appropriate model under “CC Source Effect”.

Test Record Form – Agilent N6751A and N6752A

Agilent N6751A and N6752A	Report No	Date		
Description	Model	Minimum Specs.	Results	Maximum Specs.
Constant Voltage Tests				
Voltage Programming & Readback				
Minimum Voltage Vout	Both	+ 1 mV	_____	+ 39 mV
Front Panel Display Readback	Both	Vout – 20 mV	_____	Vout + 20 mV
High Voltage Vout	Both	49.951 V	_____	50.049 V
Front Panel Display Readback	Both	Vout – 45 mV	_____	Vout + 45 mV
CV Load Effect				
	Both	– 2 mV	_____	+ 2 mV
CV Source Effect				
	Both	– 1 mV	_____	+ 1 mV
CV Ripple and Noise				
peak-to-peak	Both	N/A	_____	+ 6 mV
rms	Both	N/A	_____	+ 1 mV
Transient Response				
Voltage at 100 μ s	Both	– 75 mV	_____	+ 75 mV
Constant Current Tests				
Current Programming & Readback				
Minimum Current Iout	Both	– 10 mA	_____	+ 30 mA
Front Panel Display Readback	Both	Iout – 4 mA	_____	Iout + 4 mA
High Current Iout	N6751A	4.975 A	_____	5.025 A
	N6752A	9.970 A	_____	10.030 A
Front Panel Display Readback	N6751A	Iout – 9 mA	_____	Iout + 9 mA
	N6752A	Iout – 14 mA	_____	Iout + 14 mA
CC Load Effect				
	Both	– 2 mA	_____	+ 2 mA
CC Source Effect				
	Both	– 1 mA	_____	+ 1 mA
Instrument Settings				
Test Description	N6751A		N6752A	
Voltage Programming & Readback, Min Voltage	20 mV, 5 A		20 mV, 10 A	
Voltage Programming & Readback, High Voltage	50 V, 1 A		50 V, 2 A	
CV Load Effect, Source Effect, Ripple and Noise	50 V, 1 A		50 V, 2 A	
Transient Response	50 V, from 0.5 A to 1 A		50 V, from 1 A to 2 A	
Current Programming & Readback, Min Current	10 mA, 50 V		10 mA, 50 V	
Current Programming & Readback, High Current	5 A, 10 V		10 A, 8.5 V	
CC Load Effect, Source Effect, Ripple and Noise	5 A, 10 V		10 A, 8.5 V	

Test Record Form – Agilent N6761A and N6762A

Agilent N6761A and N6762A Description	Report No _____ Model	Date _____ Minimum Specs.	Results	Maximum Specs.
Constant Voltage Tests				
High Range Voltage Prog. & Readback				
Minimum Voltage Vout	Both	+ 9 mV	_____	+ 21 mV
Front Panel Display Readback	Both	Vout – 6 mV	_____	Vout + 6 mV
High Voltage Vout	Both	49.986 V	_____	50.014 V
Front Panel Display Readback	Both	Vout – 14 mV	_____	Vout + 14 mV
Low Range Voltage Prog. & Readback				
Low Voltage Vout	Both	5.4976 V	_____	5.5024 V
Front Panel Display Readback	Both	Vout – 2.4 mV	_____	Vout + 2.4 mV
CV Load Effect				
	Both	– 0.5 mV	_____	+ 0.5 mV
CV Source Effect				
	Both	– 0.5 mV	_____	+ 0.5 mV
CV Ripple and Noise				
peak-to-peak	Both	N/A	_____	+ 6 mV
rms	Both	N/A	_____	+ 1 mV
Transient Response				
Voltage at 150 μs	Both	– 75 mV	_____	+ 75 mV
Constant Current Tests				
High Range Current Prog. & Readback				
Minimum Current Iout	Both	+ 0.8 mA	_____	+ 1.2 mA
Front Panel Display Readback	Both	Iout – 160 μA	_____	Iout + 160 μA
High Current Iout	N6761A	1.4992 A	_____	1.5008 A
	N6762A	2.9986 A	_____	3.0014 A
Front Panel Display Readback	N6761A	Iout – 0.76 mA	_____	Iout + 0.76 mA
	N6762A	Iout – 1.36 mA	_____	Iout + 1.36 mA
Low Range Current Prog. & Readback				
Low Current (Full Scale) Iout	Both	0.099945 A	_____	0.100055 A
Front Panel Display Readback	Both	Iout – 45 μA	_____	Iout + 45 μA
CC Load Effect				
	Both	– 65 μA	_____	+ 65 μA
CC Source Effect				
	Both	– 30 μA	_____	+ 30 μA

Test Description	Instrument Settings	
	N6761A	N6762A.
Voltage Programming & Readback, Min Voltage	15 mV, 1.5 A	15 mV, 3 A
Voltage Programming & Readback, High Voltage	50 V, 1 A	50 V, 2 A
Voltage Programming & Readback, Low Voltage	5.5 V, 1.5 A	5.5 V, 3 A
CV Load Effect, Source Effect, Ripple and Noise	50 V, 1 A	50 V, 2 A
Transient Response	50 V, from 0.5 A to 1 A	50 V, from 1 A to 2 A
Current Programming & Readback, Min Current	1 mA, 50 V	1 mA, 50 V
Current Programming & Readback, High Current	1.5 A, 33 V	3 A, 33 V
Current Programming & Readback, Low Current	0.1 A, 50 V	0.1 A, 50 V
CC Load Effect, Source Effect, Ripple and Noise	1.5 A, 33 V	3 A, 33 V

Test Record Form – Agilent N6731A

Agilent N6731A	Report No	Date		
Description	Model	Minimum Specs.	Results	Maximum Specs.
Constant Voltage Tests				
Voltage Programming & Readback				
Minimum Voltage Vout		+ 1 mV	_____	+ 39 mV
Front Panel Display Readback		Vout – 20 mV	_____	Vout + 20 mV
High Voltage Vout		4.976 V	_____	5.024 V
Front Panel Display Readback		Vout – 25 mV	_____	Vout + 25 mV
CV Load Effect				
		– 2 mV	_____	+ 2 mV
CV Source Effect				
		– 1 mV	_____	+ 1 mV
CV Ripple and Noise				
peak-to-peak		N/A	_____	+ 10 mV
rms		N/A	_____	+ 2 mV
Transient Response				
Voltage at 200 μ s		– 80 mV	_____	+ 80 mV
Constant Current Tests				
Current Programming & Readback				
Minimum Current Iout		– 10 mA	_____	+ 30 mA
Front Panel Display Readback		Iout – 20 mA	_____	Iout + 20 mA
High Current Iout		9.965 A	_____	10.035 A
Front Panel Display Readback		Iout – 35 mA	_____	Iout + 35 mA
CC Load Effect				
		– 2 mA	_____	+ 2 mA
CC Source Effect				
		– 1 mA	_____	+ 1 mA
Instrument Settings				
Test Description	N6731A			
Voltage Programming & Readback, Zero Voltage	20 mV, 10 A			
Voltage Programming & Readback, High Voltage	5 V, 10 A			
CV Load Effect, Source Effect, Ripple and Noise	5 V, 10 A			
Transient Response	5 V, from 5 A to 10 A			
Current Programming & Readback, Zero Current	10 mA, 5 V			
Current Programming & Readback, High Current	10 A, 5 V			
CC Load Effect, Source Effect	10 A, 5 V			

Test Record Form – Agilent N6732A and N6742A

Agilent N6732A and N6742A	Report No	Date		
Description	Model	Minimum Specs.	Results	Maximum Specs.
Constant Voltage Tests				
Voltage Programming & Readback				
Minimum Voltage Vout	Both	+ 1 mV	_____	+ 39 mV
Front Panel Display Readback	Both	Vout – 20 mV	_____	Vout + 20 mV
High Voltage Vout	Both	7.973 V	_____	8.027 V
Front Panel Display Readback	Both	Vout – 28 mV	_____	Vout + 28 mV
CV Load Effect				
	Both	– 2 mV	_____	+ 2 mV
CV Source Effect				
	Both	– 2 mV	_____	+ 2 mV
CV Ripple and Noise				
peak-to-peak	Both	N/A	_____	+ 12 mV
rms	Both	N/A	_____	+ 2 mV
Transient Response				
Voltage at 200 μ s	Both	– 80 mV	_____	+ 80 mV
Constant Current Tests				
Current Programming & Readback				
Minimum Current Iout	Both	– 10 mA	_____	+ 30 mA
Front Panel Display Readback	Both	Iout – 10 mA	_____	Iout + 10 mA
High Current Iout	N6732A	6.2206 A	_____	6.2794 A
	N6742A	9.965 A	_____	10.035 A
Front Panel Display Readback	N6732A	Iout – 19.37 mA	_____	Iout + 19.37 mA
	N6742A	Iout – 25 mA	_____	Iout + 25 mA
CC Load Effect				
	Both	– 2 mA	_____	+ 2 mA
CC Source Effect				
	Both	– 1 mA	_____	+ 1 mA
Instrument Settings				
Test Description	N6732A		N6742A	
Voltage Programming & Readback, Zero Voltage	20 mV, 6.25 A		20 mV, 10 A	
Voltage Programming & Readback, High Voltage	8 V, 6.25 A		8 V, 10 A	
CV Load Effect, Source Effect, Ripple and Noise	8 V, 6.25 A		8 V, 10 A	
Transient Response	8 V, from 3 A to 6 A		8 V, from 5 A to 10 A	
Current Programming & Readback, Zero Current	10 mA, 8 V		10 mA, 8 V	
Current Programming & Readback, High Current	6.25 A, 8 V		10 A, 8 V	
CC Load Effect, Source Effect	6.25 A, 8 V		10 A, 8 V	

Test Record Form – Agilent N6733A and N6743A

Agilent N6733A and N6743A	Report No	Date		
Description	Model	Minimum Specs.	Results	Maximum Specs.
Constant Voltage Tests				
Voltage Programming & Readback				
Minimum Voltage Vout	Both	0 mV	_____	+ 40 mV
Front Panel Display Readback	Both	Vout – 20 mV	_____	Vout + 20 mV
High Voltage Vout	Both	19.96 V	_____	20.04 V
Front Panel Display Readback	Both	Vout – 40 mV	_____	Vout + 40 mV
CV Load Effect				
	Both	– 2 mV	_____	+ 2 mV
CV Source Effect				
	Both	– 2 mV	_____	+ 2 mV
CV Ripple and Noise				
peak-to-peak	Both	N/A	_____	+ 14 mV
rms	Both	N/A	_____	+ 3 mV
Transient Response				
Voltage at 200 μ s	Both	– 200 mV	_____	+ 200 mV
Constant Current Tests				
Current Programming & Readback				
Minimum Current Iout	Both	– 10 mA	_____	+ 30 mA
Front Panel Display Readback	Both	Iout – 5 mA	_____	Iout + 5 mA
High Current Iout	N6733A	2.4762 A	_____	2.5237 A
	N6743A	4.9725 A	_____	5.0275 A
Front Panel Display Readback	N6733A	Iout – 8.75 mA	_____	Iout + 8.75 mA
	N6743A	Iout – 12.5 mA	_____	Iout + 12.5 mA
CC Load Effect				
	Both	– 2 mA	_____	+ 2 mA
CC Source Effect				
	Both	– 1 mA	_____	+ 1 mA
Instrument Settings				
Test Description	N6733A		N6743A	
Voltage Programming & Readback, Zero Voltage	20 mV, 2.5 A		20 mV, 5 A	
Voltage Programming & Readback, High Voltage	20 V, 2.5 A		20 V, 5 A	
CV Load Effect, Source Effect, Ripple and Noise	20 V, 2.5 A		20 V, 5 A	
Transient Response	20 V, from 1.25 A to 2.5 A		20 V, from 2.5 A to 5 A	
Current Programming & Readback, Zero Current	10 mA, 20 V		10 mA, 20 V	
Current Programming & Readback, High Current	2.5 A, 20 V		5 A, 20 V	
CC Load Effect, Source Effect	2.5 A, 20 V		5 A, 20 V	

Test Record Form – Agilent N6734A and N6744A

Agilent N6734A and N6744A	Report No	Date		
Description	Model	Minimum Specs.	Results	Maximum Specs.
Constant Voltage Tests				
Voltage Programming & Readback				
Minimum Voltage Vout	Both	– 15 mV	_____	+ 55 mV
Front Panel Display Readback	Both	Vout – 35 mV	_____	Vout + 35 mV
High Voltage Vout	Both	34.93 V	_____	35.07 V
Front Panel Display Readback	Both	Vout – 70 mV	_____	Vout + 70 mV
CV Load Effect				
	Both	– 4 mV	_____	+ 4 mV
CV Source Effect				
	Both	– 4 mV	_____	+ 4 mV
CV Ripple and Noise				
peak-to-peak	Both	N/A	_____	+ 15 mV
rms	Both	N/A	_____	+ 5 mV
Transient Response				
Voltage at 200 μ s	Both	– 200 mV	_____	+ 200 mV
Constant Current Tests				
Current Programming & Readback				
Minimum Current Iout	Both	– 10 mA	_____	+ 30 mA
Front Panel Display Readback	Both	Iout – 4 mA	_____	Iout + 4 mA
High Current Iout	N6734A	1.47775 A	_____	1.52225 A
	N6744A	2.9755 A	_____	3.0245 A
Front Panel Display Readback	N6734A	Iout – 6.25 mA	_____	Iout + 6.25 mA
	N6744A	Iout – 8.5 mA	_____	Iout + 8.5 mA
CC Load Effect				
	Both	– 2 mA	_____	+ 2 mA
CC Source Effect				
	Both	– 1 mA	_____	+ 1 mA
Instrument Settings				
Test Description	N6734A		N6744A	
Voltage Programming & Readback, Zero Voltage	20 mV, 1.5 A		20 mV, 3 A	
Voltage Programming & Readback, High Voltage	35 V, 1.5 A		35 V, 3 A	
CV Load Effect, Source Effect, Ripple and Noise	35 V, 1.5 A		35 V, 3 A	
Transient Response	35 V, from 0.75 A to 1.5 A		35 V, from 1.5 A to 3 A	
Current Programming & Readback, Zero Current	10 mA, 35 V		10 mA, 35 V	
Current Programming & Readback, High Current	1.5 A, 35 V		3 A, 35 V	
CC Load Effect, Source Effect	1.5 A, 35 V		3 A, 35 V	

Test Record Form – Agilent N6735A and N6745A

Agilent N6735A and N6745A	Report No	Date		
Description	Model	Minimum Specs.	Results	Maximum Specs.
Constant Voltage Tests				
Voltage Programming & Readback				
Minimum Voltage Vout	Both	– 40 mV	_____	+ 80 mV
Front Panel Display Readback	Both	Vout – 60 mV	_____	Vout + 60 mV
High Voltage Vout	Both	49.89 V	_____	50.11 V
Front Panel Display Readback	Both	Vout – 110 mV	_____	Vout + 110 mV
CV Load Effect				
	Both	– 6 mV	_____	+ 6 mV
CV Source Effect				
	Both	– 6 mV	_____	+ 6 mV
CV Ripple and Noise				
peak-to-peak	Both	N/A	_____	+ 20 mV
rms	Both	N/A	_____	+ 9 mV
Transient Response				
Voltage at 200 μ s	Both	– 200 mV	_____	+ 200 mV
Constant Current Tests				
Current Programming & Readback				
Minimum Current Iout	Both	– 10 mA	_____	+ 30 mA
Front Panel Display Readback	Both	Iout – 4 mA	_____	Iout + 4 mA
High Current Iout	N6735A	0.7788 A	_____	0.8212 A
	N6745A	1.5776 A	_____	1.6224 A
Front Panel Display Readback	N6735A	Iout – 5.2 mA	_____	Iout + 5.2 mA
	N6745A	Iout – 6.4 mA	_____	Iout + 6.4 mA
CC Load Effect				
	Both	– 2 mA	_____	+ 2 mA
CC Source Effect				
	Both	– 1 mA	_____	+ 1 mA
Instrument Settings				
Test Description	N6735A		N6745A	
Voltage Programming & Readback, Zero Voltage	20 mV, 0.8 A		20 mV, 1.6 A	
Voltage Programming & Readback, High Voltage	50 V, 0.8 A		50 V, 1.6 A	
CV Load Effect, Source Effect, Ripple and Noise	50 V, 0.8 A		50 V, 1.6 A	
Transient Response	50 V, from 0.4 A to 0.8 A		50 V, from 0.8 A to 1.6 A	
Current Programming & Readback, Zero Current	10 mA, 50 V		10 mA, 50 V	
Current Programming & Readback, High Current	0.8 A, 50 V		1.6 A, 50 V	
CC Load Effect, Source Effect	0.8 A, 50 V		1.6 A, 50 V	

Test Record Form – Agilent N6731B and N6741B

Agilent N6731B and N6741B		Report No	Date	
Description	Model	Minimum Specs.	Results	Maximum Specs.
Constant Voltage Tests				
Voltage Programming & Readback				
Minimum Voltage Vout	Both	– 4 mV	_____	+ 34 mV
Front Panel Display Readback	Both	Vout – 20 mV	_____	Vout + 20 mV
High Voltage Vout	Both	4.976 V	_____	5.024 V
Front Panel Display Readback	Both	Vout – 25 mV	_____	Vout + 25 mV
CV Load Effect				
	Both	– 5 mV	_____	+ 5 mV
CV Source Effect				
	Both	– 1 mV	_____	+ 1 mV
CV Ripple and Noise				
peak-to-peak	N6731B	N/A	_____	+ 10 mV
	N6741B	N/A	_____	+ 11 mV
rms	Both	N/A	_____	+ 2 mV
Transient Response				
Voltage at 200 μ s	N6731B	– 80 mV	_____	+ 80 mV
	N6741B	– 100 mV	_____	+ 100 mV
Constant Current Tests				
Current Programming & Readback				
Minimum Current Iout	Both	+ 40 mA	_____	+ 80 mA
Front Panel Display Readback	Both	Iout – 20 mA	_____	Iout + 20 mA
High Current Iout	N6731B	9.965 A	_____	10.035 A
	N6741B	19.95 A	_____	20.05 A
Front Panel Display Readback	N6731B	Iout – 35 mA	_____	Iout + 35 mA
	N6741B	Iout – 50 mA	_____	Iout + 50 mA
CC Load Effect				
	Both	– 2 mA	_____	+ 2 mA
CC Source Effect				
	Both	– 1 mA	_____	+ 1 mA
Instrument Settings				
Test Description	N6731B		N6741B	
Voltage Programming & Readback, Zero Voltage	15 mV, 10 A		15 mV, 20 A	
Voltage Programming & Readback, High Voltage	5 V, 10 A		5 V, 20 A	
CV Load Effect, Source Effect, Ripple and Noise	5 V, 10 A		5 V, 20 A	
Transient Response	5 V, from 5 A to 10 A		5 V, from 10 A to 20 A	
Current Programming & Readback, Zero Current	60 mA, 5 V		60 mA, 5 V	
Current Programming & Readback, High Current	10 A, 5 V		20 A, 5 V	
CC Load Effect, Source Effect	10 A, 5 V		20 A, 5 V	

Test Record Form – Agilent N6732B and N6742B

Agilent N6732B and N6742B	Report No _____	Date _____		
Description	Model	Minimum Specs.	Results	Maximum Specs.
Constant Voltage Tests				
Voltage Programming & Readback				
Minimum Voltage Vout	Both	- 4 mV	_____	+ 34 mV
Front Panel Display Readback	Both	Vout - 20 mV	_____	Vout + 20 mV
High Voltage Vout	Both	7.973 V	_____	8.027 V
Front Panel Display Readback	Both	Vout - 28 mV	_____	Vout + 28 mV
CV Load Effect				
	Both	- 6 mV	_____	+ 6 mV
CV Source Effect				
	Both	- 2 mV	_____	+ 2 mV
CV Ripple and Noise				
peak-to-peak	Both	N/A	_____	+ 12 mV
rms	Both	N/A	_____	+ 2 mV
Transient Response				
Voltage at 200 μ s	N6732B	- 80 mV	_____	+ 80 mV
	N6742B	- 100 mV	_____	+ 100 mV
Constant Current Tests				
Current Programming & Readback				
Minimum Current Iout	Both	- 20 mA	_____	+ 60 mA
Front Panel Display Readback	Both	Iout - 10 mA	_____	Iout + 10 mA
High Current Iout	N6732B	6.2206 A	_____	6.2794 A
	N6742B	12.46 A	_____	12.54 A
Front Panel Display Readback	N6732B	Iout - 19.37 mA	_____	Iout + 19.37 mA
	N6742B	Iout - 29 mA	_____	Iout + 29 mA
CC Load Effect				
	Both	- 2 mA	_____	+ 2 mA
CC Source Effect				
	Both	- 1 mA	_____	+ 1 mA
Instrument Settings				
Test Description	N6732B		N6742B	
Voltage Programming & Readback, Zero Voltage	15 mV, 6.25 A		15 mV, 12.5 A	
Voltage Programming & Readback, High Voltage	8 V, 6.25 A		8 V, 12.5 A	
CV Load Effect, Source Effect, Ripple and Noise	8 V, 6.25 A		8 V, 12.5 A	
Transient Response	8 V, from 3.125 A to 6.25 A		8V, from 6.25A to 12.5A	
Current Programming & Readback, Zero Current	40 mA, 8 V		40 mA, 8 V	
Current Programming & Readback, High Current	6.25 A, 8 V		12.5 A, 8 V	
CC Load Effect, Source Effect	6.25 A, 8 V		12.5 A, 8 V	

Test Record Form – Agilent N6733B and N6743B

Agilent N6733B and N6743B	Report No	Date		
Description	Model	Minimum Specs.	Results	Maximum Specs.
Constant Voltage Tests				
Voltage Programming & Readback				
Minimum Voltage Vout	Both	+ 10 mV	_____	+ 50 mV
Front Panel Display Readback	Both	Vout – 20 mV	_____	Vout + 20 mV
High Voltage Vout	Both	19.96 V	_____	20.04 V
Front Panel Display Readback	Both	Vout – 40 mV	_____	Vout + 40 mV
CV Load Effect				
	Both	– 9 mV	_____	+ 9 mV
CV Source Effect				
	Both	– 2 mV	_____	+ 2 mV
CV Ripple and Noise				
peak-to-peak	Both	N/A	_____	+ 14 mV
rms	Both	N/A	_____	+ 3 mV
Transient Response				
Voltage at 200 μ s	N6733B	– 200 mV	_____	+ 200 mV
	N6743B	– 300 mV	_____	+ 300 mV
Constant Current Tests				
Current Programming & Readback				
Minimum Current Iout	Both	– 10 mA	_____	+ 30 mA
Front Panel Display Readback	Both	Iout – 5 mA	_____	Iout + 5 mA
High Current Iout	N6733B	2.4762 A	_____	2.5237 A
	N6743B	4.9725 A	_____	5.0275 A
Front Panel Display Readback	N6733B	Iout – 8.75 mA	_____	Iout + 8.75 mA
	N6743B	Iout – 12.5 mA	_____	Iout + 12.5 mA
CC Load Effect				
	Both	– 2 mA	_____	+ 2 mA
CC Source Effect				
	Both	– 1 mA	_____	+ 1 mA
Instrument Settings				
Test Description	N6733B		N6743B	
Voltage Programming & Readback, Zero Voltage	30 mV, 2.5 A		30 mV, 5 A	
Voltage Programming & Readback, High Voltage	20 V, 2.5 A		20 V, 5 A	
CV Load Effect, Source Effect, Ripple and Noise	20 V, 2.5 A		20 V, 5 A	
Transient Response	20 V, from 1.25 A to 2.5 A		20 V, from 2.5 A to 5 A	
Current Programming & Readback, Zero Current	10 mA, 20 V		10 mA, 20 V	
Current Programming & Readback, High Current	2.5 A, 20 V		5 A, 20 V	
CC Load Effect, Source Effect	2.5 A, 20 V		5 A, 20 V	

Test Record Form – Agilent N6734B and N6744B

Agilent N6734B and N6744B	Report No	Date		
Description	Model	Minimum Specs.	Results	Maximum Specs.
Constant Voltage Tests				
Voltage Programming & Readback				
Minimum Voltage Vout	Both	+ 5 mV	_____	+ 75 mV
Front Panel Display Readback	Both	Vout – 35 mV	_____	Vout + 35 mV
High Voltage Vout	Both	34.93 V	_____	35.07 V
Front Panel Display Readback	Both	Vout – 70 mV	_____	Vout + 70 mV
CV Load Effect				
	Both	– 11 mV	_____	+ 11 mV
CV Source Effect				
	Both	– 4 mV	_____	+ 4 mV
CV Ripple and Noise				
peak-to-peak	Both	N/A	_____	+ 15 mV
rms	Both	N/A	_____	+ 5 mV
Transient Response				
Voltage at 200 μ s	N6734B	– 200 mV	_____	+ 200 mV
	N6744B	– 300 mV	_____	+ 300 mV
Constant Current Tests				
Current Programming & Readback				
Minimum Current Iout	Both	– 15 mA	_____	+ 25 mA
Front Panel Display Readback	Both	Iout – 4 mA	_____	Iout + 4 mA
High Current Iout	N6734B	1.47775 A	_____	1.52225 A
	N6744B	2.9755 A	_____	3.0245 A
Front Panel Display Readback	N6734B	Iout – 6.25 mA	_____	Iout + 6.25 mA
	N6744B	Iout – 8.5 mA	_____	Iout + 8.5 mA
CC Load Effect				
	Both	– 2 mA	_____	+ 2 mA
CC Source Effect				
	Both	– 1 mA	_____	+ 1 mA
Instrument Settings				
Test Description	N6734B		N6744B	
Voltage Programming & Readback, Zero Voltage	40 mV, 1.5 A		40 mV, 3 A	
Voltage Programming & Readback, High Voltage	35 V, 1.5 A		35 V, 3 A	
CV Load Effect, Source Effect, Ripple and Noise	35 V, 1.5 A		35 V, 3 A	
Transient Response	35 V, from 0.75 A to 1.5 A		35 V, from 1.5 A to 3 A	
Current Programming & Readback, Zero Current	5 mA, 35 V		5 mA, 35 V	
Current Programming & Readback, High Current	1.5 A, 35 V		3 A, 35 V	
CC Load Effect, Source Effect	1.5 A, 35 V		3 A, 35 V	

Test Record Form – Agilent N6735B and N6745B

Agilent N6735B and N6745B	Report No _____	Date _____		
Description	Model	Minimum Specs.	Results	Maximum Specs.
Constant Voltage Tests				
Voltage Programming & Readback				
Minimum Voltage Vout	Both	+ 10 mV	_____	+ 130 mV
Front Panel Display Readback	Both	Vout – 60 mV	_____	Vout + 60 mV
High Voltage Vout	Both	59.88 V	_____	60.12 V
Front Panel Display Readback	Both	Vout – 120 mV	_____	Vout + 120 mV
CV Load Effect				
	N6735B	– 13 mV	_____	+ 13 mV
	N6745B	– 16 mV	_____	+ 16 mV
CV Source Effect				
	Both	– 6 mV	_____	+ 6 mV
CV Ripple and Noise				
peak-to-peak	Both	N/A	_____	+ 25 mV
rms	Both	N/A	_____	+ 9 mV
Transient Response				
Voltage at 200 μs	N6735B	– 400 mV	_____	+ 400 mV
	N6745B	– 500 mV	_____	+ 500 mV
Constant Current Tests				
Current Programming & Readback				
Minimum Current Iout	Both	– 17.5 mA	_____	+ 22.5 mA
Front Panel Display Readback	Both	Iout – 4 mA	_____	Iout + 4 mA
High Current Iout	N6735B	0.7788 A	_____	0.8212 A
	N6745B	1.5776 A	_____	1.6224 A
Front Panel Display Readback	N6735B	Iout – 5.2 mA	_____	Iout + 5.2 mA
	N6745B	Iout – 6.4 mA	_____	Iout + 6.4 mA
CC Load Effect				
	Both	– 2 mA	_____	+ 2 mA
CC Source Effect				
	Both	– 1 mA	_____	+ 1 mA
Instrument Settings				
Test Description	N6735A		N6745A	
Voltage Programming & Readback, Zero Voltage	70 mV, 0.8 A		70 mV, 1.6 A	
Voltage Programming & Readback, High Voltage	60 V, 0.8 A		60 V, 1.6 A	
CV Load Effect, Source Effect, Ripple and Noise	60 V, 0.8 A		60 V, 1.6 A	
Transient Response	60 V, from 0.4 A to 0.8 A		60 V, from 0.8 A to 1.6 A	
Current Programming & Readback, Zero Current	2.5 mA, 60 V		2.5 mA, 60 V	
Current Programming & Readback, High Current	0.8 A, 60 V		1.6 A, 60 V	
CC Load Effect, Source Effect	0.8 A, 60 V		1.6 A, 60 V	

Test Record Form – Agilent N6736B and N6746B

Agilent N6736B and N6746B	Report No _____	Date _____		
Description	Model	Minimum Specs.	Results	Maximum Specs.
Constant Voltage Tests				
Voltage Programming & Readback				
Minimum Voltage Vout	Both	0 mV	_____	+ 200 mV
Front Panel Display Readback	Both	Vout – 100 mV	_____	Vout + 100 mV
High Voltage Vout	Both	99.8 V	_____	100.2 V
Front Panel Display Readback	Both	Vout – 200 mV	_____	Vout + 200 mV
CV Load Effect				
	N6736B	– 20 mV	_____	+ 20 mV
	N6746B	– 30 mV	_____	+ 30 mV
CV Source Effect				
	Both	– 10 mV	_____	+ 10 mV
CV Ripple and Noise				
peak-to-peak	Both	N/A	_____	+ 30 mV
rms	Both	N/A	_____	+ 18 mV
Transient Response				
Voltage at 200 μ s	N6736B	– 500 mV	_____	+ 500 mV
	N6746B	– 1000 mV	_____	+ 1000 mV
Constant Current Tests				
Current Programming & Readback				
Minimum Current Iout	Both	– 8.5 mA	_____	+ 11.5 mA
Front Panel Display Readback	Both	Iout – 2 mA	_____	Iout + 2 mA
High Current Iout	N6736B	0.4893 A	_____	0.5107 A
	N6746B	0.9885 A	_____	1.0115 A
Front Panel Display Readback	N6736B	Iout – 2.75 mA	_____	Iout + 2.75 mA
	N6746B	Iout – 3.5 mA	_____	Iout + 3.5 mA
CC Load Effect				
	Both	– 2 mA	_____	+ 2 mA
CC Source Effect				
	Both	– 1 mA	_____	+ 1 mA
Instrument Settings				
Test Description	N6736A	N6746A		
Voltage Programming & Readback, Zero Voltage	100 mV, 0.5 A	100 mV, 1 A		
Voltage Programming & Readback, High Voltage	100 V, 0.5 A	100 V, 1 A		
CV Load Effect, Source Effect, Ripple and Noise	100 V, 0.5 A	100 V, 1 A		
Transient Response	100 V, from 0.25 A to 0.5 A	100 V, from 0.5 A to 1 A		
Current Programming & Readback, Zero Current	1.5 mA, 100 V	1.5 mA, 100 V		
Current Programming & Readback, High Current	0.5 A, 100 V	1 A, 100 V		
CC Load Effect, Source Effect	0.5 A, 100 V	1 A, 100 V		

Calibration

Refer to the “Equipment Required” section in this appendix for a list of the equipment required for calibration. A general outline of the procedure is as follows:

- Enter the calibration mode by providing the correct password. The password is factory-set to 0 (zero). You can change the password once calibration mode is entered to prevent unauthorized access to the calibration mode. Refer to “Change the Calibration Password” at the end of this section.
- Calibrate only ONE channel at a time. The calibration commands accept only a single channel number for the channel parameter. Calibration cannot be performed on channels that have been grouped. If any channels have been grouped, they must be ungrouped before they can be calibrated.
- When calibrating the unit using SCPI commands, most steps involve sending a *OPC? query to synchronize with the power system’s command completion before proceeding. The response from the instrument must be read each time *OPC? is given.
- **Once started, you must perform the complete calibration procedure in its entirety.** As each calibration section is completed, the instrument calculates new calibration constants and begins using them. However, these constants are not saved in nonvolatile memory until a SAVE command is explicitly given.
- Exit the calibration mode either by logging out of the front panel menu or by sending CAL:STAT OFF. Note that any channels that were calibrated but not saved will revert to their previous calibration constants.

Calibration Switches

Two switches control the access to calibration commands. The switches are on the carrier board and are accessible by removing the top cover. Refer to the Disassembly Instructions in Appendix D. Switches 1 and 2 set the calibration configuration as follows:

	Sw 1	Sw 2	Description
Normal	ON	ON	This is the default or as-shipped switch setting. The calibration functions are accessible after entering a numeric password. The default password is 0 (zero).
Clear password	OFF	ON	The admin/calibration password is reset to 0 when the instrument is first powered on. Use this setting if you have forgotten the password.
Inhibit calibration	OFF	OFF	All calibration commands are disabled. This is useful where calibration access is guarded by instrument seals.

Calibration Procedure

Unless instructed otherwise, connect the +sense terminal to the +output, and the -sense terminal to the -output.

Warm-up Period for Agilent Models N6761A and N6762A

Agilent Models N6761A and N6762A require a warm-up period of 30 minutes in the reset (*RST) state before starting the calibration procedure.

Enter Calibration mode

Front Panel:	SCPI Command:
Select System\Admin>Login . Enter your password in the Password field and press Select.	CAL:STAT ON, <password>

Voltage Programming and Measurement Calibration

Step 1. Connect the DVM's voltage input to an output channel.

Step 2. Select the full-scale voltage programming and measurement range. The following example selects the 50 volt full-scale range of channel 1. The value entered must be the maximum voltage of the range.

Front Panel:	SCPI Command:
Select System\Admin\Cal\Function\Vprog . Then select the High range.	CAL:VOLT 50, (@1)

Step 3. Select the first voltage calibration point.

Front Panel:	SCPI Command:
Select Next. The information field should indicate: Enter P1 data	CAL:LEV P1 *OPC?

Step 4. Measure the output voltage with the DVM and enter the data.

Front Panel:	SCPI Command:
Select the Measured Data field. Enter the data from the external DVM. Press Select when done.	CAL:DATA <data>

Step 5. Select the second voltage calibration point.

Front Panel:	SCPI Command:
Select Next. The information field should indicate: Enter P2 data	CAL:LEV P2 *OPC?

Step 6. Measure the output voltage with the DVM and enter the data.

Front Panel:	SCPI Command:
Select the Measured Data field. Enter the data from the external DVM. Press Select when done. Press Next to finish calibration.	CAL:DATA <data>

Low Range Voltage Programming Calibration

This only applies to Agilent Models N6761A and N6762A.

Step 7. Select the low-voltage programming range. This example selects the 5 volt programming range of channel 1. The value to program a range must be the maximum voltage of the range.

Front Panel:	SCPI Command:
Select System\Admin\Cal\Function\Vprog. Then select the Low range.	CAL:VOLT 5, (@1)

Step 8. Select the first voltage calibration point.

Front Panel:	SCPI Command:
Select Next. The information field should indicate: Enter P1 data	CAL:LEV P1 *OPC?

Step 9. Measure the output voltage with the DVM and enter the data.

Front Panel:	SCPI Command:
Select the Measured Data field. Enter the data from the external DVM. Press Select when done.	CAL:DATA <data>

Step 10. Select the second voltage calibration point.

Front Panel:	SCPI Command:
Select Next. The information field should indicate: Enter P2 data	CAL:LEV P2 *OPC?

Step 11. Measure the output voltage with the DVM and enter the data.

Front Panel:	SCPI Command:
Select the Measured Data field. Enter the data from the external DVM. Press Select when done. Press Next to finish calibration.	CAL:DATA <data>

Low Range Voltage Measurement Calibration

This only applies to Agilent Models N6761A and N6762A.

Step 12. Select the low-voltage measurement range. This example selects the 5 volt measurement range of channel 1. The value to program a range must be the maximum voltage of the range.

Front Panel:	SCPI Command:
Select	CAL:VOLT:MEAS 5, (@1)
System\Admin\Cal\Function\Vmeas.	

Step 13. Select the first voltage calibration point.

Front Panel:	SCPI Command:
Select Next. The information field should indicate: Enter P1 data	CAL:LEV P1 *OPC?

Step 14. Measure the output voltage with the DVM and enter the data.

Front Panel:	SCPI Command:
Select the Measured Data field. Enter the data from the external DVM. Press Select when done.	CAL:DATA <data>

Step 15. Select the second voltage calibration point.

Front Panel:	SCPI Command:
Select Next. The information field should indicate: Enter P2 data	CAL:LEV P2 *OPC?

Step 16. Measure the output voltage with the DVM and enter the data.

Front Panel:	SCPI Command:
Select the Measured Data field. Enter the data from the external DVM. Press Select when done. Press Next to finish calibration.	CAL:DATA <data>

Voltage Common Mode Rejection Ratio Calibration

This only applies to Agilent Models N6751A, N6752A, N6761A and N6762A.

Step 17. For this step only, refer to the following figure and connect a jumper between the +sense and the - sense terminals. Connect a second jumper from the +output to the - sense terminal. Connect a 25 ohm load resistor across the +output and -output terminals (refer to the equipment list). This procedure is automatic and takes a few seconds.

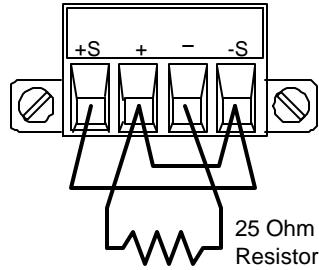

Front Panel:	SCPI Command:
Select	CAL:VOLT:CMRR (@1)
System\Admin\Cal\Function\CMRR.	*OPC?
Then select Next.	

Current Programming and Measurement Calibration

- Step 18.** Connect the +sense terminal to the +output, and the -sense terminal to the -output. Connect a precision shunt resistor to the output. The shunt resistor should be able to measure at least 120% of the output's rated full-scale current. Connect the DVM across the shunt resistor.
- Step 19.** Select the full-scale current programming range. The following example selects the 10 amp full-scale current programming and measurement range of channel 1. The value to program a range must be the maximum current of the range.

Front Panel:	SCPI Command:
Select	CAL:CURR 10, (@1)
System\Admin\Cal\Function\Iprog	
Then select the High range.	

- Step 20.** Select the first current calibration point.

Front Panel:	SCPI Command:
Select Next. The information field should indicate: Enter P1 data	CAL:LEV P1
	*OPC?

- Step 21.** Calculate the shunt current ($I=V/R$) and enter the data.

Front Panel:	SCPI Command:
Select the Measured Data field. Enter the data from the external DVM. Press Select when done.	CAL:DATA <data>

- Step 22.** Select the second current calibration point.

Front Panel:	SCPI Command:
Select Next. The information field should indicate: Enter P2 data	CAL:LEV P2
	*OPC?

Step 23. Calculate the shunt current ($I=V/R$) and enter the data.

Front Panel:	SCPI Command:
Select the Measured Data field. Enter the data from the external DVM. Press Select when done. Press Next to finish calibration.	CAL:DATA <data>

Current Downprogrammer Calibration

Step 24. Remove all loads from the output. This procedure is automatic and takes a few seconds.

Front Panel:	SCPI Command:
Select System\Admin\Cal\Function\DPprog. Then select Next.	CAL:DPRog (@1) *OPC?

Low Range Current Measurement Calibration

This only applies to Agilent Models N6761A and N6762 with Firmware revisions B.00.00 and up. For calibrating units with previous firmware revisions, refer to Appendix E.

Step 25. Connect only the current measurement terminals of the Agilent 3458A to the output terminals.

Step 26. Select the low-current measurement range. The following example selects the 0.1 amp low-current measurement range of channel 1. The value to program a range must be the maximum current of the range.

Front Panel:	SCPI Command:
Select System\Admin\Cal\Function\lmeas.	CAL:CURR:MEAS 0.1, (@1)

Step 27. Select the first current calibration point. Then wait a minimum of 5 minutes for the internal temperature to stabilize.

Front Panel:	SCPI Command:
Select Next. The information field should indicate: Enter P1 data	CAL:LEV P1

Step 28. Measure the current with the Agilent 3458A and enter the value.

Front Panel:	SCPI Command:
Select the Measured Data field. Enter the data from the external DVM. Press Select when done. Press Next to finish calibration.	CAL:DATA <data> *OPC?

Step 29. Disconnect the Agilent 3458A from the output terminals. Then select the second current calibration point. Wait a minimum of 5 minutes for the internal temperature to stabilize.

Front Panel:	SCPI Command:
Select Next. The information field should indicate: Enter P2 data	CAL:LEV P2

Step 30. Then select the third current calibration point.

Front Panel:	SCPI Command:
Select Next. The information field should indicate: Enter P3 data	CAL:LEV P3 *OPC?

Low Range Current Programming Calibration

This only applies to Agilent Models N6761A and N6762A.

Step 31. Connect only the current measurement terminals of the Agilent 3458A to the output terminals.

Step 32. Select the low-current programming range. The following example selects the 0.1 amp low-current programming range of channel 1. The value to program a range must be the maximum current of the range.

Front Panel:	SCPI Command:
Select System\Admin\Cal\Function\Iprog. Then select the Low range.	CAL:CURR 0.1, (@1)

Step 33. Select the first current calibration point. Wait a minimum of 5 minutes for the output current to stabilize.

Front Panel:	SCPI Command:
Select Next. The information field should indicate: Enter P1 data	CAL:LEV P1 *OPC?

Step 34. Measure the current with the Agilent 3458A and enter the value.

Front Panel:	SCPI Command:
Select the Measured Data field. Enter the data from the external DVM. Press Select when done.	CAL:DATA <data>

Step 35. Select the second current calibration point. Then wait 30 seconds for the output current to stabilize.

Front Panel:	SCPI Command:
Select Next. The information field should indicate: Enter P2 data	CAL:LEV P2 *OPC?

Step 36. Measure the current with the Agilent 3458A and enter the value.

Front Panel:	SCPI Command:
Select the Measured Data field. Enter the data from the external DVM. Press Select when done. Press Next to finish calibration.	CAL:DATA <data>

Peak Current Limit Calibration

Steps 37 through 41 only apply to Agilent Models N6751A, N6752A, N6761A and N6762A.

Step 37. Connect the 25 ohm load resistor across the output terminals (see the equipment list).

Step 38. Select peak current limit calibration.

Front Panel:	SCPI Command:
Select System\Admin\Cal\Function\IPeak	CAL:CURR:PEAK (@1)

Step 39. Select the first current calibration point.

Front Panel:	SCPI Command:
Select Next. The calibration is automatic.	CAL:LEV P1 *OPC?

Step 40. Replace the 25 ohm resistor with the 4 ohm load resistor (see equipment list).

Step 41. Select the second current calibration point.

Front Panel:	SCPI Command:
Select Next. The calibration is automatic.	CAL:LEV P2 *OPC?

Steps 42 through 44 apply to Agilent Models N6731A through N6735A, and N6742A through N6745A.

Step 42. Connect the 4 ohm load resistor across the output terminals (see the equipment list).

Step 43. Select peak current limit calibration.

Front Panel:	SCPI Command:
Select System\Admin\Cal\Function\IPeak	CAL:CURR:PEAK (@1)

Step 44. Select the first current calibration point.

Front Panel:	SCPI Command:
Select Next. The calibration is automatic.	CAL:LEV P1 *OPC?

Save and Exit Calibration Mode

CAUTION

Storing calibration constants overwrites the existing ones in non-volatile memory. If you are not sure you want to permanently store the new constants, do not Save the data when you exit the calibration mode. The calibration will then remain unchanged.

Front Panel:	SCPI Command:
Select System\Admin\Cal\Date . Enter the calibration date in the Date field. If desired, you can enter alphanumeric data in this field.	To enter a calibration date: CAL:DATE "<date>", (@1)
Select System\Admin\Cal\Save . Select Save to save all calibration data.	To save calibration data: CAL:SAVE
Select System\Admin\Logout to exit calibration mode.	To exit calibration mode: CAL:STAT OFF

Change the Admin/Calibration Password

The password must be numeric, and can be up to 15 digits in length. After it has been changed, you can only enter the calibration mode by providing the correct password. If the password is lost, access can be restored by setting an internal switch that resets the password to 0. If the message "Locked out by internal switch setting" or "Calibration is inhibited by switch setting" appears, the internal switch is set to prevent the password from being changed (Refer to Appendix D).

Front Panel:	SCPI Command:
Select System\Admin>Login . Enter the original password in the Password field and press Select.	Enter calibration mode using the original password CAL:STAT ON, <password>
Select System\Admin>Password . Enter a new password in the Password field.	To change the password: CAL:PASS <NRf>
Logout of the Admin menu to activate the password.	To exit calibration mode and activate the password: CAL:STAT OFF

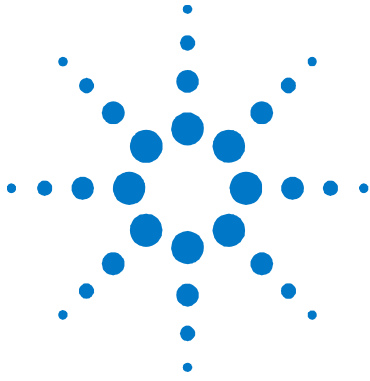

Appendix C

Using the Digital Port

Digital Control Port	162
Configuring the Digital Control Port	166

A Digital Control Port consisting of seven I/O pins is provided to access various control functions. Each pin is user-configurable. The following control functions are available for the I/O pins:

- Bi-directional Digital I/O
- Digital Input only
- External Trigger
- Fault Output
- Inhibit Input

NOTE

Agilent N6700A mainframes use a 4-pin connector instead of the 8-pin connector available on the N6700B mainframes. Pin functionality on the 4-pin connector is the same as the first 3 pins and the common pin on the 8-pin connector. Refer to Appendix E for further information.

Digital Control Port

An 8-pin connector and a quick-disconnect connector plug are provided on each instrument for accessing the five digital control port functions.

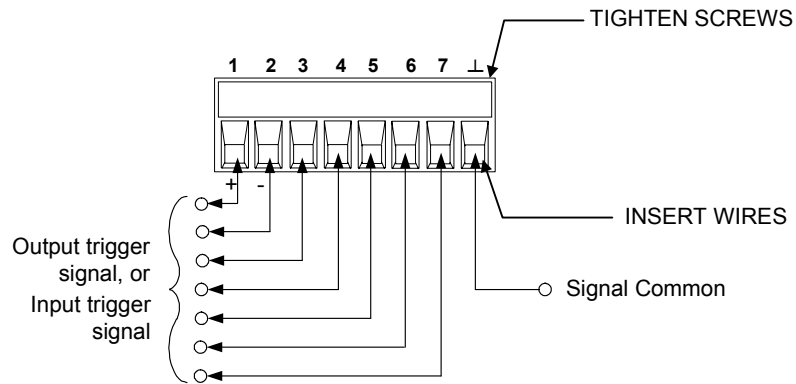

The digital control connector accepts wires sizes from AWG 14 to AWG 30. Note that wire sizes smaller than AWG 24 are not recommended. Disconnect the connector plug to make your wire connections.

NOTE

It is good engineering practice to twist and shield all signal wires to and from the digital connectors. If shielded wire is used, connect only one end of the shield to chassis ground to prevent ground loops.

The following chart describes the possible pin configuration for the available control functions. For a complete description of the electrical characteristics of the digital I/O port, refer to Appendix A.

Pin	External Trigger	Fault/Inhibit	Digital I/O
1	Trigger In/Out	FLT Output	Input/Output
2	Trigger In/Out	FLT Common	Input/Output
3	Trigger In/Out	INH Input	Input/Output
4	Trigger In/Out	N/A	Input/Output
5	Trigger In/Out	N/A	Input/Output
6	Trigger In/Out	N/A	Input/Output
7	Trigger In/Out	N/A	Input/Output
⊥	Trigger Common	INH Common	Signal Common

In addition to the configurable pin functions, the active signal polarity for each pin is also configurable. When Positive polarity is selected, a logical true signal is a voltage high at the pin. When negative polarity is selected, a logical true signal is a voltage low at the pin.

Bi-directional Digital I/O

When the Digital Control pins are configured for bi-directional digital I/O, the pins function as a bi-directional input/outputs, the state of which can be controlled and read at all times. The ground reference for the I/O pin is Signal Common on pin 8. DIGital:OUTPut:DATA sets the state of the pins and DIGital:OUTPut:DATA? reads the state of the pins according to the following bit assignments:

Pin	1	2	3	4	5	6	7
Bit Value	0	1	2	3	4	5	6

The input/output pin can be used to control both relay circuits as well as digital interface circuits. The following figure illustrates typical relay circuits as well as digital interface circuit connections using the digital I/O functions.

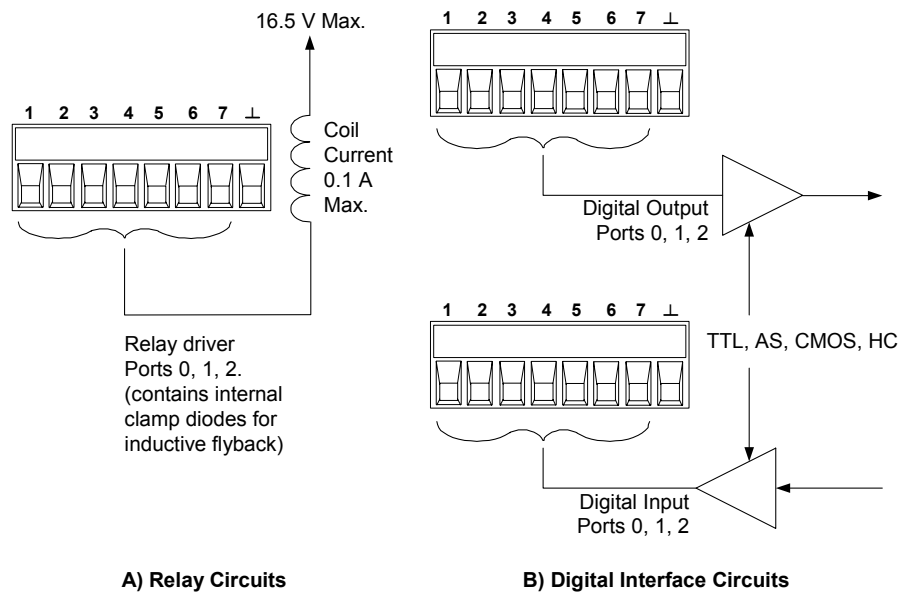

For a complete description of the electrical characteristics of the digital I/O port, see Appendix A.

Digital Input Only

When an I/O pin is configured for Digital Input only, the pin functions as a digital input pin. The ground reference for the I/O pin is Signal Common on pin 8.

The pin status reflects the true condition of the external signal that is applied to the pin. The pin state is not affected by the value of the digital output word.

External Trigger

Any of the Digital Control pins can be programmed to function as either trigger inputs or trigger outputs. All pins are referenced to the Signal Common pin.

To input an external trigger signal, you can apply either a negative-going or a positive-going pulse to the designated trigger input pin. The trigger latency is 5 microseconds. The minimum pulse width is 1 microsecond. The pin's polarity setting determines which edge generates a trigger-in event.

When configured as a trigger output, the designated trigger pin will generate a 2 microsecond-wide trigger pulse in response to a trigger event. Depending on the polarity setting, it can be either positive-going or negative-going when referenced to common.

Fault Output

The Fault Output function enables a fault condition on any channel to generate a fault signal on the Digital Control port. The following conditions will generate a fault event: over-voltage, over-current, over-temperature, inhibit signal, and power-fail (low AC-line).

When this function is selected, both pins 1 and 2 are dedicated to this function. Pin 1 is the Fault output; pin 2 is common for pin 1. This arrangement provides an optically-isolated output. Pin 2's selected function is ignored. Note that the Fault output signal remains latched until the fault condition is cleared. You must also clear the protection circuit.

Inhibit Input

The Inhibit Input function lets an external input signal control the output state of all of the output channels in the mainframe. The signal latency is 5 microseconds. The Inhibit function is only available on pin 3. Pin 8 is common for pin 3. Pin 3 can be programmed for the following Inhibit modes:

LATCHing Causes a logic-true transition on the Inhibit input to disable all outputs.

LIVE Allows the enabled outputs to follow the state of the Inhibit input. When the Inhibit input is true, the outputs are disabled. When the Inhibit input is false, the outputs are re-enabled.

OFF The Inhibit input is ignored.

Output channels can only be controlled by the inhibit signal if they have previously been turned on by the OUTPUT:STATE command or by the front panel On/Off switch. If an output channel is turned on while the Inhibit input is true, the output channel will remain off.

When an Inhibit signal turns off the outputs, the front panel INH status annunciator comes on and the INH bit is set in the Questionable Status Event register. To re-enable the outputs if the inhibit signal was latched, you must clear the protection function.

Fault/Inhibit System Protection

The following figure illustrates some ways that you can connect the Fault/Inhibit pins of the connector.

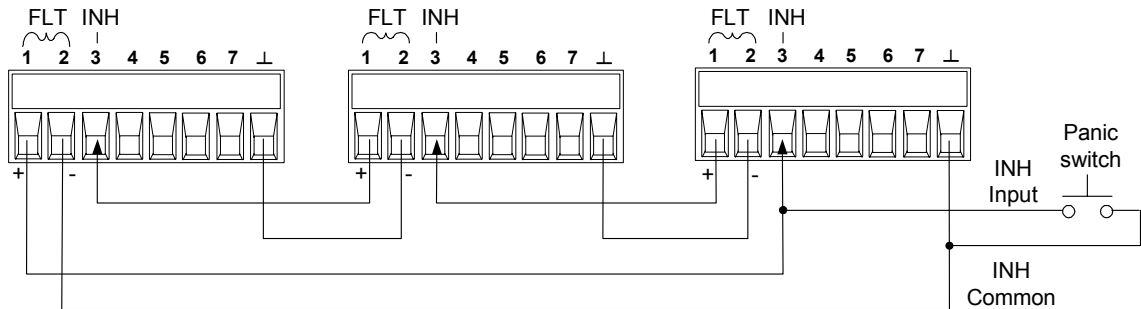

As shown in the figure, when the Fault outputs and Inhibit inputs of several mainframes are daisy-chained, an internal fault condition in one of the mainframes will disable all of them without intervention by either the controller or external circuitry.

You can also connect the Inhibit input to a manual switch that will short the Inhibit pin to common whenever it is necessary to disable all output channels in the mainframe. You can also use the Fault output to drive an external relay circuit or signal other devices whenever a user-definable fault occurs.

Clearing a System Protection Fault

To restore all instruments to a normal operating condition when a fault condition occurs in a daisy-chained system protection configuration, two fault conditions must be removed:

1. The initial protection fault or external Inhibit signal.
2. The subsequent daisy-chained fault signal (which is sourced by the Inhibit signal).

NOTE

Even when the initial fault condition or external signal is removed, the Inhibit fault signal is still active and will continue to shut down the outputs of all the mainframes.

To clear the daisy-chained Inhibit signal, you must turn the Inhibit input off as explained under "Inhibit Input" in the next section.

If the operating mode of the inhibit input is Live, turning off the Inhibit input on any ONE mainframe will break the fault chain for the entire system. To re-enable the fault chain, re-program the same Inhibit input to Live mode.

If the operating mode of the inhibit input is Latched, the Inhibit input must be turned-off on ALL mainframes individually. To re-enable the chain, the Inhibit input on each mainframe must be re-programmed to Latched mode.

Configuring the Digital Control Port

You can configure the Digital Control pins to perform five different functions. These pins can be programmed using either the front panel or SCPI commands.

Bi-directional Digital I/O

Each of the seven pins can be configured as general-purpose digital inputs and outputs. The polarity of the pins can also be configured.

Front Panel:	SCPI Command:
Select System\DigPort , then Pin<#> where # is the pin number.	To configure the pin function: DIG:PIN<#>:FUNC DIO
Select Function, then Digital I/O.	To configure pin polarity: DIG:PIN<#>:POL <pol>
Go back one level, select Polarity, then either Positive or Negative.	To send data to the pins: DIG:OUTP:DATA <data>
To send digital data to the pins, select System\DigPort\Data .	
Select Data Out and enter the data as a binary number.	

Digital Input

Each of the seven pins can be configured as digital input only. The polarity of the pins can also be configured.

Front Panel:	SCPI Command:
Select System\DigPort , then Pin<#> where # is the pin number.	To configure the pin function: DIG:PIN<#>:FUNC DINP
Select Function, then Digital In.	To configure pin polarity: DIG:PIN<#>:POL <pol>
Go back one level, select Polarity, then either Positive or Negative.	To read the pin data: DIG:INP:DATA?
To read the data from the pins, select System\DigPort\Data .	
The input data is displayed as a binary number in the Data In field.	

External Trigger

Each of the seven pins can be configured as either trigger inputs or trigger outputs. The polarity of the pins can also be configured. When you program trigger polarity, POSitive means a rising edge and NEGative means a falling edge.

Front Panel:	SCPI Command:
Select System\DigPort , then Pin<#> where # is the pin number.	To select the trigger output function for pin 1: DIG:PIN1:FUNC TOUT
Select Function, then either Trigger In or Trigger Out.	To select the trigger input function for pin 2: DIG:PIN2:FUNC TINP
Go back one level, select Polarity, then either Positive or Negative.	To select the trigger polarity: DIG:PIN<#>:POL <pol>

Fault Output

Pins 1 and 2 can be configured as a fault-output pair. The polarity of pin 1 can also be configured.

Front Panel:	SCPI Command:
Select System\DigPort\Pin1 .	To configure the Fault function: DIG:PIN1:FUNC FAUL
Select Function, then Fault Out.	To select the fault output polarity: DIG:PIN1:POL <pol>
Go back one level, select Polarity, then either Positive or Negative.	

Inhibit Input

Pin 3 can be configured as a remote inhibit input. The polarity of pin 3 can also be configured.

Front Panel:	SCPI Command:
Select System\DigPort\Pin3 .	To configure the Inhibit function: DIG:PIN3:FUNC INH
Select Function, then Inhibit In.	To select the inhibit input polarity: DIG:PIN3:POL <pol>
Go back one level, select Polarity, then either Positive or Negative.	

After you have configured pin 3 as the remote inhibit input, you must also configure the operating mode of the inhibit signal. The inhibit signal can be latched or live. When latched, the outputs will remain disabled after an inhibit signal is received. When live, the outputs will follow the state of the inhibit input. The Inhibit operating mode is stored in non-volatile memory.

Front Panel:	SCPI Command:
Select Protection/Inhibit .	To latch the Inhibit signal: OUTP:INH:MODE LATC
Select either Latching or Live.	To set the Inhibit signal live: OUTP:INH:MODE LIVE
To disable Inhibit, select Off	To disable the Inhibit signal: OUTP:INH:MODE OFF

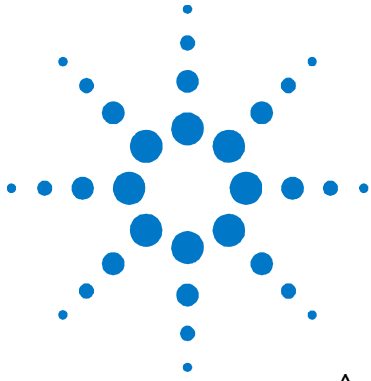

Appendix D Service



Returning an Instrument	170
Disassembly	171
Troubleshooting	176
Parts List and Parts Location	183
Error Messages	186

This chapter discusses how to return a failed instrument to Agilent Technologies for service or repair. Actual repair is done through unit exchange.

Information about for installing and removing modules, accessing the calibration switch, and installing a redundant ground is also provided.

This chapter also includes troubleshooting procedures for the N6700A and N6700B MPS mainframes. Troubleshooting procedures are provided to isolate defective assemblies. These procedures do not troubleshoot to the component level.

NOTE

No information is provided for troubleshooting individual power modules - other than identifying if a specific module is defective. If you have a defective module, you can return it to Agilent Technologies for repair or replacement.

Returning an Instrument

If your instrument fails during the warranty period, Agilent Technologies will replace or repair it free of charge. After your warranty expires, Agilent Technologies will replace or repair it at a competitive price. The standard repair process is “whole unit exchange”. The replacement units are fully refurbished and are shipped with new calibration certificates.

Contact your nearest Agilent Technologies Service Center. They will arrange to have your instrument repaired or replaced.

Operating Checklist

Before returning your instrument to Agilent Technologies for service or repair, check the following items:

Is the instrument inoperative?

- Verify that the ac power cord is connected to the instrument.
- Verify that the front-panel On/Standby switch has been pushed.

Is the display working?

- If the display is hard to read, but front-panel LED is lit and the fans are working, the display contrast setting may be too light or too dark. Use the front panel menu to set the display contrast.

Does the instrument fail self-test?

- Remove all external connections to the instrument.
- Check that modules are installed next to each other, starting with slot 1. If there are any empty slots (or filler modules) *between* the power modules, the power system will not operate.
- Check that the mainframe has the latest firmware installed.
- Turn off the unit and cycle power to run self-test again.

Repackaging for Shipment

If the unit is to be shipped to Agilent Technologies for service or repair, be sure to:

- Attach a tag to the unit identifying the owner and indicating the required service or repair. Include the model and serial number.
- Place the unit in its original container with the appropriate packaging material and secure the container with strong tape or metal bands.

If the original shipping container is not available, place your unit in a container that will ensure at least 4 inches of compressible packaging material around all sides for the instrument. Use static-free packaging materials to avoid additional damage to your unit.

Agilent Technologies suggests that you always insure shipments.



Disassembly

WARNING

SHOCK HAZARD. FAN HAZARD. Turn off the mainframe and disconnect its power cord before attempting any of the following disassembly procedures.

Electrostatic Discharge (ESD) Precautions

Almost all electrical components can be damaged by electrostatic discharge (ESD) during handling. Component damage can occur at electrostatic discharge voltages as low as 50 volts. The following guidelines will help prevent ESD damage when servicing the instrument or any electronic device.

- Disassemble instruments *only* in a static-free work area.
- Use a conductive work area to reduce static charges.
- Use a conductive wrist strap to reduce static accumulation.
- Minimize handling.
- Keep replacement parts in original static-free packaging.
- Remove all plastic, foam, vinyl, paper, and other static-generating materials from the immediate work area.

Required Tools

Tool	Use
9/32 Hex driver	Removing GPIB connector
5/16 Hex driver	Removing DC cable assembly from bias supply
T25 Torx driver	Removing carrier/bias board, handles, and bulk supply
T10 Torx driver	Removing covers, modules, and board assemblies
T8 Torx driver	Removing interface board on N6700A mainframes
Agilent 34401A DMM or equivalent	For measuring voltage and resistance

Ribbon Cables

- Note the position of the conductive side of the cable for re-installation. (The blue tab is on the non-conductive side.)
- Connectors release the cable by pulling on the end tabs as shown by the arrows in the following figure.

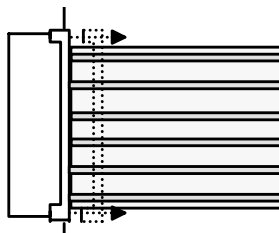

Removing/Installing Modules

CAUTION

Modules must be installed next to one another, starting with slot 1. Do not leave any empty slots *between* modules, otherwise the power system will not operate. Any remaining unused slots must have a filler module installed to ensure proper cooling. Do not install filler modules *between* power modules.

Step 1. Remove the blower cover. Remove three screws from the top of the cover and two screws on the sides. Tilt the cover up and slide it out.

Step 2. To remove a module, first remove the two fastening screws at either end of the module. Grasp the module at the ends (near the fan and the output connector), and lift it straight up out of the mainframe.

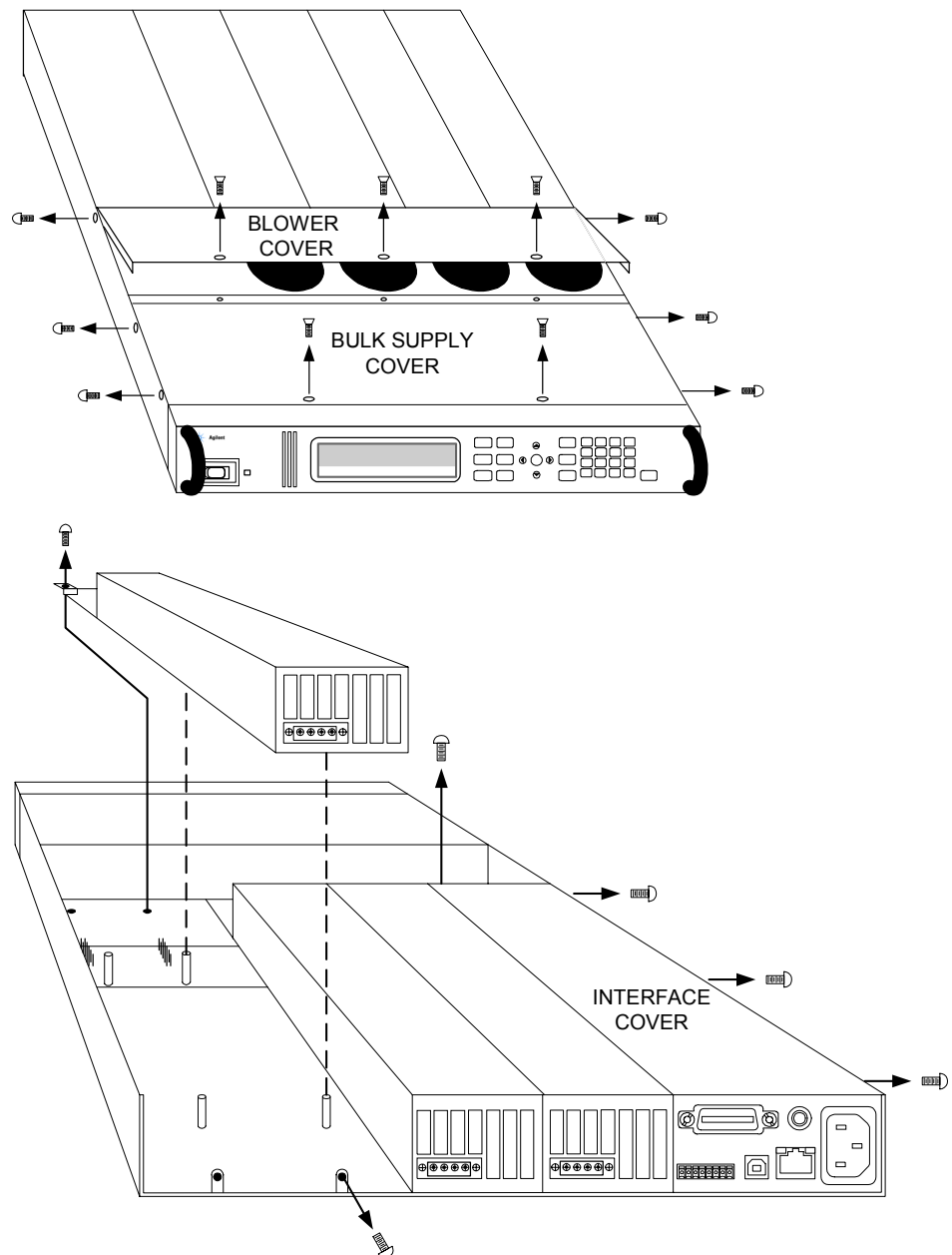

- Step 3.** To install a module, align the module over the alignment pins, and push it down onto the mainframe connector.
- Step 4.** Fasten the module to the mainframe. Install the two screws from the power module or filler module at either end of the module.
- Step 5.** Replace the blower cover when finished.

Accessing the Calibration switch

- Step 1.** Remove the blower cover. Remove three screws from the top of the cover and two screws on the sides. Tilt the cover up and slide it out.
- Step 2.** Remove the interface cover. Remove the three screws along the left side of the unit. Then remove the screw at the front of the cover. Lift off the cover.
- Step 3.** The calibration switch is on the interface board near the ribbon cable. (On Agilent N6700A mainframes, the switch is located under the ribbon cable on the carrier board.) To change the calibration switch settings, use a small screwdriver to move the switches. Refer to Appendix B for settings information.

CAUTION

Do not use a pencil to move the switches. Any graphite dust that gets on the switches will conduct electricity.

- Step 4.** Replace all covers when finished.

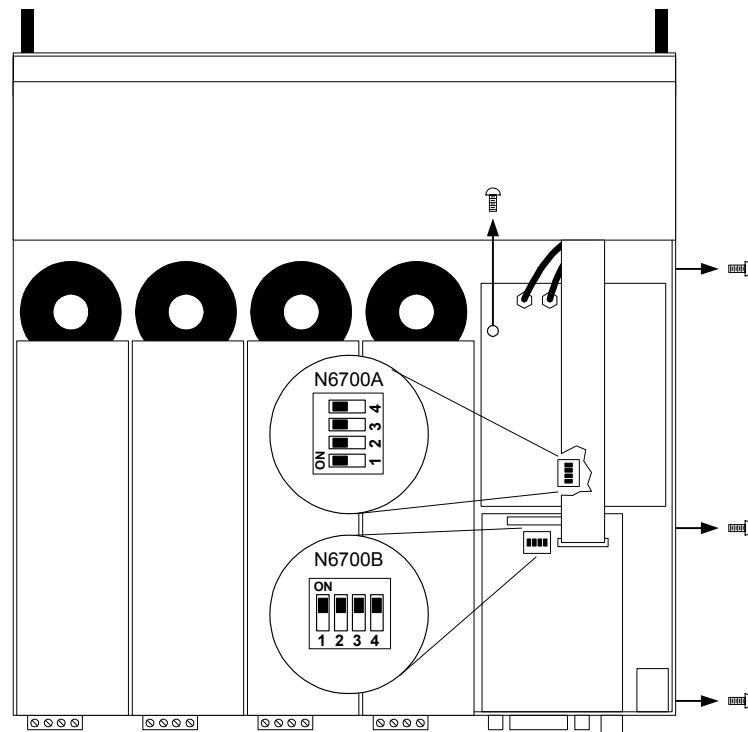

Removing/Installing the Interface (PPMC) board

- Step 1.** Remove the blower cover. Remove three screws from the top of the cover and two screws on the sides. Tilt the cover up and slide it out.
- Step 2.** Remove the interface cover. Remove the three screws along the left side of the unit. Then remove the screw at the front of the cover. Lift off the cover.
- Step 3.** Use a hex wrench to remove the GPIB connector from the rear of the mainframe. Disconnect all cable assemblies from the interface board.
- Step 4.** **On N6700A mainframes**, use a T8 driver and remove the 2 screws that attach the interface board. Lift the board out of the connectors located under the front edge of the board.
On N6700B mainframes, disconnect the 3 cable assemblies located along the front edge of the board. Use a T10 driver and remove the screws that attach the board to the chassis. Lift the board out.
- Step 5.** To reinstall the interface board, perform the above steps in reverse order. Replace all covers when finished.

Removing/Installing the Carrier/Bias board

- Step 1.** Remove the blower and interface covers as previously described.
- Step 2.** **On N6700A mainframes only**, also remove the interface board.
- Step 3.** Disconnect all cable assemblies from the carrier/bias board.
- Step 4.** Use a T10 driver and remove the screws that attach the carrier/bias board to the chassis. Use a T20 driver and remove the 4 screws that attach the board to the backplane assembly. Lift the board out.
- Step 5.** To reinstall the carrier/bias board, perform the above steps in reverse order. Replace all covers when finished.

Removing/Installing the Front Panel Assembly

- Step 1.** Remove the two screws along the front of the bulk supply cover. Then remove the two screws on each side of the front panel assembly.
- Step 2.** Slide the front panel assembly forward and away from the chassis to access the test points for troubleshooting.
- Step 3.** To completely remove the front panel assembly, disconnect the ribbon cable that connects the front panel to the interface board.
- Step 4.** Disconnect the wires going to the S1 switch assembly. For reassembly, make a note of the color coding of the wires and the pins to which they are connected.
- Step 5.** To remove the front panel board, remove the six screws that secure the board to the front frame assembly.
- Step 6.** To remove the display module, first disconnect the cable at the P1 connector and the ribbon cable at the J2 connector. Then untwist the tabs that hold the display module to the front panel board.

Step 7. To reinstall the front panel assembly, perform the above steps in reverse order.

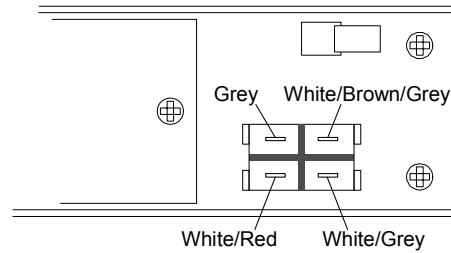

Removing/Installing the Bulk Supply

- Step 1.** Remove the modules from the mainframe as previously described.
- Step 2.** Remove the blower cover, bulk supply cover, and interface cover.
- Step 3.** Remove the four screws that attach the front panel assembly. Slide the front panel assembly forward and away from the chassis.
- Step 4.** You now have access to the four screws that install the bulk supply. Use a T20 driver and remove the four screws that fasten the bulk supply to the chassis. Disconnect the DC and AC cable assemblies. Lift the supply out of the unit.
- Step 7.** To reinstall the bulk supply, perform the above steps in reverse order.

Installing a Redundant Ground for 400 Hz Operation

Operation at 400 Hz requires the installation of a redundant ground from the instrument chassis to earth ground. The redundant ground must be permanently attached to the unit as well as to the earth ground point.

The following procedure only describes how to make the permanent connection at the unit. The user must ensure the integrity and permanence of the connection at the earth ground point.

The following customer-supplied hardware is required:

- Ground wire (14/16 AWG)
- Uninsulated ring terminal for attaching wire to unit
Tyco p/n 34122 or equivalent for N6700A mainframes
Tyco p/n 34124 or equivalent for N6700B mainframes
- Hardware for attaching wire to earth ground point

The following tools are required for installing the redundant ground:

- 5/16 inch hex wrench for N6700A mainframes
- 3/8 inch hex wrench for N6700B mainframes

- Step 1.** Remove the top cover of the GPIB board as previously described in this appendix under “Accessing the Calibration switch”.
- Step 2.** Use the wrench and remove the binding post (1) from the rear of the chassis. The binding post is located between the AC input connector and the GPIB connector.
- Step 3.** Crimp the appropriate ring terminal (2) onto the end of the ground wire.
- Step 4.** Place the ring terminal onto the threaded end of the binding post. Reinstall the binding post on the chassis with the washer and nut (3).
- Step 5.** Rotate the ring terminal so that the ground wire does not interfere with any other connectors on the back of the unit. Use the wrench and tighten the binding post to the chassis.
Torque for N6700A mainframes = 15 – 20 in-lb.
Torque for N6700B mainframes = 20 – 25 in-lb.

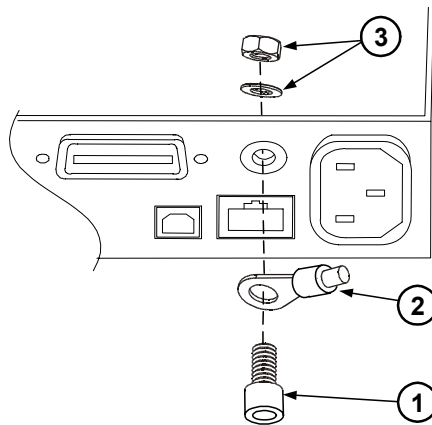

Troubleshooting

Before performing the Overall Troubleshooting procedures, perform the Operating Checkout procedure in the beginning of this chapter.

If the power system passes selftest and there are no obvious faults, perform the verification procedures in Appendix B to determine if any power modules are not calibrated, or are not operating properly. This will help isolate a problem to a specific power module.

Overall Troubleshooting

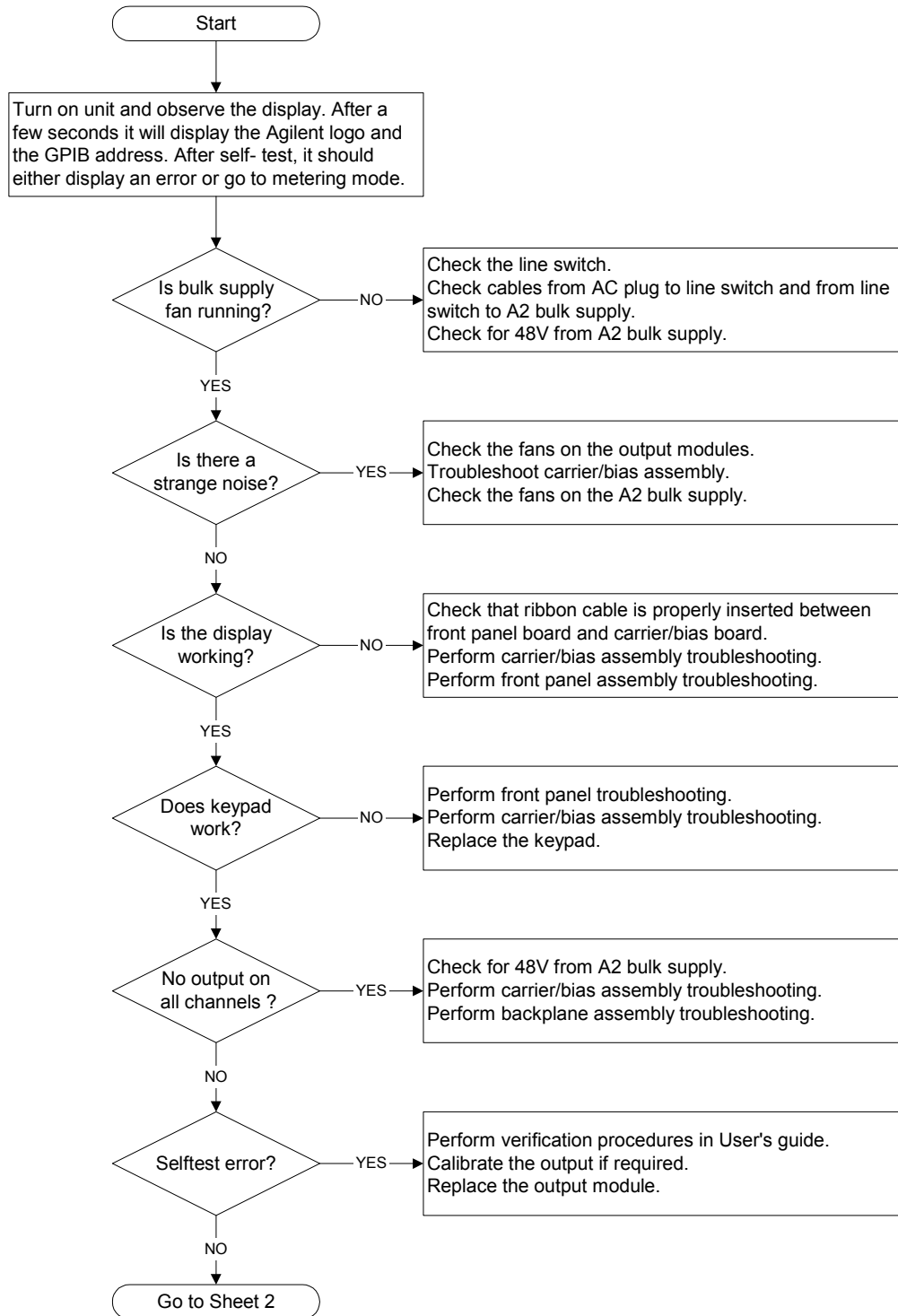

Overall Troubleshooting Sheet 1

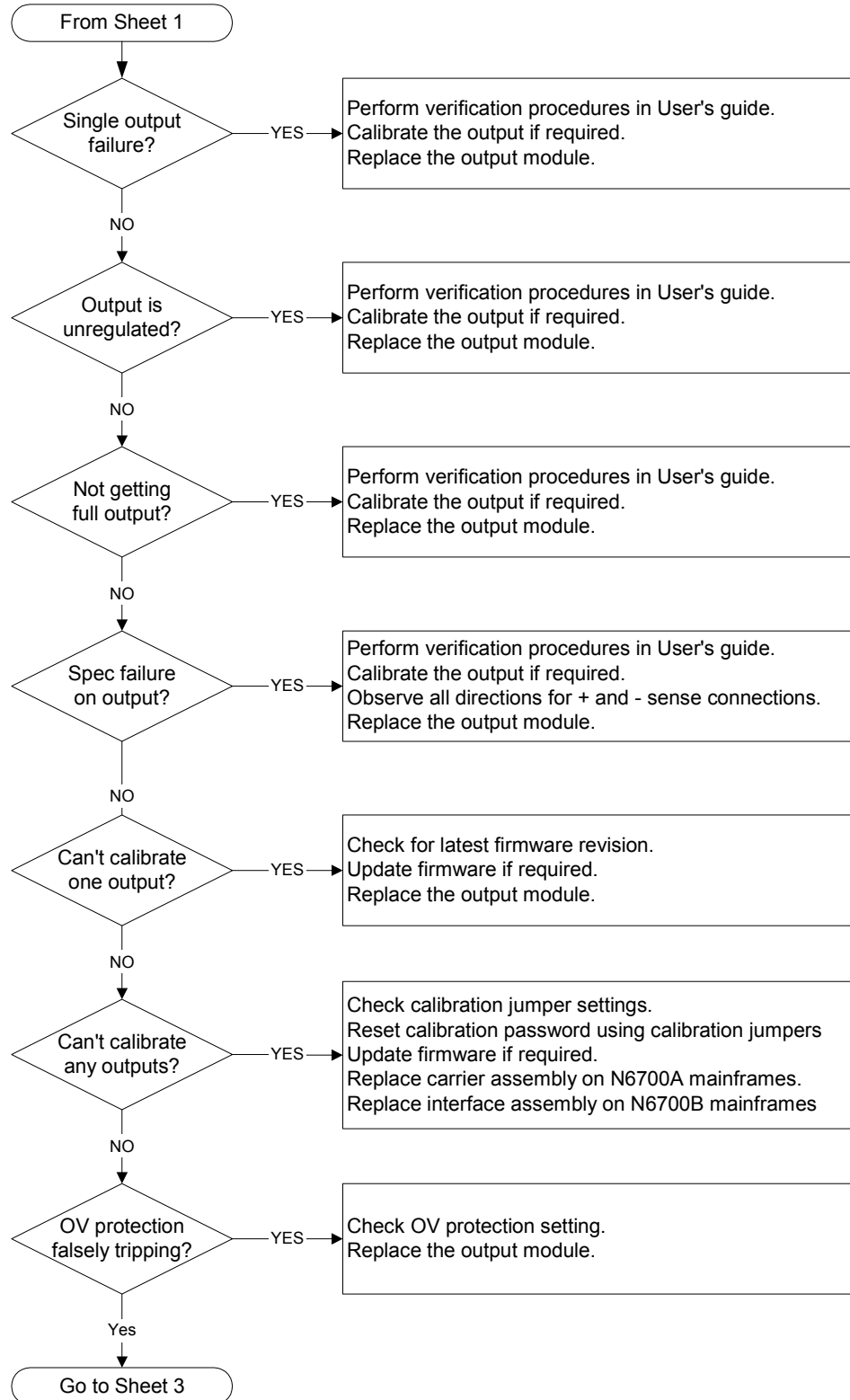

Overall Troubleshooting Sheet 2

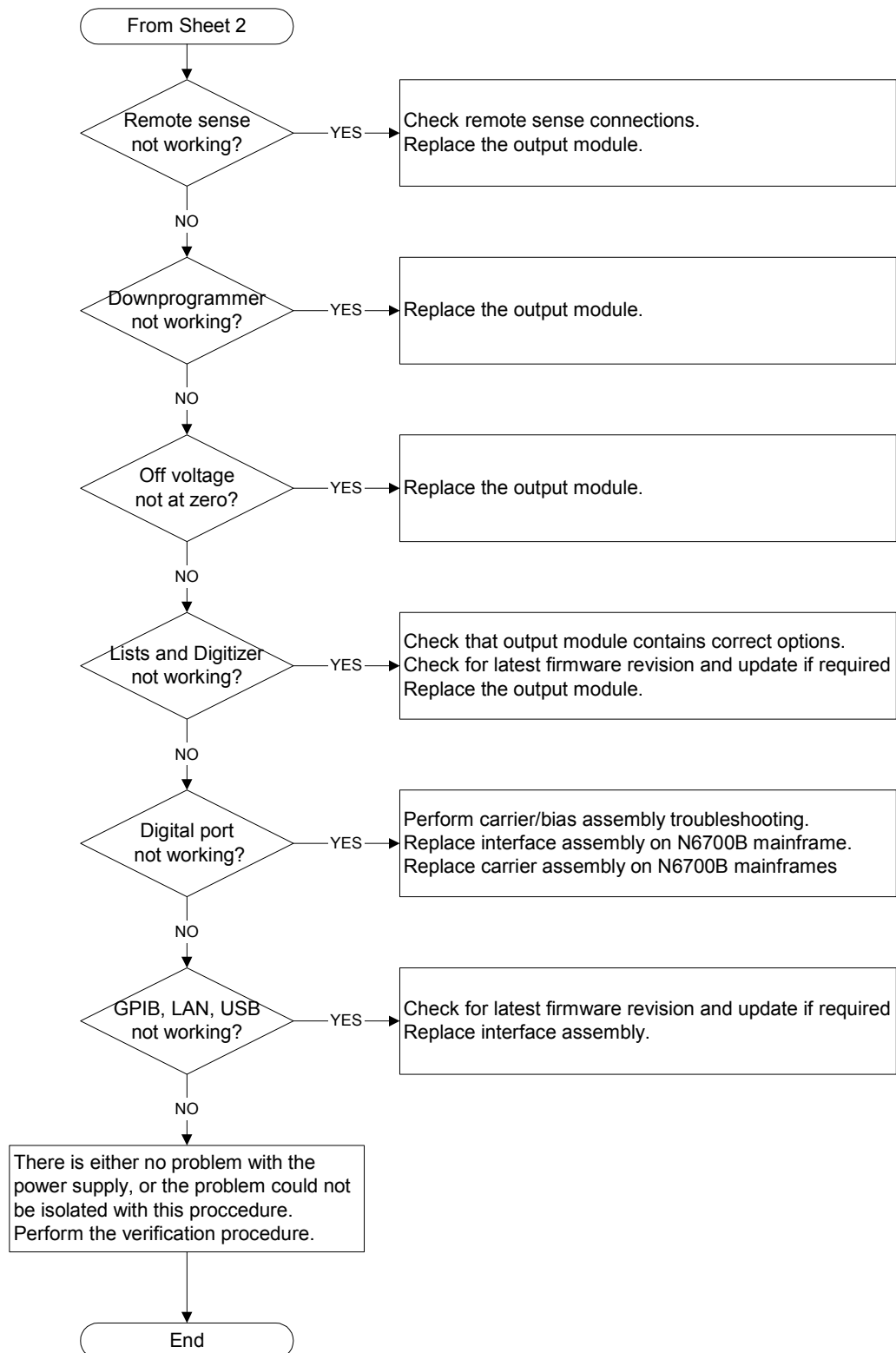

Overall Troubleshooting Sheet 3

Front Panel Troubleshooting

Troubleshooting the front panel board involves checking for the presence of the correct bias voltages on the board. Refer to the following table and figure.

Test Point	Location	Voltage	Action
TP 1	BKL_VCC	+12 V	If bias not present, troubleshoot the carrier/bias board or replace the front panel board.
TP 2	P1 pin 3	+12 V	If backlight voltage not present, replace the front panel board. If voltage is present and the display is not lit, replace the display.
Common	GNDB	Common	

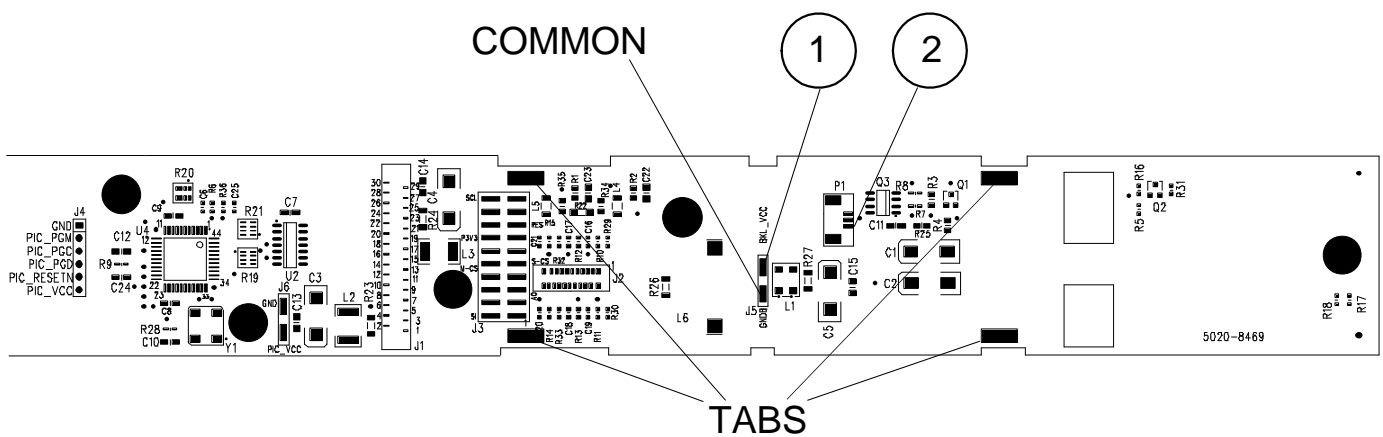

Carrier/Bias Board Troubleshooting

Troubleshooting the carrier board involves checking for the correct bias voltages on the board. Refer to the following table and figures.

Note that if the bias voltages at test points 2 - 4 in the following table are not present, it could be caused by a defect in the power module or interface board that is pulling the bias voltage low.

Test Point	Location	Voltage	Action
TP 1	+ RED	+48 V	Output of bulk supply. If not present, replace the bulk supply.
TP 2	+ C4	+12 V	If biases at TP 2, TP 3, or TP 4 are not present, disconnect the backplane and interface board and recheck again (see note 1). If biases are still not present, replace the carrier/bias board.
TP 3	U9 - 2 (N6700B) U10 - 8 (N6700A)	+5 V	Same as above.
TP 4	+ C3 (N6700B) U5 - 2 (N6700A)	+3.3 V	Same as above.
Common	- BLK	Common	

NOTE 1 On N6700B mainframes, disconnect cable #15. (Refer to parts location diagrams.)
On N6700A mainframes, disconnect cables #12 and #13. Unplug the interface board from the carrier board.

N6700B BIAS BOARD (A4)

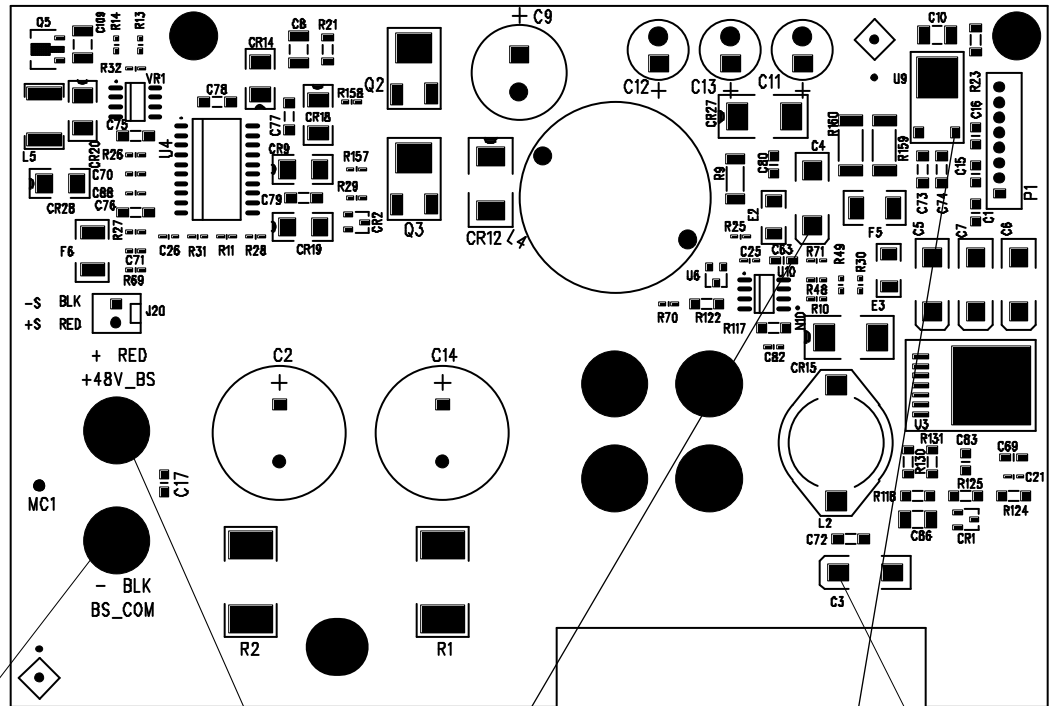

COMMON

1

2

3

4

N6700A CARRIER BOARD (A4)

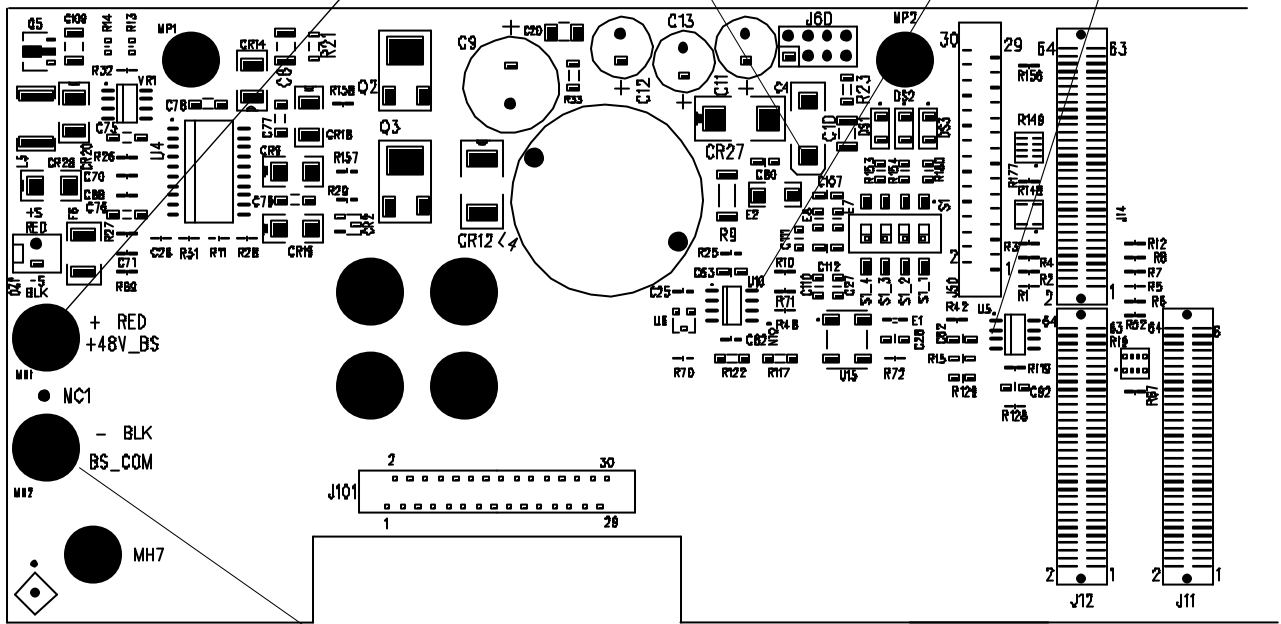

COMMON

Backplane Board Troubleshooting

Troubleshooting the backplane board consists of visually inspecting the pins and pin connections.

If there are missing or broken pins, replace the board.

If there are bent pins, carefully try to straighten the pin. If you are unsuccessful, replace the board.

Closely examine the solder connections at the pins. If there are cracks in the solder, carefully re-solder the connector. If unsuccessful, replace the board.

Calibration and Passwords

Calibration is not required after the mainframe has been repaired. All calibration information is module-specific and resides in each power module.

However, if boards that contain the calibration switches have been replaced (A4 board on N6700A mainframes; A5 board on N6700B mainframes), any calibration password that has been set will be lost. Passwords that are used to prevent access to the front panel Admin menu will also be lost.

The calibration password will automatically be reset to the factory default, which is zero (0). Front panel access to the Admin menu will be unrestricted unless a password is set.

Refer to the User's Guide for information on setting the calibration password as well as the Admin menu password.

Initialization

The power system's model number, serial number, and other constants that are required to program the instrument are also stored in an EEPROM on the A5 board. If this board is replaced, the instrument must be re-initialized.

To initialize the power system, you must send the following information to the power system over the interface:

```
DIAGnostic:FRAMe:ATTRibute "ModelNumber", "value"
```

where "value" is the model number, e.g. N6700B.

```
DIAGnostic:FRAMe:ATTRibute "SerialNumber", "value"
```

where "value" is the serial number located on top of the interface cover.

At power-up, the power system will go through the turn-on self test sequence. All other parameters will be set to the factory defaults. The mainframe is now initialized.

Parts List and Parts Location

The following table documents the replaceable parts assemblies. The diagrams show the location of the parts.

Reference Designator	N6700B Part number	N6700A Part number	Description
Electrical Assemblies			
A1	N6700-69001	N6700-69001	A1 Front Panel PCA (tested)
A2	0950-4655	0950-4494	A2 Bulk Supply
A3	5065-6981	5065-6981	A3 Backplane PCA
A4	N6700-60101	5065-7008	A4 Carrier/Bias PCA (tested)
A5	N6700-60102	5065-7010	A5 Interface PCA (tested)
Individual Parts			
1	5002-2817	5002-2805	Chassis frame
2	5002-2808	5002-2808	Front frame
3	1390-1079	1390-1079	Handles
4	N6700-40001	N6700-40001	Keypad
5	2090-0886	2090-0886	Display
6	4040-2556	4040-2556	Window
7	N6700-00001	N6700-00001	Front panel
8	3101-4019	3101-4019	Line switch
9	5185-1358	5185-1358	Cable, bulk supply to ground
10	5185-1357	5185-1357	Cable, bulk supply to switch
11	5185-1362	5185-1362	Cable, DC power
12	5185-1354	5185-1354	Ribbon cable, to front panel
13	5185-1382	5185-1353	Ribbon cable, to backplane
14	5185-1352	5185-1352	Insulator, under backplane
15	5185-1384	N/A	Bias cable assembly
16	5185-1397	5185-1355	AC cable with socket
17	1510-0038	1510-0044	Binding post
18	E5810-61605	E5810-61605	GPIB connector with cable
19	1253-6408	1253-5830	Digital plug
Covers and Labels			
	5002-2809	5002-2809	Bulk supply cover
	5002-2810	5002-2810	Blower cover
	5002-2807	5002-2807	Interface cover
	N6700-80006	N6700-80001	Front/Rear/Interface labels
	5185-1387	5185-1387	Blower cover label (caution)

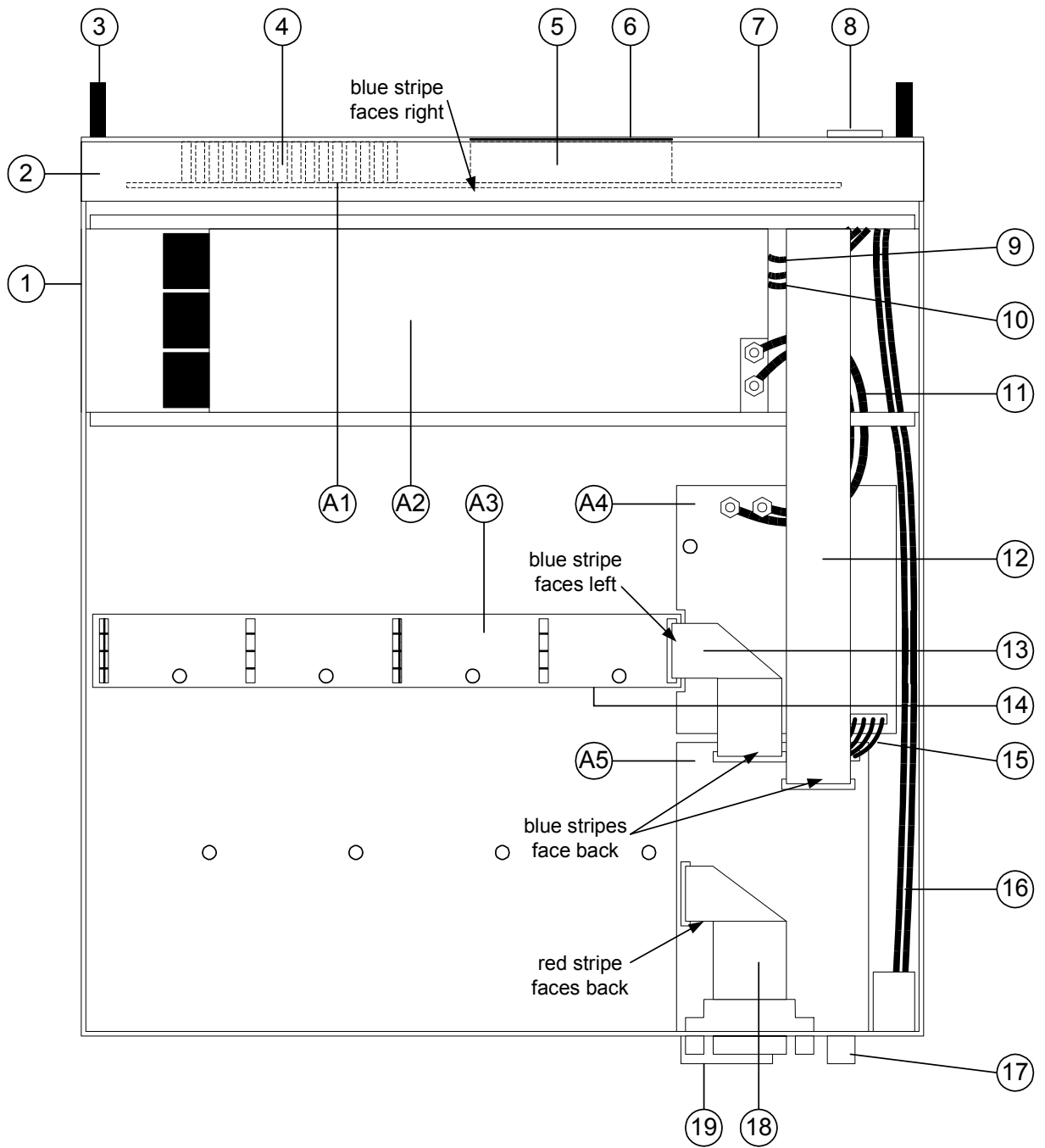

N6700B Mainframe Part Locations

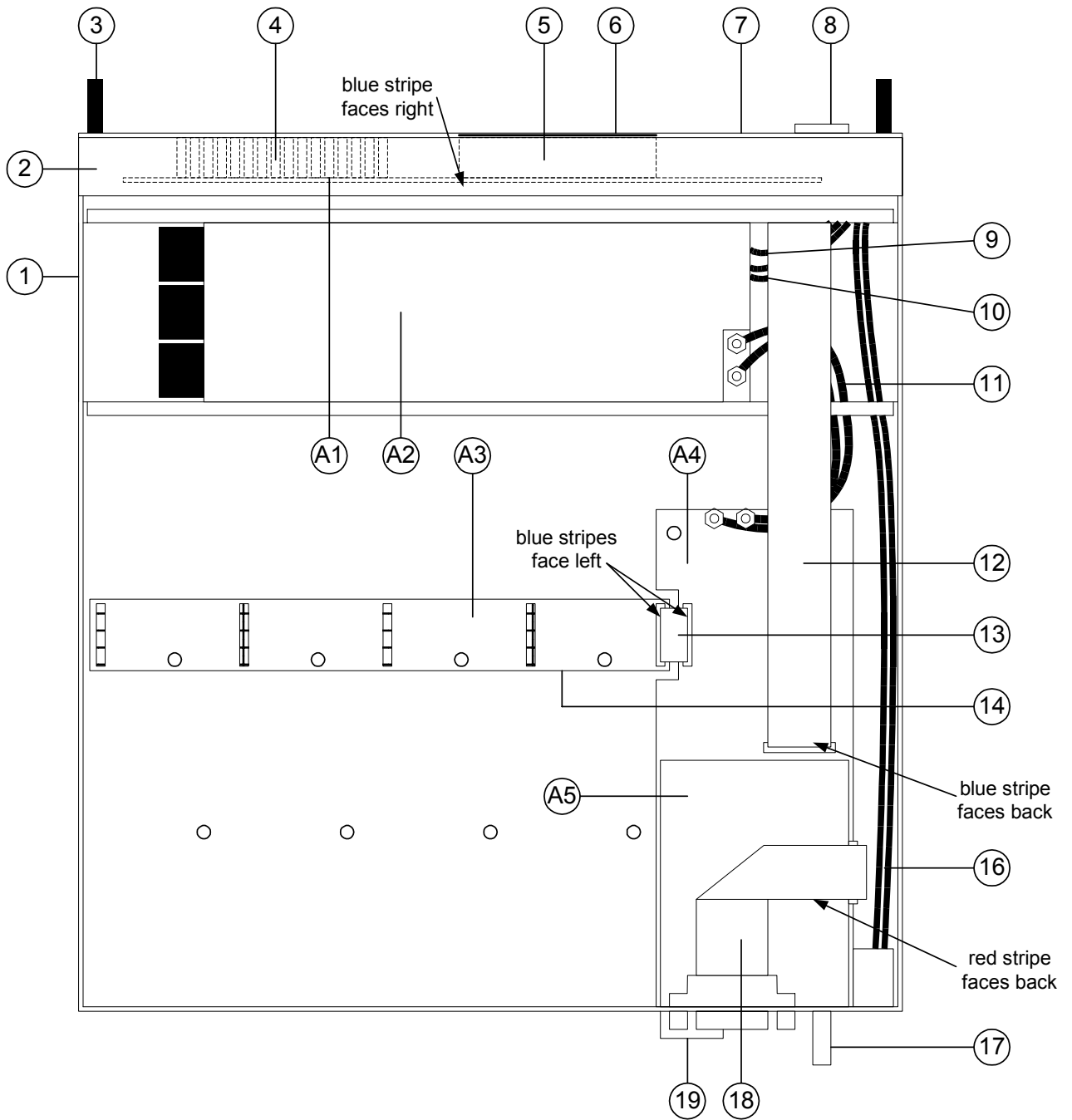

N6700A Mainframe Part Locations

Error Messages

Displaying the SCPI error queue

Front Panel:	SCPI Command:
Press the Error key.	SYST:ERR?
If errors appear, use the navigation keys to scroll through the list.	

The entire error queue is read, then emptied.

Error List

The following table documents the various error messages that the power system supports:

Error	Device-dependent Errors (these errors set Standard Event Status register bit #3)
0	No error This is the response to the ERR? query when there are no errors.
100	Too many channels You have specified more channels than are installed in the mainframe.
101	Calibration state is off Calibration is not enabled. The instrument will not accept calibration commands.
102	Calibration password is incorrect The calibration password is incorrect.
103	Calibration is inhibited by switch setting Calibration mode is locked out by the calibration switch.
104	Bad sequence of calibration commands Calibration commands have not been entered in the proper sequence.
105	Unexpected output current The measured output current is outside the acceptable range.
106	Zero measurement out of range error The "zero" measurement value is outside the acceptable range.
107	Programming cal constants out of range The programmed calibration constant is outside the acceptable range.
108	Measurement cal constants out of range The measurement calibration constant is outside the acceptable range.
109	Over voltage cal constants out of range The over voltage calibration constant is outside the acceptable range.
110	Wrong V+I The instrument was unable to set the correct voltage or current value.
111	Aux vloc cal constants out of range Calibration constants on the internal auxiliary local ADC are outside the acceptable range.
112	Aux vrem cal constants out of range Calibration constants on the internal auxiliary remote ADC are outside the acceptable range.
113	Aux imon cal constants out of range Calibration constants on the internal auxiliary imon ADC are outside the acceptable range.

Device-dependent Errors (continued)	
200	Hardware error channel <channel> A hardware error has occurred on the specified channel.
201	Invalid configuration, empty slots There is an empty slot between modules. This configuration is not allowed.
202	Selftest Fail A selftest failure has occurred. See selftest failure list for details.
203	Compatibility function not implemented The requested compatibility function is not available.
204	NVRAM checksum error A checksum error has occurred in the instrument's nonvolatile random access memory.
205	NVRAM full The nonvolatile random access memory of the instrument is full.
206	File not found The internal calibration file or the internal channel attribute file was not found in NVRAM.
207	Cal file version error The calibration file was written or read using old firmware. Firmware must be updated.
302	Option not installed The option that is programmed by this command is not installed.
303	There is not a valid acquisition to fetch from There is no valid data in the measurement buffer.
304	Volt and curr in incompatible transient modes Voltage and current cannot be in Step and List mode at the same time.
305	A triggered value is on a different range A triggered value is on a different range than the one that is presently set.
306	Too many list points Too many list points have been specified.
307	List lengths are not equivalent One or more lists are not the same length.
308	This setting cannot be changed while transient trigger is initiated Setting cannot be changed while the instrument is waiting for or executing a trigger sequence.
309	Cannot initiate, voltage and current in fixed mode Cannot initiate the transient generator because either the voltage or the current function is set to Fixed mode.
<hr/>	
Command Errors (these errors set Standard Event Status register bit #5)	
-100	Command error Generic syntax error.
-101	Invalid character An invalid character was found in the command string.
-102	Syntax error Invalid syntax was found in the command string. Check for blank spaces.
-103	Invalid separator An invalid separator was found in the command string. Check for proper use of , ; :
-104	Data type error A different data type than the one allowed was found in the command string.
-105	GET not allowed A group execute trigger is not allowed in a command string.

Command Errors (continued)	
-108	Parameter not allowed More parameters were received than were expected.
-109	Missing parameter Fewer parameters were received than were expected.
-110	Command header error An error was detected in the header.
-111	Header separator error A character that was not a valid header separator was found in the command string.
-112	Program mnemonic too long The header contains more than 12 characters.
-113	Undefined header A command was received that was not valid for this instrument.
-114	Header suffix out of range The value of the numeric suffix is not valid.
-120	Numeric data error Generic numeric data error.
-121	Invalid character in number An invalid character for the data type was found in the command string.
-123	Exponent too large The magnitude of the exponent was larger than 32000.
-124	Too many digits The mantissa of a numeric parameter contained more than 255 digits, excluding leading zeros.
-128	Numeric data not allowed A numeric parameter was received but a character string was expected.
-130	Suffix error Generic suffix error
-131	Invalid suffix A suffix was incorrectly specified for a numeric parameter.
-134	Suffix too long The suffix contains more than 12 characters.
-138	Suffix not allowed A suffix is not supported for this command.
-140	Character data error Generic character data error
-141	Invalid character data Either the character data element contains an invalid character, or the element is not valid.
-144	Character data too long The character data element contains more than 12 characters.
-148	Character data not allowed A discrete parameter was received, but a string or numeric parameter was expected.
-150	String data error Generic string data error
-151	Invalid string data An invalid character string was received. Check that the string is enclosed in quotation marks.
-158	String data not allowed A character string was received, but is not allowed for this command.

Command Errors (continued)	
-160	Block data error Generic block data error
-161	Invalid block data The number of data bytes sent does not match the number of bytes specified in the header.
-168	Block data not allowed Data was sent in arbitrary block format but is not allowed for this command.
-170	Expression error Generic expression error
-171	Invalid expression data The expression data element was invalid.
-178	Expression data not allowed Expression data element was sent but is not allowed for this command.
Execution Errors (these errors set Standard Event Status register bit #4)	
-200	Execution error Generic syntax error
-220	Parameter error A data element related error occurred.
-221	Settings conflict A data element could not be executed because of the present instrument state.
-222	Data out of range A data element could not be executed because the value was outside the valid range.
-223	Too much data A data element was received that contains more data than the instrument can handle.
-224	Illegal parameter value An exact value was expected but not received.
-225	Out of memory The device has insufficient memory to perform the requested operation.
-226	Lists not same length One or more lists are not the same length.
-230	Data corrupt or stale Possible invalid data. A new reading was started but not completed.
-231	Data questionable The measurement accuracy is suspect.
-232	Invalid format The data format or structure is inappropriate.
-233	Invalid version The version of the data format is incorrect to the instrument.
-240	Hardware error The command could not be executed because of a hardware problem with the instrument.
-241	Hardware missing The command could not be executed because of missing hardware, such as an option.
-260	Expression error An expression program data element related error occurred.
-261	Math error in expression An expression program data element could not be executed due to a math error.

Query Errors (these errors set Standard Event Status register bit #2)	
-400	Query Error Generic error query
-410	Query INTERRUPTED A condition causing an interrupted query error occurred.
-420	Query UNTERMINATED A condition causing an unterminated query error occurred.
-430	Query DEADLOCKED A condition causing a deadlocked query error occurred.
-440	Query UNTERMINATED after indefinite response A query was received in the same program message after a query indicating an indefinite response was executed.
Selftest Errors (these errors set Standard Event Status register bit #3)	
202	Selftest Fail Aux Adc 0 expected <n1> to <n2>, measured <n3>, chan <n4> Auxiliary ADC failed. n1 and n2 are the expected limits. n3 is the measured value. n4 is the channel location of the failed module.
202	Selftest Fail DACs 0 expected <n1> to <n2>, measured <n3>, chan <n4> Both voltage and current DACs are at zero. n1 and n2 are the expected limits. n3 is the measured value. n4 is the channel location of the failed module.
202	Selftest Fail DACs 1 expected <n1> to <n2>, measured <n3>, chan <n4> Voltage DAC is at zero; current DAC is at full scale. n1 and n2 are the expected limits. n3 is the measured value. n4 is the channel location of the failed module.
202	Selftest Fail DACs 2 expected <n1> to <n2>, measured <n3>, chan <n4> Voltage DAC is at full scale; current DAC is at zero. n1 and n2 are the expected limits. n3 is the measured value. n4 is the channel location of the failed module.
202	Selftest Fail DACs 3 expected <n1> to <n2>, measured <n3>, chan <n4> Both voltage and current DACs are at full scale. n1 and n2 are the expected limits. n3 is the measured value. n4 is the channel location of the failed module.

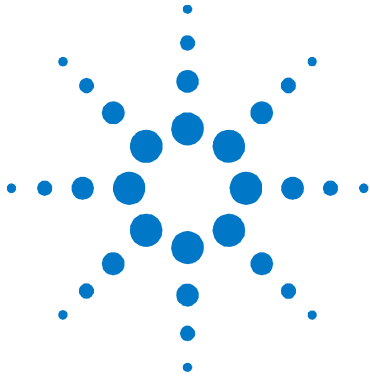

Appendix E Compatibility

Differences – In General	192
Compatibility Command Summary	193
Differences in Earlier Agilent N6700A Mainframes	197

The Agilent N6700 MPS is programmatically compatible with the Agilent 6621A – 6629A DC power supplies. This means that you can program the power system using the same commands that are used to program the Agilent 662xA power supplies. The following table describes the model mapping.

In addition to the pre-configured models shown below, Agilent 662xA commands will also work in mainframes that contain any combination of Agilent N675xA or N676xA power modules.

NOTE

Agilent 662xA commands will NOT work in mainframes that contain any Agilent of N673xA/B or N674xA/B power modules. This is true even if the mainframes also contain Agilent N675xA or N676xA power modules.

Pre-configured Agilent MPS Model ¹	Description	Previous Agilent Model
N6721A	N6700A mainframe with 2 - N6752A autoranging modules	6621A
N6722A	N6700A mainframe with 2 - N6752A autoranging modules	6622A
N6723A	N6700A mainframe with 2- N6751A and 1- N6752A autoranging module	6623A
N6724A	N6700A mainframe with 4 - N6751A autoranging modules	6624A
N6725A	N6700A mainframe with 1 - N6761A and 1 - N6762A precision module	6625A
N6726A	N6700A mainframe with 2 - N6761A and 2 - N6762A precision modules	6626A
N6727A	N6700A mainframe with 4 - N6751A autoranging modules	6627A
N6728A	N6700A mainframe with 2 - N6762A precision modules	6628A
N6729A	N6700A mainframe with 4 - N6762A precision modules	6629A

¹These Agilent MPS models are no longer orderable.

This appendix also contains a section describing how the earlier Agilent N6700A mainframes are different from the Agilent N6700B mainframes, which are the primary focus of this manual.

Differences – In General

The following table documents the general differences between the way Compatibility programming commands work on the Agilent N6700 MPS and the way they work on the Agilent 662xA series DC power supplies.

Item	Differences
Queries	<p>The Agilent N67xxA modules will respond to multiple queries.</p> <p>It will not allow a space separator between numbers.</p> <p>It will not allow a user to query information, read back only a portion of the information, send another command, and finish reading back the information from the original query.</p> <p>Sending a second query without reading the response to the first will generate an error.</p> <p>Model number queries will only return the N6700 model number.</p>
Status functions	<p>Serial Poll will be controlled by the SCPI status model and will not act like a 662xA serial poll.</p> <p>SRQ will be controlled by the SCPI status model.</p> <p>Parallel poll will not work.</p> <p>The Agilent N67xxA modules will never set the CC- bit. All other status bits are translated to the closest 662xA bits.</p>
Settings	<p>The full-scale limits will match the Agilent N67xxA module limits.</p> <p>There is no automatic setting adjustment.</p>
Measurement	<p>Measurements use the present settings for points, time interval, etc.</p> <p>Floating point numbers returned by the instrument may not have exactly the same syntax or number of digits.</p>
Calibration	<p>Calibration must be done in SCPI.</p>
Storage states	<p>The Agilent N67xxA modules have 2 non-volatile states and 9 volatile states. The 9 volatile states are only available when using compatibility commands.</p>
Protection functions	<p>OVRST and OCRST will reset all latched protection functions, not just over-voltage or over-current.</p>

Compatibility Command Summary

The following table documents the compatibility commands that the Agilent N6700 MPS supports. All compatibility commands are accepted; however, some commands will generate an error.

Agilent 662xA Command	Description	Similar SCPI Command
ASTS? <ch>	Queries the accumulated status (ASTS) of the specified output channel. The response represents the sum of the binary weights of the ASTS register bits. The ASTS register is automatically set to the present status after being queried.	STAT:OPER:EVEN? STAT:QUES:EVEN? *ESE?
CLR	Returns the entire power system (all outputs) to the power-on state, except the unit is not unaddressed and its store/recall registers are not changed.	*RST
CMODE <on/off>	Generates error –113. The unit must be calibrated using SCPI commands.	see Appendix B
CMODE?	Generates error –113. The unit must be calibrated using SCPI commands.	see Appendix B
DC <ch>, < on/off >	Turns the specified output channel on or off. On/off = 0 turns the channel off; on/off = 1 turns the channel on.	OUTP:STAT
DC? <ch>	Queries whether the specified output channel is on or off. Response is either 1 (on) or 0 (off).	OUTP:STAT?
DCPON < on/off >	Sets the power-on state of the output channels. For on/off = 0, all outputs will be off state when the unit is turned on. For on/off = 1 all outputs will be in the on state when the power system is turned on. This command requires the output power-on state to be set to RCL0.	OUTP:PON:STAT RCL0
DCPON?	Returns a 1 if any channels are set to turn on their output at power on.	OUTP:PON:STAT?
DLY <ch>, <delay>	Sets the reprogramming delay for the specified output channel. This delay is used to mask the CV, CC, CP-, UNR, and other status bits from the fault register and the OCP function for the specified delay period.	OUTP:PROT:DEL
DLY? <ch>	Queries the present reprogramming delay of the specified output channel.	OUTP:PROT:DEL?
DSP <on/off>	Does nothing.	None
DSP?	Always returns a 1.	None
DSP "xxxxxxxxxxx"	Does nothing.	None
ERR?	Queries the present programming or hardware error. An error code number is returned over the GPIB to identify the error.	SYST:ERR?
FAULT? <ch>	Queries the fault register of the specified output channel. A bit is set in the fault register when the corresponding bit in both the status and the mask registers. The response is an integer 0 to 255. The fault register is cleared after being read.	STAT:OPER? STAT:QUES? *ESE?
ID?	Queries the model number of the power system.	*IDN?
IDATA <ch>, <llo>, <lhi>	Generates error –113. Unit must be calibrated using SCPI commands.	see Appendix B

Agilent 662xA Command	Description	Similar SCPI Command
IHI <ch>	Generates error –113. Unit must be calibrated using SCPI commands.	see Appendix B
ILO <ch>	Generates error –113. Unit must be calibrated using SCPI commands.	see Appendix B
IOUT? <ch>	Queries the measured output current of the specified output channel. The response is a real number. The front panel display can be used to monitor the measured output current (and voltage) of the selected output channel.	MEAS : CURR ?
IRLO <ch>	Generates error –113.	None
IRHI <ch>	Generates error –113.	None
IRLN <ch>	Generates error –113.	None
IRHN <ch>	Generates error –113.	None
IRSET <ch>, <x>	Sets the full-scale current range programming for an output channel. The power system will select the lowest operating range that will contain the value (x). If the present operating current is greater than the full-scale range selected, the present output current will be reduced to the full-scale value of the new range selected. If the current entered is larger than the highest possible range, an error will result.	SENS : CURR : RANG
IRSET? <ch>	Queries the full-scale current range setting of an output channel.	SENS : CURR : RANG ?
ISET <ch>, <current>	Sets the current of the specified output channel.	CURR
ISET? <ch>	Queries the present current setting of the specified output channel. The response is a real number.	CURR ?
ISTEP <ch>, <x>	Increases or decreases the output channel current in steps. If the step value < x > is positive, output current will increase by the step value, if the step value is negative, the output current will decrease by the step value. Stepping beyond the active operating range causes an error.	LIST : CURR
METER <ch>	Does nothing.	None
METER?	Always returns a 1.	None
OCP <ch>, <on/off>	Enables the over-current protection circuit for the specified output channel. This circuit, when enabled, causes the output to go to the off state when the output is in + CC mode. On/off is a 1 to turn on (enable) or a 0 to turn off (disable) the circuit.	CURR : PROT : STAT
OCP? < ch >	Queries the over-current protection circuit on/off status for the specified output channel. Response is either a 1 (on) or a 0 (off).	CURR : PROT : STAT ?
OCRST < ch >	Returns the specified output channel to its previous settings after it has been turned off by a protection shutdown.	OUTP : PROT : CLE
OUT < ch >, < on/off >	Turns the specified output channel on or off. <on/off> equals 1 to turn the output on and equals 0 to turn the output off.	OUTP
OUT? < ch >	Queries whether the specified output channel is turned on or off . The response is either 1 (on) or 0 (off).	OUTP ?

Agilent 662xA Command	Description	Similar SCPI Command
OVCAL < ch >	Generates error –113. Unit must be calibrated using SCPI commands.	see Appendix B
OVRST < ch >	Returns the specified output channel to its previous settings after it has been turned off by a protection shutdown.	OUTP:PROT:CLE
OVSET <ch>, <ovpoint>	Sets the over-voltage trip point for the specified output channel.	VOLT:PROT:LEV
OVSET? < ch >	Queries the present over-voltage setting of the specified output channel. The response is a real number.	VOLT:PROT:LEV?
PON < on/off >	Does nothing.	*SRE
PON?	Always returns a 0.	*SRE?
RCL < reg >	Recalls the settings for all output channels from the specified internal register. These settings were previously stored using the STO command. RCL programs all output channels in sequential order to these stored settings.	*RCL
RELAY < on/off >	Generates error 203. This Option 750 capability is not supported.	None
RELAY?	Generates error 203. This Option 750 capability is not supported.	None
RIRST < ch >	Resets all protection functions for the specified channel. This Option 750 capability is supported	OUTP:PROT:CLE
ROM?	Queries the revision of the power system's firmware.	*IDN?
SROM?	Queries the revision of the power system's firmware.	*IDN?
SRQ < setting >	Does nothing.	*SRQ
SRQ?	Always returns a 0.	*SRQ?
STO <reg>	Stores the present settings for all output channels in the specified register. These settings can be recalled when desired.	*SAV
STS? <ch>	Queries the present status of the specified output channel. The response represents the sum of the binary weights of the status register bits.	STAT:OPER:COND? STAT:QUES:COND?
TEST?	Always returns a 0.	*TST?
UNMASK <ch>, <setting>	Sets the bits in the mask register of the specified output channel to the setting. The setting is an integer that represents the sum of the binary weights of the bits. The mask register operates in conjunction with the status and fault registers.	STAT:OPER:NTR STAT:OPER:PTR STAT:QUES:NTR STAT:QUES:PTR
UNMASK? <ch>	Queries the present setting of the mask register of the specified output channel. The response is an integer from 0 to 255.	STAT:OPER:NTR? STAT:OPER:PTR? STAT:QUES:NTR? STAT:QUES:PTR?
VDATA <ch>, <Vlo>, <Vhi>	Generates error –113. Unit must be calibrated using SCPI commands.	see Appendix B
VHI <ch>	Generates error –113.	None
VLO <ch>	Generates error –113.	None

Agilent 662xA Command	Description	Similar SCPI Command
VMUX? <ch>, <input>	Generates error –113.	None
VOUT? <ch>	Queries the measured output voltage of the specified output channel. The response is a real number. The front panel display can be used to monitor the measured output voltage (and current) of the selected output channel.	MEAS : VOLT?
VRLO <ch>	Generates error –113.	None
VRHI <ch>	Generates error –113.	None
VRSET <ch>, <x>	Sets the full-scale voltage range programming for an output channel. The power system will select the lowest operating range that will contain the value (x). If the present operating voltage is greater than the full-scale range selected, the present output voltage will be reduced to the full-scale value of the new range selected. If the voltage entered is larger than the highest possible range, an error message will result.	None
VRSET? <ch>	Queries the full scale voltage range setting of an output channel.	None
VSET <ch>, <voltage>	Sets the voltage of the specified output channel.	VOLT
VSET? <ch>	Queries the present voltage setting of the specified output channel. The response is a real number.	VOLT?
VSTEP <ch>, <x>	Increases or decreases the output channel voltage in steps. If the step value < x > is positive, output voltage will increase by the step value, if the step value is negative, the output voltage will decrease by the step value. Trying to step beyond the operating range will cause a number range error.	LIST : VOLT

Differences in Earlier Agilent N6700A Mainframes

Hardware Differences

Digital Control Port

Agilent N6700A mainframes use a 4-pin connector instead of the 8-pin connector available on Agilent N6700B mainframes.

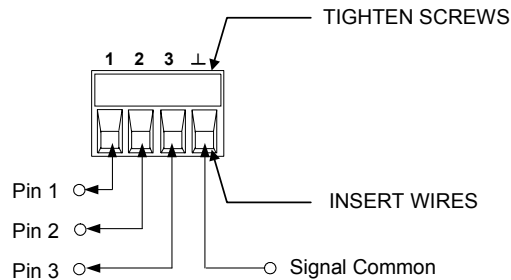

Pin functionality on the 4-pin connector is the same as the first 3 pins and the common pin on the 8-pin connector. The following chart describes the pin functions.

Pin	External Trigger	Fault/Inhibit	Digital I/O
1	Trigger In/Out	FLT Output	Input/Output 0
2	Trigger In/Out	FLT Common	Input/Output 1
3	Trigger In/Out	INH Input	Input/Output 2
⊥	Trigger Common	INH Common	Signal Common

LAN Connector

Agilent N6700A mainframes use “mini-B USB connector.

Binding Post

Agilent N6700A mainframes use a longer, hex shaped chassis ground binding post on the rear panel.

Firmware Differences

The following features and capabilities are not available on mainframes with firmware revisions prior to B.00.00.

- The ability to group output channels together in parallel
- The ability to program a voltage slew rate.
- The ability to lock out the front panel from the front panel.
- The ability to password-secure the LAN and USB interface and the non-volatile RAM settings.
- The low range current measurement calibration is different.
- The “B” version modules are not recognized by the mainframe.

To upgrade your instrument with the latest firmware revision, go to <http://www.agilent.com/find/N6700>.

Front Panel Menu Commands for Firmware Revisions prior to B.00.00

Menu Command			Control Description	
Output	Voltage		Programs voltage setting and range.	
	Current		Programs current setting and range.	
	Delay		Program Turn-on /Turn Off delay.	
Measure	Range		Selects voltage and current measurement range.	
	Sweep		Specifies measurement points, time interval, and trigger offset.	
	Window		Selects measurement window (Rectangular/Hanning).	
	Control		Lets you abort a measurement in progress.	
Transient	Mode	Voltage	Selects voltage mode (Fixed, Step, or List).	
		Current	Selects current mode (Fixed, Step, or List).	
	Step		Programs voltage and current steps. Enables step trigger signals.	
	List	Pace	Specifies Dwell or Trigger paced list.	
		Repeat	Specifies number of list repetitions, or specifies continuous list.	
		Terminate	Specifies list settings when the list terminates.	
		Config	Configures the list steps. Specify voltage, current, and dwell values. Also specifies trigger output signal states.	
		Reset	Aborts the list and resets all list parameters.	
		TrigSource	Specify the trigger source: bus, tran 1-4, pin 1-3.	
		Control	Initiate, Trigger, or Abort output triggers.	
Protect	OVP		Configures over-voltage protections function.	
	OCP		Configures over-current protections function.	
	Inhibit		Configures the external inhibit signal.	
	Coupling		Disables ALL output channels when a protection fault occurs.	
	Clear		Clears output protection.	
States	Reset		Resets the instrument to its reset (*RST) state.	
	Save/Recall		Saves or recalls an instrument state.	
	PowerOn		Selects the power on state.	
System	Interface	LAN	Status	Displays interface status information.
			IP	Enables/disables DHCP and Auto IP Also sets the IP Address, Subnet Mask, and Default Gateway.
			DNS	Configures the DNS server.
			Name	Configures the Dynamic DNS and NetBIOS naming service.
			Domain	Configures the Domain Name.
			TCP	Configures the TCP keepalive function.
			Enable	Enables/disables the LAN interface and the built-in Web server.
	USB	Status	Displays status, speed, packets received, and packets sent.	
		Identification	USB connect string - the instrument's unique USB identifier	
		Enable	Enables/disables the USB interface.	
		GPIB	Selects the GPIB address.	
		Reset	Resets the interface settings to the factory-shipped state.	

Menu Command		Control Description	
System	DigPort	Pin 1	Function Specifies the pin function: DigIO, TrigIn, TrigOut, DigIn, or FaultOut.. Polarity Specifies the pin polarity.
		Pin 2	Function Specifies the pin function: DigIO, TrigIn, TrigOut, or DigIn. Polarity Specifies the pin polarity.
	Pin 3	Function Specifies the pin function: DigIO, TrigIn, TrigOut, DigIn, or InhibitIn. Polarity Specifies the pin polarity.	
	Data	Sends/reads data from the digital I/O port function	
Preferences	Display	Configures Screen saver, Wake-on I/O, and Display contrast.	
	Keys	Enables/disables key clicks and configures the On/Off key.	
	Security ResetNVRam	Resets all non-volatile RAM settings to their factory defaults.	
Error		Displays the Error log.	
Calibrate	State	Enables/disables calibration. You must supply a password to enable.	
	Sequence VProg	High	Enters measured data for high calibration point.
		Low	Enters measured data for low calibration point.
	VMeas	Enters measured data.	
	CMRR	Calibrates common mode rejection ratio.	
	IProg	High	Enters measured data for high calibration point.
		Low	Enters measured data for low calibration point.
	IMeas	Enters Measured data.	
	DPRog	Calibrates the downprogrammer.	
	IPeak	Calibrates I peak.	
Date	Saves the calibration date for each channel.		
Save	Saves the calibration data.		
Password	Changes the password.		
About	Frame	Displays model, serial number, firmware revision, backup revision, and active firmware.	
	Module	Displays model, serial number, options, voltage, current, and power.	

Low Range Current Measurement Calibration for Units with Firmware Revisions Prior to B.00.00

This only applies to Agilent Models N6761A and N6762A with Firmware revisions prior to B.00.00. Replace steps 25 through 30 of the previously documented procedure with the following steps.

- Step 25.** Remove all loads from the output and turn the output off. Wait a minimum of 3 minutes with the output off before proceeding.
- Step 26.** Select the low-current measurement range. The following example selects the 0.1 amp low-current measurement range of channel 1. The value to program a range must be the maximum current of the range.

Front Panel:	SCPI Command:
Select	CAL:CURR:MEAS 0.1, (@1)
System\Cal\Sequences\lmeas.	

- Step 27.** Steps 27 and 28 only apply to units with firmware revision A.01.04. If your unit has firmware revision A.01.03 or below, skip these steps and go to step 29. Wait a minimum of 4 minutes for the internal temperature to stabilize. Then select the first current calibration point.

Front Panel:	SCPI Command:
Select Next. The information field should indicate: Enter P1 data	CAL:LEV P1 *OPC?

- Step 28.** Re-connect the precision shunt resistor to the output and connect the DVM across the shunt. Select the second current calibration point.

Front Panel:	SCPI Command:
Select Next. The information field should indicate: Enter P2 data	CAL:LEV P2 *OPC?

- Step 29.** This step only applies to units with firmware revision A.01.03 or below. If your unit has firmware revision A.01.04, skip this step. Re-connect the precision shunt resistor to the output and connect the DVM across the shunt. Select the second current calibration point.

Front Panel:	SCPI Command:
Select Next. The information field should indicate: Enter P1 data	CAL:LEV P1 *OPC?

- Step 30.** Calculate the shunt current ($I=V/R$) and enter the data.

Front Panel:	SCPI Command:
Select the Measured Data field. Enter the data from the external DVM. Press Select when done. Press Next to finish calibration.	CAL:DATA <data>

Index

A	
ABOR	107
Admin menu, password	43
airflow	17, 19, 128
ALL	12, 47
Auto IP	39
B	
bench location	19
C	
calibration	151
current downprogrammer	156
current programming and measurement	155
enable	152
equipment	130
low range current measurement	156, 200
low range current programming	157
low range voltage	153
low range voltage measurement	154
mainframe	129, 182
password	81, 159
peak current limit	158
save and exit	159
switches	151, 173
voltage common mode rejection	154
voltage programming and measurement	152
calibration commands	80
CAL CURR	80
CAL CURR MEAS	80
CAL CURR PEAK	80
CAL DATA	80
CAL DATE	80
CAL DPR	80
CAL LEV	81
CAL PASS	81
CAL SAVE	81
CAL STAT	81
CAL VOLT	81
CAL VOLT CMRR	81
CAL VOLT MEAS	82
capacitor, external	22
Caution	3
CC	98
load effect	136
source effect	136
channel	
groups	25, 54
location	19
numbering	19
parameter	71
range	71
select	30, 46
cleaning	19
CME	101
command	
combining	69
completion	74
coupling	70
synchronization	74
common commands	75
*CLS	100
*ESE	101
*ESR?	101
*IDN?	105
*OPC	101
*OPT?	105
*RCL	105
*RDT?	106
*RST	106
*SAV	106
*SR	102
*STB?	102
*TRG	108
*TST	106
*WAI	102
combining	69
compatibility	
command summary	193
differences	192
models	191
connections	
multiple load	22
negative voltage	22
parallel	25
positive voltage	22
remote sensing	24
series	26
contrast, front panel	56
control port, connector	162, 197
control socket	42
conventions used in this guide	72
coupled commands	70

Index

CP-	99
CP+	99
current	
measurement range	52, 84
monitoring resistor	131
output range	90
programming accuracy	135
readback accuracy	135
returning current data	64
setting	31, 46
CV	98
load effect	132
noise	133
source effect	133

D

damage	17
data socket	42
DDE	101
default gateway	39
device clear	74
DHCP	38
differences in N6700A mainframes	197
digital I/O	
configuring	166
connections	163
digital input	
configuring	166
connections	163
digitizer	
programming	62
programming example	114
dimensions	128
disassembly	171
bulk supply	175
carrier/bias board	174
front panel	174
interface board	174
ribbon cables	171
display commands	82
DISP VIEW	82
DNS server	40
Domain name	40

E

electronic load	131
electrostatic discharge precautions	171
environmental conditions	17

ERR	33, 102
error messages	186
ESB	102
EXE	101
external trigger	
configuring	166
connections	164

F

fault output	
configuring	167
connections	164
features	8
fetch commands	52, 83
FETC ARR CURR?	83
FETC ARR VOLT?	83
FETC CURR?	84
FETC VOLT?	84
frequency, 400 Hz	20
front panel	
contrast	56
display	11
keys	12
lockout	55
menus	13, 198
screen saver	56
view	56
front panel menu	
exiting	33
using	32

G

GPIB address	34
GPIB interface	34
ground	
earth	17
redundant	20
redundant for 400 Hz	175
groups	
channel	54
view	11

H

Hanning	63
headers	71
help	32
history	2
Hostname	39

I	
inhibit input	
clearing.....	164
configuring.....	167
connections.....	164
initialization.....	182
initiate commands	
INIT NAME.....	107
inspection.....	17
installation.....	17
installing modules.....	172
instrument	
identification.....	53
storing states.....	53
IO.....	34
IP address.....	39
items supplied.....	16
L	
LAN interface.....	35
sockets.....	42
Telnet.....	42
LAN, parameters.....	38
LAN, private.....	37
LAN, site.....	36
list	
arbitrary.....	60
programming.....	57
programming example.....	112
load connections.....	20
lockout, front panel.....	55
M	
MAV.....	97, 102
measure commands.....	52, 83
MEAS ARR CURR?.....	83
MEAS ARR VOLT?.....	83
MEAS CURR?.....	84
MEAS VOLT?.....	84
measurement trigger	
generate.....	66
initiate.....	66
source.....	65
measurements	
arrays.....	64
converter.....	64
Hanning window.....	63
Rectangular window.....	63
sample interval.....	62
simultaneous V and I.....	52
message separator.....	72
message terminator	
end or identify.....	72
newline.....	72
model	
differences.....	9
numbers.....	16
MSS.....	96, 102
multiple load connections.....	22
multipliers.....	73
N	
non-volatile RAM settings.....	43
numeric data formats.....	73
O	
OC.....	99
OFF.....	98
OPC.....	101
OPER.....	102
operating checklist.....	170
operation status group.....	96
header.....	69
options.....	16
OT.....	99
outline diagram.....	17, 128
output	
enable.....	31, 47
groups.....	25, 54
noise.....	24
programming example.....	110
pulse.....	58
queue.....	97
turn-on delay.....	47
output commands.....	86
OUTP.....	86
OUTP DEL FALL.....	86
OUTP DEL RISE.....	87
OUTP INH MODE.....	87
OUTP PON STAT.....	88
OUTP PROT CLE.....	88
OUTP PROT COUP.....	88
OUTP PROT DEL.....	88
output step.....	49
output trigger	
enable.....	49

Index

generate	51
initiate	50
level	49
source	50
outputs in parallel	25
outputs in series	27
OV	99
overall troubleshooting	177
over-current protection	48
over-voltage protection	48
over-voltage setting	32

P

parallel outputs	54
password	43
calibration	151
front panel	55
PF	99
PON	101
power cord, connecting	19
power factor 400 Hz	20
power receptacle	17
pre-trigger data	62
print date	2
PROT	99
protection, clearing	48
pulse	58

Q

QUE	101
query	
description	69
indicator	71
QUES	102
questionable status group	96

R

rack mounting	18
Rectangular	63
remote interface	
factory settings	43
securing	43
remote sensing	23
removing modules	172
repackaging	170
replaceable parts list	183
replaceable parts location	184, 185
reset states	79

response data types	73
returning units	170
root specifier	72
RQS	96, 102

S

safety	3
class	17
warning	17
sample interval	62
SCPI	
command completion	74
common commands	79
device clear	74
header path	68
message structure	70
message unit	71
multiple commands	68
program message	70
response message	70
subsystem commands	76
screen saver	56
self-test	53
sense commands	
SENS CURR RANG	84
SENS FUNC	84
SENS SWE OFFS POIN	84
SENS SWE POIN	85
SENS SWE TINT	85
SENS VOLT RANG	85
SENS WIND	85
sense leads, open	24
sockets	42
source commands	89
[SOUR] CURR [IMM]	89
[SOUR] CURR MODE	89
[SOUR] CURR PROT STAT	89
[SOUR] CURR RANG	90
[SOUR] CURR TRIG	89
[SOUR] DIG INP?	90
[SOUR] DIG OUTP	90
[SOUR] DIG PIN<n> FUNC	91
[SOUR] DIG PIN<n> POL	91
[SOUR] LIST COUN	92
[SOUR] LIST CURR	92
[SOUR] LIST DWEL	92
[SOUR] LIST STEP	93
[SOUR] LIST TERM LAST	93
[SOUR] LIST TOUT BOST	93

- [SOUR] LIST TOUT EOST 93
- [SOUR] LIST VOLT 93
- [SOUR] STEP TOUT 94
- [SOUR] VOLT [IMM] 94
- [SOUR] VOLT MODE 94
- [SOUR] VOLT PROT [LEV] 94
- [SOUR] VOLT RANG 95
- [SOUR] VOLT SLEW [IMM] 95
- [SOUR] VOLT TRIG 94
- specifications
 - characteristics 121
 - performance 118
- SRQ 33
- standard event status group 96
- status byte 96
- status commands 96
 - STAT OPER COND? 98
 - STAT OPER ENAB 98
 - STAT OPER NTR 99
 - STAT OPER PTR 99
 - STAT OPER? 98
 - STAT PRES 98
 - STAT QUES COND? 99
 - STAT QUES ENAB 100
 - STAT QUES NTR 100
 - STAT QUES PTR 100
 - STAT QUES? 99
- step programming 49
- storing states 53
- subnet mask 39
- subsystem commands 75
- suffixes 73
- support rails 18
- synchronizing measurements 64
- system commands 103
 - SYST CHAN MOD? 103
 - SYST CHAN OPT? 103
 - SYST CHAN SER? 103
 - SYST COMM RLST 103
 - SYST COMM TCP CONT 103
 - SYST ERR? 104
 - SYST GRO CAT? 104
 - SYST GRO DEF 104
 - SYST GRO DEL 104
 - SYST GRO DEL ALL 104
 - SYST PASS FPAN RES 105
 - SYST REB 105
 - SYST VERS? 105

- system protection
 - clearing 165
 - connections 165

T

- TCP keepalive 40
- Telnet 42
- test extensions 57, 62, 64
- transient recovery time 134
- transient trigger 51
- trigger commands 107
 - TRIG 108
 - TRIG [TRAN] SOUR 108
 - TRIG ACQ 107
 - TRIG ACQ SOUR 108
- troubleshooting
 - backplane board 182
 - carrier/bias board 180
 - flowchart 177
 - front panel 180
- turn-on delay 47
- types of SCPI commands 68

U

- ungroup 54
- UNR 99
- USB interface 35

V

- verification 130
 - equipment 130
 - procedure 132, 135
- voltage
 - measurement range 52, 85
 - output range 95
 - programming accuracy 132
 - readback accuracy 132
 - returning voltage data 64
 - setting 30, 46
 - slew rate 46

W

- Warning 3
- Web server 41
- Web URL's 4
- wire sizes 21
- WTG-meas 98
- WTG-tran 98



Agilent Technologies

DECLARATION OF CONFORMITY
According to ISO/IEC Guide 22 and CEN/CENELEC EN 45014



	Responsible Party	Alternate Manufacturing Site
Manufacturer's Name:	Agilent Technologies, Inc.	Agilent Technologies (Malaysia) Sdn. Bhd
Manufacturer's Address:	550 Clark Drive, Suite 101 Budd Lake, New Jersey 07828 USA	Malaysia Manufacturing Bayan Lepas Free Industrial Zone, PH III 11900 Penang, Malaysia

Declares under sole responsibility that the product as originally delivered

Product Name: Modular Power System

Model Numbers: N6700A, N6700B, N6710B, N6731B, N6732B, N6733B, N6734B, N6735B, N6736B, N6731A, N6732A, N6733A, N6734A, N6735A, N6741B, N6742B, N6743B, N6744B, N6745B, N6746B, N6742A, N6743A, N6744A, N6745A, N6751A, N6752A, N6761A, N6762A

Product Options: This declaration covers all options of the above product(s)

complies with the essential requirements of the following applicable European Directives, and carries the CE marking accordingly:

- Low Voltage Directive (73/23/EEC, amended by 93/68/EEC)
- EMC Directive (89/336/EEC, amended by 93/68/EEC)

and conforms with the following product standards:

EMC	Standard	Limit
	IEC 61326 :1997+A1 :1998+A2 :2000 EN 61326 :1997+A1 :1998+A2 :2001	
	CISPR 11:1997 / EN 55011:1998	Group 1 Class A
	IEC/EN 61000-4-2:1995+A1:1998 +A2:2001	4 kV CD, 8 kV AD
	IEC/EN 61000-4-3:2002	3 V/m, 80-1000 MHz, 80% AM
	IEC 61000-4-4:1995+A1 :2000 / EN 61000-4-4:1995+A1 :2001	0.5 kV signal lines, 1 kV power lines
	IEC 61000-4-5:1995+A1 :2000 / EN 61000-4-5:1995+A1 :2001	0.5 kV differential, 1 kV common mode
	IEC 61000-4-6:1996+A1 :2000 / EN 61000-4-6:1996+A1 :2001	3 Vrms, 0.15-80 MHz, 80% AM
	IEC 61000-4-11:1994+A1 :2000 / EN 61000-4-11:1994+A1 :2001	100%/20 ms
	Canada: ICES-001:1998	
	Australia/New Zealand: AS/NZS 2064.1	

The product was tested in a typical configuration with Agilent Technologies test systems.

Safety IEC 61010-1:2001 / EN 61010-1:2001
Canada: CSA C22.2 No. 1010.1:1992
UL 61010B-1: 2003

This DoC applies to above-listed products placed on the EU market after:

January 1, 2004

Date

Bill Darcy
Product regulations manager

For further information, please contact your local Agilent Technologies sales office, agent or distributor, or Agilent Technologies Deutschland GmbH, Herrenberger Straße 130, D 71034 Böblingen, Germany.