

Keysight  
N5171B/72B/73B EXG  
N5181B/82B/83B MXG  
X-Series Signal Generators

# Notices

© Keysight Technologies, Inc.  
2012-2019

No part of this manual may be reproduced in any form or by any means (including electronic storage and retrieval or translation into a foreign language) without prior agreement and written consent from Keysight Technologies, Inc. as governed by United States and international copyright laws.

## Trademark Acknowledgments

## Manual Part Number

N5180-90056

## Edition

Edition 1, February 2019

Supersedes: August 2018

Printed in USA/Malaysia

Published by:  
Keysight Technologies  
1400 Fountaingrove Parkway  
Santa Rosa, CA 95403

## Warranty

THE MATERIAL CONTAINED IN THIS DOCUMENT IS PROVIDED "AS IS," AND IS SUBJECT TO BEING CHANGED, WITHOUT NOTICE, IN FUTURE EDITIONS. FURTHER, TO THE MAXIMUM EXTENT PERMITTED BY APPLICABLE LAW, KEYSIGHT DISCLAIMS ALL WARRANTIES, EITHER EXPRESS OR IMPLIED WITH REGARD TO THIS MANUAL AND ANY INFORMATION CONTAINED HEREIN, INCLUDING BUT NOT LIMITED TO THE IMPLIED WARRANTIES OF MERCHANTABILITY AND FITNESS FOR A PARTICULAR PURPOSE. KEYSIGHT SHALL NOT BE LIABLE FOR ERRORS OR FOR INCIDENTAL OR CONSEQUENTIAL DAMAGES IN CONNECTION WITH THE FURNISHING, USE, OR PERFORMANCE OF THIS DOCUMENT OR ANY INFORMATION CONTAINED HEREIN. SHOULD KEYSIGHT AND THE USER HAVE A SEPARATE WRITTEN AGREEMENT WITH WARRANTY TERMS

COVERING THE MATERIAL IN THIS DOCUMENT THAT CONFLICT WITH THESE TERMS, THE WARRANTY TERMS IN THE SEPARATE AGREEMENT WILL CONTROL.

## Technology Licenses

The hardware and/or software described in this document are furnished under a license and may be used or copied only in accordance with the terms of such license.

## U.S. Government Rights

The Software is "commercial computer software," as defined by Federal Acquisition Regulation ("FAR") 2.101. Pursuant to FAR 12.212 and 27.405-3 and Department of Defense FAR Supplement ("DFARS") 227.7202, the U.S. government acquires commercial computer software under the same terms by which the software is customarily provided to the public.

Accordingly, Keysight provides the Software to U.S. government customers under its standard commercial license, which is embodied in its End User License Agreement (EULA), a copy of which can be found at

<http://www.keysight.com/find/sweula>

The license set forth in the EULA represents the exclusive authority by which the U.S. government may use, modify, distribute, or disclose the Software. The EULA and the license set forth therein, does not require or permit, among other things, that Keysight: (1) Furnish technical information related to commercial computer software or commercial computer software documentation that is not customarily provided to the public; or (2) Relinquish to, or otherwise provide, the government rights in excess of these rights customarily provided to the public to use, modify, reproduce, release, perform, display, or disclose commercial computer software or commercial computer software

documentation. No additional government requirements beyond those set forth in the EULA shall apply, except to the extent that those terms, rights, or licenses are explicitly required from all providers of commercial computer software pursuant to the FAR and the DFARS and are set forth specifically in writing elsewhere in the EULA. Keysight shall be under no obligation to update, revise or otherwise modify the Software. With respect to any technical data as defined by FAR 2.101, pursuant to FAR 12.211 and 27.404.2 and DFARS 227.7102, the U.S. government acquires no greater than Limited Rights as defined in FAR 27.401 or DFAR 227.7103-5 (c), as applicable in any technical data.

## Safety Notices

### CAUTION

A **CAUTION** notice denotes a hazard. It calls attention to an operating procedure, practice, or the like that, if not correctly performed or adhered to, could result in damage to the product or loss of important data. Do not proceed beyond a CAUTION notice until the indicated conditions are fully understood and met.

### WARNING

A **WARNING** notice denotes a hazard. It calls attention to an operating procedure, practice, or the like that, if not correctly performed or adhered to, could result in personal injury or death. Do not proceed beyond a WARNING notice until the indicated conditions are fully understood and met.

## Where to Find the Latest Information

Documentation is updated periodically. For the latest information about these products, including instrument software upgrades, application information, and product information, browse to one of the following URLs, according to the name of your product:

[http://www.keysight.com/find/X-Series\\_SG](http://www.keysight.com/find/X-Series_SG)

To receive the latest updates by email, subscribe to Keysight Email Updates at the following URL:

<http://www.keysight.com/find/MyKeysight>

Information on preventing instrument damage can be found at:

[www.keysight.com/find/PreventingInstrumentRepair](http://www.keysight.com/find/PreventingInstrumentRepair)

## Is your product software up-to-date?

Periodically, Keysight releases software updates to fix known defects and incorporate product enhancements. To search for software updates for your product, go to the Keysight Technical Support website at:

<http://www.keysight.com/find/techsupport>



Table of Contents

1. Signal Generator Overview

Signal Generator Features .....	18
Modes of Operation .....	19
Continuous Wave .....	19
Swept Signal .....	19
Analog Modulation .....	19
Digital Modulation (Vector Models with Option 65x Only) .....	20
Front Panel Overview .....	21
1. Host USB .....	21
2. Display .....	21
3. Softkeys .....	21
4. Numeric Keypad .....	21
5. Arrows and Select .....	22
6. Page Up .....	22
7. MENUS .....	22
8. Trigger .....	22
9. Local Cancel/(Esc) .....	22
10. Help .....	22
11. Preset and User Preset .....	23
12. RF Output (N5171B, N5172B, N5181B, N5182B) .....	23
12. RF Output (N5173B, N5183B) .....	23
13. RF On/Off and LED .....	23
14. Mod On/Off and LED .....	23
15. Page Down .....	23
16. I Input (vector models only) .....	23
17. Q Input (vector models only) .....	24
18. Knob .....	24
19. Incr Set .....	24
20. Return .....	24
21. More and LED .....	24
22. Power Switch and LEDs .....	24
Front Panel Display .....	25
1. Active Function Area .....	25
2. Frequency Area .....	25
3. Annunciators .....	25
4. Amplitude Area .....	26
5. Error Message Area .....	26
6. Text Area .....	27
7. Softkey Label Area .....	27
Rear Panel Overview (N5171B, N5172B, N5181B, & N5182B) .....	28
1. AC Power Receptacle .....	28
2. EXT 1 & EXT 2 .....	29
3. LF OUT .....	29
4. SWEEP OUT .....	29
5. PULSE .....	29

## Contents

6. TRIG 1 & 2	29
7. REF IN	29
8. 10 MHz OUT	30
9. GPIB	30
10. LAN	30
11. Device USB	30
12. Host USB	30
13. SD Card	30
Digital Modulation Connectors (Vector Models Only)	31
I OUT, Q OUT, OUT, OUT	31
BB TRIG 1 & BB TRIG 2	31
EVENT 1	31
PAT TRIG	32
DIGITAL BUS I/O	32
AUX I/O Connector	33
Rear Panel Overview (N5173B & N5183B)	37
1. AC Power Receptacle	37
2. EXT 1 & EXT 2	38
3. LF OUT	38
4. SWEEP OUT	38
5. PULSE	38
6. TRIG 1 & 2	38
7. REF IN	38
8. 10 MHz OUT	39
9. GPIB	39
10. LAN	39
11. Device USB	39
12. Host USB	39
13. SD Card	39
14. ALC INPUT	39
15. Z AXIS OUTPUT	40
<b>2. Preferences &amp; Enabling Options</b>	
User Preferences	42
Display Settings	43
Power On and Preset	44
Front Panel Knob Resolution	44
Setting Time and Date	45
Reference Oscillator Tune	46
Upgrading Firmware	47
Remote Operation Preferences	47
GPIB Address and Remote Language	47
Configuring the LAN Interface	48
Enabling LAN Services: "Browser," "Sockets," and "VXI-11"	48
Configuring the Remote Languages	49
Configuring the Preset Languages	51
Enabling an Option	53
Viewing Options and Licenses	54

Hardware Assembly Installation and Removal Softkeys . . . . .	55
<b>3. Basic Operation</b>	
Presetting the Signal Generator . . . . .	58
Viewing Key Descriptions . . . . .	58
Entering and Editing Numbers and Text . . . . .	59
Entering Numbers and Moving the Cursor . . . . .	59
Entering Alpha Characters . . . . .	59
Example: Using a Table Editor . . . . .	60
Setting Frequency and Power (Amplitude) . . . . .	61
Example: Configuring a 700 MHz, -20 dBm Continuous Wave Output . . . . .	62
Using an External Reference Oscillator . . . . .	62
Setting ALC Bandwidth Control . . . . .	63
Configuring a Swept Output . . . . .	64
Routing Signals . . . . .	65
Step Sweep . . . . .	65
List Sweep . . . . .	67
Example: Using a Single Sweep . . . . .	70
Example: Manual Control of Sweep . . . . .	71
Modulating the Carrier Signal . . . . .	72
Example . . . . .	72
Simultaneous Modulation . . . . .	73
Working with Files . . . . .	74
File Softkeys . . . . .	75
Viewing a List of Stored Files . . . . .	76
Storing a File . . . . .	78
Loading (Recalling) a Stored File . . . . .	79
Moving a File from One Media to Another . . . . .	80
Working with Instrument State Files . . . . .	80
Selecting the Default Storage Media . . . . .	85
Reading Error Messages . . . . .	86
Error Message Format . . . . .	86
<b>4. Optimize Performance</b>	
Using the Dual Power Meter Display . . . . .	88
Example: Dual Power Meter Calibration . . . . .	89
Using the USB Pass Through Commands . . . . .	95
Procedure . . . . .	95
Using the Power Meter Servo . . . . .	97
Power Meter Servo Configuration . . . . .	98
Example . . . . .	99
Using Flatness Correction . . . . .	100
Creating a User Flatness Correction Array . . . . .	102
Recalling and Applying a User Flatness Correction Array . . . . .	108
Using Internal Channel Correction (N5172B/82B Only) . . . . .	109
Configure Internal Channel Correction . . . . .	112

## Contents

Perform Enhanced Factory Calibration. . . . .	112
Using External Leveling (N5173B/83B Only) . . . . .	113
Option 1E1 Output Attenuator Behavior and Use . . . . .	116
Configure External Leveling . . . . .	116
Using Unleveled Operating Modes. . . . .	120
ALC Off Mode . . . . .	120
Power Search Mode . . . . .	121
Using an Output Offset, Reference, or Multiplier. . . . .	124
Setting an Output Offset . . . . .	124
Setting an Output Reference . . . . .	125
Setting a Frequency Multiplier . . . . .	126
Using the Frequency and Phase Reference Softkeys. . . . .	127
Using Free Run, Step Dwell, and Timer Trigger. . . . .	128
Understanding Free Run, Step Dwell, and Timer Trigger Setup . . . . .	128
Using a USB Keyboard . . . . .	130
<b>5. Avionics VOR/ILS (Option N5180302B)</b>	
Using VOR [VHF Omnidirectional Range] Softkeys . . . . .	132
To set the VOR mode that produces a full or partial VOR signal . . . . .	134
To set the VOR carrier frequency . . . . .	134
To set the VOR bearing angle between the VAR signal and the REF signal . . . . .	136
To set the VOR bearing direction as From or To. . . . .	137
To set the frequency of the reference signal (REF Freq) and the variable phase signal (VAR Freq) . . . . .	137
To set the amount of FM deviation that the 30 Hz reference signal (REF Freq) applies on the sub-carrier. . . . .	137
To set the AM depth of the variable phase signal (VAR Freq) . . . . .	138
To set the frequency of the sub-carrier signal (SubCarrier Freq). . . . .	138
To set the sub-carrier AM depth that modulates the VOR carrier. . . . .	138
To set or return the VOR subsystem parameters to a default state. . . . .	139
Example of Setting All VOR Parameters. . . . .	139
Using COM/ID Softkeys . . . . .	142
To set the COM/ID on or off . . . . .	143
To set the COM/ID type between Code or Tone. . . . .	143
To set the COM/ID 3-character code (airport identification code) . . . . .	143
To set the COM/ID tone/code modulating frequency . . . . .	144
To set the COM/ID tone AM depth. . . . .	144
To set or return the COM/ID parameters to a default state. . . . .	145
Example of Setting All COM/ID Parameters. . . . .	145
Using ILS Localizer Softkeys. . . . .	147
To set the ILS Localizer mode to produce a full or partial signal. . . . .	149
To set the ILS Localizer carrier frequency. . . . .	150
To set the ILS Localizer left frequency . . . . .	151
To set the ILS Localizer right frequency . . . . .	151
To set the ILS Localizer phase of the right signal relative to the left. . . . .	152
To set the ILS Localizer DDM polarity to fly left or fly right. . . . .	152
To set the ILS Localizer DDM value . . . . .	154
To set the ILS Localizer DDM value in micro-amps ( $\mu$ A) . . . . .	154
To set the ILS Localizer DDM value as a percentage (%). . . . .	155



To set the ILS Localizer SDM value . . . . .	155
To set or return the ILS Localizer parameters to a default state . . . . .	156
Example of Setting All ILS Localizer Parameters . . . . .	157
Using ILS Glide Slope Softkeys . . . . .	159
To set the ILS Glide Slope mode to produce a full or partial signal . . . . .	162
To set the ILS Glide Slope carrier frequency . . . . .	162
To set the ILS Glide Slope up frequency . . . . .	163
To set the ILS Glide Slope down frequency . . . . .	163
To set the ILS Glide Slope phase of the down signal relative to the up . . . . .	164
To set the ILS Glide Slope DDM polarity to fly up or fly down . . . . .	164
To set the ILS Glide Slope DDM value . . . . .	166
To set the ILS Glide Slope DDM value in micro-amps ( $\mu\text{A}$ ) . . . . .	166
To set the ILS Glide Slope DDM value in percentage (%) . . . . .	167
To set the ILS Glide Slope SDM value . . . . .	167
To set or return the ILS Glide Slope parameters to a default state . . . . .	168
Example of Setting All ILS Glide Slope Parameters . . . . .	169
Using ILS Marker Beacon Softkeys . . . . .	171
To set the ILS Marker Beacon mode to off, inner, middle, or outer . . . . .	172
To set the ILS Marker Beacon carrier frequency . . . . .	172
To set the ILS Marker Beacon AM depth . . . . .	173
To set the ILS Marker Beacon inner marker frequency . . . . .	173
To set the ILS Marker Beacon middle marker frequency . . . . .	174
To set the ILS Marker Beacon outer marker frequency . . . . .	174
To set or return the ILS Marker Beacon parameters to a default state . . . . .	174
Example of Setting All ILS Marker Beacon Parameters . . . . .	175
<b>6. Analog Modulation (Option UNT)</b>	
Analog Modulation Waveforms . . . . .	178
Analog Modulation Sources . . . . .	178
Using an Internal Modulation Source . . . . .	180
Using an External Modulation Source . . . . .	181
Removing an External Source DC Offset . . . . .	181
Using Wideband AM . . . . .	182
Configuring the LF Output (Option 303) . . . . .	183
LF Out Modulation Sources . . . . .	183
Configuring the LF Output with an Internal Modulation Source . . . . .	184
Configuring the LF Output with a Function Generator Source . . . . .	185
<b>7. Pulse Modulation (Options UNW and N5180320B)</b>	
Pulse Characteristics . . . . .	189
The Basic Procedure . . . . .	191
Example . . . . .	192
Pulse Train (Options UNW and N5180320B) . . . . .	193
<b>8. Basic Digital Operation—No BBG Option Installed</b>	
I/Q Modulation . . . . .	200

## Contents

Configuring the Front Panel Inputs . . . . .	201
<b>9. Basic Digital Operation (Option 653/655/656/657)</b>	
Waveform File Basics . . . . .	205
Signal Generator Memory . . . . .	205
Dual ARB Player . . . . .	205
Storing, Loading, and Playing a Waveform Segment . . . . .	207
Loading a Waveform Segment into BBG Media . . . . .	207
Storing/Renaming a Waveform Segment to Internal or USB Media . . . . .	208
Playing a Waveform Segment . . . . .	208
Waveform Sequences . . . . .	210
Creating a Sequence . . . . .	210
Viewing the Contents of a Sequence . . . . .	212
Editing a Sequence . . . . .	212
Playing a Sequence . . . . .	213
Saving a Waveform's Settings & Parameters . . . . .	215
Viewing and Modifying Header Information . . . . .	217
Viewing & Editing a Header without Selecting the Waveform . . . . .	219
Using Waveform Markers . . . . .	221
Waveform Marker Concepts . . . . .	222
Accessing Marker Utilities . . . . .	226
Viewing Waveform Segment Markers . . . . .	227
Clearing Marker Points from a Waveform Segment . . . . .	227
Setting Marker Points in a Waveform Segment . . . . .	228
Viewing a Marker Pulse . . . . .	230
Using the RF Blanking Marker Function . . . . .	232
Setting Marker Polarity . . . . .	233
Controlling Markers in a Waveform Sequence . . . . .	233
Using the EVENT Output Signal as an Instrument Trigger . . . . .	236
Triggering a Waveform . . . . .	237
Trigger Type . . . . .	238
Trigger Source . . . . .	239
Example: Segment Advance Triggering . . . . .	240
Example: Gated Triggering . . . . .	241
Example: External Triggering . . . . .	243
Clipping a Waveform . . . . .	244
How Power Peaks Develop . . . . .	245
How Peaks Cause Spectral Regrowth . . . . .	247
How Clipping Reduces Peak-to-Average Power . . . . .	248
Configuring Circular Clipping . . . . .	251
Configuring Rectangular Clipping . . . . .	252
Scaling a Waveform . . . . .	253
How DAC Over-Range Errors Occur . . . . .	254
How Scaling Eliminates DAC Over-Range Errors . . . . .	255
Setting Waveform Runtime Scaling . . . . .	256
Setting Waveform Scaling . . . . .	257
Setting the Baseband Frequency Offset . . . . .	259

DAC Over-Range Conditions and Scaling ..... 261

I/Q Modulation ..... 263

    Using the Rear Panel I and Q Outputs ..... 265

    Configuring the Front Panel Inputs ..... 266

I/Q Adjustments ..... 267

I/Q Calibration ..... 268

Using the Equalization Filter ..... 270

Using Finite Impulse Response (FIR) Filters in the Dual ARB Real-Time Modulation Filter ..... 272

    Creating a User-Defined FIR Filter Using the FIR Table Editor ..... 273

Modifying a FIR Filter Using the FIR Table Editor ..... 278

    Loading the Default Gaussian FIR File ..... 278

    Modifying the Coefficients ..... 279

    Storing the Filter to Memory ..... 280

Setting the Real-Time Modulation Filter ..... 281

Multiple Baseband Generator Synchronization ..... 283

    Understanding the Master/Slave System ..... 284

    Equipment Setup ..... 286

    Configuring the Setup ..... 286

    Making Changes to the Multiple Synchronization Setup  
    and Resynchronizing the Master/Slave System ..... 288

Understanding Option 012 (LO In/Out for Phase Coherency)  
with Multiple Baseband Generator Synchronization ..... 289

    Configuring the Option 012 (LO In/Out for Phase Coherency) with MIMO ..... 289

Real-Time Applications ..... 293

Waveform Licensing ..... 294

    Understanding Waveform Licensing ..... 294

    Installing an Option N5182-22x or Option N5182B-25x ..... 294

    Licensing a Signal Generator Waveform ..... 294

**10. Digital Signal Interface Module (Option 003/004)**

Clock Timing ..... 304

    Clock and Sample Rates ..... 304

    Clock Source ..... 306

    Common Frequency Reference ..... 307

    Clock Timing for Parallel Data ..... 309

    Clock Timing for Parallel Interleaved Data ..... 311

    Clock Timing for Serial Data ..... 312

    Clock Timing for Phase and Skew Adjustments ..... 313

Connecting the Clock Source and the Device Under Test ..... 315

Data Types ..... 317

    Output Mode ..... 317

    Input Mode ..... 317

Operating the N5102A Module in Output Mode ..... 318

    Setting up the Signal Generator Baseband Data ..... 318

    Accessing the N5102A Module User Interface ..... 318

    Choosing the Logic Type and Port Configuration ..... 319

## Contents

Selecting the Output Direction . . . . .	320
Selecting the Data Parameters . . . . .	320
Configuring the Clock Signal . . . . .	323
Generating Digital Data . . . . .	327
Operating the N5102A Module in Input Mode . . . . .	328
Accessing the N5102A Module User Interface . . . . .	328
Selecting the Input Direction . . . . .	329
Choosing the Logic Type and Port Configuration . . . . .	329
Configuring the Clock Signal . . . . .	330
Selecting the Data Parameters . . . . .	334
Digital Data . . . . .	336
<b>11. Baseband Operating Mode—Primary, BERT, or N5102A</b>	
To set the Baseband Operating Mode to BERT . . . . .	338
To set the Baseband Operating Mode to N5102A . . . . .	339
To set the Baseband Operating Mode to Primary . . . . .	340
<b>12. BERT (Option N5180UN7B)</b>	
Bit Error Rate Tester—Option N5180UN7B . . . . .	342
Block Diagram . . . . .	342
Clock Gate Function . . . . .	342
Clock/Gate Delay Function . . . . .	343
Clock Delay Function . . . . .	345
Gate Delay Function in the Clock Mode . . . . .	346
Triggering . . . . .	347
Data Processing . . . . .	349
Repeat Measurements . . . . .	350
Testing Signal Definitions . . . . .	351
Verifying BERT Operation . . . . .	352
Measurement Setup Using Self-Test Mode . . . . .	354
Measurement Example Using Custom Digital Modulation (Requires Option N5180431B) . . . . .	356
<b>13. Real-Time Noise—AWGN (Option N5180403B)</b>	
Adding Real-Time Noise to a Dual ARB Waveform . . . . .	360
Eb/No Adjustment Softkeys for Real Time I/Q Baseband AWGN . . . . .	363
Using Real Time I/Q Baseband AWGN . . . . .	366
<b>14. Real-Time Phase Noise Impairments (Option N5180432B)</b>	
Real-Time Phase Noise Impairment . . . . .	368
Phase Noise Shape and Additive Phase Noise Impairments . . . . .	369
Understanding the Phase Noise Adjustments . . . . .	371
DAC Over-Range Conditions and Scaling . . . . .	372
<b>15. Real-Time Fading (Option 660)</b>	
Using Real-Time Fading Softkeys . . . . .	374
To configure a Real-Time Fading simulation . . . . .	375

**16. Custom Digital Modulation (Option N5180431B)**

Custom Modulation . . . . . 378

    ARB Custom Modulation Waveform Generator . . . . . 378

    Real-Time Custom Modulation Waveform Generator . . . . . 378

Creating and Using Bit Files . . . . . 386

    Creating a User File . . . . . 387

    Renaming and Saving a User File . . . . . 388

    Recalling a User File . . . . . 389

    Modifying an Existing User File . . . . . 389

    Applying Bit Errors to a User File . . . . . 390

Using Customized Burst Shape Curves . . . . . 391

    Understanding Burst Shape . . . . . 391

    Creating a User-Defined Burst Shape Curve . . . . . 393

    Storing a User-Defined Burst Shape Curve . . . . . 395

    Recalling a User-Defined Burst Shape Curve . . . . . 395

Using the Arbitrary Waveform Generator . . . . . 397

    Using Predefined Custom Digital Modulation . . . . . 397

    Creating a Custom Digital Modulation State . . . . . 398

    Storing a Custom Digital Modulation State . . . . . 400

    Recalling a Custom Digital Modulation State . . . . . 401

    Defining a Modulation . . . . . 402

    Creating a Custom Multicarrier Digital Modulation State . . . . . 409

    Storing a Custom Multicarrier Digital Modulation State . . . . . 411

    Applying Changes to an Active Multicarrier Digital Modulation State . . . . . 411

Using Finite Impulse Response (FIR) Filters with Custom Modulation . . . . . 412

    Understanding FIR Filters . . . . . 412

    Creating a User-Defined FIR Filter Using the FIR Table Editor . . . . . 414

Modifying a FIR Filter Using the FIR Table Editor . . . . . 419

    Loading the Default Gaussian FIR File . . . . . 419

    Modifying the Coefficients . . . . . 420

    Storing the Filter to Memory . . . . . 421

Differential Encoding . . . . . 422

    Using Differential Encoding . . . . . 425

**17. Multitone and Two-Tone Waveforms (Option N5180430B)**

Creating a Custom Two-Tone Waveform . . . . . 430

Creating a Custom Multitone Waveform . . . . . 430

Using Two-Tone Modulation . . . . . 431

    Two-Tone Modulation Softkeys . . . . . 431

    Creating a Two-Tone Waveform . . . . . 432

    Viewing a Two-Tone Waveform . . . . . 432

    Minimizing Carrier Feedthrough . . . . . 433

    Changing the Alignment of a Two-Tone Waveform . . . . . 434

Using Multitone Modulation . . . . . 436

    Multitone Modulation Softkeys . . . . . 436

    Initializing the Multitone Setup Table Editor . . . . . 436

    Configuring Tone Powers and Tone Phases . . . . . 437

## Contents

Removing a Tone . . . . .	437
Generating the Waveform . . . . .	437
Configuring the RF Output . . . . .	437
Applying Changes to an Active Multitone Signal . . . . .	438
<b>18. Troubleshooting</b>	
Display . . . . .	442
The Display is Too Dark to Read . . . . .	442
The Display Turns Black when Using USB Media . . . . .	442
Signal Generator Lock-Up . . . . .	442
RF Output . . . . .	443
No RF Output . . . . .	443
Power Supply Shuts Down . . . . .	443
No Modulation at the RF Output . . . . .	443
RF Output Power too Low . . . . .	443
Distortion . . . . .	443
Signal Loss While Working with a Spectrum Analyzer . . . . .	444
Signal Loss While Working with a Mixer . . . . .	445
Sweep . . . . .	447
Cannot Turn Off Sweep . . . . .	447
Sweep Appears Stalled . . . . .	447
Incorrect List Sweep Dwell Time . . . . .	447
List Sweep Information is Missing from a Recalled Register . . . . .	447
Amplitude Does Not Change in List or Step Sweep . . . . .	448
Internal Media Data Storage . . . . .	448
Instrument State Saved but the Register is Empty or Contains the Wrong State . . . . .	448
USB Media Data Storage . . . . .	448
Instrument Recognizes USB Media Connection, but Does Not Display Files . . . . .	448
Preset . . . . .	448
The Signal Generator Does Not Respond . . . . .	448
Pressing Preset Performs a User Preset . . . . .	448
Error Messages . . . . .	449
Error Message Types . . . . .	449
Front Panel Tests . . . . .	450
Self Test Overview . . . . .	450
Licenses . . . . .	452
A Time-Based License Quits Working . . . . .	452
Cannot Load a Time-Based License . . . . .	452
Contacting Keysight Technologies . . . . .	453
Returning a Signal Generator to Keysight . . . . .	453
<b>19. Working in a Secure Environment</b>	
How to Obtain the Security Features Document . . . . .	455
Using Secure Display (Option 006) . . . . .	456
Using Restricted Display . . . . .	457

## Documentation Overview

- Getting Started Guide**
  - Safety Information
  - Receiving the Instrument
  - Environmental & Electrical Requirements
  - Basic Setup
  - Accessories
  - Operation Verification
  - Regulatory Information
  
- User's Guide**
  - Signal Generator Overview
  - Preferences & Enabling Options
  - Basic Operation
  - Optimize Performance
  - Avionics VOR/ILS (Option N5180302B)
  - Analog Modulation (Option UNT)
  - Pulse Modulation (Options UNW or N5180320B)
  - Basic Digital Operation—No BBG Option
  - Basic Digital Operation (Options 653/655/656/657)
  - Digital Signal Interface Module (Option 003 /004)
  - Baseband Operating Mode—Primary, BERT, or N5102A
  - BERT (Option N5180UN7B)
  - Real-Time Noise—AWGN (Option N5180403B)
  - Real-Time Phase Noise Impairments (Option N5180432B)
  - Real-Time Fading (Option 660)
  - Custom Digital Modulation (Option N5180431B)
  - Multitone and Two-Tone Waveforms (Option N5180430B)
  - Troubleshooting
  - Working in a Secure Environment
  
- Programming Guide**
  - Getting Started with Remote Operation
  - Using IO Interfaces
  - Programming Examples
  - Programming the Status Register System
  - Creating and Downloading Files
  - Creating and Downloading User-Data Files
  
- SCPI Reference**
  - SCPI Basics
  - Basic Function Commands
  - System Commands
  - Analog Modulation Commands
  - Arb Commands
  - Avionics VOR/ILS Commands
  - Bit Error Rate Test (BERT) Commands
  - Digital Signal Interface Module Commands
  - Real-Time Commands

<b>Programming Compatibility Guide</b>	–	Provides a listing of SCPI commands and programming codes for signal generator models that are supported by the Keysight EXG and MXG X- Series signal generators.
<b>Service Guide</b>	–	Troubleshooting
	–	Replaceable Parts
	–	Assembly Replacement
	–	Post-Repair Procedures
	–	Safety and Regulatory Information
	–	Instrument History
<b>Key Help<sup>a</sup></b>	–	Key function description
	–	Related SCPI commands

- a. Press the **Help** key, and then the key for which you wish help.



# 1 Signal Generator Overview

## CAUTION

To avoid damaging or degrading the performance of the instrument, do not exceed 33 dBm (2W) maximum (27 dBm (0.5W) for N5173N/83B) of reverse power levels at the RF input. See also Tips for Preventing Signal Generator Damage on [www.keysight.com](http://www.keysight.com).

---

- **Signal Generator Features** on page 18
- **Modes of Operation** on page 19
- **Front Panel Overview** on page 21
- **Front Panel Display** on page 25
- **Rear Panel Overview (N5171B, N5172B, N5181B, & N5182B)** on page 28
- **Rear Panel Overview (N5173B & N5183B)** on page 37

## Signal Generator Features

- N5171B/N5181B, RF analog models: 9 kHz to 1 (N5171B only), 3, or 6 GHz (Options 501, 503, and 506 respectively)
- N5172B/N5182B, RF vector models: 9 kHz to 3 or 6 GHz (Options 503, and 506 respectively)
- N5173B/N5183B, Microwave analog models: 9 kHz to 13, 20, 31.8 or 40 GHz (Options 513, 520, 532, and 540 respectively)
- electronic attenuator (N5172B, N5172B, N5181B, N5182B)
- mechanical attenuator (N5173B or N5183B, Option 1E1)
- vector models can include waveforms in list sweep
- automatic leveling control (ALC)
- real-time modulation filtering
- 8648/ESG code compatible
- 10 MHz reference oscillator with external output
- two channel power meter display
- user settable maximum power limit
- user flatness correction
- external analog I/Q inputs (vector models)
- enhanced assembly replacement
- GPIB, USB 2.0, and 100Base-T LAN interfaces
- deep amplitude modulation providing greater dynamic range
- manual power search (ALC off)
- SCPI and IVI-COM driver
- multiple baseband generator synchronization when using multiple signal generators (master/slave setup)
- with Signal Studio Software, vector models can generate 802.11 WLAN, W-CDMA, cdma2000, 1xEV-DO, GSM, EDGE, and more
- real-time baseband generator (Option 660)
- pulse train generator (Option N5180320B)
- LF multifunction generator (Option 303)
- narrow pulse modulation, including internal pulse generator (Option UNW)
- analog differential I/Q outputs (vector models, Option 1EL)
- analog modulation: AM, FM, and  $\Phi$ M (Option UNT)
- arbitrary I/Q waveform playback up to 200 MSa/s (vector models, Option 656/657)

- external AM, FM, and  $\Phi$ M inputs (Option UNT)
- Wideband AM (vector models, Option UNT)
- flexible reference input, 1 – 50 MHz (Option 1ER)
- LO In/Out for phase coherency (Option 012)
- phase noise interference (vector models, Option N5180432B)
- expanded license key upgradability (Option 099)

For more details on hardware, firmware, software, and documentation features and options, refer to the data sheet shipped with the signal generator and available from the Keysight Technologies website at [http://www.keysight.com/find/X-Series\\_SG](http://www.keysight.com/find/X-Series_SG).

## Modes of Operation

Depending on the model and installed options, the Keysight X-Series signal generator provides up to four basic modes of operation: continuous wave (CW), swept signal, analog modulation, and digital modulation.

### Continuous Wave

In this mode, the signal generator produces a continuous wave signal. The signal generator is set to a single frequency and power level. Both the analog and vector models can produce a CW signal.

### Swept Signal

In this mode, the signal generator sweeps over a range of frequencies and/or power levels. Both the analog and vector models provide list and step sweep functionality.

### Analog Modulation

In this mode, the signal generator modulates a CW signal with an analog signal. The analog modulation types available depend on the installed options.

Option UNT provides AM, FM, and  $\Phi$ M modulations. Some of these modulations can be used together.

Option 303 provides a multifunction generator that consists of seven waveform generators.

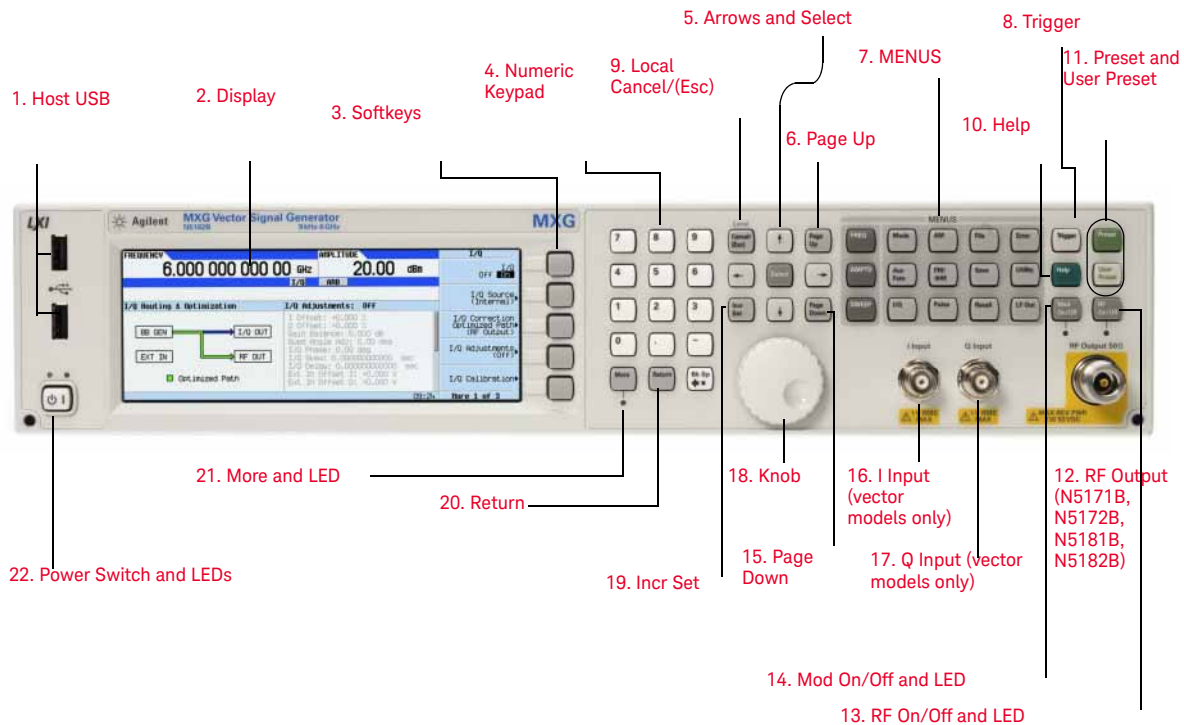
Option UNW provides standard and narrow pulse modulation capability.

## Digital Modulation (Vector Models with Option 65x Only)

In this mode, the signal generator modulates a CW signal with an arbitrary I/Q waveform. I/Q modulation is only available on vector models. An internal baseband generator (Option 65x) adds the following digital modulation formats:

- **Custom Arb Waveform Generator** mode can produce a single-modulated carrier or multiple-modulated carriers. Each modulated carrier waveform must be calculated and generated before it can be output; this signal generation occurs on the internal baseband generator. Once a waveform has been created, it can be stored and recalled, which enables repeatable playback of test signals. To learn more, refer to [“Using the Arbitrary Waveform Generator” on page 397](#).
- **Custom Real-Time Waveform Generator** mode can produce a single-modulated carrier or multiple-modulated carriers. Each modulated carrier waveform must be calculated and generated before it can be output; this signal generation occurs on the internal baseband generator. Once a waveform has been created, it can be stored and recalled, which enables repeatable playback of test signals. To learn more, refer to [“Using the Arbitrary Waveform Generator” on page 397](#).
- **Multitone** mode produces up to 64 continuous wave signals (or tones). Like the Two Tone mode, the frequency spacing between the signals and the amplitudes are adjustable. To learn more, refer to [“Creating a Custom Multitone Waveform” on page 430](#).
- **Two-tone** mode produces two separate continuous wave signals (or tones). The frequency spacing between the signals and the amplitudes are adjustable. To learn more, refer to [Chapter 17, “Multitone and Two-Tone Waveforms \(Option N5180430B\)”](#).
- **Dual ARB** mode is used to control the playback sequence of waveform segments that have been written into the ARB memory located on the internal baseband generator. These waveforms can be generated by the internal baseband generator using the Custom Arb Waveform Generator mode, or downloaded through a remote interface into the ARB memory. To learn more, refer to [“Dual ARB Player” on page 205](#).

## Front Panel Overview



### 1. Host USB

Connector	Type A
USB Protocol	2.0

Use this universal serial bus (USB) to connect a USB Flash Drive (UFD) for data transfer. You can connect or disconnect a USB device without shutting down or restarting the signal generator. The instrument also has a rear panel device USB connector (see [page 30](#)) used to remotely control the instrument.

### 2. Display

The LCD screen provides information on the current function. Information can include status indicators, frequency and amplitude settings, and error messages. Labels for the softkeys are located on the right hand side of the display. See also, [“Front Panel Display” on page 25](#).

### 3. Softkeys

A softkey activates the function indicated by the displayed label to the left of the key.

### 4. Numeric Keypad

The numeric keypad comprises the 0 through 9 hardkeys, a decimal point hardkey, a minus sign hardkey, and a backspace hardkey. See [“Entering and Editing Numbers and Text” on page 59](#).

## 5. Arrows and Select

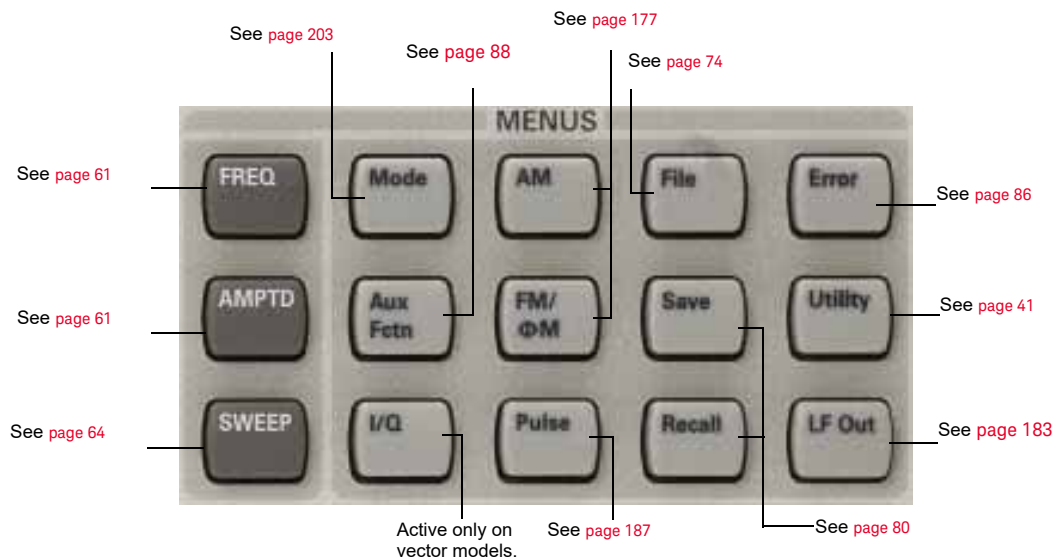
The **Select** and arrow hardkeys enable you to select items on the signal generator's display for editing. See [“Entering and Editing Numbers and Text” on page 59](#).

## 6. Page Up

In a table editor, use this hardkey to display a previous page. See [“Example: Using a Table Editor” on page 60](#). When text does not fit on one page in the display area, use this key in conjunction with the **Page Down** key ([page 23](#)) to scroll text.

## 7. MENUS

These hardkeys open softkey menus that enable you to configure instrument functions or access information.



## 8. Trigger

When trigger mode is set to **Trigger Key**, this hardkey initiates an immediate trigger event for a function such as a list or step sweep.

## 9. Local Cancel/(Esc)

This hardkey deactivates remote operation and returns the signal generator to front panel control, cancels an active function entry, and cancels long operations (such as an IQ calibration).

## 10. Help

Use this key to display a description of any hardkey or softkey. See [“Viewing Key Descriptions” on page 58](#).

## 11. Preset and User Preset

These hardkeys set the signal generator to a known state (factory or user-defined). See [“Presetting the Signal Generator” on page 58](#).

## 12. RF Output (N5171B, N5172B, N5181B, N5182B)

Connector	Standard:	female Type-N
	Option 1EM:	Rear panel output
	Impedance:	50 $\Omega$
Damage Levels	50 Vdc, 2 W maximum RF power	

## 12. RF Output (N5173B, N5183B)

Connector	Option 513/520:	male Precision APC-3.5
	Option 532/540:	male Precision 2.4 mm
	Option 1ED Option 1EM:	female Type-N Rear panel output
	Impedance:	50 $\Omega$
Damage Levels	0 Vdc, 0.5 W maximum RF power	

## 13. RF On/Off and LED

This hardkey toggles the operating state of the RF signal present at the RF OUTPUT connector. The **RF On/Off** LED lights when RF output is enabled.

## 14. Mod On/Off and LED

This hardkey enables or disables the modulation of the output carrier signal by an active modulation format. This hardkey does not set up or activate a format (see [“Modulating the Carrier Signal” on page 72](#)).

The **MOD ON/OFF** LED lights when modulation of the output is enabled.

## 15. Page Down

In a table editor, use this hardkey to display the next page. See [“Example: Using a Table Editor” on page 60](#). When text does not fit on one page in the display area, use this key in conjunction with the **Page Up** key ([page 22](#)) to scroll text.

## 16. I Input (vector models only)

Connector	Type:	female BNC	Impedance:	50 $\Omega$
Signal	An externally supplied analog, in-phase component of I/Q modulation.			
	The signal level is $\sqrt{I^2+Q^2} = 0.5 V_{rms}$ for a calibrated output level.			
Damage Levels	1 $V_{rms}$			

See also, [“I/Q Modulation” on page 263](#).

## 17. Q Input (vector models only)

Connector	Type: female BNC Impedance: 50 $\Omega$
Signal	An externally supplied analog, quadrature-phase component of I/Q modulation. The signal level is $\sqrt{I^2+Q^2} = 0.5 V_{\text{rms}}$ for a calibrated output level.
Damage Levels	1 $V_{\text{rms}}$

See also, [“I/Q Modulation” on page 263](#).

## 18. Knob

Rotating the knob increases or decreases a numeric value, or moves the highlight to the next digit, character, or item in a list. See also, [“Front Panel Knob Resolution” on page 44](#).

## 19. Incr Set

This hardkey enables you to set the increment value of the currently active function. The increment value also affects how much each turn of the knob changes an active function’s value, according to the knob’s current ratio setting (see [“Front Panel Knob Resolution” on page 44](#)).

## 20. Return

This hardkey enables you to retrace key presses. In a menu with more than one level, the **Return** key returns to the prior menu page.

## 21. More and LED

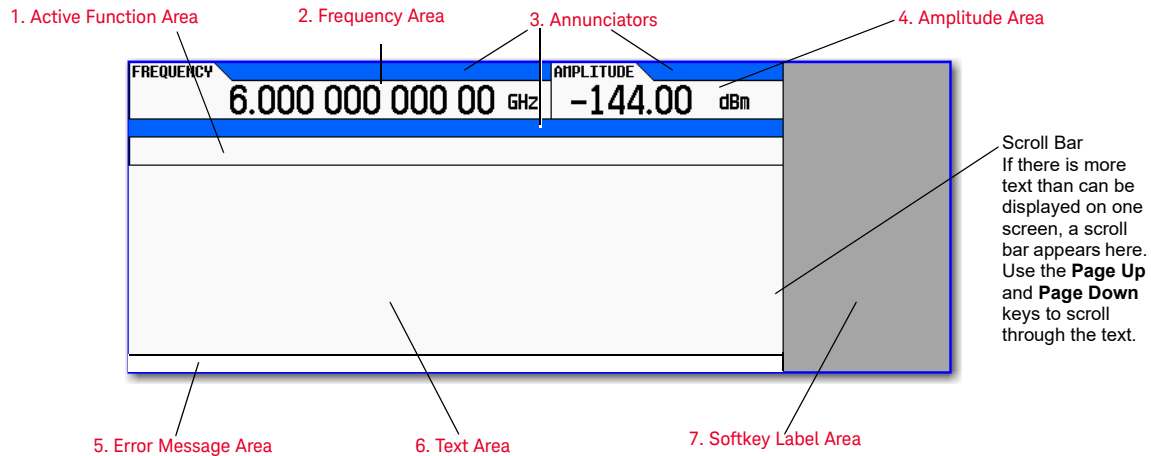
When a menu contains more softkey labels than can be displayed, the More LED lights and a **More** message displays below the labels. To display the next group of labels, press the **More** hardkey.

## 22. Power Switch and LEDs

This switch selects the standby mode or the power on mode. In the standby position, the yellow LED lights and all signal generator functions deactivate. The signal generator remains connected to the line power, and some power is consumed by some internal circuits. In the on position, the green LED lights and the signal generator functions activate.



## Front Panel Display



### 1. Active Function Area

This area displays the currently active function. For example, if frequency is the active function, the current frequency setting appears. If the currently active function has an increment value associated with it, that value also appears.

### 2. Frequency Area

This area displays the current frequency setting.

### 3. Annunciators

Annunciators show the status of some of the signal generator functions, and indicate error conditions. An annunciator position may be used by more than one annunciator; in this case, only one of the functions sharing a given position can be active at a given time.

#### This annunciator appears when...

ΦM	Phase modulation is on. If you turn frequency modulation on, the <b>FM</b> annunciator replaces <b>ΦM</b> .
ARB	The ARB generator is on. ARB is running and not waiting on a trigger.
ALC OFF	The ALC circuit is disabled. The <b>UNLEVEL</b> annunciator appears in the same position if the ALC is enabled and is unable to maintain the output level.
AM	Amplitude modulation is on.
ARMED	A sweep has been initiated and the signal generator is waiting for the sweep trigger event.
ATTNHOLD	The attenuator hold function is on. When this function is on, the attenuator is held at its current setting.
AWGN	Real Time I/Q Baseband additive white Gaussian noise is on.
BBG DAC	A DAC overflow is occurring, adjust the runtime scaling adjust until the <b>BBG DAC</b> annunciator turns off. Another annunciator, <b>UNLOCK</b> , appears in the same position and has priority over the <b>BBG DAC</b> annunciator (see <b>UNLOCK</b> , below).
CHANCORR	The internal channel correction is enabled.
DETHTR	The ALC detector heater is not up to temperature. To meet ALC specifications the heater must be at temperature.
DIGBUS	The digital bus is in use.

**This annunciator appears when...**

DIGMOD	Custom Arb waveform generator is on.
ERR	An error message is placed in the error queue. This annunciator does not turn off until you either view all of the error messages or clear the error queue (see <a href="#">“Reading Error Messages” on page 86</a> ).
EXTREF	An external frequency reference is applied.
FM	Frequency modulation is on. If you turn phase modulation on, the $\Phi$ M annunciator replaces FM.
I/Q	I/Q vector modulation is on.
L	The signal generator is in listener mode and is receiving information or commands over the GPIB, USB, or VXI-11/Sockets (LAN) interface.
M-TONE	Multitone waveform generator is on.
MULT	A frequency multiplier is set (see <a href="#">“Setting a Frequency Multiplier” on page 126</a> ).
OFFS	An output offset is set (see <a href="#">“Setting an Output Offset” on page 124</a> ).
PN	Phase noise interference is on.
PULSE	Pulse modulation is on.
R	The signal generator is remotely controlled over the GPIB, USB, or VXI-11/Sockets (LAN) interface. When the signal generator is in remote mode, the keypad is locked out. To unlock the keypad, press <b>Local</b> (see page <a href="#">22</a> ).
REF	An output reference is set (see <a href="#">“Setting an Output Reference” on page 125</a> ).
RF OFF	The signal generator’s RF Output is not enabled.
S	The signal generator has generated a service request (SRQ) over the GPIB, USB, or VXI-11/Sockets (LAN) interface.
SWEEP	The signal generator is currently sweeping in list or step mode.
SWMAN	The signal generator is in manual sweep mode.
T	The signal generator is in talker mode and is transmitting information over the GPIB, USB, or VXI-11/Sockets (LAN) interface.
T-TONE	Two-Tone waveform generator is on.
UNLEVEL	The signal generator is unable to maintain the correct output level. This is not necessarily an indication of instrument failure; unlevelled conditions can occur during normal operation. Another annunciator, <b>ALC OFF</b> , appears in the same position when the ALC circuit is disabled (see <b>ALC OFF</b> , above).
UNLOCK	Any of the phase locked loops cannot maintain phase lock. To determine which loop is unlocked, examine the error messages (see <a href="#">“Reading Error Messages” on page 86</a> ).
WATRIG	The current modulation mode is waiting on the Arb trigger.
WINIT	The signal generator is waiting for you to initiate a single sweep.

## 4. Amplitude Area

This area displays the current output power level setting (If the RF Output is off, this area is greyed out).

## 5. Error Message Area

This area displays abbreviated error messages. If multiple messages occur, only the most recent message remains displayed. See [“Reading Error Messages” on page 86](#).

## 6. Text Area

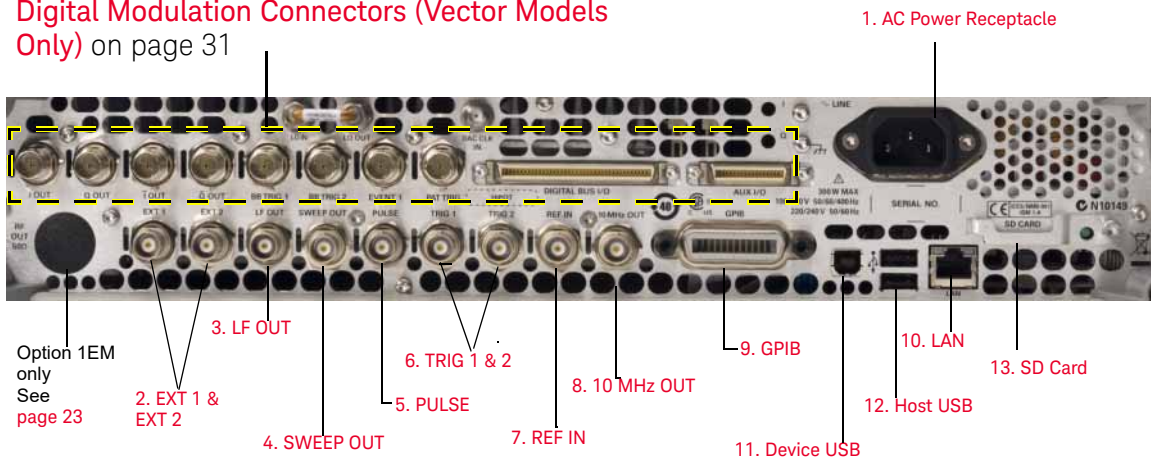
This area displays signal generator status information, such as the modulation status, and other information such as sweep lists and file catalogs. This area also enables you to perform functions such as managing information (entering information, and displaying or deleting files).

## 7. Softkey Label Area

This area displays labels that define the function of the softkeys located immediately to the right of the display. Softkey labels change, depending on the function selected.

## Rear Panel Overview (N5171B, N5172B, N5181B, & N5182B)

Digital Modulation Connectors (Vector Models Only) on page 31



### 1. AC Power Receptacle

The AC power cord receptacle accepts a three-pronged AC power cord that is supplied with the signal generator. For details on line setting requirements and the power cord, see the **Getting Started Guide**.

#### CAUTION

To avoid the loss of data, GPIB settings, or current user instrument states that have not been permanently saved to nonvolatile memory, the signal generator should always be powered down either via the instrument's front panel power button or the appropriate SCPI command. Signal generators installed in rack systems and powered down with the system rack power switch rather than the instrument's front panel switch display a Error -310 due to the instrument not being powered down correctly.

## 2. EXT 1 & EXT 2

Connector	female BNC	Impedance nominally 50 $\Omega$
Signal	An externally supplied $\pm 1$ V <sub>p</sub> signal that produces the indicated depth.	
Damage Levels	5 V <sub>rms</sub> and 10 V <sub>p</sub>	

## 3. LF OUT

Connector	female BNC	Impedance 50 $\Omega$
Signal	Voltage range: 0 to +5 V <sub>p</sub> Offset: -5 V to +5 V, nominal	
	For more information, see page <a href="#">183</a> .	

## 4. SWEEP OUT

Connector	female BNC	Impedance <1 $\Omega$ Can drive 2 k $\Omega$ .
Signal	Voltage range: 0 to +10 V, regardless of sweep width In swept mode: beginning of sweep = 0 V; end of sweep = +10 V In CW mode: no output	
	This is a multiple use connector. For signal routing selections, see pages <a href="#">65</a> and <a href="#">187</a> .	

## 5. PULSE

Connector	female BNC	Impedance nominally 50 $\Omega$
Signal	Externally supplied: +1 V = on; 0 V = off	
Damage Levels	$\leq -0.3$ and $\geq +5.3$ V	

## 6. TRIG 1 & 2

Connector	female BNC	Impedance high Z
Signal	An externally supplied TTL or CMOS signal for triggering operations, such as point to point in manual sweep mode or an LF sweep in external sweep mode. Triggering can occur on either the positive or negative edge.	
Damage Levels	$\leq -0.5$ and $\geq +5.5$ V	

## 7. REF IN

Connector	female BNC	Impedance nominally 50 $\Omega$
Signal	An externally supplied $-3.5$ to $+20$ dBm signal from a timebase reference that is within $\pm 1$ ppm.	

In its factory default mode, the signal generator can detect a valid reference signal at this connector and automatically switch from internal to external reference operation. See **“Presetting the Signal Generator” on page 58**. With Option 1ER (flexible reference input), you must explicitly tell the signal generator the external reference frequency you wish to use; enter the information through the front panel or over the remote interface.

## 8. 10 MHz OUT

Connector    female BNC    Impedance nominally 50  $\Omega$   
Signal        A nominal signal level greater than 4 dBm.

## 9. GPIB

This connector enables communication with compatible devices such as external controllers, and is one of three connectors available to remotely control the signal generator (see also **10. LAN** and **11. Device USB**).

## 10. LAN

The signal generator supports local area network (LAN) based communication through this connector, which enables a LAN-connected computer to remotely program the signal generator. The LAN interface supports auto-MDIX. The signal generator is limited to 100 meters on a single cable (100Base-T). For more information on the LAN, refer to the **Programming Guide**.

## 11. Device USB

Connector    Type B  
USB Protocol    Version 2.0

Use this universal serial bus (USB) connector to connect a PC to remotely control the signal generator.

## 12. Host USB

Connector    Type A  
USB Protocol    2.0

Use this universal serial bus (USB) to connect a USB Flash Drive (UFD) for data transfer. You can connect or disconnect a USB device without shutting down or restarting the signal generator.

## 13. SD Card

Holds the Secure Digital (SD) nonvolatile memory card.

## Digital Modulation Connectors (Vector Models Only)

### I OUT, Q OUT, i OUT, $\bar{Q}$ OUT

#### NOTE

i OUT and  $\bar{Q}$  OUT, require Option 1EL.

Connector	Type: female BNC    Impedance: 50 $\Omega$ DC-coupled
Signal	
I OUT	The analog, in-phase component of I/Q modulation from the internal baseband generator.
Q OUT	The analog, quadrature-phase component of I/Q modulation from the internal baseband generator.
i OUT	Used in conjunction with the I OUT connector to provide a balanced <sup>a</sup> baseband stimulus.
$\bar{Q}$ OUT	Used in conjunction with the Q OUT connector to provide a balanced <sup>a</sup> baseband stimulus.
Damage Levels	> 1 Vrms <b>DC Origin Offset</b> typically <10 mV

#### Output Signal Levels into a 50 $\Omega$ Load

- 0.5 V<sub>pk</sub>, typical, corresponds to one unit length of the I/Q vector
- 0.69 V<sub>pk</sub> (2.84 dB), typical, maximum crest factor for peaks for  $\pi/4$  DQPSK, alpha = 0.5
- 0.71 V<sub>pk</sub> (3.08 dB), typical, maximum crest factor for peaks for  $\pi/4$  DQPSK, alpha = 0.35
- Typically 1 V<sub>p-p</sub> maximum

a. Balanced signals are signals present in two separate conductors that are symmetrical relative to ground, and are opposite in polarity (180 degrees out of phase).

### BB TRIG 1 & BB TRIG 2

Connector	female BNC                      Impedance nominally 50 $\Omega$
Signal	Reserved for arbitrary and real-time baseband generators I/O, such as markers or trigger inputs.

### EVENT 1

Connector	female BNC    Impedance: nominally 50 $\Omega$
Signal	A pulse that can be used to trigger the start of a data pattern, frame, or timeslot. Adjustable to $\pm$ one timeslot; resolution = one bit <b>Markers</b> Each Arb-based waveform point has a marker on/off condition associated with it. Marker 1 level = +3.3 V CMOS high (positive polarity selected); -3.3 V CMOS low (negative polarity selected). Output on this connector occurs whenever Marker 1 is on in an Arb-based waveform (see <b>“Using Waveform Markers” on page 221</b> ).
Damage Levels	< -4 and > +8 V

## PAT TRIG

Connector	female BNC
Signal	<p>A TTL/CMOS low to TTL/CMOS high, or TTL/CMOS high to TTL/CMOS low edge trigger. The input to this connector triggers the internal digital modulation pattern generator to start a single pattern output or to stop and re-synchronize a pattern that is being continuously output. To synchronize the trigger with the data bit clock, the trigger edge is latched, then sampled during the falling edge of the internal data bit clock. This is the external trigger for all ARB waveform generator triggers.</p> <p><b>Minimum Trigger Input Pulse Width</b> (high or low) = 10 ns</p> <p><b>Minimum Trigger Delay</b> (trigger edge to first bit of frame) = 1.5 to 2.5 bit clock periods</p>
Damage Levels	< -4 and > +8 V

## DIGITAL BUS I/O

This is a proprietary bus used by Keysight Technologies signal creation software. This connector is not operational for general purpose use. Signals are present only when a signal creation software option is installed (for details, refer to <http://www.keysight.com/find/signalcreation>).

### NOTE

The X-Series' Digital BUS I/O connector can be used for enabling operation with the Keysight Technologies N5106A PXB MIMO Receiver Tester.

---



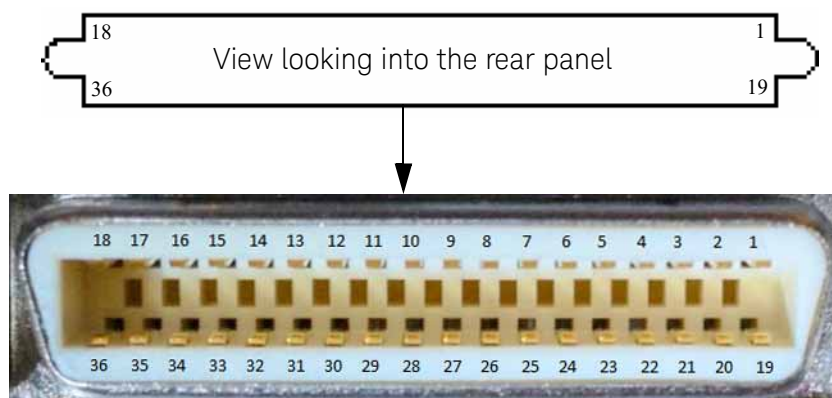
## AUX I/O Connector

This female 36-pin connector is available only on instruments with an internal baseband generator (Option 653, 655, 656, 657). On signal generators without one of these options, this connector is not present.

The AUX I/O connector allows the X-Series signal generator to interface with external equipment by sending and/or receiving supplementary (auxiliary) signaling information. This information is non-RF related signaling such as:

- output markers to an external device from Arbitrary waveform playback sent to external equipment to trigger or respond to waveform changes.
- output of signal markers to an external device from real-time signal generation personalities. Signals such as frame markers, pulse-per-second, and even-second, for example, may be supported, depending on the signal generation personality (CDMA, 3GPP, GNSS, LTE, etc.).
- input signals from external devices under test to cause the signal generator to modify characteristics of a signal being generated, depending on the signal generation personality (CDMA, 3GPP, LTE, etc.).

**Table 1-1 on page 35** describes the inputs and outputs accessible through the AUX I/O connector. The specific functions controllable by auxiliary signaling vary significantly from one real-time signal generation personality to another. Refer to the documentation for each real-time signal generation personality for additional information.



The AUX I/O connector is a shielded .050 series  
The AUX I/O mating connector manufacturer's part number is  
3M® 10136-3000 (wire mount plug).

### NOTE

The AUX I/O connector supports standard 3.3V TTL signaling levels. Signals support data rates up to 50 MHz with minimum rise and fall times of 3ns. Any pins that are not connected will have a weak pull-up to 3.3V.

#### Markers (pins 1-4)

Each Arb-based waveform point has a marker on/off condition associated with it.  
Each real-time signal can be routed to the output marker signals using SCPI commands or the real-time personalities.  
Marker level = +3.3 V high (positive polarity selected); 0V low (negative polarity selected).

#### Event 1 (pin 1)

Pin 1 outputs a pulse that can be used to trigger the start of a data pattern, frame, or timeslot.  
Adjustable to  $\pm$  one timeslot; resolution = one bit

#### Data Clock Out (pin 7)

Pin 7 is used with an internal baseband generator. This pin relays a CMOS bit clock signal for synchronizing serial data.

#### Data In (pin 23)

Pin 23 accepts an externally supplied CMOS-compatible signal data input used with digital modulation applications. The expected input is a CMOS signal where a CMOS high is equivalent to a data 1 and a CMOS low is equivalent to a data 0.

The maximum input data rate is 50 Mb/s. The data must be valid on the DATA CLOCK falling edges.

#### Symbol Sync In (pin 25)

Pin 25 accepts an externally supplied symbol sync signal for use with digital modulation applications.

#### Data Clock In (pin 29)

Pin 29 accepts an externally supplied CMOS-compatible signal data-clock input used with digital modulation applications. The expected input is a CMOS bit clock signal where the rising edge is aligned with the beginning data bit. The falling edge is used to clock the DATA and SYMBOL SYNC signals.

The maximum clock rate is 50 MHz.

#### Event 2 (pin 31)

Pin 31 outputs data enable signal for gating external equipment. The output is applicable when the external data is clocked into internally generated timeslots. Data is enabled when the signal is low.

Table 1-1 AUX I/O Connector Configuration

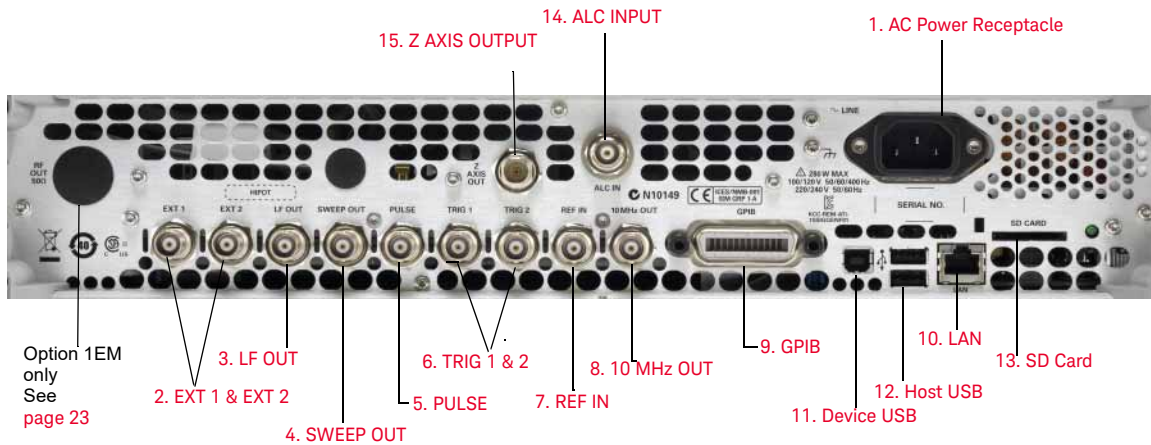
MXG and EXG AUX I/O Connector Configuration								
Pin #	ARB & ARB-Based Applications		Real-Time Custom Modulation		Real-Time Applications		BERT Capability	
	Input	Output	Input	Output	Input	Output	Input	Output
1		Marker(1)		Event 1		Marker(1)		
2		Marker(2)				Marker(2)		
3		Marker(3)				Marker(3)		
4		Marker(4)				Marker(4)		
5								
6					AUX Strobe			
7				Data Clock Output		10MHz Clock		
8					AUX(0)			
9					AUX(1)			
10					AUX(2)			
11					AUX(3)			
12					AUX(4)			
13					AUX(5)			
14					AUX(6)		AUX I/O	
15					AUX(7)			BER Meas End <sup>a</sup>
16					AUX(8)			BER Sync Loss <sup>a</sup>
17					AUX(9)			BER Test Out <sup>a</sup>
18					AUX(10)			BER Gate Out <sup>a</sup>
19					AUX(11)			BER No Data <sup>a</sup>
20	GND	GND	GND	GND	GND	GND		
21					AUX(12)			

Table 1-1 AUX I/O Connector Configuration

<b>MXG and EXG AUX I/O Connector Configuration</b>								
<b>Pin #</b>	<b>ARB &amp; ARB-Based Applications</b>		<b>Real-Time Custom Modulation</b>		<b>Real-Time Applications</b>		<b>BERT Capability</b>	
	<b>Input</b>	<b>Output</b>	<b>Input</b>	<b>Output</b>	<b>Input</b>	<b>Output</b>	<b>Input</b>	<b>Output</b>
22	GND	GND	GND	GND	GND	GND		
23			Data Input		AUX(13)			
24	GND	GND	GND	GND	GND	GND		
25			Symbol Sync Input		AUX(14)			
26	GND	GND	GND	GND	GND	GND		
27			Burst Input		AUX(15)			
28	GND	GND	GND	GND	GND	GND		
29			Data Clock Input			AUX Sample Clock		
30	GND	GND	GND	GND	GND	GND		
31				Event 2				
32	GND	GND	GND	GND	GND	GND		
33				Data Out		AUX Out(1)		
34	GND	GND	GND	GND	GND	GND		
35				Symbol Sync Output		AUX Out(2)		
36	GND	GND	GND	GND	GND	GND		

- a. Settings shown are for the Error Out signal configuration of the AUX I/O connector (BERT > I/O Setup > Aux I/O Out). Press the Help hardkey, then either Reference Out or PN9 Out for the respective signal configuration.

## Rear Panel Overview (N5173B & N5183B)



### 1. AC Power Receptacle

The AC power cord receptacle accepts a three-pronged AC power cord that is supplied with the signal generator. For details on line setting requirements and the power cord, see the **Getting Started Guide**.

#### CAUTION

To avoid the loss of data, GPIB settings, or current user instrument states that have not been permanently saved to nonvolatile memory, the signal generator should always be powered down either via the instrument's front panel power button or the appropriate SCPI command. Signal generators installed in rack systems and powered down with the system rack power switch rather than the instrument's front panel switch display a Error -310 due to the instrument not being powered down correctly.

## 2. EXT 1 & EXT 2

Connector	female BNC	Impedance nominally 50 $\Omega$
Signal	An externally supplied $\pm 1 V_p$ signal that produces the indicated depth.	
Damage Levels	5 $V_{rms}$ and 10 $V_p$	

## 3. LF OUT

Connector	female BNC	Impedance 50 $\Omega$
Signal	Voltage range: 0 to +5 $V_p$ Offset: -5 V to +5 V, nominal	
	For more information, see page <PagenumOnlyCallout>183.	

## 4. SWEEP OUT

Connector	female BNC	Impedance <1 $\Omega$ Can drive 2 k $\Omega$ .
Signal	Voltage range: 0 to +10 V, regardless of sweep width In swept mode: beginning of sweep = 0 V; end of sweep = +10 V In CW mode: no output	
	This is a multiple use connector. For signal routing selections, see pages 65 and 187.	

## 5. PULSE

Connector	female BNC	Impedance nominally 50 $\Omega$
Signal	Externally supplied: +1 V = on; 0 V = off	
Damage Levels	$\leq -0.3$ and $\geq +5.3$ V	

## 6. TRIG 1 & 2

Connector	female BNC	Impedance high Z
Signal	An externally supplied TTL or CMOS signal for triggering operations, such as point to point in manual sweep mode or an LF sweep in external sweep mode. Triggering can occur on either the positive or negative edge.	
Damage Levels	$\leq -0.5$ and $\geq +5.5$ V	

## 7. REF IN

Connector	female BNC	Impedance nominally 50 $\Omega$
Signal	An externally supplied -3.5 to +20 dBm signal from a timebase reference that is within $\pm 1$ ppm.	

In its factory default mode, the signal generator can detect a valid reference signal at this connector and automatically switch from internal to external reference operation. See **“Presetting the Signal Generator” on page 58**. With Option 1ER (flexible reference input), you must explicitly tell the signal generator the external reference frequency you wish to use; enter the information through the front panel or over the remote interface.

## 8. 10 MHz OUT

Connector female BNC Impedance nominally 50  $\Omega$   
Signal A nominal signal level greater than 4 dBm.

## 9. GPIB

This connector enables communication with compatible devices such as external controllers, and is one of three connectors available to remotely control the signal generator (see also **10. LAN** and **11. Device USB**).

## 10. LAN

The signal generator supports local area network (LAN) based communication through this connector, which enables a LAN-connected computer to remotely program the signal generator. The LAN interface supports auto-MDIX. The signal generator is limited to 100 meters on a single cable (100Base-T). For more information on the LAN, refer to the **Programming Guide**.

## 11. Device USB

Connector Type B  
USB Protocol Version 2.0

Use this universal serial bus (USB) connector to connect a PC to remotely control the signal generator.

## 12. Host USB

Connector Type A  
USB Protocol 2.0

Use this universal serial bus (USB) to connect a USB Flash Drive (UFD) for data transfer. You can connect or disconnect a USB device without shutting down or restarting the signal generator.

## 13. SD Card

Holds the Secure Digital (SD) nonvolatile memory card.

## 14. ALC INPUT

This input connector is used for negative external detector leveling.

Connector female BNC Impedance nominally 100 k $\Omega$   
Signal -0.2 mV to -0.5 V  
Damage Levels -12 to 1 V

## 15. Z AXIS OUTPUT

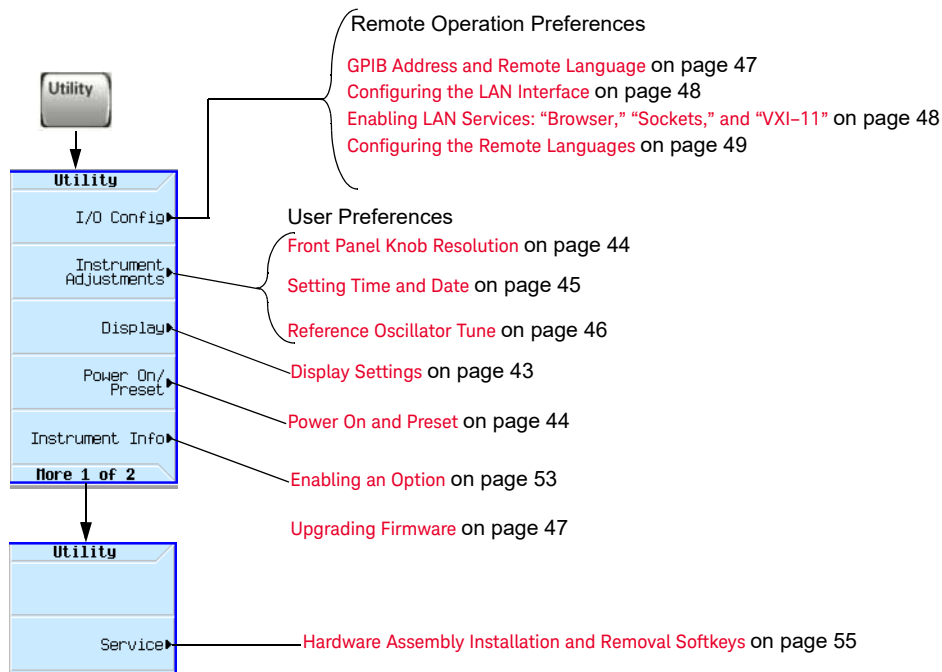
This female BNC connector supplies a +5 V (nominal) level during retrace and band-switch intervals of a step or list sweep. During step or list sweep, this female BNC connector supplies a -5 V (nominal) level when the RF frequency is at a marker frequency and intensity marker mode is on. This signal is derived from an operational amplifier output so the load impedance should be greater than or equal to 5 kohms.<sup>1</sup>

Connector    female BNC    Impedance nominally 50  $\Omega$   
Signal        A nominal signal level greater than 4 dBm.



## 2 Preferences & Enabling Options

The Utility menu provides access to both user and remote operation preferences, and to the menus in which you can enable instrument options.



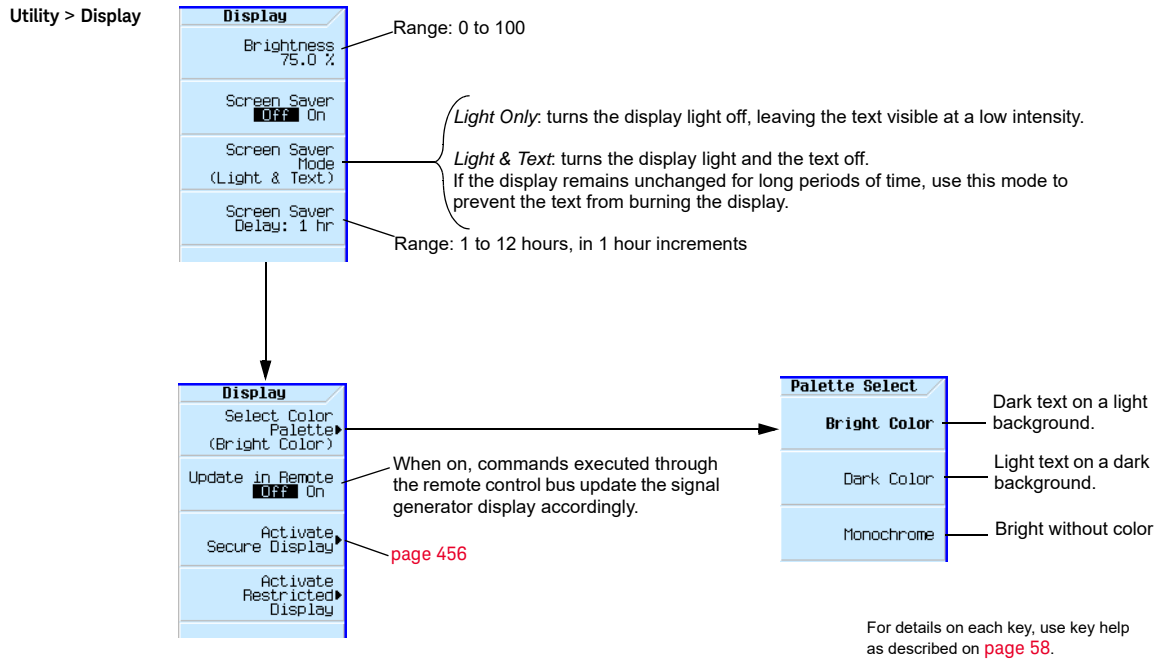
## User Preferences

From the Utility menu, you can set the following user preferences:

- Display Settings, below
- **Power On and Preset** on page 44
- **Front Panel Knob Resolution** on page 44

## Display Settings

See also, [Using Secure Display \(Option 006\)](#) on page 456.



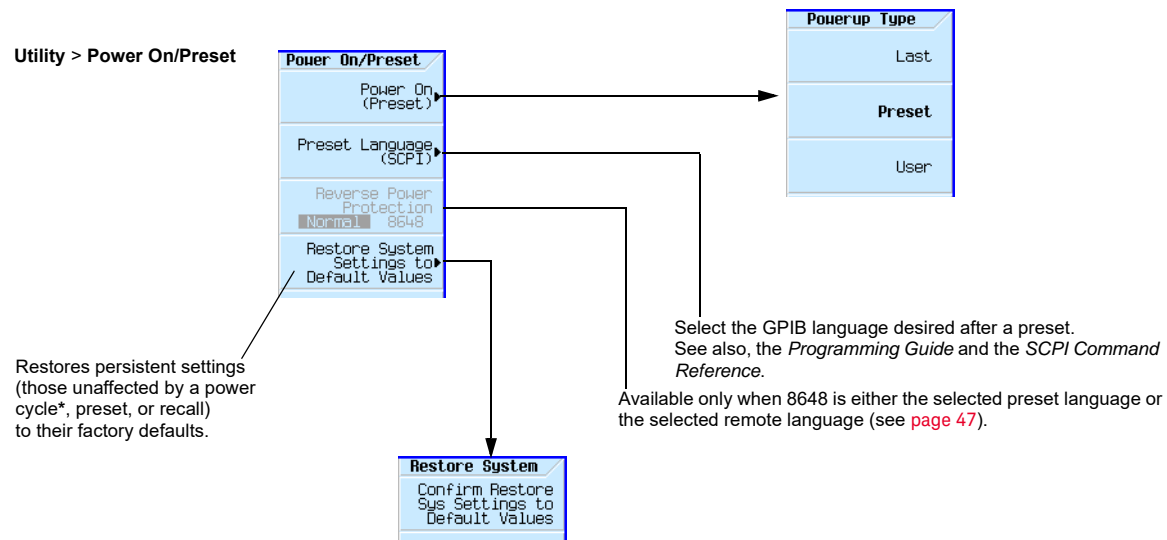
**NOTE**

X-Series signal generators are shipped from the factory with default display settings. Automated Test Environment (ATE) users may benefit from display settings other than the default settings. When the signal generator display is not required to be active for long periods of time, consider using the Screen Saver Mode to extend the life of the display.

**NOTE**

With the brightness set to minimum, the display may be too dark to see the softkeys. If this happens, use the figure above to locate the brightness softkey and adjust the value so that you can see the display.

## Power On and Preset



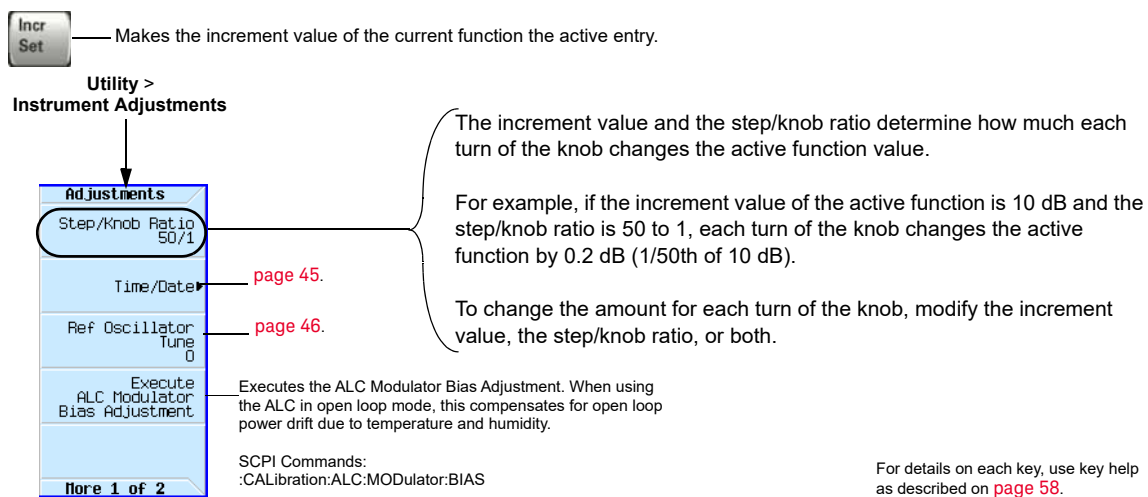
### \*Caution

To avoid the loss of data, GPIB settings, or current user instrument states that have not been permanently saved to nonvolatile memory, the X-Series signal generator should always be powered down either via the instrument's front panel power button or the appropriate SCPI command. X-Series signal generators installed in rack systems and powered down with the system rack power switch rather than the instrument's front panel switch display a Error -310 due to the instrument not being powered down correctly.

### Note

To define a user preset, set the instrument up as desired and press **User Preset > Save User Preset**.

## Front Panel Knob Resolution



## Setting Time and Date

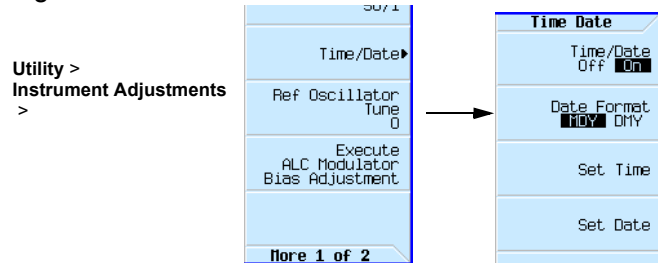
The signal generator's firmware tracks the time and date, and uses the **latest** time and date as its time/date reference point.

### CAUTION

Changing the time or date can adversely affect the signal generator's ability to use time.

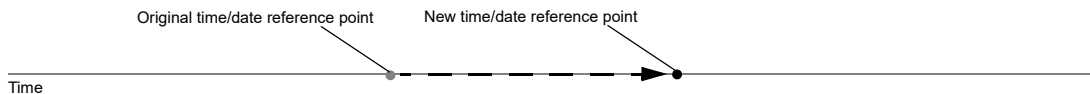
- based licenses, even if a time based license is not installed.

Figure 2-1



### Setting the Time or Date Forward

If you set the time or date forward, be aware that you are using up any installed time-based licenses, and that you are **resetting the signal generator's time/date reference point**. When you set a new time or date that is later than the signal generator's current reference point, that date becomes the new reference point. If you then set the date back, you run the risk described in the next section.

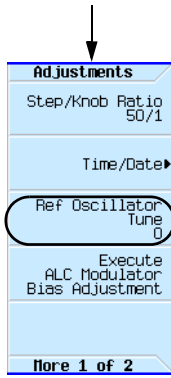


### Setting the Time or Date Backward

When you set the time back, the signal generator notes that the time has moved back from the reference point. If you set the time back more than a few hours, you disable the signal generator's ability to use time-based licenses, even if there is no license installed at the time that you set the time back. In this case, you can re-enable the signal generator's ability to use time-based licenses by moving the clock forward to the original time or simply waiting that length of time.

## Reference Oscillator Tune

Utility > Instrument Adjustments



For details on each key, use key help as described on [page 58](#).

Tunes the internal VCTXCO oscillator frequency.

The user value offsets the factory tuned value (the value is added to the factory calibrated DAC value). The tune value of 0 sets the factory calibrated value.

The range; -8192 to 8192, can be set by using the front panel keypad, knob or remote command.

See also the *SCPI Command Reference*.

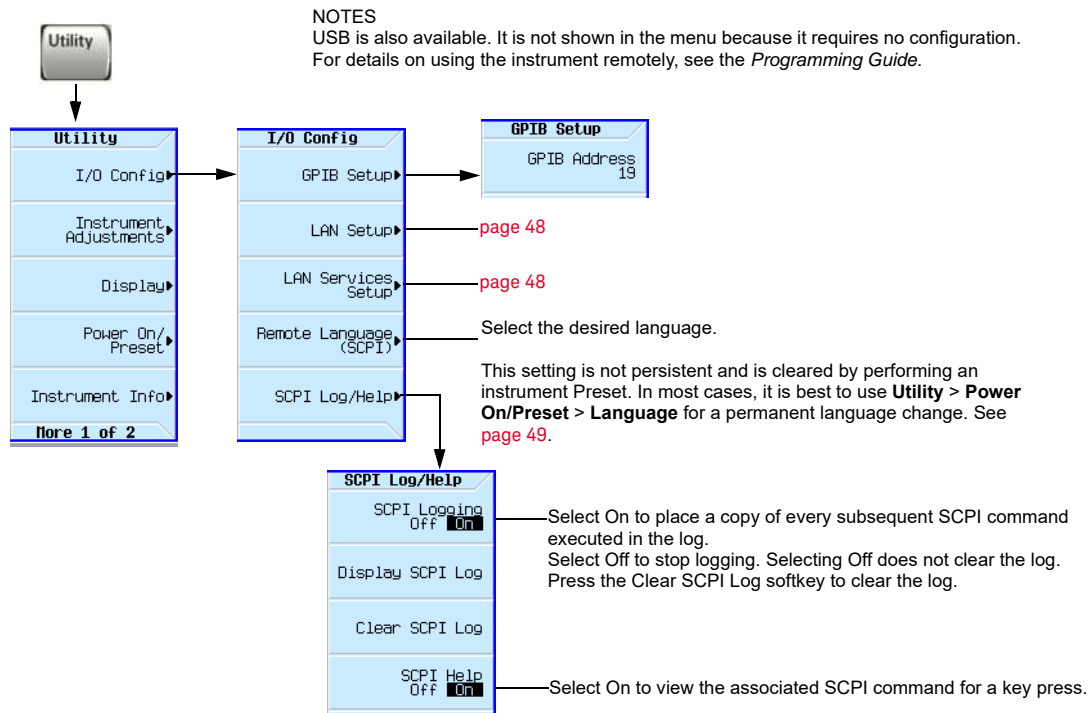
## Upgrading Firmware

For information on new firmware releases, go to <http://www.keysight.com/find/upgradeassistant>.

## Remote Operation Preferences

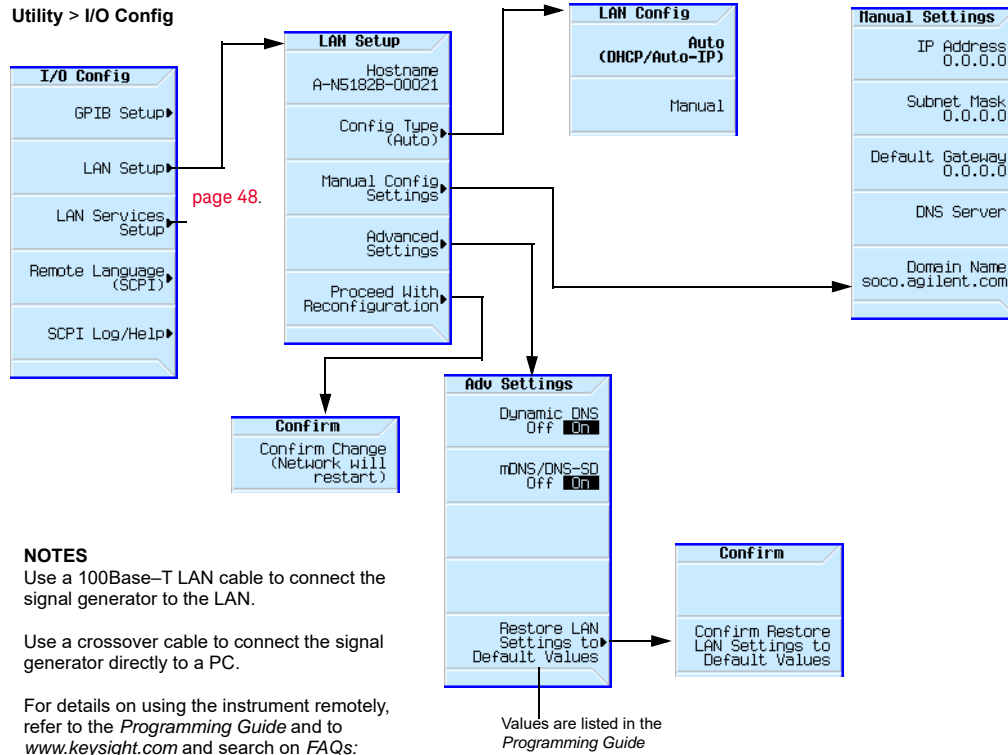
For details on operating the signal generator remotely, refer to the **Programming Guide**.

## GPIO Address and Remote Language



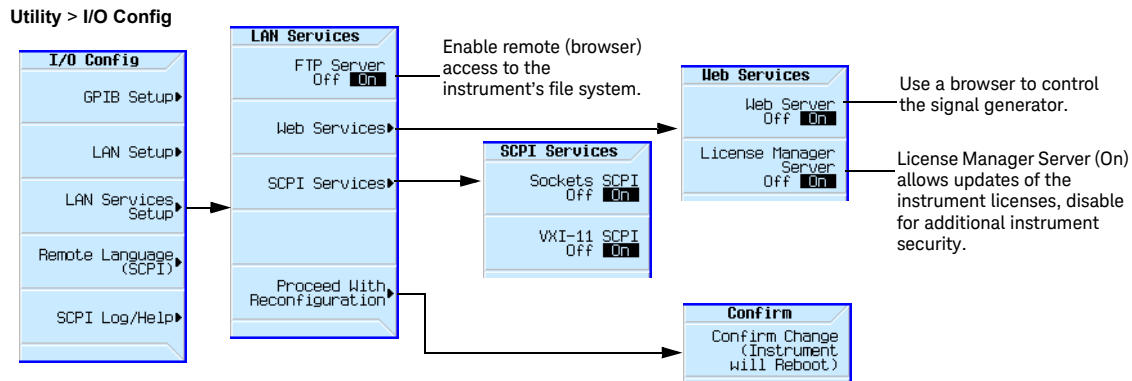
For details on each key, use key help as described on page 58.

## Configuring the LAN Interface



For details on each key, use key help as described on page 58.

## Enabling LAN Services: “Browser,” “Sockets,” and “VXI-11”



For details on each key, use key help as described on page 58.

For more information refer to the *Programming Guide*.

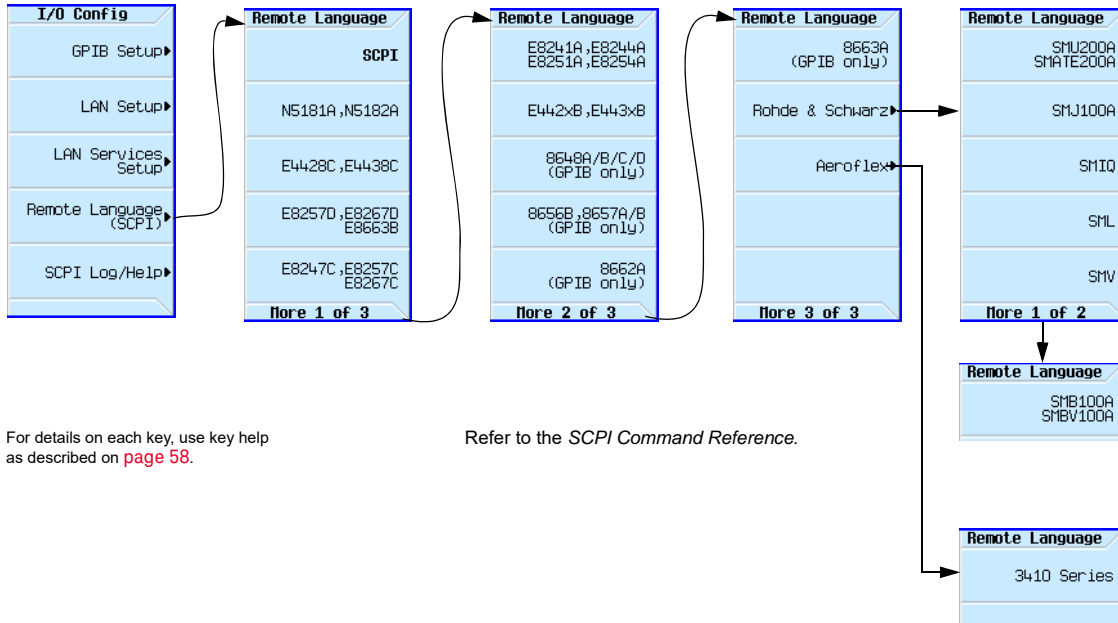


## Configuring the Remote Languages

Figure 2-2 N5171B/72B/81B/82B

Utility > I/O Config

Select the desired Remote language.



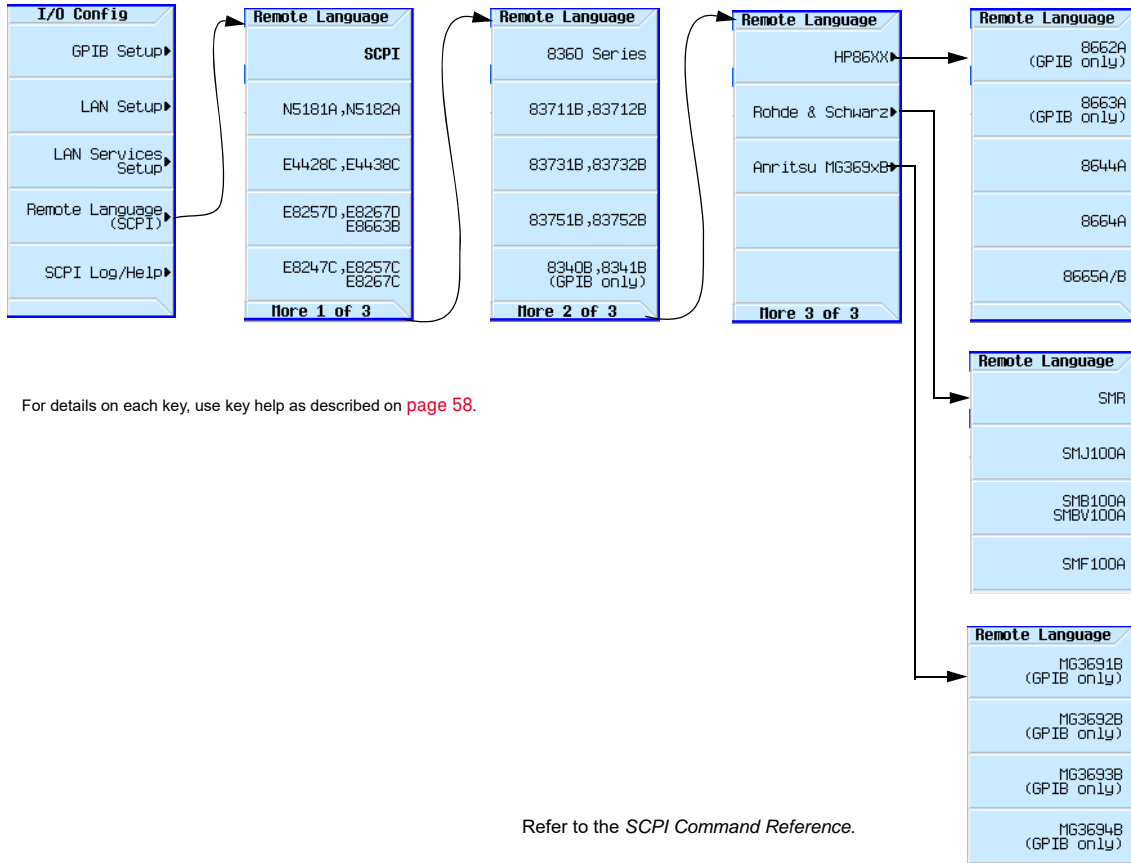
For details on each key, use key help as described on [page 58](#).

Refer to the *SCPI Command Reference*.

Figure 2-3 N5173B/83B

Utility > I/O Config

Select the desired Remote language.



For details on each key, use key help as described on [page 58](#).

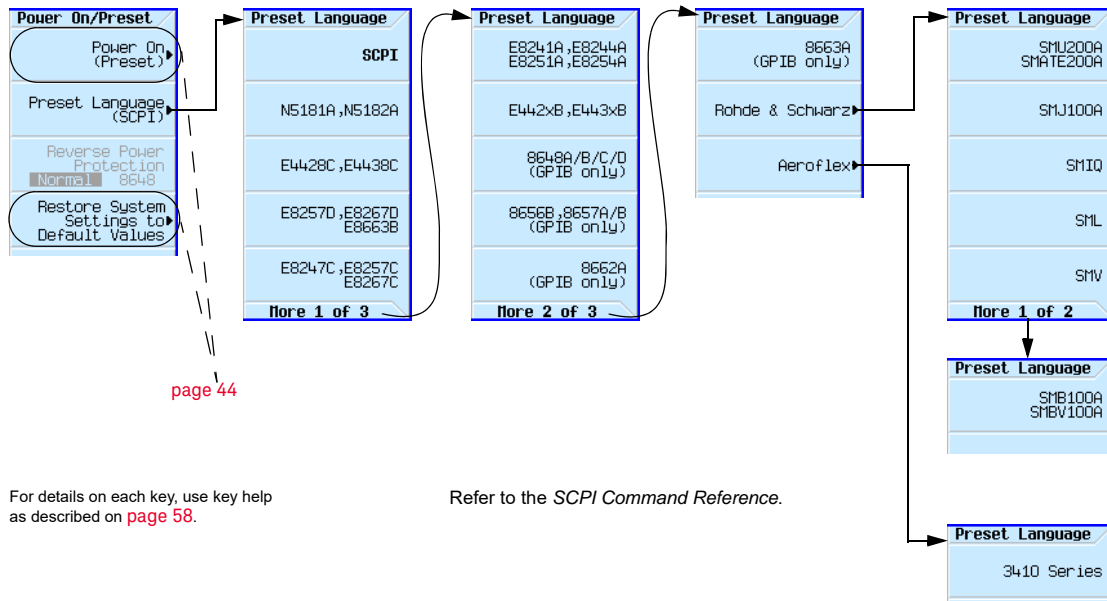
Refer to the *SCPI Command Reference*.

## Configuring the Preset Languages

Figure 2-4 N5171B/72B/81B/82B

Utility > Power On/Preset

Select the desired Remote language.



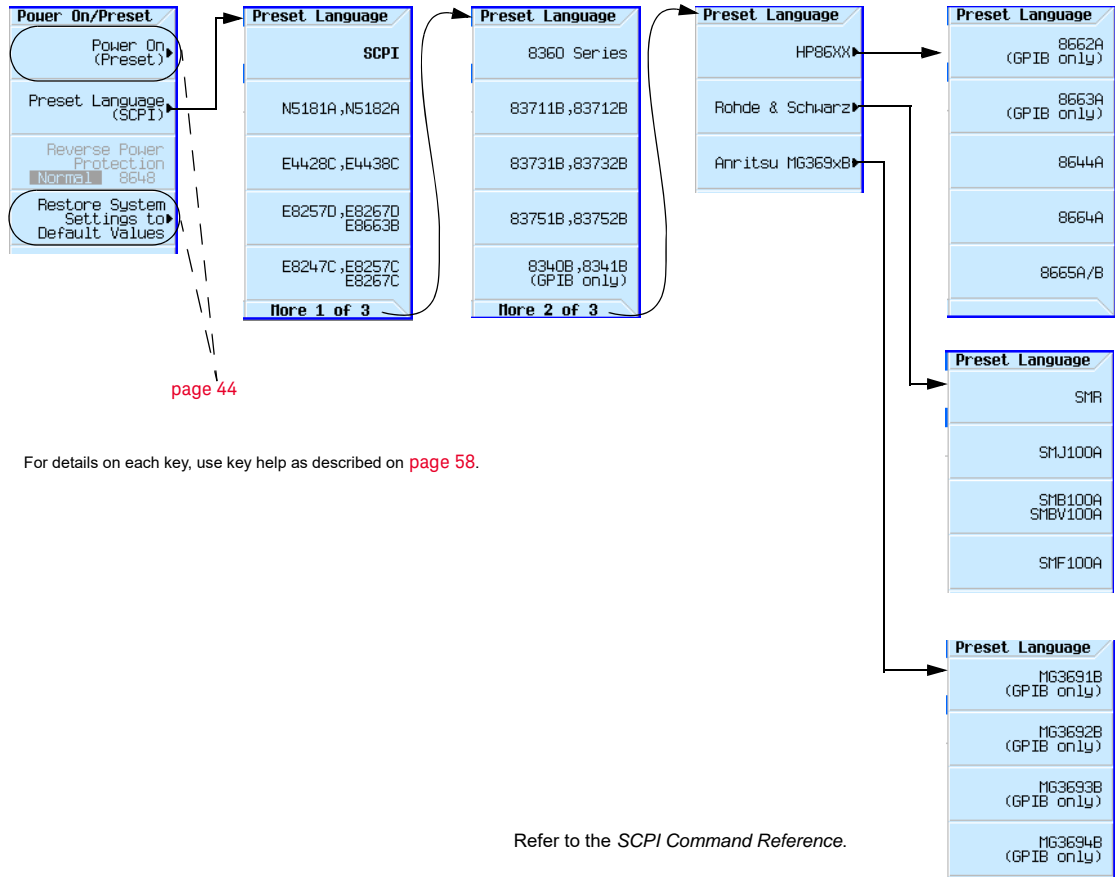
For details on each key, use key help as described on page 58.

Refer to the SCPI Command Reference.

Figure 2-5 N5173B/83B

Utility > Power On/Presets

Select the desired Remote language.



## Enabling an Option

### NOTE

With firmware version B.0.175 or later, the following options have changed to a new eight-digit format:

- Option 302 to Option N5180302B
- Option 320 to Option N5180320B
- Option 403 to Option N5180403B
- Option 430 to Option N5180430B
- Option 431 to Option N5180431B
- Option 432 to Option N5180432B
- Option UN7 to Option N5180UN7B

Only software options are changed to the eight-digit format. Hardware options remain with three-digits.

---

There are three ways to enable an option:

1. Download and run the License Manager software on a PC connected to the instrument from: [www.keysight.com/find/LicenseManager](http://www.keysight.com/find/LicenseManager).
2. Place the license file (\*.lic) on a USB flash drive:
  - a. Insert the USB flash drive into one of the instrument front panel USB ports.
  - b. Select the license file.
  - c. Press Install Licenses.
3. Use SCPI commands, as described in the **SCPI Command Reference**.

## Viewing Options and Licenses

Utility >  
**Instrument Info**

**Instrument Info**

- Diagnostic Info
- Options Info
- Self Test
- Installed Board Info
- Front Panel Tests

**Options Info**

- Instrument Options
- Software Support Subscriptions
- Auxiliary Software Options
- Waveform Licenses

Instrument options appear here. A check mark means that an option is enabled.

Instrument Option	Expiration	Description
003	permanent	✓ Digital output connectivity with the N5102
004	permanent	✓ Digital input connectivity with the N5102A
006	permanent	✓ Security and removable memory card
009	permanent	✓ Internal solid state memory
012	permanent	✓ LO in/out for phase coherency
021	permanent	✓ Upgrade BBG memory from 32 Msa to 256 Msa
022	permanent	✓ Upgrade BBG memory from 32 Msa to 512 Msa
023	permanent	✓ Upgrade BBG memory from 32 Msa to 1 Gsa
099	permanent	✓ Expanded license key upgradability
1EA	permanent	✓ High power output

03/09/2012 14:29

**Software Support Subscriptions**

Subscription Option	SI Support Expiration	Description
N5180302B	2020.0109	✓ Avionics VOR/ILS
N5180320B	2020.0123	✓ Pulse Train Generator

01/15/2019 15:00

Displays software options and information such as those that are internal to the instrument. With firmware B.01.75 or later, these options are an eight-digit format as shown in this figure.

**Waveform Licenses**

Wave ID	Days Left	Description
Waveform licenses from some Signal Studio applications appear here.		

**Aux Software Licenses**

Service Software Licenses appear here.

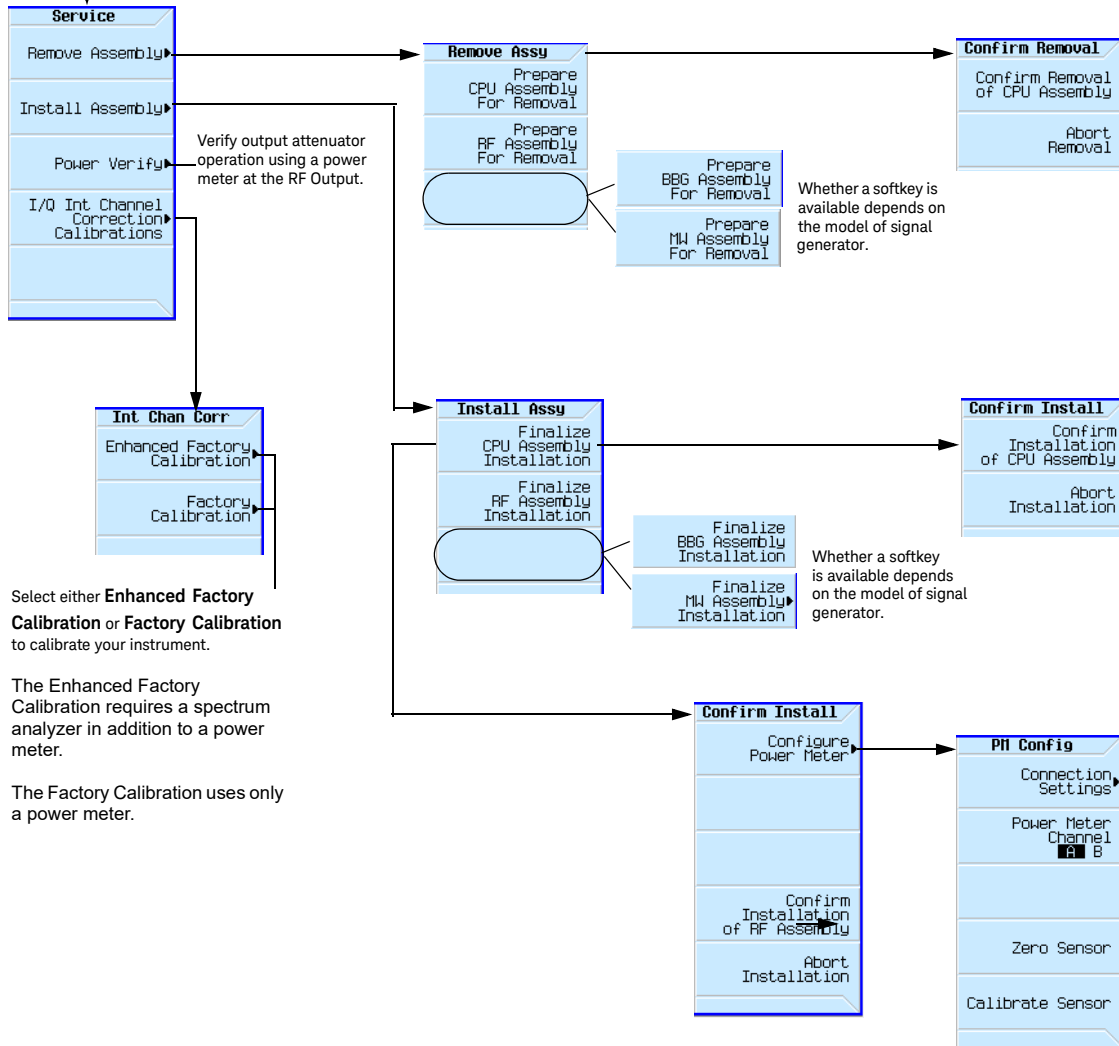
03/09/2012 14:30

For details on each key, use key help as described on [page 58](#).

# Hardware Assembly Installation and Removal Softkeys

Utility > More 2 of 2 >

For details on each key, use key help as described on [page 58](#).



Preferences & Enabling Options  
Hardware Assembly Installation and Removal Softkeys



## 3 Basic Operation

This chapter introduces fundamental front panel operation. For information on remote operation, refer to the **Programming Guide**.

- **Presetting the Signal Generator** on page 58
- **Viewing Key Descriptions** on page 58
- **Entering and Editing Numbers and Text** on page 59
- **Setting Frequency and Power (Amplitude)** on page 61
- **Setting ALC Bandwidth Control** on page 63
- **Configuring a Swept Output** on page 64
- **Modulating the Carrier Signal** on page 72
- **Working with Files** on page 74
- **Reading Error Messages** on page 86

## Presetting the Signal Generator



To return the signal generator to a known state, press either **Preset** or **User Preset**.

*Preset* is the factory preset; *User Preset* is a custom preset\*\* (see also, [page 44](#)).

To reset persistent settings (those unaffected by preset, user preset, or power cycle\*), press: **Utility > Power On/Preset > Restore System Defaults**.

**\*Caution**

To avoid the loss of data, GPIB settings, or current user instrument states that have not been permanently saved to nonvolatile memory, the instrument should always be powered down either via the instrument's front panel power button or the appropriate SCPI command. Instrument's installed in rack systems and powered down with the system rack power switch rather than the instrument's front panel switch display a Error -310 due to the instrument not being powered down correctly.

\*\*You can create more than one user preset by giving each saved state file a different name (see [Figure 3-9 on page 84](#)).

## Viewing Key Descriptions



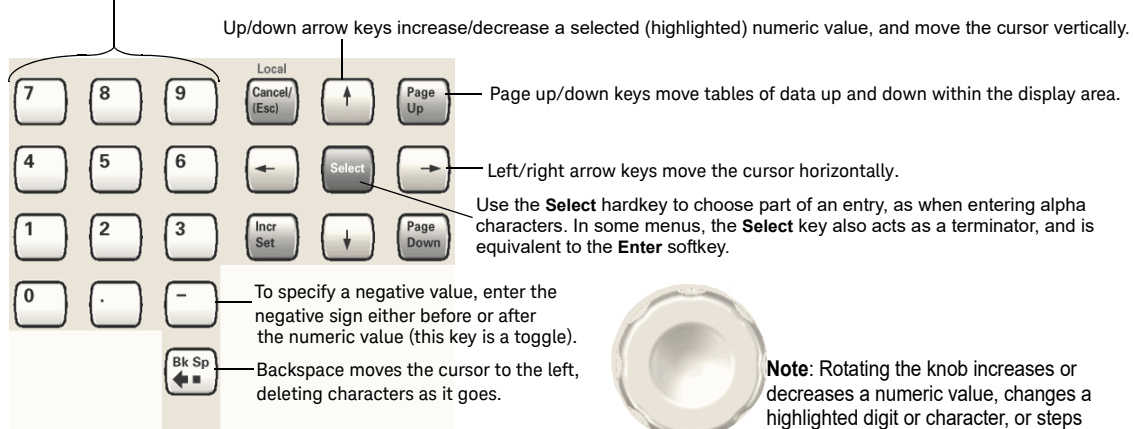
The Help hardkey enables you to display a description of any hardkey or softkey.  
To display help text:

1. Press **Help**.
2. Press the desired key.  
The help displays and the key's normal function does not execute.

## Entering and Editing Numbers and Text

### Entering Numbers and Moving the Cursor

Use the number keys and decimal point to enter numeric data.



**Note:** Rotating the knob increases or decreases a numeric value, changes a highlighted digit or character, or steps through lists or items in a row.

See also "[Front Panel Knob Resolution](#)" on page 44.

For details on each key, see [page 58](#).

### Entering Alpha Characters

Data entry softkeys appear in various menus. If their meaning is not clear in context, use the help key (described on [page 58](#)) to display an explanation. Use the softkey next to the alpha table for help on the table.

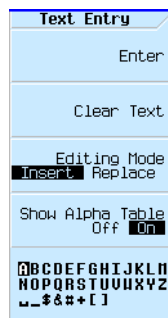
Selecting data that accepts alpha characters, displays one of the menus shown at right.

Use the arrow keys or knob to highlight the desired letter, then press the **Select** hardkey (or the softkey next to the alpha table). To correct errors, use **Bk Sp** or **Clear Text**.

To terminate the entry, press the **Enter** softkey.

A subset of this menu appears for hexadecimal characters. The character menu displays only the letters A through F (use the numeric keypad for other values).

**Note:** File names are limited to 25 characters.



to move the cursor within the active value rather than within the alpha table, turn the alpha table off.

Add/edit comments for saved instrument state files (see [page 80](#)).

## Example: Using a Table Editor

Table editors simplify configuration tasks. The following procedure describes basic table editor functionality using the List Mode Values table editor.

1. Preset the signal generator: Press **Preset**.
2. Open the table editor: Press **Sweep** > **More** > **Configure List Sweep**.

The signal generator displays the editor shown in the following figure.

**Active Function Area**  
 Displays the active item as you edit it.

**Cursor**  
 Highlighting indicates the selected item. To make this the active (editable) item, either press **Select**, or simply enter the desired value.

**Table Editor Name**  
 Current / Total Number of Pages

**Table Items**  
 Table items are also called data fields.

**Table Editor Softkeys**  
 Used to load, navigate, modify, and store table item values. For details on each key, use the key help: Press the **Help** hardkey and then the desired key.

Indicates that another menu is available; to display the second menu, press **More**.

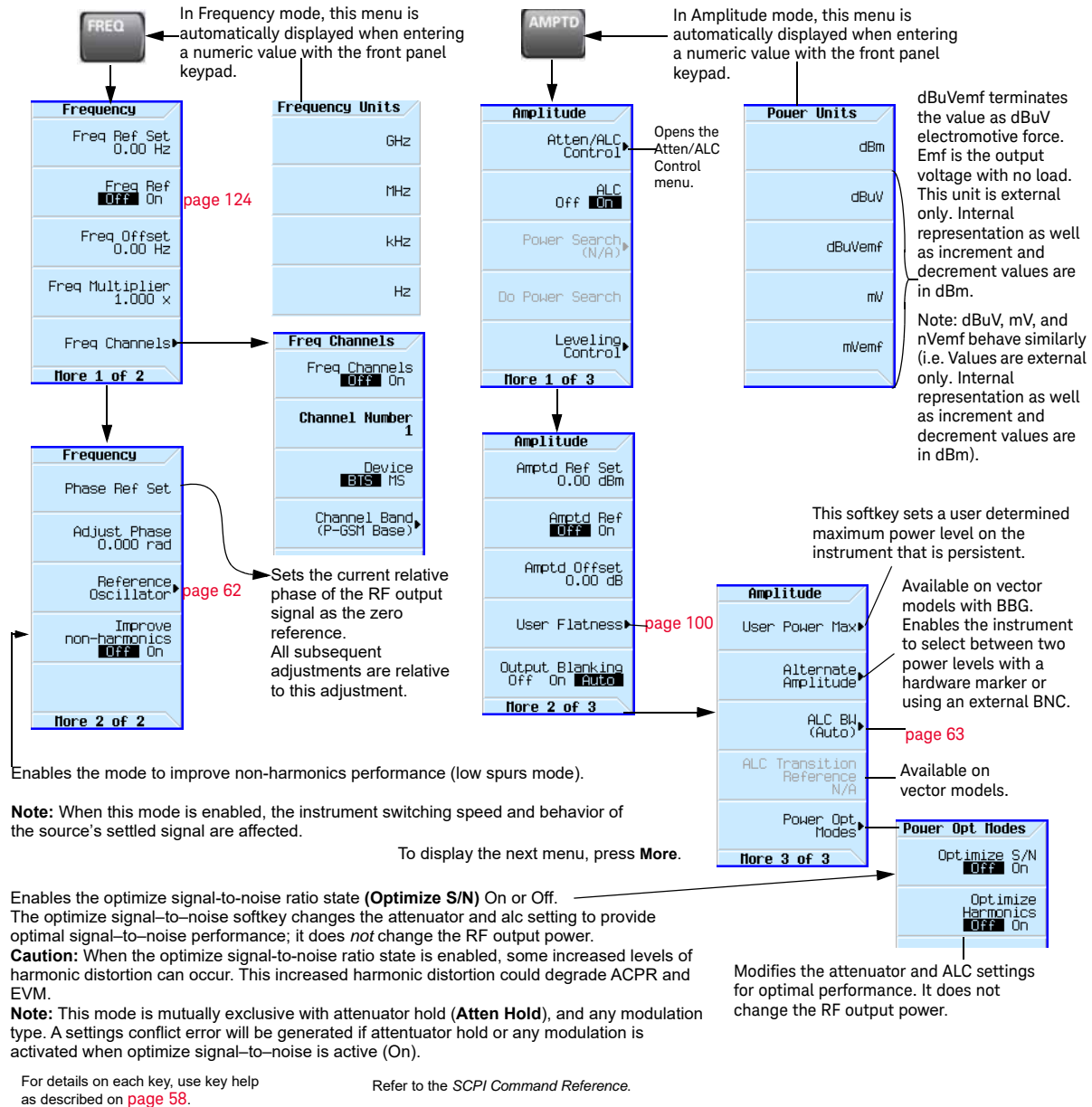
Pg 1/11	Frequency	Power	Waveform	Dwell
1	6.0000000000 GHz	-144.00	-- CW (no modulation)	2.000 ms
2	6.0000000000 GHz	-144.00	-- CW (no modulation)	2.000 ms
3	6.0000000000 GHz	-144.00	-- CW (no modulation)	2.000 ms
4	6.0000000000 GHz	-144.00	-- CW (no modulation)	2.000 ms
5	6.0000000000 GHz	-144.00	-- CW (no modulation)	2.000 ms
6	6.0000000000 GHz	-144.00	-- CW (no modulation)	2.000 ms
7	6.0000000000 GHz	-144.00	-- CW (no modulation)	2.000 ms
8	6.0000000000 GHz	-144.00	-- CW (no modulation)	2.000 ms
9	6.0000000000 GHz	-144.00	-- CW (no modulation)	2.000 ms
10	6.0000000000 GHz	-144.00	-- CW (no modulation)	2.000 ms

3. Highlight the desired item: use the arrow keys or the knob to move the cursor.
4. (Optional) Display the selected item in the active function area: Press **Select**.
5. Modify the value:
  - If the value is displayed in the active function area, use the knob, arrow keys, or numeric keypad to modify the value.
  - If the value is not displayed in the active function area, use the numeric keypad to enter the desired value (which then appears in the active function area).
6. Terminate the entry:
  - If available, press the desired units.
  - If units are not displayed, press either **Enter** (if available) or **Select**.

The modified item is displayed in the table.

# Setting Frequency and Power (Amplitude)

Figure 3-1 Frequency and Amplitude Softkeys



## Example: Configuring a 700 MHz, -20 dBm Continuous Wave Output

### 1. Preset the signal generator.

The signal generator displays its maximum specified frequency and minimum power level (the front panel display areas are shown on [page 25](#)).

### 2. Set the frequency to 700 MHz: Press **Freq** > **700** > **MHz**.

The signal generator displays 700 MHz in both the FREQUENCY area of the display and the active entry area.

### 3. Set the amplitude to -20 dBm: Press **Amptd** > **-20** > **dBm**.

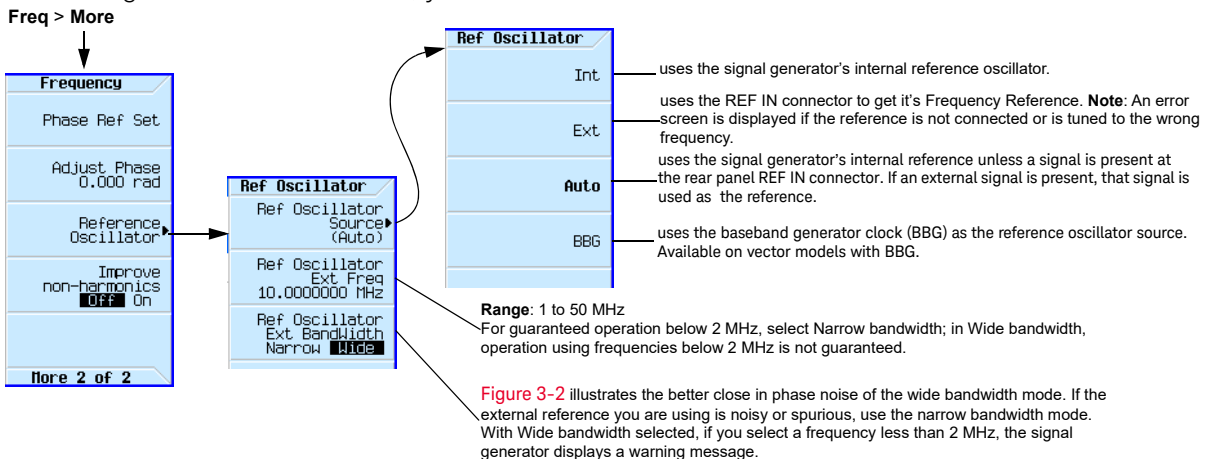
The display changes to -20 dBm in the AMPLITUDE area of the display, and the amplitude value becomes the active entry. Amplitude remains the active function until you press another function key.

### 4. Turn on the RF Output: Press **RF On/Off**.

The RF Output LED lights, and a 700 MHz, -20 dBm CW signal is available at the RF OUTPUT connector.

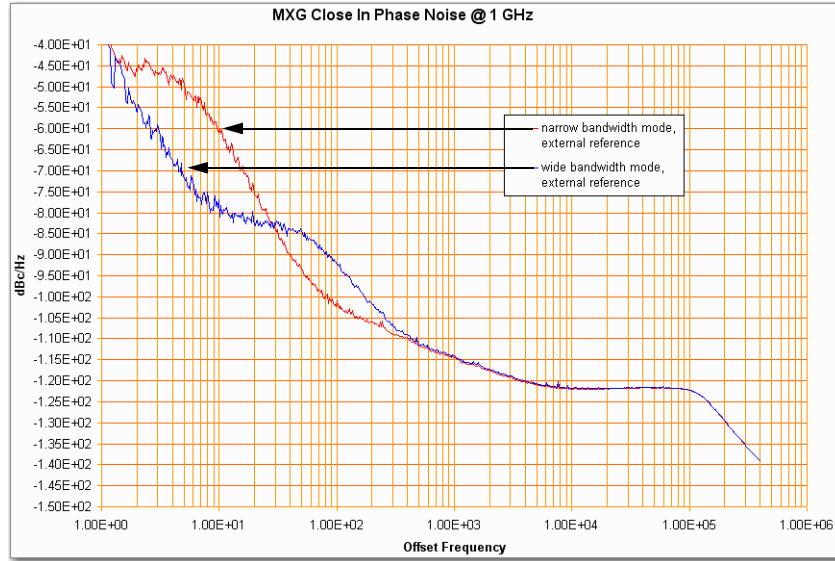
## Using an External Reference Oscillator

When using an external reference, you can select either narrow or wide bandwidth mode.



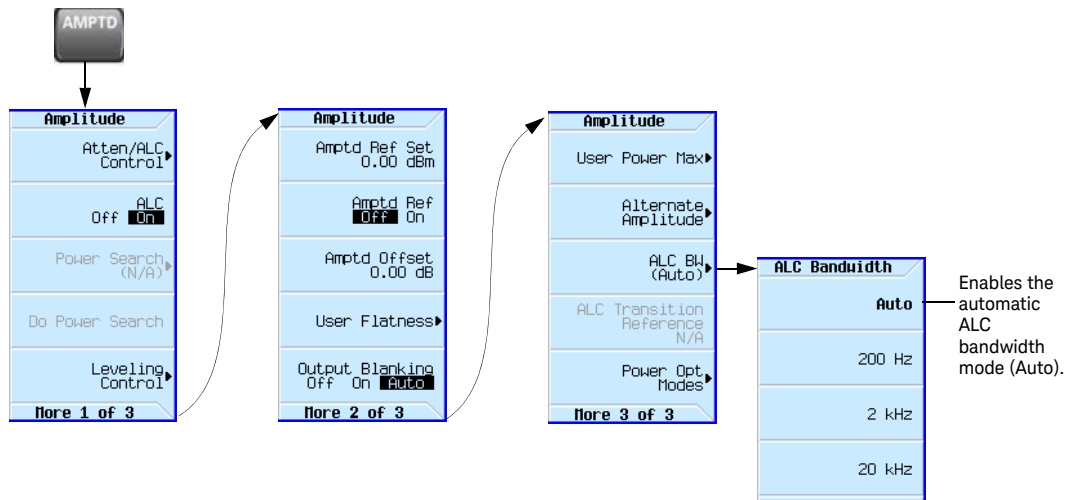
For details on each key, use key help as described on [page 58](#).

Figure 3-2 Using an External Reference Oscillator



## Setting ALC Bandwidth Control

Figure 3-3 Amplitude Softkeys



For details on each key, use key help as described on [page 58](#).

Refer to the SCPI Command Reference.

To display the next menu, press **More**.

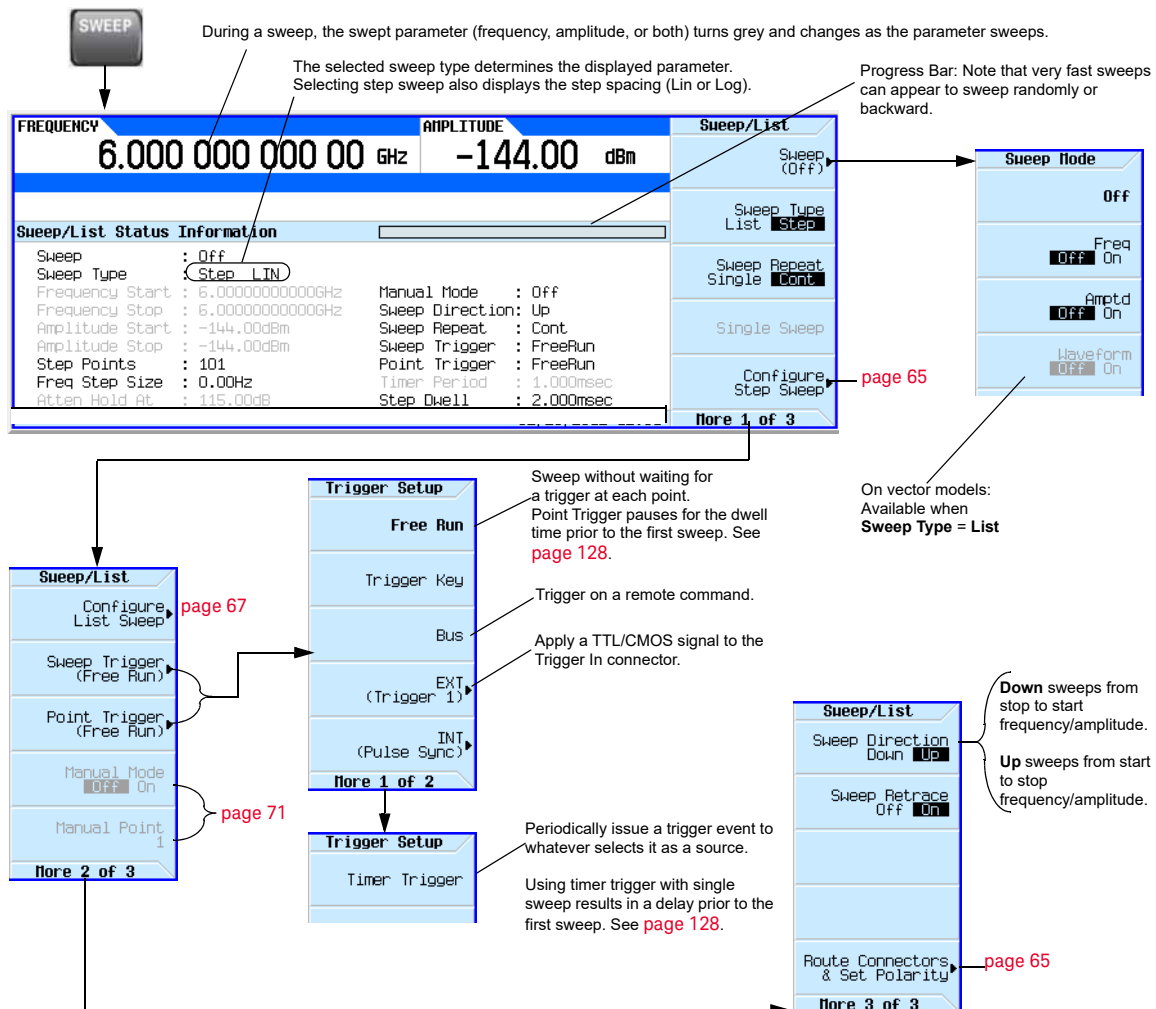
## Configuring a Swept Output

The signal generator has two methods of sweeping through a set of frequency and amplitude points:

**Step sweep** (page 65) provides a linear or logarithmic progression from one selected frequency, amplitude, or both, to another, pausing at linearly or logarithmically spaced points (steps) along the sweep. The sweep can progress forward, backward, or manually.

List sweep (page 67) enables you to enter frequencies and amplitudes at unequal intervals, in nonlinear ascending, descending, or random order. List sweep also enables you to copy the current step sweep values, include an Arb waveform in a sweep (on a vector instrument), and save list sweep data in the file catalog (page 79).

Figure 3-4 Sweep Softkeys



For details on each key, use key help as described on page 58.



## Routing Signals

### Sweep > More > More > Route Connectors

### Step Sweep

Step sweep provides a linear or logarithmic progression from one selected frequency, or amplitude, or both, to another, pausing at linearly or logarithmically spaced points (steps) along the sweep. The sweep can progress forward, backward, or be changed manually.

Figure 3-5 Signal Routing Softkeys

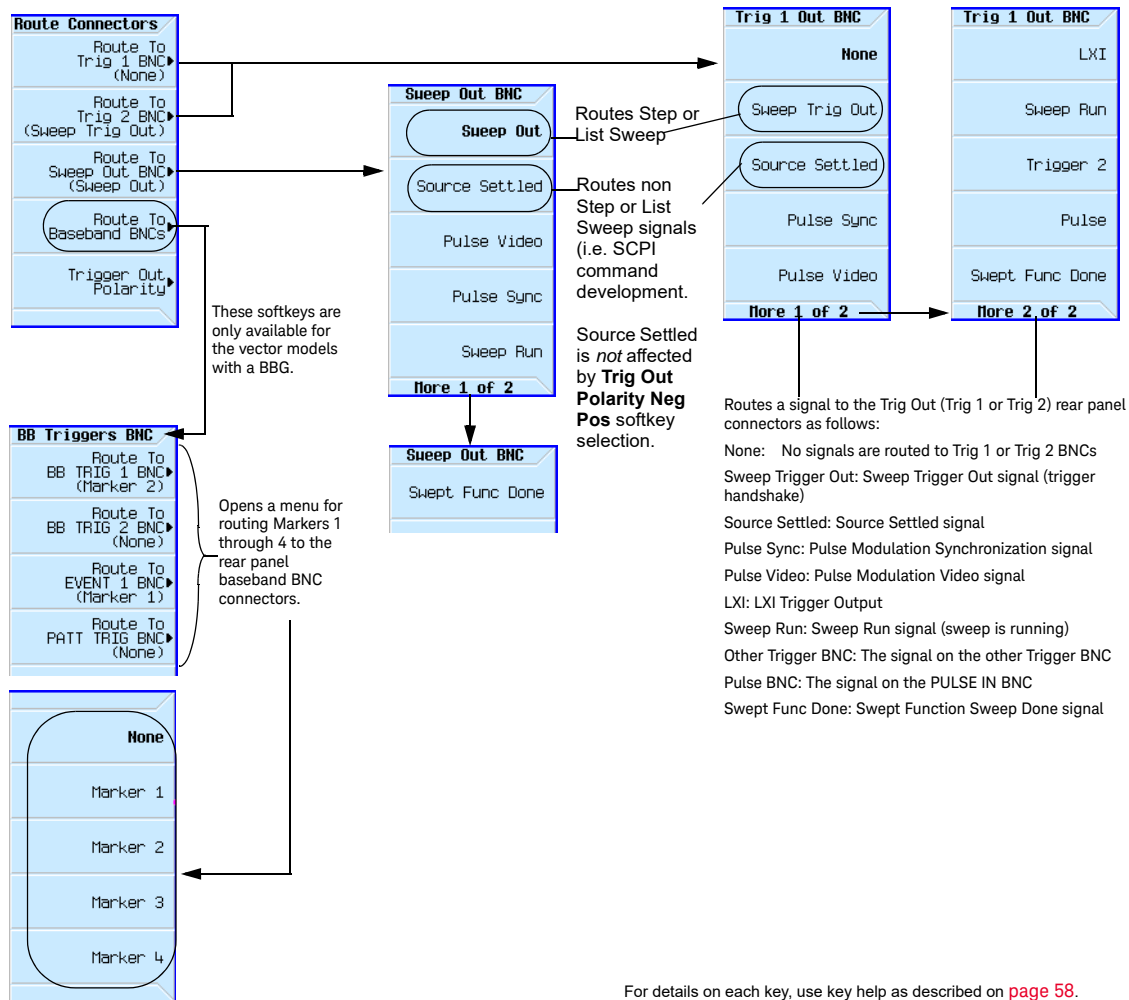
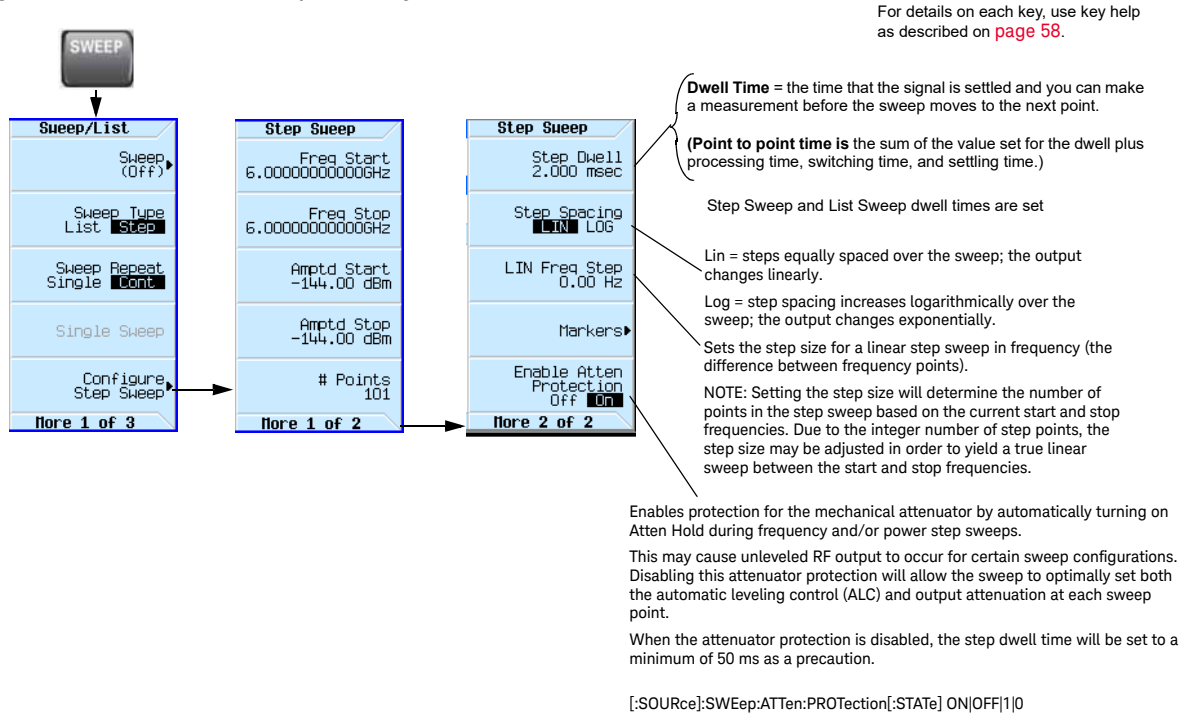


Figure 3-6 Sweep Softkeys



### Example: Configuring a Continuous, Linear Step Sweep

Output: A signal that continuously sweeps from 500 to 600 MHz and from -20 to 0 dBm, with a dwell time of 500 ms at each of six equally spaced points

1. Preset the instrument and open the Sweep/List menu: Press **Preset** > **SWEEP**.

Because continuous is the default sweep repeat selection, and linear is the default step spacing selection, you do not need to set these parameters.

2. Open the step sweep menu: Press **Configure Step Sweep**.
3. Set the following parameters:

Start frequency 500 MHz:	Press <b>Freq Start</b> > <b>500</b> > <b>MHz</b>
Stop frequency 600 MHz:	Press <b>Freq Stop</b> > <b>600</b> > <b>MHz</b>
Amplitude at the beginning of the sweep, -20 dBm:	Press <b>Amptd Start</b> > <b>-20</b> > <b>dBm</b>
Amplitude at the end of the sweep, 0 dBm:	Press <b>Amptd Stop</b> > <b>0</b> > <b>dBm</b> .
6 sweep points:	Press <b># Points</b> > <b>6</b> > <b>Enter</b>
Dwell time at each point, 500 milliseconds:	Press <b>More</b> > <b>Step Dwell</b> > <b>500</b> > <b>msec</b>

4. Sweep both frequency and amplitude: Press **Return** > **Return** > **Sweep** > **Freq Off On** > **Amptd Off On**.

A continuous sweep begins, from the start frequency/amplitude to the stop frequency/amplitude. The SWEEP annunciator displays, and sweep progress is shown in the frequency display, the amplitude display, and the progress bar.

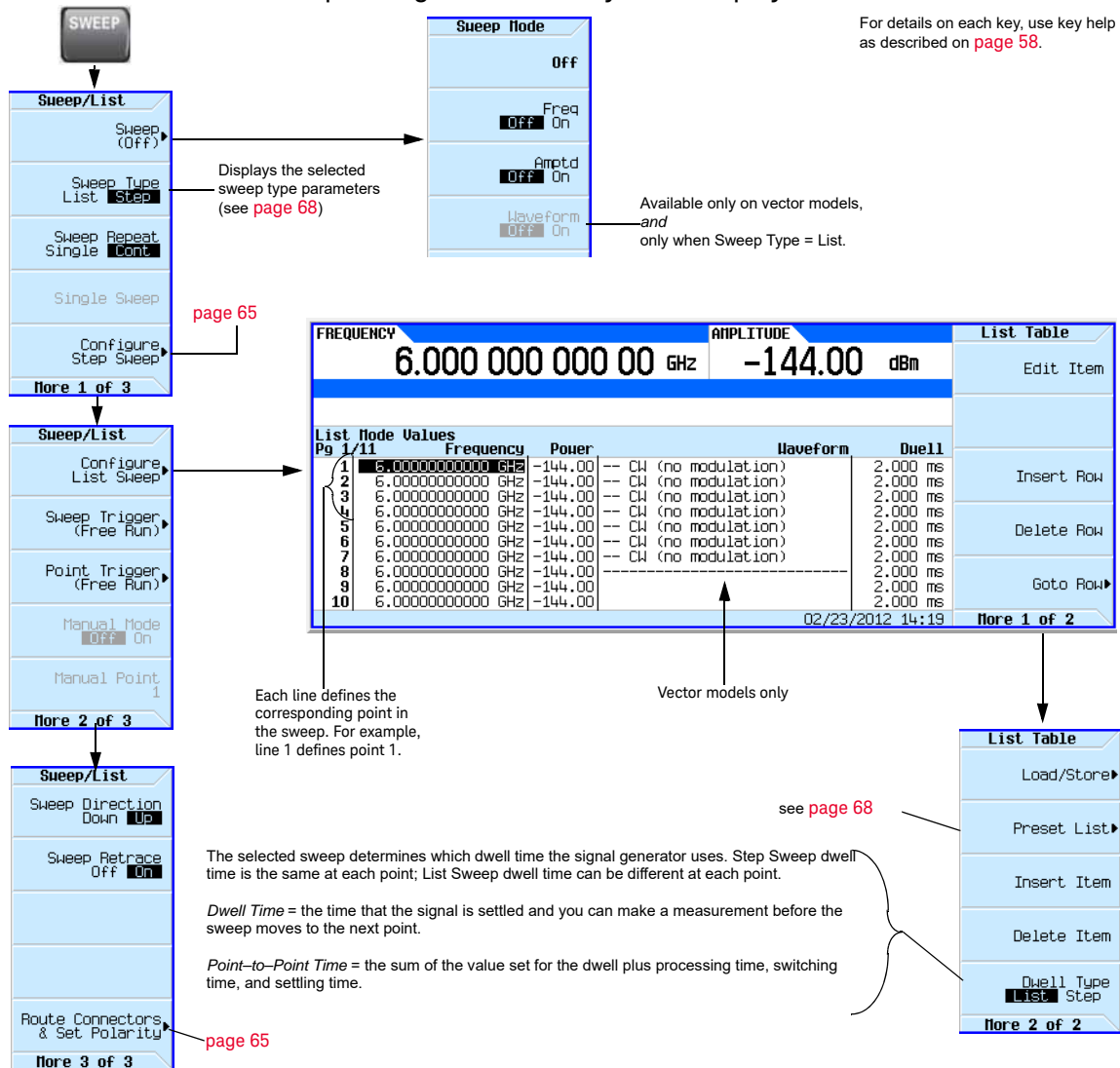
5. Turn the RF output on: Press **RF On/Off**.

The RF LED lights, and the continuous sweep is available at the RF Output connector.

### List Sweep

List sweep enables you to enter frequencies and amplitudes at unequal intervals in nonlinear ascending, descending, or random order. List sweep also enables you to copy the current step sweep values, include a waveform in a sweep (on a vector instrument), and save list sweep data in the file catalog (page 79). Dwell time is editable at each point. For fastest switching speeds, use list sweep.

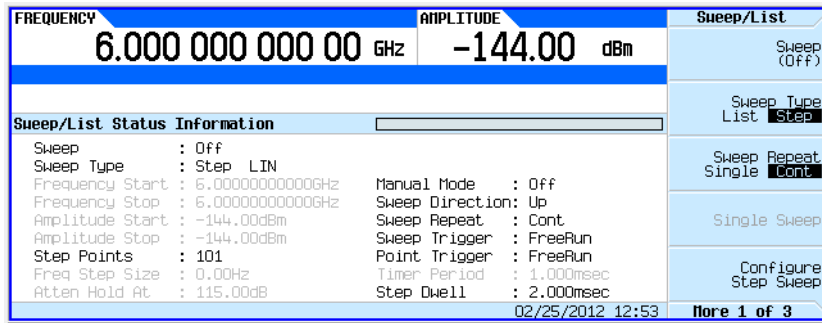
Figure 3-7 List Sweep Configuration Softkeys and Display



### Example: Configuring a List Sweep Using Step Sweep Data

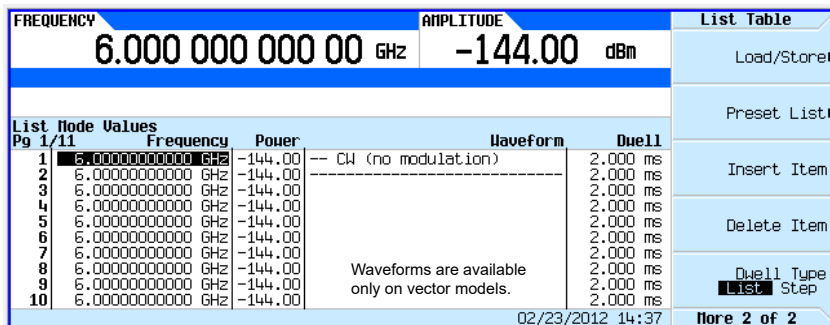
1. Set up the desired step sweep, but do not turn the sweep on. This example uses the step sweep configured on [page 66](#).
2. In the SWEEP menu, change the sweep type to list:  
Press **SWEEP** > **Sweep Type List Step** to highlight List.

The display shows sweep list parameters, as shown below.



3. Open the List Sweep menu: Press **More** > **Configure List Sweep**.
4. Clear any previously set values from the menu and load the points defined in the step sweep into the list: Press **More** > **Preset List** > **Preset with Step Sweep** > **Confirm Preset**.

The display updates with the values loaded from the step sweep, as shown.



#### Vector Models:

Presetting the list clears any previously selected waveforms.

For information on selecting a list sweep waveform, see ["Example: Editing List Sweep Points"](#) on [page 68](#).

5. Sweep frequency and amplitude: Press **SWEEP** (hardkey) > **Sweep** > **Freq Off On** > **Amptd Off On**.

Setting the sweep turns on the sweep function; a continuous sweep begins. On the display, the **SWEEP** annunciator appears, and the progress bar shows the progression of the sweep.

6. If not already on, turn the RF output on: Press **RF On/Off**.

The RF Output LED lights, and a continuous sweep is available at the RF OUTPUT connector.

### Example: Editing List Sweep Points

If you are not familiar with table editors, refer to [page 60](#).

1. Create the desired list sweep. This example uses the list sweep created in the previous example.

2. If sweep is on, turn it off. Editing list sweep parameters with sweep on can generate an error.
3. Ensure that the sweep type is set to list: Press **SWEEP** > **Sweep Type List Step** to highlight List.
4. In the List Mode Values table editor, change the point 1 dwell time (defined in row 1) to 100 ms:
  - a. Press **More** > **Configure List Sweep**.
  - b. Highlight the point 1 dwell time.
  - c. Press **100** > **msec**.

The next item in the table (the frequency value for point 2) highlights.

5. Change the selected frequency value to 445 MHz: Press **445** > **MHz**.
6. Add a new point between points 4 and 5: Highlight any entry in row 4 and press **Insert Row**.

This places a copy of row 4 below row 4, creating a new point 5, and renumbers subsequent rows.

7. Shift frequency values down one row, beginning at point 5: Highlight the frequency entry in row 5, then press **More** > **Insert Item**.

This places a copy of the highlighted frequency value in row 6, shifting the original frequency values for rows 6 and 7 down one row. The new row 8 contains only a frequency value (the power and dwell time entries do not shift down).

8. Change the still active frequency value in row 5 to 590 MHz: Press **590** > **MHz**. The power in row 5 is now the active parameter.
9. Insert a new power value (-2.5 dBm) for point 5, and shift down the original power values for points 5 and 6 by one row: Press **Insert Item** > **-2.5** > **dBm**.
10. To complete the entry for point 8, insert a duplicate of the point 7 dwell time by shifting a copy of the existing value down: Highlight the dwell time in row 7 and press **Insert Item**.
11. For an analog instrument, go to step 14. For a vector instrument, continue with step 12.
12. Select a waveform for point 2:
  - a. Highlight the waveform entry for point 2 and press the **More** > **Select Waveform**.  
The signal generator displays the available waveforms, as shown in the following example.

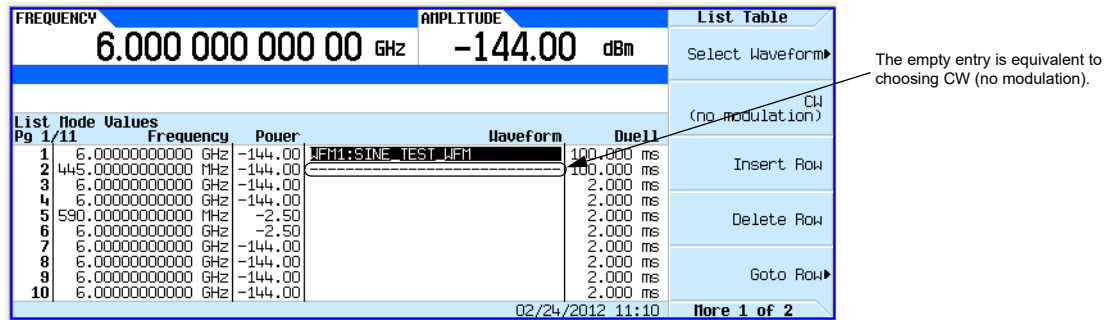
FREQUENCY		AMPLITUDE		Arb Waveform	
6.000 000 000 00 GHz		-144.00 dBm		Select Waveform (WFM1:SINE_TEST_FR)	
				Display Waveform And Markers	
				Waveform Segments	
				CW (no modulation)	
				Goto Row	

Select Pg 1/1    Segment On BBG Media    Points    Sequence On Int Media    Segs  
 RAMP\_TEST\_WFM1    200 Sa    ANTENNA2M1    2097152  
 SINE\_TEST\_WFM1    200 Sa

Either select a waveform, page 58  
 or  
 select no modulation.

- b. Highlight the desired waveform (in this example, SINE\_TEST) and press either the **Select** hardkey or the **Select Waveform** softkey.

13. As desired, repeat step 12 for the remaining points for which you want to select a waveform. The following figure shows an example of how this might look.



14. Turn sweep on:  
Press **Return** > **Return** > **Return** > **Sweep** > **Freq Off On** > **Amptd Off On** > **Waveform Off On**.

15. If it is not already on, turn the RF output on:  
Press **RF On/Off**.

The **SWEEP** annunciator appears on the display, indicating that the signal generator is sweeping, and the progress bar shows the progression of the sweep.

**NOTE**

If the instrument is in manual sweep (page 71), the active row (row 6 in the figure above) is the selected (manual) point, and the signal generator outputs the settings for that selection when the RF output is on.

Example: Using a Single Sweep

1. Set up either a step sweep (page 66) or a list sweep (page 68).
2. In the List/Sweep menu, set the sweep repeat to single:  
Press **Sweep Repeat Single Cont** to highlight Single.  
Sweep does not occur until you trigger it.

Note that the **WINIT** annunciator appears on the display, indicating that the sweep is waiting to be initiated.

3. If not already on, turn the RF output on: Press **RF On/Off**.
4. Initiate the sweep: Press **Single Sweep**.

A single repetition of the configured sweep is available at the RF Output connector.

As the signal generator sweeps, the **SWEEP** annunciator replaces **WINIT** on the display, and the progress bar shows the progression of the sweep.

At the end of the sweep, there is no progress bar, and the **WINIT** annunciator replaces **SWEEP**.

### Example: Manual Control of Sweep

1. Set up either a step sweep (page 66) or a list sweep (page 68).
2. In the Sweep/List menu, select a parameter to sweep: Press **Sweep** > **parameter** > **Return**.
3. Select manual mode: Press **More** > **Manual Mode Off On**.

When you select manual mode, the current sweep point becomes the selected manual point.

4. If it is not already on, turn the RF output on: Press **RF On/Off**.
5. Select the desired point to output: Press **Manual Point** > **number** > **Enter**.

The progress bar changes to indicate the selected point.

6. Use the knob or arrow keys to move from point to point. As you select each point, the RF output changes to the settings in that selection.

The SWMAN annunciator indicates that the sweep is in manual mode.

The currently sweeping parameter stops and displays the selected point.

When you enter a manual point, the progress bar moves to and stops at the selected point.

The parameters of the selected sweep point (point 3 of 6 in this example) define the signal available at the RF Output connector.

When you turn manual mode on, the current sweep point becomes the manual point.

FREQUENCY		AMPLITUDE		Sweep/List	
6.000 000 000 00 GHz		-144.00 dBm		Configure List Sweep ▶	
SWMAN				Sweep Trigger (Free Run) ▶	
Manual Point: 100				Point Trigger (Free Run) ▶	
Sweep/List Status Information		Current Point : 100/104		Manual Mode Off <b>On</b>	
Sweep	: Freq+Amptd	Sweep Speed	: 273pts/sec	Manual Point 100	
Sweep Type	: List	Manual Mode	: On	More 2 of 3	
Frequency Points	: 104	Sweep Direction	: Up		
Amplitude Points	: 104	Sweep Repeat	: Cont		
Waveform Points	: 1	Sweep Trigger	: FreeRun		
Dwell Points	: 104	Point Trigger	: FreeRun		
Dwell Type	: List	Timer Period	: 1.000msec		
Atten Hold At	: 115.00dB	Step Dwell	: 2.000msec		
		02/24/2012 11:18			

## Modulating the Carrier Signal

To modulate the carrier signal, you must have both

- an active modulation format  
**and**
- modulation of the RF output enabled

### Example

1. Preset the signal generator.

2. Turn on AM: Press **AM > AM Off On** (requires Option UNT).

You can turn on the modulation format before or after setting signal parameters.

The modulation format generates, but does not yet modulate the carrier signal.

Once the signal generates, an annunciator showing the name of the format appears, indicating that a modulation format is active.

3. Enable modulation of the RF output: Press the **Mod On/Off** key until the LED lights.

If you enable modulation without an active modulation format, the carrier signal does not modulate until you subsequently turn on a modulation format.

Annunciator indicates active AM modulation

FREQUENCY	AMPLITUDE	AM
6.000 000 000 00 GHz	-144.00 dBm	AM
Analog Modulation Status Information		
AM1	FuncGen1	Depth:0.1% Wfm:Sine(400.0Hz)
AM2	FuncGen1	Depth:0.1% Wfm:Sine(400.0Hz)
AMWB	I Input	Depth:0.5V=100% Wfm:Sine(400.0Hz)
FM1	FuncGen1	Dev:1.0000kHz Wfm:Sine(400.0Hz)
FM2	FuncGen1	Dev:1.0000kHz Wfm:Sine(400.0Hz)
PM1	FuncGen1	Dev:0.000rad Wfm:Sine(400.0Hz)
PM2	FuncGen1	Dev:0.000rad Wfm:Sine(400.0Hz)
LFOut	IntMonitor	Ampl:0.000V Monitored:FuncGen1

Mod On/Off

A lit LED indicates that any active modulation format can modulate the carrier.

AM format on

### NOTE

To turn modulation off, press the **Mod On/Off** key until the LED turns off.

When the **Mod On/Off** key is off, the carrier signal is not modulated, even with an active modulation format.

4. To make the modulated carrier available at the RF output connector, press the **RF On/Off** key until the LED lights.

See also: [“Analog Modulation \(Option UNT\)” on page 177](#)  
[“Pulse Modulation \(Options UNW and N5180320B\)” on page 187](#)  
[“I/Q Modulation” on page 263](#)



## Simultaneous Modulation

**NOTE**

The Keysight X-Series signal generators are capable of simultaneous modulation. All modulation types (AM, FM, fM, Pulse, and I/Q) may be simultaneously enabled, but there are some exceptions. Refer to [Table 3-1](#).

Table 3-1 Simultaneous Modulation Type Combinations

	AM <sup>a</sup>	FM	fM	Pulse <sup>b</sup>	I/Q
AM	--	x	x	x	x
FM	x <sup>c</sup>	--	<b>not applicable</b>	x	x
fM	x <sup>c</sup>	<b>not applicable</b>	--	x	x
Pulse	x	x	x	--	x
I/Q	x	x	x	x	--

- a. Linear AM and Exponential AM **cannot** be enabled simultaneously. Refer to [Chapter 6](#).
- b. Pulse modulation requires Option UNW. Refer to [Chapter 7](#).
- c. FM and fM **cannot** be enabled simultaneously.

## Working with Files

- [File Softkeys](#) on page 75
- [Viewing a List of Stored Files](#) on page 76
- [Storing a File](#) on page 78
- [Loading \(Recalling\) a Stored File](#) on page 79
- [Moving a File from One Media to Another](#) on page 80
- [Working with Instrument State Files](#) on page 80
- [Selecting the Default Storage Media](#) on page 85

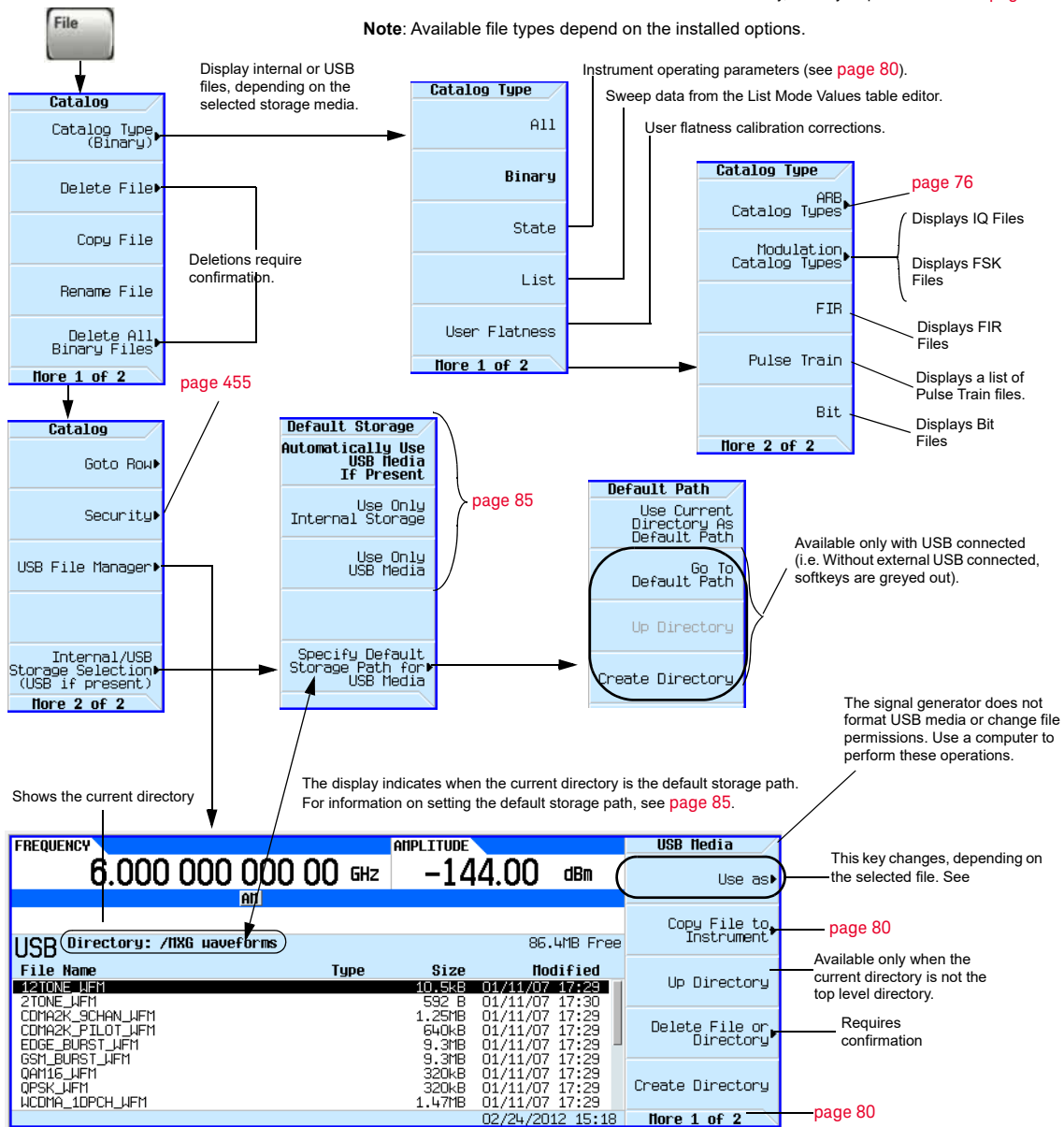
The signal generator recognizes several types of files, such as instrument state files, license files, and list sweep files. Files can be stored either in the signal generator's internal storage or on the USB media. This section provides an overview of how to navigate the signal generator's file menus, and how to view, store, load, and move files.

The Keysight MXG and EXG nonvolatile internal memory is allocated according to a Microsoft compatible file allocation table (FAT) file system. Refer to the **Programming Guide**.

See also: [Storing, Loading, and Playing a Waveform Segment](#) on page 207.

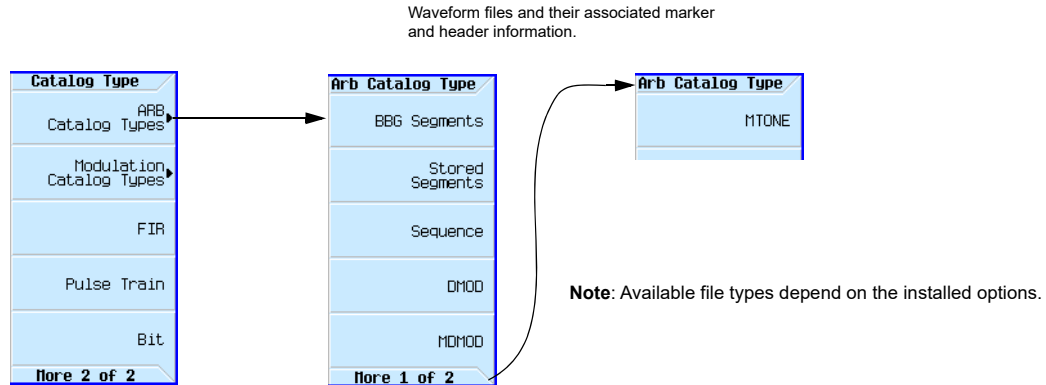
## File Softkeys

For details on each key, use key help as described on [page 58](#).



When you connect USB media to the instrument, the signal generator displays the USB Media menu and the message **External USB Storage attached**. When you disconnect the USB media, the message **External USB Storage detached** displays. When you open the External Media menu without USB media connected, the signal generator displays the message **External Media Not Detected**.

## ARB File Softkeys



For details on each key, use key help as described on [page 58](#).

## Viewing a List of Stored Files

The information in this section is provided with the assumption that default storage media is set to Auto, as described on [page 85](#).

## Viewing a List of Files Stored in the Signal Generator

1. If USB media is connected, disconnect it. The signal generator's storage media switches to internal, so you can now use the file catalogs to see files stored in the signal generator.
2. Select the desired file catalog: Press **File > Catalog Type > desired catalog** (in this example, **All**). The selected files appear in alphabetical order by file name, as shown in the following figure.

The selected file catalog and the storage media

File Name	Type	Size	Modified
1 00_00	STATE	516 B	12/14/11 11:16
2 802_11AC_160MHZ_256Q.WFM	SNVWFM	106kB	10/28/11 13:27
3 802_11AC_80MHZ_256Q.WFM	SNVWFM	53.1kB	10/28/11 13:27
4 ANTENNA2M	SEQ	24MB	10/30/11 20:14
5 FIR_1	FIR	268 B	02/20/12 16:50
6 FMRADIO_1_5G	NVWMP	381MB	10/30/11 19:38
7 FMRADIO_1_5G	NVWFM	1.49GB	10/30/11 19:19
8 FMRADIO_1_5G	NVHDR	173 B	10/30/11 19:38
9 FSK1_FILE	FSK	34 B	11/09/11 11:16
10 FSK2_FILE	FSK	34 B	11/09/11 11:16

02/24/2012 15:44 **More 1 of 2**

## Viewing a list of Files Stored on USB Media

With USB media connected, you can view files on USB media using either the file catalogs, which can display only a selected type of file, or the USB File Manager, which displays all files.

Using the File Catalogs:

- With the USB media connected, select the desired file catalog: press **> Catalog Type > desired catalog**. The selected files appear in alphabetical order by file name.

Using the USB File Manager:

- With USB media connected, open the USB File Manager: press **File > More > USB File Manager**.

The instrument displays the default directory on the USB Media, as shown in the following figure. Note that when you attach USB media, the display goes directly to this menu.

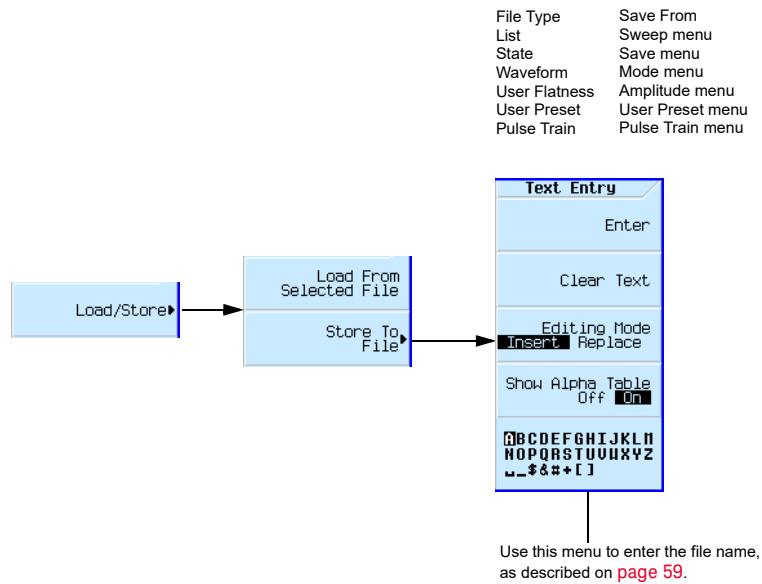
Use the **Page Up** and **Page Down** hardkeys to scroll through the contents of the directory.

FREQUENCY	AMPLITUDE	USB Media	
6.000 000 000 00 GHz	-144.00 dBm	Use as▶	
All		Copy File to Instrument▶	
USB Directory: /MXG waveforms		86.4MB Free	
File Name	Type	Size	Modified
2TONE_WFM		10.5KB	01/11/07 17:29
ZTONE_WFM		592 B	01/11/07 17:30
CDMA2K_SCHAN_WFM		1.25MB	01/11/07 17:29
CDMA2K_PILOT_WFM		640KB	01/11/07 17:29
EDGE_BURST_WFM		9.3MB	01/11/07 17:29
GSM_BURST_WFM		9.3MB	01/11/07 17:29
QAM16_WFM		320KB	01/11/07 17:29
QPSK_WFM		320KB	01/11/07 17:29
WCDMA_1DPCCH_WFM		1.47MB	01/11/07 17:29
		Create Directory	
		More 1 of 2▶	

## Storing a File

Several menus enable you to store instrument parameters. For example, you can store instrument states, lists, and waveforms.

- An instrument state file contains instrument settings. For this type of file, use the **Save** hardkey shown in [Figure 3-8 on page 81](#).
- For other types of data, use the **Load/Store** softkey (shown below) that is available through the menu used to create the file.



For details on each key, use key help as described on [page 58](#).

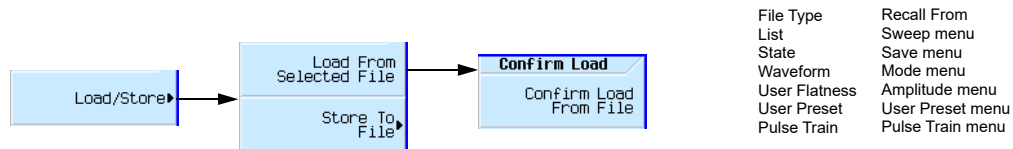
### File Length (including extension)

Internal Media:	25 characters
USB Media:	39 characters

## Loading (Recalling) a Stored File

There are several ways to load (recall) a stored file.

- For an instrument state file, use the **Recall** hardkey shown in [Figure 3-8 on page 81](#).
- For other types of data, use the **Load/Store** softkey (shown below) that is available through the menu used to create the file.

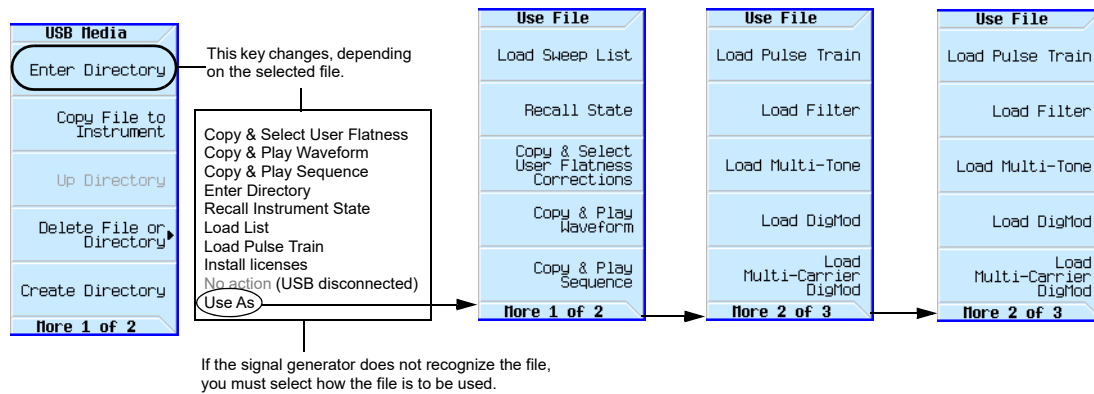


## Loading a File From USB Media

To load a file from USB media, use the USB file manager shown below.

**File > Catalog Type > <type> > More > USB File Manager**  
or  
**File > More > USB File Manager**  
or  
Insert the USB media

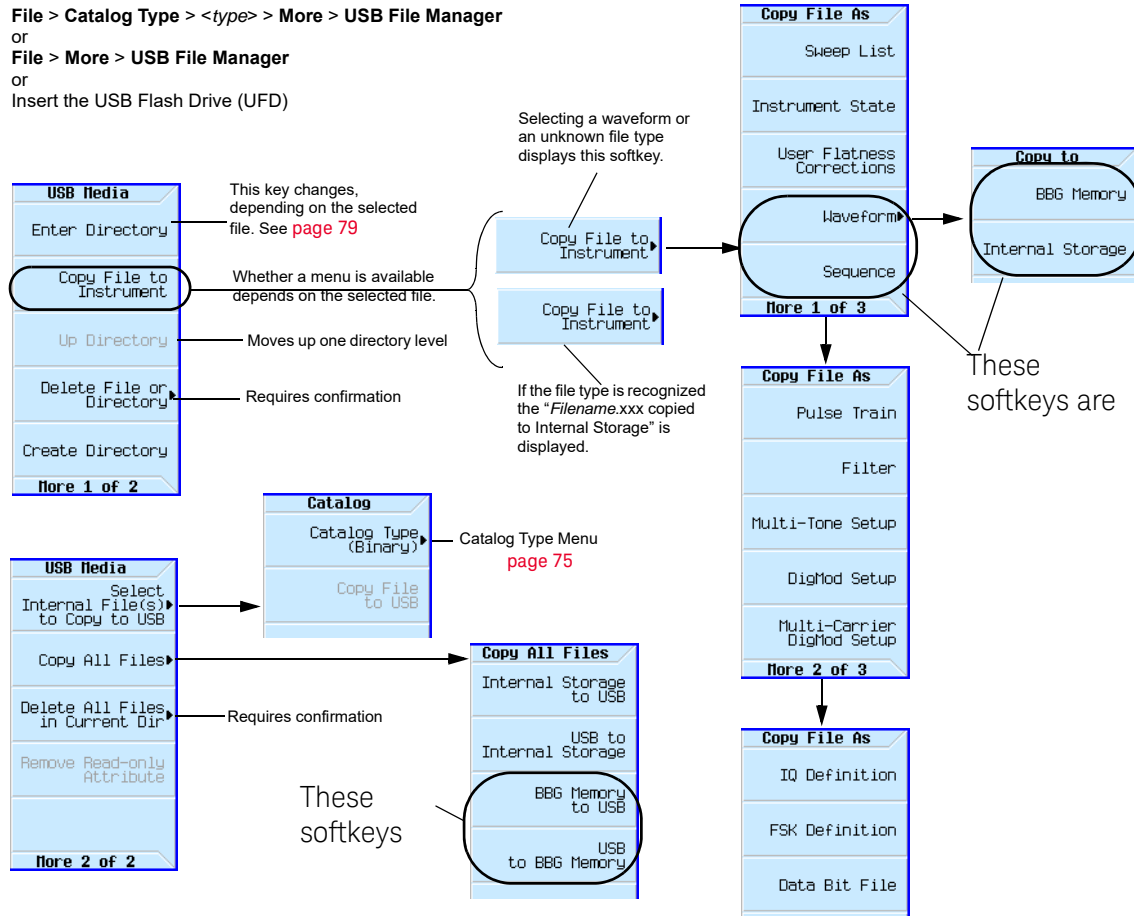
File Type	Extension	Pressing Select with file highlighted...
List	.list	loads list and starts sweep
State	.state	load instrument state
Waveform	.waveform	loads and plays waveform
User Flatness	.uflat	loads and applies user flatness
User Preset	.uprst	loads and executes user preset
License	.lic	installs purchased license
Pulse Train	.ptrain	loads and applies pulse train



For details on each key, use key help as described on [page 58](#).

## Moving a File from One Media to Another

Use the USB Media Manager to move files between USB and internal media.



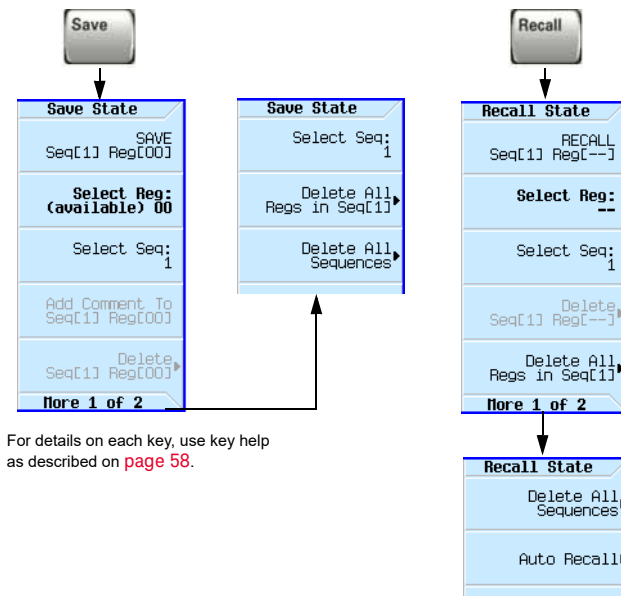
For details on each key, use key help as described on [page 58](#).

## Working with Instrument State Files

- [Saving an Instrument State](#) on page 82
- [Saving a User Preset](#) on page 82
- [Recalling an Instrument State](#) on page 82
- [Recalling an Instrument State and Associated Waveform File](#) on page 83
- [Recalling an Instrument State and Associated List File](#) on page 83
- [Moving or Copying a Stored Instrument State](#) on page 84



Figure 3-8 Save and Recall Softkeys



When saved to the signal generator, instrument settings (states) save to instrument state memory\*. Instrument state memory is divided into 10 sequences (0 through 9); each sequence comprises 100 registers (00 through 99).

Delete softkeys in the **Save** and **Recall** menus enable you to delete the contents of a specific register, or the contents of all sequences in the state file catalog.

The signal generator requires that you confirm a deletion.

**\*Caution**

To avoid the loss of data, GPIB settings, or current user instrument states that have not been permanently saved to nonvolatile memory, the instrument should always be powered down either via the instrument's front panel power button or the appropriate SCPI command. instrument's installed in rack systems and powered down with the system rack power switch, rather than the instrument's front panel switch display a Error -310 due to the instrument not being powered down correctly.

Table 3-2

**The following information is not stored in a state file:**

System Security Level	Sweep lists	Hostname	Remote Language	Step increment values
System Security Level Display	Pulse Train lists	IP Address	FTP Server	ARB Files
System Security Level State	Display State On/Off	Subnet Mask	Manual DHCP	MAC
Web Server (HTTP)	Files	Default Gateway	VXI-11 SCPI	User Power Correction
Sockets SCPI (TELNET)	I/Q Calibration Data			

## Saving an Instrument State

1. Preset the signal generator and set the following:

· Frequency: 800 MHz      · Amplitude: 0 dBm      · RF: on

2. (Optional, vector models only) Associate a waveform file with these settings:
  - a. Press **Mode** > **Dual ARB** > **Select Waveform**.
  - b. Highlight the desired file and press **Select Waveform**. If the file is not listed, you must first move it from internal or external media to BBG media, see [page 207](#).
3. Select the desired memory sequence (for this example, 1): Press **Save** > **Select Seq** > **1** > **Enter**.
4. Select the desired register (in this example, 01): Press **Select Reg** > **1** > **Save Reg**.

If a waveform is currently selected, saving the instrument state also saves a pointer to the waveform file **name**.

5. Add a descriptive comment to sequence 1 register 01:

Press **Add Comment to Seq[1] Reg[01]**, enter the comment and press **Enter**. The comment appears in the Saved States list when you press **Recall**. If the instrument state has an associated waveform, entering the waveform name in the comment makes it easy to identify which instrument state applies to which waveform.

## Saving a User Preset

A user preset is a special type of instrument state file.

1. Preset the signal generator and set as desired.
2. Press **User Preset** > **Save User Preset**.

This saves a state file named USER\_PRESET, which the signal generator recognizes as containing user preset information.

You can set up several preset conditions under different names:

1. After you save a user preset, rename it to something other than USER\_PRESET (see [page 84](#)).
2. Save as many user presets as you wish, renaming the USER\_PRESET file each time.
3. Give the desired file the name USER\_PRESET.

## Recalling an Instrument State

1. Preset the signal generator.
2. Press **Recall**.

The **Select Seq** softkey shows the last sequence used, and the display lists any states stored in the registers in that sequence; **RECALL Reg** is the active entry.

3. Select the desired instrument state:

If the desired state is listed in the currently selected sequence, press **desired number** > **Enter**. If not, press **Select Seq** > **desired number** > **Enter** > **RECALL Reg** > **desired number** > **Enter**.

### Recalling an Instrument State and Associated Waveform File

1. Ensure that the desired waveform file exists, and that it is in BBG media (page 207).

If the waveform file is not in BBG media, this procedure generates an error.

Recalling an instrument state with an associated waveform file recalls only the waveform **name**. It does not recreate the waveform file if it was deleted, or load the file into BBG media if it is in internal or USB media.

2. Recall the desired instrument state (see previous example).
3. View the waveform file name recalled with the instrument state: press **Mode** > **Dual ARB**.

The name is displayed as the selected waveform.

4. Turn on the waveform file: Press **Mode** > **Dual ARB** > **ARB Off On**.

### Recalling an Instrument State and Associated List File

Recalling an instrument state recalls only the list sweep setup. It does not recall the frequency and/or amplitude values. Because you must load the list file from the file catalog, when you store a list file, be sure to give it a descriptive name (up to 25 characters).

1. Recall the desired instrument state (see previous example).
2. Load the desired list file:
  - a. Press **Sweep** > **More** > **Configure List Sweep** > **More** > **Load/Store**.
  - b. Highlight the desired file and press **Load From Selected File** > **Confirm Load From File**.

### Editing The Comment on an Instrument Comment

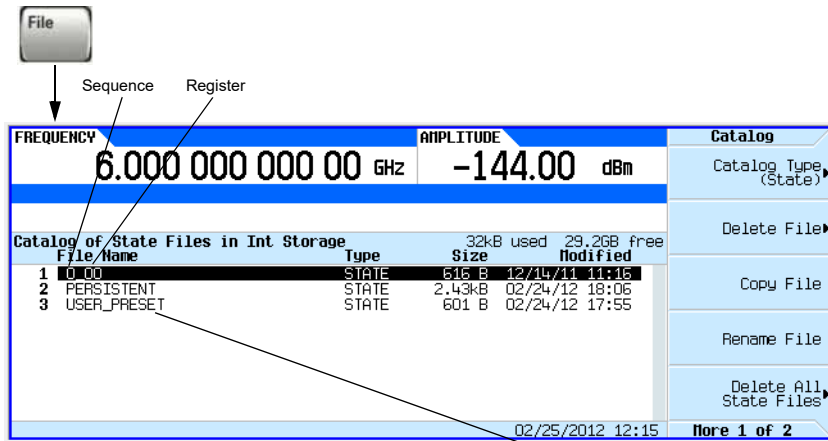
Use the following steps to change a comment on an instrument state saved using the **Save** key. This is **not** the file name that appears in the State catalog (which is the file's memory location).

1. Press **Save**
2. Highlight the desired register
3. Press **Edit Comment In Seq[n] Reg [nn]**.
4. Press **Re-SAVE Seq[n] Reg[nn]**.

This overwrites previously saved instrument state settings with the new comment.

## Moving or Copying a Stored Instrument State

Figure 3-9 Instrument State File Catalog



The signal generator recognizes only the file named USER\_PRESET as user preset information (page 82).

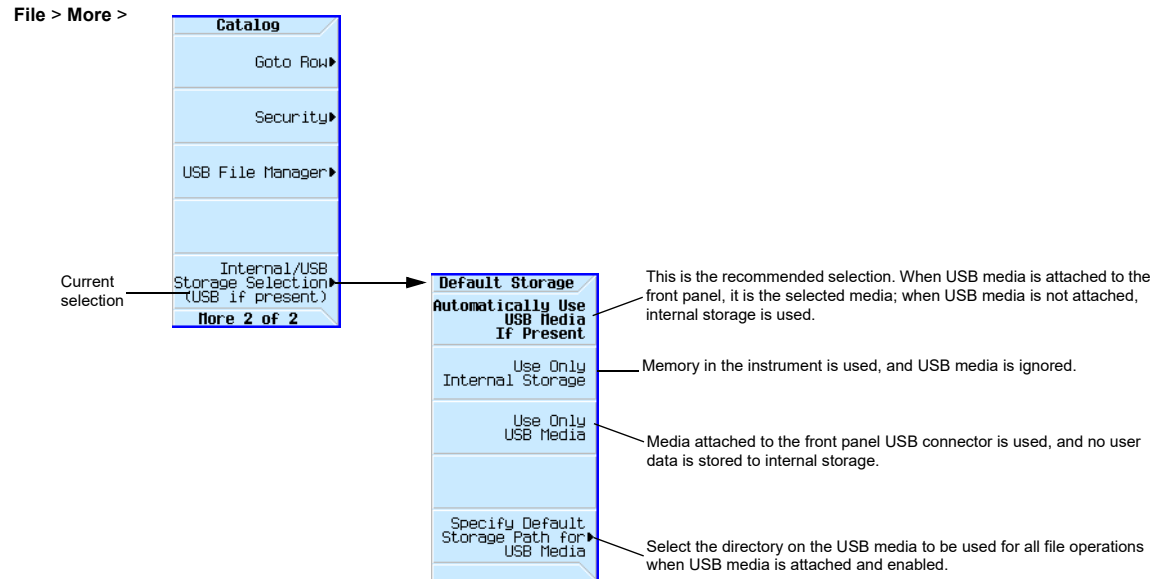
A user-created state file's default name is its memory location (sequence and register).

To move the file, rename it to the desired sequence and register; you can not give a file the same name as an existing file. If you rename a state file to something other than a valid sequence/register name, the file does not appear in either the Save or Recall menu.

## Selecting the Default Storage Media

You can configure the signal generator to store user files to either the internal storage or to external USB media. To automatically switch between USB media and internal storage, depending on whether USB media is attached, select **Automatically Use USB Media If Present**. To avoid storing any confidential information in the instrument, select **Use Only USB Media**. To avoid storing any confidential information to USB media, select **Use Only Internal Storage**.

This selection is unaffected by a power cycle or preset.



For details on each key, use key help as described on [page 58](#).

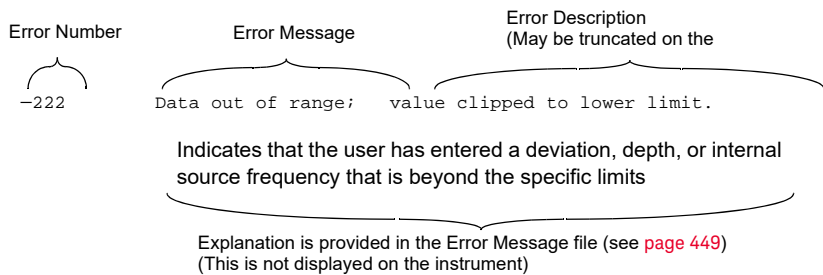
## Reading Error Messages

If an error condition occurs, the signal generator reports it to both the front panel display error queue and the SCPI (remote interface) error queue. These two queues are viewed and managed separately; for information on the SCPI error queue, refer to the **Programming Guide**.

Characteristic	Front Panel Display Error Queue
Capacity (#errors)	30
Overflow Handling	Drops the oldest error as each new error comes in.
Viewing Entries	Press: <b>Error</b> > <b>View Next</b> (or <b>Previous</b> ) <b>Error Page</b>
Clearing the Queue	Press: <b>Error</b> > <b>Clear Error Queue(s)</b>
Unresolved Errors <sup>a</sup>	Re-reported after queue is cleared.
No Errors	When the queue is empty (every error in the queue has been read, or the queue is cleared), the following message appears in the queue: No Error Message(s) in Queue 0 of 0

a. Errors that must be resolved. For example, unlock.

## Error Message Format



The annunciator indicates an unviewed message.

new indicates a message generated since messages were last viewed.

Message number and longer description

Error messages appear in the lower left corner of the display as they occur.

Modulation Status Information					
Mod	State	Depth/Dev	Source	Rate	Wavefo
AM	Off	0.1%	Internal	400.0Hz	Sine
<b>FM</b>	<b>On</b>	<b>1.0000kHz</b>	<b>Internal</b>	<b>400.0Hz</b>	<b>Sine</b>
PM	Off	0.000rad	Internal	400.0Hz	Sine
Pulse	Off	2.00us	Internal	4.00us	Pre
Burst	Off		Int		
I/Q	Off		Internal		

Error Queue		Error Info
2.000 000 000 00 GHz	-144.00 dBm	View Previous Error Page
<b>ERR</b>	<b>ERR</b>	View Next Error Page
-221, Settings conflict; Enabled modulation source conflicts with previously enabled modulation source. Previous modulation disabled.		Clear Error Queue(s)
		1 of 1 (new)

\*\*\* PROTO CODE \*\* NOT FOR CUSTOMER USE \*\*\* 04/06/2006 10:12

## 4 Optimize Performance

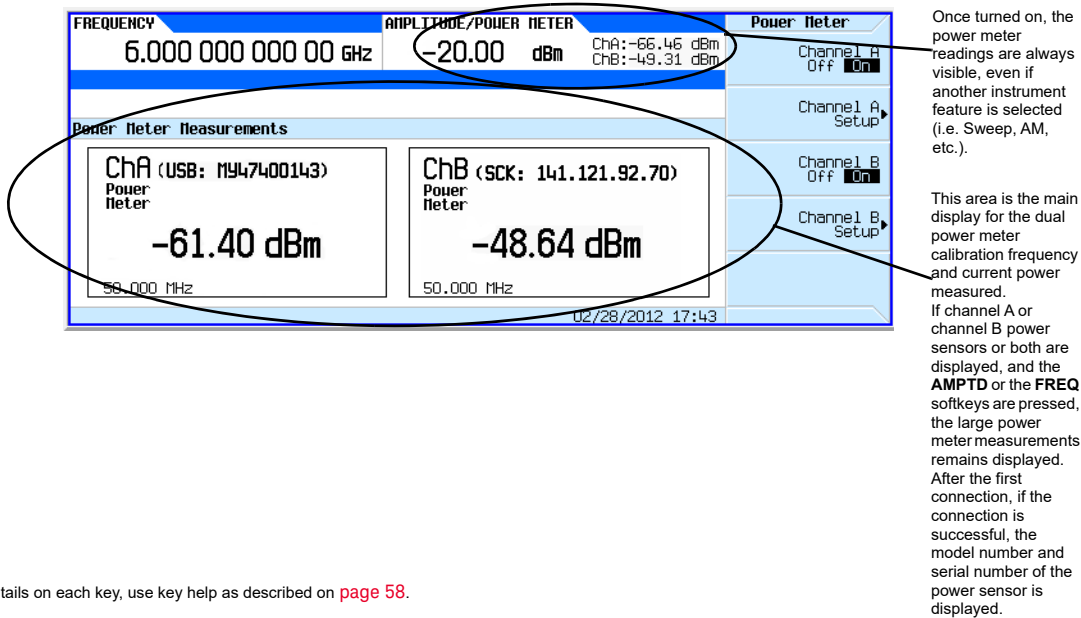
Before using this information, you should be familiar with the basic operation of the signal generator. If you are not comfortable with functions such as setting the power level and frequency, refer to **Chapter 3, “Basic Operation”, on page 57** and familiarize yourself with the information in that chapter.

- **Using the Dual Power Meter Display** on page 88
- **Using the USB Pass Through Commands** on page 95
- **Using the Power Meter Servo** on page 97
- **Using Flatness Correction** on page 100
- **Using Internal Channel Correction (N5172B/82B Only)** on page 109
- **Using External Leveling (N5173B/83B Only)** on page 113
- **Using Unleveled Operating Modes** on page 120
- **Using an Output Offset, Reference, or Multiplier** on page 124
- **Using Free Run, Step Dwell, and Timer Trigger** on page 128
- **Using a USB Keyboard** on page 130

## Using the Dual Power Meter Display

The dual power meter display can be used to display the current frequency and power of either one or two power sensors. The display outputs the current frequency and power measured by the power sensors in the larger center display and in the upper right corner of the display. Refer to [Figure 4-2](#), [Figure 4-2](#), and [Figure 4-3](#).

Figure 4-1 Dual Power Meter Display with Power Sensors A and B Calibrated



For details on each key, use key help as described on [page 58](#).

Figure 4-2 Dual Power Meter Display Menu

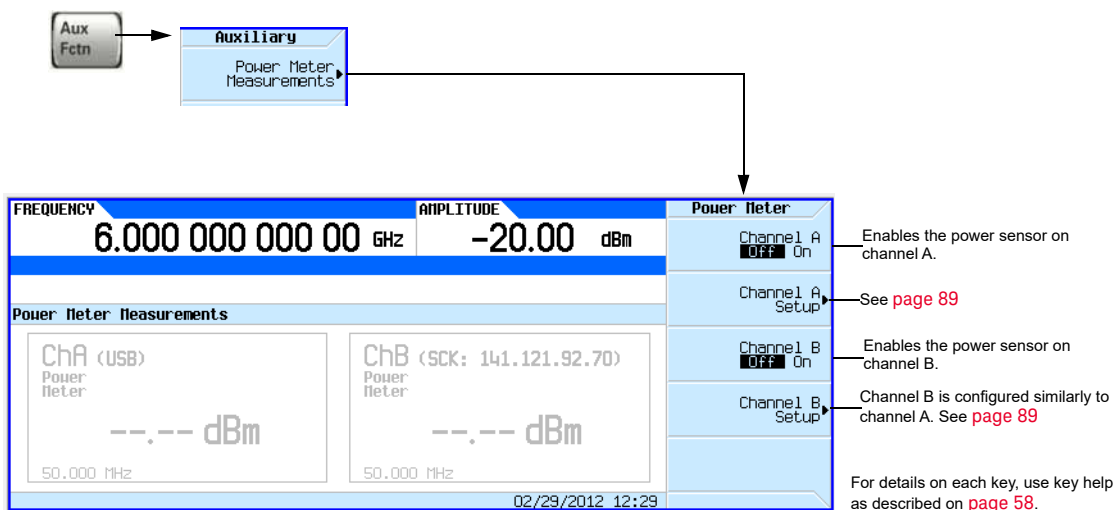
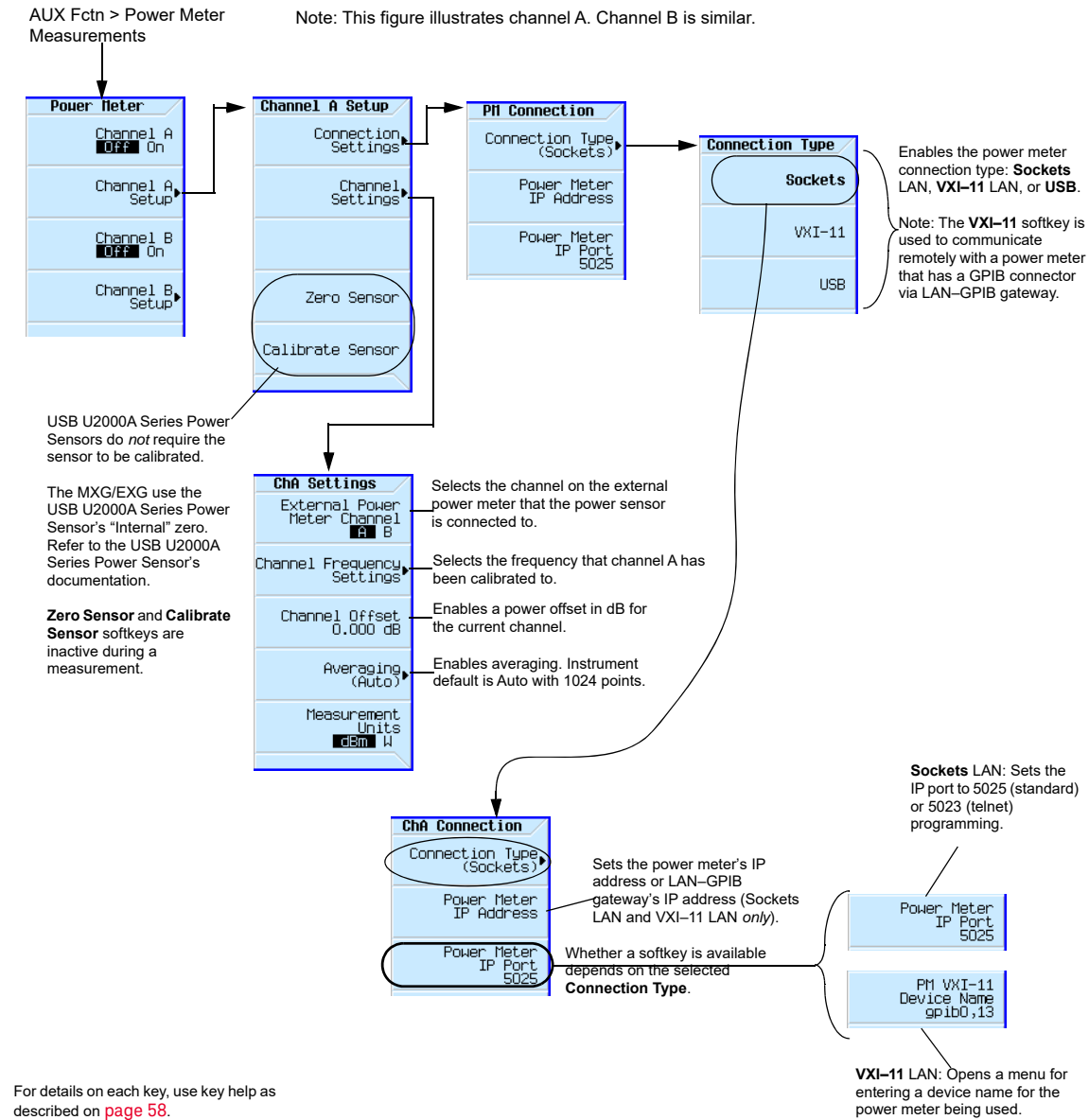




Figure 4-3 Configuring the Power Sensor Channels



For details on each key, use key help as described on [page 58](#).

### Example: Dual Power Meter Calibration

In the following example a U2004A USB Power Sensor is connected to channel A and a N1912A P-Series Power Meter and 8482A Power Sensor are connected to channel B and are zeroed and calibrated, as required.

On the signal generator:

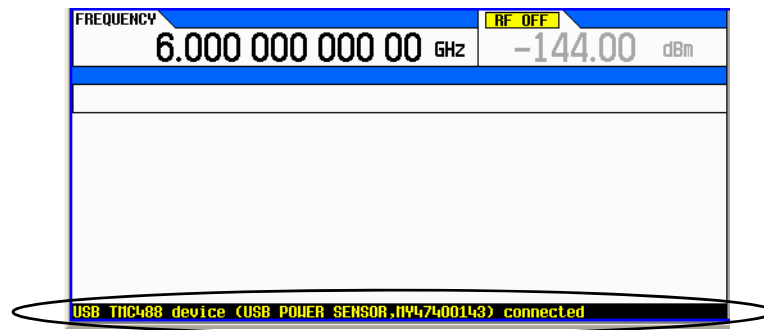
1. Setup for Step Sweep. “Configuring a Swept Output” on page 64.

**CAUTION**

Verify RF Output power is off before continuing.

2. Connecting the Channel A power sensor: Connect USB sensor to the signal generator. The MXG/EXG should display a message across the bottom that reads similar to:  
USB TMC488 device (USB POWER SENSOR,MY47400143) connected

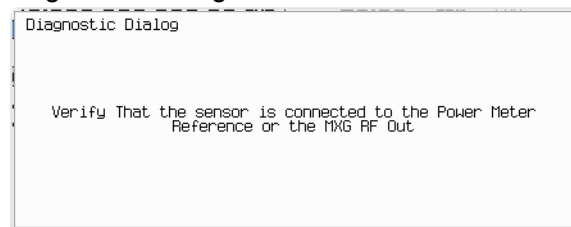
**Figure 4-4** MXG/EXG Displays Connection to U2000 USB Power Sensor



3. Press **Aux Fctn** > **Power Meter Measurements** > **Channel A Setup** > **Connection Settings** > **Connection Type** > **USB Device (None)** > USB POWER SENSOR (MY47400143)
4. Press **Return** > **Zero Sensor**

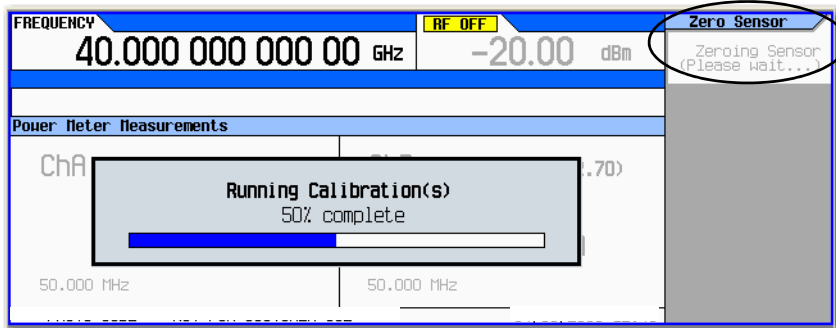
A diagnostic dialog box appears the **initial** time that a U2000 Series power sensor with a different serial number is connected to the signal generator (refer to [Figure 4-5](#)). After the U2000 has been recognized by the signal generator, the U2000 power sensor is saved as a softkey in the instrument and the dialog box in [Figure 4-5](#) won't be displayed (press **DONE**, if you see this message).

**Figure 4-5** Diagnostic Dialog Box for USB Sensor



A Running Calibration(s) bar is displayed on the signal generator. Refer to [Figure 4-6 on page 91](#).

**Figure 4-6** Running Calibration(s) Bar (Zeroing Sensor)

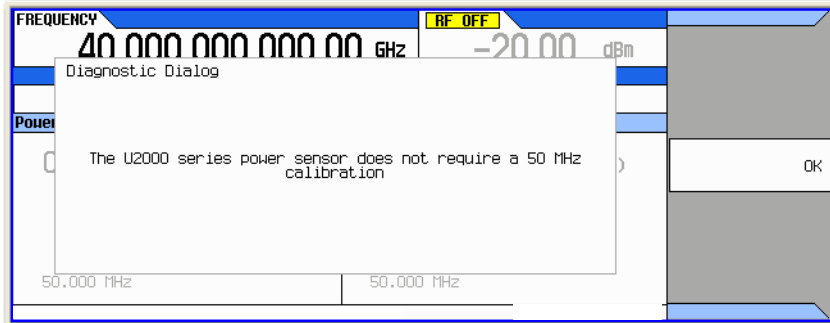


For details on each key, use key help as described on page 58.

**NOTE**

The U2000 Series USB Power Sensor, does **not** require a 50 MHz calibration. If a calibration is attempted with the U2000 Series Power Sensors, the signal generator displays a message reading:  
The U2000 series power sensor does not require a 50 MHz calibration. Refer to **Figure 4-7** on page 91.

**Figure 4-7** Diagnostic Dialog Box Displayed for U2000 Power Sensor

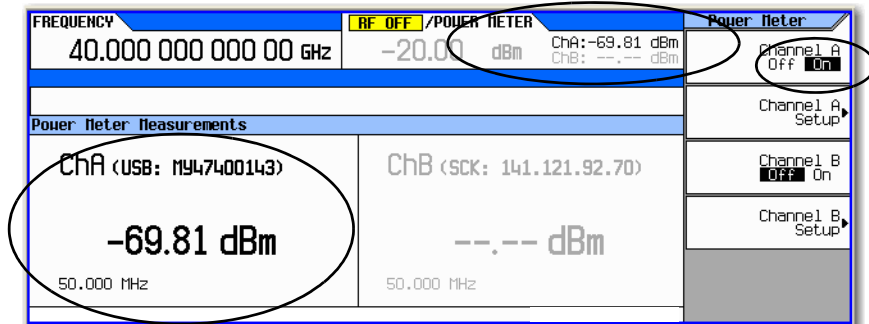


For details on each key, use key help as described on page 58.

**5. Press Return > Return > Channel A to On**

The current power meter sensor reading should be displayed in the ChA portion of the instrument's display and in the upper right portion of the display under Power Meter. Refer to **Figure 4-8**.

**Figure 4-8** Channel A Power Sensor Displayed on MXG/EXG



For details on each key, use key help as described on page 58.

6. On the N1912A P-Series Power Meter (**Channel B power sensor**): Connect the N1912A P-Series Power Meter to the LAN.
7. Connect the power meter sensor to channel B of the power meter.

**NOTE**

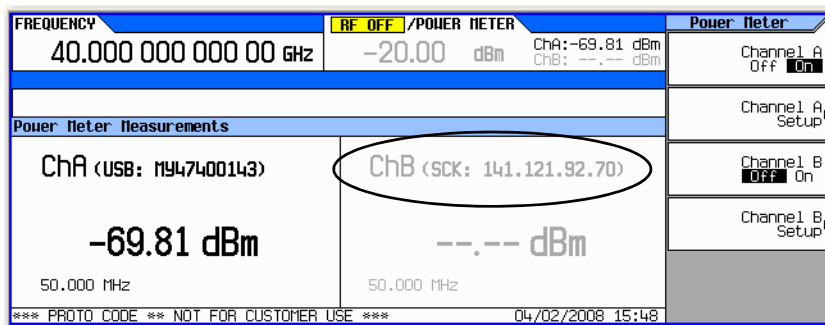
It is recommended, but not required to use the channel B on the N1912A. This provides continuity with the signal generator's dual display. For this example, the U2004A has already used up the channel A position on the signal generator.

8. Connect the power sensor input to the 50 MHz reference of the power meter.
9. Press **Channel B Setup**
10. Press **Connection Settings > Sockets**
11. Press **IP Address > IP address > Enter**

**NOTE**

The IP address of the power meter should be displayed in the ChB section of the display.

**Figure 4-9** Channel B Power Sensor with IP Address Entered



For details on each key, use key help as described on page 58.

12. Press **Return > Channel Settings > External Power Meter Channel to B.**

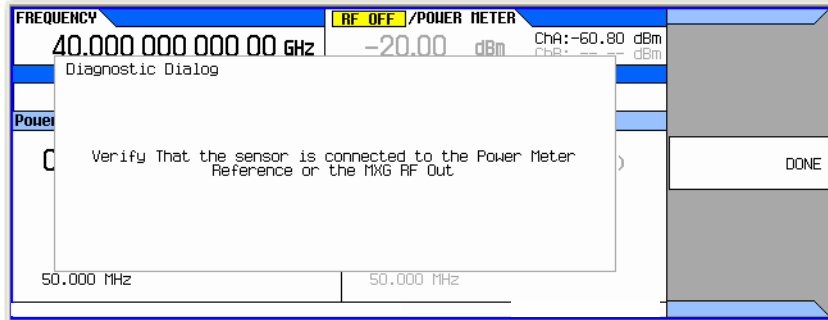
13. On the signal generator: Press Channel B to On and then back to Off again. This initializes the signal generator to the external power meter.

14. Press **Return** > **Zero Sensor**

A diagnostic dialog box is displayed each time an external power meter is being used and the Zero Sensor or Calibrate Sensor softkey is pressed (refer to [Figure 4-10 on page 93](#)).

Verify the power sensor is connected to the 50 MHz reference of the power meter.

**Figure 4-10** Diagnostic Dialog Box for Channel B



For details on each key, use key help as described on [page 58](#).

15. Press **Done**

The Running Calibration(s) bar is displayed: Zeroing Sensor Please wait....

16. After Running Calibration(s) bar disappears: Press **Calibrate Sensor**

Diagnostic Dialog box is displayed that prompts for verifying the connection of the power sensor to the power meter 50 MHz reference (refer to [Figure 4-11 on page 93](#)).

**Figure 4-11** Diagnostic Dialog Box for Calibration

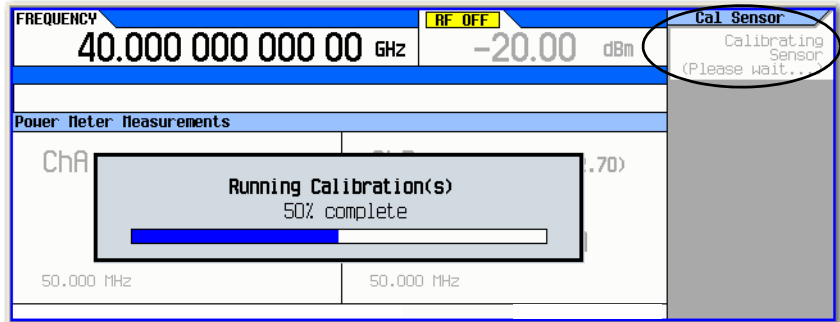


For details on each key, use key help as described on [page 58](#).

17. Press Done

Calibration progress bar is displayed. Refer to [Figure 4-12 on page 94](#).

**Figure 4-12** Running Calibration(s) Bar (Calibrating Sensor)

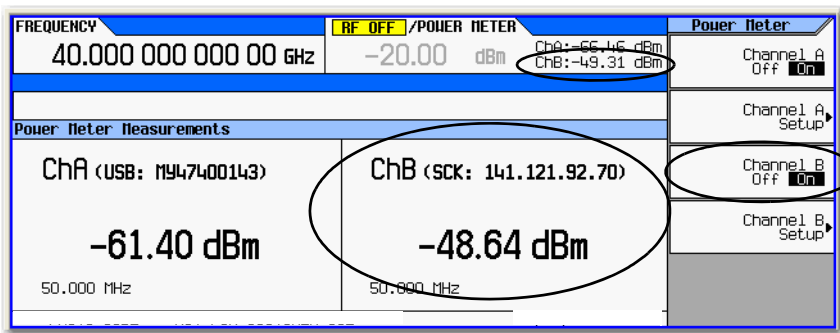


For details on each key, use key help as described on [page 58](#).

18. Press Return > Channel B to On

19. The current power meter sensor reading should be displayed on the signal generator in the ChB portion of the display and in the upper right corner of the display under Power Meter and to the left of the Power Meter power sensor reading.

**Figure 4-13** Channel B Power Sensor Displayed on MXG/EXG



For details on each key, use key help as described on [page 58](#).

20. The power sensors are now ready to be connected in a measurement setup.

## Using the USB Pass Through Commands

The USB pass through SCPI commands are used remotely and or to program your system setup and power meter sensor setup.

This section applies to the following USB power sensors:

- U2040 X-Series
- U2020 X-Series
- U8480 Series
- U2000 Series
- 

### NOTE

If the power sensor is configured to return peak power, then the MXG displays peak power (i.e., Use the `:fetch?` and `:measure?` power sensor SCPI commands, which returns a value based on the configuration). Refer to the X-Series Signal Generators SCPI Command Reference.

This section contains the following:

- [Table 4-1, “SCPI Pass Through Commands”](#)
- [“Procedure”](#)

Table 4-1 SCPI Pass Through Commands

```
:SYSTem:PMETer[1]|2:PASSthrough <"scpiCommand">
:SYSTem:PMETer[1]|2:PASSthrough? <"scpiQuery">
-----
:SYSTem:PMETer[1]|2:PASSthrough:ENABle 0|1
:SYSTem:PMETer[1]|2:PASSthrough:ENABle?
-----
:SYSTem:PMETer[1]|2:PASSthrough:TIMEout <valueInSeconds>
:SYSTem:PMETer[1]|2:PASSthrough:TIMEout?
```

## Procedure

Step	Substeps	Results/Notes
<b>1. Setup equipment.</b>		
<b>2. Enable the pass through capability in the MXG.</b>	<b>a. Enter:</b> <code>:SYSTem:PMETer:PASSthrough:ENABle 1</code>	
<b>3. Query the instrument and verify pass through status.</b>	<b>a. Enter:</b> <code>:SYSTem:PMETer:PASSthrough:ENABle?</code>	The instrument should return a 1, indicating that the pass through feature has been enabled.

Step	Substeps	Results/Notes
<p><b>4. Sending additional SCPI commands.</b> If you are sending a query, go to step 5. Else, repeat steps 4 and or 5 as needed.</p>	<p><b>a. Enter:</b> :SYSTem:PMETer:PAS Sthrough "SCPI command"</p>	<p>Where "SCPI command" is any SCPI pass through command. Refer to <a href="#">Table 4-1 on page 95</a>.</p>
<p><b>5. Sending additional SCPI queries.</b> If you are sending a command, go to step 4. Else, repeat steps 4 and or 5 as needed.</p>	<p><b>a. Enter:</b> :SYSTem:PMETer:PAS Sthrough? "*IDN?"</p>	<p>The power sensor model and serial number should be returned.</p>

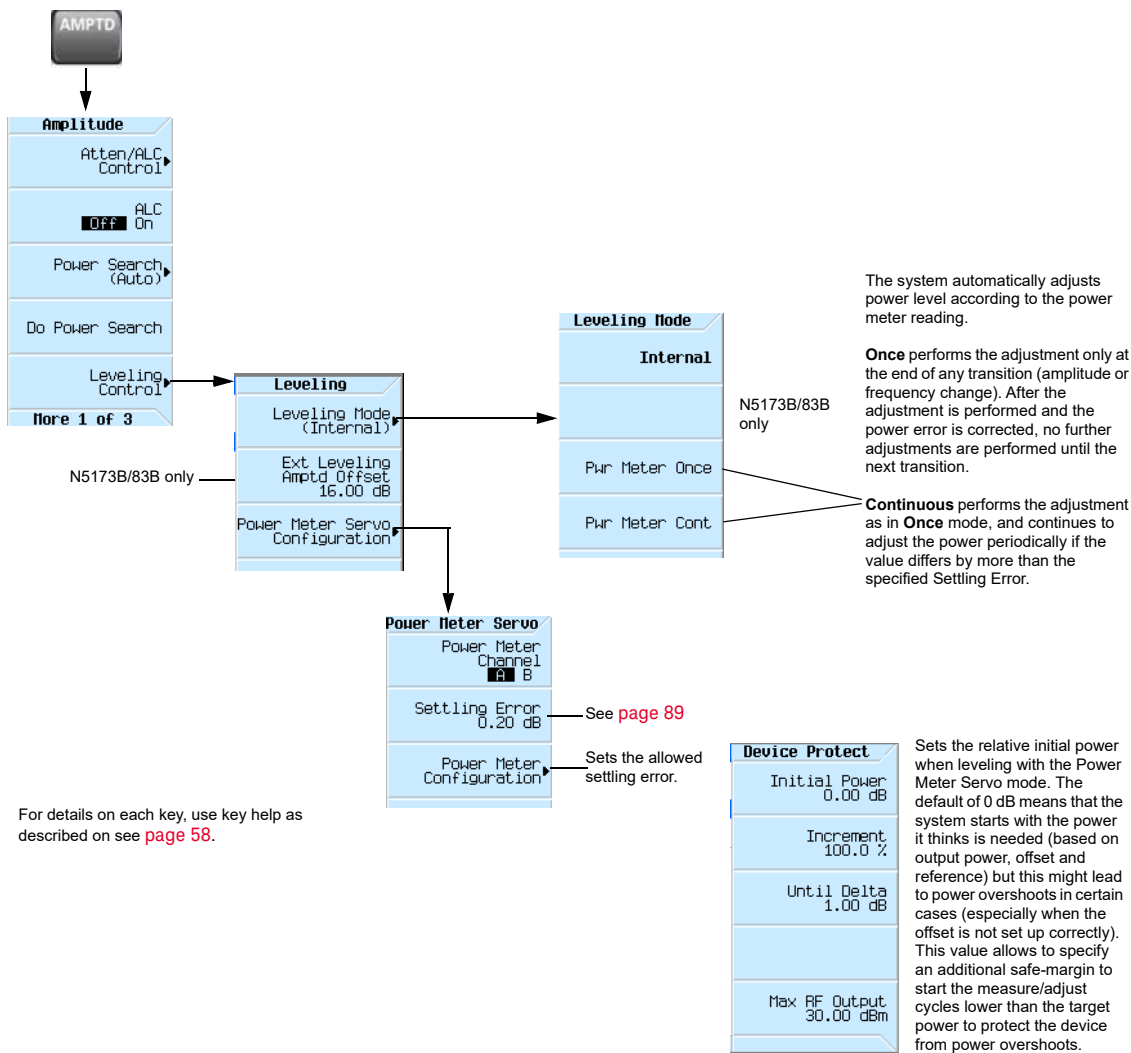


## Using the Power Meter Servo

The Power Meter Servo mode uses power meter readings to adjust the output power of the source, maintaining a constant DUT output power.

The servo loop measures the output power of the DUT, compares it to the user-provided reference power, and adjusts the output of the source to achieve the user-provided power level within the settling error. The servo loop will abort after twenty unsuccessful attempts to achieve the user-provided power level.

Figure 4-14 Power Meter Servo Menus



## Power Meter Servo Configuration

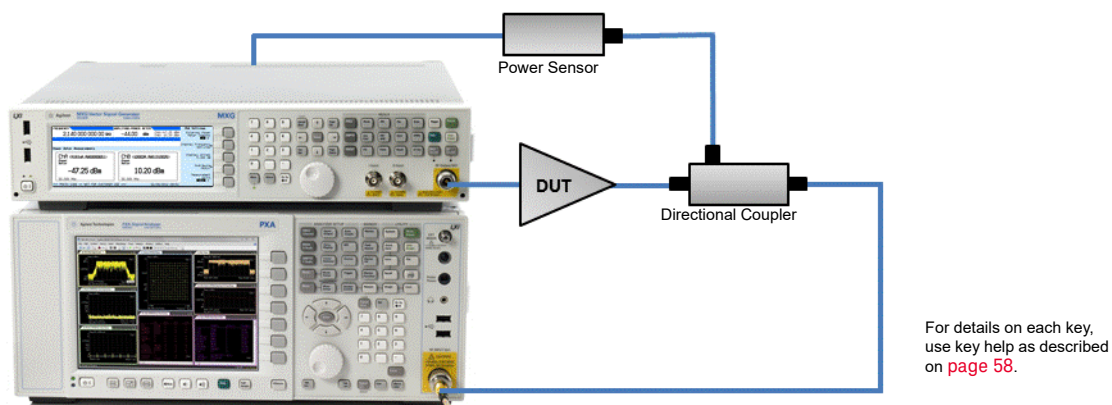
The following procedure is a basic configuration for using the signal generator's Power Meter Servo mode.

### CAUTION

The configuration described below is one possible setup example. Consider the limits of your DUT and use caution to protect the DUT from being exposed to too much power.

1. Connect the equipment as shown in [Figure 4-15](#).

**Figure 4-15** Power Meter Servo Configuration



2. Set the signal generator frequency and amplitude to the desired settings for your device.

### NOTE

To get the best results and reduce stress on the DUT, the amplitude offset should be set to match the approximate gain of the device. For example, if the DUT is an amplifier with 20 dB of gain, set the amplitude offset to 20 dB.

Press **AMPTD** > **More** > **Amptd Offset**, then enter a value.

3. On the signal generator, press **AMPTD** > **Leveling Control** > **Power Meter Servo Configuration**.
4. Press **Channel A Setup** and configure the power meter. Refer to [Configuring the Power Sensor Channels](#) on page 89.
5. Press **Return** > **Return** > **Settling Error**. Set the Settling Error value.
6. Press **Return** > **Return** > **Leveling Mode**. Select the leveling mode.

Power Meter Once performs the adjustment only at the end of any transition (amplitude or frequency change). After the adjustment is performed and the power is corrected, no further adjustments are performed until the next transition.

**Power Meter Continuous performs the adjustment as in Once mode, and continues to adjust the power periodically if the value differs by more than the specified Settling Error.**

Once these parameters are set, the servo loop engages and levels the DUT's output power.

## Example

The following example emphasizes the importance of setting the amplitude offset, as it protects the DUT from being exposed to too much power.

For this example, the source amplitude offset is 20 dB and the source amplitude is programmed to 25 dBm. The offset is subtracted from the programmed level, making the actual source output power 5 dBm. If the power meter measures 24.5 dBm, for example, the output power will be adjusted by 0.5 dBm since the power meter measurement is 0.5 dBm lower than the desired 25 dBm. The new source output power is 5.5 dBm. If the power meter then measures 24.97 dBm, no further adjustments will be made since the measured value is within half of the settling error of 0.2 dB.

If using the continuous leveling mode, the power meter readings are monitored and the output power of the source will be adjusted if the measurement drifts outside the specified settling error.

Continuing with this example, if the amplitude offset remained at the default of 0 dB, the output power would have been 25 dBm, resulting in a power meter measurement of 40 dBm (assuming the amplifier already went into compression). The algorithm would have reduced the source power by 15 dB, thus outputting 10 dBm and resulting in a measurement of maybe 29.5 dBm. The additional reduction of another 4.5 dB would have led to the same outcome as with the 20 dB amplitude offset (source output power of 5.5 dBm). However, in-between, the DUT was stressed possibly past its specified operating range.

## Using Flatness Correction

User flatness correction allows the digital adjustment of RF output amplitude for up to 1601 sequential linearly or arbitrarily spaced frequency points to compensate for external losses in cables, switches, or other devices. Using an Keysight N1911A/12A, E4419A/B, or U2000 Series power meter/sensor to calibrate the measurement system, a table of power level corrections can automatically be created for frequencies where power level variations or losses occur. Supported connection types to the power meter/sensor are Sockets LAN, VXI-11 LAN, USB, and GPIB via VXI-11 LAN using a LAN-GPIB gateway (e.g. E5810A Gateway or equivalent).

### NOTE

A power meter with GPIB requires using the Connection Type **VXI-11** softkey, as well as a LAN-GPIB gateway, to control a power meter. Refer to the Keysight Connectivity Guide **USB/LAN/GPIB Connectivity Guide** (E2094-90009), Keysight X-Series FAQs “How do I connect to the LAN?”, and to the E5810A User’s Guide or equivalent, LAN/GPIB gateway device.

---

If you do not have an Keysight N1911A/12A or E4419A/B power meter, or U2000A/01A/02A/04A power sensor, or if your power meter does not have a LAN, GPIB, or USB interface, the correction values can be manually entered into the signal generator.

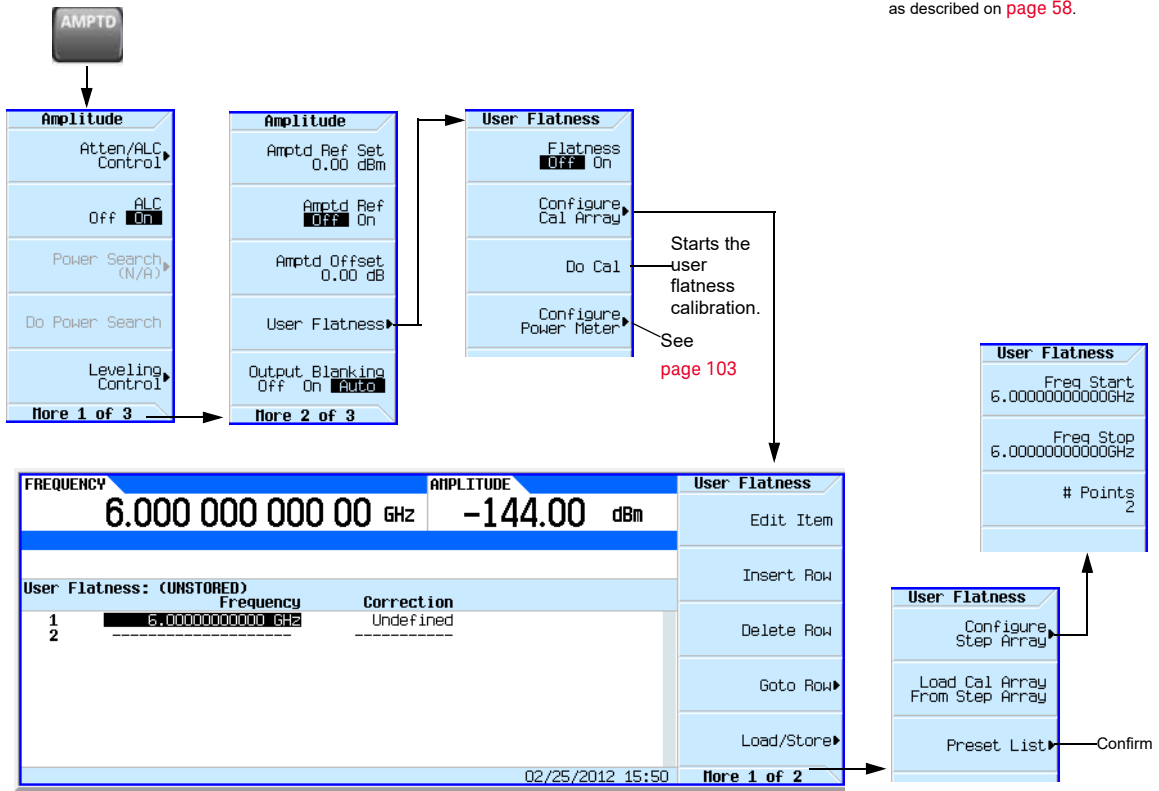
To allow different correction arrays for different test setups or different frequency ranges, you may save individual user flatness correction tables to the signal generator’s memory catalog and recall them on demand.

Follow the steps in the next sections to create and apply user flatness correction to the signal generator’s RF output (see [page 104](#)).

Afterward, follow the steps in “[Recalling and Applying a User Flatness Correction Array](#)” on [page 108](#) to recall a user flatness file from the memory catalog and apply it to the signal generator’s RF output.

Figure 4-16 User Flatness Correction Softkeys

For details on each key, use key help as described on page 58.



## Creating a User Flatness Correction Array

In this example, you will create a user flatness correction array. The flatness correction array contains ten frequency correction pairs (amplitude correction values for each specified frequency), from 500 MHz to 1 GHz.

An Keysight N1911A/12A or E4419A/B power meter and E4413A power sensor are used to measure the RF output amplitude at the specified correction frequencies and transfer the results to the signal generator. (A U2000 Series power meter/sensor could be used in lieu of the power meter and E4413A power sensor.) The signal generator reads the power level data from the power meter, calculates the correction values, and stores the correction pairs in the user flatness correction array.

If you do not have the required Keysight power meter, or if your power meter does not have a LAN, GPIB, or USB interface, you can enter correction values manually.

### Required Equipment

- Keysight N1911A/12A or E4419A/B power meter (a power meter is **not** required with the U2000A/01A/02A/04A Power Sensor)
- Keysight E4413A E Series CW power sensor or U2000A/01A/02A/04A Power Sensor
- GPIB, LAN, or USB interface cables, as required
- adapters and cables, as required

#### NOTE

For operating information on a particular power meter/sensor, refer to its operating guide.

---

### Connect the Equipment

Connect the equipment as shown in [“Connect the Equipment” on page 103](#).

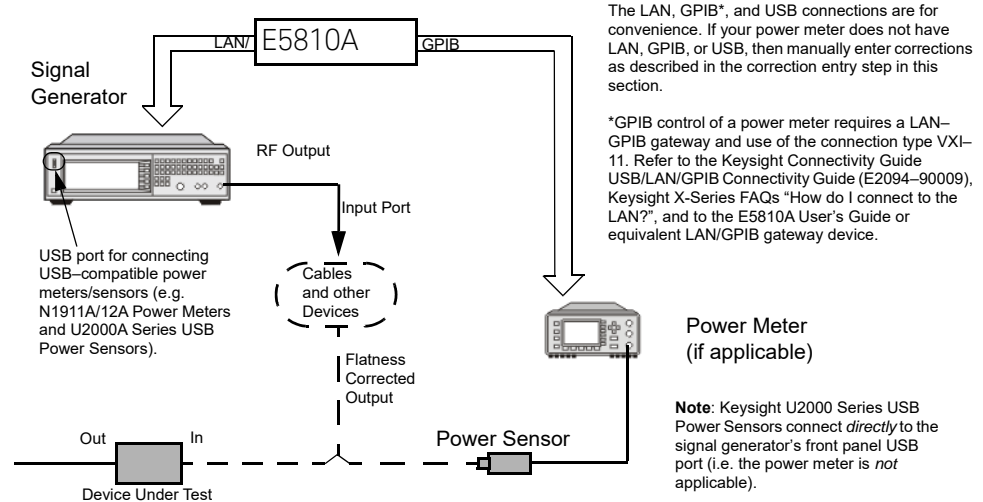
#### NOTE

During the process of creating the user flatness correction array, the power meter is remotely controlled by the signal generator.

---

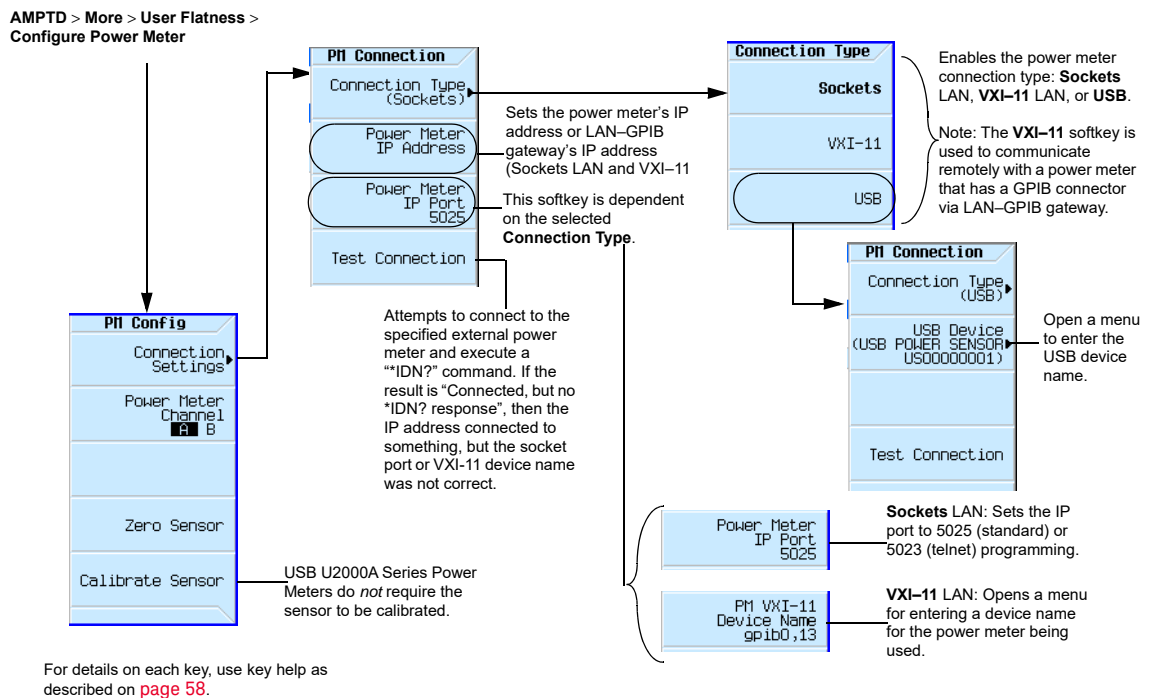
## Connect the Equipment

- Keysight N1911A/12A or E4419A/B power meter<sup>a</sup>
- Keysight U2000A/01A/02A/04A power Sensor<sup>a</sup>
- LAN, GPIB, or USB interface cables, as required
- adapters and cables, as required



a. For operating information, refer to the power meter/sensor documentation.

Figure 4-17 Configure Power Meter Menu Softkeys



## Basic Procedure

1. Create a user flatness array.
  - a. Configure the power meter/sensor
  - b. Connect the equipment
  - c. Configure the signal generator
  - d. Enter the user flatness correction values
2. Optionally, save the user flatness correction data.
3. Apply user flatness correction to the RF Output.

### Configure the U2000A/01A/02A/04A Power Sensor

1. Connect the power sensor to the signal generator's front panel USB port. Refer to **“Connect the Equipment”** on page 103.
2. Zero the power sensor using the signal generator softkeys.

#### CAUTION

Verify the signal generator RF Output power is set to the desired amplitude before performing the power meter zero. No RF Output amplitude check is done by the signal generator during zero.

---

#### NOTE

The signal generator's RF Output LED remains unchanged during zeroing of the power sensor (e.g. if the RF Output LED was on prior to starting the Zeroing of the power sensor, the LED remains on throughout the zero/calibration). But, actually the instrument's firmware has turned off the RF Output's power.

For operating information on your particular power sensor, refer to its operation guide.

---

### Configure the E4419A/B and N1911A/12A Power Meter

1. Select SCPI as the remote language for the power meter.
2. Zero and calibrate the power sensor to the power meter, using the softkeys on the signal generator or the front panel of the power meter.
3. Enter the power sensor calibration factors into the power meter as required.



#### 4. Enable the power meter's cal factor array.

##### NOTE

The signal generator's RF Output LED remains unchanged during zeroing of the power sensor (e.g. if the RF Output LED was on prior to starting the Zeroing of the power sensor, the LED remains on throughout the zero/calibration). But, actually the instrument's firmware has turned off the RF Output's power.

For operating information on your particular power meter/sensor, refer to its operating guide.

---

Example: A 500 MHz to 1 GHz Flatness Correction Array with 10 Correction Values

#### Create the User Flatness Array

##### 1. Configure the signal generator:

a. Preset the signal generator.

b. Set the signal generator's connection type to the power meter/sensor:

i. Press **AMPTD > More > User Flatness > Configure Power Meter > Connection Settings > Connection Type > connection type.**

ii. If connection type is USB:

1. Zero Sensor

2. Go to step **c.**

**else**

If Sockets LAN or VXI-11 LAN: Press **Power Meter IP Address > power meter's or LAN-GPIB gateway IP address > Enter.**

iii. If Sockets LAN: Press **Power Meter IP Port > IP port > Enter.**

**else**

If VXI-11: Press **PM VXI-11 Device Name > device name > Enter.**

When connecting directly to the power meter, enter the **device name** as specified in the power meter's documentation. Typically, this is "inst0" and is case sensitive for some power meters. Refer to your power meter's documentation, the Keysight Connectivity Guide USB/LAN/GPIB Connectivity Guide (E2094-90009), and Keysight X-Series FAQs "How do I connect to the LAN?"

When connecting via a LAN-GPIB gateway, enter the SICL address of the power meter. Typically, this is "gpib0,13", where "gpib0" is the GPIB SICL interface name of the gateway and "13" is the GPIB address of the power meter. Refer to the Keysight Connectivity Guide USB/LAN/GPIB Connectivity Guide (E2094-90009), Keysight X-Series FAQs "How do I connect to the LAN?", and to the E5810A User's Guide or equivalent, LAN/GPIB gateway device.

- c. Open the User Flatness table editor and preset the cal array:  
Press **Return** > **Configure Cal Array** > **More** > **Preset List** > **Confirm Preset with Defaults**.
- d. In the Step Array menu, enter the desired flatness-corrected start and stop frequencies, and the number of points:

Press **More** > **Configure Step Array** >  
**Freq Start** > **500** > **MHz** >  
**Freq Stop** > **1** > **GHz** >  
**# of Points** > **10** > **Enter**

- e. Populate the user flatness correction array with the step array configured in the previous step:  
Press **Return** > **Load Cal Array From Step Array** > **Confirm Load From Step Data**.
- f. Set the output amplitude to 0 dBm.
- g. Turn on the RF output.

2. Connect the power meter to the RF output and enter the correction values:

With a Power Meter Over LAN, GPIB, or USB	Manually
<p>i. Create the correction values: Press <b>More &gt; User Flatness &gt; Do Cal.</b> The signal generator begins the user flatness calibration, and displays a progress bar. The amplitude correction values load automatically into the user flatness correction array.</p> <p>ii. View the stored amplitude correction values: Press <b>Configure Cal Array.</b></p>	<p>i. Open the User Flatness table editor and highlight the frequency value in row 1: Press <b>More &gt; User Flatness &gt; Configure Cal Array.</b> The RF output changes to the frequency value of the table row containing the cursor.</p> <p>ii. Note the value measured by the power meter.</p> <p>iii. Change the sign on the delta value (e.g. the delta value of the 0 dBm reference value (step f), and the measured value from ii is <b>-0.34</b>, change the value to <b>+0.34</b>).</p> <p>iv. Highlight the correction value in row 1.</p> <p>v. Press <b>Select &gt; enter the delta calculated in step iii &gt; dB.</b> (e.g. For this example enter +.34) The signal generator adjusts the output amplitude based on the correction value entered.</p> <p>vi. Repeat steps ii - v until the power meter reads 0 dBm.</p> <p>vii. Highlight the frequency value in the next row.</p> <p>viii. Repeat steps ii through vii for the remaining rows.</p>

The user flatness correction array title displays `User Flatness: (UNSTORED)`, without a name, indicating that the current user flatness correction array data has **not** been saved to the file catalog.

**Optional: Save the User Flatness Correction Data**

1. Press **Load/Store > Store to File.**
2. Enter a file name (for this example, `FLATCAL1`) and press **Enter.**

The user flatness correction array file is now stored in the file catalog as a `USERFLAT` file. Any user flatness correction files saved to the catalog can be recalled, loaded into the correction array, and applied to the RF output to satisfy specific RF output flatness requirements.

3. Press **Return.**

**Enable the Flatness Correction at the RF Output**

- Press **Return > Flatness Off On.**

The **UF** annunciator appears in the **AMPLITUDE** area of the display, and the correction data in the array is applied to the RF output.

## Recalling and Applying a User Flatness Correction Array

The following example assumes that a user flatness correction array has been created and stored. If not, perform the **Example: A 500 MHz to 1 GHz Flatness Correction Array with 10 Correction Values** on page 105.

1. Preset the signal generator.
2. Recall the desired User Flatness Correction file:
  - a. Press **AMPTD** > **More** > **User Flatness** > **Configure Cal Array** > **More** > **Preset List** > **Confirm Preset**.
  - b. Press **Load/Store**.
  - c. Highlight the desired file.
  - d. Populate the user flatness correction array with the data contained in the selected file:  
Press **Load From Selected File** > **Confirm Load From File**.  
The user flatness correction array title displays **User Flatness: Name of File**.
3. Apply the correction data in the array to the RF output: Press **Return** > **Flatness Off On to On**.

## Using Internal Channel Correction (N5172B/82B Only)

### NOTE

There is an internal calibration routine (Factory Calibration) that collects correction data for both the baseband and RF magnitude and phase errors over the entire RF frequency and power level range on any unit with options 653, 655, 656, and 657. The internal channel correction cannot be turned on until after the Enhanced Factory Calibration has been executed once. See **“Perform Enhanced Factory Calibration” on page 112.**

---

The internal channel correction feature flattens the system magnitude and phase response across the maximum bandwidth supported by the instrument (up to 160 MHz BW, depending on the option). This performance improvement is available at any arbitrary center frequency or amplitude level.

Correction filter generation and application is performed internally. The correction filtering occurs in real time and is applied to live data.

There are two correction types: factory and user. The Factory Calibration optimizes the performance at the front panel RF output connector into a precision 50 ohm load. The User Calibration can extend this performance to a new calibration reference plane and deliver the highest signal quality to the user's DUT.

This feature also minimizes unwanted baseband images by flattening (and matching) the magnitude and phase response of the I and Q channels from the signal DACs to the IQ modulator.

This calibration should be run when the ambient temperature has varied by at least  $\pm 5$  degrees Celsius from the ambient temperature at which the previous calibration was run.

When this feature is off, the box will behave as it always has. When this feature is on, the internal I/Q path is active, the I/Q Correction Optimized Path is RF Output, and the frequency is changed by more than 1 kHz, the firmware will calculate a channel correction filter. For List/Sweep, the calculation will be done prior to the first sweep using the specified frequencies when either waveform sweep is active or the baseband is on and the instrument is optimized for the internal path. This calculation will cache corrections for up to the maximum number of cache points (256). For list/sweep, the sweep will pause and recalculate the correction caches before running again.

### CAUTION

**In the case of arbitrary frequency switching, once the correction cache is full (256 unique frequency points), the oldest frequency corrections will be forgotten as new frequencies are selected.**

**Whenever I/Q Timing Skew, I/Q Delay, Quadrature Angle Adjustment, or the Int Equalization Filter is adjusted, all caches are forgotten.**

---

Additional characteristics of the internal channel correction:

- When the internal channel correction is on, arbitrary frequency switching while the baseband is on will take up to an additional 290 ms (72 ms typical) the first time that frequency is specified. After the first time that a frequency is selected, switching to that frequency again takes an additional 1 ms.

## Optimize Performance

### Using Internal Channel Correction (N5172B/82B Only)

- If a frequency sweep is activated, then the calculation and caching will occur up front for the first 256 unique frequencies, and all additional unique frequencies will have the characteristics of arbitrary frequency switching.
- If the I/Q Correction Optimized Path softkey is set to Ext I/Q, then only the baseband corrections will be applied and the frequency switching will be unaffected.
- If active, the ACP Internal I/Q Channel Optimization filter and the Equalization filter, will be convolved with the internal channel correction filter. A hamming window is applied and the resulting filter will be truncated to 256 taps.

Figure 4-18 Internal Channel Correction Softkeys

I/Q > More

Displays a menu that controls the calibration and application of the internal baseband generator RF and baseband magnitude and phase corrections across the entire baseband bandwidth.

Toggles on or off the application of the internal baseband generator RF and baseband magnitude and phase corrections across the 160MHz baseband bandwidth at the current RF frequency. When this feature is on, arbitrary frequency switching while the baseband is on will take up to an additional 3.3ms (typical) to 6.8ms the first time that frequency is specified. After that, switching to that frequency will take up to an additional 1.3ms. Up to 1024 unique frequencies can be cached before the oldest cache will be forgotten. If a frequency sweep is activated, then the calculation and caching will occur up front for the first 1024 unique frequencies, and all further unique frequencies will have the characteristics of arbitrary frequency switching. If the I/Q Correction Optimized Path is set to Ext I/Q Output then only the baseband corrections will be applied and the frequency switching speed will be unaffected. This correction will be convolved with the ACP Internal I/Q Channel Optimization filter and the Equalization filter if they are active. The resulting filter will be truncated to 256 taps. **NOTE:** The Enhanced Factory Calibration must be executed once before the Factory correction type can be turned on. See [page 112](#).

Toggles on or off the application of Factory or User I/Q channel correction.

**Factory** optimizes the performance to the RF output connector.

**User** extends the correction to the DUT.

**NOTE:** The Enhanced Factory Calibration must be executed once before the Factory correction type can be turned on. See [Perform Enhanced Factory Calibration](#).

To perform the Factory calibration, press **Utility > More > Service > I/Q Int Channel Correction Calibrations**.

Select either **Factory Calibration** or **Enhanced Factory Calibration**. Follow the instructions on the signal generator display.

Provides additional correction to the DUT. Specify the start and stop frequencies, configure the power meter, then execute the calibration.

```

SCPI Commands:
[:SOURce]:DM:INteRnal:CHANnel:CORRection[:STATe] ON|OFF|1|0
[:SOURce]:DM:INteRnal:CHANnel:CORRection[:STATe]?
:CALibration:BBG:CHANnel

:MEMory:LOAD:CHANnel <"filename">
:MEMory:STORe:CHANnel <"filename">
    
```

For details on each key, use key help as described on [page 58](#).

## Configure Internal Channel Correction

### NOTE

There is an internal calibration routine (Enhanced Factory Calibration) that collects correction data for both the baseband and RF magnitude and phase errors over the entire RF frequency and power level range on any unit with options 653, 655, 656, and 657. The internal channel correction cannot be turned on until after the Enhanced Factory Calibration has been executed once.

---

The following is a basic configuration for using the signal generator's internal channel correction. Refer to [Figure 4-18](#).

On the signal generator:

**1. Set the center frequency:**

Press **Freq > 3 > GHz**

**2. Set the I/Q to internal (default):**

Press **I/Q > I/Q Source > Internal**

**3. Press I/Q to On**

**4. Perform internal channel correction:**

Press **More > Int Channel Correction Off On to On**

### Using User Corrections

Use a USB power sensor to perform a User Channel Corrections calibration to correct the response of the DUT/poor matching network. And, verify the EVM of the DUT with the new User Channel Corrections calibration.

## Perform Enhanced Factory Calibration

For instruments with firmware prior to B.01.10, the Enhanced Factory Calibration must be run once before you can turn on the I/Q Internal Channel Corrections (Factory Correction Type). Optionally, this calibration procedure can be run anytime for new calibration data.

### NOTE

Depending on the equipment you use, the Enhanced Factory Calibration may take up to four hours to complete.

---

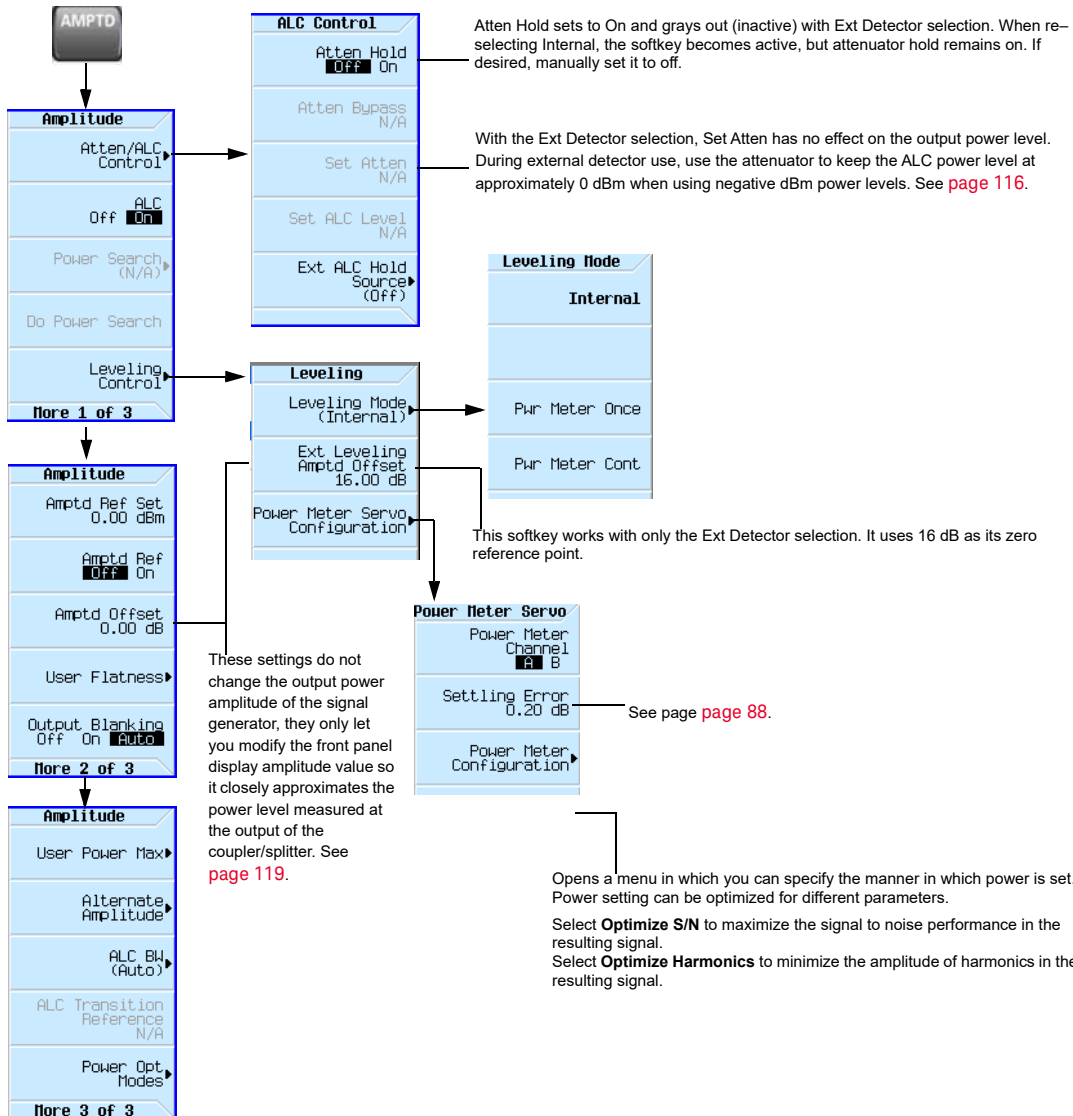
On the signal generator:

**1. Press **Utility > More > Service > I/Q Int Channel Correction Calibrations > Enhanced Factory Calibration**.**

**2. Follow the instructions on the signal generator display to complete the calibration.**



## Using External Leveling (N5173B/83B Only)

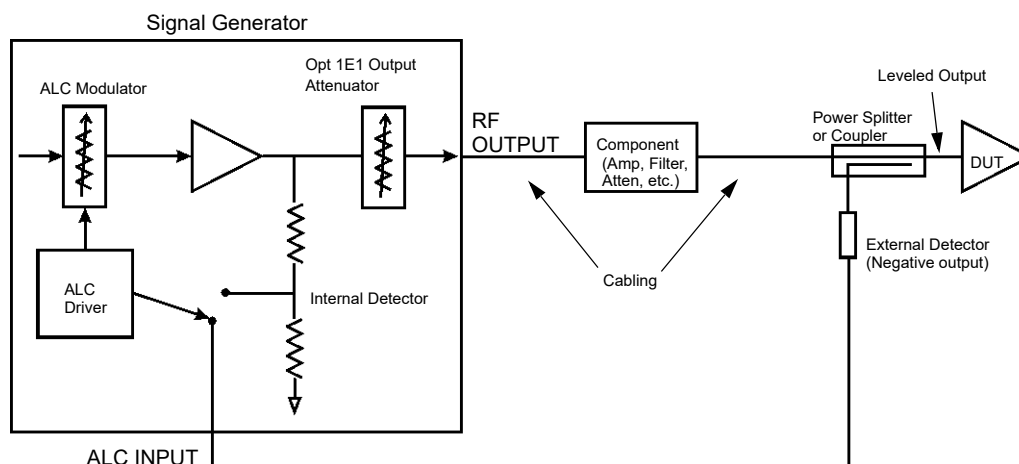


### CAUTION

While operating in external leveling mode, if either the RF or the DC connection between the signal generator and the detector is broken, maximum signal generator power can occur. This maximum power may overstress a power-sensitive device under test.

External leveling lets you move the ALC feedback source closer to the device under test (DUT) so that it accounts for most of the power uncertainties inherent to the cabling and components in a test setup. Refer to [Figure 4-19](#).

Figure 4-19 ALC Circuitry



The external detector outputs a negative voltage to the signal generator's rear panel ALC INPUT connector based on the power level at the detector. As the RF power level at the coupler's/power splitter input changes, the external detector returns a compensating negative voltage. The ALC circuit uses this negative voltage to level the RF output power by raising and lowering the signal's power, thus ensuring a constant power level at the point of detection (external detector). Since the point of detection does not occur at the output of the device to which the detector is connected, there is some power loss that is not compensated for by the external detector. For example on a coupler, the coupled port siphons some of the signal's energy to drive the external detector. In addition the coupler experiences some insertion loss between the coupled port and the output. [Figure 4-21 on page 115](#) shows the input power versus output voltage characteristics for typical Keysight Technologies diode detectors. Using this chart, you can determine the leveled power at the diode detector input by measuring the external detector output voltage. For a coupler, you must then add the coupling factor to determine the leveled output power.

When using an external detector, the signal generator's power range may vary from the values shown in the data sheet. This is primarily due to the efficiency of the detector. Always ensure that the detector, coupler/power splitter are specified for the power and frequency range of interest. To determine the signal generator's actual power range during external leveling, see ["Determining the Signal Generator's Amplitude Range" on page 118](#).

With external leveling, the displayed amplitude value can vary significantly from the actual output power of the coupler/power splitter to which the external detector is connected (see [Figure 4-20](#)). This is because the coupler/power splitter has its own signal characteristics (insertion loss, coupling factor, and so forth), which are unknown to the signal generator, so it is typically unable to display an accurate amplitude value. Also components between the signal generator and the external detector can affect the output power of the coupler/power splitter. You can compensate for this power display difference by using the **Ext Leveling Amptd Offset** softkey or the **Amptd Offset** softkey. The difference between the two softkeys is that the **Ext Leveling Amptd Offset** functions only while external leveling is active. For more information on using the external leveling offset feature, see ["Adjusting the Signal Generator Display's Amplitude Value" on page 119](#).

Figure 4-20 Power Value Differences with External Leveling

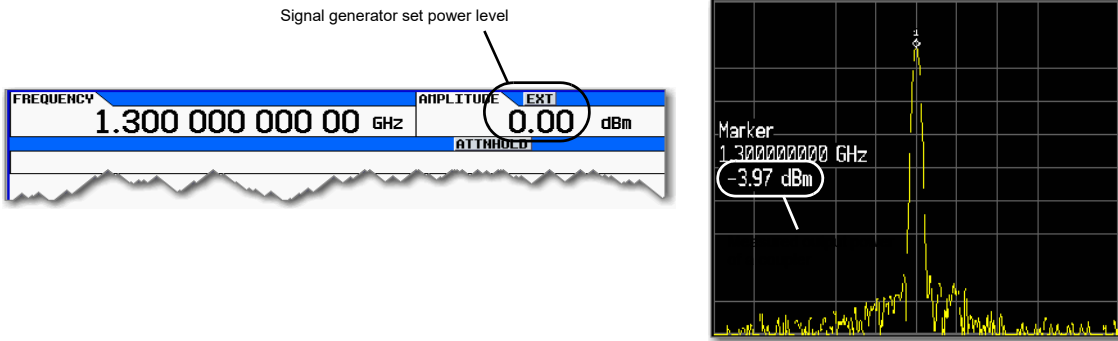
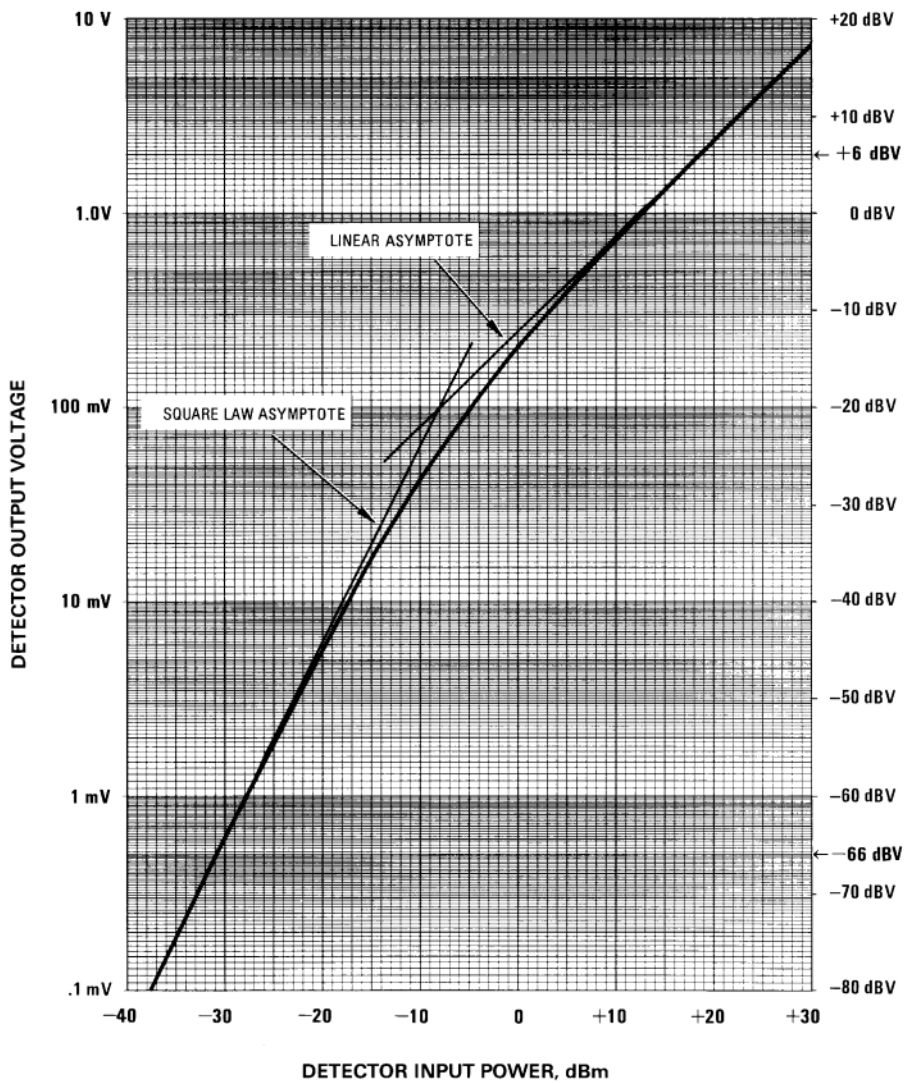


Figure 4-21 Typical Diode Detector Response at 25° C



## Option 1E1 Output Attenuator Behavior and Use

When using the internal detector, the Option 1E1 output attenuator enables signal generator power levels down to -130 dBm at the RF Output connector. It accomplishes this by adding attenuation to the output signal after the ALC detection circuit. The output power value (shown in the **Amplitude** area of the display) is the resultant of the **Set Atten** and **Set ALC Level** values (see [page 113](#)). With the external detector selected, the output attenuator no longer attenuates the output signal since the feedback for the detection circuit has been moved beyond the output attenuator. Because the attenuator no longer affects the amplitude of the output signal, the output amplitude is determined by only the **Set ALC Level** softkey.

With external leveling selected, the signal generator enables attenuator hold and the power range approximates the range of a standard option (no attenuator) signal generator (see the *Data Sheet*). As stated earlier, the actual output power may vary due to the external detector and the coupler/power splitter performance characteristics.

### NOTE

When the internal detector (**Internal** selection) is reselected, the signal generator does not turn the attenuator hold off.

---

Even though the output attenuator no longer affects the output power, it is still useful to drive the ALC circuit to its mid-power point of approximately 0 dBm, which is optimal for the internal leveling circuitry and typically provides the best amplitude flatness results. This is useful with power values of -5 dBm or less. For example, to drive the ALC to approximately mid-power with a -20 dBm power setting, add 25 dB of attenuation. This sets the ALC circuit to 5 dBm (-20 + 25).

### NOTE

If there is too much attenuation, it will drive the ALC circuit too high and cause the signal generator to go unlevelled. Ensure that you decrease the attenuation as you increase the power level.

---

## Configure External Leveling

### Basic Setup Process

- If working with a single frequency signal, perform Steps 1 through 5.
  - If working with multiple frequencies:
    - a. Perform Steps 1 through 4.
    - b. Perform a user flatness correction, see [“Using Flatness Correction” on page 100](#).
  - If working with a sweep:
    - a. Perform Steps 1 through 4.
    - b. Setup the sweep, see [“Configuring a Swept Output” on page 64](#).
1. Setup the equipment, see [“Equipment Setup” on page 117](#)
  2. Configure the carrier signal, see [“Configuring the Carrier” on page 117](#)
  3. Select external leveling, see [“Selecting External Leveling” on page 117](#).

4. Determine the output amplitude range, see “[Determining the Signal Generator’s Amplitude Range](#)” on page 118
5. Set the displayed power value, see “[Adjusting the Signal Generator Display’s Amplitude Value](#)” on page 119

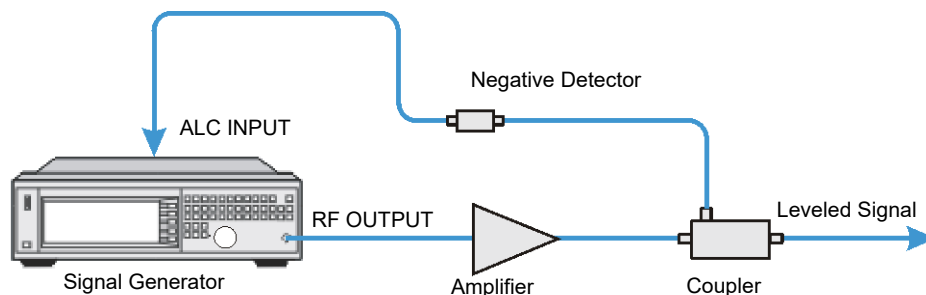
## Equipment Setup

Set up the equipment as shown in [Figure 4-22 on page 117](#). Place the external detector (detector and coupler/power splitter) as close as possible to the DUT.

## Recommended Equipment

- Keysight 8474E negative detector
- Keysight 87301D directional coupler
- cables and adapters, as required

Figure 4-22 Typical External Leveling Setup using a Directional Coupler



## Configuring the Carrier

1. Press **Preset**.
2. Set the carrier frequency.
3. Set the power level to 0 dBm:
  - If the signal generator has Options 1E1 and 520, set the output attenuator to zero dBm:
    - a. Press **AMPTD > Atten/ALC Control > Atten Hold Off On** to On.
    - b. Press **Set Atten > 0 > dB**.
    - c. Press **Set ALC Level > 0 > dBm**.

## Selecting External Leveling

Press **AMPTD > Leveling Control > Leveling Mode > Pwr Meter Cont**.

## Determining the Signal Generator's Amplitude Range

The maximum output amplitude is frequency dependent. So if you are using multiple frequency points and there is a need to know the maximum output amplitude for each frequency point, refer to the “*Amplitude*” section of the *X-Series Data Sheet*. Then use this procedure to determine the maximum amplitude for each band.

With external leveling and Option 1E1, the signal generator's power range approximates that of a standard option instrument (no Option 1E1). But Option 1E1 does let you use the attenuator to drive the ALC to its mid-power point when using amplitude values less than 0 dBm. However adding attenuation does decrease the upper range limit. For more information, see “**Option 1E1 Output Attenuator Behavior and Use**” on page 116.

1. If Option 1E1 is installed, adjust the attenuator to the desired level.

### NOTE

If the Option 1E1 output attenuator value is too high (approximately  $\geq 55$  dB), it will cause an unlevel condition to occur when the RF output is turned on.

- a. Press **AMPTD** > **Atten/ALC Control** > **Atten Hold On** > **Set Atten**.
  - b. Enter the attenuator value.
2. Turn on the RF output: Press **RF On/Off** to On
  3. Set the **AMPTD** step increment value to one dB.
    - Press **AMPTD** > **Incr Set** > **1** > **dB**.
  4. Determine the minimum amplitude value:
    - a. Set the amplitude to -25 dBm.
    - b. Using the down arrow key, decrease the amplitude until the **UNLEVEL** annunciator appears.
    - c. Using the up arrow key, increase the amplitude until the **UNLEVEL** annunciator is gone.

The value showing when the **UNLEVEL** annunciator is gone is the minimum amplitude range value.
  5. Determine the maximum amplitude value:
    - a. Set the amplitude to a value that does not cause the signal generator to go unlevelled.
    - b. Using the up arrow key, increase the amplitude until it goes unlevelled or an error message indicating that the upper limit has been reached shows at the bottom of the display.
    - c. Decrease the amplitude value:
      - If the unlevelled annunciator appeared, decrease the amplitude until the annunciator is gone. The value where the annunciator disappears is the maximum upper range value.
      - If the signal generator displays **Error: 501, Attenuator hold setting over range** at the bottom of the display, the value showing is the maximum upper range value.

To remove the error message, press the down arrow key until the message is gone. The error appears when an attempt is made to increase the amplitude beyond the maximum value as it relates to the current attenuator setting.

## Adjusting the Signal Generator Display's Amplitude Value

When using external leveling, the signal generator's displayed amplitude value will not match the leveled power of the signal at the output of the coupler/splitter. To compensate for this difference, the signal generator provides two methods for configuring the displayed power value so that it closely matches the measured value at the output of the coupler/splitter.

### 1. Connect and configure a measurement instrument:

- a. Connect the output of the coupler/splitter to either a power meter or a signal analyzer.
- b. Configure the power meter/signal analyzer for measuring the power level of the signal.

### 2. Adjust the signal generator's displayed amplitude value:

- If using the **Ext Leveling Amptd Offset** Softkey:

This softkey uses 16 dB as its zero reference. The 16dB is the coupling factor of the internal detector.

- a. On the signal generator, press **AMPTD > Leveling Control > Ext Leveling Amptd Offset**.
- b. While viewing the carrier amplitude value on the signal generator display, use the RPG knob (detent knob) to adjust the offset value until the integer part of the displayed amplitude value is the same as the integer portion of the measured value.

Each detent position adjusts the value by 1 dB.

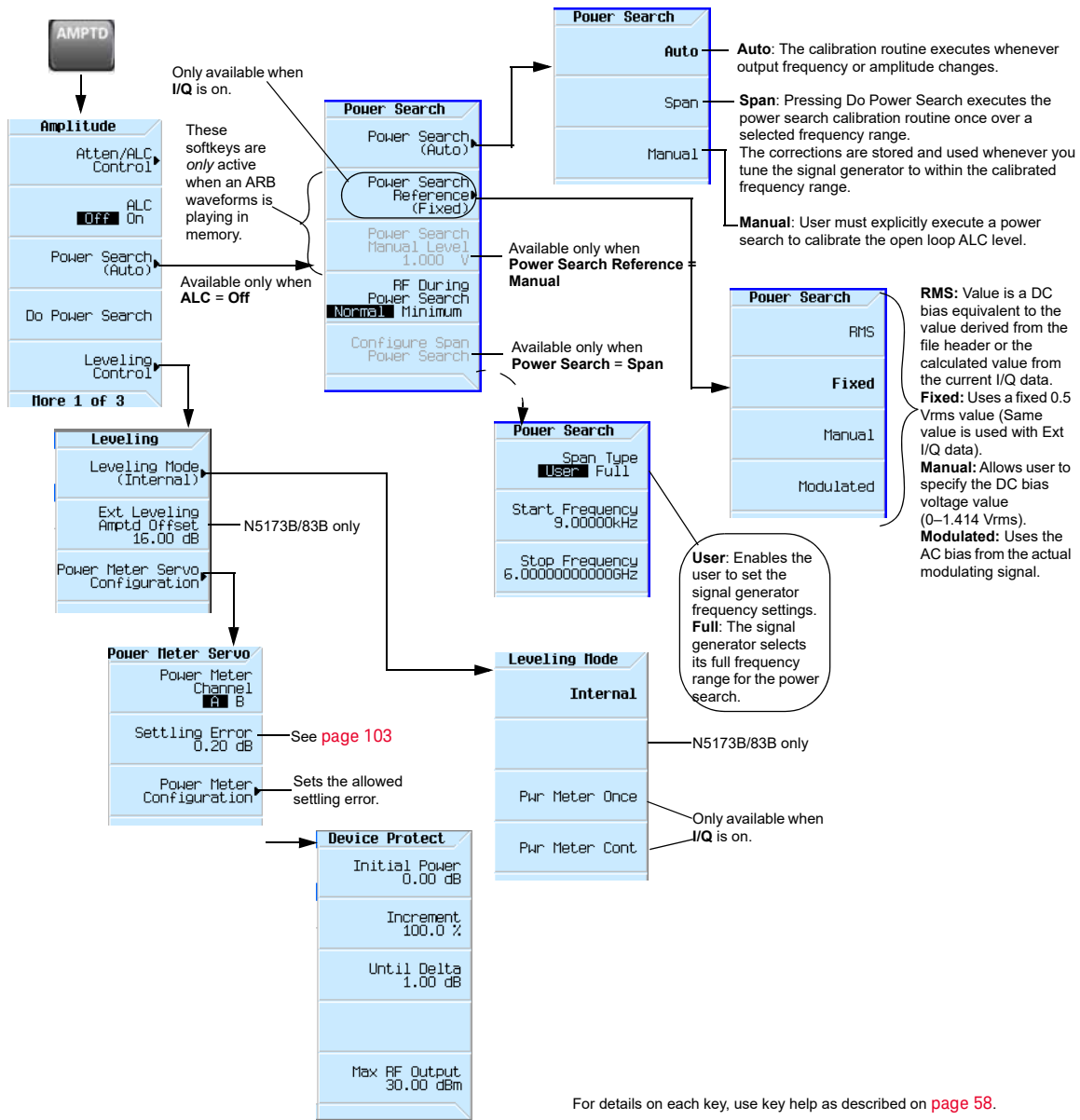
- c. Using the number keypad, make the necessary fractional adjustments to the display amplitude value.

- If using the **Amptd Offset** Softkey:

- a. On the signal generator, press **AMPTD > More > Amptd Offset**.
- b. Calculate the difference between the signal generators displayed Amplitude value and the measured value.
- c. Using the numeric keypad, enter this difference as the **Amptd Offset** softkey value.

## Using Unleveled Operating Modes

Figure 4-23 Power Search and ALC Off Softkeys



### ALC Off Mode

Turning ALC off deactivates the signal generator’s automatic leveling circuitry. Turning ALC off is useful when the modulation consists of very narrow pulses that are below the pulse width specification of the ALC or when up converting external IQ signals and the modulation consists of



slow amplitude variations or bursts that the automatic leveling would remove or distort. When using the internal IQ baseband generator, the best technique is to use the ALC hold marker function vs. ALC off for the types of signals just described.

**NOTE**

After the ALC has been turned off, power search must be executed to set the proper output power level requested on the front panel. Power search is executed automatically by default, but these settings can be overridden by using the Manual mode.

---

## Power Search Mode

**NOTE**

The power search mode cannot be used with bursted signals input via the external IQ inputs.

---

The MXG/EXG has three power search modes (for internal and external I/Q modulation) and four power search references (for external I/Q modulation only). Refer to [Figure 4-23 on page 120](#).

Power search executes a routine that temporarily activates the ALC, calibrates the power of the current RF output, and then disconnects the ALC circuitry.

### Power Search Modes (Applies to External and Internal I/Q Modulation)

- Auto – A power search is executed at each frequency or power change, and at each change to the AM, burst, pulse, or I/Q modulation state.
- Span – When **Power Search** is set to Span, pressing **Do Power Search** executes the power search calibration routine over a range of user-defined frequencies. The power search is stored and used when the signal generator is tuned within a user-defined range. After the Span softkey is pressed, select either **Full** or **User**. If **User** is selected, then the start and stop frequencies need to be selected.
- Manual – When **Power Search** is set to Manual, pressing **Do Power Search** executes the power search calibration routine for the current RF frequency and amplitude. In this mode, if there is a change in RF frequency or amplitude, you will need to press **Do Power Search** again.

### Power Search References (Only applies to Internal I/Q Modulation)

The four Power Search References control the power search function. These four references select the reference voltage used while the RF signal is being I/Q modulated. (Power search references are not used for analog modulation: FM, fM, or pulse modulation.)

**CAUTION**

If the power search reference has the incorrect RMS voltage, the output power will be incorrect. Refer to [Figure 4-24, "Calculating the Output Power Error for a Single Waveform Sample Point"](#) and [Figure 4-25, "Calculating the RMS Voltage of the Waveform."](#)

---

**NOTE**

A successful power search is dependent on a valid power search reference.

---

- Fixed – Reference level is 0.5 Vrms.

This reference functions with internal, external IQ and bursted signals. This is the instrument's default setting.

- RMS – User provided reference level 0–1.414 Vrms placed in the Waveform Header. Refer to **“Saving a Waveform's Settings & Parameters” on page 215.**

This reference functions with internal IQ and bursted signals.

- Manual – User provided reference level 0–1.414 Vrms.

This reference functions with internal, external IQ and bursted signals.

- Modulated – Uses the I/Q modulation signal as the reference level.

This reference functions with internal or external IQ. It is not functional with bursted signals or a signal with varying Vrms.

**Figure 4-24 Calculating the Output Power Error for a Single Waveform Sample Point**

$$\text{The Output Power Error} = 20 \times \log_{10}((V1)/(V2))$$

Where:

V1 is the actual waveform RMS voltage

V2 is the entered RMS voltage

Note: If the RMS voltage value entered is lower than the actual RMS voltage, the output power will be higher than desired. If the RMS voltage value entered is higher than the actual RMS voltage, the output power will be lower than desired.

**Figure 4-25 Calculating the RMS Voltage of the Waveform**

RMS value for the waveform =

$$\sqrt{\sum_{n=1}^N (i_n^2 + q_n^2) \star \frac{1}{N}}$$

N = # of Samples

The signal generator can calculate the RMS value automatically. If more than two contiguous IQ data points are zero, the signal generator calculation ignores those zero points. Also, because the RMS calculation, that is done by the signal generator, is slow and may not be appropriate for your application, it is recommended that the user calculate and enter in their measured RMS value for the waveform file.

SCPI Commands:

```
[;SOURce]:RADio:ARB:HEADER:RMS <"file_name">,<val>|UNSPecified  
[;SOURce]:RADio:ARB:HEADER:RMS? <"file_name">
```

For a programming example of determining the RMS voltage of a waveform, refer to the *Programming Guide* and to the *Documentation CD* that came with this instrument.

The RMS and MANUAL references are the most powerful selections. The user provides the reference level. The IQ signal can be bursted (radar) or have different RMS levels (Wireless Signals). Once the RMS/MANUAL reference level is set, the power search runs independent of the current Vrms value of the waveform.

The RMS and MANUAL references, with a reference level of 1.0 Vrms are equivalent to a calculated rms value of 1 and can be measured using SINE\_TEST\_WFM.

The FIXED, RMS, and MANUAL references use a DAC to apply the reference voltage and do not require the IQ signal to be present.

**NOTE**

The MXG/EXG reference voltage is designed to operate between 0.1 Vrms to 1 Vrms nominally, but it can overrange to 1.414 Vrms. (The RMS can overrange to 1.414, if the constant values are loaded manually and all “1”s are entered for the I and Q values.) See also [“Saving a Waveform’s Settings & Parameters” on page 215.](#)

---

**CAUTION**

The minimum reference level that results in a successful power search is dependent on RF Frequency, RF Amplitude, and Temperature. An MXG/EXG power search using a reference level of 0.1 Vrms for 0 dBm at 1 GHz may fail.

---

## Power Search Settings

For the power search routine to execute, the instrument must be in the following conditions:

- The I/Q modulation enabled On.
- The RF output enabled On.
- The Automatic Leveling Circuitry deactivated (Off).
- The RF Blanking set to On.

This function prevents power spikes during the power search (refer to [“Using the RF Blanking Marker Function” on page 232.](#))

- When using summing for the internal Arb and the external I/Q, all four power reference modes are available (e.g. Fixed, RMS, Manual, and Modulated).
- When using the external IQ inputs, use the MANUAL reference mode, and make sure the external I/Q signal is present when executing a power search. If the external I/Q signal is not present, the power search will fail.

## Example: Automatic Power Search

1. Preset the signal generator.
2. Set the desired frequency.
3. Set the desired amplitude.
4. Turn the RF output on.
5. Deactivate the signal generator’s automatic :

Press **AMPTD > ALC Off On** to highlight Off

Deactivating the signal generator’s automatic leveling control is a significant instrument change that automatically initiates a power search.

When set to Auto, power search automatically executes when a significant instrument setting changes. The Do Power Search feature enables you to decide when to execute a power search to compensate for changes, such as temperature drift or a change in the external input.

## Using an Output Offset, Reference, or Multiplier

### Setting an Output Offset

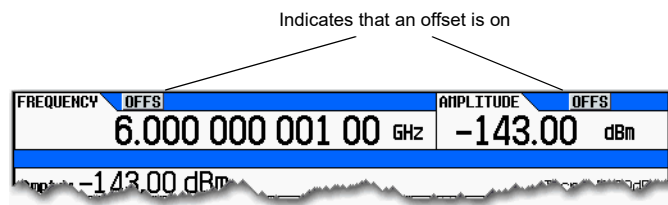
Using an output offset, the signal generator can output a frequency or amplitude that is offset (positive or negative) **from** the entered value.

RF Output = entered value – offset value

Displayed Value = output frequency + offset value

To set an offset:

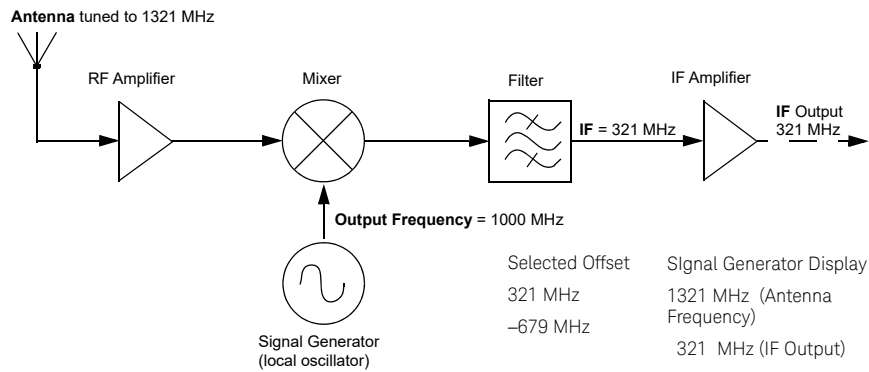
- **Frequency:** Press **Freq** > **Freq Offset** > **offset value** > **frequency unit**.
- **Amplitude:** Press **Amptd** > **More** > **Amptd Offset** > **offset value** > **dB**.



### Examples

Parameter	Example #1	Example #2	Example #3	Comments
Entered (and displayed) Value:	300 MHz	300 MHz	2 GHz	The entered value must be positive.
Offset:	50 MHz	-50 MHz	-1 GHz	An offset value can be positive or negative.
Output Frequency:	250 MHz	350 MHz	3 GHz	The signal generator alerts you if the output frequency or amplitude is out of range.

When using the signal generator as a local oscillator (LO), you can use the offset to display the frequency of interest, as illustrated below:



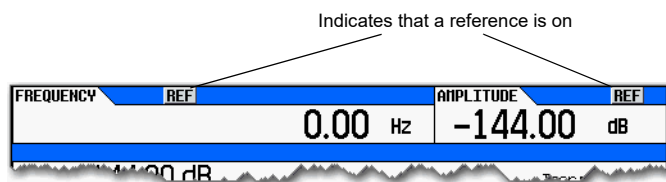
## Setting an Output Reference

Using an output reference, the signal generator can output a frequency or amplitude that is offset (positive or negative) **by** the entered value **from** a chosen reference value.

RF Output = reference value + entered value

To set a reference:

1. Set the frequency or amplitude to the value you want as the output reference level.
2. **Frequency:** Press **Frequency** > **Freq Ref Set**  
The frequency displays 0.00 Hz, indicating that this is the RF output frequency “zero level.” All frequencies entered are interpreted as being relative to this reference frequency.  
**Amplitude:** Press **Amptd** > **More** > **Amptd Ref Set**  
The amplitude displays 0.00 dB, indicating that this is the RF output amplitude “zero level.” All amplitudes entered are interpreted as being relative to this reference amplitude.



## Examples

Parameter	Example #1	Example #2	Example #3	Comments
Reference:	50 MHz	50 MHz	2 GHz	A reference value must be positive.
Entered (and displayed) Value:	2 MHz	-2 MHz	-1 GHz	The entered value can be positive or negative.
Output Frequency:	52 MHz	48 MHz	1 GHz	The signal generator alerts you if the output frequency or amplitude is out of range.

Optimize Performance  
Using an Output Offset, Reference, or Multiplier

To set a new frequency or amplitude reference, turn the frequency reference off, and then follow the steps above.

## Setting a Frequency Multiplier

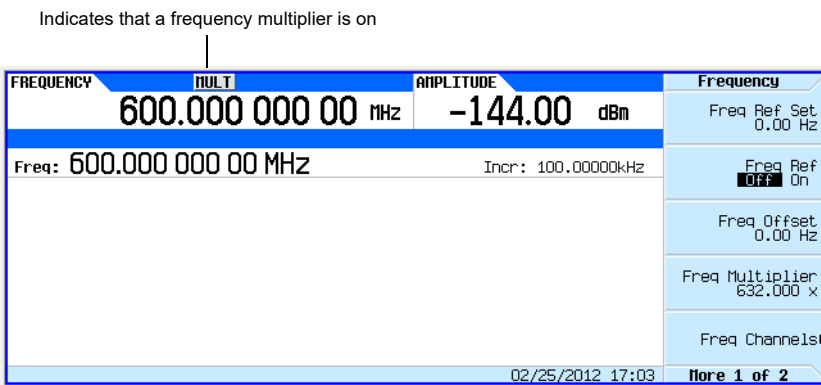
Using a frequency multiplier, the signal generator can display a frequency that is the multiple (positive or negative) of the output value.

Displayed Value = multiplier value × output frequency

Output Frequency = displayed value ÷ multiplier value

To set a frequency multiplier:

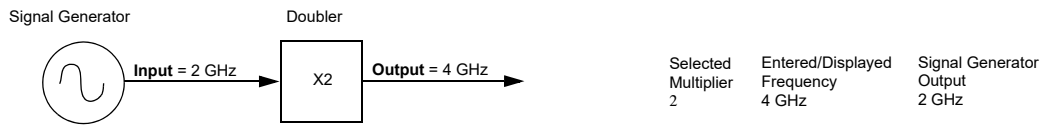
1. Press **Frequency > Freq Multiplier > multiplier value > x**.
2. Set the desired frequency.  
The display equals the output frequency times the multiplier value.



## Examples

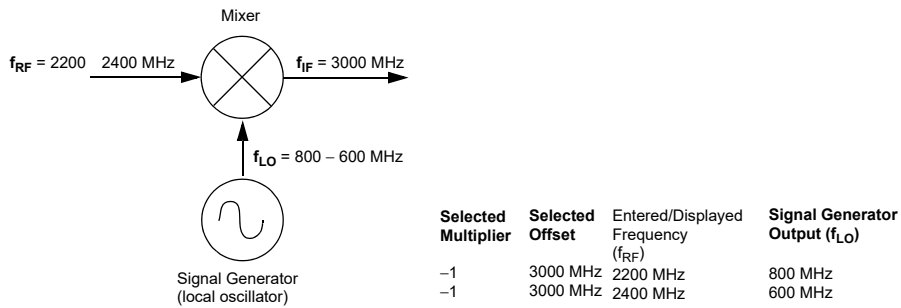
Parameter	Example #1	Example #2	Example #3	Comments
Frequency Multiplier:	3	-3	4	The multiplier range can be set from: +0.001 to +1000 -1000 to -0.001
Entered (and displayed) Value:	600 MHz	-600 MHz	8 GHz	
Output Frequency:	200 MHz	200 MHz	2 GHz	The signal generator alerts you if the output frequency is out of range.

When using the signal generator as the input to a system, you can set the frequency multiplier so that the signal generator displays the output of the system, as illustrated below using a doubler:



When measuring mixers, the frequency multiplier and frequency offset are often used together. In the upconverter example below, the multiplier is set to

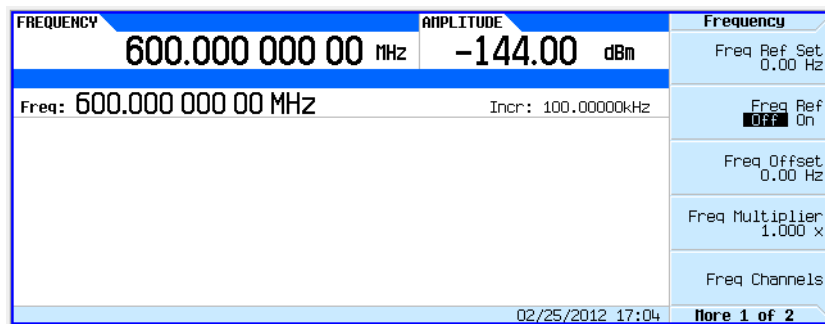
-1 and the offset is set to 3 GHz so that the signal generator displays  $f_{RF}$ .



## Using the Frequency and Phase Reference Softkeys

The MXG/EXG can be set to have either a user-determined frequency or phase reference.

Figure 4-26 Frequency Reference and Frequency Offset Softkeys



## Using Free Run, Step Dwell, and Timer Trigger

**Free Run, Step Dwell** (time), and **Timer Trigger** can be used to adjust the time spent at any point in a Step Sweep or a List Sweep. There are two possible measurement combinations:

**Free Run with Step Dwell time** (Figure 4-27 on page 129) the signal generator waits for the signal to settle and then waits for the Step Dwell time, then it jumps to the next frequency point. In addition, the time to complete the entire sweep can vary. There is **always** a minimum value of Step Dwell for each frequency point. The minimum Step Dwell timing for any point is fixed at a value of 100 us. The time between frequency points is the sum of the settling time, plus the Step Dwell time. The settling time is dependent on frequency, amplitude, band crossings, and other factors, so the time between frequency points can vary.

**Timer Trigger instead of Free Run** (Figure 4-27 on page 129) the signal generator generates equally spaced triggers, and it moves to the next point at each trigger. This has the advantage that the time between points is consistent and the overall sweep time is consistent. But, if the trigger is too fast, the signal may not have time to settle before jumping to the next point.

### Understanding Free Run, Step Dwell, and Timer Trigger Setup

If the signal is to be settled for a minimum specific time at each point and it is **not** important if the point to point time is consistent, use **Free Run** and **Set Dwell** time.

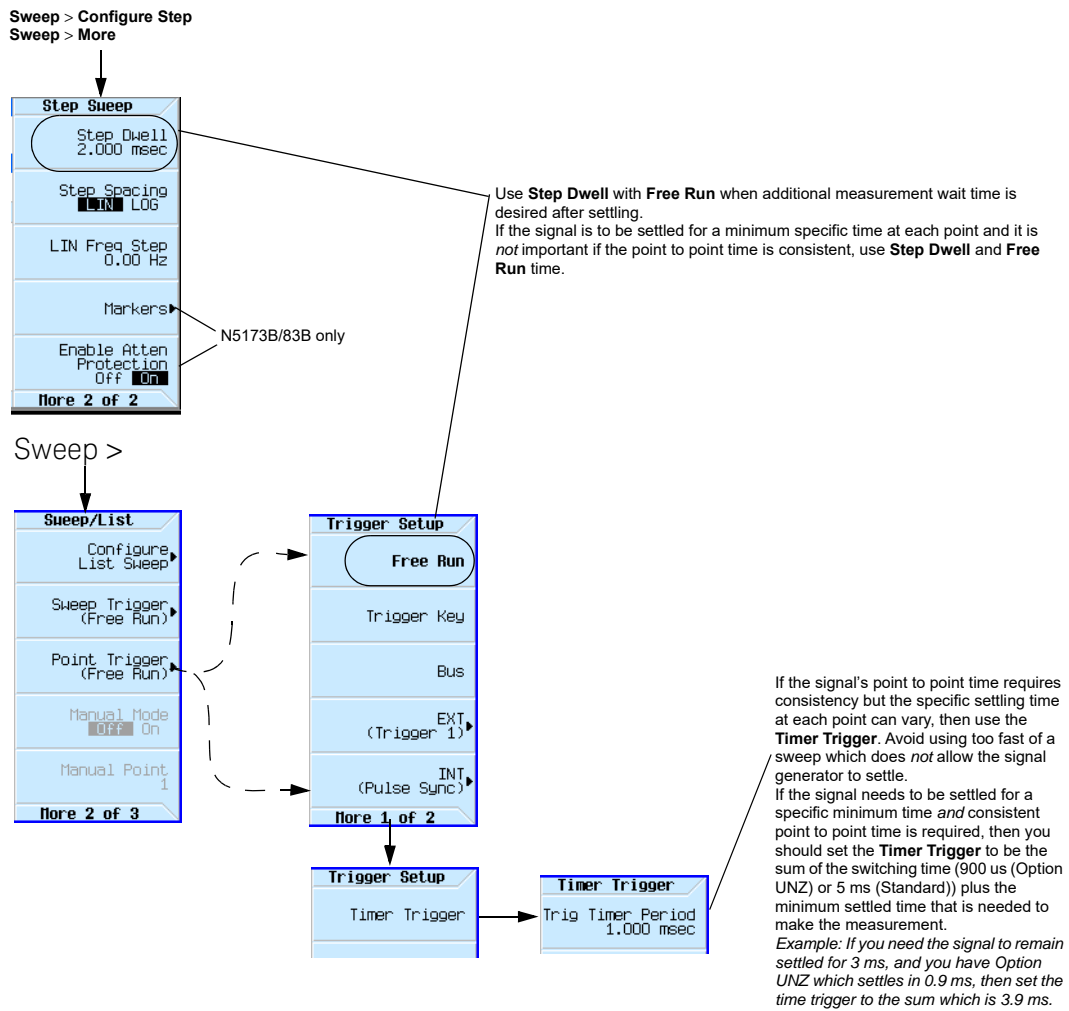
If the signal's point to point time requires consistency but the specific settling time at each point can vary, then use the Timer Trigger. Avoid using too fast of a sweep which does **not** allow the signal generator to settle.

If the signal needs to be settled for a specific minimum time **and** consistent point to point time is required, then you should set the Timer Trigger to be the sum of the switching time (900 us or 5 ms, depending on options) **plus** the minimum settled time that is needed to make the measurement.

If the measurement requires external equipment synchronization, consider using hardware triggers.



Figure 4-27 Free Run, Set Dwell, and Timer Trigger Softkeys



For details on each key, use key help as described on see [page 58](#).

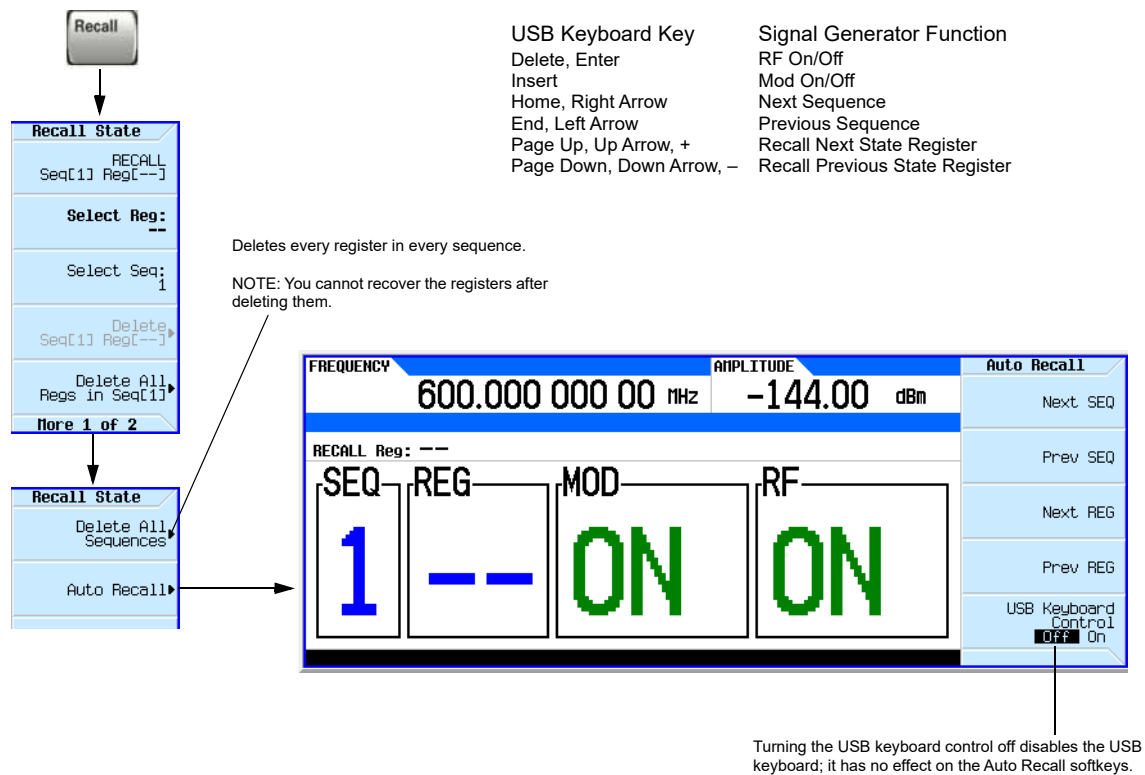
## Using a USB Keyboard

You can use a USB keyboard to remotely control the RF output state, the modulation state, and to select a memory sequence and register.

The register selection, RF output state, and modulation state are affected by power cycle or preset, but the USB keyboard control state and the sequence selection are not.

### CAUTION

To avoid the loss of data, GPIB settings, or current user instrument states that have not been permanently saved to nonvolatile memory, the signal generator should always be powered down either via the instrument's front panel power button or the appropriate SCPI command. Signal generators installed in rack systems and powered down with the system rack power switch rather than the instrument's front panel switch display a Error -310 due to the instrument not being powered down correctly.



For details on each key, use key help as described on [page 58](#).

## 5 Avionics VOR/ILS (Option N5180302B)

### NOTE

With firmware version B.01.75 or later, option numbers for software internal to the instrument have changed. For more information, see [“Enabling an Option” on page 53](#).

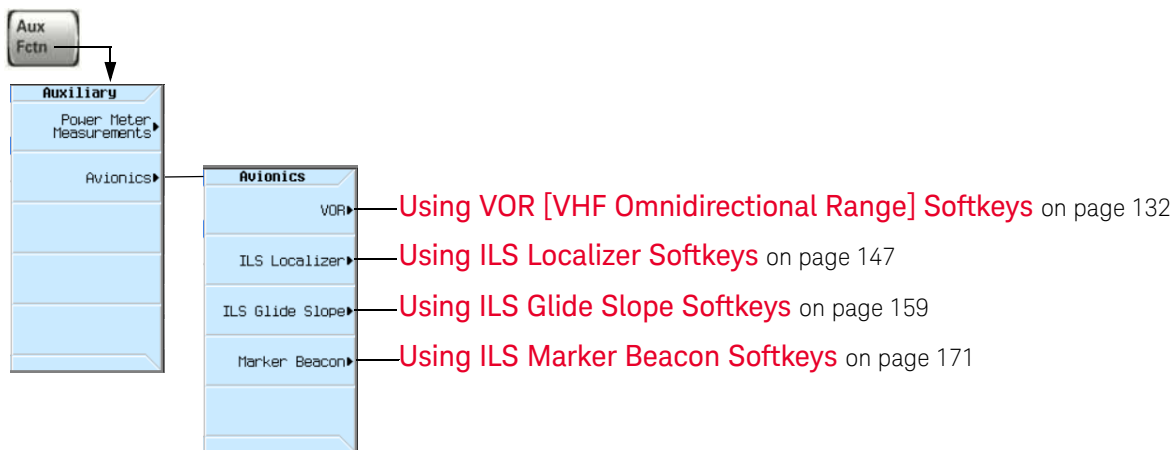
This chapter describes the avionics softkeys used by Keysight N5171B/72B EXG and N5181B/82B MXG X-Series signal generators with Option N5180302B Avionics License during either VOR [VHF Omnidirectional Ranging] or ILS [Instrument Landing System] aircraft navigation receiver test. Avionics is a term used to describe the electronic instrumentation on aircraft.

Before using the information in this chapter, you should be familiar with the basic operation of the signal generator. If you are not comfortable with functions such as setting the power level and frequency, refer to [Chapter 3, “Basic Operation”, on page 57](#) and familiarize yourself with the information in that chapter.

Use the Aux Fctn [Auxiliary Functions] key to access the Avionics softkeys.

Figure 5-1

Avionics Softkeys



## Using VOR [VHF Omnidirectional Range] Softkeys

The purpose of the VOR system is to provide directional information for aircraft in flight. VOR ground based transmitter stations are strategically located to provide complete coverage for air traffic. Each VOR ground based transmitter station radiates a carrier in the range from 108.00 to 117.95 MHz, which is modulated in a way that provides aircraft bearing information relative to the VOR ground based transmitter location.

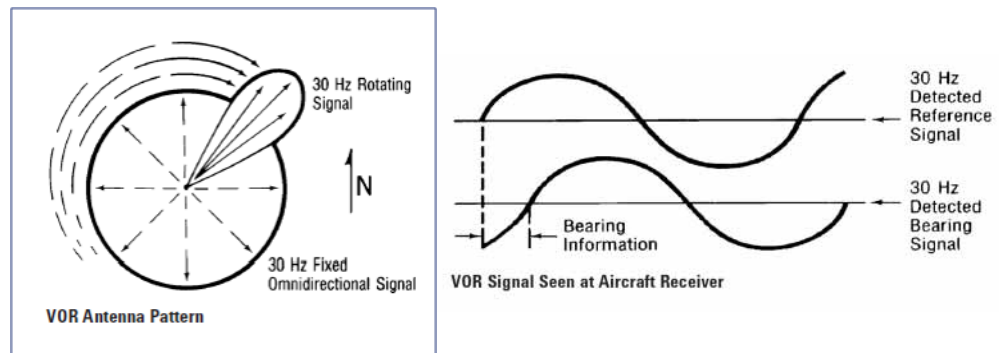
The VOR radiated electromagnetic signal consists of the sum of two antenna's signals radiating at the same RF carrier frequency:

- The first antenna signal is from a non-directional antenna radiating a carrier that is AM modulated by a signal that varies from 9480 Hz to 10440 Hz and back 30 times per second.
- The second antenna signal is from a horizontal dipole which rotates at a rate of 30 revolutions per second. The dipole produces a figure-eight pattern. The RF voltages are opposite in polarity on front and back side of the dipole pattern. Since the RF on one side is in phase with the RF radiated from the non-directional antenna, a cardioid field pattern, which rotates at 30 Hz is formed. The signal received by the aircraft is an RF carrier with amplitude varying at 30 Hz which is caused by the rotating cardioid pattern. The carrier is also amplitude modulated by the 9960 Hz frequency modulated sub-carrier. The 30 Hz FM signal provides the phase reference and the 30 Hz AM caused by the cardioid pattern provides the variable phase signal.

By demodulating the transmitted VOR signal, an aircraft receiver can compare the phases of the two 30 Hz signals (REF Freq vs VAR Freq) to determine the compass bearing to a VOR station. By tuning to two or more VOR stations and recording each bearing angle, pilots can determine their exact location on an air chart by triangulation. A VOR Bearing Angle is the phase difference between the 30 Hz reference signal (REF Freq) and the 30 Hz variable phase signal (VAR Freq). The 30 Hz reference signal (REF Freq) is transmitted from the ground-based stationary VOR transmitter while the 30 Hz variable phase signal (VAR Freq) is transmitted from the VOR signal that is rotating at 30 Hz clockwise.

Figure 5-2

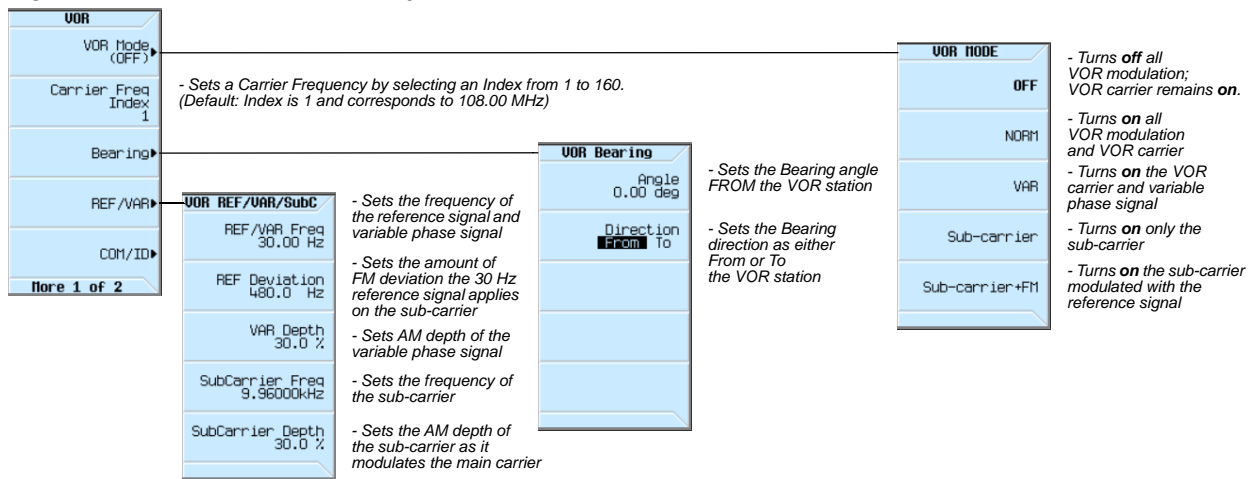
VOR Transmitter Antenna Pattern



Avionics VOR/ILS (Option N5180302B)  
Using VOR [VHF Omnidirectional Range] Softkeys

When using an X-Series signal generator with Option N5180302B Avionics License to simulate VOR signals, the 30 Hz reference signal (REF Freq) is placed on a sub-carrier of 9960 Hz (SubCarrier Freq) using frequency modulation with a peak deviation set to 480 Hz (REF Deviation). This frequency modulated sub-carrier is then amplitude modulated onto one of the VOR carriers (108.00 to 117.95 MHz). This makes the reference signal essentially an FM/AM multiplex signal.

Figure 5-3 VOR Softkeys



When testing a VOR system, the following VOR parameters can be set:

VOR Menu	Parameters	Default State
VOR Mode		OFF
Carrier Freq Index	1	108.00 MHz
Bearing menu	Angle	0.00 Deg
	Direction	From
REF/VAR menu	REF/VAR Freq	30.00 Hz
	REF Deviation	480.0 Hz
	VAR Depth	30.0%
	SubCarrier Freq	9.96000 kHz
	SubCarrier Depth	30.0%
COM/ID menu <sup>a</sup>		

a. For information on the COM/ID menu, refer to **“Using COM/ID Softkeys” on page 142.**

To set the VOR mode that produces a full or partial VOR signal

1. Press **Aux Fctn > Avionics > VOR**
2. Press **VOR Mode**  
(Default selection is **OFF**.)
3. Select either: **OFF | NORM | VAR | Sub-carrier | Sub-carrier+FM**
  - Selecting **OFF** turns off all VOR modulation. When set to **OFF**, all VOR mode parameter settings are turned off, but the selected VOR carrier is still present on the RF Output connector. To turn off this VOR carrier, set **RF Off/On** to **Off**.
  - Selecting **NORM** turns on all VOR signals so that a standard VOR signal is generated with a default VOR Bearing of zero degrees.
  - Selecting **VAR** turns on the main VOR carrier and the 30 Hz variable phase signal (**VAR Freq**); suppresses the **Sub-carrier**.
  - Selecting **Sub-carrier** turns on the **Sub-carrier** without the 30 Hz reference signal (**REF Freq**); suppresses the main VOR carrier.
  - Selecting **Sub-carrier+FM** turns on the **Sub-carrier** and the 30 Hz reference signal (**REF Freq**); suppresses the main VOR carrier.

To set the VOR carrier frequency

1. Press **Aux Fctn > Avionics > VOR**
2. Press **Carrier Freq Index**  
(Default value is 1 and corresponds to 108.00 MHz.)
3. Select a value from 1 to 160 and press **Enter**.

The index value that is entered sets the VOR carrier frequency to one of the standard defined corresponding values and produces a VOR carrier.

VOR carrier frequencies range from 108.00 to 117.95 MHz and can be set by selecting index values from 1 to 160.

ILS Localizer frequencies range from 108.10 to 111.95 MHz, which overlaps the VOR carrier frequency range, and can be set by selecting index values from 1 to 40. (For information, see: **“To set the ILS Localizer carrier frequency” on page 150.**)

Because VOR carrier frequencies and ILS Localizer carrier frequencies have a frequency range that overlaps, only frequencies where the 100 kHz digit is even (tenths of a megacycle count is even) are used as VOR carrier frequencies.

The default VOR carrier frequency Index is 1 and corresponds to 108.00 MHz.

VOR Carrier Frequencies (MHz)		Carrier Freq Index = 1 to 160			
1 to 32	33 to 64	65 to 96	97 to 128	129 to 160	

Avionics VOR/ILS (Option N5180302B)  
 Using VOR [VHF Omnidirectional Range] Softkeys

108.00	111.20	113.20	114.80	116.40
108.05	111.25	113.25	114.85	116.45
108.20	111.40	113.30	114.90	116.50
108.25	111.45	113.35	114.95	116.55
108.40	111.60	113.40	115.00	116.60
108.45	111.65	113.45	115.05	116.65
108.60	111.80	113.50	115.10	116.70
108.65	111.85	113.55	115.15	116.75
108.80	112.00	113.60	115.20	116.80
108.85	112.05	113.65	115.25	116.85
109.00	112.10	113.70	115.30	116.90
109.05	112.15	113.75	115.35	116.95
109.20	112.20	113.80	115.40	117.00
109.25	112.25	113.85	115.45	117.05
109.40	112.30	113.90	115.50	117.10
109.45	112.35	113.95	115.55	117.15
109.60	112.40	114.00	115.60	117.20
109.65	112.45	114.05	115.65	117.25
109.80	112.50	114.10	115.70	117.30
109.85	112.55	114.15	115.75	117.35
110.00	112.60	114.20	115.80	117.40
110.05	112.65	114.25	115.85	117.45
110.20	112.70	114.30	115.90	117.50
110.25	112.75	114.35	115.95	117.55
110.40	112.80	114.40	116.00	117.60
110.45	112.85	114.45	116.05	117.65
110.60	112.90	114.50	116.10	117.70
110.65	112.95	114.55	116.15	117.75
110.80	113.00	114.60	116.20	117.80
110.85	113.05	114.65	116.25	117.85
111.00	113.10	114.70	116.30	117.90
111.05	113.15	114.75	116.35	117.95

To set the VOR bearing angle between the VAR signal and the REF signal

1. Press Aux Fctn > Avionics > VOR
2. Press Bearing
3. Press Angle  
(Default value is 0.00 deg.)
4. Select a <value> from 0 to 360 deg and press Enter.

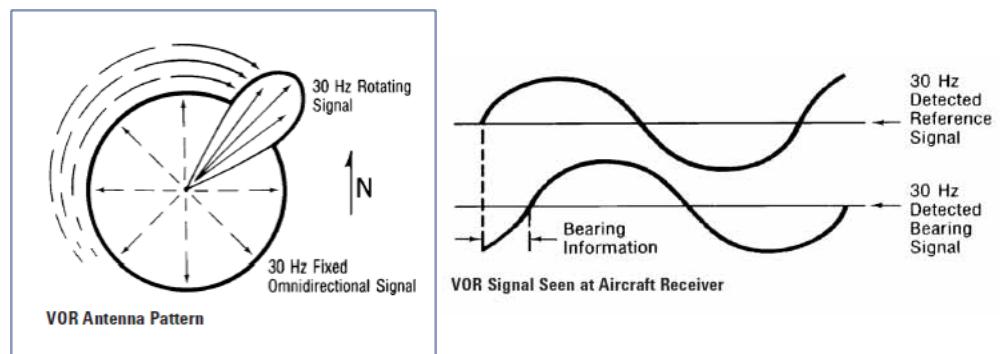
By demodulating the transmitted VOR signal, an aircraft receiver can compare the phases of the two 30 Hz signals (REF Freq vs VAR Freq) to determine the compass bearing to a VOR station. By tuning to two or more VOR stations and recording each bearing angle, pilots can determine their exact location on an air chart by triangulation.

A VOR Bearing Angle is the phase difference between the 30 Hz reference signal (REF Freq) and the 30 Hz variable phase signal (VAR Freq).

The 30 Hz reference signal (REF Freq) is transmitted from the ground-based stationary VOR transmitter while the 30 Hz variable phase signal (VAR Freq) is transmitted from the VOR signal that is rotating at 30 Hz clockwise.

Figure 5-4

#### VOR Transmitter Antenna Pattern





To set the VOR bearing direction as From or To

1. Press Aux Fctn > Avionics > VOR
2. Press Bearing
3. Press Direction  
(Default selection is From.)
4. Select either From | To

**From** - In the From convention, the VOR transmitter beacon is made the reference point and the Bearing Angle is between local magnetic-North and the beacon-to-aircraft radial line (RL).

**To** - In the To convention, the aircraft is made the reference point and the Bearing Angle is between local magnetic-North and the aircraft-to-beacon radial line (RL).

$$RL(\text{To}) = 180^\circ - RL(\text{From})$$

To set the frequency of the reference signal (REF Freq) and the variable phase signal (VAR Freq)

1. Press Aux Fctn > Avionics > VOR
2. Press REF/VAR
3. Press REF/VAR Freq  
(Default value is 30 Hz.)
4. Select a value in Hz | kHz | MHz | GHz from 10 to 60 Hz.

Enter a value in Hz to set the frequency of the reference signal (REF Freq) and the variable phase signal (VAR Freq).

To set the amount of FM deviation that the 30 Hz reference signal (REF Freq) applies on the sub-carrier

1. Press Aux Fctn > Avionics > VOR
2. Press REF/VAR
3. Press REF Deviation  
(Default value is 480 Hz.)
4. Select a value in Hz | kHz | MHz | GHz from 0 Hz to 1 kHz.

Enter a value in Hz to set the amount of FM Deviation that the 30 Hz reference signal (REF Freq) applies on the sub-carrier.

The 30 Hz reference signal (REF Freq) is placed on a sub-carrier of 9960 Hz (SubCarrier Freq) using frequency modulation with a peak deviation set to 480 Hz (REF Deviation). This frequency modulated sub-carrier is then

amplitude modulated onto one of the VOR carriers (108.00 to 117.95 MHz). This makes the reference signal essentially an FM/AM multiplex signal.

To set the AM depth of the variable phase signal (VAR Freq)

1. Press Aux Fctn > Avionics > VOR
2. Press REF/VAR
3. Press VAR Depth  
(Default value is 30%.)
4. Select a value from 0 to 49.9% and press Enter.

Enter a value in percentage to set the AM depth of the variable phase signal (VAR Freq).

To set the frequency of the sub-carrier signal (SubCarrier Freq)

This process sets the frequency of the sub-carrier for a VOR signal.

1. Press Aux Fctn > Avionics > VOR
2. Press REF/VAR
3. Press SubCarrier Freq  
(Default value is 9960 Hz.)
4. Select a value in Hz | kHz | MHz | GHz from 0 Hz to 20 kHz.

The 30 Hz reference signal (REF Freq) is placed on a sub-carrier of 9960 Hz (SubCarrier Freq) using frequency modulation with a peak deviation set to 480 Hz (REF Deviation). This frequency modulated sub-carrier is then amplitude modulated onto a VOR carrier (108.00 to 117.95 MHz). This makes the reference signal essentially an FM/AM multiplex signal.

To set the sub-carrier AM depth that modulates the VOR carrier

1. Press Aux Fctn > Avionics > VOR
2. Press REF/VAR
3. Press SubCarrier Depth  
(Default value is 30%.)
4. Select a value from 0 to 49.9% and press Enter.

Enter a value in percentage to set the Sub-carrier AM depth as it modulates the main carrier of a VOR signal.

Sub-carrier AM depth is typically 30%, but can range from 0 to 49.9%.

To set or return the VOR subsystem parameters to a default state

This process returns the VOR system parameters to a set of default state conditions.

1. Press Aux Fctn > Avionics > VOR
2. Press More 1 of 2
3. Press Recall Default Settings

VOR Menu	Parameters	Default State
VOR Mode		OFF
Carrier Freq Index	1	108.00 MHz
Bearing menu	Angle	0.00 Deg
	Direction	From
REF/VAR menu	REF/VAR Freq	30.00 Hz
	REF Deviation	480.0 Hz
	VAR Depth	30.0%
	SubCarrier Freq	9.96000 kHz
	SubCarrier Depth	30.0%
COM/ID menu <sup>a</sup>		

- a. For information on the COM/ID menu, refer to **“Using COM/ID Softkeys” on page 142.**

Example of Setting All VOR Parameters

1. Press Preset to place the signal generator in a known preset state.
2. Set the VOR carrier frequency.
  - a. Press Aux Fctn > Avionics > VOR
  - b. Press Carrier Freq Index  
(Default value is 1 and corresponds to 108.00 MHz carrier frequency.)
  - c. (Optional) Select a value from 1 to 160 and press Enter to change to a different carrier frequency.
3. Set the VOR bearing angle between the VAR signal and the REF signal.
  - a. Press Bearing
  - b. Press Angle  
(Default value is 0.00 deg.)
  - c. (Optional) Select a value from 0 to 360 deg and press Enter.

4. Set the VOR bearing direction as From or To.
  - a. Press Direction  
(Default selection is From.)
  - b. (Optional) Select either From | To
5. Set the frequency of the reference signal (REF Freq) and variable phase signal (VAR Freq).
  - a. Press Return
  - b. Press REF/VAR
  - c. Press REF/VAR Freq  
(Default value is 30 Hz.)
  - d. (Optional) Select a <value> from 10 to 60 Hz.
6. Set the amount of FM deviation that the 30 Hz reference signal (REF Freq) applies on the sub-carrier.
  - a. Press REF Deviation  
(Default value is 480 Hz.)
  - b. (Optional) Select a <value> from 0 Hz to 1 kHz.
7. Set the AM depth of the variable phase signal (VAR Freq).
  - a. Press VAR Depth  
(Default value is 30%.)
  - b. (Optional) Select a <value> from 0 to 49.9% and press Enter.
8. Set the frequency of the sub-carrier signal.
  - a. Press SubCarrier Freq  
(Default value is 9960 Hz.)
  - b. (Optional) Select a <value> from 0 Hz to 20 kHz.
9. Set the sub-carrier AM depth that modulates the VOR carrier.
  - a. Press SubCarrier Depth  
(Default value is 30%.)
  - b. (Optional) Select a <value> from 0 to 49.9% and press Enter.
10. Set the VOR mode to produce a full VOR signal.
  - a. Press Aux Fctn > Avionics > VOR
  - b. Press VOR Mode  
(Default selection is OFF.)
  - c. Select NORM to turn on all VOR signals so that a standard VOR signal is generated with a default VOR Bearing of zero degrees.

**11. Set modulation to on.**

- a. Press MOD On and verify that the front panel LED is illuminated, indicating that it is on.  
(Default is on).

**12. Set a desired RF power level.**

- a. Press Amptd  
(Default power level is around -144 dBm, and depends on the signal generator model being used, so the signal may be very low and hard to find if you do not specify a high enough power level.)
- b. Select a value from -20 dBm to -40 dBm.

**13. Set RF output to on.**

- a. Press RF On and verify that the front panel LED is illuminated, indicating that it is on.  
(Default is off).

**14. Verify that all settings are as expected on the signal generator display.**

- a. Press Aux Fctn > Avionics > VOR
- b. Review the settings under  
VOR Status Information

## Using COM/ID Softkeys

The purpose of COM/ID commands are to set parameters related to airport communication identification codes. (This code may also be referred to as an, “airport call-sign”.)

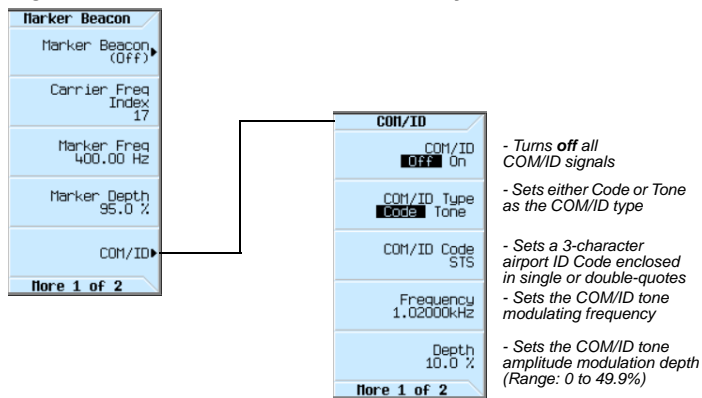
During VOR and ILS testing, a COM/ID code can be transmitted as a three letter Morse-code signal of 1.02000 kHz and is placed on the carrier; this COM/ID code is used to identify the ground-based transmitting station.

Each COM/ID code (airport identification code) must correspond to one of the International Air Transport Association (IATA) codes.

IATA owns, controls, and has a copyright to the complete list of airport identification codes; STS is the airport identification code that refers to the Sonoma County Airport in Santa Rosa, CA, USA.

Figure 5-5

### COM/ID Softkeys



When testing a VOR [VHF Omnidirectional Ranging] or ILS [Instrument Landing System], the following COM/ID parameters can be set:

COM/ID Menu	Parameters	Default State
	COM/ID Off/On	Off
	COM/ID Code/Type	Code
	COM/ID Code	STS
	Frequency	1.02000 kHz
	Depth	10.0%

## To set the COM/ID on or off

This process toggles COM/ID Off (0) or On (1).

1. Press Aux Fctn > Avionics > VOR
2. Press COM/ID  
(Default is COM/ID Off.)
3. Select either COM/ID Off | COM/ID On

When COM/ID is set to Off, all COM/ID functions are turned off and must be set to On before any of the other COM/ID parameters have an effect.

## To set the COM/ID type between Code or Tone

1. Press Aux Fctn > Avionics > VOR
2. Press COM/ID
3. Press COM/ID Type
4. Select either Code | Tone

**Code** - When set to Code, the signal generator plays the code associated with the COM/ID Code setting.

- To change the COM/ID Code setting, see [“To set the COM/ID 3-character code \(airport identification code\)” on page 143](#)

**Tone** - When set to Tone, the COM/ID Code setting is disabled and the signal generator plays a continuous tone based on the COM/ID Frequency setting.

- To change the COM/ID Tone setting, see [“To set the COM/ID tone/code modulating frequency” on page 144](#)

## To set the COM/ID 3-character code (airport identification code)

1. Press Aux Fctn > Avionics > VOR
2. Press COM/ID
3. Press COM/ID Code  
(Default 3-character code is STS.)
4. Select a 3-character code and select Enter.

Enter a valid COM/ID code (airport identification code) by typing a 3-character code (for example, STS).

This value sets the airport communication identification code to be played by the COM/ID generator. (This value/code may also be referred to as an, “airport call-sign”).

The COM/ID code is transmitted as a three letter-code signal of 1.02000 kHz and is placed on the VOR carrier; this COM/ID code is used to identify the VOR ground-based transmitting station.

Each COM/ID code (airport identification code) must correspond to one of the International Air Transport Association (IATA) codes.

IATA owns, controls, and has a copyright to the complete list of airport identification codes; STS is the airport identification code that refers to the Sonoma County Airport in Santa Rosa, CA, USA.

To find a valid COM/ID code (airport communication identification code) for a particular area, refer to the following websites:

**[Airline Coding Directory \(http://www.iata.org\)](http://www.iata.org)**

**[AirNav \(http://www.airnav.com\)](http://www.airnav.com)**

To set the COM/ID tone/code modulating frequency

1. Press Aux Fctn > Avionics > VOR
2. Press COM/ID
3. Press Frequency  
(Default value is 1.02000 kHz.)
4. Select a value in Hz | kHz | MHz | GHz from 0 Hz to 20 kHz.

Enter a value in Hz to set the frequency of the COM/ID tone modulating frequency.

To set the COM/ID tone AM depth

1. Press Aux Fctn > Avionics > VOR
2. Press COM/ID
3. Press Depth  
(Default value is 10%.)
4. Select a value from 0 to 49.9% and press Enter.

Enter a value in percentage to set the COM/ID tone AM depth.



To set or return the COM/ID parameters to a default state

1. Press Aux Fctn > Avionics > VOR
2. Press COM/ID
3. Press More 1 of 2
4. Press Recall Default Settings

Selecting these softkeys returns the COM/ID parameters to a set of default state conditions.

COM/ID Menu	Parameters	Default State
	COM/ID Off/On	Off
	COM/ID Code/Type	Code
	COM/ID Code	STS
	Frequency	1.02000 kHz
	Depth	10.0%

Example of Setting All COM/ID Parameters

1. Press Preset to place the signal generator in a known preset state.
2. Set the COM/ID type to Code.
  - a. Press Aux Fctn > Avionics > VOR
  - b. Press COM/ID
  - c. Press COM/ID Type  
(Default setting is Code.)
  - d. Select Code

3. Set the COM/ID 3-character code (airport identification code).

- a. Press COM/ID Code  
(Default 3-character code is STS.)

- b. (Optional) Select a 3-character code and select Enter.

To find a valid COM/ID code (airport communication identification code) for a particular area, refer to the following websites:

[Airline Coding Directory \(http://www.iata.org\)](http://www.iata.org)

[AirNav \(http://www.airnav.com\)](http://www.airnav.com)

4. Set the COM/ID tone/code modulating frequency.

- a. Press Frequency  
(Default value is 1.02000 kHz.)



## Using ILS Localizer Softkeys

An ILS [Instrument Landing System] is a navigation system, used by aircraft to obtain guidance to a runway (performing a “runway approach” while attempting to land the aircraft) and includes the following three functions operating in tandem (working together):

- ILS Localizer - ensures that the lateral/horizontal left-right approach of an aircraft is aligned with the center of a runway
- ILS Glide Slope - ensures that the vertical descent path of an aircraft is aligned to the proper descent path (~ 3 degrees downwards slope) of a runway
- ILS Marker Beacons - ensures the proper distance from a runway; the distances are based on the Outer, Middle, and Inner ILS Marker Beacons

The purpose of the ILS Localizer is to provide signals that indicate whether an aircraft is left, right, or in-line with the glide path to a runway and enables a pilot to adjust the aircraft left or right correctly during landing. This lateral/horizontal correction is performed using two AM signals with an AM depth of 20%, operating at a carrier frequency range between 108.10 to 111.95 MHz.

For an aircraft on approach, using the ILS Localizer to land on a runway, the left signal is modulated at a frequency of 90 Hz AM by default and the right signal is modulated at a frequency of 150 Hz AM by default.

The primary mechanism which makes it possible for a pilot to obtain guidance to a runway is the aircraft receiver's ability to detect the “Difference in Depth of Modulation (DDM)” between this 90 Hz and 150 Hz amplitude modulation.

Figure 5-6 ILS Localizer: 108.10 MHz w/ 90 Hz AM (Left), 150 Hz AM (Right) @ 20%

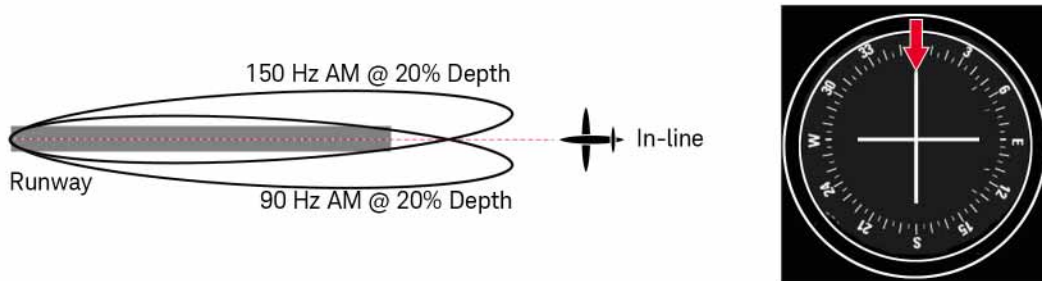


Figure 5-7 ILS Glide Slope: 334.70 MHz w/ 90 Hz AM (Up), 150 Hz AM (Down) @ 40%

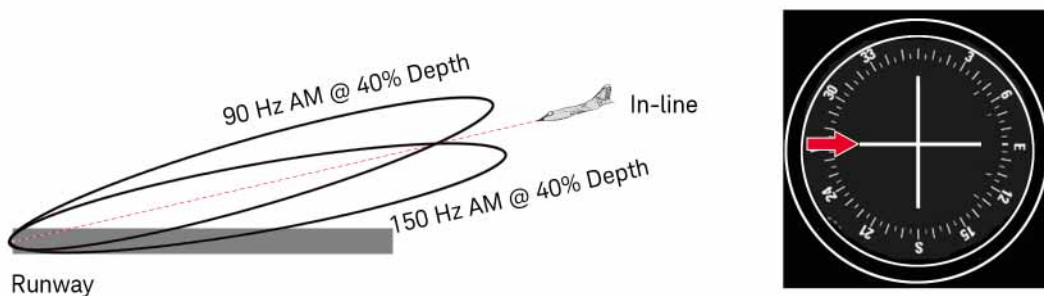


Figure 5-8 ILS Marker Beacons: 75 MHz, Inner 3000 Hz, Middle 1300 Hz, Outer 400 Hz

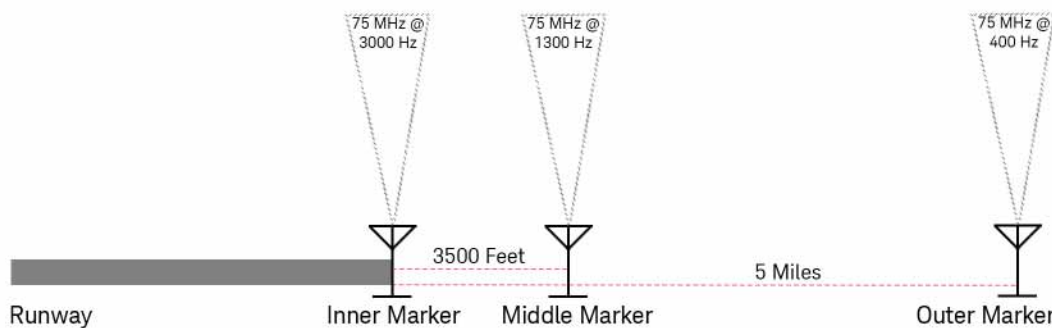
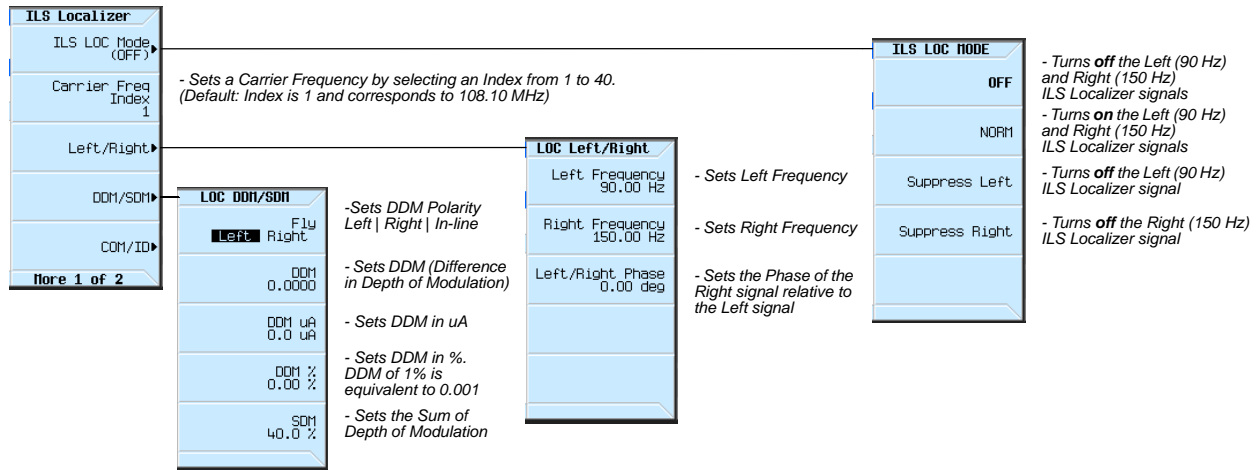


Figure 5-9 ILS Localizer Softkeys



When testing an ILS [Instrument Landing System], the following ILS Localizer parameters can be set:

ILS Localizer Menu	Parameters	Default State
ILS LOC Mode		OFF
Carrier Freq Index	1	108.10 MHz
Left/Right menu	Left Frequency	90 Hz
	Right Frequency	150 Hz
	Left/Right Phase	0.00 deg
DDM/SDM menu	Fly Left/Right	None
	DDM	0.0000
	DDM uA	0.0 uA
	DDM%	0.00%
	SDM	40.0%
COM/ID menu <sup>a</sup>		

a. For information on the COM/ID menu, refer to **“Using COM/ID Softkeys” on page 142.**

To set the ILS Localizer mode to produce a full or partial signal

1. Press Aux Fctn > Avionics > ILS Localizer
2. Press ILS LOC Mode (Default selection is OFF.)

### 3. Select either: OFF | NORM | Suppress Left | Suppress Right

These softkeys allow selection of a complete or partial ILS Localizer signal and can set the ILS Localizer Mode to one of the following:

- Selecting **OFF** turns off both the Left (90 Hz) and the Right (150 Hz) ILS Localizer signals. When set to OFF, all ILS Localizer mode parameter settings are turned off, but the selected ILS Localizer carrier is still present on the RF Output connector. To turn off this ILS Localizer carrier, set RF Off/On to Off.
- Selecting **NORM** turns on both the Left (90 Hz) and the Right (150 Hz) ILS Localizer signals.
- Selecting **Suppress Left** turns off the Left (90 Hz) ILS Localizer signal.
- Selecting **Suppress Right** turns off the Right (150 Hz) ILS Localizer signal.

To set the ILS Localizer carrier frequency

1. Press Aux Fctn > Avionics > ILS Localizer
2. Press Carrier Freq Index  
(Default value is 1 and corresponds to 108.10 MHz.)
3. Select a value from 1 to 40 (108.10 to 111.95 MHz) and press Enter.

These softkeys set a carrier index between 1 and 40.

Each index corresponds to a standard defined ILS Localizer carrier channel in the range from 108.10 to 111.95 MHz.

There are forty channels that are allocated to the ILS Localizer in the range from 108.10 to 111.95 MHz; each ILS Localizer carrier has a corresponding ILS Glide Slope carrier frequency in the range from 329.15 to 335.00 MHz.

The default ILS Localizer carrier frequency Index is 1 and corresponds to 108.10 MHz.

ILS Localizer and Corresponding ILS Glide Slope Carrier Frequencies (MHz)			
ILS Localizer (MHz) Index 1-20	ILS Glide Slope (MHz) Index 1-20	ILS Localizer (MHz) Index 21-40	ILS Glide Slope (MHz) Index 21-40
<b>1=108.10</b>	1=334.70	21=110.10	21=334.40
2=108.15	2=334.55	22=110.15	22=334.25
3=108.30	3=334.10	23=110.30	23=335.00
4=108.35	4=333.95	24=110.35	24=334.85
5=108.50	5=329.90	25=110.50	25=329.60
6=108.55	6=329.75	26=110.55	26=329.45

Avionics VOR/ILS (Option N5180302B)  
Using ILS Localizer Softkeys

7=108.70	7=330.50	27=110.70	27=330.20
8=108.75	8=330.35	28=110.75	28=330.05
9=108.90	9=329.30	29=110.90	29=330.80
10=108.95	10=329.15	30=110.95	30=330.65
11=109.10	11=331.40	31=111.10	31=331.70
12=109.15	12=331.25	32=111.15	32=331.55
13=109.30	13=332.00	33=111.30	33=332.30
14=109.35	14=331.85	34=111.35	34=332.15
15=109.50	15=332.60	35=111.50	35=332.90
16=109.55	16=332.45	36=111.55	36=332.75
17=109.70	17=333.20	37=111.70	37=333.50
18=109.75	18=333.05	38=111.75	38=333.35
19=109.90	19=333.80	39=111.90	39=331.10
20=109.95	20=333.65	40=111.95	40=330.95

To set the ILS Localizer left frequency

1. Press Aux Fctn > Avionics > ILS Localizer
2. Press Left/Right
3. Press Left Frequency  
(Default value is 90 Hz.)
4. Select a value in Hz | kHz | MHz | GHz from 0 Hz to 6 MHz.

These softkeys set the frequency of the Left ILS Localizer signal.

To set the ILS Localizer right frequency

1. Press Aux Fctn > Avionics > ILS Localizer
2. Press Left/Right
3. Press Right Frequency  
(Default value is 150 Hz.)
4. Select a value in Hz | kHz | MHz | GHz from 0 Hz to 10 MHz.

These softkeys set the frequency of the Right ILS Localizer signal.

To set the ILS Localizer phase of the right signal relative to the left

1. Press Aux Fctn > Avionics > ILS Localizer
2. Press Left/Right Phase  
(Default value is 0.00 deg.)
3. Select a value from 0.00 deg to 360 deg and press Enter.

These softkeys set the phase of the right (150 Hz) ILS Localizer signal relative to the left (90 Hz) ILS Localizer signal.

To set the ILS Localizer DDM polarity to fly left or fly right

1. Press Aux Fctn > Avionics > ILS Localizer
2. Press DDM/SDM
3. Press Fly Left | Right  
(Default selection is Left.)
4. Select either Left | Right

These softkeys set the “Difference in Depth of Modulation” (DDM) polarity of the ILS Localizer signal to either:

LEFT = positive | RIGHT = negative

The ILS Localizer provides signals that indicate whether an aircraft is Left, Right, or in-line with the glide path to the runway and enables a pilot to adjust the aircraft Left or Right correctly during landing. This lateral/horizontal correction is performed using two AM carriers with an AM depth of 20%, operating at a carrier frequency range between 108.10 - 111.95 MHz.

For an aircraft on approach, the left signal is modulated at a frequency of 90 Hz by default, and the right signal is modulated at a frequency of 150 Hz by default. When an aircraft is in-line with the glide path to the runway, the amplitude of the 90 Hz and 150 Hz sine-wave signals are equal. Left or right of this glide path, the amplitudes are different. The difference in amplitude can determine the relative position of an aircraft from this theoretical glide path.

The primary mechanism which makes it possible for a pilot to obtain guidance to a runway is the aircraft receiver's ability to detect the “Difference in Depth of Modulation (DDM)” between the 90 Hz modulation and the 150 Hz modulation.

DDM is defined to be the “percentage modulation depth of the larger signal” minus the “percentage modulation depth of the smaller signal”, divided by 100.

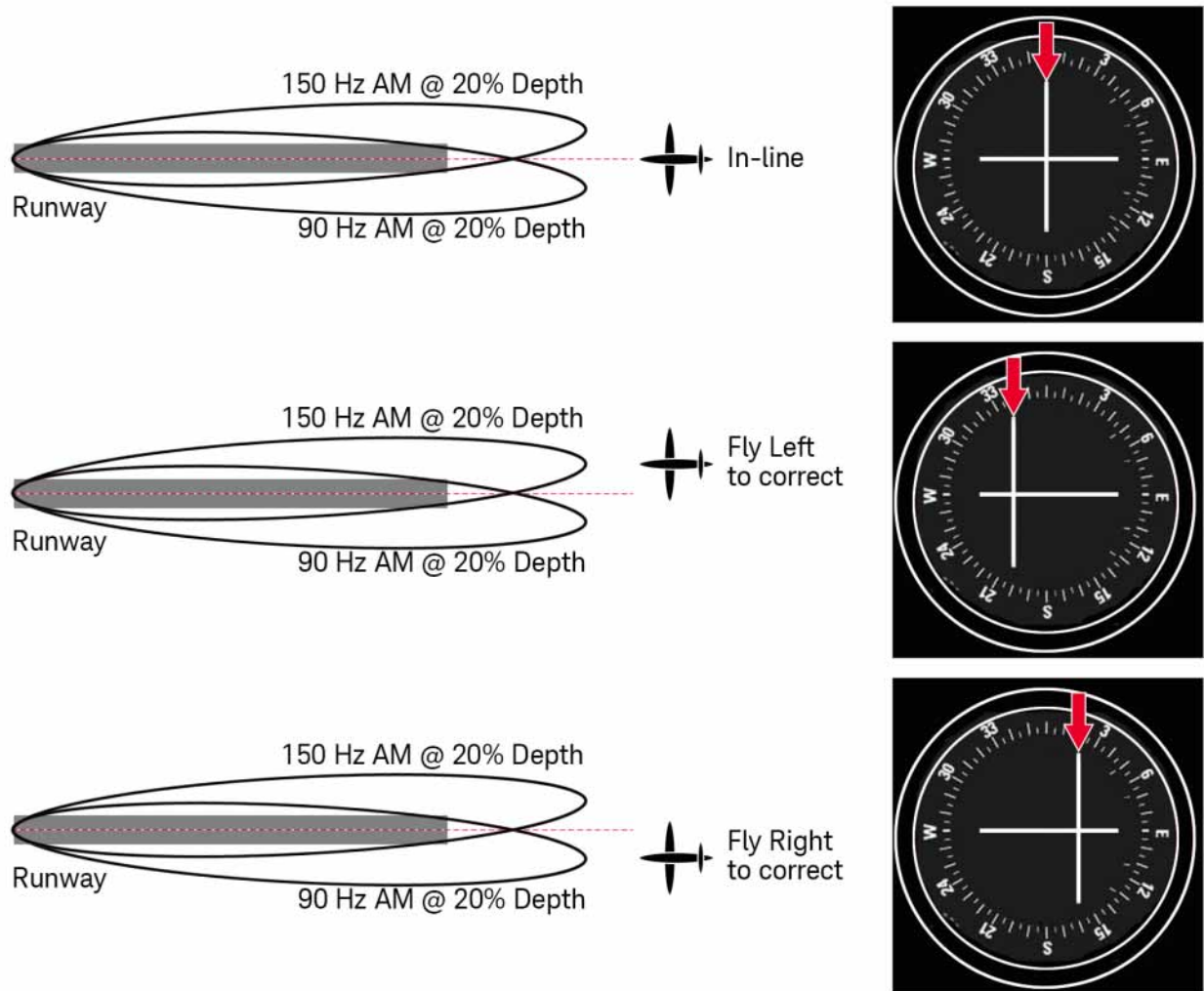
$$\text{DDM} = [\text{AM}(90 \text{ Hz})\% - \text{AM}(150 \text{ Hz})\%] / 100$$

When this formula yields a negative DDM value, the right signal at 150 Hz is stronger; this is indicating that the aircraft is to the Right of the ILS Localizer



centerline signal and would have to Fly “Left” to bring the DDM value back to zero so that the aircraft is back in-line with the centerline of the runway.

Figure 5-10 ILS Localizer @ 108.10 MHz w/ Aircraft In-Line, Fly Left, Fly Right



Example:

To correct if the left signal at 90 Hz is stronger at 0.2 DDM, the aircraft would have to be pointed Right with a DDM of 0.2.

The following steps of key presses demonstrate the correction for Right:

- 1. Aux Fctn > Avionics.**
- 2. ILS Localizer > DDM/SDM > Fly Left Right to Right highlighted.**
- 3. DDM > 0.2 > Enter.**

Example:

To correct if the right signal at 150 Hz is stronger at  $-0.2$  DDM, the aircraft would have to be pointed Left with a DDM of  $-0.2$

The following steps of key presses demonstrate the correction for Left:

- 1. Aux Fctn > Avionics.**
- 2. ILS Localizer > DDM/SDM > Fly Left Right to Left highlighted.**
- 3. DDM >  $-0.2$  > Enter.**

To set the ILS Localizer DDM value

This process sets a value for the Difference in Depth of Modulation (DDM).

- 1. Press Aux Fctn > Avionics > ILS Localizer**
- 2. Press DDM/SDM**
- 3. Press DDM**  
(Default value is 0.0000.)
- 4. Enter a value that is within the range of the current SDM value.**

Typically the SDM default value provides sufficient range ( $-0.40$  to  $0.40$ ) for most applications.

If SDM is set to 99%, then the full range ( $-0.99$  to  $0.99$ ) of DDM is available. The following demonstrates the limits of DDM's range:

$(-SDM/100)$  to  $(SDM/100)$

As SDM's value increases or decrease, so does DDM's range.

DDM is defined to be the "percentage modulation depth of the larger signal" minus the "percentage modulation depth of the smaller signal", divided by 100.

$$DDM = [AM(90 \text{ Hz})\% - AM(150 \text{ Hz})\%] / 100$$

The primary mechanism which makes it possible for a pilot to obtain guidance to a runway is the aircraft receiver's ability to detect the DDM between the 90 Hz and 150 Hz amplitude modulation.

To set the ILS Localizer DDM value in micro-amps ( $\mu\text{A}$ )

This process sets a value for the difference in depth of modulation (DDM) in  $\mu\text{A}$ .

- 1. Press Aux Fctn > Avionics > ILS Localizer.**
- 2. Press DDM/SDM.**
- 3. Press DDM  $\mu\text{A}$**

4. Enter a value that is within the range of the current SDM value.

Typically the SDM default value provides sufficient range for most applications.

If SDM is set to 99%, then the full range (–958.1 to 958.1  $\mu\text{A}$ ) of DDM  $\mu\text{A}$  is available. The following demonstrates the limits of DDM  $\mu\text{A}$ 's range:

$$((-SDM/100)*(150/.155)) \text{ to } ((SDM/100)*(150/.155))$$

As SDM's value increases or decrease, so does the range.

The DDM  $\mu\text{A}$  default value is 0.0  $\mu\text{A}$ .

### To set the ILS Localizer DDM value as a percentage (%)

This process sets a value for the difference in depth of modulation (DDM) in %. DDM can be expressed either in terms of percentage (%) or as a modulation index. A DDM of 1% is equivalent to 0.01 DDM.

1. Press Aux Fctn > Avionics > ILS Localizer
2. Press DDM/SDM
3. Press DDM%  
(Default value is 0.00%.)

4. Enter a value within the range of the current SDM value.

Typically the SDM default value provides sufficient range (–40% to 40%) for most applications.

If SDM is set to 99%, then the full range (–99% to 99%) of DDM is available. The following demonstrates the limits of DDM's range:

$$(-SDM) \text{ to } (SDM)$$

As SDM's value increases or decrease, so does DDM's range.

### To set the ILS Localizer SDM value

This process sets the sum of depth of modulation (SDM):

1. Press Aux Fctn > Avionics > ILS Localizer
2. Press DDM/SDM
3. Press SDM  
(Default value is 40.00%.)

4. Select a value from 0 to 99% and press Enter.

The SDM range is defined by the following equation:

$$SDM = [AM(90 \text{ Hz}) + AM(150 \text{ Hz})] / 100:$$

To set or return the ILS Localizer parameters to a default state

This process returns the ILS Localizer parameters to a set of default state conditions.

1. Press Aux Fctn > Avionics > ILS Localizer
2. Press More 1 of 2
3. Press Recall Default Settings

The following table lists the default values:

ILS Localizer Menu	Parameters	Default State
ILS LOC Mode		OFF
Carrier Freq Index	1	108.1 MHz
Left/Right menu	Left Frequency	90 Hz
	Right Frequency	150 Hz
	Left/Right Phase	0.00 deg
DDM/SDM menu	Fly Left/Right	Left
	DDM	0.0000
	DDM uA	0.0 uA
	DDM%	0.00%
	SDM	40.0%
COM/ID menu <sup>a</sup>		

- a. For information on the COM/ID menu, refer to **“Using COM/ID Softkeys” on page 142.**

## Example of Setting All ILS Localizer Parameters

1. Press Preset to place the signal generator in a known preset state.
2. Set the ILS Localizer carrier frequency.
  - a. Press Aux Fctn > Avionics > ILS Localizer
  - b. Press Carrier Freq Index  
(Default value is 1 and corresponds to 108.10 MHz carrier frequency.)
  - c. (Optional) Select a value from 1 to 40 and press Enter to change to a different carrier frequency.
3. Set the ILS Localizer left frequency.
  - a. Press Left/Right
  - b. Press Left Frequency  
(Default value is 90 Hz.)
  - c. (Optional) Select a <value> from 0 Hz to 6 MHz.
4. Set the ILS Localizer right frequency.
  - a. Press Right Frequency  
(Default value is 150 Hz.)
  - b. (Optional) Select a <value> from 0 Hz to 10 MHz.
5. Set the ILS Localizer phase of the right signal relative to the left.
  - a. Press Left/Right Phase  
(Default value is 0.00 deg.)
  - b. (Optional) Select a <value> from 0.00 deg to 360 deg and press Enter.
6. Set the ILS Localizer DDM polarity to fly left or fly right.
  - a. Press Return
  - b. Press DDM/SDM
  - c. Press Fly Left | Right  
(Default selection is Left.)
  - d. (Optional) Select either Left | Right
7. Set the ILS Localizer DDM value.
  - a. Press DDM  
(Default value is 0.0000)
  - b. Enter a value that is within the range of the current SDM value.  
Typically the SDM default value provides sufficient range (-0.40 to 0.40) for most applications.

If SDM is set to 99%, then the full range (-0.99 to 0.99) of DDM is available. The following demonstrates the limits of DDM's range:

(-SDM/100) to (SDM/100)

As SDM's value increases or decrease, so does DDM's range.

- 8.** Set the ILS Localizer SDM value.
  - a.** Press SDM  
(Default value is 40.00%.)
  - b.** (Optional) Select a <value> from 0 to 99% and press Enter.
- 9.** Set the ILS Localizer mode.
  - a.** Press ILS LOC Mode  
(Default selection is OFF.)
  - b.** Select NORM to turn on both the Left (90 Hz) and the Right (150 Hz) ILS Localizer signals.
- 10.** Set the modulation to on.
  - a.** Press MOD On and verify that the front panel LED is illuminated, indicating that it is on.  
(Default is on).
- 11.** Set a desired RF power level.
  - a.** Press Amptd  
(Default power level is around -144 dBm, and depends on the signal generator model being used, so the signal may be very low and hard to find if you do not specify a high enough power level.)
  - b.** Select a value from -20 dBm to -40 dBm.
- 12.** Set the RF output to on
  - a.** Press RF On and verify that the front panel LED is illuminated, indicating that it is on.  
(Default is off).
- 13.** Verify that all settings are as expected on the signal generator display.
  - a.** Press Aux Fctn > Avionics > ILS Localizer
  - b.** Review the settings under ILS-LOC Status Information

## Using ILS Glide Slope Softkeys

An ILS [Instrument Landing System] is a navigation system, used by aircraft to obtain guidance to a runway (performing a “runway approach” while attempting to land the aircraft) and includes the following three functions operating in tandem (working together):

- ILS Localizer - ensures that the lateral/horizontal left-right approach of an aircraft is aligned with the center of a runway
- ILS Glide Slope - ensures that the vertical descent path of an aircraft is aligned to the proper descent path (~ 3 degrees downwards slope) of a runway
- ILS Marker Beacons - ensures the proper distance from a runway; the distances are based on the Outer, Middle, and Inner ILS Marker Beacons

The purpose of the ILS Glide Slope is to provide signals that indicate whether an aircraft is above, below, or in-line with the glide path to a runway and enables a pilot to adjust the aircraft up or down correctly during landing. This is the same type of information as provided by the ILS Localizer, but for the vertical reference rather than the lateral/horizontal reference; the same modulation and antenna techniques are used. This vertical correction is performed using two AM signals with an AM depth of 40%, operating at a carrier frequency range between 329.90 to 334.70 MHz.

For an aircraft on approach, using the ILS Glide Slope to land on a runway, the upper signal is modulated at a frequency of 90 Hz AM by default, and the lower signal is modulated at a frequency of 150 Hz AM by default.

The primary mechanism which makes it possible for a pilot to obtain guidance to a runway is the aircraft receiver's ability to detect the “Difference in Depth of Modulation (DDM)” between this 90 Hz and 150 Hz amplitude modulation.

Figure 5-11 ILS Localizer: 108.10 MHz w/ 90 Hz AM (Left), 150 Hz AM (Right) @ 20%

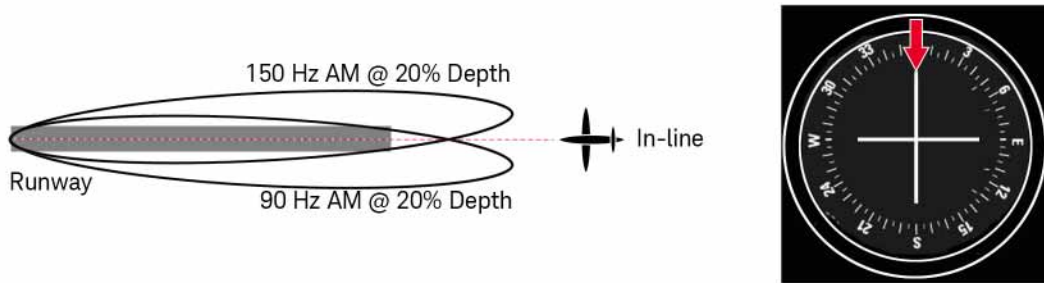


Figure 5-12 ILS Glide Slope: 334.70 MHz w/ 90 Hz AM (Up), 150 Hz AM (Down) @ 40%

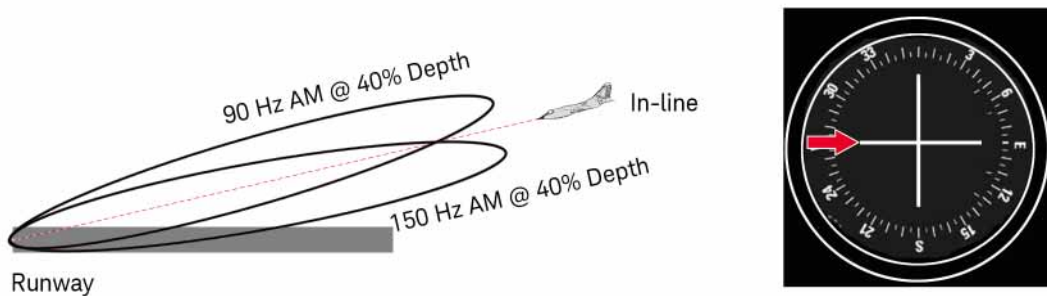


Figure 5-13 ILS Marker Beacons: 75 MHz, Inner 3000 Hz, Middle 1300 Hz, Outer 400 Hz

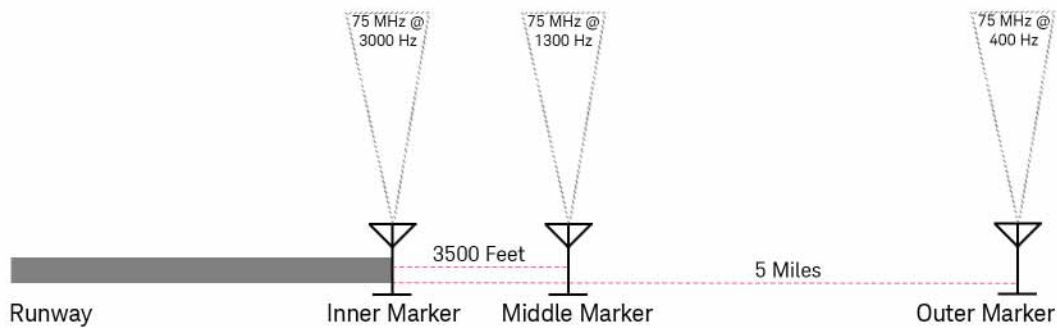
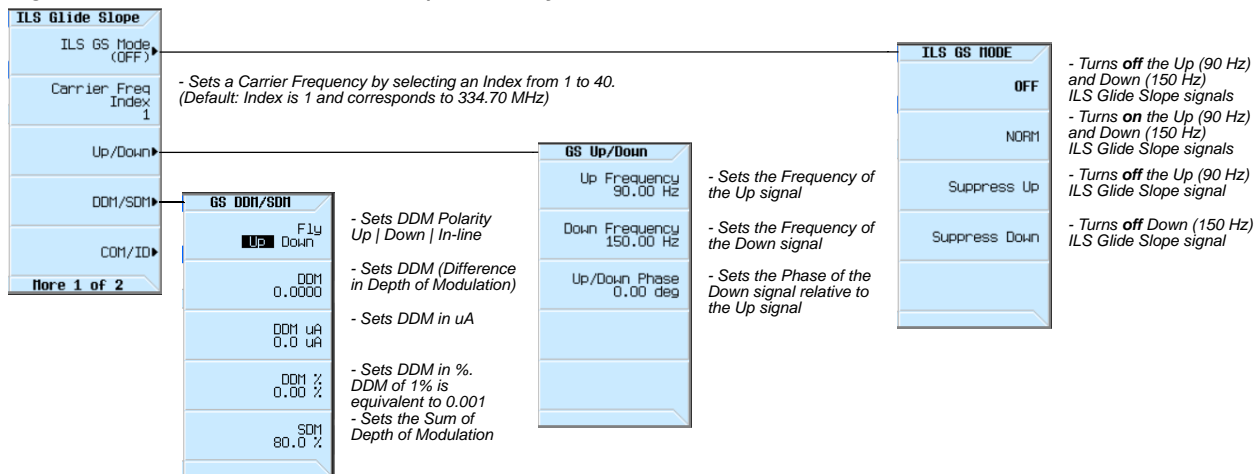




Figure 5-14 ILS Glide Slope Softkeys



When testing an ILS [Instrument Landing System], the following ILS Glide Slope parameters can be set:

ILS Glide Slope Menu	Parameters	Default State
ILS GS Mode		OFF
Carrier Freq Index	1	334.70 MHz
Up/Down menu	Up Frequency	90 Hz
	Down Frequency	150 Hz
	Up/Down Phase	0.00 deg
DDM/SDM menu	Fly Up/Down	Up
	DDM	0.0000
	DDM uA	0.0 uA
	DDM%	0.00%
	SDM	80.0%
COM/ID menu <sup>a</sup>		

a. For information on the COM/ID menu, refer to **“Using COM/ID Softkeys”** on page 142.

To set the ILS Glide Slope mode to produce a full or partial signal

1. Press Aux Fctn > Avionics > ILS Glide Slope
2. Press ILS GS Mode  
(Default selection is OFF.)
3. Select either: OFF | NORM | Suppress Up | Suppress Down

These softkeys allow selection of a complete or partial ILS Glide Slope signal and can set the ILS Glide Slope Mode to one of the following:

- Selecting **OFF** turns off all ILS Glide Slope signals. When set to OFF, all ILS Glide Slope mode parameter settings are turned off, but the selected ILS Glide Slope carrier is still present on the RF Output connector. To turn off this ILS Glide Slope carrier, set RF Off/On to Off.
- Selecting **NORM** turns on both Up (90 Hz) and Down (150 Hz) ILS Glide Slope signals.
- Selecting **Suppress Up** turns off the Up (90 Hz) ILS Glide Slope signal.
- Selecting Suppress Down turns off the Down (150 Hz) ILS Glide Slope signal.

To set the ILS Glide Slope carrier frequency

1. Press Aux Fctn > Avionics > ILS Glide Slope
2. Press Carrier Freq Index  
(Default value is 1 and corresponds to 334.70 MHz.)
3. Select a value from 1 to 40 (see table) and press Enter.

There are forty channels that are allocated to the ILS Localizer in the range from 108.10 to 111.95 MHz; each ILS Localizer carrier has a corresponding ILS Glide Slope carrier frequency in the range from 329.15 to 335.00 MHz.

The default ILS Glide Slope carrier frequency Index is 1 and corresponds to 334.70 MHz.

ILS Localizer and Corresponding ILS Glide Slope Carrier Frequencies (MHz)			
ILS Localizer Index 1-20	ILS Glide Slope Index 1-20	ILS Localizer Index 21-40	ILS Glide Slope Index 21-40
1=108.10	1=334.70	21=110.10	21=334.40
2=108.15	2=334.55	22=110.15	22=334.25
3=108.30	3=334.10	23=110.30	23=335.00
4=108.35	4=333.95	24=110.35	24=334.85
5=108.50	5=329.90	25=110.50	25=329.60

Avionics VOR/ILS (Option N5180302B)  
Using ILS Glide Slope Softkeys

6=108.55	6=329.75	26=110.55	26=329.45
7=108.70	7=330.50	27=110.70	27=330.20
8=108.75	8=330.35	28=110.75	28=330.05
9=108.90	9=329.30	29=110.90	29=330.80
10=108.95	10=329.15	30=110.95	30=330.65
11=109.10	11=331.40	31=111.10	31=331.70
12=109.15	12=331.25	32=111.15	32=331.55
13=109.30	13=332.00	33=111.30	33=332.30
14=109.35	14=331.85	34=111.35	34=332.15
15=109.50	15=332.60	35=111.50	35=332.90
16=109.55	16=332.45	36=111.55	36=332.75
17=109.70	17=333.20	37=111.70	37=333.50
18=109.75	18=333.05	38=111.75	38=333.35
19=109.90	19=333.80	39=111.90	39=331.10
20=109.95	20=333.65	40=111.95	40=330.95

### To set the ILS Glide Slope up frequency

This process sets the ILS Glide Slope up frequency.

1. Press Aux Fctn > Avionics > ILS Glide Slope
2. Press Up/Down
3. Press Up Frequency  
(Default value is 90 Hz.)
4. Select a value in Hz | kHz | MHz | GHz from 0 Hz to 6 MHz.

### To set the ILS Glide Slope down frequency

This process sets the ILS Glide Slope down frequency.

1. Press Aux Fctn > Avionics > ILS Glide Slope
2. Press Up/Down
3. Press Down Frequency  
(Default value is 150 Hz.)
4. Select a value in Hz | kHz | MHz | GHz from 0 Hz to 10 MHz.

To set the ILS Glide Slope phase of the down signal relative to the up

This process sets the phase of the Down (150 Hz) ILS Glide Slope signal relative to the Up (90 Hz) ILS Glide Slope signal.

1. Press Aux Fctn > Avionics > ILS Glide Slope
2. Press Up/Down Phase  
(Default value is 0.00 deg.)
3. Select a value from 0.00 deg to 360 deg and press Enter.

To set the ILS Glide Slope DDM polarity to fly up or fly down

1. Press Aux Fctn > Avionics > ILS Glide Slope
2. Press DDM/SDM
3. Press Fly Up | Down  
(Default selection is Up.)
4. Select either Up | Down

The ILS Glide Slope enables a pilot to adjust the aircraft up or down correctly during landing.

The ILS Glide Slope provides signals that indicate whether an aircraft is above, below, or in-line with the glide path to the runway and enables a pilot to adjust the aircraft Up or Down correctly during landing.

This is the same type of information as provided by the ILS Localizer, but for the vertical reference rather than the lateral/horizontal reference; the same modulation and antenna techniques are used.

This vertical adjustment is performed using two AM signals with an AM depth of 40% operating at a carrier frequency range between 329.90 to 334.70 MHz.

For aircraft approach, the upper signal is modulated at a frequency of 90 Hz AM by default, and the lower signal is modulated at a frequency of 150 Hz AM by default.

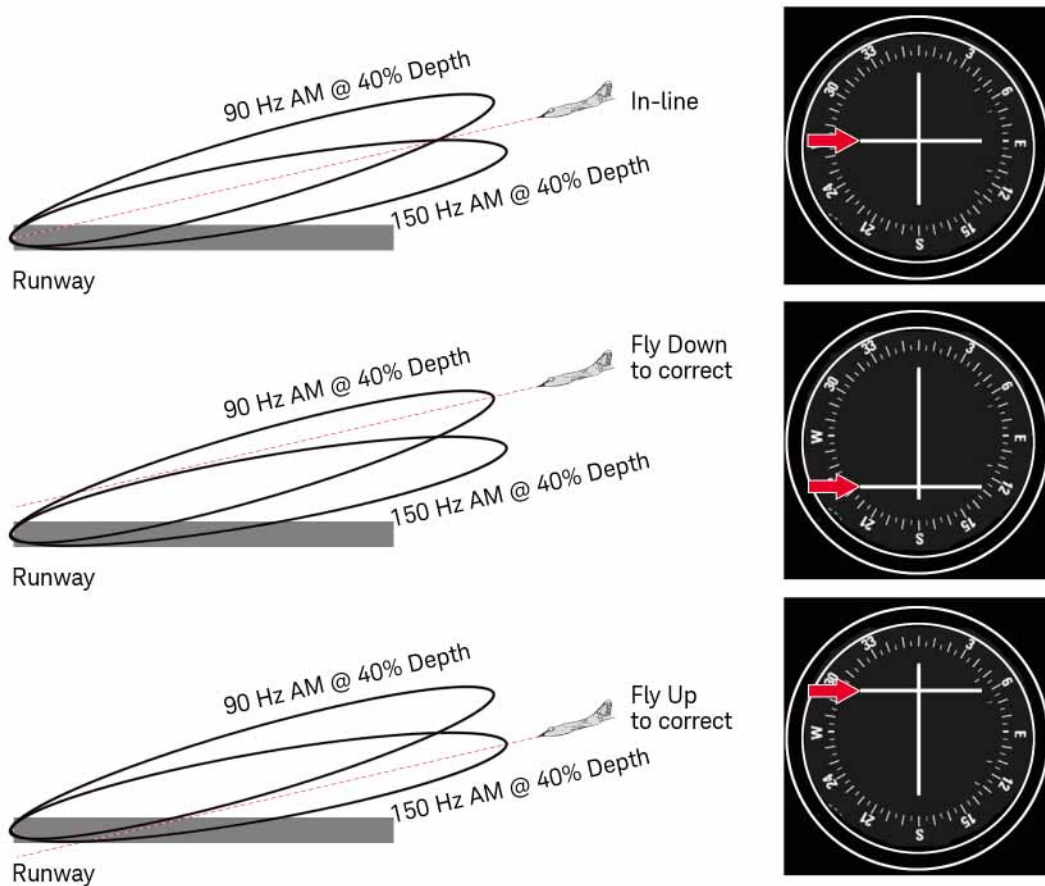
The primary mechanism which makes it possible for a pilot to obtain guidance to a runway is the aircraft receiver's ability to detect the "Difference in Depth of Modulation (DDM)" between the 90 Hz and the 150 Hz amplitude modulation.

DDM is defined to be the "percentage modulation depth of the larger signal" minus the "percentage modulation depth of the smaller signal", divided by 100.

$$\text{DDM} = [\text{AM}(90 \text{ Hz})\% - \text{AM}(150 \text{ Hz})\%] / 100$$

When this formula yields a positive DDM value, the upper signal at 90 Hz is stronger; this is indicating that the aircraft is Above the ILS Glide Slope centerline signal and would have to Fly "Down" to bring the DDM value back to zero so that the aircraft is back in-line with the centerline of the runway.

Figure 5-15 ILS Glide Slope @ 334.70 MHz w/ Aircraft In-Line, Fly Down, Fly Up



Example:

To correct if the upper tone at 90 Hz is stronger at 0.4 DDM, the aircraft would have to fly Down with a DDM of 0.4.

The following steps of key presses demonstrate the fly Down correction:

1. **Aux Fctn > Avionics.**
2. **ILS Glide Slope > DDM/SDM > Fly Up Down to Down highlighted.**
3. **DDM > 0.4 > Enter.**

Example:

To correct if the upper tone at 150 Hz is stronger at -0.4 DDM, the aircraft would have to fly Up with a DDM of -0.4.

The following steps of key presses demonstrate the fly Up correction:

1. **Aux Fctn > Avionics.**
2. **ILS Glide Slope > DDM/SDM > Fly Up Down to Up highlighted.**
3. **DDM > -0.4 > Enter.**

## To set the ILS Glide Slope DDM value

This process sets a value for the “Difference in Depth of Modulation” (DDM).

**1. Press Aux Fctn > Avionics > ILS Glide Slope**

**2. Press DDM/SDM**

**3. Press DDM**  
(Default value is 0.0000.)

**4. Enter a value that is within the range of the current SDM value.**

Typically the SDM default value provides sufficient range (–0.80 to 0.80) for most applications.

If SDM is set to 99%, then the full range (–0.99 to 0.99) of DDM is available. The following demonstrates the limits of DDM’s range:

$$(-SDM/100) \text{ to } (SDM/100)$$

As SDM’s value increases or decrease, so does DDM’s range.

The primary mechanism which makes it possible for a pilot to obtain guidance to a runway is the aircraft receiver's ability to detect the “Difference in Depth of Modulation (DDM)” between this 90 Hz and 150 Hz amplitude modulation.

DDM is defined to be the “percentage modulation depth of the larger signal” minus the “percentage modulation depth of the smaller signal”, divided by 100.

$$DDM = [AM(90 \text{ Hz})\% - AM(150 \text{ Hz})\%] / 100$$

## To set the ILS Glide Slope DDM value in micro-amps ( $\mu\text{A}$ )

This process sets a value for the difference in depth of modulation (DDM) expressed in  $\mu\text{A}$ .

**1. Press Aux Fctn > Avionics > ILS Glide Slope**

**2. Press DDM/SDM**

**3. Press DDM  $\mu\text{A}$**   
(Default value is 0.0  $\mu\text{A}$ .)

**4. Enter a value that is within the range of the current SDM value.**

Typically the SDM default value provides sufficient range for most applications.

If SDM is set to 99%, then the full range (–846.6 to 846.6  $\mu\text{A}$ ) of DDM  $\mu\text{A}$  is available. The following demonstrates the limits of DDM  $\mu\text{A}$ ’s range:

$$((-SDM/100)*(150/.175)) \text{ to } ((SDM/100)*(150/.175))$$

As SDM’s value increases or decrease, so does the range.

## To set the ILS Glide Slope DDM value in percentage (%)

This process sets a value for the difference in depth of modulation (DDM) in %. DDM can be expressed either in terms of percentage (%) or as a modulation index. A DDM of 1% is equivalent to 0.01 DDM.

**1. Press Aux Fctn > Avionics > ILS Glide Slope**

**2. Press DDM/SDM**

**3. Press DDM%**  
(Default value is 0.00%.)

**4. Enter a value within the range of the current SDM value.**

Typically the SDM default value provides sufficient range (-80% to 80%) for most applications.

If SDM is set to 99%, then the full range (-99% to 99%) of DDM is available. The following demonstrates the limits of DDM's range:

(-SDM) to (SDM)

As SDM's value increases or decrease, so does DDM's range.

## To set the ILS Glide Slope SDM value

This process sets the sum of depth of modulation (SDM):

**1. Press Aux Fctn > Avionics > ILS Glide Slope**

**2. Press DDM/SDM**

**3. Press SDM**

**4. Select a value from 0 to 99% and press Enter.**  
(Default value is 80%.)

The SDM value is calculated using the following equation:

$$\text{SDM} = [\text{AM}(90 \text{ Hz}) + \text{AM}(150 \text{ Hz})] / 100$$

To set or return the ILS Glide Slope parameters to a default state

This process returns the ILS Glide Slope parameters to a set of default state conditions.

1. Press Aux Fctn > Avionics > ILS Glide Slope
2. Press More 1 of 2
3. Press Recall Default Settings

ILS Glide Slope Menu	Parameters	Default State
ILS GS Mode		OFF
Carrier Freq Index	1	334.70 MHz
Up/Down menu	Up Frequency	90 Hz
	Down Frequency	150 Hz
	Up/Down Phase	0.00 deg
DDM/SDM menu	Fly Up/Down	Up
	DDM	0.0000
	DDM uA	0.0 uA
	DDM%	0.00%
	SDM	80.0%
COM/ID menu <sup>a</sup>		

- a. For information on the COM/ID menu, refer to [“Using COM/ID Softkeys” on page 142.](#)



## Example of Setting All ILS Glide Slope Parameters

1. Press Preset to place the signal generator in a known preset state.
2. Set the ILS Glide Slope carrier frequency.
  - a. Press Aux Fctn > Avionics > ILS Glide Slope
  - b. Press Carrier Freq Index  
(Default value is 1 and corresponds to 334.70 MHz.)
  - c. (Optional) Select a <value> from 1 to 40 and press Enter to change to a different carrier frequency.)
3. Set the ILS Glide Slope up frequency.
  - a. Press Up/Down
  - b. Press Up Frequency  
(Default value is 90 Hz.)
  - c. (Optional) Select a <value> from 0 Hz to 6 MHz.
4. Set the ILS Glide Slope down frequency.
  - a. Press Down Frequency  
(Default value is 150 Hz.)
  - b. (Optional) Select a <value> from 0 Hz to 10 MHz.
5. Set the ILS Glide Slope phase of the down signal relative to the up.
  - a. Press Up/Down Phase  
(Default value is 0.00 deg.)
  - b. (Optional) Select a <value> from 0.00 deg to 360 deg and press Enter.
6. Set the ILS Glide Slope DDM polarity to fly up or fly down.
  - a. Press Return
  - b. Press DDM/SDM
  - c. Press Fly Up | Down  
(Default selection is Up.)
  - d. (Optional) Select either Up | Down
7. Set the ILS Glide Slope DDM value.
  - a. Press DDM  
(Default value is 0.0000.)

- b.** Enter a value that is within the range of the current SDM value.

Typically the SDM default value provides sufficient range (-0.80 to 0.80) for most applications.

If SDM is set to 99%, then the full range (-0.99 to 0.99) of DDM is available. The following demonstrates the limits of DDM's range:

(-SDM/100) to (SDM/100)

As SDM's value increases or decrease, so does DDM's range.

- 8.** Set the ILS Glide Slope SDM value.

- a.** Press SDM  
(Default value is 80%.)
- b.** (Optional) Select a <value> from 0 to 99% and press Enter.

- 9.** Set the ILS Glide Slope mode.

- a.** Press ILS GS Mode  
(Default selection is OFF.)
- b.** Select NORM to turn on both the Up (90 Hz) and Down (150 Hz) ILS Glide Slope signals.

- 10.** Set the modulation to on.

- a.** Press MOD On and verify that the front panel LED is illuminated, indicating that it is on.  
(Default is on).

- 11.** Set a desired RF power level.

- a.** Press Amptd  
(Default power level is around -144 dBm, and depends on the signal generator model being used, so the signal may be very low and hard to find if you do not specify a high enough power level.)
- b.** Select a value from -20 dBm to -40 dBm.

- 12.** Set the RF output to on.

- a.** Press RF On and verify that the front panel LED is illuminated, indicating that it is on.  
(Default is off).

- 13.** Verify that all settings are as expected on the signal generator display.

- a.** Press Aux Fctn > Avionics > ILS Glide Slope
- b.** Review the settings under ILS-GS Status Information

## Using ILS Marker Beacon Softkeys

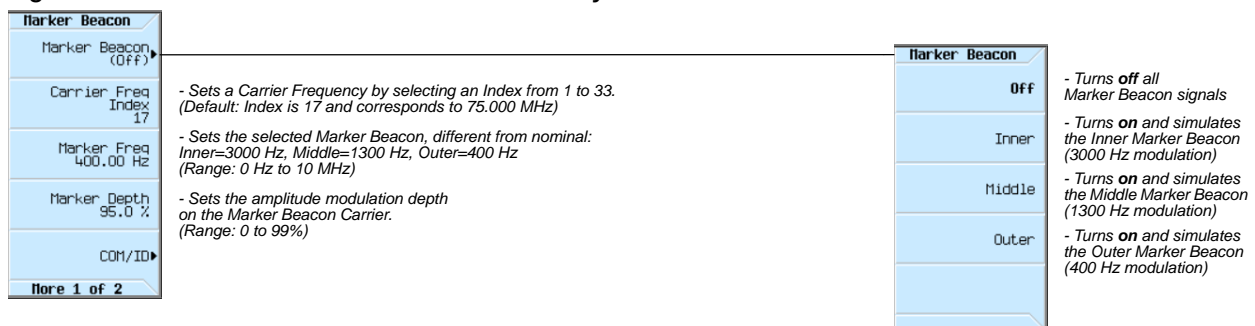
An ILS [Instrument Landing System] is a navigation system, used by aircraft to obtain guidance to a runway (performing a “runway approach”) and includes the following three functions operating in tandem (working together):

- ILS Localizer - ensures that the lateral/horizontal left-right approach of an aircraft is aligned with the center of a runway
- ILS Glide Slope - ensures that the vertical descent path of an aircraft is aligned to the proper descent path (~ 3 degrees downwards slope) of a runway
- ILS Marker Beacons - ensures the proper distance from a runway; the distances are based on the Outer, Middle, and Inner ILS Marker Beacons

Marker Beacons are used to alert a pilot that an action is needed, such as checking the aircraft altitude. Marker Beacon information is presented to pilots by audio and visual information. The ILS Localizer may contain present information on the Outer, Middle, and Inner ILS Marker Beacons. All ILS Marker Beacons are broadcast at 75 MHz and are located at specific intervals along an ILS approach. Each ILS Marker Beacon is identified by specific audio as well as visual characteristics.

ILS Marker Beacon	Code	Color	Sound
Outer Marker	---	Blue	400 Hz two dashes per second
Middle Marker	-.--	Amber	1300 Hz alternating dot and dash
Inner Marker	...	White	3000 Hz dots only

Figure 5-16 ILS Marker Beacon Softkeys



When testing an ILS [Instrument Landing System], the following ILS Marker Beacon parameters can be set:

ILS Marker Beacon Menu	Parameters	Default State
Marker Beacon mode		Off
Carrier Freq Index	17	75.0 MHz
Marker Freq	400 Hz	Outer
Marker Depth	95.0%	Up
COM/ID menu <sup>a</sup>		

a. For information on the COM/ID menu, refer to **“Using COM/ID Softkeys” on page 142.**

To set the ILS Marker Beacon mode to off, inner, middle, or outer

This process selects a Marker Beacon Mode and can be one of the following:

**1. Press Aux Fctn > Avionics > Marker Beacon**

**2. Press Marker Beacon**  
(Default selection is Off.)

**3. Select either: Off | Inner | Middle | Outer**

– Selecting **Off** turns off all Marker Beacon signals. When set to Off, all Marker Beacon parameter settings are turned off.

**NOTE**

Setting the mode back to OFF, after selecting one of the other modes (either: Inner | Middle | Outer) does not turn off the Marker Beacon carrier, specified by Carrier Freq Index, it is still present on the RF Output of the signal generator.

To turn off this ILS Marker Beacon carrier, set RF Off/On to Off.

– Selecting **Inner** turns on and simulates the Inner Marker Beacon (nominal 3000 Hz modulation) signal.

– Selecting **Middle** turns on and simulates the Middle Marker Beacon (nominal 1300 Hz modulation) signal.

– Selecting **Outer** turns on and simulates the Outer Marker Beacon (nominal 400 Hz modulation) signal.

To set the ILS Marker Beacon carrier frequency

This process sets the carrier frequency for the three Marker Beacons: Inner, Middle, and Outer.

**1. Press Aux Fctn > Avionics > Marker Beacon**

**2. Press Carrier Freq Index**  
(Default value is 17 and corresponds to 75.000 MHz.)

**3. Select a value from 1 to 33 and press Enter.**

The default ILS Marker Beacon carrier frequency Index is 17 and corresponds to 75.000 MHz.

ILS Marker Beacon Carrier Frequencies (Index = 1 to 33)		
1=74.600	12=74.875	23=75.150
2=74.625	13=74.900	24=75.175
3=74.650	14=74.925	25=75.200
4=74.675	15=74.950	26=75.225
5=74.700	16=74.975	27=75.250
6=74.725	17=75.000	28=75.275
7=74.750	18=75.025	29=75.300
8=74.775	19=75.050	30=75.325
9=74.800	20=75.075	31=75.350
10=74.825	21=75.100	32=75.375
11=74.850	22=75.125	33=75.400

### To set the ILS Marker Beacon AM depth

This process sets the AM depth on the Marker Beacon carrier.

- 1. Press Aux Fctn > Avionics > Marker Beacon**
- 2. Press Marker Depth**  
(Default value is 95%.)
- 3. Select a value from 0 to 99.9% and press Enter.**

### To set the ILS Marker Beacon inner marker frequency

This process sets the frequency for the Inner Marker Beacon.

- 1. Press Aux Fctn > Avionics > Marker Beacon**
- 2. Press Marker Beacon**
- 3. Press Inner**
- 4. Press Marker Freq**  
(Default value is 3000 Hz.)
- 5. Select a value in Hz | kHz | MHz | GHz from 0 Hz to 10 MHz.**

## To set the ILS Marker Beacon middle marker frequency

This process sets the frequency for the Middle Marker Beacon.

1. Press Aux Fctn > Avionics > Marker Beacon
2. Press Marker Beacon
3. Press Middle
4. Press Marker Freq  
(Default value is 1300 Hz.)
5. Select a value in Hz | kHz | MHz | GHz from 0 Hz to 10 MHz.

## To set the ILS Marker Beacon outer marker frequency

This process sets the frequency for the Outer Marker Beacon.

1. Press Aux Fctn > Avionics > Marker Beacon
2. Press Marker Beacon
3. Press Outer
4. Press Marker Freq  
(Default value is 400 Hz.)
5. Select a value in Hz | kHz | MHz | GHz from 0 Hz to 10 MHz.

## To set or return the ILS Marker Beacon parameters to a default state

This process returns the ILS Marker Beacon parameters to a set of default state conditions.

1. Press Aux Fctn > Avionics > Marker Beacon
2. Press More 1 of 2
3. Press Recall Default Settings

ILS Marker Beacon Menu	Parameters	Default State
Marker Beacon mode		Off
Carrier Freq Index	17	75.0 MHz
Marker Freq	400 Hz	Outer
Marker Depth	95.0%	Up
COM/ID menu <sup>a</sup>		

- a. For information on the COM/ID menu, refer to **“Using COM/ID Softkeys” on page 142.**

## Example of Setting All ILS Marker Beacon Parameters

1. Press Preset to place the signal generator in a known preset state.
2. Set the ILS Marker Beacon mode to inner, middle, or outer mode.
  - a. Press Aux Fctn > Avionics > Marker Beacon
  - b. Press Marker Beacon  
(Default selection is Off.)
  - c. Select either: Inner | Middle | Outer
3. Set the ILS Marker Beacon carrier frequency.
  - a. Press Carrier Freq Index  
(Default value is 17 and corresponds to 75.000 MHz.)
  - b. (Optional) Select a <value> from 1 to 33 and press Enter to change to a different carrier frequency.
4. Set the ILS Marker Beacon AM depth.
  - a. Press Marker Depth  
(Default value is 95%.)
  - b. (Optional) Select a value from 0 to 99.9% and press Enter.
5. (Optional, if Inner was selected in step 2 above.)  
Set the ILS Marker Beacon inner marker frequency.
  - a. Press Marker Beacon
  - b. Press Inner
  - c. Press Marker Freq  
(Default value is 3000 Hz.)
  - d. (Optional) Select a value from 0 Hz to 10 MHz.
6. (Optional, if Middle was selected in step 2 above.)  
Set the ILS Marker Beacon middle marker frequency.
  - a. Press Marker Beacon
  - b. Press Middle
  - c. Press Marker Freq  
(Default value is 1300 Hz.)
  - d. (Optional) Select a <value> from 0 Hz to 10 MHz.
7. (Optional, if Outer was selected in step 2 above.)  
Set the ILS Marker Beacon outer marker frequency.
  - a. Press Marker Beacon
  - b. Press Outer  
(Default value is 400 Hz.)





## 6 Analog Modulation (Option UNT)

Before using this information, you should be familiar with the basic operation of the signal generator. If you are not comfortable with functions such as setting the power level and frequency, refer to **Chapter 3, “Basic Operation”, on page 57** and familiarize yourself with the information in that chapter.

- **Using an Internal Modulation Source** on page 180
- **Using an External Modulation Source** on page 181
- **Removing an External Source DC Offset** on page 181
- **Using Wideband AM** on page 182
- **Configuring the LF Output (Option 303)** on page 183

## Analog Modulation Waveforms

The signal generator can modulate the RF carrier with four types of analog modulation: amplitude, frequency, phase, and pulse. For pulse modulation information, refer to **Chapter 7, “Pulse Modulation (Options UNW and N5180320B)”**, on page 187.

Available internal waveforms include:

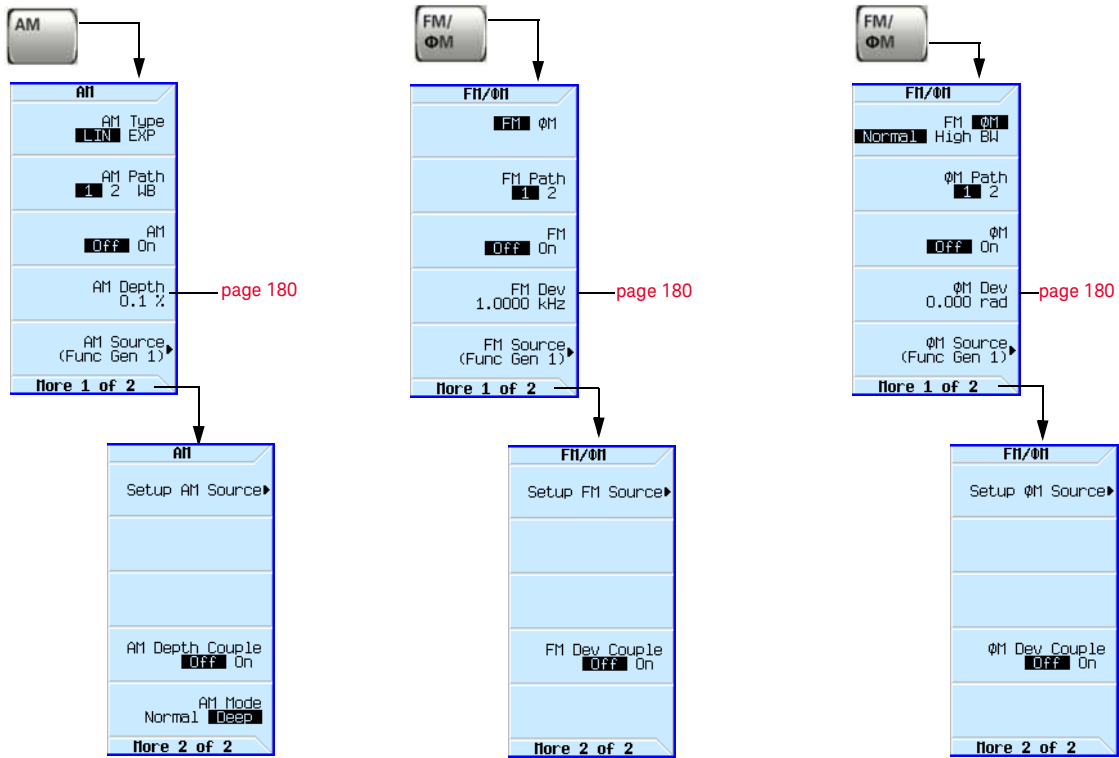
Sine	sine wave with adjustable amplitude and frequency
Triangle	triangle wave with adjustable amplitude and frequency
Square	square wave with adjustable amplitude and frequency
Pos Ramp	positive going ramp with adjustable amplitude and frequency
Neg Ramp	negative going ramp with adjustable amplitude and frequency

## Analog Modulation Sources

The signal generator provides the following internal and external modulation input sources. Internal modulation sources generate the five waveforms listed above unless noted otherwise.

Ext1 & Ext2	an externally applied signal is used as the modulation input. Connect the signal to the EXT 1 or EXT 2 connector on the rear panel of the instrument.
Func Gen 1	sine wave from the internal function generator. Instruments with Option 303 have additional waveform choices listed above.
Func Gen 2	Func Gen 2 has the same capability as Func Gen 1. Available on instruments with Option 303.
Dual Func Gen	dual waveforms with individually adjustable frequencies and a percent-of-peak-amplitude setting for the second tone. Available on instruments with Option 303.
Swept Func Gen	swept waveforms with adjustable start and stop frequencies, sweep time, and sweep trigger settings. Available on instruments with Option 303.
Noise Gen 1 & 2	noise with adjustable amplitude generated as a peak-to-peak value (RMS value is approximately 80% of the displayed value). Uniform and Gaussian distribution is available. Available on instruments with Option 303.

Figure 6-1 Analog Modulation Softkeys



For details on each key, use key help as described on [page 58](#).

## Using an Internal Modulation Source

1. Preset the signal generator.
2. Set the carrier (RF) frequency.
3. Set the RF amplitude.
4. Configure the modulation:

AM	FM	$\Phi$ M
a. Press <b>AM</b> b. Set the AM type (Linear or Exponential): <b>AM Type</b> to highlight desired type. c. Set the AM Mode (Normal or Deep). Default is Deep. To select <b>Normal</b> enable <b>More</b> to highlight desired type. d. Set the AM Depth: <b>AM Depth</b> > <b>value</b> > <b>unit</b> e. Set the rate: <b>More</b> > <b>Setup AM Source</b> > <b>AM Rate</b> > <b>value</b> > <b>frequency unit</b>	a. Press <b>FM/<math>\Phi</math>M</b> b. Set the deviation: <b>FM Dev</b> > <b>value</b> > <b>frequency unit</b> c. Set the rate: <b>More</b> > <b>Setup FM</b> <b>Source</b> > <b>FM Rate</b> > <b>value</b> > <b>frequency unit</b>	a. Press <b>FM/<math>\Phi</math>M</b> > <b>FM/<math>\Phi</math>M</b> <b>(<math>\Phi</math>M is highlighted)</b> b. Set the BW (normal or high): <b>FM <math>\Phi</math>M</b> to highlight desired type c. Set the deviation: <b><math>\Phi</math>M Dev</b> > <b>value</b> > <b>pi rad</b> d. Set the rate: <b>More</b> > <b>Setup <math>\Phi</math>M</b> <b>Source</b> > <b><math>\Phi</math>M Rate</b> > <b>value</b> > <b>frequency unit</b>

5. Turn on the modulation:

AM	FM	$\Phi$ M
<b>AM Off On</b> softkey to On	<b>FM Off On</b> softkey to On	<b><math>\Phi</math>M Off On</b> softkey to On

The appropriate modulation annunciator displays, indicating that you enabled modulation.

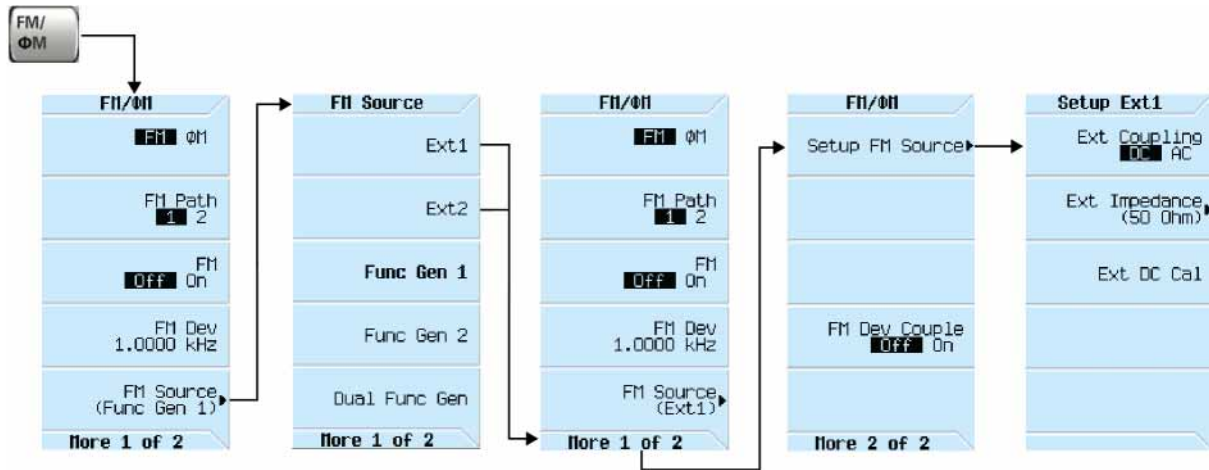
6. Turn on the RF output.

The RF output LED lights, indicating that the signal is transmitting from the RF output connector.

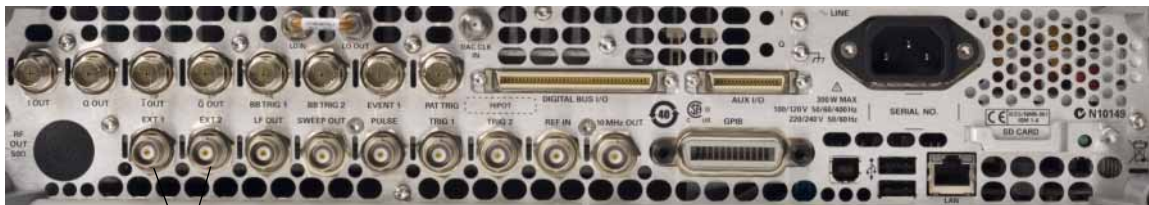
If the modulation does not seem to be working properly, refer to **“No Modulation at the RF Output” on page 443**.

See also **“Modulating the Carrier Signal” on page 72**.

## Using an External Modulation Source



Rear panel inputs are described on [page 28](#)



AM, FM or ΦM inputs

## Removing an External Source DC Offset

To eliminate an offset in an externally applied FM or ΦM signal, perform an external DC calibration (Ext DC Cal).

1. Set up and turn on the desired modulation.
2. Press **FM/ΦM** > **FM Source** > **Ext1** or **Ext2** > **More** > **Setup FM Source**.
3. Ensure that Ext Coupling is set to DC.  
- If not, press **Ext Coupling DC AC** until DC is highlighted.
4. Press **Ext DC Cal**.

This begins the calibration.

Performing the calibration with a DC signal applied removes any deviation caused by the DC signal, and the applied DC level becomes the new zero reference point. When you disconnect the DC signal, perform the calibration again to reset the carrier to the correct zero reference.

## Using Wideband AM

Wideband AM uses the I input of the I/Q modulation system. When the wideband AM is turned on, the I/Q is turned on and the I/Q source is set to external. If the I/Q is turned off or the I/Q source is set to internal, then the wideband AM turns off.

**NOTE**

For frequencies between 9 kHz and 5 MHz, Wideband AM turns off.

Figure 6-2 Wideband AM Softkey Menu

AM > AM Path 1 2 WB

FREQUENCY		AMPLITUDE		AM
6.000 000 000 00 GHz		-144.00 dBm		
AN		I/Q		
Analog Modulation Status Information				AM Path 1 2 WB
AM1	FuncGen1	Depth:0.1%	Wfm:Sine(400.0Hz)	
AM2	FuncGen1	Depth:0.1%	Wfm:Sine(400.0Hz)	
<b>AMWB</b>	<b>I Input</b>	<b>Depth:0.5V=100%</b>		AM Off On
FM1	Ext2 DC	Dev:1.0000kHz	Imp:50 Ohm	
FM2	FuncGen1	Dev:1.0000kHz	Wfm:Sine(400.0Hz)	
QM1HBM	Ext1 DC	Dev:0.000rad	Imp:50 Ohm	
QM2HBM	FuncGen1	Dev:0.000rad	Wfm:Sine(400.0Hz)	
LFOut	InthMonitor	Amp1:0.000V	Monitored:FuncGen1	
				AM Depth 0.5V=100%
				AM Source I Input
02/25/2012 14:25				

When the Wideband AM is enabled, these fields are active.

Enables and disables the wideband AM feature. Note: If the I/Q is turned off or the I/Q source is set to internal, then the wideband AM turns off.

For details on each key, use key help as described on [page 58](#).

## Setting the Wideband AM

1. Set up and enable the desired modulation type.
2. Press **AM > AM Path 1 2 WB** to **WB**.

## Configuring the LF Output (Option 303)

The signal generator has a low frequency (LF) output. The LF output's source can be switched between an internal modulation source or an internal function generator.

Using internal modulation (**Int Monitor**) as the LF output source, the LF output provides a replica of the signal from the internal source that is being used to modulate the RF output. The specific modulation parameters for this signal are configured through the AM, FM, or  $\Phi$ M menus. The internal source (AM, FM, or  $\Phi$ M) must be configured for the LF Out to provide a signal.

Using function generator as the LF output source, the function generator section of the internal modulation source drives the LF output directly. Frequency and waveform are configured from the LF output menu, not through the AM, FM, or  $\Phi$ M menus. You can select the waveform shape from the following choices:

Available internal waveforms include:

Sine	sine wave with adjustable amplitude and frequency
Triangle	triangle wave with adjustable amplitude and frequency
Square	square wave with adjustable amplitude and frequency
Pos Ramp	positive going ramp with adjustable amplitude and frequency
Neg Ramp	negative going ramp with adjustable amplitude and frequency
Pulse	pulse with adjustable period and width

### LF Out Modulation Sources

The signal generator provides the following modulation input sources. Internal modulation sources generate the five waveforms listed above unless noted otherwise.

Int Monitor	uses AM, FM or $\Phi$ M settings.
Func Gen 1	waveforms from the internal function generator
Func Gen 2	waveforms from the internal function generator
Dual Func Gen	dual waveforms with individually adjustable frequencies and a percent-of-peak-amplitude setting for the second tone. Available on instruments with Option 303.
Swept Func Gen	swept waveforms with adjustable start and stop frequencies, sweep time, and sweep trigger settings. Available on instruments with Option 303.
Noise Gen 1 & 2	noise with adjustable amplitude generated as a peak-to-peak value (RMS value is approximately 80% of the displayed value). Uniform and Gaussian distribution is available. Available on instruments with Option 303.

DC selects a DC voltage level as the LF output BNC source.

**NOTE**

The **LF Out Off On** softkey controls the operating state of the LF output. However when the LF output source selection is **Int Monitor**, you have three ways of controlling the output. You can use the modulation source (AM, FM, or  $\Phi$ M) on/off key, the LF output on/off key, or the **Mod On/Off** softkey.

The **RF On/Off** hardkey does not apply to the LF OUTPUT connector.

---

## Configuring the LF Output with an Internal Modulation Source

In this example, the internal FM is the LF output source. See [Figure 6-3 on page 185](#).

**NOTE**

Internal modulation (**Int Monitor**) is the default LF output source.

---

## Configuring the Internal Modulation as the LF Output Source

1. Press **Preset**.
2. Press the **FM/ $\Phi$ M** hardkey.
3. Press **FM Dev > 75 > kHz**.
4. Press **More > Setup FM Source > FM Rate > 10 > kHz**.
5. Press **Return > Return > FM Off On**.

You have set up the FM signal with a rate of 10 kHz and 75 kHz of deviation. The  $\Phi$ M annunciator is activated indicating that you have enabled frequency modulation.

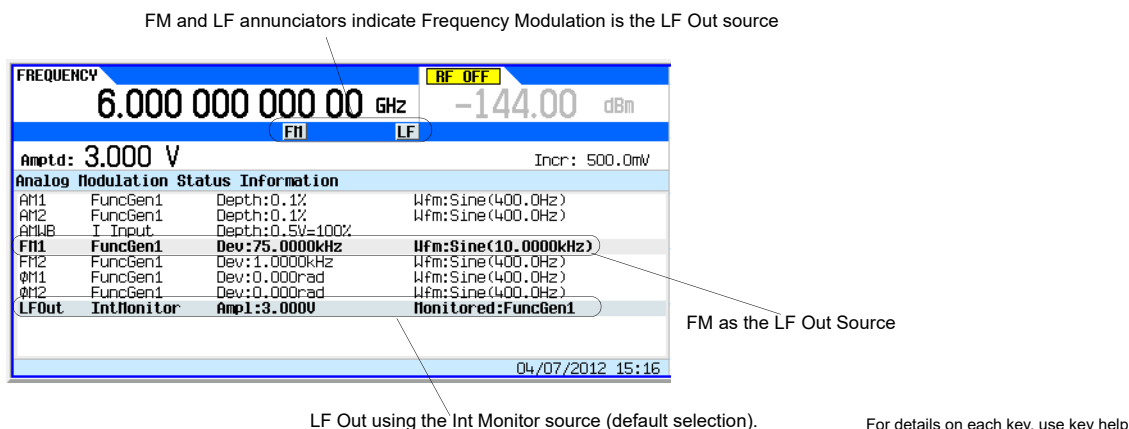
## Configuring the Low Frequency Output

1. Press the **LF Out** hardkey.
2. Press **LF Out Amplitude > 3 > V**.
3. Press **LF Out Off On**.

You have configured the LF output signal for a 3 volt sine wave (default wave form) output which is frequency modulated using the **Int Monitor** source selection (default source).



Figure 6-3 Configure the LF Out Source with FM



## Configuring the LF Output with a Function Generator Source

In this example, the function generator is the LF output source.

### Configuring the Function Generator as the LF Output Source

1. Press **Preset**.
2. Press the **LF Out** hardkey.
3. Press **LF Out Source > Func Gen 1**.

### Configuring the Waveform

1. Press **Setup LF Out Source > LF Out Waveform > Sine**.
2. Press **LF Out Freq > 500 > Hz**.
3. Press **Return**.

This returns you to the top LF Output menu.

### Configuring the Low Frequency Output

1. Press **LF Out Amplitude > 3 > V**.

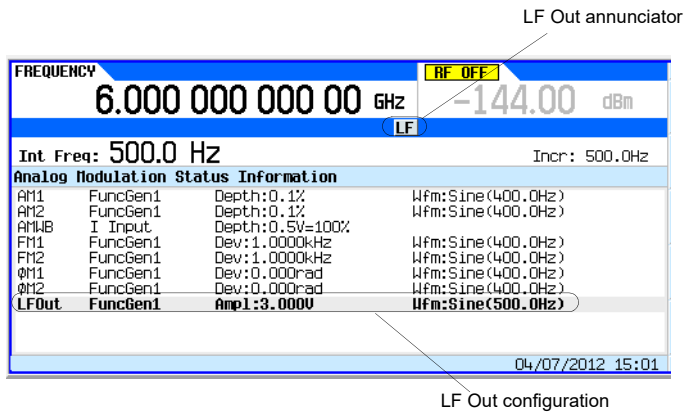
This sets the LF output amplitude to 3 V.

2. Press **LF Out Off On**.

Figure 6-4 on page 186 shows that the LF output is now transmitting a signal using the function generator that is providing a 3 V sine waveform.

Analog Modulation (Option UNT)  
 Configuring the LF Output (Option 303)

Figure 6-4 LF Out Status Display



For details on each key, use key help as described on [page 58](#).

## 7 Pulse Modulation (Options UNW and N5180320B)

### NOTE

With firmware version B.01.75 or later, option numbers for software internal to the instrument have changed. For more information, see [“Enabling an Option” on page 53](#).

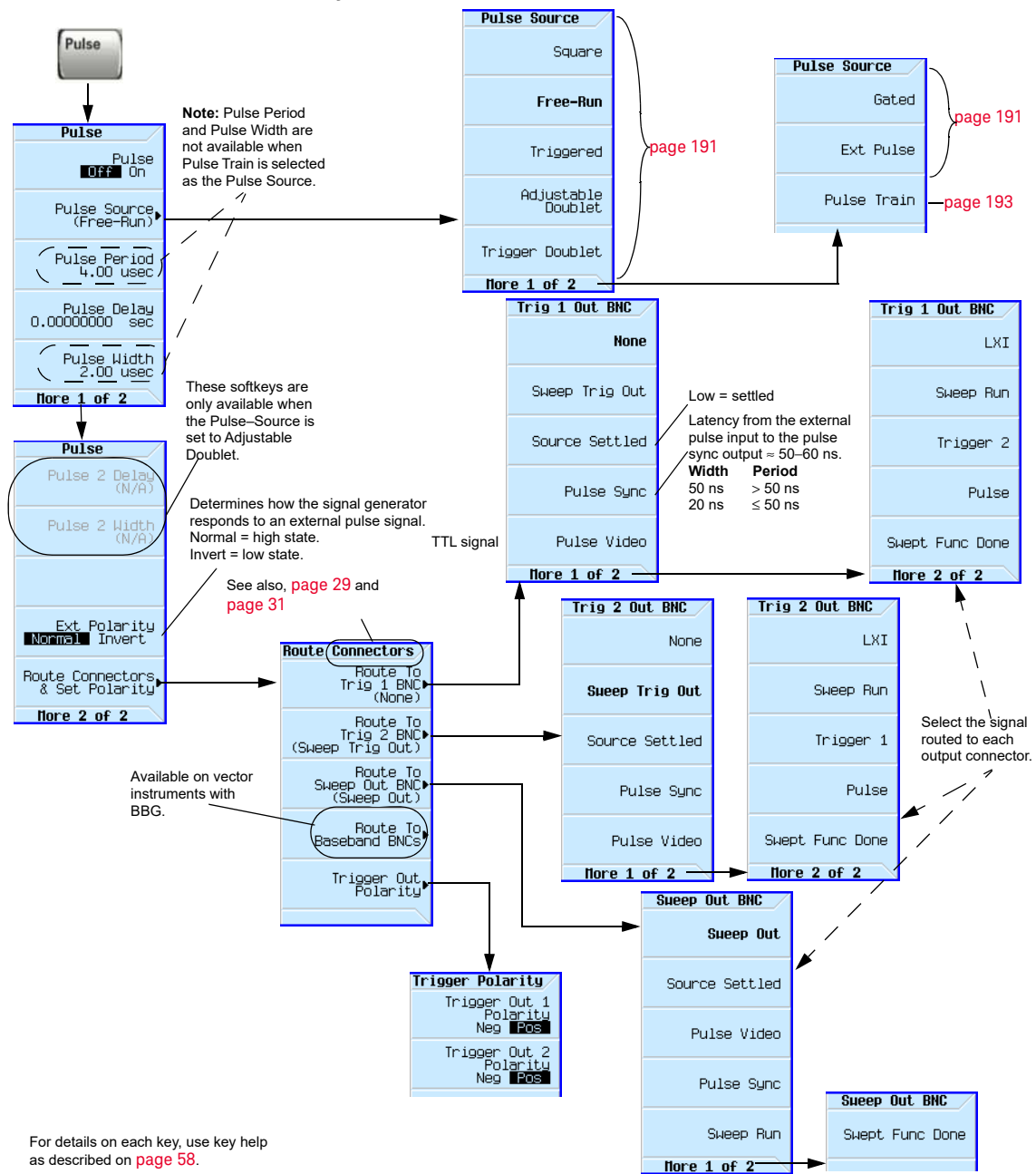
---

Before using this information, you should be familiar with the basic operation of the signal generator. If you are not comfortable with functions such as setting the power level and frequency, refer to [Chapter 3, “Basic Operation”, on page 57](#) and familiarize yourself with the information in that chapter.

Option UNW with Option N5180320B provides the pulse train generation support.

- [Pulse Characteristics](#) on page 189
- [The Basic Procedure](#) on page 191
- [Example](#) on page 192
- [Pulse Train \(Options UNW and N5180320B\)](#) on page 193

Figure 7-1 Pulse Softkeys



## Pulse Characteristics

### NOTE

When using very narrow pulses that are below the signal generator's ALC pulse width specification, or leveled pulses with an unusually long duty cycle, it is often useful to turn ALC off (see [page 120](#)).

Pulse Source	Type	Period <sup>a</sup>	Width & Delay <sup>a</sup>	Uses Trigger Event <sup>b</sup>
Square	Internal free run pulse train with 50% duty cycle.	Determined by user defined rate.	—	—
Free Run (default)	Internal free run pulse train	User Defined	User Defined	—
Triggered	Internal pulse train	—	User Defined	?
Adjustable Doublet	Two internal pulse trains for each trigger event.	—	User Defined: First pulse is relative to the rising edge of trigger signal. Second pulse is relative to the rising edge of first pulse. See <a href="#">Figure 7-2 on page 190</a>	?
Trigger Doublet	Two internal pulse trains for each trigger event.	—	The first pulse follows the trigger signal. Second pulse is user defined. See <a href="#">Figure 7-3 on page 190</a>	?
Gated	Internal gated pulse train	—	User Defined	?
External	External pulse signal at the rear panel Pulse connector	—	—	—
Pulse Train	Internal pulse train	User Defined	User Defined: See <a href="#">Figure 7-4 on page 193</a>	?

- a. All delays, widths, and periods have a resolution of 10 ns.  
b. A signal at the rear panel pulse connector must be held high for at least 20 ns to trigger an internally generated pulse.

Rear panel inputs are described on [page 28](#)



Figure 7-2 Adjustable Doublet

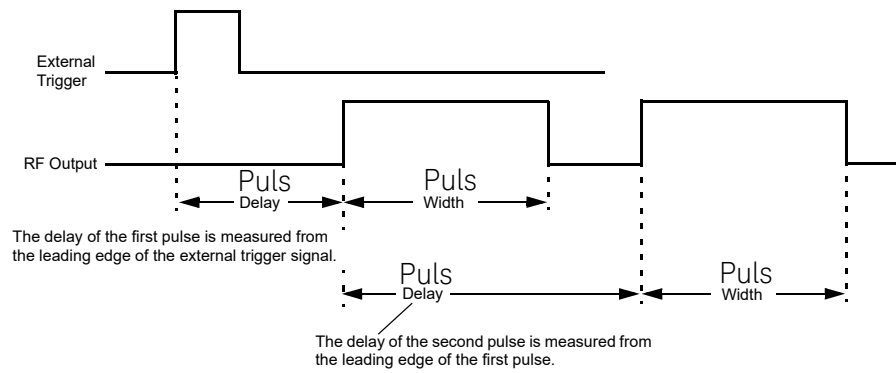
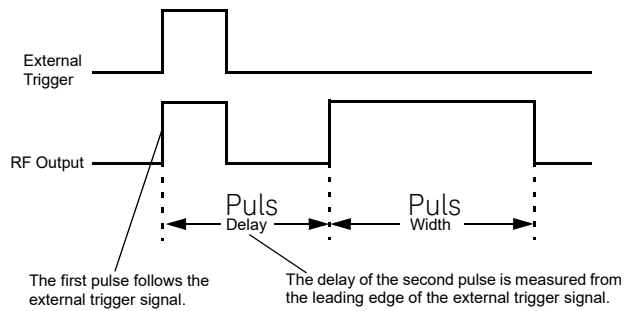


Figure 7-3 Trigger Doublet



## The Basic Procedure

1. Preset the signal generator.
2. Set the carrier (RF) frequency.
3. Set the RF amplitude.
4. Configure the modulation:
  - a. Set the pulse source: Press **Pulse** > **Pulse Source** > **selection**
  - b. Set the parameters for the selected pulse source:

Square	Free Run (default)	Triggered	Adjustable Doublet	Trigger Doublet	Gated	Pulse Train <sup>a</sup>	External
Pulse Rate	—	—	—	—	—	—	—
—	Pulse Period	—	—	—	Pulse Period	—	—
—	Pulse Delay	Pulse Delay	Pulse Delay	Pulse Delay	—	Pulse Delay	—
—	Pulse Width	Pulse Width	Pulse Width	Pulse Width	Pulse Width	—	—
—	—	—	Pulse 2 Delay	—	—	—	—
—	—	—	Pulse 2 Width	—	—	—	—
—	—	—	—	—	—	Pulse On <sup>b</sup>	—
—	—	—	—	—	—	Pulse Off <sup>b</sup>	—

a. Requires Option N5180320B.

b. Up to 2047 pulse cycles (elements) composed of both Pulse On and Pulse Off can be user defined.

5. Turn on the modulation: **Pulse Off On** softkey to On.

The the PULSE annunciator lights, indicating that you enabled modulation.

6. Output the modulated signal from the signal generator: Press the front panel **RF On Off** key.

The RF output LED lights, indicating that the signal is transmitting from the RF output connector.

See also, **“Modulating the Carrier Signal” on page 72.**

## Example

The following example uses the factory preset pulse source and delay.

Output: A 2 GHz, 0 dBm carrier modulated by a 24  $\mu$ s pulse that has a period of 100  $\mu$ s.

1. Preset the signal generator.
2. Set the frequency to 2 GHz.
3. Set the amplitude to 0 dBm.
4. Set the pulse period to 100 microseconds: Press **Pulse** > **Pulse Period** > **100** > **usec**.
5. Set the pulse width to 24 microseconds: Press **Pulse** > **Pulse Width** > **24** > **usec**
6. Turn on both the pulse modulation and the RF output.

The PULSE annunciator displays and the RF output LED lights.

If the modulation does not seem to be working properly, refer to **“No Modulation at the RF Output”** on page 443.



## Pulse Train (Options UNW and N5180320B)

The Option N5180320B Pulse Train feature enables the specification of up to 2047 independent pulse cycles, each of which has an “On Time”, during which the RF output is measurable at the RF output connector, and an “Off Time”, during which the RF output is attenuated. Each pulse cycle is similar in function to other X-Series signal generator Pulse modes—the Pulse Train feature has up to 2047 cycles, instead of only a maximum of two (with Doublets). There are also repeat counts available for each pulse. These repetitions count against the total count of 2047 cycles.

The instrument can import pulse trains from a .csv (comma separated values) file or some other common ASCII format. It can also export to ASCII/CSV files as well. Export allows specification of the decimal separator and a column separator. The import allows specification of the decimal separator (to allow for “,”), but the column separator is auto-detected. Refer to **“Pulse Train Menu Softkeys” on page 193** and **“Display Pulse Train Menu Softkeys” on page 195**.

Figure 7-4 Pulse Train Menu Softkeys

Pulse > Pulse Source > More > Pulse Train

For details on each key, use key help as described on [page 58](#).

Mod	State	Depth/Dev	Source	Rate	Waveform
AM	Off	0.1%	Internal	400.0Hz	Sine
AM HB	Off		I Input		
FM	Off	1.0000kHz	Internal	400.0Hz	Sine
PM	Off	0.000rad	Internal	400.0Hz	Sine
<b>Pulse</b>	<b>On</b>	<b>Int Triggered</b>	<b>Train</b>		
Burst	Off		Int		
I/Q	Off		Internal		

Display area indicates Pulse Train is the current pulse source.

Free-Run continuously plays the pulse train, ignoring all triggers.  
Triggered runs the pulse train (after waiting the Pulse Delay) each time an external trigger is supplied to the PULSE BNC, the **Trigger Immediately** softkey is pressed, or the Trigger SCPI command is sent.  
Gated runs the pulse train while an external trigger is supplied (level triggered) to the PULSE BNC connector. The state of the GATED trigger is detected only when the playback is transitioning to or in idle. This means that, once started, playback is always completed, even if the GATE trigger changes to the inactive state.

Trigger Immediately causes the pulse train to run once.

SCPI Commands:

```
[:SOURce]:PULM:INternal:TRAI:n:TRIGger FRUN|{TRIGgered}|GATED
[:SOURce]:PULM:INternal:TRAI:n:TRIGger:IMMediate
```

Refer to the *SCPI Command Reference*.

Figure 7-5 Edit Pulse Train Menu Softkeys

For details on each key, use key help as described on [page 58](#).

Pulse > Pulse Source > More > Pulse Train > Edit Pulse Train

	On Time	Off Time	Repeat
1	2.000 us	2.000 us	1
2	2.000 us	2.000 us	2
3	2.000 us	2.000 us	3
4	2.000 us	2.000 us	1

These softkeys provide ease of use in changing the pulse cycle settings in the pulse train.

- Goto Row
  - Enter
  - Goto Top Row
  - Goto Middle Row
  - Goto Bottom Row
- Display Pulse Train (page 195)

page 196

This column indicates the row of a each pulse train cycle.  
**Note:** When the cycles (elements) are repeated, the row numbers are skipped in the displayed count for the number of pulse cycles repeated.  
**Example:** For the pulse train displayed above, in row 2, the 3 us On Time and 2 us Off Time pulse cycle is repeated twice. But, only row 2 is displayed for that pulse cycle (i.e. row 3 is not displayed).

This column displays the on times for each pulse cycle (element) in the pulse train.

This column displays the off times for each pulse cycle (element) in the pulse train.

This column displays the repeat times for each pulse cycle (element) in the pulse train.

page 196

- Load/Store
- Import/Export
- Insert Item
- Delete Item
- Delete All Rows

More 2 of 2

SCPI Commands:

```
[[:SOURCE]:PULM:INTERNAL:TRAI:LIST:PRESet
[:SOURCE]:PULM:INTERNAL:TRAI:OFFTime <20ns - 42sec>
[:SOURCE]:PULM:INTERNAL:TRAI:OFFTime?
[:SOURCE]:PULM:INTERNAL:TRAI:OFFTime:POINTS?
[:SOURCE]:PULM:INTERNAL:TRAI:ONTime <20ns - 42sec>
[:SOURCE]:PULM:INTERNAL:TRAI:ONTime?
[:SOURCE]:PULM:INTERNAL:TRAI:ONTime:POINTS?
[:SOURCE]:PULM:INTERNAL:TRAI:REPetition <1-2047>
[:SOURCE]:PULM:INTERNAL:TRAI:REPetition?
[:SOURCE]:PULM:INTERNAL:TRAI:REPetition:POINTS?
```

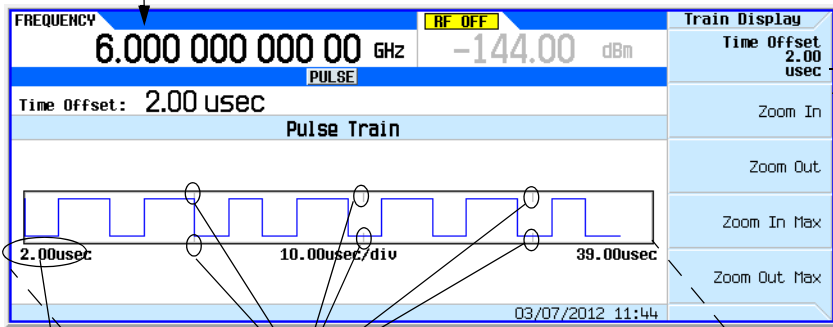
Refer to the *SCPI Command Reference*.

SCPI Commands (continued):

```
:MEMory:CATalog:PTRain?
:MEMory:DELete:PTRain
:MEMory:EXPort[:ASCIi]:PTRain <"filename">
:MEMory:EXPort[:ASCIi]:SEParator:COLumn
TAB|SEMicolon|{COMMA}|SPACE
:MEMory:EXPort[:ASCIi]:SEParator:COLumn?
:MEMory:EXPort[:ASCIi]:SEParator:DECimal {DOT}|COMMA
:MEMory:EXPort[:ASCIi]:SEParator:DECimal?
:MEMory:IMPort[:ASCIi]:PTRain <"filename">
:MEMory:IMPort[:ASCIi]:SEParator:DECimal {DOT}|COMMA
:MEMory:IMPort[:ASCIi]:SEParator:DECimal?
:MMEMory:LOAD:PTRain <"filename">
:MMEMory:STORe:PTRain <"filename">
```

Figure 7-6 Display Pulse Train Menu Softkeys

Pulse > Pulse Source > More > Pulse Train > Edit Pulse Train > Display Pulse Train

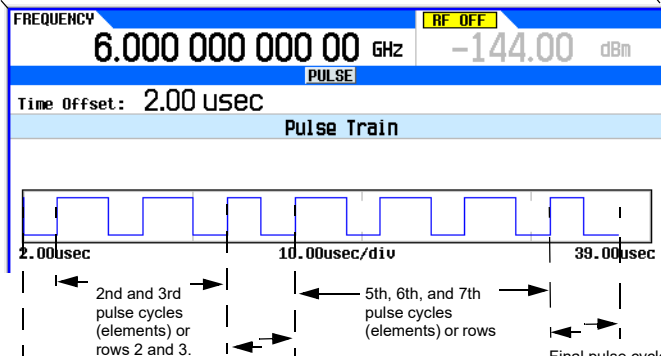


This softkey shifts the time offset from the left hand side of the display to the one specified. Increments and decrements are 1/20th of the visible pulse train.

Use these softkeys to optimize the view of the different characteristics of the pulse train.

This value can be adjusted with the Time Offset softkey.

These are the division markers currently set at 10.00 us/div for the currently displayed view. Use the zoom softkeys to change the time/div value.



This is the initial pulse cycle (row 1) note that the On Time portion of this pulse is not showing due to the 2 us offset.

4th pulse cycle (element) or row 4.

2nd and 3rd pulse cycles (elements) or rows 2 and 3.

5th, 6th, and 7th pulse cycles (elements) or rows

Final pulse cycle (element) in the displayed pulse train above. 8th pulse cycle or row.

For details on each key, use key help as described on [page 58](#).

Figure 7-7 Pulse Train: Import From Selected File Softkeys

Pulse > Pulse Source > More > Pulse Train > Edit Pulse Train > More

For details on each key, use key help as described on page 58.

**FREQUENCY** 6.000 000 000 00 GHz **RF OFF** -144.00 dBm

**PULSE**

Pulse Train	On Time	Off Time	Repeat
1	2.000 us	2.000 us	1
2	3.000 us	2.000 us	2
4	2.000 us	2.000 us	1
5	3.000 us	2.000 us	3
6	2.000 us	2.000 us	1
9	-----	-----	-----

03/07/2012 11:54 More 2 of 2

page 78

These softkeys delete individual On Time or Off Time elements as well as the Repeat cycle counts.

Deleting all Pulse Cycle rows (elements) must be confirmed.

**FREQUENCY** 6.000 000 000 00 GHz **RF OFF** -144.00 dBm

**PULSE**

Catalog of Binary Files in Int Storage 32.7MB used 465MB free

File Name	Type	Size	Modified
1 DISPLAY.BMP	BINARY	76918	22/09/06 22:36
2 DRAM1PM.LIC	BINARY	524	22/09/06 22:36
3 LAUNCH3.EXE	BINARY	925696	22/09/06 22:36
4 PTRAIN.CSV	BINARY	55	04/05/10 08:47
5 PTRAIN.TXT	BINARY	55	04/05/10 08:43
6 PTRAIN2.CSV	BINARY	15	04/05/10 09:08
7 WMPINFO.XML	BINARY	296	22/09/06 22:37

04/05/2010 09:17 More 1 of 2

page 197

page 197

Selects whether the decimal point is a "." or a "," during import of CSV/ASCII files.

This value is persistent across preset/recall and power cycles.

SCPI Commands:  
:MEMory:IMPorT[:ASCIi]:SEParato  
r:DECimal DOT]COMMa  
:MEMory:IMPorT[:ASCIi]:SEParato  
r:DECimal?

**PTRAIN.csv - Notepad**

```
0000001,0000001,2
0000004,0000003,3
0000002,0000002,2
```

This file's data structure uses decimals in the numbers and so requires the Import Decimal Separator to be set to Dot.

Note: Column separated values are auto-detected by the instrument.

**FREQUENCY** 6.000 000 000 00 GHz **RF OFF** -144.00 dBm

**PULSE**

Pulse Train	On Time	Off Time	Repeat
1	2.000 us	1.000 us	2
3	4.000 us	2.000 us	3
6	2.000 us	3.000 us	2
8	-----	-----	-----

Pulse train imported as CSV

After confirming import of the file the new file's pulse train values are displayed.

Figure 7-8 Pulse Train: Export to File Softkeys

Pulse > Pulse Source > More > Pulse Train > Edit Pulse Train > More

Note: Files can be FTP'd to the BIN (Binary) folder in the instrument, or a USB stick can be used to download the files to the instrument. Refer to [page 79](#).

**Import/Export**

Import From Selected File

Export To File

Delete File

Goto Row

Import Decimal Separator

Dot Comma

04/05/2010 08:46 **Page 1 of 2**

**Goto Row**

Enter

Goto Top Row

Goto Middle Row

Goto Bottom Row

**Import/Export**

Export Column Separator (Comma)

Export Decimal Separator (Dot Comma)

**Column Separator**

Comma

Semicolon

Tab

Space

Selects whether the decimal point is a "." or "," during export of the CSV/ASCII files. This value is persistent across preset/recall and power cycles.  
SCPI Commands:  
:MEMory:EXPort[:AS Cij]:SEParator:DECi mal DOT|COMMa  
:MEMory:EXPort[:AS Cij]:SEParator:DECi mal?

Selects whether the column separator is a tab, ";", " ", or "a " during export of the CSV/ASCII files. This value is persistent across preset/recall and power cycles.  
SCPI Commands:  
:MEMory:EXPort[:ASCij]:SEParator:COLumn  
TAB|SEMicolon|COMMa|SPACE  
:MEMory:EXPort[:ASCij]:SEParator:COLumn?

The Export to File softkey menu, writes out a CSV/ASCII file to the BINARY directory. You may supply your own extender as part of the filename.  
Example:  
MEM:EXP:PTR "myfile.csv".  
SCPI Command:  
:MEMory:EXPort[:ASCij]:PTRain <"filename">

**Text Entry**

Enter

Clear Text

Editing Mode

Insert Replace

Show Alpha Table

Off On

ABCDEFGHIJKLMNOPQRSTUVWXYZ  
\_!@#\$%^&\*[]

Use the text editor keys to rename the file to be exported to the BIN (Binary) folder.

Note: Since there is already a file named PTRAIN.CSV the new filename should be different, to avoid overwriting the original PTRAIN.CSV file.

For details on each key, use key help as described on [page 58](#).

Pulse Modulation (Options UNW and N5180320B)  
Pulse Train (Options UNW and N5180320B)

## 8 Basic Digital Operation—No BBG Option Installed

Before using this information, you should be familiar with the basic operation of the signal generator. If you are not comfortable with functions such as setting power level and frequency, refer to [Chapter 3, “Basic Operation”, on page 57](#) and familiarize yourself with the information in that chapter.

See also [“Adding Real-Time Noise to a Dual ARB Waveform” on page 360](#).

## I/Q Modulation

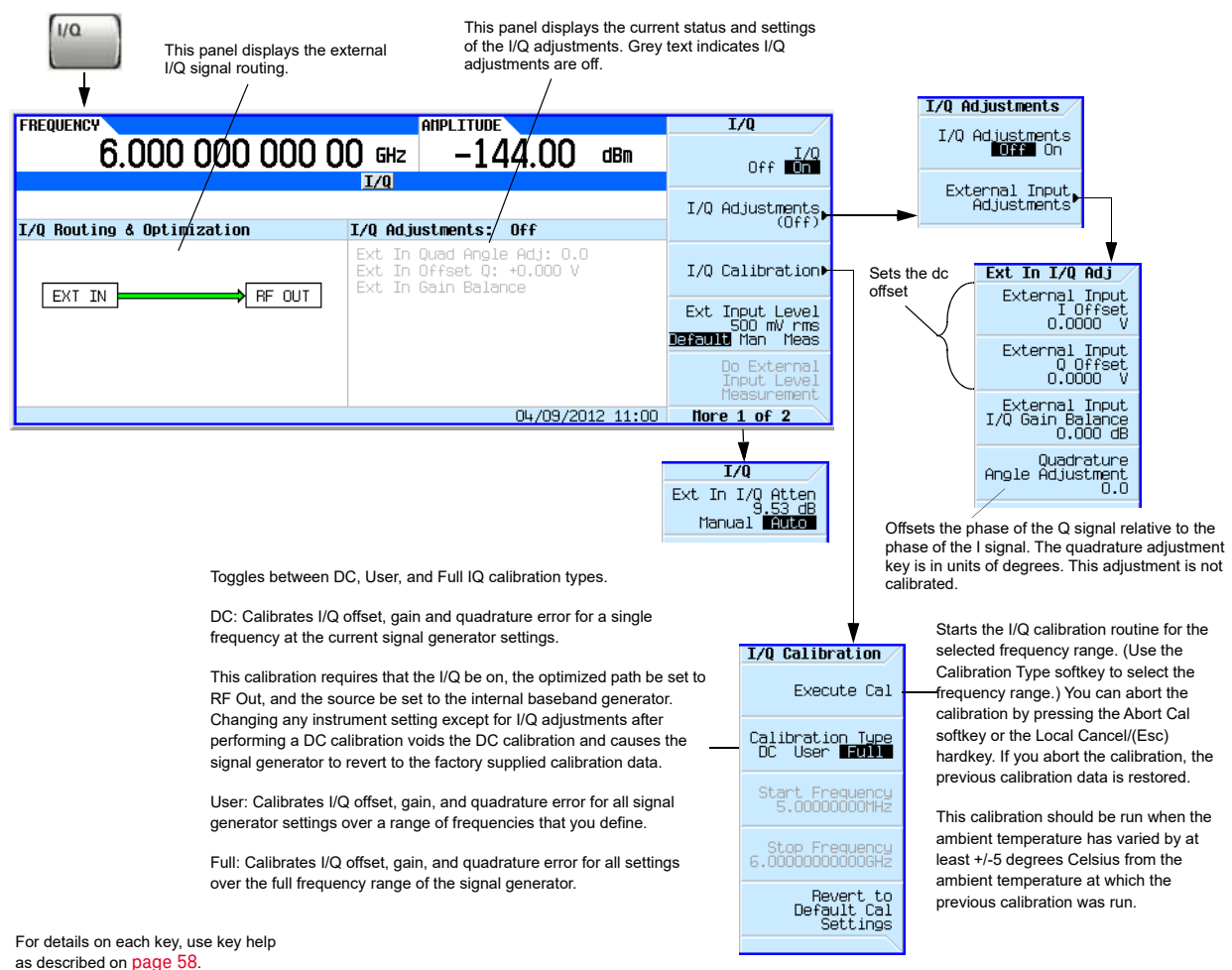
The following factors contribute to the error vector magnitude:

- Differences in amplitude, phase, and delay between the I and Q channels
- DC offsets

The I/Q menu provides adjustments and calibration to compensate for some of the differences in the I and Q signals or to add impairments. See **I/Q Modulation** on page 263 for additional information.

See also **“Modulating the Carrier Signal”** on page 72.

Figure 8-1 I/Q Display and Softkeys



The following table shows common uses for the adjustments.

Table 8-1 I/Q Adjustments Uses

I/Q Adjustment	Effect	Impairment
Offset	Carrier Feedthrough	dc offset



Table 8-1 I/Q Adjustments Uses

I/Q Adjustment	Effect	Impairment
Quadrature Angle	EVM error	phase skew
	I/Q Images	I/Q path delay

## Configuring the Front Panel Inputs

The MXG/EXG accepts externally supplied analog I and Q signals through the front panel I Input and Q Input for modulating onto the carrier.

1. Connect I and Q signals to the front panel connectors. For voltage levels, refer to **“Front Panel Overview” on page 21**.
  - a. Connect an analog I signal to the signal generator’s front panel I Input.
  - b. Connect an analog Q signal to the signal generator’s front panel Q Input.
2. Turn on the I/Q modulator: Press **I/Q Off On** to On.
3. Configure the RF output:
  - a. Set the carrier frequency.
  - b. Set the carrier amplitude.
  - c. Turn the RF output on.
4. Make adjustments to the I/Q signals (**page 200**) as needed.

Basic Digital Operation—No BBG Option Installed  
I/Q Modulation

## 9 Basic Digital Operation (Option 653/655/656/657)

Before using this information, you should be familiar with the basic operation of the signal generator. If you are not comfortable with functions such as setting power level and frequency, refer to **Chapter 3, “Basic Operation”, on page 57** and familiarize yourself with the information in that chapter.

The features described in this chapter are available only in vector signal generators with Option 653 or 655 (N5172B) or Option 656 or 657 (N5182B).

- **Waveform File Basics** on page 205
- **Storing, Loading, and Playing a Waveform Segment** on page 207
- **Waveform Sequences** on page 210
- **Saving a Waveform's Settings & Parameters** on page 215
- **Using Waveform Markers** on page 221
- **Triggering a Waveform** on page 237
- **Clipping a Waveform** on page 244
- **Scaling a Waveform** on page 253
- **Setting the Baseband Frequency Offset** on page 259
- **I/Q Modulation** on page 263
- **I/Q Adjustments** on page 267
- **I/Q Calibration** on page 268
- **Using the Equalization Filter** on page 270
- **Using Finite Impulse Response (FIR) Filters in the Dual ARB Real-Time Modulation Filter** on page 272
- **Modifying a FIR Filter Using the FIR Table Editor** on page 278
- **Setting the Real-Time Modulation Filter** on page 281
- **Multiple Baseband Generator Synchronization** on page 283
- **Understanding Option 012 (LO In/Out for Phase Coherency) with Multiple Baseband Generator Synchronization** on page 289

Basic Digital Operation (Option 653/655/656/657)

- [Waveform Licensing](#) on page 294

See Also:

- [Adding Real-Time Noise to a Dual ARB Waveform](#) on page 360
- [Real-Time Phase Noise Impairment](#) on page 368
- [Multitone and Two-Tone Waveforms \(Option N5180430B\)](#) on page 429

## Waveform File Basics

There are two types of waveform files:

- A **segment** is a waveform file that you download to the signal generator.  
For information on creating and downloading waveform files, refer to the **Programming Guide**.
- A **sequence** is a file you create in the signal generator that contains pointers to one or more waveform files (segments, other sequences, or both).  
For information on creating sequences, see [page 210](#).

## Signal Generator Memory

The signal generator has two types of memory:

- **Volatile** memory, baseband generator (BBG) media, where waveform files are played from or edited.
- **Non-volatile** memory, either internal (int) or external (USB) media, where waveform files are stored.

## Dual ARB Player

### NOTE

The MXG/EXG's ARB Waveform File Cache is limited (see the Data Sheet). Consequently, once the file cache limit has been reached, the waveform switching speed is much slower for additional files loaded into the volatile waveform memory (BBG).

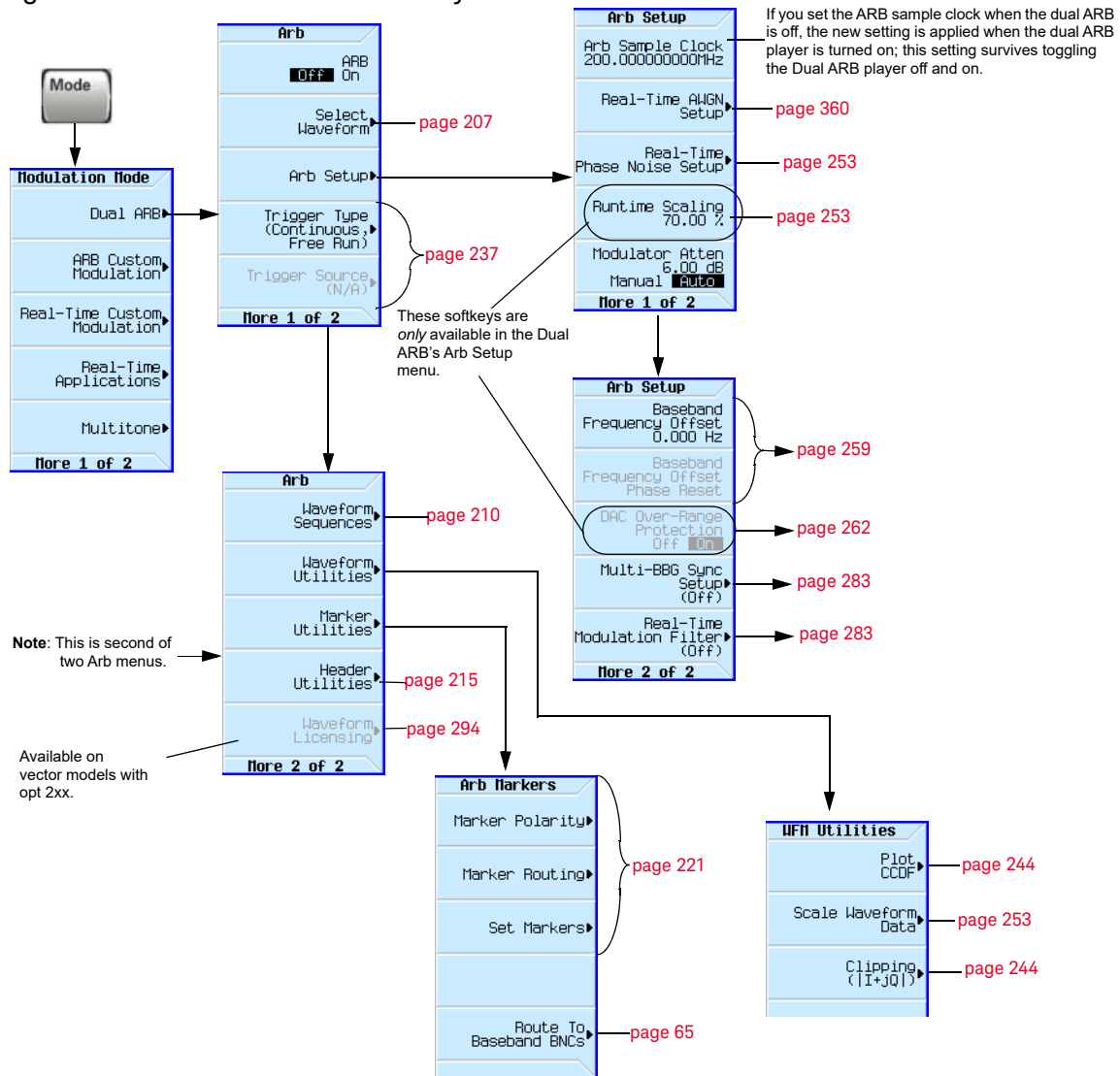
---

The dual ARB waveform player enables you to play, rename, delete, store, and load (external or internal) waveform files in addition to building waveform sequences. The dual ARB waveform player also provides markers ([page 221](#)), triggering ([page 237](#)), clipping ([page 244](#)), and scaling ([page 253](#)) capabilities.

Most procedures in this section start from the Dual ARB menu, shown below.

Figure 9-1

Dual ARB Softkeys



For details on each key, use key help as described on [page 58](#).

## Storing, Loading, and Playing a Waveform Segment

**NOTE**

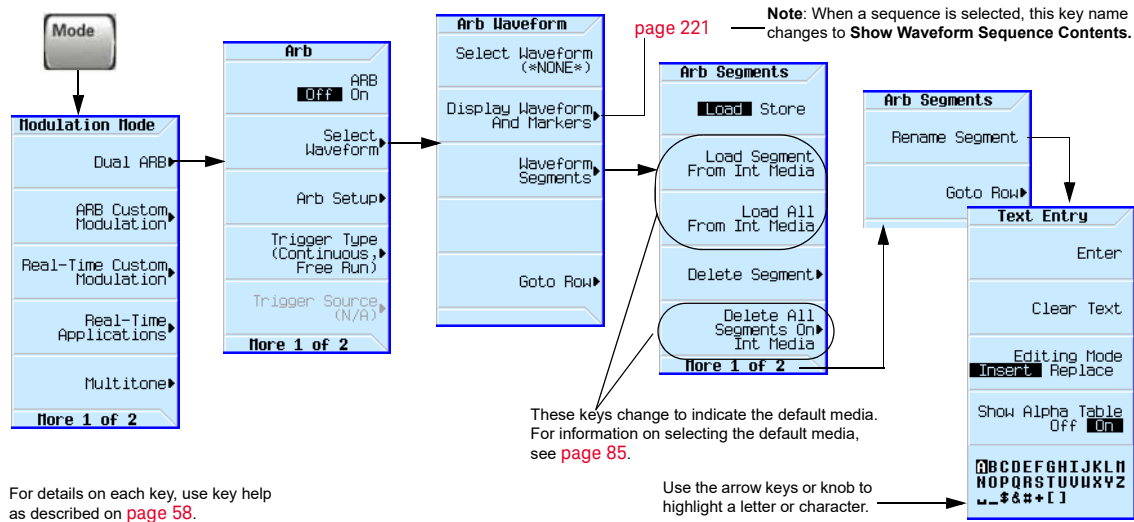
The MXG/EXG's ARB Waveform File Cache is limited to 128 files. Consequently, once the 128 file cache limit has been reached, the waveform switching speed will be much slower for additional files loaded into the volatile waveform memory (BBG).

Before using this information, you should be familiar with the signal generator's file menus. If you are not, refer to **“Working with Files” on page 74** and familiarize yourself with that information.

See also: **“Waveform Sequences” on page 210**.

The signal generator has two types of waveform media: non-volatile (internal or USB), and volatile (BBG). BBG media is also called “working” media, because before you can play, edit, or include a waveform file in a sequence, the waveform file must be loaded into BBG media.

Figure 9-2 Waveform Segment Softkeys



For details on each key, use key help as described on **page 58**.

Use the arrow keys or knob to highlight a letter or character.

### Loading a Waveform Segment into BBG Media

Waveforms must reside in BBG media before they can be played, edited, or included in a sequence. Cycling power or rebooting the signal generator deletes the files in BBG media.

**NOTE**

Each time the instrument powers up, two factory-supplied segments are automatically created in BBG media: **RAMP\_TEST\_WFM** and **SINE\_TEST\_WFM**.

1. Press **Mode** > **Dual ARB** > **Select Waveform** > **Waveform Segments**.
2. Press **Load Store** to highlight **Load**, then use the arrow keys to highlight the desired waveform segment.

3. If there is already a copy of this segment in the currently selected media and you do not want to overwrite it, rename the waveform segment before you load it (refer to the previous procedure).

4. Press **Load Segment From currently selected Media**.

To load **all** files from the currently selected media into BBG media, press **Load All From currently selected Media**.

## Storing/Renaming a Waveform Segment to Internal or USB Media

Use the following steps to store a copy of a file in BBG memory to the currently selected media (page 85). If you have not downloaded a waveform segment, either refer to the **Programming Guide**, or use one of the factory-supplied segments.

1. Press **Mode** > **Dual ARB** > **Select Waveform** > **Waveform Segments**.
2. Press **Load Store** to highlight Store.
3. Using the arrow keys, highlight the waveform segment you want to store.
4. Optionally, rename the segment.

If there is already a copy of this segment in the currently selected media and you do not want to overwrite it, rename the waveform segment before you store it:

- a. Press **More** > **Rename Segment** > **Clear Text**.
  - b. Enter a name for the waveform segment.
  - c. Press **Enter** > **More**.
  - d. Highlight the waveform segment that was renamed.
5. Press **Store Segment to currently selected Media**.
  6. Repeat **Step 3** through **Step 5** for all segments that you want to store.

To save **all** segments from BBG media to the currently selected media, press **Store All to currently selected Media**.

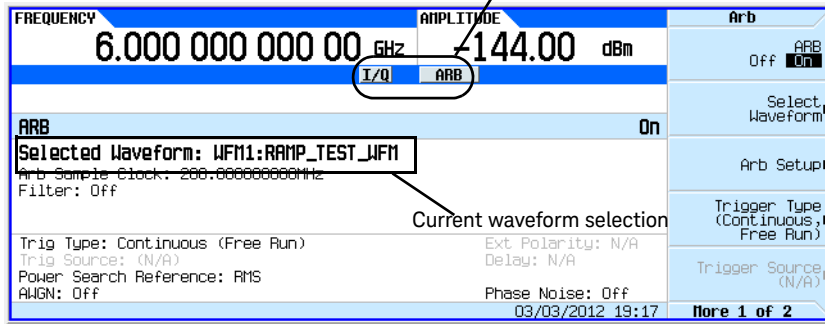
## Playing a Waveform Segment

1. Press **Mode** > **Dual ARB** > **Select Waveform**.
2. In the **Segment on BBG Media** column, highlight the waveform segment you want to play.
3. Press **Select Waveform**.
4. Set **ARB Off On** to On.

This plays the selected waveform segment. Both the **I/Q** and **ARB** annunciators turn on, and the waveform modulates the RF carrier.



Annunciators display with active waveform (ARB On)



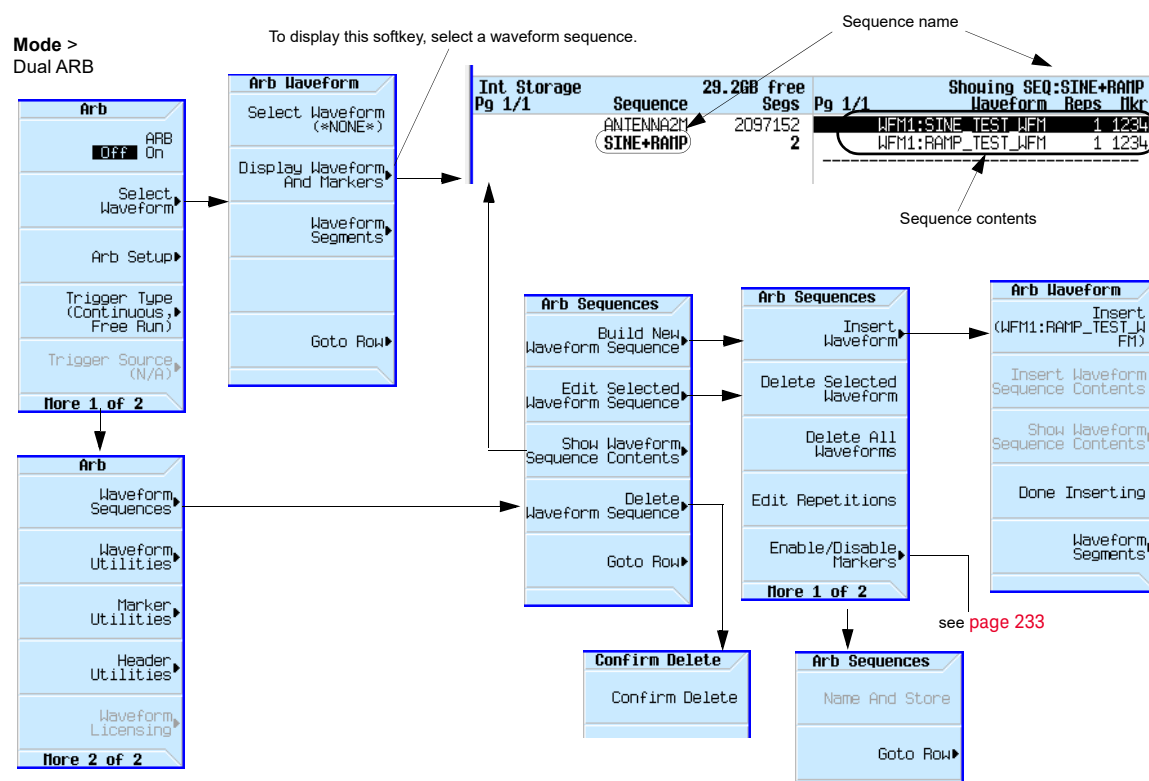
### 5. Configure the RF Output:

Set the RF carrier frequency and amplitude, and turn on the RF output.

The waveform segment is now available at the signal generator's RF Output connector.

## Waveform Sequences

Figure 9-3 Waveform Sequence Softkeys



For details on each key, use key help as described on [page 58](#).

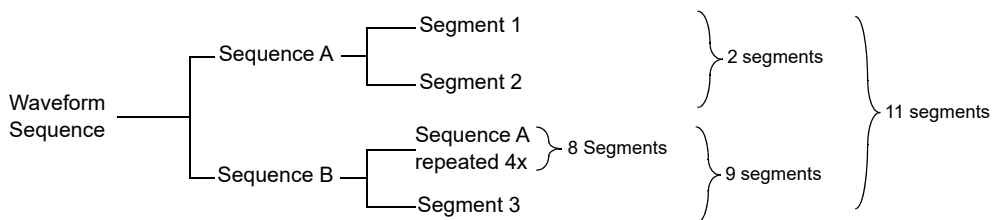
A waveform sequence is a file that contains pointers to one or more waveform segments or other waveform sequences, or both. This lets the signal generator play multiple waveform segments, or other sequences, or both thereby eliminating the need to stop waveform playback just to select another waveform.

The segments that a waveform sequence points to are **not** automatically stored when you store the sequence; you must also store the individual segments or they are lost when you turn off or reboot the signal generator. If the segments are located in internal/external media, you must load them into BBG media prior to selecting a waveform sequence (see [page 207](#)). If you attempt to play a sequence without the segments loaded into BBG media, the signal generator reports: **ERROR: 629, File format invalid**. If this happens and the segments are not stored in internal/external media, you must recreate the segments using the same file names that the sequence points to before you can play the sequence.

### Creating a Sequence

A waveform sequence can contain up to 1,024 segments and have both segments and other sequences (nested sequences). The signal generator lets you set the number of times the segments and nested sequences repeat during playback. But there is a difference between repeating a

segment versus repeating a nested sequence. Each segment can repeat up to 65,535 times, but no matter how many times a segment repeats, it counts as a single segment. However each repetition of a nested sequence counts as additional segments.



The maximum number of times that a nested sequence can repeat is based on the number of segments in the nested sequence and the remaining number of allowed segments (1,024). For example, with a sequence that contains 24 segments and one nested sequence with 4 segments, the nested sequence is limited to 250 repetitions:

$$24 + (4 \times 250) = 1,024 \text{ maximum number of segments per sequence}$$

Even though there is a limiting factor on the maximum number of times that a nested sequence can repeat, each segment within the nested sequence can repeat up to 65,535 times.

### Example

Use the following procedure to create and store a waveform sequence using one repetition each of two different segments.

**Assumption:** The waveform segments are in BBG media (volatile memory). For information on loading waveform segments into BBG media, see [page 207](#).

#### 1. Select the first segment:

- a. Press **Mode** > **Dual ARB** > **More** > **Waveform Sequences** > **Build New Waveform Sequence** > **Insert Waveform**.
- b. Highlight the desired waveform segment and press **Insert**.

#### 2. Select the second segment:

- a. Highlight the next desired waveform segment and press **Insert**.
- b. Press **Done Inserting**

3. Name and store the waveform sequence to the `Seq` file catalog:
  - a. Press **More** > **Name and Store**.
  - b. Enter a file name and press **Enter**.

See also, “[Viewing the Contents of a Sequence](#)” on page 212 and “[Setting Marker Points in a Waveform Segment](#)” on page 228.

## Viewing the Contents of a Sequence

There are two ways to view the contents of a waveform sequence:

### Through the Waveform Sequences Softkey

1. Press **Mode** > **Dual ARB** > **More** > **Waveform Sequences**.
2. Highlight the desired sequence.
3. Press **Show Waveform Sequence Contents**.

### Using the Select Waveform Softkey

1. Press **Mode** > **Dual ARB** > **Select Waveform**.
2. In the `Sequence On` column, highlight the desired waveform sequence.
3. Press **Show Waveform Sequence Contents**.

## Editing a Sequence

When editing a waveform sequence, you can:

- change the number of times each segment or nested sequence plays
- delete segments or nested sequences from the sequence
- add segments or nested sequences to the sequence
- toggle markers on and off (described on [page 233](#))
- save changes either to the current waveform sequence or as a new sequence

If you exit the sequence editing menu before saving changes, the changes are lost.

Sequences save to the `Seq` file catalog.

### CAUTION

If you edit and resave a segment used in a sequence, the sequence does not automatically update the RMS value in its header. You must select and update the sequence header information ([page 215](#)).

Use the following steps to edit a sequence that has two different segments so that the first segment repeats 100 times and the second segment repeats 200 times, then save the changes.

**Assumption:** A waveform sequence that has two different segments has been created and stored (see previous example on [page 211](#)).

1. Select the sequence:  
Press **Mode** > **Dual ARB** > **More** > **Waveform Sequences** > **highlight the desired sequence** > **Edit Selected Waveform Sequence**.
2. Change the first segment so that it repeats 100 times:  
Highlight the first segment entry and press **Edit Repetitions** > **100** > **Enter**.  
The cursor moves to the next entry.
3. Change the repetition for the selected entry to 200:  
Press **Edit Repetitions** > **200** > **Enter**.
4. Save the changes made in the previous steps:  
Press **More** > **Name and Store** > **Enter**.  
To save the changes as a *new* sequence:
  - a. Press **More** > **Name and Store** > **Clear Text**.
  - b. Enter a file name (for example, SINE100+RAMP200).
  - c. Press **Enter**.

The edited sequence saves as a new waveform sequence.

## Playing a Sequence

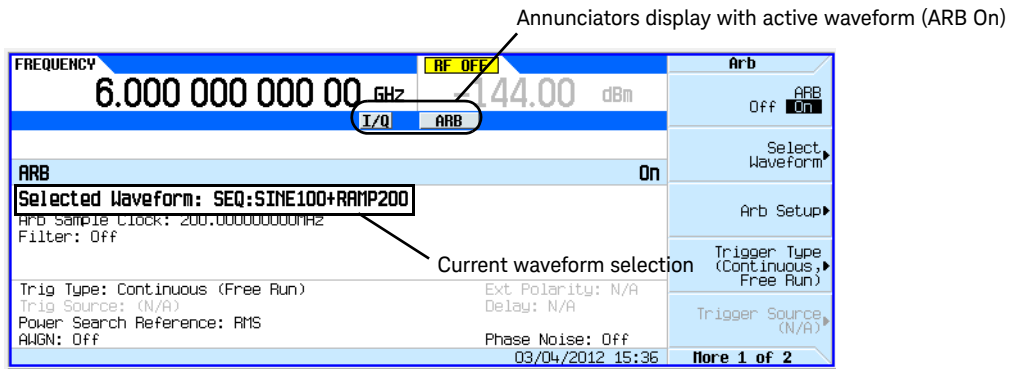
If you have not created a waveform sequence, refer to [“Creating a Sequence” on page 210](#).

### NOTE

To play a waveform segment individually or as part of a waveform sequence, the segment must reside in BBG media. See also, [“Loading a Waveform Segment into BBG Media” on page 207](#).

1. Select a waveform sequence:
  - a. Press **Mode** > **Dual ARB** > **Select Waveform**.
  - b. Highlight a waveform sequence (for this example, SINE100+RAMP200) from the Sequence On column.
  - c. Press **Select Waveform**.

The display shows the currently selected waveform (for example, Selected Waveform: SEQ:SINE100+RAMP200).



2. Generate the waveform:  
Press **ARB Off On** to On.

This plays the selected waveform sequence. During the waveform sequence generation, both the I/Q and ARB annunciators turn on, and the waveform modulates the RF carrier.

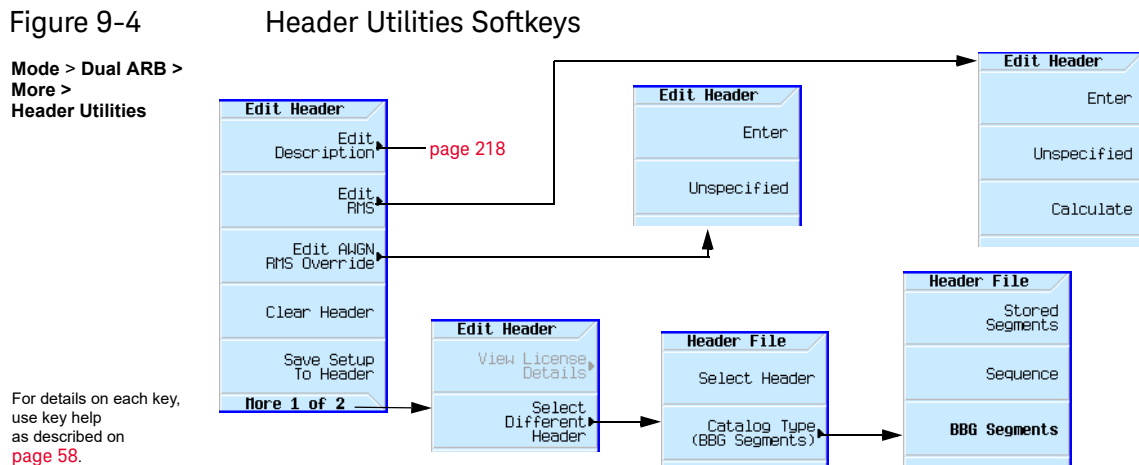
3. Configure the RF output:
  - a. Set the RF carrier frequency.
  - b. Set the RF output amplitude.
  - c. Turn on the RF output.

The waveform sequence is now available at the signal generator's RF OUTPUT connector.

## Saving a Waveform's Settings & Parameters

This section describes how to edit and save a file header. When you download only a waveform file (I/Q data, which the signal generator treats as a waveform segment), the signal generator automatically generates a file header and a marker file with the same name as the waveform file. Initially the file header has no signal generator settings saved to it, and the marker file consists of all zeros. For a given waveform, you can save signal generator settings and parameters in its file header and marker settings in its marker file (page 221); when you load a stored waveform file into BBG media, the file header and marker file settings automatically apply to the signal generator so that the dual ARB player sets up the same way each time the waveform file plays.

Figure 9-4



When you create a waveform sequence (as described on page 210), the signal generator automatically creates a waveform sequence header that takes priority over the individual waveform segment headers. During a waveform sequence playback, the segment headers are ignored, except to verify that all required options are installed. Storing a waveform sequence also stores its file header.

Some of the current signal generator settings shown in the file header appear as part of the softkey labels, and others appear in the dual ARB summary display, shown in the following example.

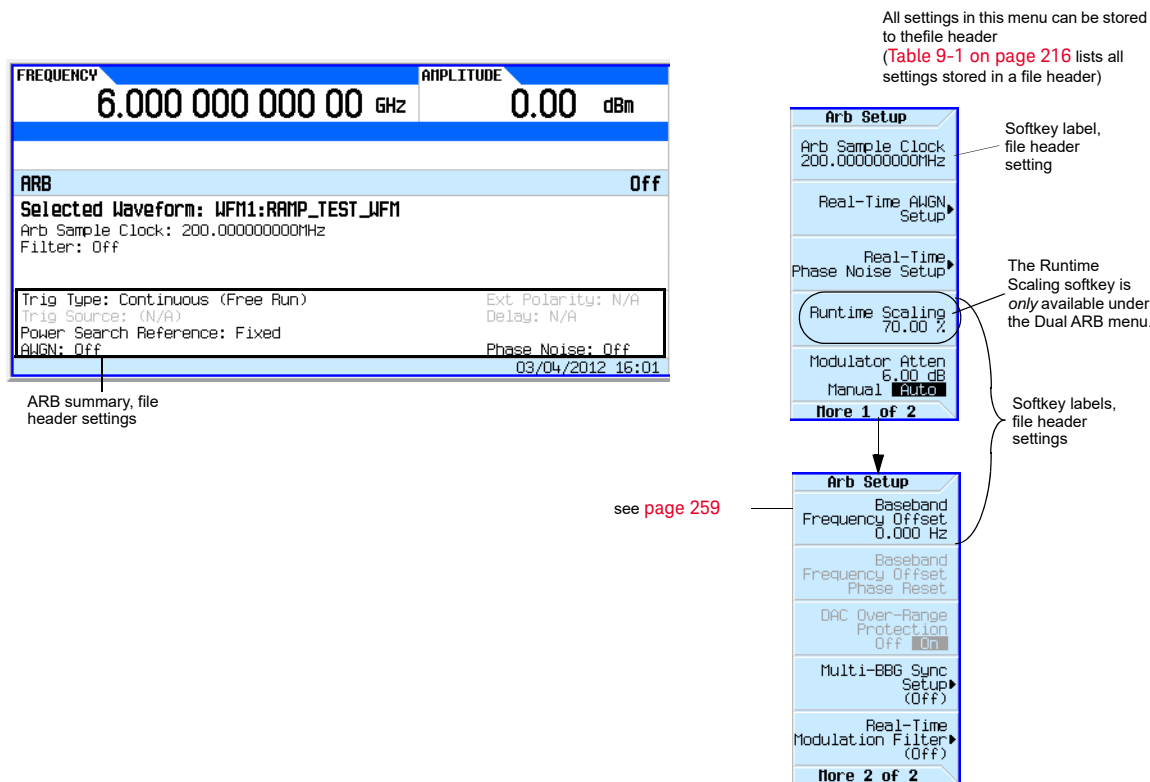


Table 9-1 File Header Entries

32-Character Description	A description entered for the header, such as a the waveform's function (saved/edited with the <b>Edit Description</b> softkey, see <a href="#">Figure 9-4 on page 215</a> ).
Sample Rate	The waveform playback rate. This is the ARB sample clock rate, set in the Arb Setup menu (shown in <a href="#">"Dual ARB Softkeys" on page 206</a> ).
Runtime Scaling	The Runtime scaling value is applied in real-time while the waveform is playing. This setting can be changed only for files playing in the dual ARB player (see <a href="#">page 256</a> ).
RMS	When the modulator attenuation setting (see <a href="#">page 206</a> ) is set to Auto, this value is used to calculate the I/Q modulator attenuation setting to optimize ACPR. Value: 0 to 1.414213562.
Marker 1...4 Polarity	Marker polarity can be positive or negative (described on <a href="#">page 233</a> ).
ALC Hold Routing	Which marker, if any, implements the ALC hold function (described on <a href="#">page 223</a> ), which holds the ALC at its current level when the marker signal is low. All waveforms generated in the signal generator have a marker on the first sample point. To see the results from the three routing selections, you may need to select a range of sample (marker) points (see <a href="#">"Setting Marker Points in a Waveform Segment" on page 228</a> ).
RF Blank Routing	Which marker, if any, implements the RF blanking function (described on <a href="#">page 232</a> ) when the marker signal is low. RF blanking also uses ALC hold. There is no need to select the ALC Hold Routing for the same marker when you are using the RF Blank Routing function. When the marker signal goes high, RF blanking discontinues.
Mod Attenuation	The I/Q modulator attenuation setting (set in the Arb Setup menu shown in <a href="#">Figure 9-1 on page 206</a> ).
BB Freq Offset	The baseband frequency offset, in Hz (see <a href="#">page 259</a> ).



**Table 9-1 File Header Entries**

AWGN: State	Indicated whether real-time noise is on (1) or off (0) (see <a href="#">page 359</a> ).
AWGN: C/N Ratio	Carrier to noise ration, in dB (see <a href="#">page 364</a> ).
AWGN: Carrier BW	Bandwidth over which the noise power is integrated, in Hz (see <a href="#">page 364</a> ).
AWGN: Noise BW	Bandwidth of the noise, in Hz (see <a href="#">page 364</a> ).
AWGN: Carrier RMS	The carrier RMS across the carrier bandwidth (see <a href="#">page 364</a> ).
Phase Noise State	Indicated whether phase noise is on (1) or off (0) (see <a href="#">page 368</a> ).
Phase Noise F1	The start frequency for the level mid-frequency characteristics (see <a href="#">page 368</a> ).
Phase Noise F2	The end frequency for the level mid-frequency characteristics (see <a href="#">page 368</a> ).
Phase Noise Lmid	The amplitude for the level mid-frequency characteristics (see <a href="#">page 368</a> ).
Modulation Filter	The real-time modulation filter type selected (see <a href="#">page 281</a> ).
Over-Range Protect	Indicated whether DAC Over-Range Protection is on (1) or off (0) (see <a href="#">page 372</a> ).
Unique Waveform Id	0 = no Id; once an Id is assigned, it cannot be changed.
License Required	Indicates whether a license is required to play the waveform. See also: <a href="#">"Viewing Options and Licenses" on page 54</a>
Can be Read Out	Indicates whether the waveform can be queried through SCPI or FTP.

## Viewing and Modifying Header Information

The following example uses the factory-supplied waveform file `RAMP_TEST_WFM`.

1. From **BBG media**, select the waveform `RAMP_TEST_WFM`:
  - a. Press **Mode > Dual ARB > Select Waveform**.
  - b. In the `Segment On` column, highlight the waveform `RAMP_TEST_WFM`.
  - c. Press **Select Waveform**.
2. Open the Header Utilities menu:

Press **More > Header Utilities**

The [Figure 9-5](#) shows the default file header for the factory-supplied waveform `RAMP_TEST_WFM`. The `Header Field` column lists the file header parameters; use the **Page Down** key to see them all.

The `Saved Header Settings` column shows that most of the settings are `Unspecified`. `Unspecified` means that there is no setting saved for that particular parameter.

The `Current Inst. Settings` column shows the current signal generator settings. In this example, these are the settings that you will save to the file header.

**NOTE**

If a setting is unspecified in the file header, the signal generator uses its current value for that setting when you select and play the waveform.

Figure 9-5 Example File Header

Mode > Dual ARB > More > Header Utilities

The name of the waveform file.

The description can be up to 32-characters.

Opens a menu for manually defining the carrier RMS value to use for calculating the AWGN: Carrier RMS value in the Header Field.

Resets the saved header settings entries to default settings

Default header settings

Current signal generator settings

To calculate the RMS waveform voltage:  
 Press **Calculate**  
 Then refer to Header Field information.  
 Note: For greater accuracy, if the waveform has long rise/fall times, a DC offset, or noise\* already added to the waveform (for a burst signal), it is recommended that the Edit RMS and Edit AWGN RMS Override softkeys are used for the best measurement accuracy.  
 \*Option N5180403B Real-time AWGN does *not* affect the Header Field RMS value. *But, noise added to the waveform prior to downloading and playing in the signal generator does affect the Header Field RMS value.*

**3. Save the information in the Current Inst. Settings column to the file header:**

Press **Save Setup To Header**.

Both the Saved Header Settings column and the Current Inst. Settings column now display the same values; the Saved Header Settings column lists the settings saved in the file header.

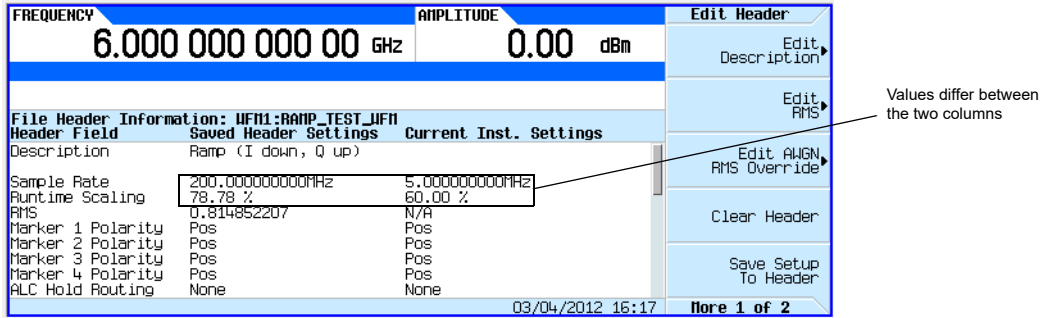
**4. Edit and Update Settings**

- a. Return to the ARB Setup menu:  
 Press **Return > More > ARB Setup**.

From this menu you can access some of the signal generator settings that are saved to the file header. **Figure 9-1 on page 206** shows the ARB Setup softkeys used in the following steps.

- b. Set the ARB sample clock to 5 MHz:  
 Press **ARB Sample Clock > 5 > MHz**.
- c. Set waveform runtime scaling to 60%:  
 Press **Waveform Runtime Scaling > 60 > %**.
- d. Return to the Header Utilities menu:  
 Press **Return > More > Header Utilities**.

As shown in the following figure, the **Current Inst. Settings** column now reflects the changes to the current signal generator setup, but the **saved** header values have not changed.



- e. Save the current settings to the file header:  
 Press the **Save Setup To Header** softkey.

The settings from the **Current Inst. Settings** column now appear in the **Saved Header Settings** column. This saves the new current instrument settings to the file header.

If you change any of the signal generator settings listed in the file header after you select the waveform file, the changed setting(s) appear in the file header's **Current Inst. Settings** column and are used instead of the saved header settings. To reapply the saved header settings, reselect the waveform for playback.

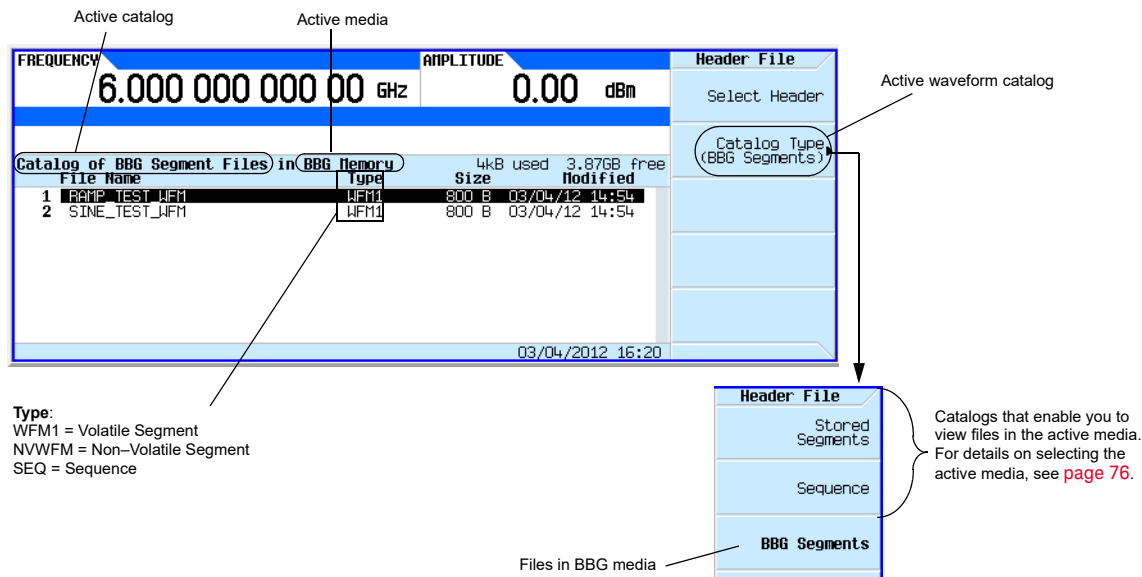
## Viewing & Editing a Header without Selecting the Waveform

As described on [page 217](#), you can view and edit a waveform's header information after you select the waveform; you can also edit waveform header information without selecting a waveform, or for another waveform than the one that is currently selected.

1. Access the file header utilities menu:  
 Press **Mode** > **Dual ARB** > **More** > **Header Utilities** > **More** > **Select Different Header**.

The signal generator displays an alphabetical list of the waveform files in the media that was last selected. The following figure shows an example of the factory-supplied waveforms in BBG media.

Basic Digital Operation (Option 653/655/656/657)  
 Saving a Waveform's Settings & Parameters



For details on each key, use key help as described on [page 58](#).

- If the desired catalog is not displayed, select it.
- Highlight the desired waveform file and press **Select Header**.  
 The signal generator displays the file header for the selected waveform file.
- To edit the header, press **More**, and proceed as described in [Step 4 on page 218](#) (Viewing and Modifying Header Information section).

## Using Waveform Markers

The signal generator provides four waveform markers to mark specific points on a waveform **segment**. When the signal generator encounters an enabled marker, an auxiliary signal is routed to a rear panel event output that corresponds to the marker number.

- Event 1 is available at both the EVENT 1 BNC connector (see [page 31](#)), and a pin on the AUXILIARY I/O connector (see [page 33](#)).
- Event 2 is available at the TRIG 1 & TRIG 2 connectors (see [page 29](#)), and a pin on the AUXILIARY I/O connector (see [page 33](#)).
- Events 3 and 4 are available at pins on the AUXILIARY I/O connector (see [page 33](#)).

You can use an auxiliary output signal to synchronize another instrument with the waveform, or as a trigger signal to start a measurement at a given point on a waveform.

You can also configure markers to initiate ALC hold or RF Blanking (which includes ALC hold). Refer to [“Using Waveform Markers” on page 221](#) for details.

When you download a waveform file that does not have a marker file associated with it, the signal generator creates a marker file without any marker points. Factory-supplied segments (`RAMP_TEST_WFM` and `SINE_TEST_WFM`) have a marker point on the first sample for all four markers.

The following procedures demonstrate how to use markers while working in the dual ARB player. These procedures also discuss two types of points: a **marker point** and a sample point. A marker point is a point at which a given marker is set on a waveform; you can set one or more marker points for each marker. A **sample point** is one of the many points that compose a waveform.

There are three basic steps to using waveform markers:

[Clearing Marker Points from a Waveform Segment](#) on page 227

[Setting Marker Points in a Waveform Segment](#) on page 228

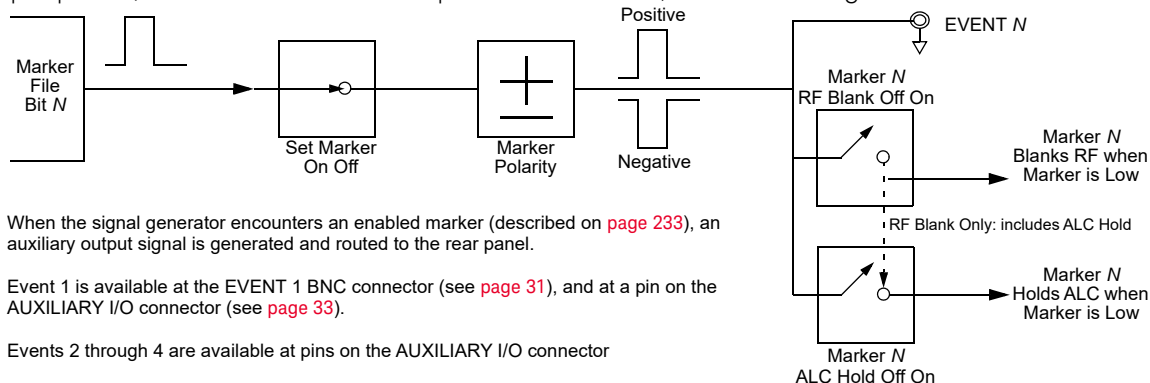
[Controlling Markers in a Waveform Sequence](#) on page 233

This section also provides the following information:

- [Waveform Marker Concepts](#) on page 222
- [Accessing Marker Utilities](#) on page 226
- [Viewing Waveform Segment Markers](#) on page 227
- [Viewing a Marker Pulse](#) on page 230
- [Using the RF Blanking Marker Function](#) on page 232
- [Setting Marker Polarity](#) on page 233

## Waveform Marker Concepts

The signal generator's Dual ARB provides four waveform markers for use on a waveform segment. You can set each marker's polarity and marker points (on a single sample point or over a range of sample points). Each marker can also perform ALC hold, or RF Blanking and ALC hold.



## Marker Signal Response

The signal generator aligns the marker signals with the I and Q signals at the baseband generator. However some settings such as amplitude, filters, and so forth within the RF output path can create delays between the marker EVENT output signal and the modulated RF output. When using the marker EVENT output signal, observe the signals (marker relative to modulated RF) for any latency, and if needed, reset the marker point positions, include delay ([page 267](#)), or both.

## Marker File Generation

Downloading a waveform file (as described in the **Programming Guide**) that does not have a marker file associated with it causes the signal generator to automatically create a marker file, but does **not** place any marker points.

## Marker Point Edit Requirements

Before you can modify a waveform segment's marker points, the segment must reside in BBG media (see **"Loading a Waveform Segment into BBG Media"** on [page 207](#)).

## Saving Marker Polarity and Routing Settings

Marker polarity and routing settings remain until you reconfigure them, preset the signal generator, or cycle power. To ensure that a waveform uses the correct settings when it is played, set the marker polarities or routing (RF Blanking and ALC Hold) and save the information to the file header ([page 215](#)).

### NOTE

When you use a waveform that does not have marker routings and polarity settings stored in the file header, and the previously played waveform used RF Blanking, ensure that you set RF Blanking to **None**. Failure to do so can result in no RF output or a distorted waveform.

## ALC Hold Marker Function

While you can set a marker function (described as **Marker Routing** on the softkey label) either before or after you set marker points ([page 228](#)), setting a marker function before setting marker points may cause power spikes or loss of power at the RF output.

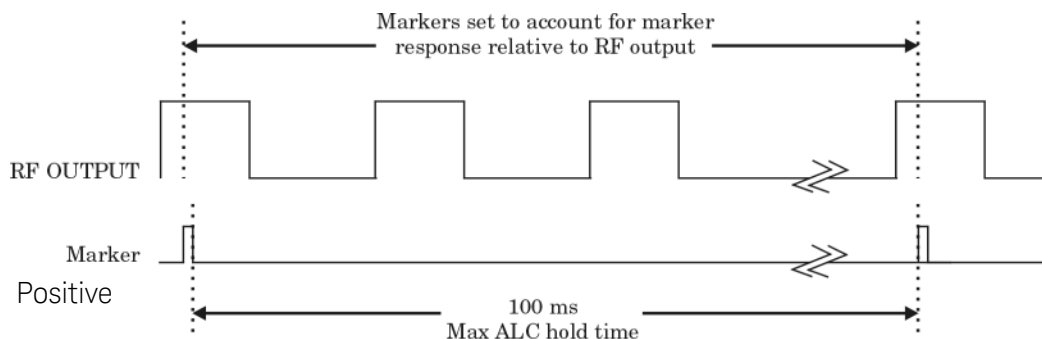
Use the ALC hold function by itself when you have a waveform signal that incorporates idle periods, burst ramps, or when the increased dynamic range encountered with RF blanking ([page 232](#)) is not desired.

The ALC hold marker function holds the ALC circuitry at the **average** value of the sampled points set by the marker(s). For both positive and negative marker polarity, the ALC samples the RF output signal (the carrier plus any modulating signal) when the marker signal goes high:

- Positive: The signal is sampled during the on marker points.
- Negative: The signal is sampled during the off marker points.

### NOTE

Because it can affect the waveform's output amplitude, do not use the ALC hold for longer than 100 ms. For longer time intervals, refer to **"Power Search Mode"** on [page 121](#).



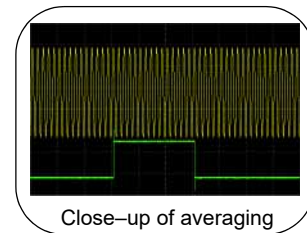
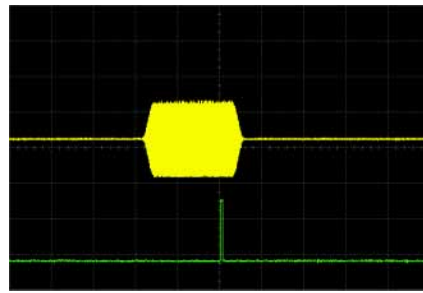
### CAUTION

Incorrect ALC sampling can create a sudden unlevelled condition that may create a spike in the RF output, potentially damaging a DUT or connected instrument. To prevent this condition, ensure that you set markers to let the ALC sample over an amplitude that accounts for the higher power levels encountered within the signal.

### Example of Correct Use

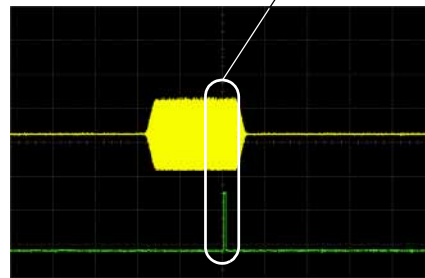
Waveform: 1022 points  
Marker range: 95–97  
Marker polarity: Positive

This example shows a marker set to sample the waveform's area of highest amplitude. Note that the marker is set well before the waveform's area of lowest amplitude. This takes into account any response difference between the marker and the waveform signal.



The ALC samples the waveform when the marker signal goes high, and uses the average of the sampled waveform to set the ALC circuitry.

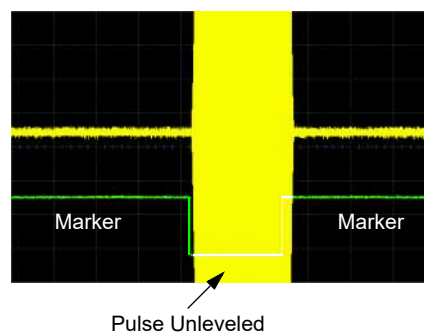
Here the ALC samples during the *on* marker points (positive polarity).



### Example of Incorrect Use

Waveform: 1022 points  
Marker range: 110–1022  
Marker polarity: Positive

This example shows a marker set to sample the low part of the same waveform, which sets the ALC modulator circuitry for that level; this usually results in an unlevelled condition for the signal generator when it encounters the high amplitude of the pulse.

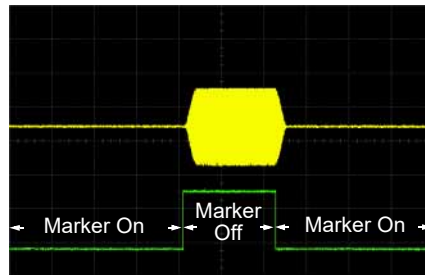




### Example of Incorrect Use

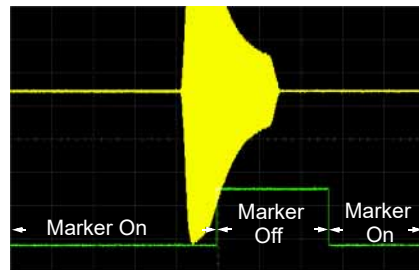
Waveform: 1022 points  
Marker range: 110–1022  
Marker polarity: Negative

This figure shows that a negative polarity marker goes low during the marker *on* points; the marker signal goes high during the *off* points. The ALC samples the waveform during the *off* marker points.



Sample range begins on first point of signal

Sampling both on and off time sets the modulator circuitry incorrectly for higher signal levels. Note the increased amplitude at the beginning of the pulse.

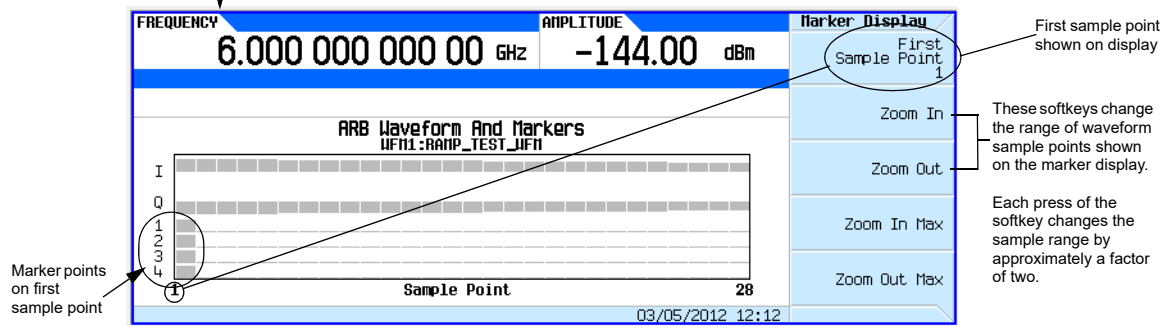
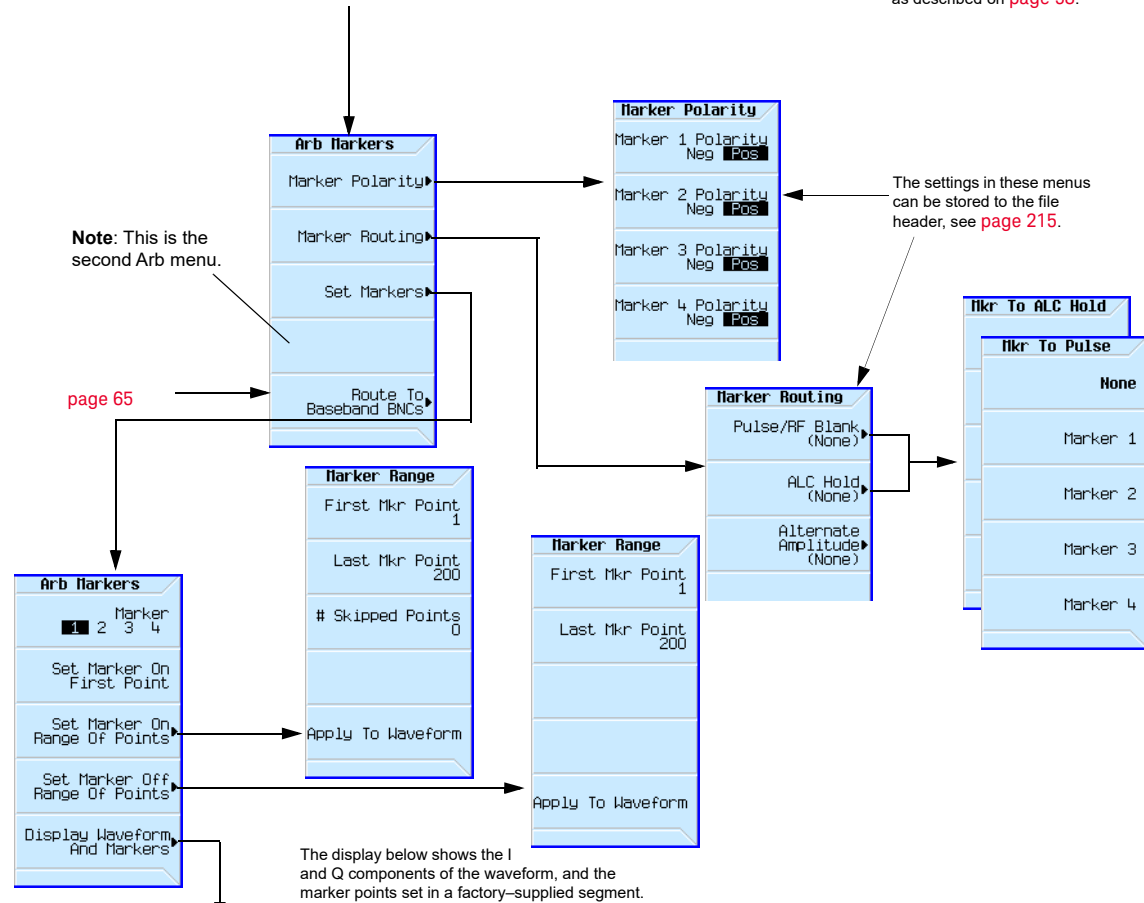


Negative range set between signal and off time

## Accessing Marker Utilities

Mode > Dual ARB > More > Marker Utilities

For details on each key, use key help as described on [page 58](#).



## Viewing Waveform Segment Markers

Markers are applied to waveform segments. Use the following steps to view the markers set for a segment (this example uses the factory-supplied segment, `SINE_TEST_WFM`).

1. In the second Arb menu (page 226), press **Marker Utilities > Set Markers**.
2. Highlight the desired waveform segment (in this example, `SINE_TEST_WFM`).
3. Press **Display Waveform and Markers > Zoom in Max**.  
The maximum zoom in range is 28 points.

Experiment with the Zoom functions to see how they display the markers.

The display can show a maximum of 460 points; displayed waveforms with a sample point range greater than 460 points may not show the marker locations.

## Clearing Marker Points from a Waveform Segment

When you set marker points they do not replace points that already exist, but are set **in addition** to existing points. Because markers are cumulative, before you set points, view the segment (page 227) and remove any unwanted points. With all markers cleared, the level of the event output signal is 0V. To clear marker points on a segment, the segment must reside in BBG media (page 207).

### Clearing All Marker Points

1. In the second Arb menu (page 226), press **Marker Utilities > Set Markers**.
2. Highlight the desired waveform segment (in this example, `SINE_TEST_WFM`).
3. Highlight the desired marker number: Press **Marker 1 2 3 4**.
4. For the selected marker number, remove all marker points in the selected segment:
  - a. Press **Set Marker Off Range of Points**.  
Notice that the softkeys for the first and last marker points correspond with the length of the waveform. The factory-supplied waveform (`SINE_TEST_WFM`) contains 200 samples. To clear all set marker points, the range must equal to the length of the waveform.
  - b. Press **Apply To Waveform > Return**.
5. Repeat from **Step 3** for any remaining marker points that you want to remove from the other markers.

### Clearing a Range of Marker Points

The following example uses a waveform with marker points (Marker 1) set across points 10–20. This makes it easy to see the affected marker points. The same process applies whether the existing points are set over a range or as a single point (page 228):

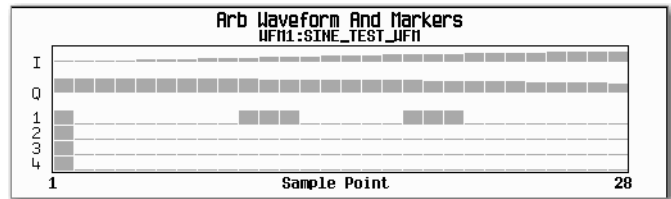
1. In the second Arb menu (page 226), press **Marker Utilities > Set Markers**, then select Marker 1.
2. Set the first sample point that you want off (for this example, 13):  
Press **Set Marker Off Range Of Points > First Mkr Point > 13 > Enter**.

3. Set the last marker point in the range that you want off to a value less than or equal to the number of points in the waveform, and greater than or equal to the value set in **Step 2** (for this example, 17):

Press **Last Mkr Point** > **17** > **Enter** > **Apply To Waveform** > **Return**.

This turns off all marker points for the active marker within the range set in **Steps 2 and 3**, as shown at right.

How to view markers is described on **page 227**.



### Clearing a Single Marker Point

Use the steps described in **“Clearing a Range of Marker Points”** on **page 227**, but set both the first and last marker point to the value of the point you want to clear. For example, if you want to clear a marker on point 5, set both the first and last value to 5.

### Setting Marker Points in a Waveform Segment

To set marker points on a segment, the segment must reside in BBG media (**page 207**).

When you set marker points, they do not replace points that already exist, but are set **in addition** to existing points. Because markers are cumulative, before you set marker points within a segment, view the segment (**page 227**) and remove any unwanted points (**page 227**).

### Placing a Marker Across a Range of Points

1. In the second Arb menu (**page 226**), press **Marker Utilities** > **Set Markers**.

2. Highlight the desired waveform segment.

3. Select the desired marker number: Press **Marker 1 2 3 4**

4. Set the first sample point in the range (in this example, 10):

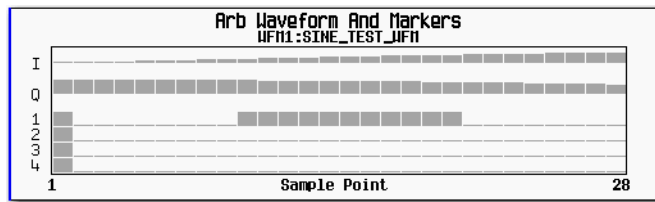
Press **Set Marker On Range Of Points** > **First Mkr Point** > **10** > **Enter**.

5. Set the last marker point in the range to a value less than or equal to the number of points in the waveform, and greater than or equal to the first marker point (in this example, 20):

Press **Last Mkr Point** > **20** > **Enter**.

6. Press **Apply To Waveform** > **Return**.

This sets a range of waveform marker points. The marker signal starts on sample point 10, and ends on sample point 20, as shown in the following figure.



How to view markers is described on [page 227](#)

## Placing a Marker on a Single Point

### On the First Point

1. In the second Arb menu ([page 226](#)), press **Marker Utilities > Set Markers**.
2. Highlight the desired waveform segment.
3. Select the desired marker number:  
Press **Marker 1 2 3 4**.
4. Press **Set Marker On First Point**.

This sets a marker on the first point in the segment for the marker number selected in [Step 3](#).

### On Any Point

Use the steps described in [“Placing a Marker Across a Range of Points” on page 228](#), but set both the first and last marker point to the value of the point you want to set. For example, if you want to set a marker on point 5, set both the first and last value to 5.

## Placing Repetitively Spaced Markers

The following example sets markers across a range of points and specifies the spacing (skipped points) between each marker. You must set the spacing **before** you apply the marker settings; you cannot apply skipped points to a previously set range of points.

### NOTE

The skipped points value is limited to the size of the range of points.

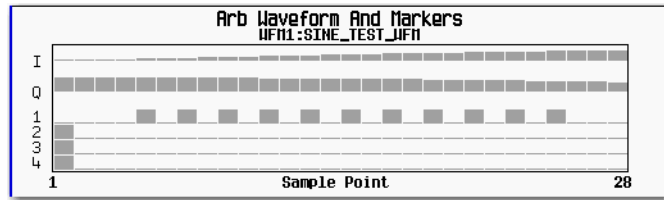
1. Remove any existing marker points ([page 222](#)).
2. In the second Arb menu ([page 226](#)), press **Marker Utilities > Set Markers**.
3. Highlight the desired waveform segment.
4. Select the desired marker number:  
Press **Marker 1 2 3 4**.
5. Set the first sample point in the range (in this example, 5):  
Press **Set Marker On Range Of Points > First Mkr Point > 5 > Enter**.
6. Set the last marker point in the range. (The last marker point value must always be less than or equal to the number of points in the waveform, **and** greater than or equal to the first marker point, in this example, 25):  
Press **Last Mkr Point > 25 > Enter**.

7. Enter the number of sample points that you want skipped (in this example, 1):  
Press # **Skipped Points** > **1** > **Enter**.

8. Press **Apply To Waveform** > **Return**.

This causes the marker to occur on every other point (one sample point is skipped) within the marker point range, as shown at right.

How to view markers is described on [page 227](#).

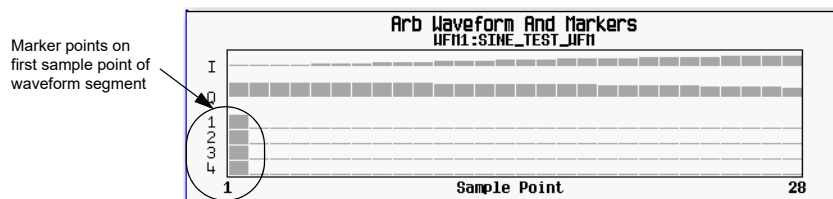


One application of the skipped point feature is the creation of a clock signal as the EVENT output.

### Viewing a Marker Pulse

When a waveform plays ([page 213](#)), you can detect a set and enabled marker's pulse at the rear panel event connector/Aux I/O pin that corresponds to that marker number. This example demonstrates how to view a marker pulse generated by a waveform segment that has at least one marker point set ([page 228](#)). The process is the same for a waveform sequence.

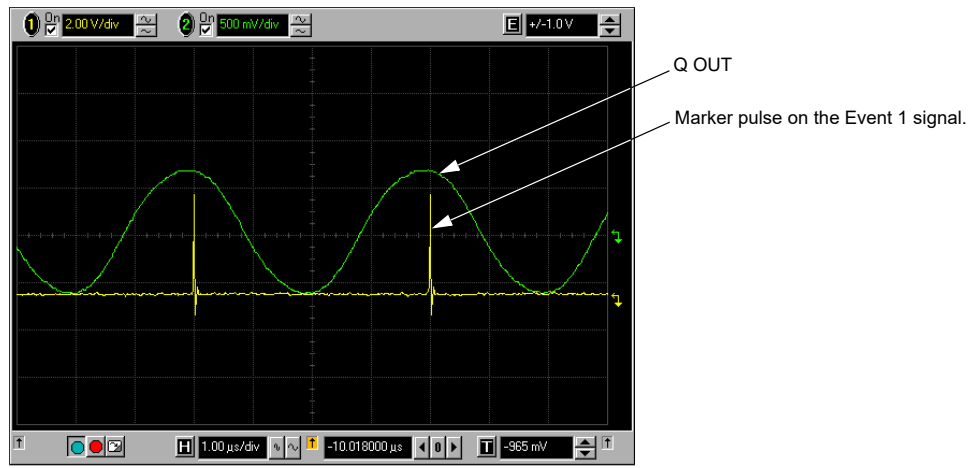
This example uses the factory-supplied segment, `SINE_TEST_WFM` in the dual ARB Player. Factory-supplied segments have a marker point on the first sample point for all four markers, as shown.



How to view markers is described on [page 227](#)

1. In the first Arb menu ([page 206](#)), press **Select Waveform**.
2. Highlight the `SINE_TEST_WFM` segment and press **Select Waveform**.
3. Press **ARB Off On** to On.
4. Connect the signal generator's rear panel `Q OUT` output to the oscilloscope's channel 1 input.
5. Connect the signal generator's rear panel `EVENT 1` output to the oscilloscope's channel 2 input.

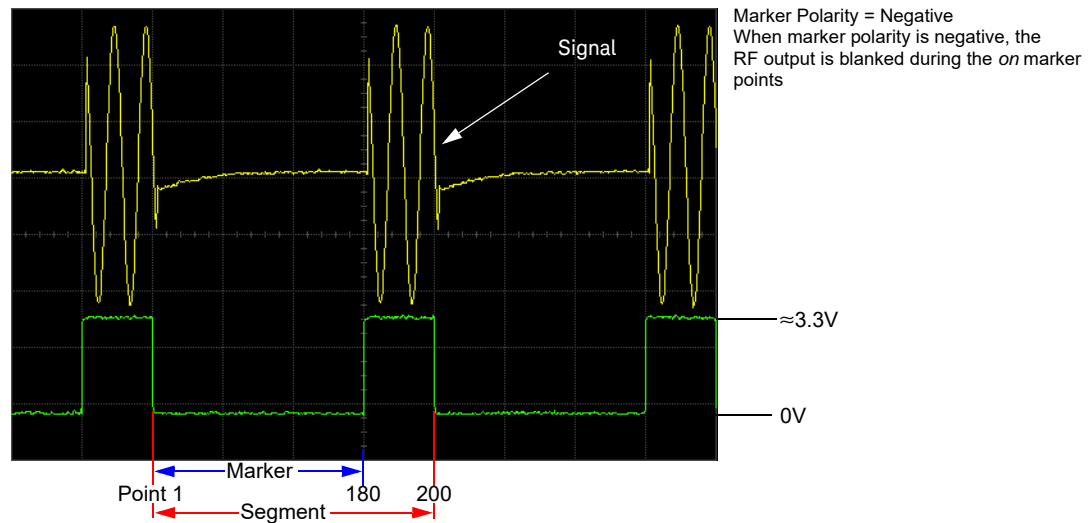
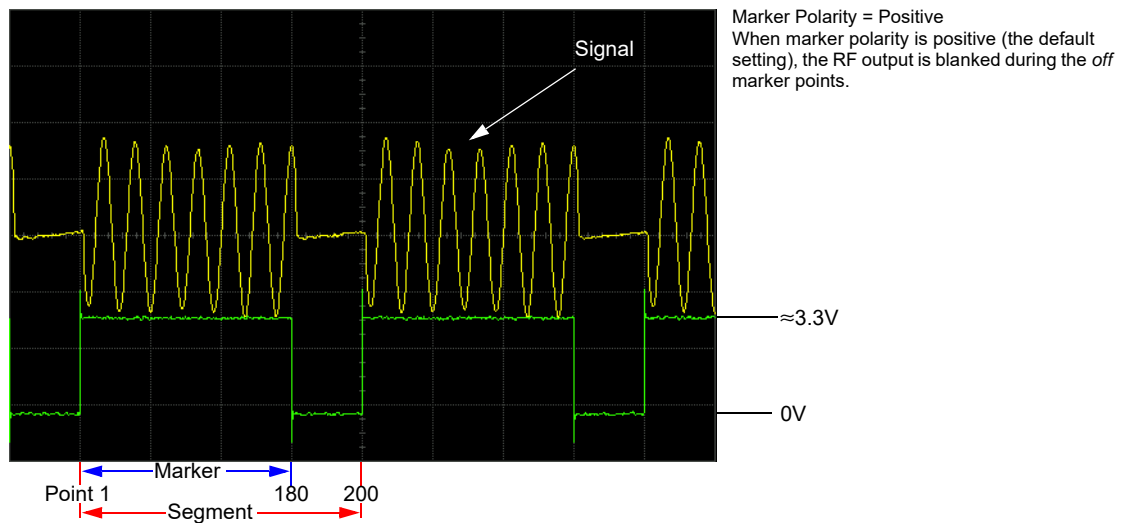
When marker 1 is present, the Keysight MXG/EXG outputs a signal through `EVENT 1` as shown in the following example.



## Using the RF Blanking Marker Function

While you can set a marker function (described as **Marker Routing** on the softkey label in the Marker Utilities menu) either before or after setting the marker points (page 228), setting a marker function before you set marker points may change the RF output. RF Blanking includes ALC hold (described on page 223, note **Caution** regarding unlevelled power). The signal generator blanks the RF output when the marker signal goes low. This example is a continuation of the previous example, Viewing a Marker Pulse.

1. Using the factory-supplied segment `SINE_TEST_WFM`, set Marker 1 across points 1–180 (page 228).
2. From the **Marker Routing** softkey menu, assign RF Blanking to Marker 1:  
In the second Arb menu (page 226), press **Marker Utilities** > **Marker Routing** > **Pulse/RF Blank** > **Marker 1**.





## Setting Marker Polarity

Setting a negative marker polarity inverts the marker signal.

1. In second Arb menu ([page 226](#)), press **Marker Utilities** > **Marker Polarity**.
2. For each marker, set the marker polarity as desired.
  - The default marker polarity is positive.
  - Each marker polarity is set independently.

See also, [“Saving Marker Polarity and Routing Settings” on page 222](#).

As shown on [page 232](#):

Positive Polarity: **On** marker points are high ( $\approx 3.3V$ ).

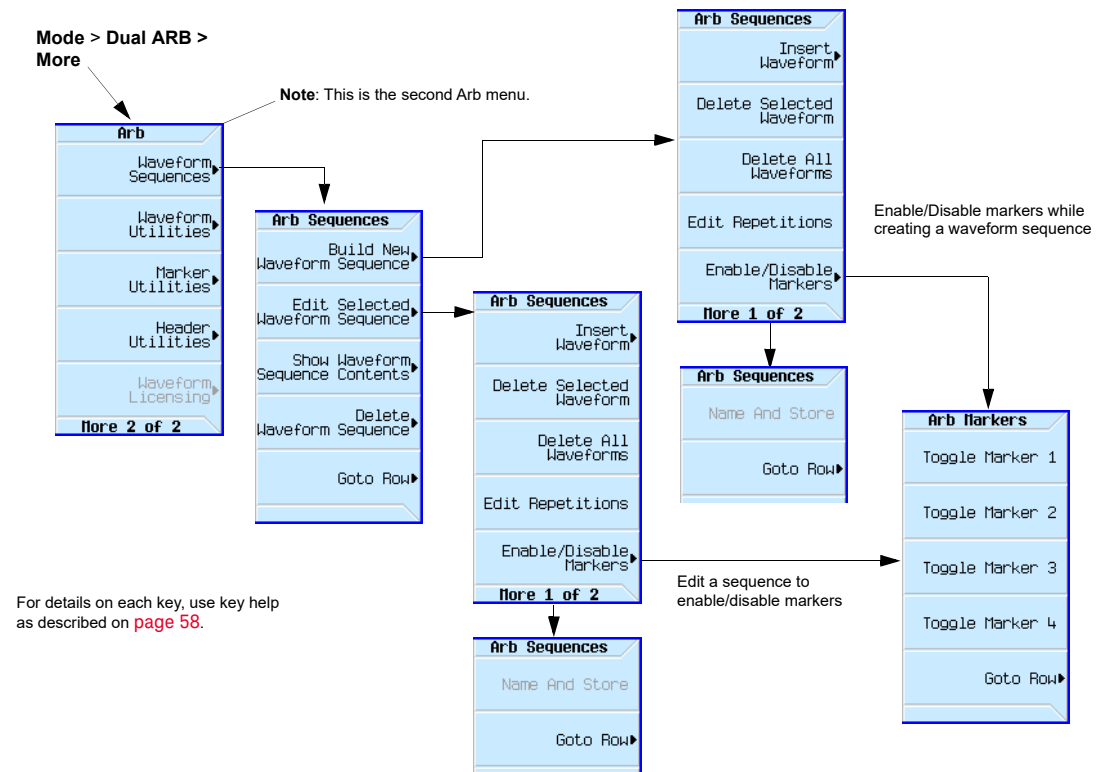
Negative Polarity: **On** marker points are low (0V).

RF blanking always occurs on the low part of the signal regardless of the polarity setting.

## Controlling Markers in a Waveform Sequence

In a waveform segment, an enabled marker point generates an auxiliary output signal that is routed to the rear panel EVENT output (described in [“Rear Panel Overview \(N5171B, N5172B, N5181B, & N5182B\)” on page 28](#)) corresponding to that marker number. For a waveform sequence, you enable or disable markers on a segment-by-segment basis; this enables you to output markers for some segments in a sequence, but not for others. Unless you change the sequence marker settings or cycle the power, the marker setting for the last segment edited in the sequence applies to all segments in the next sequence that you build. For information on building a waveform sequence, see [“Creating a Sequence” on page 210](#).

Figure 9-6 Waveform Sequence Menus for Enabling/Disabling Segment Markers



## Enabling and Disabling Markers in a Waveform Sequence

Select the waveform segments within a waveform sequence to enable or disable each segment's markers independently. You can enable or disable the markers either at the time of creating the sequence or after the sequence has been created and stored. If the sequence has already been stored, you must store the sequence again after making any changes. Enabling a marker that has no marker points has no effect on the auxiliary outputs. To set marker points on a segment, see **“Setting Marker Points in a Waveform Segment” on page 228**. This example assumes that a waveform sequence exists.

1. Ensure that all waveform segments for the sequence reside in BBG media (see [page 207](#)).
2. From the second Arb menu, press **Waveform Sequences**.
3. Highlight the desired waveform sequence.
4. Press **Edit Selected Waveform Sequence > Enable/Disable Markers**.
5. Toggle the markers:
  - a. Highlight the first waveform segment.
  - b. As desired, press **Toggle Marker 1**, **Toggle Marker 2**, **Toggle Marker 3**, and **Toggle Marker 4**.  
  
An entry in the **Mkr** column (see figure below) indicates that the marker is enabled for that segment; no entry in the column means that all markers are disabled for that segment.
  - c. In turn, highlight each of the remaining segments and repeat **Step b**.
6. Press **Return > More > Name and Store**.
7. Either rename the sequence using the text entry keys (see [page 208](#)) or just press **Enter** to save the sequence with the existing name.

The markers are enabled or disabled per the selections, and the changes saved to the sequence file.

The following figure shows a sequence built using one of the factory-supplied waveform segments; a factory-supplied segment has a marker point on the first sample for all four markers. In this example, marker 1 is enabled for the first segment, marker 2 is enable for the second segment, and markers 3 and 4 are enabled for the third segment.

Segment On Pg 1/1	BBG Media	Sequence On Int Media	(UNSTORED) Pg 1/1	Waveform	SINE+RAMP Reps	Mkr	Toggle Marker 3
RAMP_TEST_WFM		ANTENNA2M		WFM1:SINE_TEST_WFM	1	1	
SINE_TEST_WFM		SINE+RAMP		WFM1:SINE_TEST_WFM	1	2	
		SINE100+RAMP200		WFM1:SINE_TEST_WFM	1	3,4	

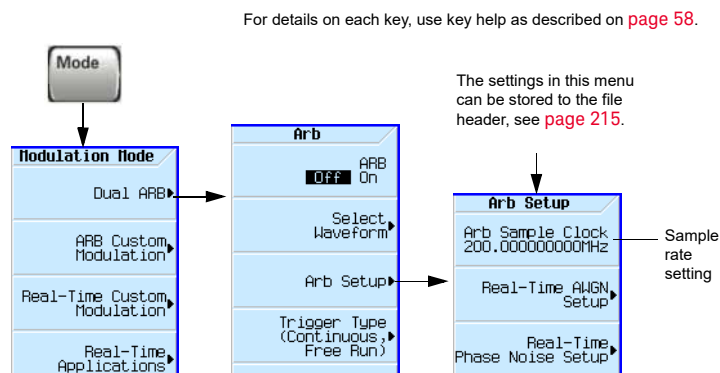
Sequence marker column

This entry shows that markers 3 and 4 are enabled for this segment.

For each segment, only the markers enabled for that segment produce a rear panel auxiliary output signal. In this example, the marker 1 auxiliary signal appears only for the first segment, because it is disabled for the remaining segments. The marker 2 auxiliary signal appears only for the second segment, and the marker 3 and 4 auxiliary signals appear only for the third segment.

## Using the EVENT Output Signal as an Instrument Trigger

One of the uses for the EVENT output signal (marker signal) is to trigger a measurement instrument. You can set up the markers to start the measurement at the beginning of the waveform, at any single point in the waveform, or on multiple points in the waveform. To optimize the use of the EVENT signal for measurements, you may also need to adjust the sample rate. The location of the sample rate setting is shown in the figure at right.



The EVENT output signal can exhibit jitter of up to  $\pm 4$  ns on the rising and falling edge. This jitter can be minimized in either of two ways.

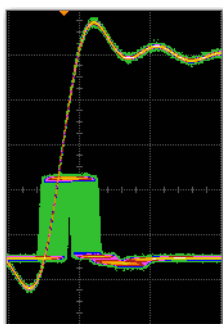
**Method 1:** Use a sample clock of  $125 \text{ MHz}/N$  where  $N$  is a positive integer and where  $125 \text{ MHz}/N$  can be represented exactly on the display. For example: 125 MHz, 62.5 MHz, 31.25 MHz, 25 MHz, and so on.

If the result cannot be represented exactly on the display, jitter will be present. For example:  $N = 6$  will result in jitter, because  $125 \text{ MHz}/6 = 20.833 \text{ Mhz}$ , which is truncated when displayed.

**Method 2:** Select a sample clock and waveform length that spaces the markers by a multiple of 8 ns. For example: A 200 point waveform with a marker on the first point and a sample clock of 50 MHz provides a marker every  $4 \mu\text{s}$ . Because  $4 \mu\text{s}$  is a multiple of 8 ns, the jitter is minimized.

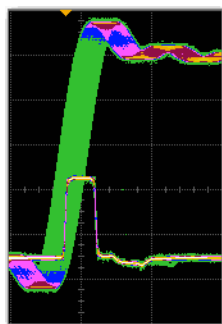
When the EVENT output signal exhibits jitter and it is used as a measurement trigger, it can cause the waveform to falsely appear as having jitter. If this condition occurs, you can adjust the sample rate to a value (see above) that does not cause the jitter appearance. To maintain the integrity of the original waveform with a sample rate change, you will have to also recalculate the sample values. The following figures illustrate the marker signal jitter and its affect on the waveform.

EVENT output signal exhibits jitter due to a non-optimal sample rate



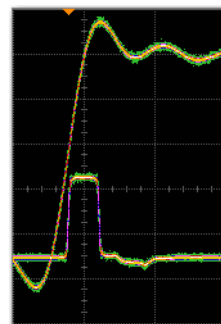
Oscilloscope triggering on waveform

Waveform appears to exhibit jitter when triggered using EVENT signal with jitter.



Oscilloscope triggering on EVENT signal

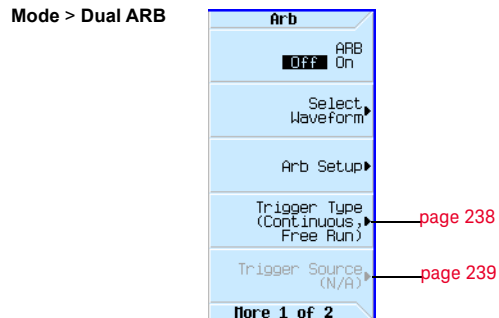
The jitter is gone with an optimal sample rate



Oscilloscope triggering on EVENT signal

## Triggering a Waveform

Figure 9-7 Triggering Softkeys



For details on each key, use key help as described on [page 58](#).

Triggers control data transmission by controlling when the signal generator transmits the modulating signal. You can configure trigger settings so that data transmission occurs once (Single mode), continuously (Continuous mode), or starts and stops repeatedly (Gated and Segment Advance modes).

A trigger signal contains both positive and negative states; you can use either for triggering.

When you initially select a trigger mode or when you change from one triggering mode to another, you may lose the carrier signal at the RF output until the modulating signal is triggered. This is because the signal generator sets the I and Q signals to zero volts prior to the first trigger event. To maintain the carrier signal at the RF output, create a data pattern with the initial I and Q voltages set to values other than zero.

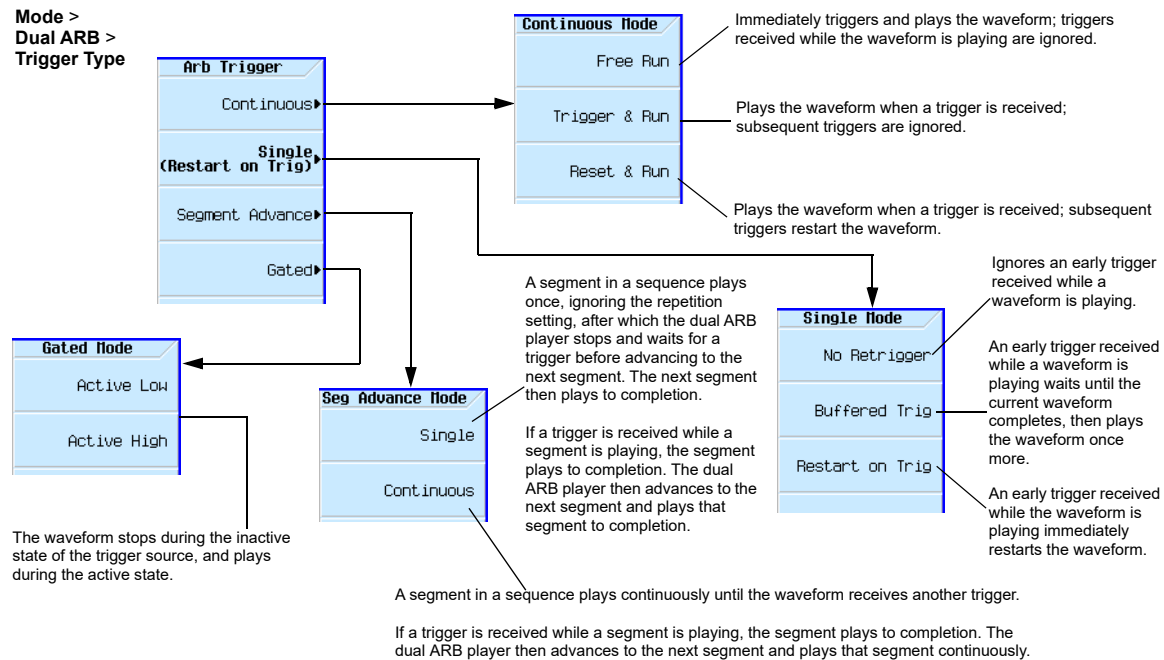
When you initially turn the Arb ON or select a trigger mode or when you change from one triggering mode to another, you may temporarily lose the carrier signal for a few tens of milliseconds at the RF output. The Arb will present the idle IQrms value of the next Arb waveform to the IQ modulator. This ensures that the RF carrier output is at the correct amplitude level while the Arb waits for a trigger. When that trigger is received, the Arb begins playing the waveform and the modulated RF carrier exhibits no undesirable transients.

There are two parts to configuring a waveform trigger:

- **Type** determines the behavior of the waveform when it plays (see [Trigger Type](#) on page 238).
- **Source** determines how the signal generator receives the trigger that starts the modulating waveform playing (see [Trigger Source](#) on page 239).

## Trigger Type

Type defines the trigger mode: how the waveform plays when triggered.



For details on each key, use key help as described on [page 58](#).

### NOTE

The example above shows Dual ARB Mode, but trigger functionality is similar for other modulation modes. Available trigger types vary depending on the modulation mode selected.

- **Continuous** mode repeats the waveform until you turn the signal off or select a different waveform, trigger mode, or response (Free Run, Trigger & Run, Reset & Run).
- **Single** mode plays the waveform once.

### NOTE

In **Single No Retrigger**, do not use **Continuous Reset & Run** mode due to the variable latency of this setup.

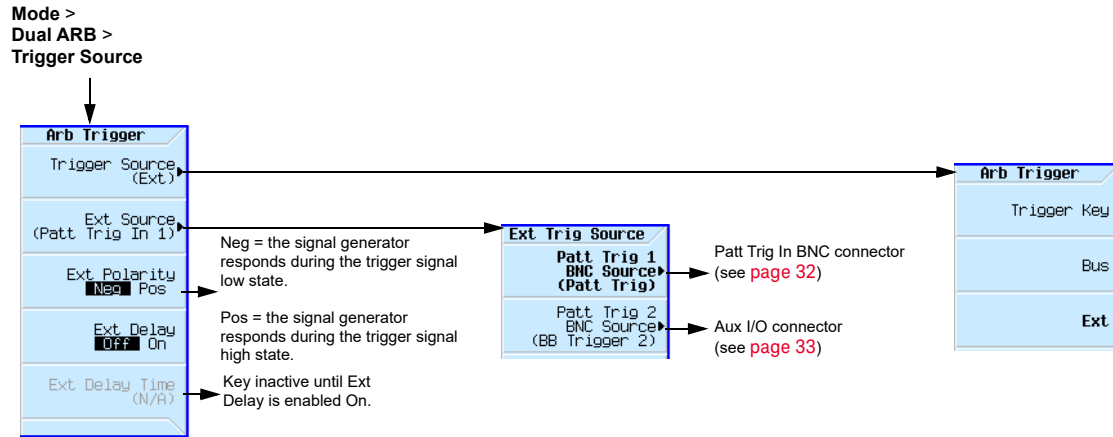
**No Retrigger:** If a trigger is received early it will be ignored. The gap in your playback is dependent on the trigger period, after which time the RF will start up again where it is expected.

**Buffered Trigger:** An early trigger will cause the waveform to play to the end and then start again. The RF will not be aligned with this early trigger.

**Restart on Trigger:** The ARB will reset itself and trigger again but there will some gap in the playback while this is occurring. It will reset itself for every trigger it receives.

- **Segment Advance** mode plays a segment in a sequence only if triggered. The **trigger source** controls segment-to-segment playing (see **Example: Segment Advance Triggering** on page 240). A trigger received during the last segment loops play to the **first** segment in the sequence.
- **Gated** mode triggers the waveform at the first active triggering state, then repeatedly starts and stops playing the waveform in response to an externally applied gating signal. See **Example: Gated Triggering** on page 241.

## Trigger Source



For details on each key, use key help as described on page 58.

## External Trigger Polarity

- In Continuous, Single, and Segment Advance modes, use the **Ext Polarity** softkey to set the external trigger polarity.
- In Gated mode, the **Active Low** and **Active High** softkeys (page 238) determine the external trigger polarity.

## Example: Segment Advance Triggering

Segment advance triggering enables you to control the segment playback within a waveform sequence. This type of triggering ignores the repetition value ([page 212](#)). For example if a segment has repetition value of 50 and you select **Single** as the segment advance triggering mode, the segment still plays only once. The following example uses a waveform sequence that has two segments.

If you have not created and stored a waveform sequence, refer to [“Creating a Sequence” on page 210](#).

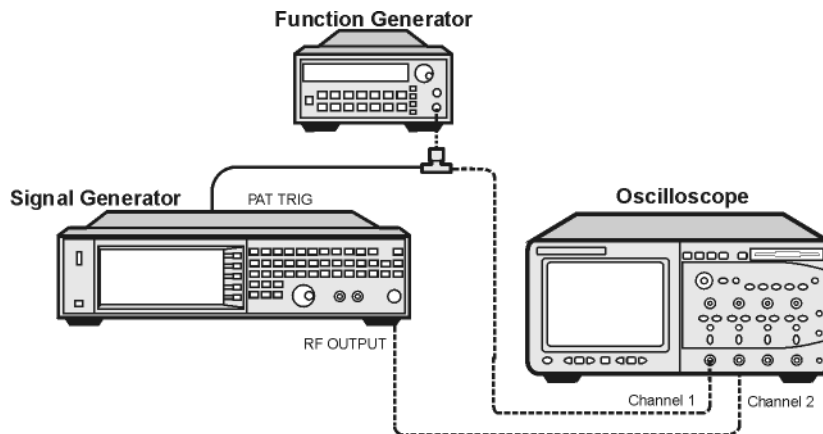
1. Preset the signal generator.
2. Configure the RF output:
  - Set the desired frequency.
  - Set the desired amplitude.
  - Turn on the RF output.
3. Select a waveform sequence for playback:
  - a. Press **Mode** > **Dual ARB** > **Select Waveform**.
  - b. In the *Sequence On* column, highlight a waveform sequence file.
  - c. Press **Select Waveform**.
4. Set the triggering as follows:
  - Trigger Type: continuous Segment Advance  
Press **Trigger Type** > **Segment Advance** > **Continuous**.
  - Trigger source: Trigger hardkey  
Press **Trigger Source** > **Trigger Key**.
5. Generate the waveform sequence:  
Press **ARB Off On** until On highlights.
6. (Optional) Monitor the waveform:  
Connect the RF OUTPUT of the signal generator to the input of an oscilloscope, and configure the oscilloscope so that you can see the signal.
7. Trigger the first waveform segment to begin playing continuously:  
Press the **Trigger** hardkey.
8. Trigger the second segment:  
Press the **Trigger** hardkey.  
  
Pressing the **Trigger** hardkey causes the currently playing segment to finish and the next segment to start.  
  
If the last segment in the sequence is playing, pressing the **Trigger** hardkey causes the **first** segment in the waveform sequence to start when the last segment finishes.



## Example: Gated Triggering

Gated triggering enables you to define the on and off states of a modulating waveform.

1. Connect the output of a function generator to the signal generator's rear panel PAT TRIG IN connector, as shown in the following figure. This connection is applicable to all external triggering methods. The optional oscilloscope connection enables you to see the effect that the trigger signal has on the RF output.

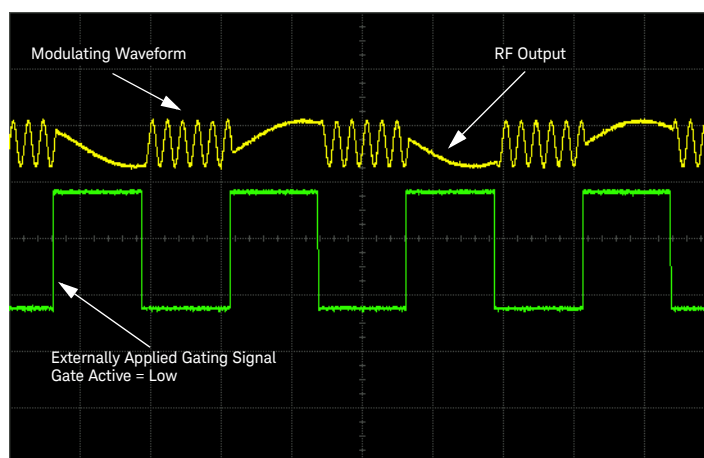


2. Preset the signal generator.
3. Configure the RF output:
  - Set the desired frequency.
  - Set the desired amplitude.
  - Turn on the RF output.
4. Select a waveform for playback (sequence or segment):
  - a. Press **Mode** > **Dual ARB** > **Select Waveform**.
  - b. In the Segment On or Sequence On column, highlight a waveform.
  - c. Press **Select Waveform**.
5. Set the triggering as follows:
  - Trigger type: Gated  
Press **Trigger Type** > **Gated**.
  - Active state: Low  
Press **Active Low**.
  - Trigger source: External  
Press **Trigger Source** > **Ext**.
  - Input connector: Rear panel Patt Trig In BNC  
Press **Ext Source** > **Patt Trig In 1**.
6. Generate the waveform: Press **Return** > **ARB Off On** until On highlights.
7. On the function generator, configure a TTL signal for the external gating trigger.

**8. (Optional) Monitor the waveform:**

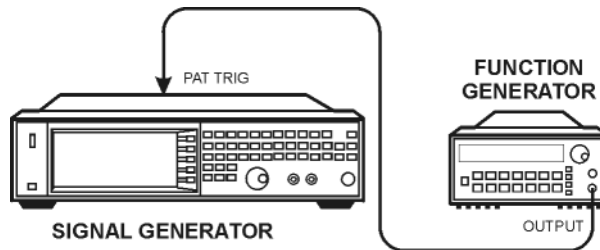
Configure the oscilloscope to display both the output of the signal generator, and the external triggering signal. You will see the waveform modulating the output during the gate **active** periods (low in this example).

The following figure shows an example display.



## Example: External Triggering

Use the following example to set the signal generator to output a modulated RF signal 100 milliseconds after a change in TTL state from low to high occurs at the PATT TRIG IN rear panel BNC connector



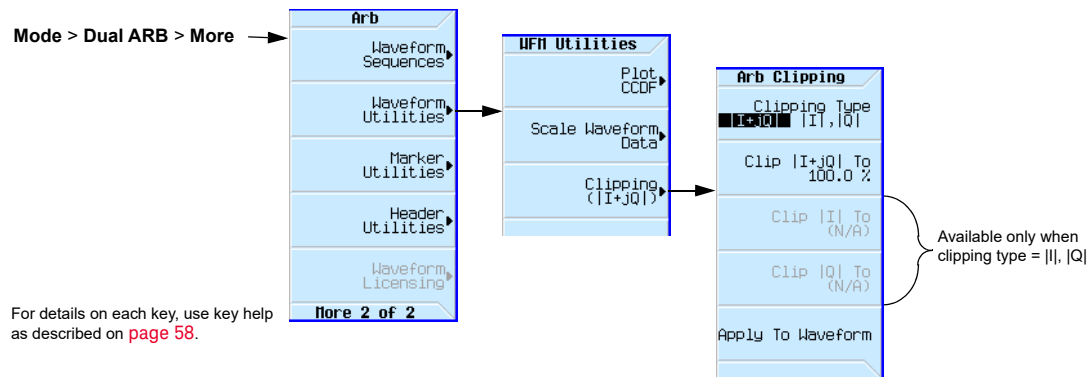
1. Connect the signal generator to the function generator as shown above.
2. Configure the RF output:
  - Set the desired frequency.
  - Set the desired amplitude.
  - Turn on the RF output.
3. Select a waveform for playback (sequence or segment):
  - a. Press **Mode** > **Dual ARB** > **Select Waveform**.
  - b. In the **Segment On** or **Sequence On** column, highlight a waveform.
  - c. Press **Select Waveform**.
4. Generate the waveform:  
Press **ARB Off On** until **On** highlights.
5. Set the waveform trigger as follows:
  - a. Trigger Type: single  
Press **Trigger Type** > **Single** > **No Retrigger**
  - b. Trigger Source: external  
Press **Trigger Source** > **Ext**
  - c. Input connector: Rear panel Patt Trig In BNC  
Press **Ext Source** > **Patt Trig In 1**.
  - d. External Trigger Polarity: positive  
Press **Ext Polarity** until **Pos** highlights
  - e. External Delay: 100 ms  
Press **More** > **Ext Delay** until **On** highlights  
Press **Ext Delay Time** > **100** > **msec**
6. Configure the Function Generator:
  - Waveform: 0.1 Hz square wave
  - Output Level: 3.5V to 5V.

## Clipping a Waveform

Digitally modulated signals with high power peaks can cause intermodulation distortion, resulting in spectral regrowth that can interfere with signals in adjacent frequency bands. The clipping function enables you to reduce high power peaks by clipping the I and Q data to a selected percentage of its highest peak, thereby reducing spectral regrowth.

- [How Power Peaks Develop](#) on page 245
- [How Peaks Cause Spectral Regrowth](#) on page 247
- [How Clipping Reduces Peak-to-Average Power](#) on page 248
- [Configuring Circular Clipping](#) on page 251
- [Configuring Rectangular Clipping](#) on page 252

Figure 9-8 Clipping Softkeys



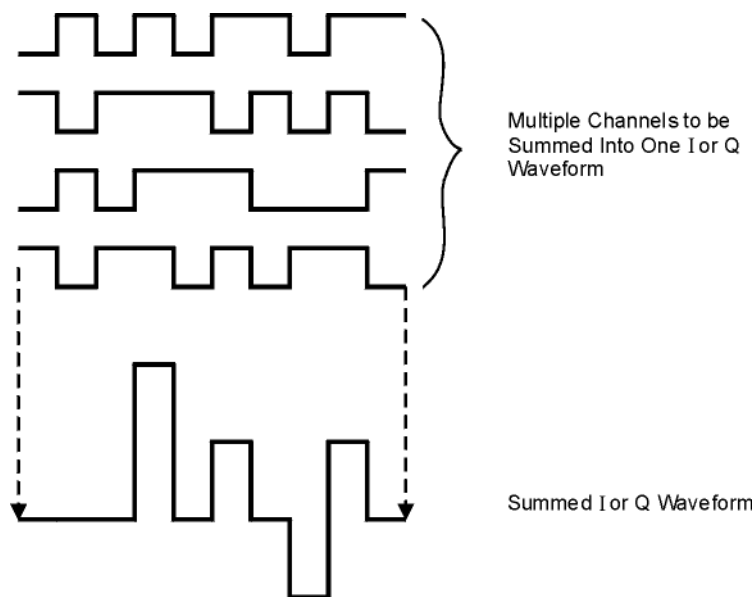
## How Power Peaks Develop

To see how clipping reduces high power peaks, it is important to understand how the peaks develop as you construct a signal.

### Multiple Channel Summing

I/Q waveforms can be the summation of multiple channels, as shown in the following figure. If a bit in the same state (high or low) occurs simultaneously in several individual channel waveforms, an unusually high power peak (positive or negative) occurs in the summed waveform.

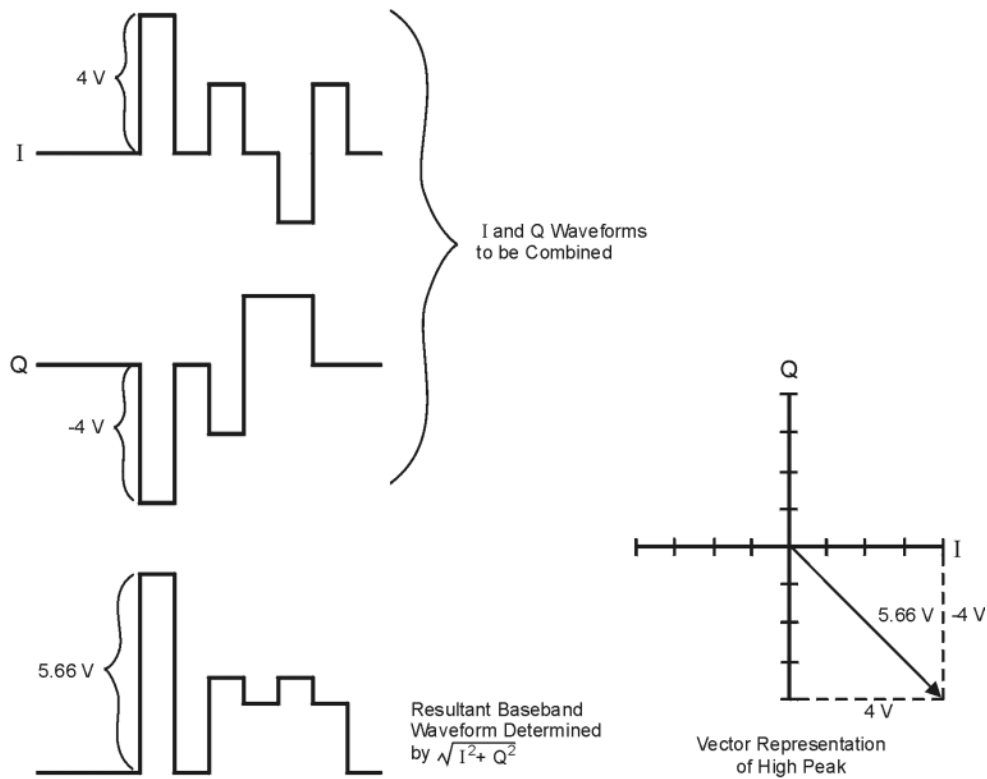
Because the high and low states of the bits in channel waveforms are random and generally result in a canceling effect, high power peaks occur infrequently with multiple channel summing.



### Combining the I and Q Waveforms

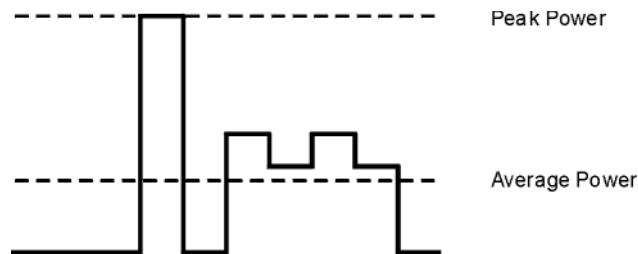
When the I and Q waveforms combine in the I/Q modulator to create an RF waveform, the magnitude of the RF envelope is  $\sqrt{I^2+Q^2}$ , where the squaring of I and Q always results in a positive value.

As shown in the following figure, simultaneous positive and negative peaks in the I and Q waveforms do not cancel each other, but combine to create an even greater peak.

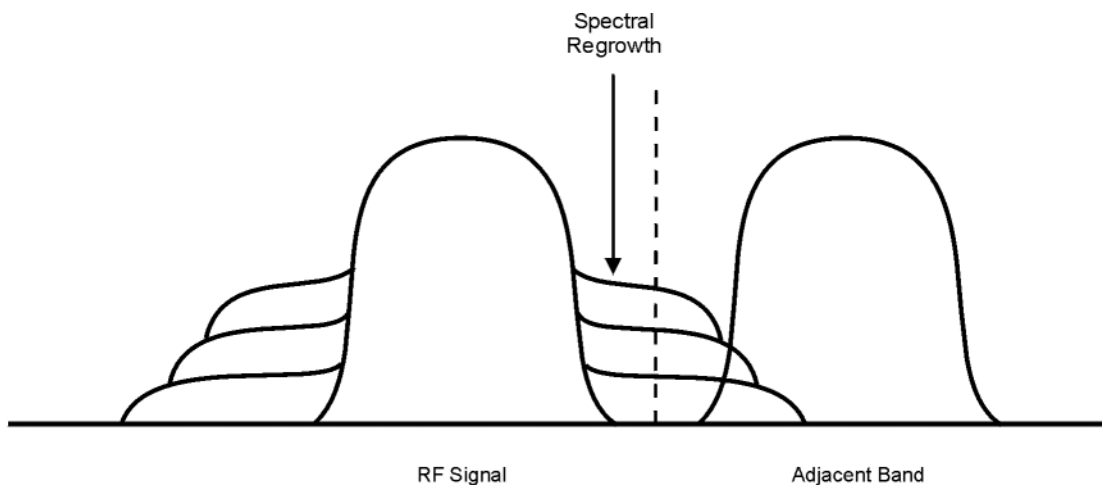


## How Peaks Cause Spectral Regrowth

In a waveform, high power peaks that occur infrequently cause the waveform to have a high peak-to-average power ratio, as illustrated in the following figure.



Because the gain of a transmitter's power amplifier is set to provide a specific average power, high peaks can cause the power amplifier to move toward saturation. This causes the intermodulation distortion that generates spectral regrowth. Spectral regrowth is a range of frequencies that develops on each side of the carrier (similar to sidebands) and extends into the adjacent frequency bands (see the following figure). Clipping provides a solution to this problem by reducing the peak-to-average power ratio.



## How Clipping Reduces Peak-to-Average Power

You can reduce peak-to-average power, and consequently spectral regrowth, by clipping the waveform. Clipping limits waveform power peaks by clipping the I and Q data to a selected percentage of its highest peak. The Signal Generator provides two methods of clipping:

- **Circular** clipping is applied to the composite I/Q data (I and Q data are equally clipped).

As shown in **Figure 9-9**, the clipping level is constant for all phases of the vector and appears as a circle in the vector representation.

- **Rectangular** clipping is independently applied the I and Q data.

As shown in **Figure 9-10 on page 249**, the clipping level is different for I and Q, and appears as a rectangle in the vector representation.

In both circular and rectangular clipping, the objective is to clip the waveform to a level that reduces spectral regrowth but does **not** compromise the integrity of the signal. The two complementary cumulative distribution plots in **Figure 9-11 on page 250** show the reduction in peak-to-average power that occurs after applying circular clipping to a waveform.

The lower the clipping value, the lower the peak power that is passed (the more the signal is clipped). The peaks can often be clipped without substantially interfering with the rest of the waveform. In many cases, data that might otherwise be lost in the clipping process is retained because of the error correction inherent in the coded systems. If you apply excessive clipping, however, lost data cannot be recovered. Experiment with clipping settings to find a percentage that reduces spectral regrowth while retaining needed data.

**Figure 9-9** Circular Clipping

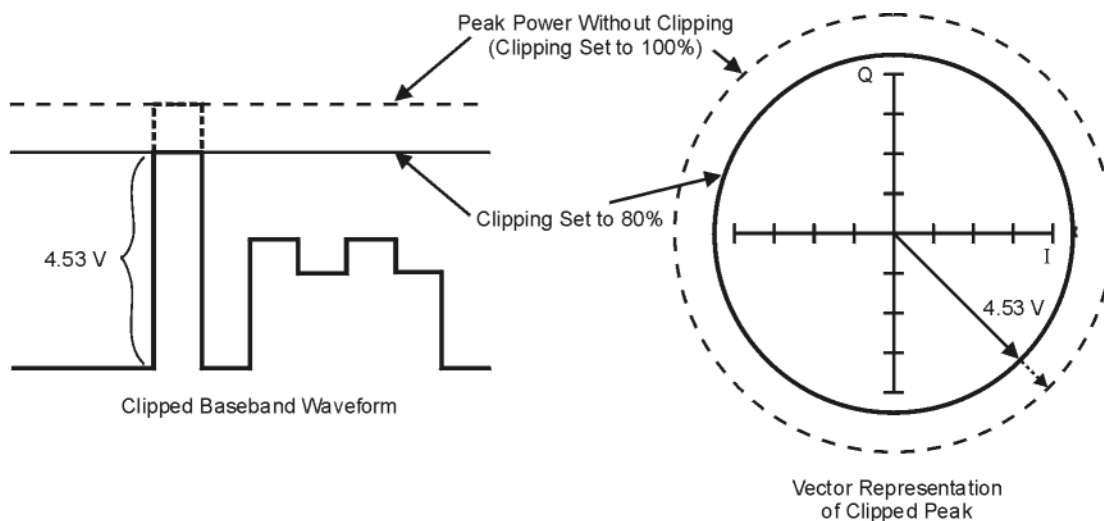
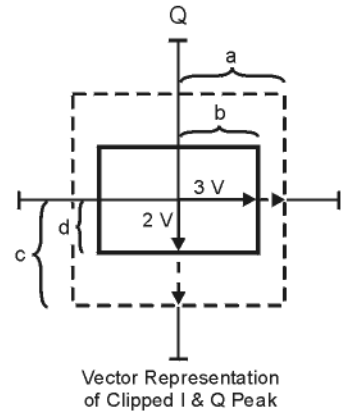
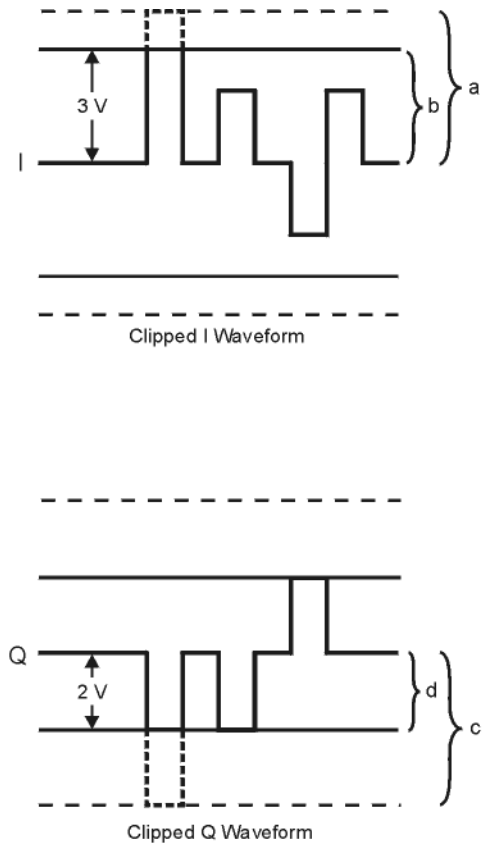




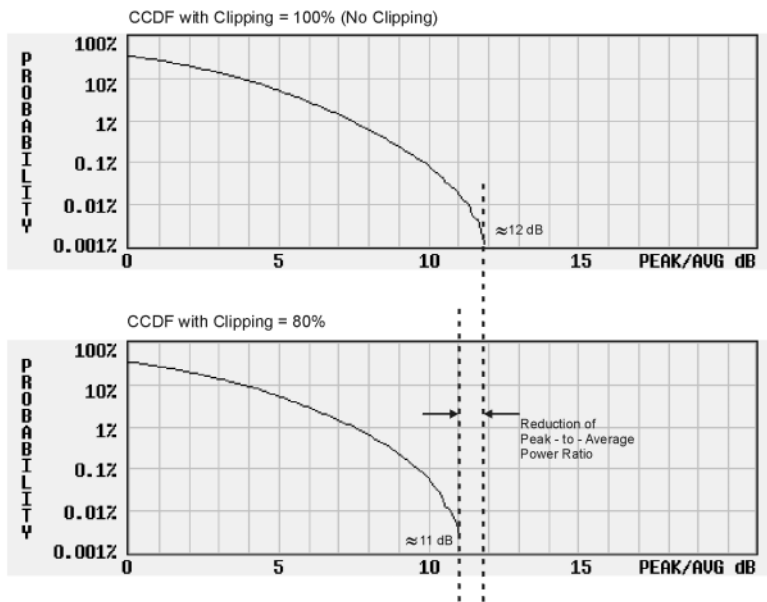
Figure 9-10 Rectangular Clipping



- a) |I| Clipping Set to 100% (No Clipping)
- b) |I| Clipping Set to 75% of Greatest Peak
- c) |Q| Clipping Set to 100% (No Clipping)
- d) |Q| Clipping Set to 50% of Greatest Peak

Figure 9-11 Reduction of Peak-to-Average Power

Complementary Cumulative Distribution



## Configuring Circular Clipping

Use this example to configure circular clipping and observe its affect on the peak-to-average power ratio of a waveform. Circular clipping clips the composite I/Q data (I and Q data are clipped equally). For more information about circular clipping, refer to **“How Clipping Reduces Peak-to-Average Power”** on page 248.

### CAUTION

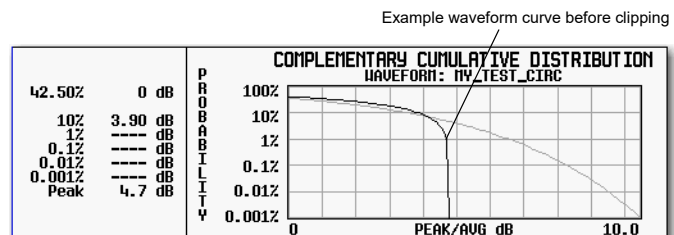
Clipping is non-reversible and cumulative. Save a copy of the waveform file before you apply clipping.

### Copy a Waveform File

1. Display the signal generator's files: Press **File** > **Catalog Type** > **More** > **Volatile Segments**.
2. Highlight the waveform RAMP\_TEST\_WFM.
3. Press **Copy File**.
4. Name the copy (in this example, the name is MY\_TEST\_CIRC) and press **Enter**.

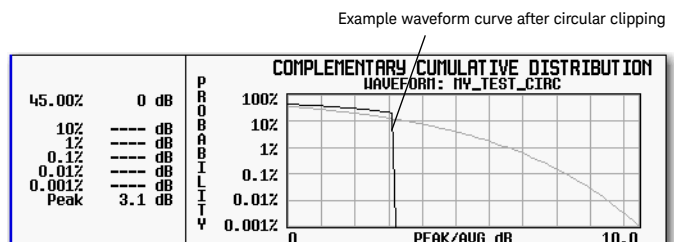
### Apply Circular Clipping to the Copied Waveform File

1. Open the DUAL ARB Waveform Utilities menu: Press **Mode** > **Dual ARB** > **More** > **Waveform Utilities**.
2. In the list of files, highlight the copied file (in this example, MY\_TEST\_CIRC).
3. Create the CCDF plot: Press **Plot CCDF**.
4. Observe the shape and position of the waveform's curve (the dark line in the example at right).
5. Activate circular clipping: Press **Return** > **Clipping** > **Clipping Type** until **|I+jQ|** highlights.
6. Set circular clipping to 80%:  
Press **Clip |I+jQ| To** > **80** > **%**.
7. Apply 80% clipping to the I and Q data: Press **Apply to Waveform**.



8. Create the CCDF plot (see the example at right): Press **Plot CCDF**.
9. Observe the waveform's curve after clipping.

Note the reduction in peak-to-average power relative to the previous plot.



## Configuring Rectangular Clipping

Use this example to configure rectangular clipping. Rectangular clipping clips the I and Q data independently. For more information about rectangular clipping, refer to [“How Clipping Reduces Peak-to-Average Power”](#) on page 248.

### CAUTION

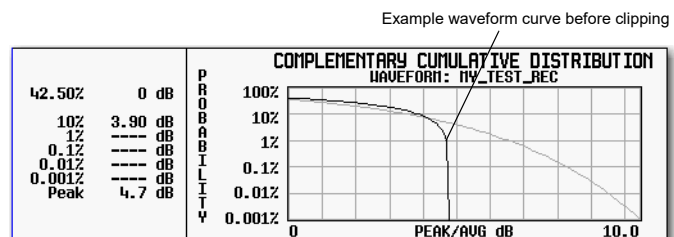
Clipping is non-reversible and cumulative. Save a copy of the waveform file before you apply clipping.

### Copy a Waveform File

1. Display the signal generator's files: Press **File** > **Catalog Type** > **More** > **Volatile Segments**.
2. Highlight the waveform `RAMP_TEST_WFM`.
3. Press **Copy File**.
4. Name the copy (in this example, the name is `MY_TEST_REC`) and press **Enter**.

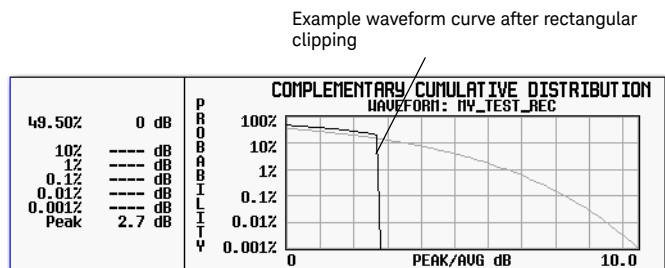
### Apply Rectangular Clipping to the Copied Waveform File

1. Open the DUAL ARB Waveform Utilities menu: Press **Mode** > **Dual ARB** > **More** > **Waveform Utilities**.
2. In the list of files, highlight the copied file (in this example, `MY_TEST_REC`).
3. Create the CCDF plot: Press **Plot CCDF**.
4. Observe the shape and position of the waveform's curve (the dark line in the example at right).
5. Activate rectangular clipping: Press **Return** > **Clipping** > **Clipping Type** until `||I||,|Q|` highlights.
6. Set 80% clipping for the I data: Press **Clip ||I|| To** > **80** > **%**.
7. Set 40% clipping for the Q data: Press **Clip |Q| To** > **40** > **%**.
8. Apply the rectangular clipping to the waveform: Press **Apply to Waveform**.
9. Create the CCDF plot (see the example at right): Press **Plot CCDF**.



10. Observe the waveform's curve after clipping.

Note the reduction in peak-to-average power relative to the previous plot.

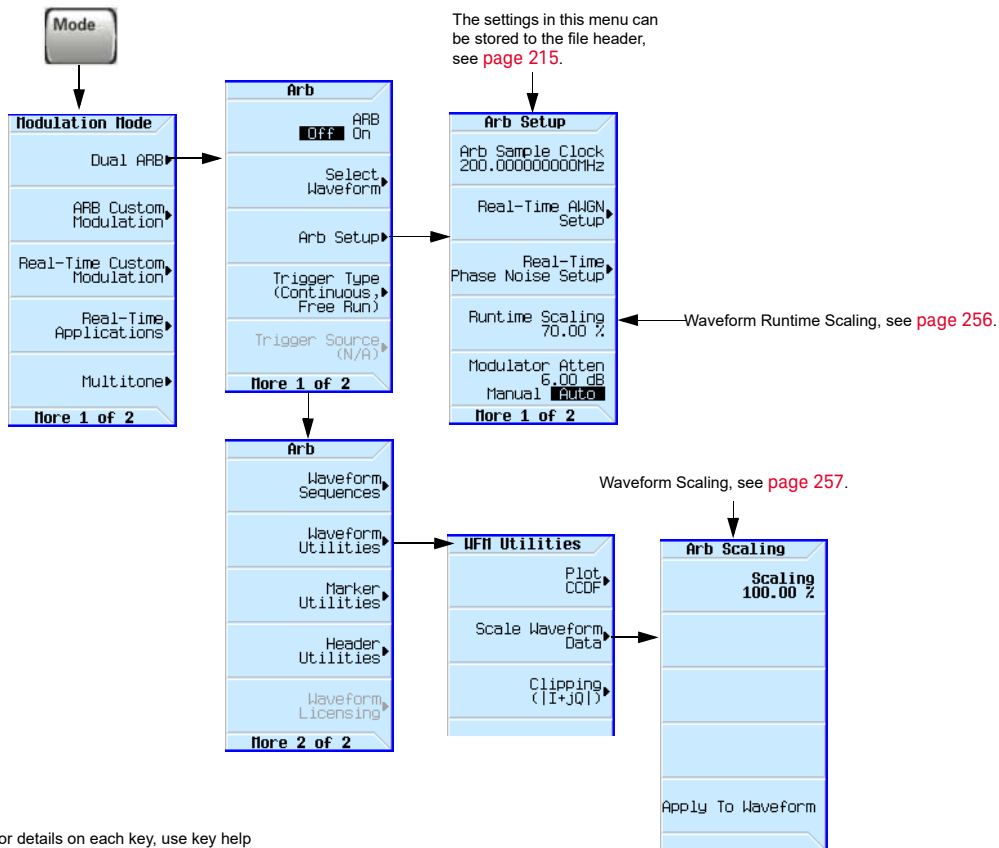


## Scaling a Waveform

The signal generator uses an interpolation algorithm (sampling between the I/Q data points) when reconstructing a waveform. For common waveforms, this interpolation can cause overshoots, which may create a DAC over-range error condition. This chapter describes how DAC over-range errors occur and how you can use waveform scaling to eliminate these errors.

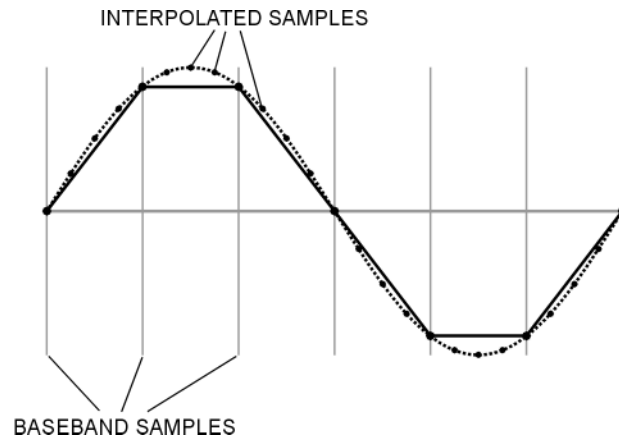
- [How DAC Over-Range Errors Occur](#) on page 254
- [How Scaling Eliminates DAC Over-Range Errors](#) on page 255
- Keysight MXG/EXG waveform scaling on [page 256](#) and [page 257](#):
  - Waveform runtime scaling to scale a currently-playing waveform
  - Waveform scaling to permanently scale either the currently playing waveform, or a non-playing waveform file in BBG media

Figure 9-12      **Scaling Softkeys**

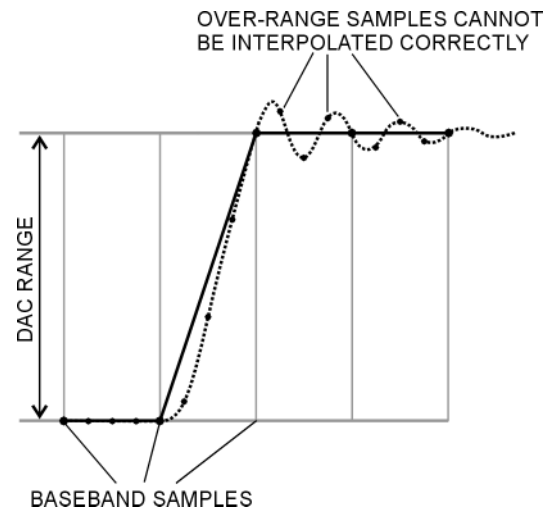


## How DAC Over-Range Errors Occur

The signal generator uses an interpolator filter when it converts digital I and Q baseband waveforms to analog waveforms. Because the clock rate of the interpolator is four times that of the baseband clock, the interpolator calculates sample points between the incoming baseband samples and smooths the waveform as shown in the figure at the right.



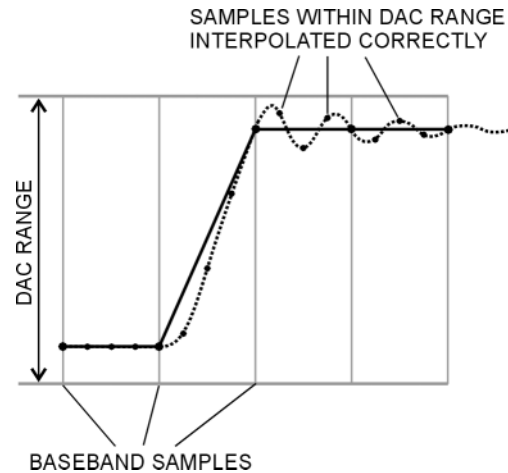
The interpolation filters in the DACs overshoot the baseband waveform. If a baseband waveform has a fast-rising edge, the interpolator filter's overshoot becomes a component of the interpolated baseband waveform. This response causes a ripple or ringing effect at the peak of the rising edge. If this ripple overshoots the upper limit of the DAC range, the interpolator calculates erroneous sample points and is unable to replicate the true form of the ripple (see the figure at the right). As a result, the signal generator reports a DAC over-range error.



## How Scaling Eliminates DAC Over-Range Errors

Scaling reduces the amplitude of the baseband waveform while maintaining its basic shape and characteristics, such as peak-to-average power ratio. If the fast-rising baseband waveform is scaled enough to allow an adequate margin for the interpolator filter overshoot, the interpolator filter can calculate sample points that include the ripple effect and eliminate the over-range error (see the figure at the right).

Although scaling maintains the basic shape of the waveform, excessive scaling can compromise waveform integrity. For example, if the bit resolution becomes too low the waveform becomes corrupted with quantization noise. To achieve maximum accuracy and optimize dynamic range, scale the waveform no more than is required to remove the DAC over-range error. Optimum scaling varies with waveform content.



## Setting Waveform Runtime Scaling

Runtime scaling scales the waveform data during playback; it does not affect the stored data. You can apply runtime scaling to either a segment or sequence, and set the scaling value either while the ARB is on or off. This type of scaling is well suited for eliminating DAC over-range errors. Runtime scaling adjustments are not cumulative; the scaling value is applied to the original amplitude of the waveform file. There are two ways to save the runtime scaling setting: by using the save function ([page 82](#)) and by saving the setting to the file header ([page 217](#)). Saving to the file header saves the value with the waveform file, saving with the Save function stores the value as the current instrument setting.

Use this example to learn how to scale the currently selected waveform.

1. Select the waveform to which you want to apply scaling:
  - a. Press **Mode > Dual ARB > Select Waveform**.
  - b. Highlight the desired waveform (segment or sequence).
  - c. Press **Select Waveform**.
2. Play the selected waveform: Press **ARB Off On** until On highlights.
3. Set the Waveform Runtime Scaling value:
  - a. Press **ARB Setup > Waveform Runtime Scaling**.
  - b. Enter a scaling value.

The signal generator automatically applies the new scaling value to the waveform. There is no single value that is optimal for all waveforms. To achieve the maximum dynamic range, use the largest scaling value that does not result in a DAC over-range error.

- c. Press **Return**.

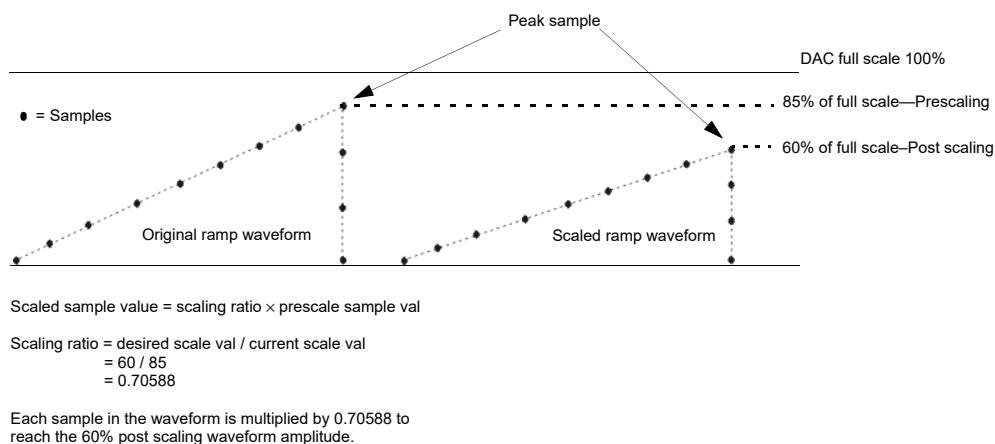


## Setting Waveform Scaling

Waveform scaling differs from waveform runtime scaling in that it permanently affects waveform data and only applies to waveform segments stored in BBG media. You scale the waveform either up or down as a percentage of the DAC full scale (100%). If you scale your waveforms using this method, you may also need to change the waveform runtime scaling value to accommodate this scaling.

When you scale, the signal generator permanently modifies the waveform file's sample values so that they conform to the desired scaling value. When you initiate scaling, the signal generator performs the following actions:

- locates the waveform file's absolute peak sample value
- determines its current percentage of full scale
- calculates the ratio of the desired scale value to the determined absolute peak sample scale value
- multiplies each sample in the waveform file by this ratio



When you scale a waveform, you can create fractional data, lose data, or both. Fractional data occurs almost every time you reduce or increase the scaling value, and causes quantization errors. Quantization errors are more noticeable when scaling down, since you are closer to the noise floor. You lose data when either the signal generator rounds fractional data down or the scaling value is derived using the results from a power of two. This means that scaling a waveform in half (power of two:  $2^1 = 2$ ) causes each waveform sample to lose one bit. The waveform data modifications are not correctable and may cause waveform distortion. It is always best to make a copy of the original file prior to applying scaling.

Use the following examples to apply waveform scaling to a waveform file. While this process uses the factory-supplied waveform `RAMP_TEST_WFM`, it is the same for any waveform file.

### Copy a Waveform File

1. Display the waveform files in BBG media: Press **File** > **Catalog Type** > **More** > **Volatile Segments**.
2. Highlight the waveform `RAMP_TEST_WFM`.
3. Press **Copy File**.

4. Name the copy (this example uses the name `MY_TEST_SCAL`) and press **Enter**.

### Apply Scaling to the Copied Waveform File

#### CAUTION

This type of scaling is non-reversible. Any data lost in the scaling operation cannot be restored. Save a copy of the waveform file before scaling.

---

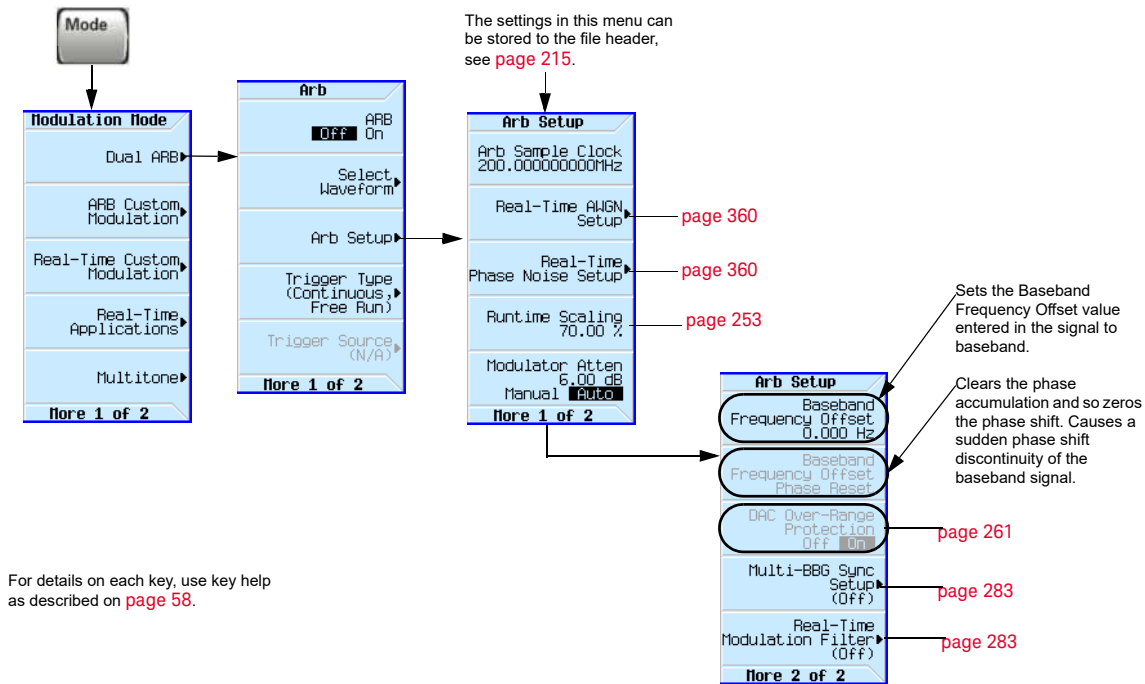
1. Open the DUAL ARB Waveform Utilities menu:  
Press **Mode > Dual ARB > More > Waveform Utilities**.
2. In the list of BBG Media segment files, highlight the copied file (in this example, `MY_TEST_SCAL`).
3. Set and apply a scaling value (in this example 70% scaling is applied):  
Press **Scale Waveform Data > Scaling > 70 > % > Apply to Waveform**.

## Setting the Baseband Frequency Offset

The baseband frequency offset specifies a value to shift the baseband frequency up to  $\pm 50$  MHz within the BBG 100 MHz signal bandwidth, depending on the signal generator's baseband generator option. While the following figure shows how to access the control using the Dual ARB player, the location of the **Baseband Frequency Offset** softkey within each ARB format, through the **ARB Setup** softkey, is the same as for the Dual ARB player.

When the Baseband Frequency Offset is non-zero, the hardware rotator accumulates phase-shift of the baseband signal. This residual phase remains even after the offset value is returned to zero. To remove this phase accumulation, either restart the personality or select the **Baseband Frequency Offset Phase Reset** softkey. This softkey will grey out whenever the phase, due to the frequency offset, is zero. In addition, while there is a non-zero residual phase present in the signal, the DAC Over-Range Protection feature will automatically ensure that the reduced internal scaling is applied. This reduced scaling will be removed when both the frequency offset is returned to zero and the phase is reset.

Figure 9-13 Baseband Frequency Offset Softkey for the Dual ARB Player



Common uses for the offset feature include:

- offsetting the carrier from any LO feedthrough (carrier signal spur at the carrier frequency)
- sum the baseband signal with external I and Q inputs to create a multicarrier signal
- use the signal generator's I/Q signal as an IF

**NOTE**

Changing the baseband frequency offset may cause a DAC over range condition that generates error 628, Baseband Generator DAC over range. The signal generator incorporates an automatic scaling feature to minimize this occurrence. For more information, see “DAC Over-Range Conditions and Scaling” on page 261.

The baseband frequency offset value is one of the file header parameters (page 215), which means you can store this value with the waveform. When you select a waveform with a stored frequency offset value, the signal generator changes the current value to match the stored file header value. If there is no stored baseband offset frequency value for the current waveform, the signal generator uses the last set frequency offset value.

You can also use the Save function (page 82) to store this value as part of the signal generator setup. When you Recall a setup stored with the Save function, the baseband frequency offset value becomes the current instrument setting value, disregarding the stored file header value.

Use the following steps to offset the carrier from LO/carrier feedthrough. This example uses the factory supplied waveform, SINE\_TEST\_WFM available in the Dual ARB Player. To view the output for this example, connect the RF OUTPUT of the signal generator to the input of a spectrum analyzer.

**1. Select and play the waveform.**

- a. Press **Mode > Dual ARB > Select Waveform.**
- b. In the Segment On BBG Media column, select SINE\_TEST\_WFM.
- c. Press **Select Waveform.**

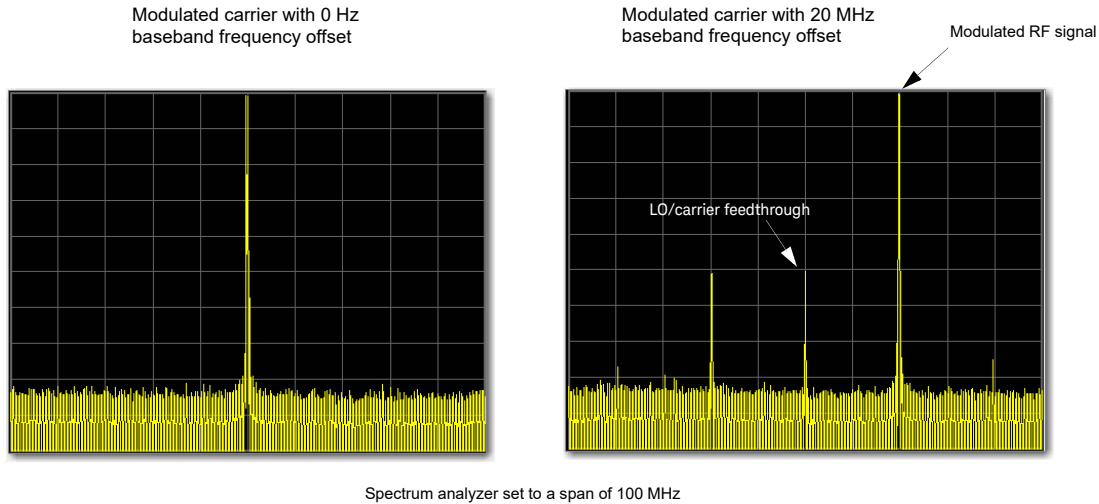
**2. Generate the waveform: Press ARB Off On to On.**

**3. Configure the carrier signal:**

- a. Set the carrier signal to 1 GHz.
- b. Set the amplitude to 0 dBm.
- c. Turn on the RF OUTPUT.

**4. Press Mode > Dual Arb > ARB Setup > More > Baseband Frequency Offset > 20 MHz.**

The modulated RF signal is now offset from the carrier frequency by 20 MHz as shown in the following figures.

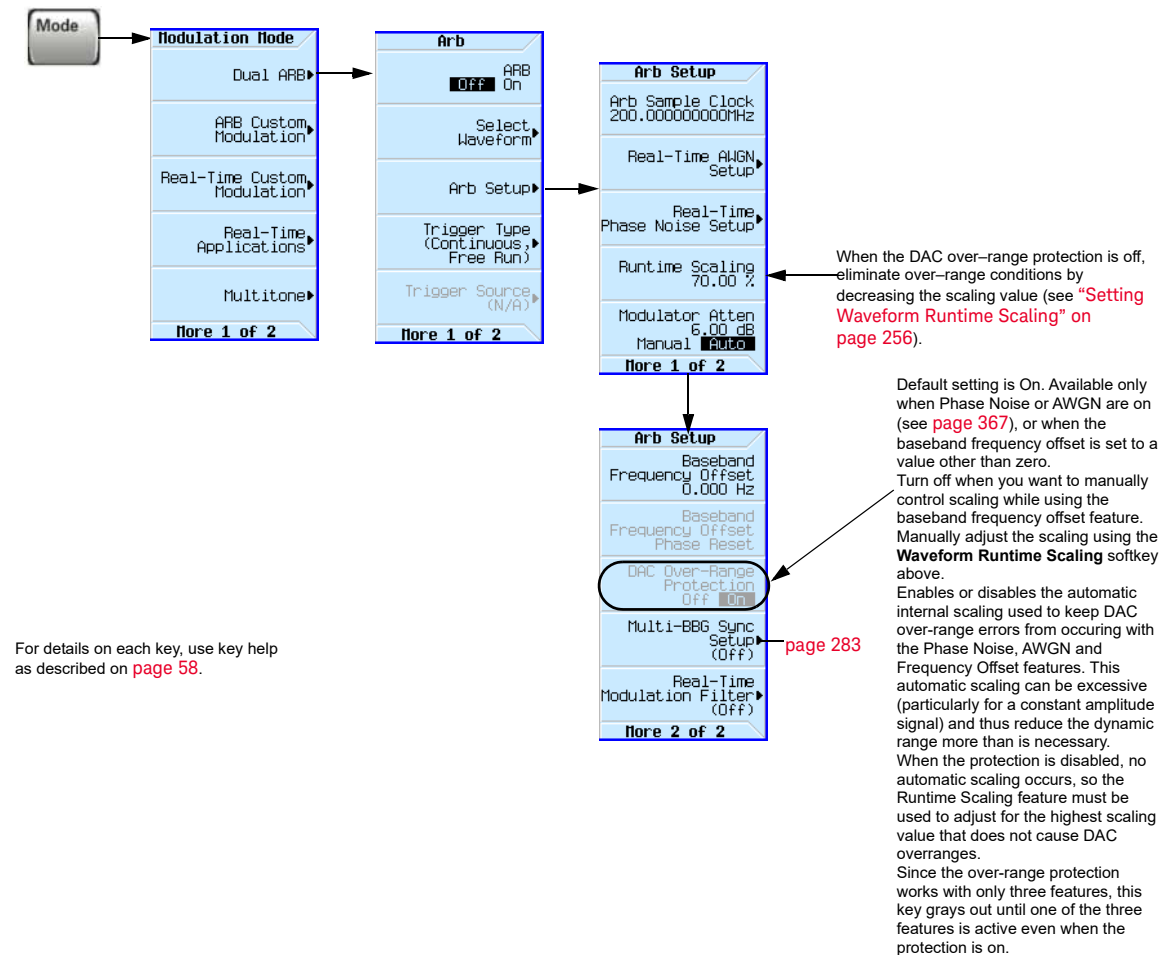


## DAC Over-Range Conditions and Scaling

When using the baseband frequency offset (at a setting other than 0 Hz), it is possible to create a DAC over-range condition, which causes the Keysight MXG/EXG to generate an error. To minimize this condition with the frequency offset feature, the Keysight MXG/EXG incorporates an automatic DAC over-range protection feature that scales down the I/Q data by  $1/\text{square root of } 2$  when the offset is something other than zero. Because it can scale the data by more than what is actually need, it typically decreases the dynamic range of the waveform. This is especially noticeable when using a constant amplitude signal such as GSM.

For the Dual ARB Player, this automatic over-range feature can be turned off. When on, it is active for the Dual ARB signal only when the offset is something other than 0 Hz. The control for the Dual ARB DAC over-range protection feature is located in the key path as shown in [Figure 9-14](#).

Figure 9-14 Dual ARB DAC Over-Range Protection Softkey Location



In the Dual ARB Player, to avoid excessive scaling or to just perform scaling manually, turn the feature off and use the **Waveform Runtime Scaling** softkey to eliminate DAC over-range conditions.

## I/Q Modulation

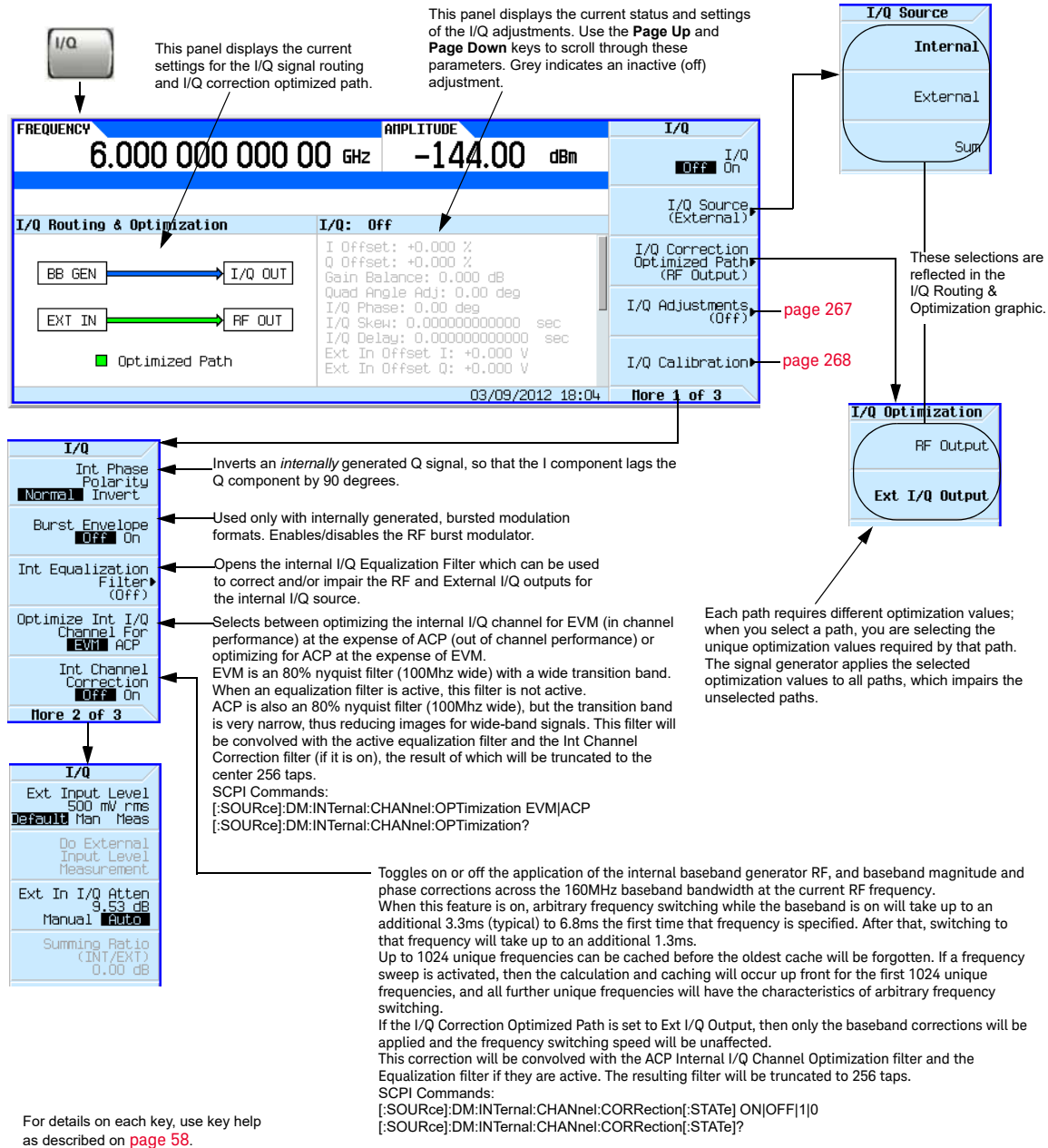
The following factors contribute to the error vector magnitude:

- Differences in amplitude, phase, and delay between the I and Q channels
- DC offsets

The I/Q menu not only enables you to select the I/Q signal source and output, it also provides adjustments and calibrations to compensate for differences in the I and Q signals.

See also, **“Modulating the Carrier Signal” on page 72.**

Figure 9-15 I/Q Display and Softkeys





## Using the Rear Panel I and Q Outputs

### NOTE

The rear panel I and Q connectors only output a signal while using the internal BBG.

In addition to modulating the carrier, the signal generator also routes the internally generated I and Q signals to the rear panel I and Q connectors. These output signals are post DAC, so they are in analog form. You can use these rear panel I and Q signals to:

- drive a system’s transmitter stage
- test individual analog I and Q components such as an I/Q modulator
- route the I and Q signals into another signal generator

The factory default setting routes the internally generated I and Q signals to the I/Q modulator and the rear panel I and Q output connectors. However to optimize (apply calibration factors) the rear panel signals, you need to select the external I/Q output path.

### Select and Play a Waveform

1. Press **Mode** > **Dual ARB** > **Select Waveform**.
2. Highlight the desired waveform.
3. Press **Select Waveform** > **ARB Off On to On**.

### Optimize the Signal Path

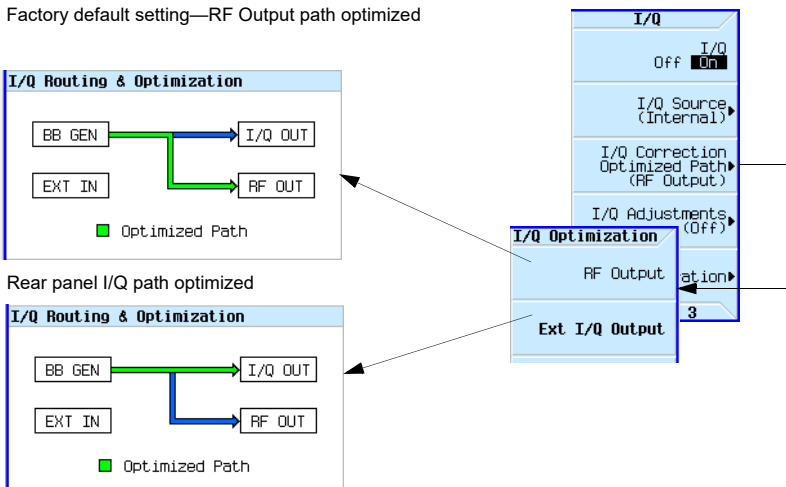
1. Connect cables from the rear panel I and Q connectors to either a DUT or another signal generator.

When you turn the ARB on, the signal generator automatically outputs the I and Q signals to the rear panel connectors. You can use the rear panel I and Q signals as I and Q inputs to another signal generator. The MXG/EXG has front panel connectors, I Input and Q Input, for this purpose.

2. Press **I/Q** > **I/Q Correction Optimized Path** > **Ext I/Q Output**.

When you optimize a path, the path indicator turns green.

Factory default setting—RF Output path optimized



## Configuring the Front Panel Inputs

The signal generator accepts externally supplied analog I and Q signals through the front panel I Input and Q Input. You can use the external signals as the modulating source, or sum the external signals with the internal baseband generator signals.

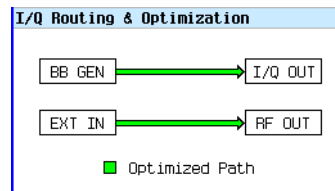
1. Connect I and Q signals to the front panel connectors.
  - a. Connect an analog I signal to the signal generator's front panel I Input.
  - b. Connect an analog Q signal to the signal generator's front panel Q Input.
2. Set the signal generator to recognize the front panel input signals:

– **To Modulate onto the Carrier**

Press **I/Q > I/Q Source > External**.

Signal generator display: both paths are calibrated when the **I/Q Correction Optimized Path** is set to **Ext I/Q Output** (see [page 265](#))

**Note:** when the optimized path is set to RF, *only* the RF Out path is calibrated.

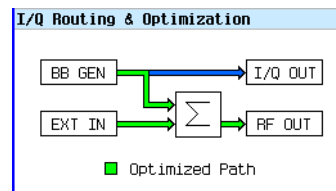


– **To Sum and Modulate onto the Carrier**

Press **I/Q > I/Q Source > Sum**.

To select and play a waveform for the **BB GEN** path, see [page 208](#).

Signal generator display: both RF paths are calibrated when the **I/Q Correction Optimized Path** is set to **RF Output** (see [page 265](#))



Notice that only the internal BBG (**BB GEN**) routes I and Q signals to the rear panel I and Q outputs.

3. If you are using only the external I and Q signals (no summing), turn on the I/Q modulator: Press **I/Q Off On** to On.
4. Configure the RF output:
  - a. Set the carrier frequency.
  - b. Set the carrier amplitude.
  - c. Turn the RF output on.

# I/Q Adjustments

Use the I/Q Adjustments to compensate for or add impairments to the I/Q signal.

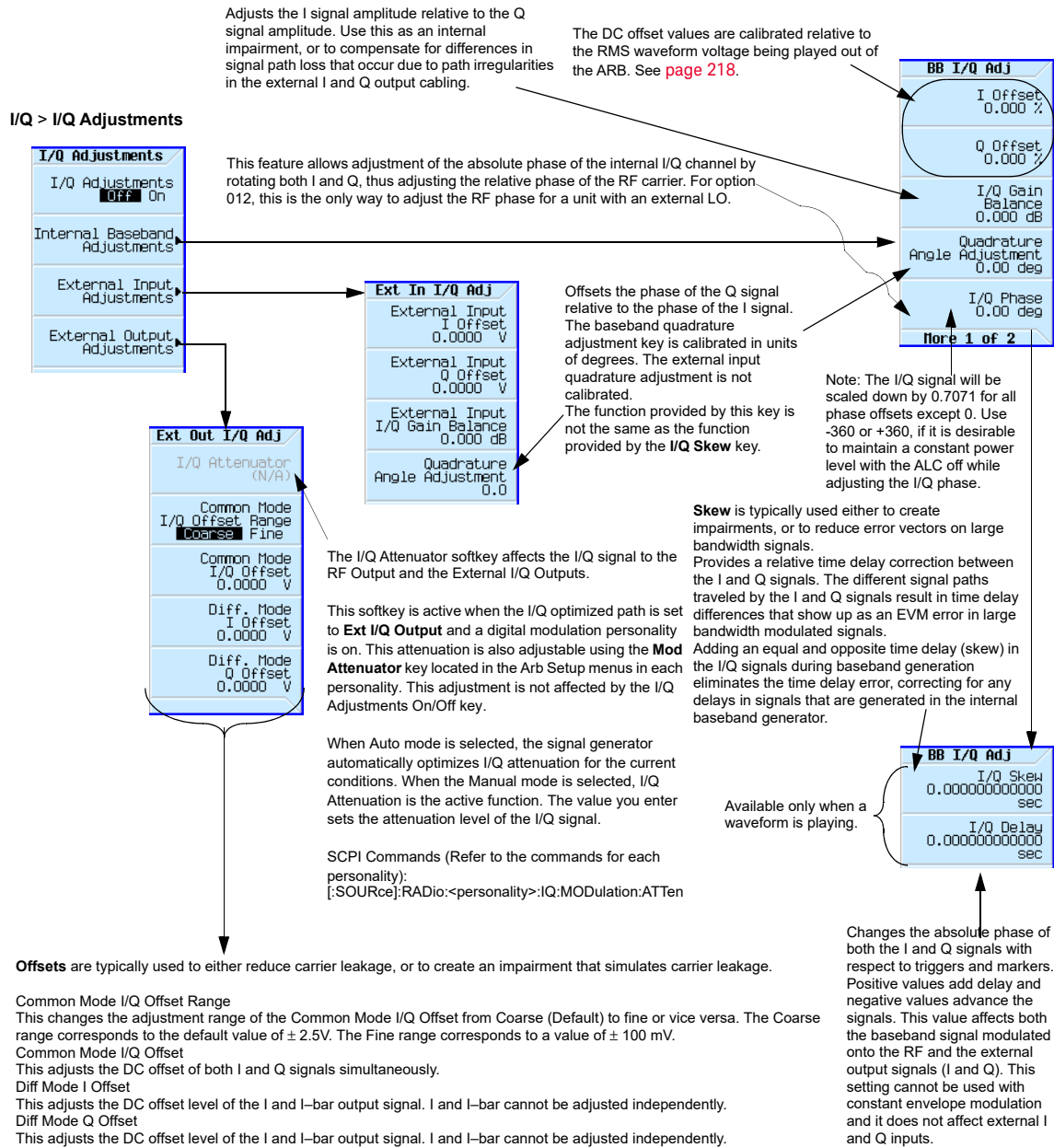


Table 9-2 I/Q Adjustments Uses

I/Q Adjustment	Effect	Impairment
Offset	Carrier feedthrough	dc offset
Quadrature Angle	EVM error	phase skew
	I/Q images	I/Q path delay
I/Q Skew	EVM error	high sample rate phase skew or I/Q path delay
I/Q Gain Balance	I/Q amplitude difference	I/Q gain ratio
I/Q Phase	I/Q phase rotation	RF phase adjustment

The I/Q adjustment, I/Q Delay, is not for adding impairments; its function is to compensate for any latency between the EVENT output signals (marker signals) and the RF output.

## I/Q Calibration

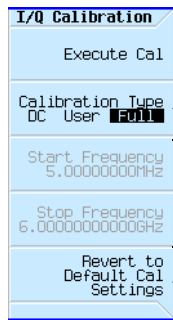
Use the I/Q calibration for I and Q signal corrections. What aspects of the I and Q signal is corrected depends on whether the signal is internally or externally generated.

Correction	Internal I and Q	External I and Q
<b>Offset</b>	X	X
<b>Gain Balance</b>	X	X
<b>Quadrature Error</b>	X	X

When you perform an I/Q calibration, that calibration data takes precedence over the factory-supplied calibration data. The calibration routines improve performance that may degrade over time or due to temperature changes. An I/Q calibration should be run when the ambient temperature has varied by at least  $\pm 5$  degrees Celsius from the ambient temperature at which the previous calibration was run.

- The user I/Q calibration is persistent (i.e. Pressing instrument preset or cycling power does not remove the user I/Q calibration from memory).
- If the start and stop frequencies are set to the same value, then the calibration will be performed exactly at that frequency and the data will be persisted in the bounding calibration array elements.

I/Q > I/Q Calibration



Available only when  
Calibration type = User

Deletes any user-generated  
calibration data and restores  
the factory-supplied  
calibration data.

**DC** optimizes the I/Q performance for the current instrument settings, and typically completes in several seconds. Changing any instrument setting after performing a DC calibration voids the DC calibration and causes the signal generator to revert to the user calibration data (or factory-supplied calibration data, if no user calibration data exists)

**User** provides a quicker calibration when a full calibration is not required. You can limit the calibration by specifying the calibration start and stop frequencies. When you limit the calibration to less than the instrument's full frequency range, the factory-supplied calibration data is used for the rest of the range. If the start and stop frequencies are set to the same value, then the calibration will be performed exactly at that frequency and the data will be persisted in the bounding calibration array elements. Information is retained through a preset or power cycle\*.

**Full** takes approximately a minute, executing measurements over the instrument's entire frequency range.

Information is retained through a preset or power cycle\*.

**\*Caution:**

To avoid the loss of data, GPIB settings, or current user instrument states that have not been permanently saved to non-volatile memory, the signal generator should always be powered down either via the Instrument's front panel power button or the appropriate SCPI command. Signal generators installed in rack systems and powered down with the system rack power switch rather than the instrument's front panel switch display an Error -310 due to the instrument not being powered down correctly.

Note

A DC calibration requires the following settings:

- I/Q: On
- Optimized Path: RF Output
- Source: Internal

For details on each key, use key help as described on [page 58](#).

## Using the Equalization Filter

An equalization FIR file can be created externally, uploaded via SCPI, and subsequently selected from the file system (refer to [“Working with Files” on page 74](#)). For information related to downloading FIR file coefficients, refer to the **Programming Guide**. For information regarding working with FIR file coefficients manually, refer to [“Modifying a FIR Filter Using the FIR Table Editor” on page 278](#).

This filter can be used to correct and/or impair the RF and External I/Q outputs for the internal I/Q source. This filter will be convolved with the ACP Internal I/Q Channel Optimization filter if that filter is selected, the result of which will be truncated to the center 256 taps. The equalization filter operates at 200 MHz, so all equalization filters must be resampled to 200 MHz prior to selection, if they are sampled at some other rate.

The MXG/EXG supports equalization filters—either Complex or Real—that are programmable FIR filters with two inputs (I, Q) and two outputs (I, Q) per sample. This 256-tap filter has two modes of operation:

### NOTE

The maximum number of taps is 256 (with 2 coefficients per tap for a complex filter) for equalization filters. The minimum number of taps is 2. Equalization filters can also be referred to as predistortion filters or correction filters.

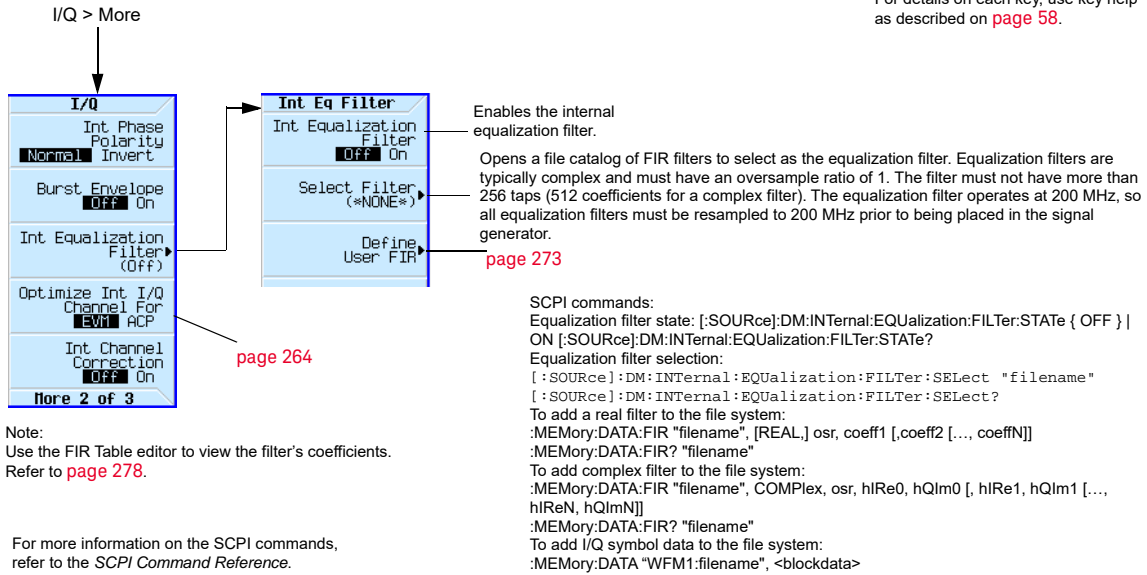
---

Type of Filter	Description
Real	The I and Q samples are independently filtered by a single set of real coefficients.
Complex	The samples are treated as complex ( $I + jQ$ ) and convolved with the filter coefficients which are specified as $(I + jQ)$ in the time domain.

The equalization filter can be turned on and off.

Figure 9-16 Int Equalization Filter Softkeys

For details on each key, use key help as described on [page 58](#).

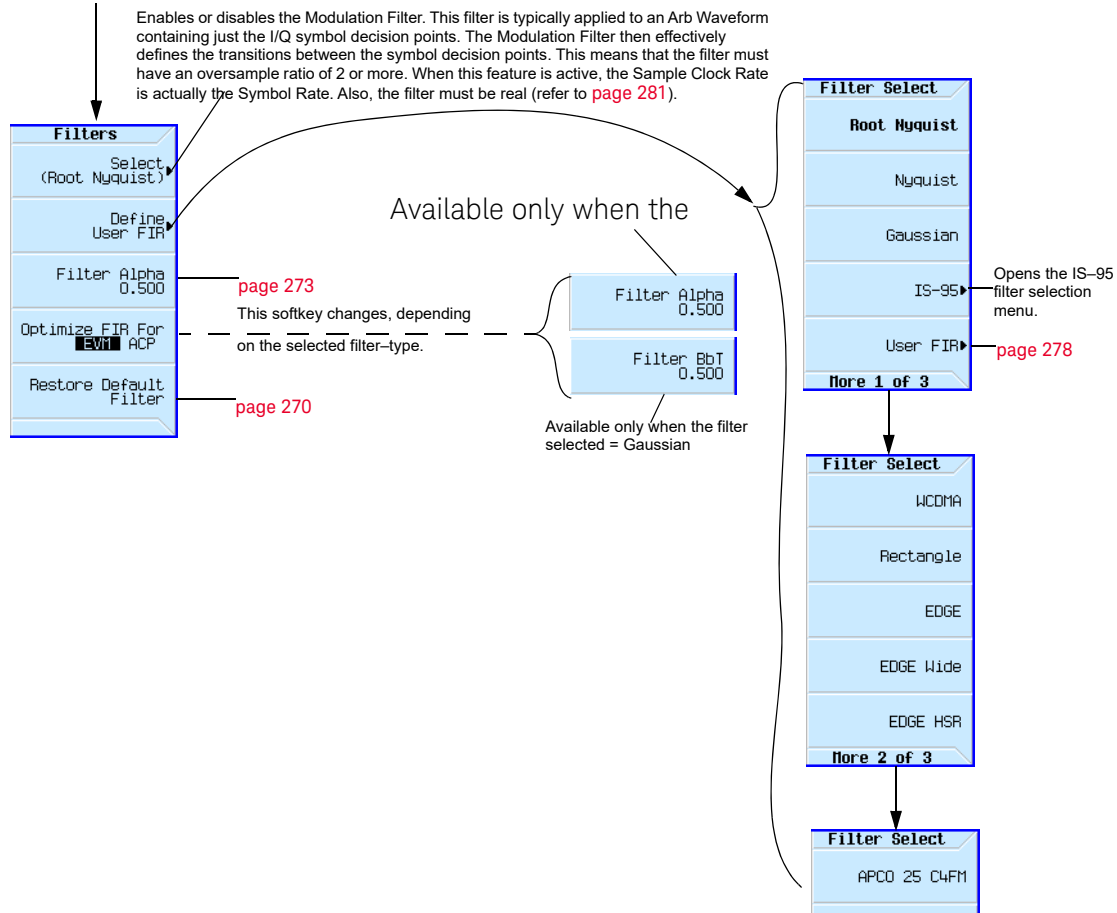


## Using Finite Impulse Response (FIR) Filters in the Dual ARB Real-Time Modulation Filter

Finite Impulse Response filters can be used to compress single carrier I/Q waveforms down to just the I/Q constellation points and then define the transitions similar to the modulation filter in Arb Custom (refer to **“Using Finite Impulse Response (FIR) Filters with Custom Modulation” on page 412**). The key difference for dual ARB real-time modulation is that a filter is applied as the waveform plays, rather than in the waveform data itself.

**Figure 9-17 Filter Menu**

Mode > Dual ARB > Arb Setup > More > Real-Time Modulation Filter >





## Creating a User-Defined FIR Filter Using the FIR Table Editor

In this procedure, you use the `FIR Values` table editor to create and store an 8-symbol, windowed sync function filter with an oversample ratio of 4.

### Accessing the Table Editor

1. Press **Preset**.
2. Press **Mode** > **Dual ARB** > **Arb Setup** > **More** > **Real-Time Modulation Filter** > **Select** > **Nyquist**.
3. Press **Define User FIR**.
4. Press **More 1 of 2** > **Delete All Rows** > **Confirm Delete of All Rows**.

This will initialize the table editor as shown in [Figure 9-18](#).

Figure 9-18 Creating a User-Defined FIR Filter Using the FIR Filter Table Editor

Mode > Dual ARB > Arb Setup > More > Real-Time Modulation Filter > Define User FIR > More 1 of 2 > Delete All Rows > Confirm Delete of All Rows

For details on each key, use key help as described on [page 58](#).

Opens a menu that enables you to select and load a saved file into volatile memory.

page 278

Adds a column for specifying the imaginary coefficients of the filter.\* (All of the imaginary coefficients will be 0 initially.) If the Convert to Complex Filter softkey has been selected the Convert to Real Filter softkey becomes available. Caution: Selecting the Convert to Real Filter softkey removes the Imaginary Values column and the imaginary values are lost.

Active only when: FIR filter coefficient table has minimum of two values visible.

Note:  
Modulation filters must be real and have an oversample ratio (OSR) of 2 or greater.  
Equalization filters are typically complex and must have an oversample ratio (OSR) of 1.

### Entering the Coefficient Values

1. Press the **Return** softkey to get to the first page of the table editor.
2. Use the cursor to highlight the `Value` field for coefficient 0.
3. Use the numeric keypad to type the first value ( $-0.000076$ ) from [Table 4](#). As you press the numeric keys, the numbers are displayed in the active entry area. (If you make a mistake, you can correct it using the backspace key.)

- Continue entering the coefficient values from the table in step 1 until all 16 values have been entered.

Table 9-3

Coefficient	Value	Coefficient	Value
0	-0.000076	8	-0.035667
1	-0.001747	9	-0.116753
2	-0.005144	10	-0.157348
3	-0.004424	11	-0.088484
4	0.007745	12	0.123414
5	0.029610	13	0.442748
6	0.043940	14	0.767329
7	0.025852	15	0.972149

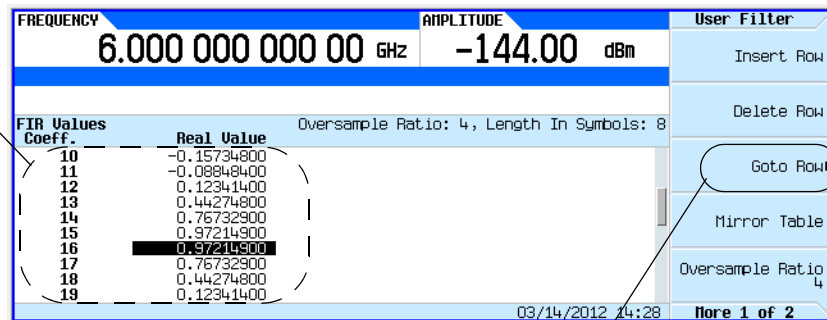
### Duplicating the First 16 Coefficients Using Mirror Table

In a windowed sinc function filter, the second half of the coefficients are identical to the first half in reverse order. The signal generator provides a mirror table function that automatically duplicates the existing coefficient values in the reverse order.

- Press **Mirror Table**. The last 16 coefficients (16 through 31) are automatically generated and the first of these coefficients (number 16) highlights, as shown in [Figure 9-19 on page 274](#).

Figure 9-19

FIR table coefficient values, may be from the factory default values or entered by the user.



Use the Goto Row menu to move around and make changes to the FIR Values coefficient table.

For details on each key, use key help as described on [page 58](#).

## Setting the Oversample Ratio

### NOTE

Modulation filters are real and have an oversample ratio (OSR) of two or greater.

Equalization filters are typically complex and must have an OSR of one (refer to [“Using the Equalization Filter” on page 270](#) and to [“Setting the Real-Time Modulation Filter” on page 281](#)).

The oversample ratio (OSR) is the number of filter coefficients per symbol. Acceptable values range from 1 through 32; the maximum number of taps allowed by the table editor is 1024.

The actual limits on OSR, number of coefficients, and number of symbols depends on the feature with which the FIR is used. Refer to [Table 9-4](#).

Table 9-4

Filter Type	Oversampling Ratio (OSR)	Number of Taps (Maximum)	Symbols/Coefficients (Maximum)
Equalization <sup>a</sup>	1	256	--
ARB Custom Modulation <sup>b</sup>	$\geq 2$	--	512/1024
Dual ARB Real-Time Modulation <sup>c</sup>	$\geq 2$	--	32/1024

- a. When I/Q timing skew, I/Q delay, or the ACP internal I/Q channel optimization features are active, the effective number of taps for the equalization filter are reduced.
- b. The filter may be sampled to a higher or lower OSR.
- c. The filter will be decimated to a 16 or lower OSR depending on the symbol rate.

For modulation filters, if the oversample ratio is different from the internal, optimally selected one, then the filter is automatically resampled to an optimal oversample ratio.

For this example, the desired OSR is 4, which is the default, so no action is necessary.

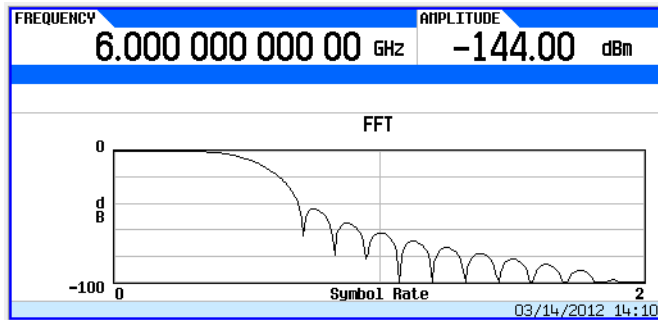
## Displaying a Graphical Representation of the Filter

The signal generator has the capability of graphically displaying the filter in both time and frequency dimensions.

1. Press **More 1 of 2 > Display Filter > Display FFT** (fast Fourier transform).

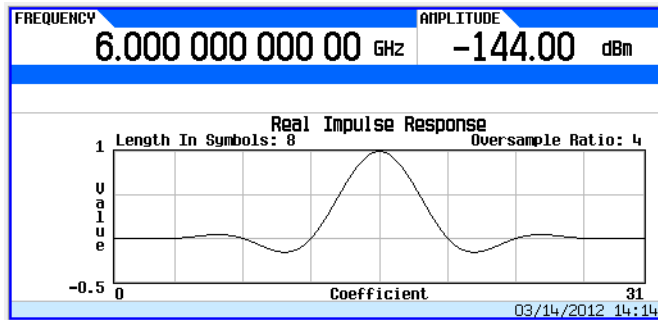
Refer to [Figure 9-20 on page 276](#).

Figure 9-20



2. Press **Return**.
3. Press **Display Impulse Response**.  
Refer to **Figure 9-21**.

Figure 9-21



4. Press **Return** to return to the menu keys.

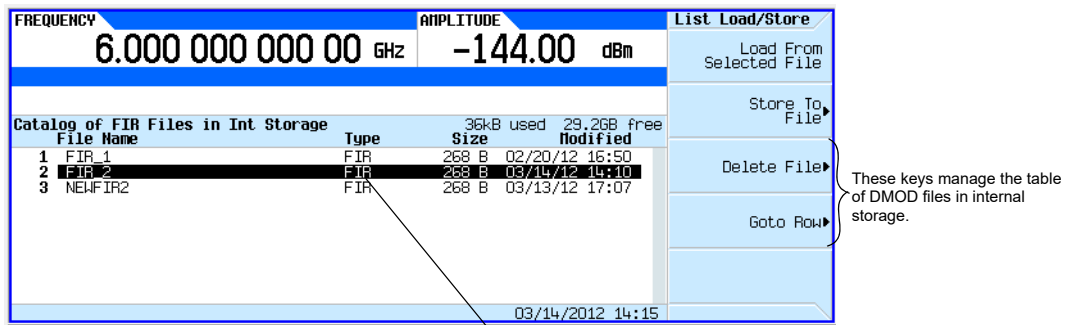
### Storing the Filter to Memory

Use the following steps to store the file.

1. Press **Load/Store** > **Store To File**. The catalog of FIR files appears along with the amount of memory available.
2. As described in **Storing, Loading, and Playing a Waveform Segment** on page 207, name and store this file as `FIR_1`.

The `FIR_1` file is the first file name listed. (If you have previously stored other FIR files, additional file names are listed below `FIR_1`.) The file type is FIR and the size of the file is 260 bytes. The amount of memory used is also displayed. The number of files that can be saved depends on the size of the files and the amount of memory used. Refer to **Figure 9-22**.

Figure 9-22



Catalog displays FIR files that have been previously saved by the user.

For details on each key, use key help as described on [page 58](#).

Memory is also shared by instrument state files and list sweep files.

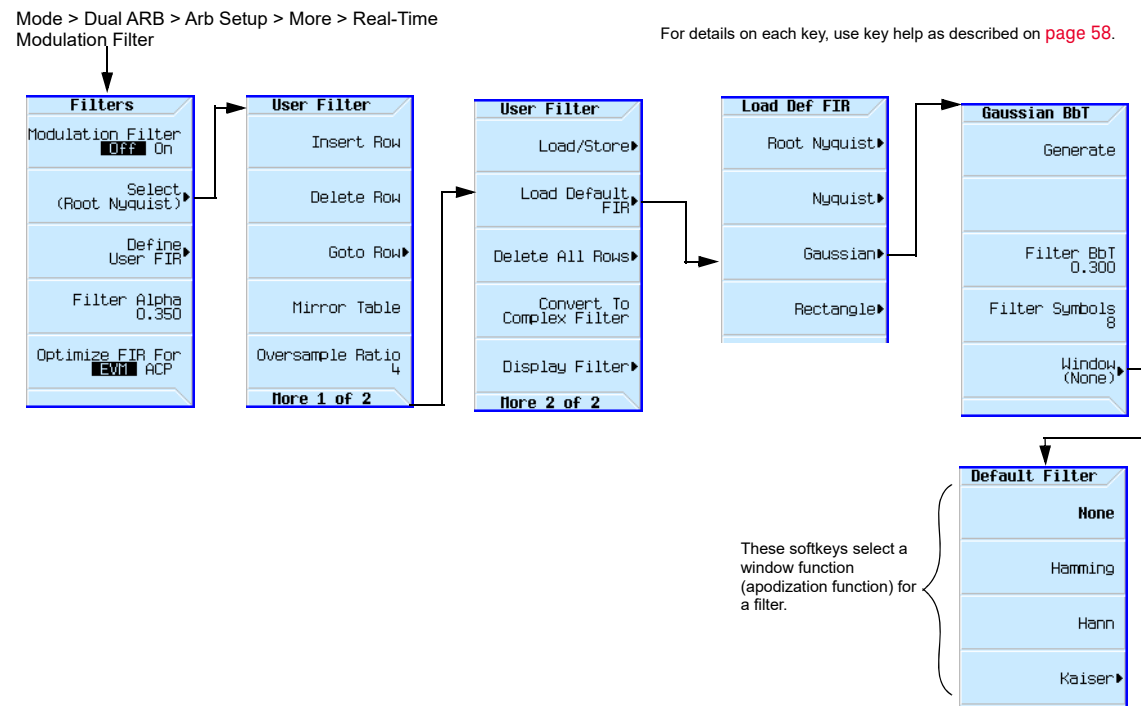
This filter can now be used to customize a modulation format or it can be used as a basis for a new filter design.

## Modifying a FIR Filter Using the FIR Table Editor

FIR filters stored in signal generator memory can easily be modified using the FIR table editor. You can load the FIR table editor with coefficient values from user-defined FIR files stored in non-volatile memory or from one of the default FIR filters. Then you can modify the values and store the new files.

### Loading the Default Gaussian FIR File

Figure 9-23 Loading the Default Gaussian FIR File



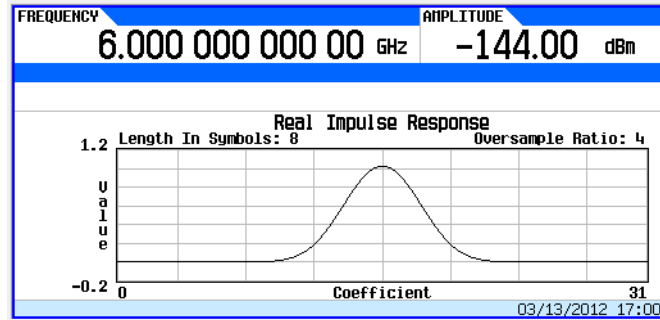
1. Press **Preset**.
2. Press **Mode > Dual ARB > Arb Setup > More > Real-Time Modulation Filter > Define User FIR > More > Load Default FIR > Gaussian**.
3. Press **Filter BbT > 0.300 > Enter**.
4. Press **Filter Symbols > 8 > Enter**.
5. Press **Generate**.

#### NOTE

The actual oversample ratio during modulation is automatically selected by the instrument. A value between 4 and 16 is chosen dependent on the symbol rate, the number of bits per symbol of the modulation type, and the number of symbols.

6. Press **Display Filter > Display Impulse Response** (refer to [Figure 9-24](#)).

Figure 9-24



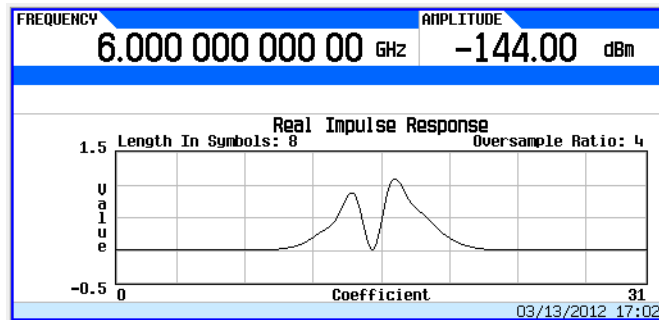
For details on each key, use key help as described on page 58.

7. Press **Return**.

### Modifying the Coefficients

1. Using the front panel arrow keys, highlight coefficient 15.
2. Press **0** > **Enter**.
3. Press **Display Impulse Response**.

Figure 9-25



For details on each key, use key help as described on page 58.

Refer to **Figure 9-25**. The graphic display can provide a useful troubleshooting tool (in this case, it indicates that a coefficient value is missing, resulting in an improper Gaussian response).

4. Press **Return**.
5. Highlight coefficient 15.
6. Press **1** > **Enter**.

## Storing the Filter to Memory

The maximum file name length is 23 characters (alphanumeric and special characters).

- 1. Press **Return** > **Return** > **Load/Store** > **Store To File**.**
- 2. Name the file NEWFIR2.**
- 3. Press **Enter**.**

The contents of the current FIR table editor are stored to a file in non-volatile memory and the catalog of FIR files is updated to show the new file.



## Setting the Real-Time Modulation Filter

The real-time modulation filter effectively compresses a single carrier I/Q waveform down to just the I/Q constellation points and then controls the transitions similar to the modulation filter in Arb Custom modulation. The key difference is that this filter is applied as the waveform plays, rather than in the waveform data itself. The real-time modulation filter is only available for Dual ARB waveforms.

When the real-time modulation filter is on, the sample clock rate acts as the symbol rate. The sample clock rate must be set to one half of the sample rate for the real-time Arb modulation filter feature to be turned on. The sample rate is determined by the Option 65x baseband generator.

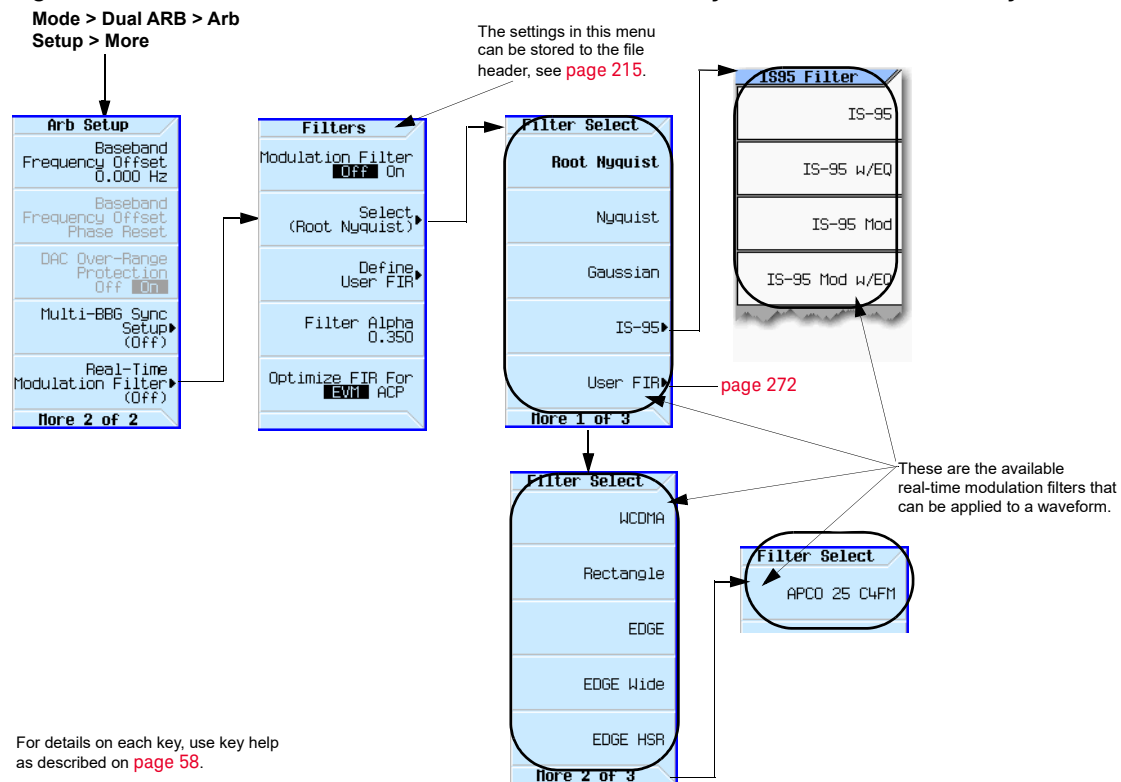
### CAUTION

Because the Arb format only supports rectangular I/Q data for defining the symbol decision points, constant envelope modulation, which should be specified as magnitude and phase, are not supported. (Examples of constant envelope modulation are MSK and FSK.)

The carrier frequency must be the same for all frequencies used (i.e. only single carrier applications work with arb real-time modulation filters).

Figure 9-26

Real-Time Modulation Filter Softkeys for the Dual ARB Player



Common uses for the real-time modulation feature include:

- Where the single carrier rectangular ideal I/Q symbol decision points are known and are to have an over-sampled filter applied.
- Where greater effective MXG/EXG memory size is required.

- When you have a low rate waveform that could benefit from a higher OSR that does not make the waveform longer.

The real-time modulation filter setup is one of the file header parameters (page 215), which means you can store this setup with the waveform. When you select a waveform with a stored modulation filter setup, the signal generator changes the current setup to match the stored file header setup. If there is no stored modulation filter setup for the current waveform, the signal generator uses the last set modulation filter setup.

You can also use the Save function (page 82) to store this value as part of the signal generator setup. When you Recall a setup stored with the Save function, the modulation filter value becomes the current instrument setting value, disregarding the stored file header value.

Use the following steps to apply a real-time modulation filter to the current waveform loaded into volatile memory. This example uses the factory supplied waveform, `SINE_TEST_WFM` available in the Dual ARB Player. To view the output for this example, connect the RF OUTPUT of the signal generator to the input of a spectrum analyzer.

**NOTE**

The following setup assumes you have completed the setup in “Setting the Baseband Frequency Offset” on page 259 for creating a modulated RF signal that is offset from the carrier frequency by 20 MHz.

---

**1. Configure the modulation filter:**

Press **Mode** > **Dual ARB** > **Arb setup** > **More** > **Real-Time Modulation Filter** > **Select** > **Root Nyquist**

**2. Press Filter Alpha** > **.4** > **Enter**.

The modulated RF signal now has a real-time modulation filter of type root nyquist, with a filter alpha of 0.400.

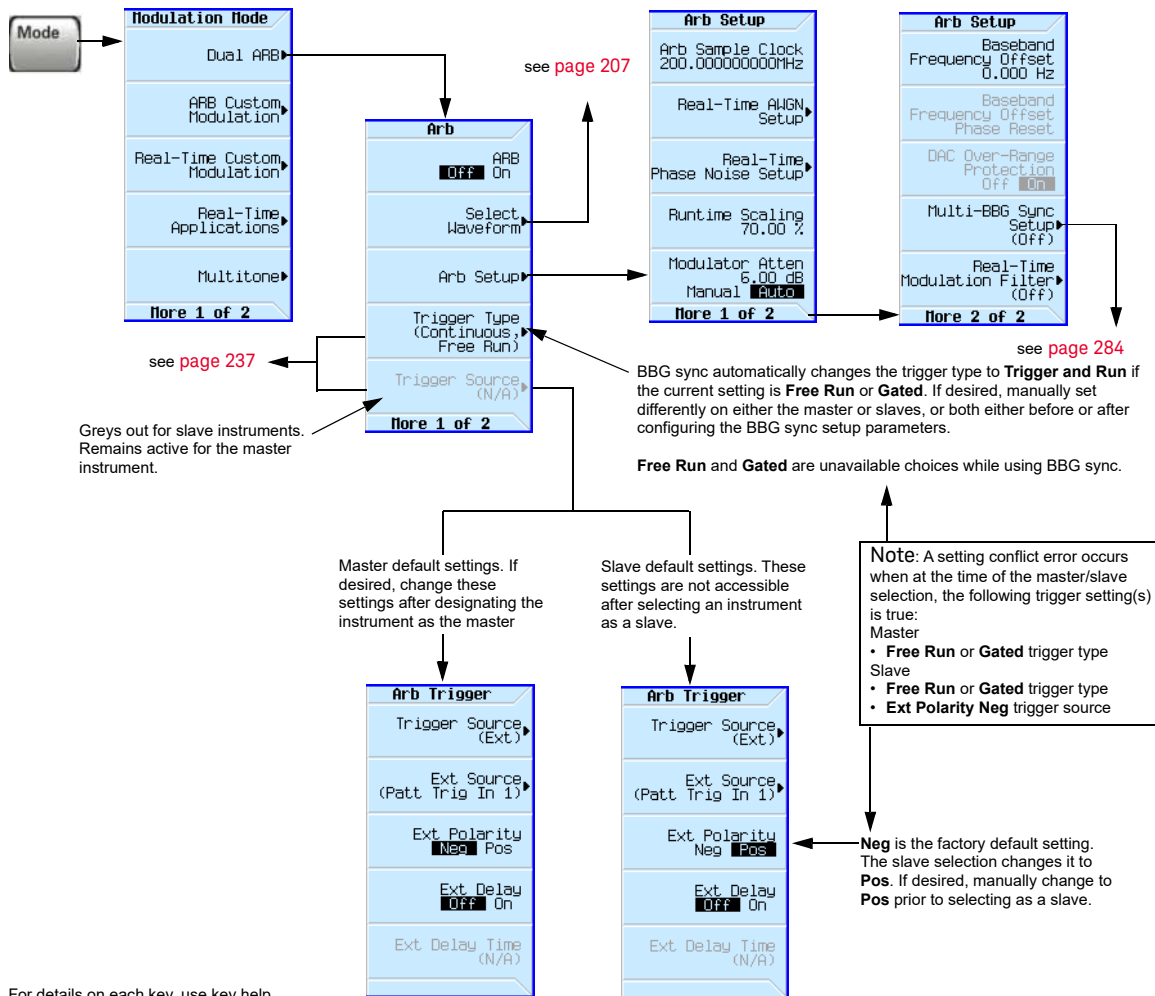
## Multiple Baseband Generator Synchronization

Available in the Dual ARB menu, this feature lets you set up a master/slave system of up to sixteen Keysight MXG/EXGs so that the baseband generators (BBG) synchronize the playing of waveforms. The system count includes one Keysight MXG/EXG to function as the master (see **“Equipment Setup” on page 286**).

The MXG/EXG with Option 012, enables 2x2, 3x3, or 4x4 MIMO configurations to share a common external LO signal to create phase coherent system. Refer to **“Understanding Option 012 (LO In/Out for Phase Coherency) with Multiple Baseband Generator Synchronization” on page 289** and the **Data Sheet**.

**Figure 9-27 Multiple Baseband Generator Synchronization (BBG Synchronization) Trigger Softkeys and Menu Location**

**Note:** The BBG sync feature automatically configures the trigger settings shown below. To avoid a settings conflict error in this process, manually configure the trigger settings prior to setting the BBG sync parameters shown on [page 284](#).



For details on each key, use key help as described on [page 58](#).

Figure 9-28 Multiple BBG Synchronization Front Panel Displays

Mode > Dual ARB > Arb Setup > More >  
Multi-BBG Sync Setup

Master Display and Available Softkeys

Master/slave indicator and setup diagram.

Master shows one of the following messages:

- Out of Sync
- In Sync

Shows after pressing **Sync Slaves**

**Note:** Press only after pressing **Listen for Sync** on all slave instruments and the slaves show "Waiting For Sync" as the status.

Slave Display and Available Softkeys

Master/slave indicator and setup diagram. The bottom slave indicator is green on the last slave in the system.

Slave shows one of the following messages:

- Out of Sync
- Waiting for Sync
- Shows after pressing **Listen for Sync**
- In Sync
- Shows after pressing **Sync Slaves** on the master

**Note:** Press before pressing **Sync Slaves** on the master instrument.

For details on each key, use key help as described on [page 58](#).

## Understanding the Master/Slave System

### System Delay

The multiple BBG synchronization feature provides a system for synchronizing the waveform generation capability of up to 16 signal generators to within a characteristic value of  $\pm 8$  ns between the master and the last slave. This minor amount of delay ( $\pm 8$  ns) can be reduced further to picosecond resolution by using the **I/Q Delay** softkey located in the **I/Q** menu. To reduce the delay, check and adjust the BBG signal alignment for each signal generator in the system. For more information on adjusting the delay, see **"I/Q Adjustments" on page 267**.

The delay value includes compensation for cables that have less than 1 ns of propagation delay between the **EVENT 1** and **PAT TRIG** connectors (see Equipment Setup). The recommended cable is an Keysight BNC cable, part number 10502A. The use of cables with greater propagation delay may not allow the signal generators to properly synchronize.

## System Synchronization

Synchronization occurs after the master signal generator sends a one-time event pulse that propagates through and to each slave in the system. Prior to this event, each slave must recognize that it is waiting for this event pulse, which occurs during the system configuration (see **“Configuring the Setup” on page 286**). In order to properly send the synchronization pulse, the trigger source and the Dual ARB Player for each signal generator must be turned off.

The master/slave setup does *not* incorporate a feedback system between the slaves and the signal generator selected as the master. After synchronization, if changes occur to the Multi-BBG Sync Setup menu or a signal generator is added to the system, the master does not automatically resynchronize the setup. This may cause the signal generators in the system to incorrectly report their status as **In Sync**.

The system can also misinterpret other signals as the synchronization pulse, which results in an incorrect **In Sync** status. These types of signals include a continuous trigger or an active Marker routed to the EVENT 1 connector. Improperly connected rear panel cables can also create a false status.

You must resynchronize the entire system after making any change in one or all of the Multi-BBG Sync Setup menus, after adding a signal generator to the system, or in doubt as to the true status of a signal generator. Changes to parameters that are outside of the Multi-BBG Sync Setup menu such as waveform files, Dual ARB state, sample rate, scaling, carrier frequency or amplitude have no effect on the system synchronization. To resynchronize a system, see **“Making Changes to the Multiple Synchronization Setup and Resynchronizing the Master/Slave System” on page 288**.

## System Trigger Setup

The multiple BBG synchronization feature restricts the trigger selections (see **page 283**) for each signal generator. For signal generators selected as slaves, you can only modify the trigger type (with restrictions). The trigger source is fixed and set to receive a trigger through the rear panel **PAT TRIG** connector. On the master, you can change both the trigger type (with restrictions) and the trigger source. The trigger source provides three options for triggering the waveforms: external trigger, front panel **Trigger** key, or the GPIB trigger.

If the trigger settings are other than what the BBG synchronization feature supports, the feature changes the trigger settings to what is shown on **page 283**. When this change occurs, the Keysight MXG/EXG generates a settings conflict error to alert you to the changes. To avoid the error generation, appropriately configure the trigger settings prior to selecting a signal generator as the master or slave.

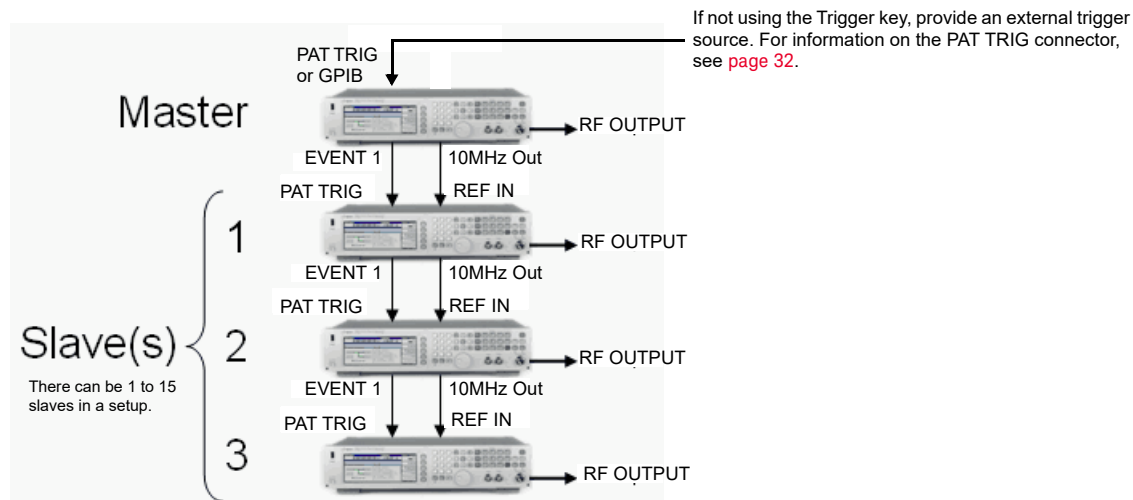
The system trigger propagates in the same manner as the synchronization pulse initiated by the master (see System Synchronization). So if it is not turned off during changes to the synchronization parameters, it can cause a false **In Sync** status.

The signal generator does not reset the trigger parameters when the multiple BBG synchronization feature is turned off. To play waveforms after disabling the feature, you must either set the trigger type to **Free Run** or provide a trigger to start the waveform play back.

## Equipment Setup

Figure 9-29 Multiple Baseband Synchronization Setup

**Note:** To minimize synchronization delay, the Keysight BNC cable 10502A is the recommended cable for the rear panel daisy chain connections (see [page 284](#)).



## Configuring the Setup

### Set the Common Parameters

Perform the following steps on all signal generators:

1. Set the frequency of the carrier signal.
  2. Set the power level of the carrier signal.
  3. Select the desired waveform (see [page 207](#)).
- Do *not* turn the Dual ARB on.
4. Except for triggering, set the desired waveform parameters such as markers and sample clock.

The baseband synchronization feature limits the trigger selections for both the master and slaves. If the current trigger settings include unsupported BBG synchronization parameters, the Keysight MXG/EXG generates a settings conflict error and changes the trigger settings. To avoid the settings conflict error, manually set the trigger parameters as shown on [page 283](#) prior to setting the multiple BBG synchronization parameters.

5. Turn on the RF Output.

### Set the BBG Synchronization Master Parameters

1. Press **Mode** > **Dual ARB** > **ARB Setup** > **More** > **Multi-BBG Sync Setup** > **Multi-Bbg Sync Type** > **Master**.
2. Set the number of slaves using the **Number of Slaves** softkey.
3. If desired, modify the trigger parameters (see [page 283](#)).

The master signal generator allows the modifications of both the trigger type and the trigger source.

- a. Return to the Dual ARB menu (see [page 283](#)).
- b. Set the desired trigger type and source.
- c. Return to the **Multi-BBG Sync Setup** menu.

### Set the BBG Synchronization Slave Parameters

1. Press **Mode** > **Dual ARB** > **ARB Setup** > **More** > **Multi-BBG Sync Setup** > **Multi-BBG Sync Type** > **Slave**.
2. Set the number of Slaves using the **Number of Slaves** softkey.
3. Set the slave position that the signal generator occupies.  
There can be up to fifteen slaves in a system.
4. Press the **Listen for Sync** softkey and verify that `Waiting for Sync` appears in the `Status` area of the display.
5. If desired, select a different trigger type parameter:
  - a. Return to the Dual ARB menu (see [page 283](#)).
  - b. Set the desired trigger type.
  - c. Return to the **Multi-BBG Sync Setup** menu.
6. Repeat for each slave signal generator in the system.

### Synchronize the System

Perform this procedure only after setting the parameters for both the master and slave signal generators. If resynchronizing a system, use the procedure [“Making Changes to the Multiple Synchronization Setup and Resynchronizing the Master/Slave System” on page 288](#).

1. On the master, press the **Sync Slaves** softkey.

#### NOTE

All of the signal generators in the master/slave system must be resynchronized when any changes are made to the master/slave settings or with the addition of a slave instrument, even if `In Sync` appears after pressing the **Listen for Sync** softkey on the slave instruments.

2. On the front panel displays, ensure that all of the signal generators show `In Sync` as the `Status`.

### Trigger and Play the Waveform

1. On all Keysight signal generators, press **Mode** > **Dual ARB** > **ARB Off On** to `On`.
2. Start the trigger signal going to the master signal generator.

## Making Changes to the Multiple Synchronization Setup and Resynchronizing the Master/Slave System

If any changes are made to the master/slave parameters or a signal generator (slave unit) is added to the system, the system must be resynchronized even if *In Sync* appears in the Status portion of the display.

1. Turn off the trigger source. If using the **Trigger** key, there is nothing to turn off.  
If the trigger source is on and provides a continuous pulse stream, it may cause the signal generators to incorrectly display *In Sync* as the status after pressing the **Listen for Sync** softkey.
2. On each of the signal generators, press **Mode > Dual ARB > ARB Off On** to Off.  
If a signal generator(s) has the Dual ARB on during changes, signal generators further in the chain may incorrectly display *In Sync* after pressing the **Listen for Sync** softkey.
3. On each of the signal generators, press **ARB Setup > More > Multi-BBG Sync Setup**.
4. Make the changes in the Multi-BBG Sync Setup menu.  
*Out Of Sync* appears as the status message.
5. On each of the slave signal generators, press **Listen for Sync**.
6. Ensure that all of the slaves' Status show *Waiting for Sync*. If *In Sync* shows as the status, perform the following steps:
  - a. Check that the **PATT TRIG** to **EVENT 1** cables are properly connected on the rear panel.  
A disconnected cable can cause a false *In Sync* status.
  - b. If the cables are connected, perform steps 1 and 2.
  - c. Press **Listen for Sync** and ensure that *Waiting for Sync* appears as the status.
7. On the master signal generator, press **Sync Slaves**.
8. Verify that *In Sync* appears as the status on all master/slave signal generators.
9. Perform the process **“Trigger and Play the Waveform”** on page 287.



## Understanding Option 012 (LO In/Out for Phase Coherency) with Multiple Baseband Generator Synchronization

### NOTE

This section assumes that the previous section on Multiple Baseband Generator Synchronization has been read and understood. If not, refer to **“Multiple Baseband Generator Synchronization” on page 283** before continuing.

The MXG/EXG with Option 012, enables 2x2, 3x3, or 4x4 MIMO configurations to share a common external LO signal to create a phase coherent system (refer also, to **“Multiple Baseband Generator Synchronization” on page 283**).

RF phase coherency may **not** be needed for general STC/MIMO receiver testing, since a MIMO receiver perceives any phase differences between the sources as part of the channel conditions and correct for them. But, RF phase coherency might be desirable for certain applications such as R&D on beamforming systems.

### Configuring the Option 012 (LO In/Out for Phase Coherency) with MIMO

The Keysight BNC cable, part number 10502A, is the recommended cable for the standard multi-BBG synchronization setup, and is recommended for Option 012 too (see also **Figure 9-29 on page 286**). Additionally, for the 2x2, 3x3, and 4x4 MIMO connections from the LO IN and LO OUT to the splitter, additional cables are required (refer to **Table , Figure 9-30 on page 291**, and **Figure 9-31 on page 292**).

### NOTE

Keysight recommends the LO Output be covered when not in use.

When the LO In/Out jumper cable is removed and the instrument is in Dual ARB mode, the instrument is unlevelled and the instrument displays an Unlevel error message.

All test equipment requires a 12 hour warm-up period to ensure accurate performance.

The phase coherent configuration requires the following:

- The recommended LO input drive level should be in the 0 to 6 dBm range.

### NOTE

The 0 to 6 dBm LO input drive level ensures the instruments will operate over the full frequency and over the full 0 to 55 ambient temperature range<sup>a</sup>.

- LO input power requirements vary with temperature; power <0 dBm may work at 20–30 degree ambient temperature conditions. Refer to the **Data Sheet**.

- The I/Q calibration and the self-test must be performed with the LO In/Out jumper cable in place. Where the I/Q calibration cannot be run, the baseband offset can be manually adjusted to minimize the I/Q offsets.

- The phase coherency feature only applies to the Dual ARB modulation mode.
- All cables from the splitter output to the instrument inputs should be of equal lengths.

Table 9-5 Option 012 (LO In/Out for Phase Coherency) Equipment

MIMO Configuration	Part <sup>a</sup>	Cable Length	Notes
2x2	n/a	As required	SMA flexible cables are connected from the power splitter outputs to the LO inputs on the rear panel of both the master and the slave MXG/EXGs. Refer to <b>Figure 9-30 on page 291</b> .
	11636A	n/a	Power Divider, DC to 18 GHz. Refer to <b>www.keysight.com</b> .
3x3	n/a	As required	SMA flexible cables are connected from the power splitter outputs to the LO inputs on the rear panel of the slave MXG/EXGs. Refer to <b>Figure 9-31 on page 292</b> .
	PS3-20-451/12S	n/a	3-Way Pulser Microwave Corp., 3-Way Wilkinson Dividers
4x4	n/a	As required	The SMA flexible cables are connected to the power splitter output to the LO inputs on the rear panel of the slave MXG/EXGs. Refer to <b>Figure 9-31 on page 292</b> .
	PS4-16-452/10S	n/a	4-Way Pulser Microwave Corp., 4-Way Wilkinson Dividers
All	10502A	22.86 cm (9 inches)	Refer to <b>Figure 9-30 on page 291</b> and <b>Figure 9-31 on page 292</b> . See also <b>“Multiple Baseband Generator Synchronization” on page 283</b> .

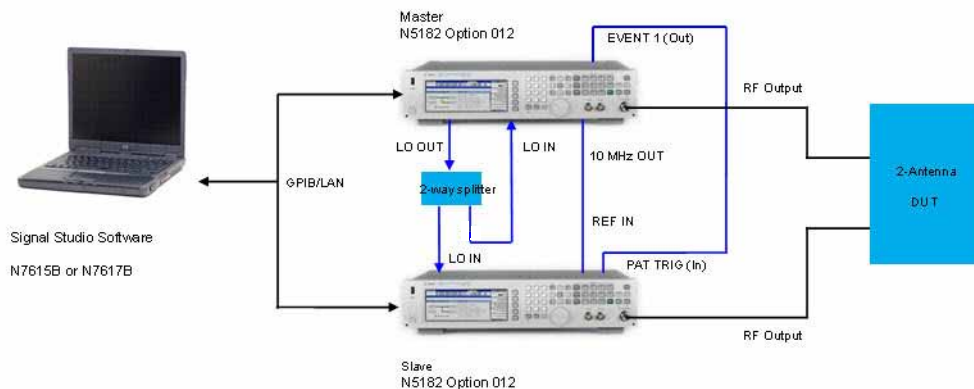
- a. On all of the MIMO configurations, the same length of SMA flexible cables are connected from the splitter output to the inputs on the master and slave instruments. Refer to **Figure 9-30 on page 291** and to **Figure 9-31 on page 292**.

## 2x2 MIMO (LO In/Out for Phase Coherency) Configuration

For the 2x2 MIMO (LO In/Out for phase coherency) setup, the LO from the master MXG/EXG can be run through a power splitter and used as the LO input to both the master and the slave signal generators. No external source is required.

To generate phase coherent signals for a 2x2 MIMO configuration, the master MXG LO OUT is connected via a power splitter to the slave LO IN. The LO OUT provides a sufficient amplitude LO signal when connected directly, to drive the Slave MXG/EXG(s), thus providing phase coherency for the RF output signals. In this example, we show two MXG signal generators with Option 012 connected for a phase coherent 2x2 MIMO solution. Refer to [Figure 9-30](#).

**Figure 9-30** 2x2 MIMO (LO In/Out for Phase Coherency) Equipment Setup



Note:

To optimize the phase coherence, the same length SMA flexible cable is recommended for the *output* of the 2-way splitter connections to the LO IN of the signal generator

## 3x3 and 4x4 MIMO (LO In/Out for Phase Coherency) Configurations

For a 3x3 and 4x4 MIMO (LO In/Out for phase coherency) setups, an additional analog source is needed to provide the higher LO power required by the power splitter and the additional instruments.

Splitting the LO output four ways causes too much loss to drive the LO input of the N5172B/82Bs in the system. Also, there is no amplitude adjustment to the LO output of the N5172B/82B. To generate phase coherent signals for 3x3 and 4x4 configurations with the MXG/EXG, an external Master LO is needed to provide a sufficient amplitude LO input signal to the vector MXG/EXGs (refer to [Figure 9-31 on page 292](#)).

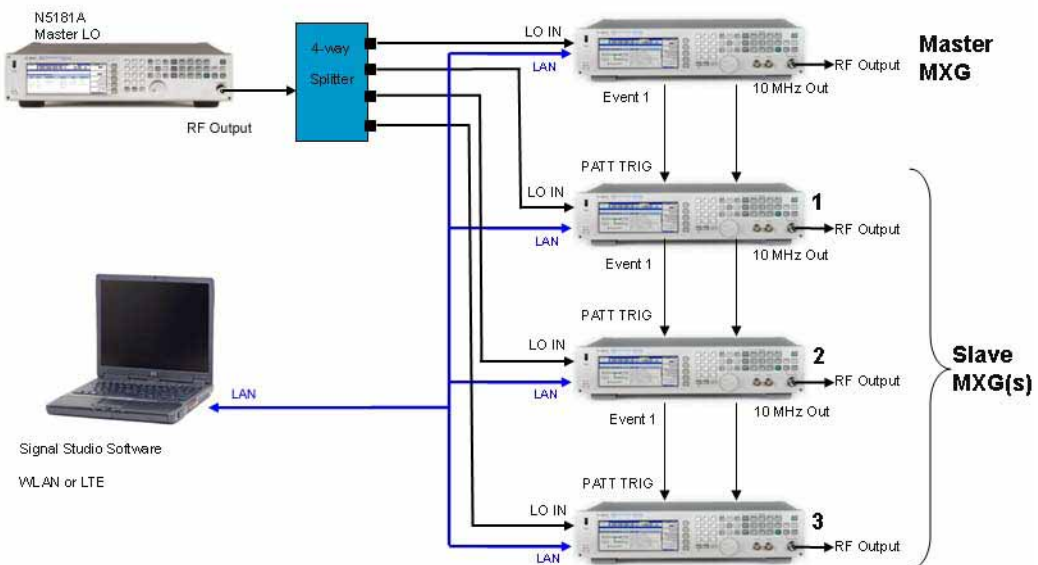
### NOTE

The Master LO is not controlled by any of the Signal Studio software, but must be set manually—via the RF frequency settings on the master signal generator—by the user to the desired frequency and amplitude.

Figure 9-31 3x3 and 4x4 MIMO (LO In/Out for Phase Coherency) Equipment Setup

Note:

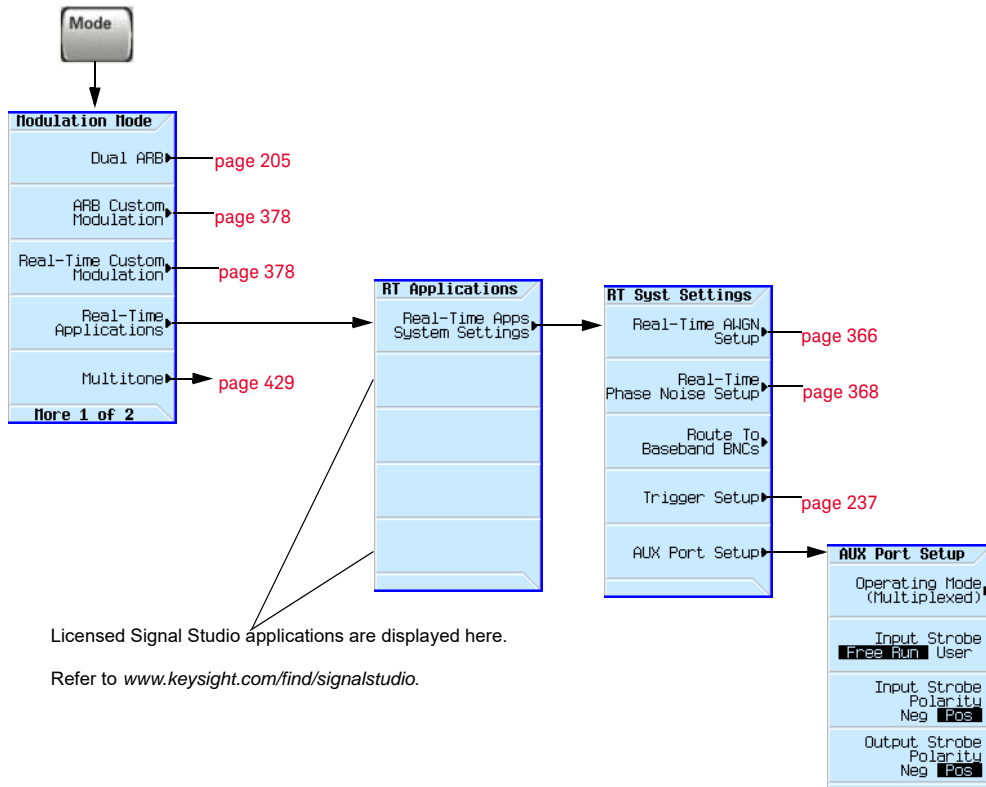
A SMA flexible cable is recommended for the *input* to the 4-way splitter connections to the LO IN and LO OUT of the instruments with Option 012 (see [page 289](#)).



# Real-Time Applications

The Keysight X-Series signal generators provide access to several real-time applications for signal creation.

Figure 9-32 Real-Time Applications Softkeys



For details on each key, use key help as described on page 58.

## Waveform Licensing

Waveform licensing enables you to license waveforms that you generate and download from any Signal Studio application for unlimited playback in a signal generator. Each licensing option (221-229) allows you to permanently license up to five waveforms or (250-259) allows you to permanently license up to 50 waveforms of your choice (i.e. Waveform Option 22x or Option 25x are **perpetual fixed** waveform licenses).

Waveforms licensed with Options 221-229 or Options 250-259 cannot be **exchanged for different waveforms**. Once a waveform is licensed, that license is permanent and cannot be revoked or replaced. Option 22x and 25x waveform licenses are signal generator specific (i.e. signal generator serial number specific). If a licensed Option 22x or Option 25x waveform file is transferred to another signal generator, the file must be licensed by a separate Option 22x or Option 25x that is in the other signal generator **before** it can be played.

To redeem Option 22x or Option 25x, refer to the **N5182B-2xx Entitlement Certificate** that comes with the N5182B-2xx order. For more information on extracting and downloading waveform files, refer to the **Programming Guide**.

## Understanding Waveform Licensing

Use any N76xxB Signal Studio software to build and download waveforms to the signal generator. Each Option 22x provides 5 available slots and Option 25x license provides 50 available slots, where you can add and play waveforms for a trial period of 48 hours per slot. During this time, you can replace the waveform any number of times until you are satisfied with it. After the trial period expires, the waveform in the slot is no longer playable until the slot is locked for permanent playback; however, you can replace the waveform in the slot with another waveform of your choice before locking the slot.

To license additional waveforms that exceed the number permitted by an Option 22x or Option 25x, you must purchase another Option 22x or Option 25x that you do **not** already own. For example, if you already own Option 250, purchase Option 251 to add an additional 50 slots. Adding all options, 250-259, provides a maximum of 500 slots. Adding all options, 221-229, provides a maximum of 45 slots. (Repurchasing the same option for the **same** signal generator, gives you no additional Waveform licenses.)

## Installing an Option N5182-22x or Option N5182B-25x

Load a Waveform License, Option N5182-22x or Option N5182B-25x, into the signal generator using License Manager or a USB media. For more information on loading the Waveform License, refer to the **N5182B-2xx Entitlement Certificate** included with your order.

## Licensing a Signal Generator Waveform

Create and download a waveform into the signal generator using any of the N76xxB Signal Studio software. Refer to your Signal Studio software help if you need assistance using the application.

Refer to **page 299** for steps in adding the waveform to a license slot for a 48-hour trial period. During the trial period, the waveform can be played and replaced any number of times. When the trial time expires, the slot can no longer be used for playback until the slot is locked for permanent playback capability.

## Waveform Licensing Softkeys Overview

Figure 9-33 Waveform Licensing Softkeys

Mode > Dual ARB > More

Note: Waveforms licensed with Option 2xx cannot be exchanged for other waveforms. Once a waveform is locked into a license slot, that license is permanent and cannot be revoked or replaced.

This softkey is only available if there is an Option 2xx license installed on the instrument. Pressing this softkey displays the licensing status and associated filename for each slot and accesses the waveform licensing menu selections.

Note: When Waveform Licensing is first accessed, all slots appear as **Available**. For licensing status descriptions after waveforms have been added to a slot, refer to [Table 9-6 on page 297](#).

This softkey allows you to add a waveform that you select to the first available slot. Refer to [page 296](#).

This softkey allows you to replace a waveform in the selected slot. Refer to [page 297](#).

This softkey clears the waveform from the selected slot.

This softkey allows you to lock a waveform into a slot. After the trial period has expired, the waveform must be locked in order to be able to play the waveform. Refer to [page 297](#).

This softkey allows you to select a specific slot where you want to add, replace, or clear a waveform. You can also select a slot by using the front panel arrow keys or by scrolling to the slot. Refer to [page 296](#).

Waveform Slot	Status	Filename
1	Remaining Trial Time 47:42	
2	Remaining Trial Time 47:54	802_11AC_160MHZ_2550.WFM
3	Available	
4	Available	
5	Available	
6	Available	
7	Available	
8	Available	
9	Available	
10	Available	

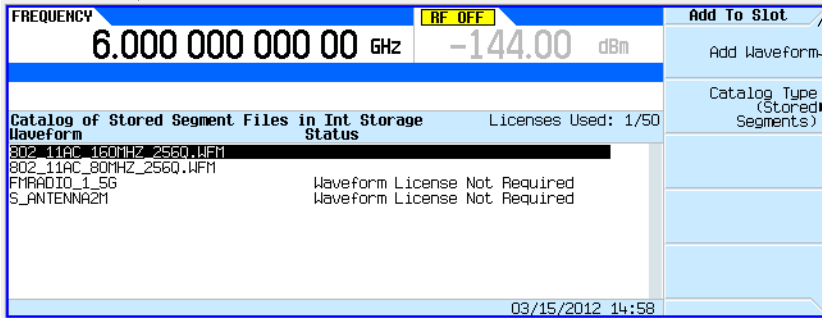
Refer to the SCPI Command Reference for related license commands.  
[page 297](#)

For details on each key, use key help as described on [page 58](#).

Figure 9-34 Waveform Licensing Softkeys

Mode > Dual ARB > More >  
Waveform Licensing > Add  
Waveform to First Available Slot  
or  
Mode > Dual ARB > More >  
Waveform Licensing > Replace  
Waveform in Slot

Note: Waveforms licensed with Option 2xx cannot be "exchanged". Once a slot is locked, that license for the waveform in the locked slot is permanent and cannot be revoked or replaced.

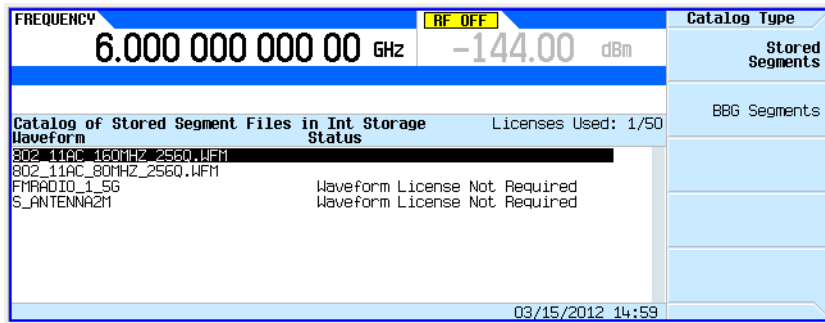


The softkey is greyed out, if a waveform is already licensed or does not require licensing.

To select a waveform, use the arrow keys to highlight the waveform and then press **Add Waveform**.

Refer to the SCPI Command Reference for related License Commands.

The waveform to be added or replaced can be selected from BBG memory, internal storage, or a USB device.



This softkey displays a catalog of the waveform segments stored in the **Int Storage** or **USB Media**.

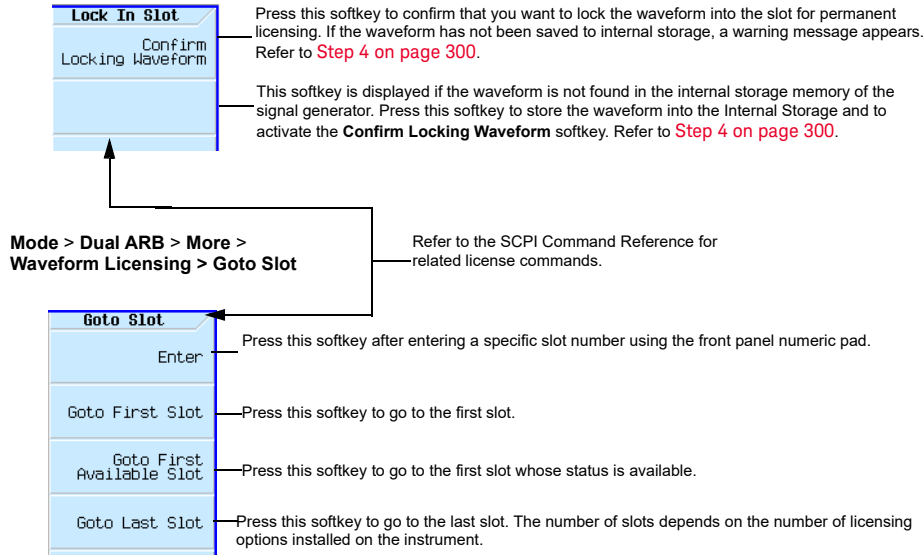
This softkey displays a catalog of the waveforms stored in the **BBG memory**.

For details on each key, use key help as described on [page 58](#).

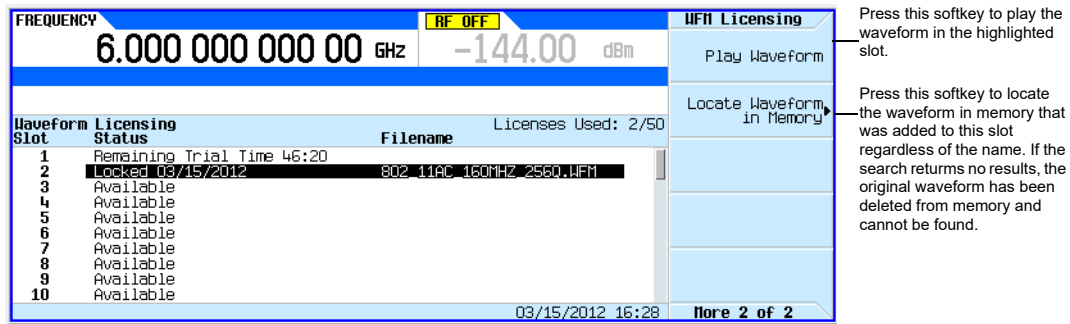


Figure 9-35 Waveform Licensing Softkeys

Mode > Dual ARB > More > Waveform Licensing  
> Lock Waveform in Slot



Mode > Dual ARB > More > Waveform Licensing > More > More



For details on each key, use key help as described on [page 58](#).

Table 9-6 Waveform Licensing Slot Status Messages

Status Column	Meaning	Notes
Available	The slot has never had a waveform added to it.	50 slots are initially available for each Option 25x. 5 slots are initially available for each Option 22x.

Table 9-6 Waveform Licensing Slot Status Messages

Status Column	Meaning	Notes
Locked MM/DD/YY	The slot is locked and can no longer be modified.	The waveform in this slot is licensed to this signal generator for unlimited playback.
Remaining Trial Time HH:MM	The slot is in a trial period that is available for 48 hours that begins when a waveform is added.	During the trial period, the waveform in this slot can be played, cleared, or replaced with another waveform.
Lock Required	The trial period for the slot has expired but the slot has not been locked.	The slot can be cleared or replaced with a different waveform but the waveform cannot be played until the slot is locked. A trial period is no longer available.

### Example: Licensing a Signal Studio Waveform

The following steps add a waveform file to a license slot and lock the slot for permanent playback.

#### 1. Press **Mode > Dual ARB > More > Waveform Utilities > Waveform Licensing**

The signal generator displays a catalog of files labeled: **Catalog of BBG Segment Files in BBG Memory**.

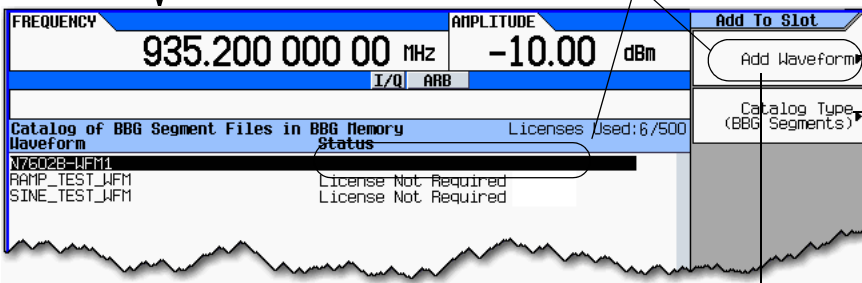
#### 2. Use the arrow keys to highlight and select the file to be licensed.

#### 3. Press **Add Waveform** to add the selected waveform to the first available slot.

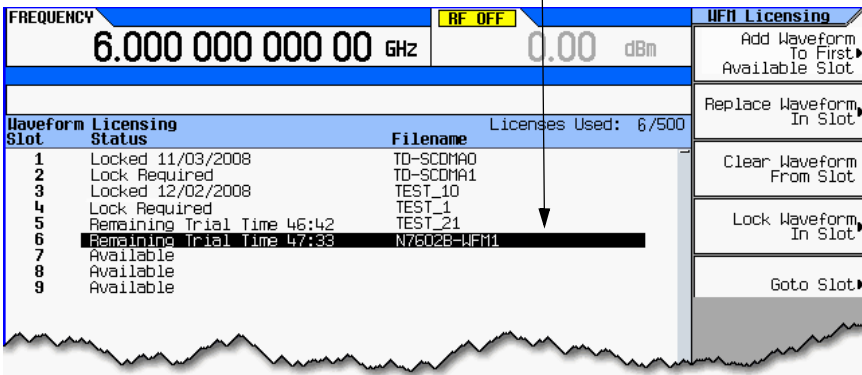
**Figure 9-36 Add Waveform**

**Mode > Dual ARB > More > Waveform Licensing > Add Waveform to First Available Slot**

Status area for the waveform N7602B-WFM1 is *empty* and the **Add Waveform** softkey is active, indicating the waveform is licensable.



page 296



The selected waveform is added to the first available slot. The trial time for the slot begins as soon as the waveform is added. During the 48 hour trial period, the waveform can be played and replaced any number of times. When the trial time expires, the licensing status of the slot changes to **Lock Required** after which the waveform can no longer be played until the slot is locked.

4. License the waveform:

a. Press **Lock Waveform in Slot**.

A warning is displayed: **\*\*\* Waveform Lock Warning!!! \*\*\***. **If necessary, verify you have selected the correct waveform you want for licensing by pressing Return.**

Figure 9-37 Waveform Lock Warning



b. Press **Confirm Locking Waveform**.

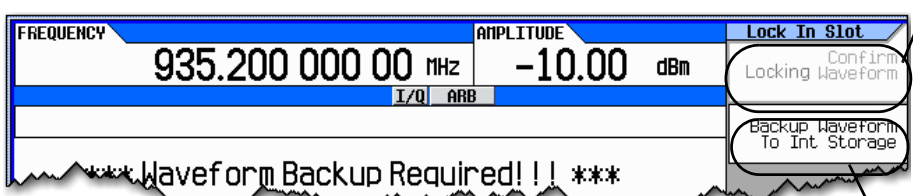
The licensing status of the slot will be changed to Locked MM/DD/YY.

c. If the waveform has not been previously backed up in internal storage, a warning is displayed: **\*\*\* Waveform Backup Required!!! \*\*\***.

d. Make a backup copy of this waveform on a USB media or a computer before pressing **Backup Waveform to Int Storage**. **(If the waveform is lost or deleted on the signal generator, it cannot be recovered).**

Figure 9-38 Backup Waveform To Int Storage softkey

The **Confirm Locking Waveform** softkey remains inactive until the waveform is stored in internal storage.



Press this softkey to store the waveform into the internal storage and to activate the **Confirm Locking Waveform** softkey.

**CAUTION**

It is important that you make a **backup** copy of any waveforms that you are licensing. **Do not store the backup copy on the signal generator. If all copies of the waveforms are deleted or lost, there is no way to recover the waveform or reassign the license. Refer to “Working with Files” on page 74.**

## Waveform Licensing Warning Messages

Figure 9-39

The figure displays four sequential warning messages from a signal generator's interface, each with a title, a description, and a required action:

- Warning 1: \*\*\* Waveform Lock Warning! ! ! \*\*\***  
 Once a waveform is locked it will use up an available license slot and it can not be un-locked. Be sure that you want to lock this waveform.  
**Important! Keep a backup copy of the waveform elsewhere in case you delete all files in Int Storage**
- Warning 2: \*\*\* Waveform Backup Required! ! ! \*\*\***  
 Waveform backup required. The waveform can not be licensed until it is copied to non-volatile memory.  
**You must back up the waveform to non-volatile memory**
- Warning 3: \*\*\* Waveform Backup Failed! ! ! \*\*\***  
 Waveform backup failed. The waveform could not be copied to non-volatile memory. There may not be enough free memory.  
**You must free enough non-volatile memory to copy the waveform before you can license it.**
- Warning 4: \*\*\* Waveform File is Missing! ! ! \*\*\***  
 The waveform file in the selected slot is no longer in instrument memory.  
**You must either clear or replace the waveform for this slot or load the missing file into instrument memory before you can license it.**

This standard warning is displayed every time a waveform is selected to be locked. This notification indicates that one of the available "license slots" is about to be used from Option 2xx. ALWAYS make backup copies of waveforms in a *separate* non-volatile memory in case a file is deleted or lost from the instrument's internal storage.

This warning is displayed when an attempt is made to lock a waveform that has *not* been saved to internal storage or USB media (i.e. waveforms cannot be locked unless they have been stored to non-volatile memory). Press the **Backup Waveform To Int Storage** softkey.

This warning is displayed when there is insufficient memory or other problems with the internal storage, or USB media (non-volatile memory) and the waveform could not be saved to non-volatile memory.

This warning is displayed when the waveform file cannot be found in BBG or internal storage. You must ensure that the waveform still resides in the instrument before you can lock it.



## 10 Digital Signal Interface Module (Option 003/004)

This chapter provides information on the N5102A Baseband Studio Digital Signal Interface Module. These features are available only in N5172B/82B Vector Signal Generators with Options 003/004 and 653/655/656/657. The following list shows the topics covered in this chapter:

- **Clock Timing** on page 304
- **Data Types** on page 317
- **Connecting the Clock Source and the Device Under Test** on page 315
- **Operating the N5102A Module in Output Mode** on page 318
- **Operating the N5102A Module in Input Mode** on page 328

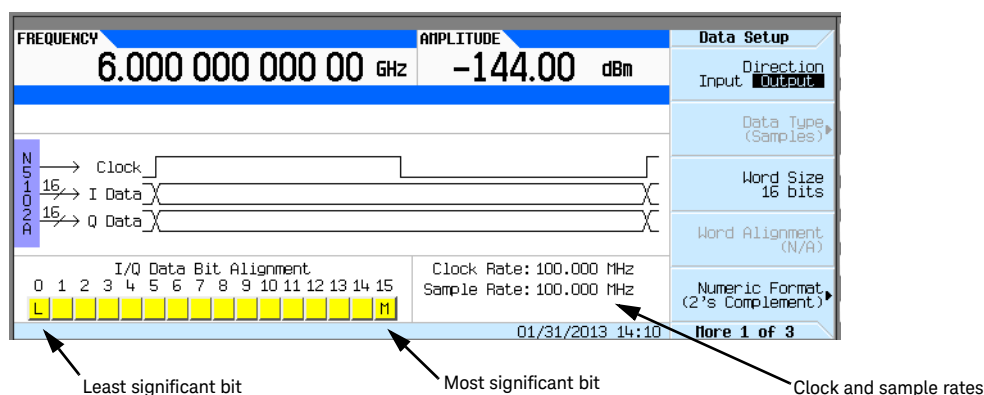
## Clock Timing

This section describes how clocking for the digital data is provided. Clock timing information and diagrams are supplied for the different port configurations (serial, parallel, or parallel interleaved data transmission) and phase and skew settings. All settings for the interface module are available on the signal generator user interface (UI).

### Clock and Sample Rates

A sample is a group of bits where the size of the sample is set using the **Word Size** softkey. The clock is the signal that tells when the bits of a sample are valid (in a non-transition state). The clock and sample rates are displayed in the first-level and data setup softkey menus. The clock rate and sample rate are usually the same. They will differ when serial mode is selected, or when there are multiple clocks per sample.

Figure 10-1 Data Setup Menu for a Parallel Port Configuration



The N5102A module clock rate is set using the **Clock Rate** softkey and has a range of 1 kHz to 400 MHz. The sample rate is automatically calculated and has a range of 1 kHz to 200 MHz. These ranges can be smaller depending on logic type, data parameters, and clock configuration.

### Maximum Clock Rates

The N5102A module maximum clock rate is dependent on the logic and signal type. **Table 10-1** and **Table 10-2** show the warranted rates and the maximum clock rates for the various logic and signal types. Notice that LVDS in the output mode using an IF signal is the only logic type where the warranted and maximum rates are the same.

Table 10-1 Warranted Parallel Output Level Clock Rates and Maximum Clock Rates

Logic Type	Warranted Level Clock Rates		Maximum Clock Rates (typical)	
	IQ Signal Type	IF Signal Type <sup>1</sup>	IQ Signal Type	IF Signal Type
LVTTTL and CMOS	100 MHz	100 MHz	150 MHz	150 MHz
LVDS	200 MHz	400 MHz	400 MHz	400 MHz



1. The IF signal type is not available for a serial port configuration.

Table 10-2 Warranted Parallel Input Level Clock Rates and Maximum Clock Rates

Logic Type	Warranted Level Clock Rates	Maximum Clock Rates (typical)
LVTTL and CMOS	100 MHz	150 MHz
LVDS	200 MHz	200 MHz

The levels will degrade above the warranted level clock rates, but they may still be usable.

### Serial Port Configuration Clock Rates

For a serial port configuration, the lower clock rate limit is determined by the word size (word size and sample size are synonymous), while the maximum clock rate limit remains constant at 150 MHz for LVTTL and CMOS logic types, and 400 MHz for an LVDS logic type.

The reverse is true for the sample rate. The lower sample (word) rate value of 1 kHz remains while the upper limit of the sample rate varies with the word size. For example, a five-bit sample for an LVTTL or CMOS logic type yields the following values in serial mode:

- Clock rate of 5 kHz through 150 MHz
- Sample rate of 1 kHz through 30 MHz

Refer to [Table 10-3](#) and [Table 10-4](#), for the serial clock rates.

Table 10-3 Output Serial Clock Rates

Logic Type	Minimum Rate	Maximum Rate
LVDS	1 x (word size) kHz	400 MHz
LVTTL and CMOS	1 x (word size) kHz	150 MHz

Table 10-4 Input Serial Clock Rates

Logic Type	Data Type	Minimum Rate	Maximum Rate
LVDS	Samples	1 x (word size) kHz	400
	Pre-FIR Samples	1 x (word size) kHz	the smaller of: $50^1 \times (\text{word size})$ MHz or 400 MHz
LVTTL and CMOS	N/A	1 x (word size) kHz	150 MHz

1. The maximum sample rate depends on the selected filter when the data rate is Pre-FIR Samples. Refer to [“Input Mode” on page 317](#) for more information.

## Parallel and Parallel Interleaved Port Configuration Clock Rates

Parallel and parallel interleaved port configurations have other limiting factors for the clock and sample rates:

- logic type
- Clocks per sample selection
- IQ or IF digital signal type

Clocks per sample (clocks/sample) is the ratio of the clock to sample rate. For an IQ signal type, the sample rate is reduced by the clocks per sample value when the value is greater than one. For an IF signal or an input signal, clocks per sample is always set to one. Refer to **Table 10-5** for the Output mode parallel and parallel interleaved port configuration clock rates.

Table 10-5 Output Parallel and Parallel Interleaved Clock Rates

Logic Type	Signal Type	Minimum Rate	Maximum Rate
LVDS	IQ	1 x (clocks/sample) kHz	the smaller of: 100 x (clocks /sample) MHz or 400 MHz
	IF	4 kHz	400 MHz
Other	IQ	1 x (clocks/sample) kHz	the smaller of: 100 x (clocks /sample) MHz or 150 MHz
	IF	4 kHz	150 MHz

For Input mode, the maximum clock rate is limited by the following factors:

- sample size
- data type

Refer to **Table 10-6** for the Input mode parallel and parallel interleaved port configuration clock rates.

Table 10-6 Input Parallel and Parallel Interleaved Clock Rates

Logic Type	Data Type	Minimum Rate	Maximum Rate
N/A	Samples	1 kHz	200 MHz
	Pre-FIR Samples	1 kHz	100 MHz

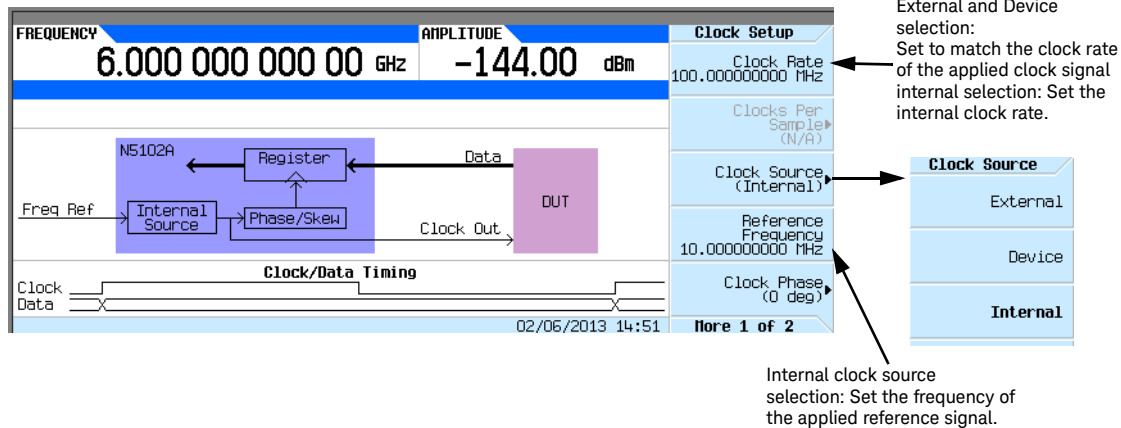
## Clock Source

The clock signal for the N5102A module is provided in one of three ways through the following selections:

- Internal: generated internally in the interface module (requires an external reference)
- External: generated externally through the Ext Clock In connector
- Device: generated externally through the Device Interface connector

The clock source is selected using the N5102A module UI on the signal generator, see [Figure 10-2](#).

Figure 10-2 Clock Source Selection



When you select a clock source, you must let the N5102A module know the frequency of the clock signal using the **Clock Rate** softkey. In the internal clock source mode, use this softkey to set the internal clock rate. For device and external clock sources, this softkey must reflect the frequency of the applied clock signal.

When the clock source is Internal, a frequency reference must be applied to the Freq Ref connector. The frequency of this applied signal needs to be specified using the **Reference Frequency** softkey, unless the current setting matches that of the applied signal.

The selected clock source provides the interface module output clock signal at the Clock Out and the Device Interface connectors.

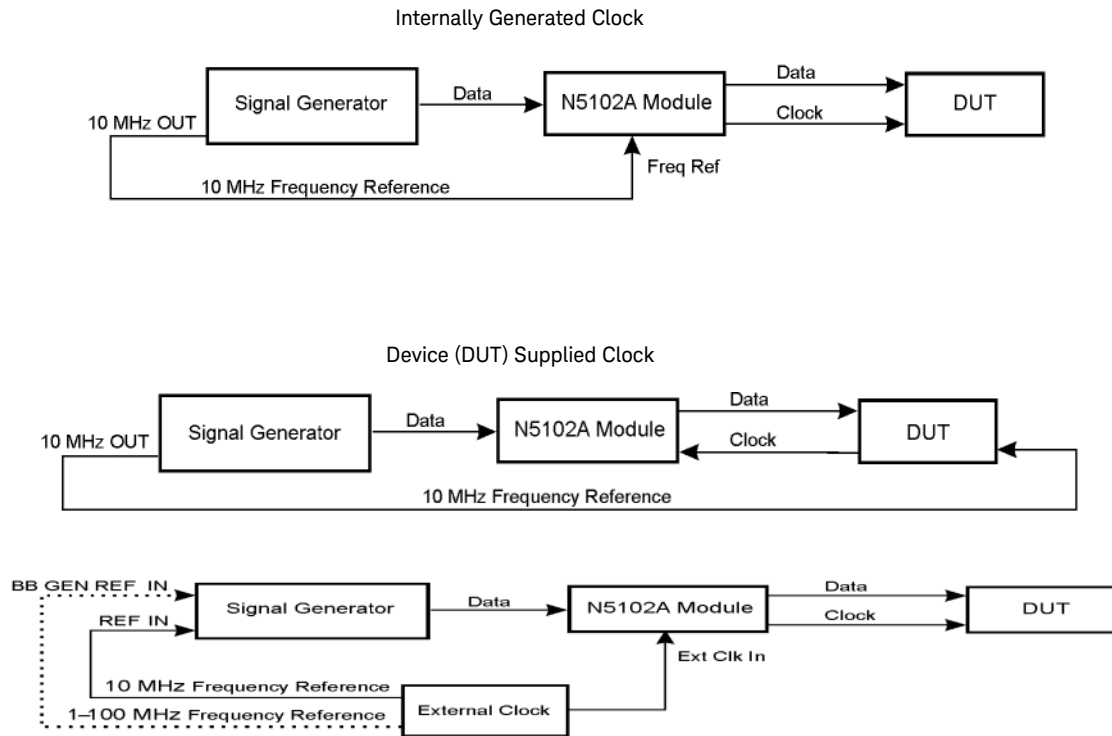
## Common Frequency Reference

The clocking flexibility of the digital signal interface module allows the setting of arbitrary clock rates for the device under test. In general, the clock rate inside the signal generator will be different from the interface module clock rate, so the interface module performs a rate conversion. An important aspect of this conversion is to have accurate clock rate information to avoid losing data. The module relies on relative clock accuracy, instead of absolute accuracy, that must be ensured by using a single frequency reference for all clock rates involved in the test setup. This can be implemented in various ways (see the five drawings in [Figure 10-3 on page 308](#)), but whatever way it is implemented, the clock inside the signal generator must have the same base frequency reference as the clock used by the device under test.

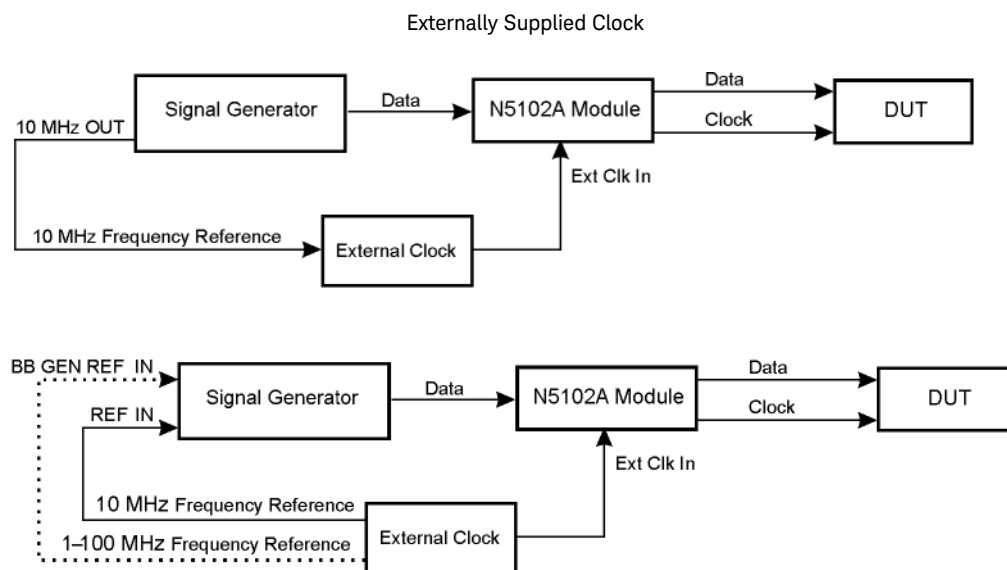
## Signal Generator Frequency Reference Connections

When a frequency reference is connected to the signal generator, it is applied the REF In rear panel connector.

Figure 10-3 Frequency Reference Setup Diagrams for the N5102A Module Clock Signal



**NOTE:** Use only one of the two signal generator frequency reference inputs.

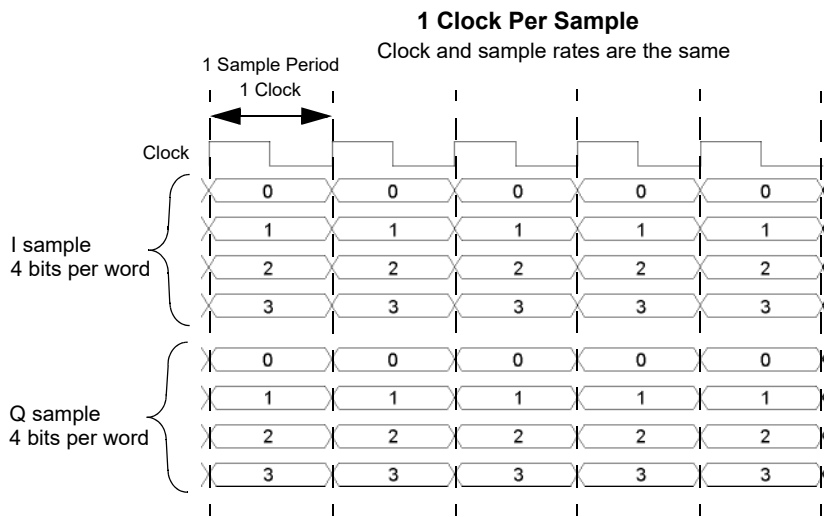


**NOTE:** Use only one of the two signal generator frequency reference inputs.

## Clock Timing for Parallel Data

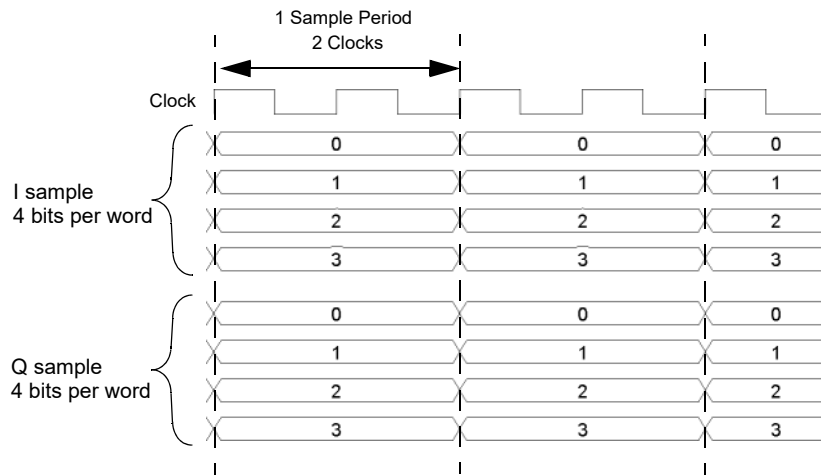
Some components require multiple clocks during a single sample period. (A sample period consists of an I and Q sample). For parallel data transmissions, you can select one, two, or four clocks per sample. For clocks per sample greater than one, the I and Q samples are held constant to accommodate the additional clock periods. This reduces the sample rate relative to the clock rate by a factor equal to the clocks per sample selection. For example, when four is selected, the sample rate is reduced by a factor of four (sample rate to clock rate ratio). **Figure 10-4** demonstrates the clock timing for each clocks per sample selection. For input mode, the clocks per sample setting is always one.

**Figure 10-4** Clock Sample Timing for Parallel Port Configuration



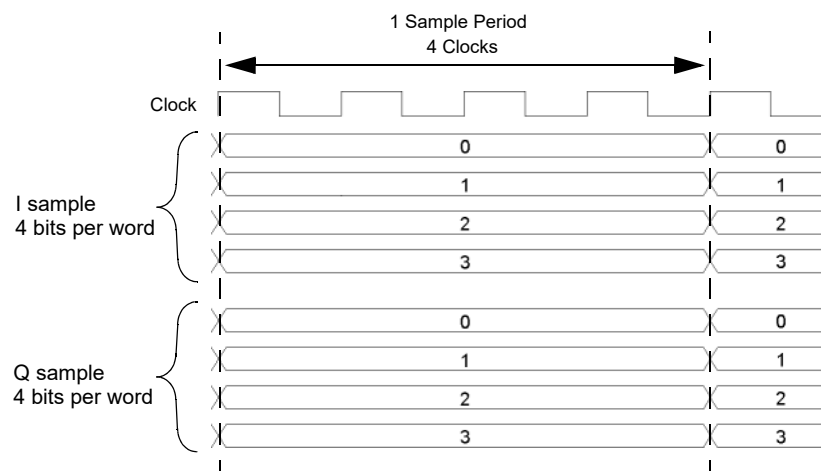
### 2 Clocks Per Sample

Sample rate decreases by a factor of two



### 4 Clocks Per Sample

Sample rate decreases by a factor of four



## Clock Timing for Parallel Interleaved Data

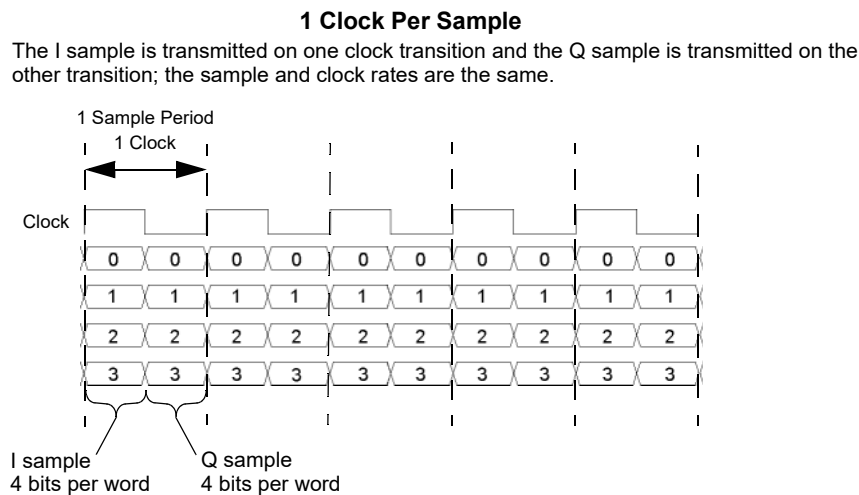
The N5102A module provides the capability to interleave the digital I and Q samples. There are two choices for interleaving:

- IQ, where the I sample is transmitted first
- QI, where the Q sample is transmitted first

When parallel interleaved is selected, all samples are transmitted on the I data lines. This effectively transmits the same number of samples during a sample period on half the number of data lines as compared to non-interleaved samples. (A sample period consists of an I and Q sample.) Clocks per sample is still a valid parameter for parallel interleaved transmissions and creates a reduction in the sample rate relative to the clock rate. The clocks per sample selection is the ratio of the reduction.

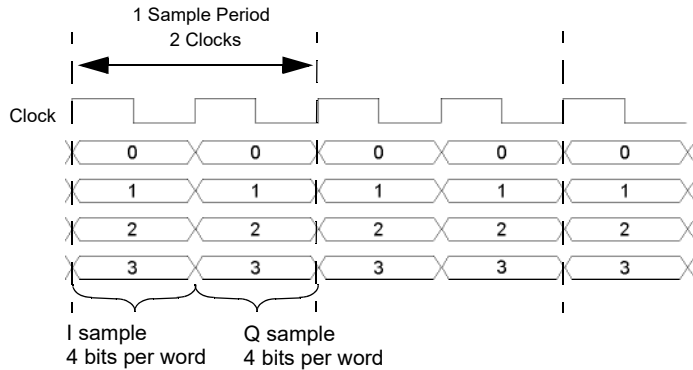
**Figure 10-5** shows each of the clocks per sample selections, for a parallel IQ interleaved port configuration, using a word sized of four bits and the clock timing relative to the I and Q samples. For a parallel QI interleaved port configuration, just reverse the I and Q sample positions. For input mode, the clocks per sample setting is always one.

**Figure 10-5** Clock Timing for a Parallel IQ Interleaved Port Configuration



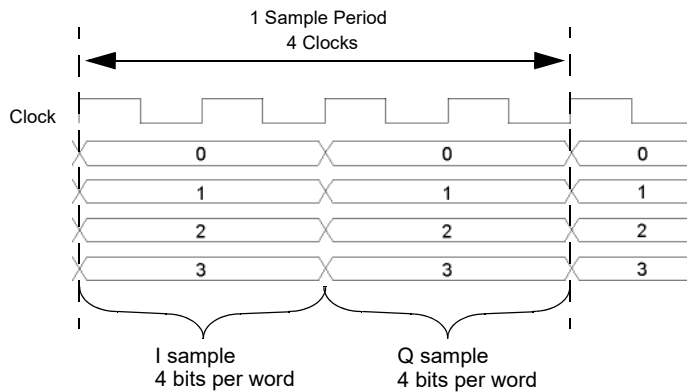
### 2 Clocks Per Sample

The I sample is transmitted for one clock period and the Q sample is transmitted during the second clock period; the sample rate decreases by a factor of two.



### 4 Clocks Per Sample

The I sample is transmitted for the first two clock periods and the Q sample is transmitted during the second two clock periods; the sample rate is decreased by a factor of four.

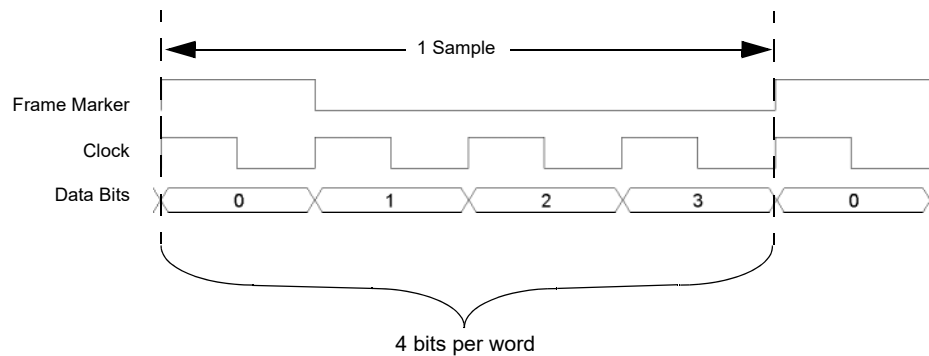


## Clock Timing for Serial Data

**Figure 10-6** shows the clock timing for a serial port configuration. Notice that the serial transmission includes frame pulses that mark the beginning of each sample where the clock delineates the beginning of each bit. For serial transmission, the clock and the bit rates are the same, but the sample rate varies depending on the number of bits per word that are entered using the **Word Size** softkey. The number of bits per word is the same as the number of bits per sample.



Figure 10-6 Clock Timing for a Serial Port Configuration



### Clock Timing for Phase and Skew Adjustments

The N5102A module provides phase and skew adjustments for the clock relative to the data and can be used to align the clock with the valid portion of the data. The phase has a 90 degree resolution (0, 90, 180, and 270 degree selections) for clock rates from 10 to 200 MHz and a 180 degree resolution (0 and 180 degree selections) for clock rates below 10 MHz and greater than 200 MHz.

The skew is displayed in nanoseconds with a maximum range of  $\pm 5$  ns using a maximum of  $\pm 127$  discrete steps. Both the skew range and the number of discrete steps are variable with a dependency on the clock rate. The skew range decreases as the clock rate is increased and increases as the clock rate is decreased. The maximum skew range is reached at a clock rate of approximately 99 MHz and is maintained down to a clock rate of 25 MHz. For clock rates below 25 MHz, the skew adjustment is unavailable.

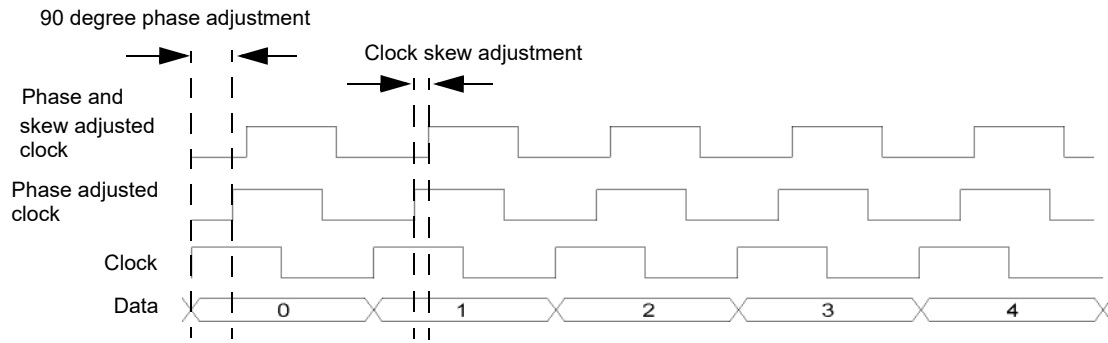
A discrete step is calculated using the following formula:

$$\frac{1}{256 \times \text{Clock Rate}}$$

The number of discrete steps required to reach the maximum skew range decreases at lower frequencies. For example, at a clock rate of 50 MHz, 127 steps would exceed the maximum skew range of  $\pm 5$  ns, so the actual number of discrete steps would be less than 127.

**Figure 10-7** is an example of a phase and skew adjustment and shows the original clock and its phase position relative to the data after each adjustment. Notice that the skew adjustment adds to the phase setting.

Figure 10-7 Clock Phase and Skew Adjustments



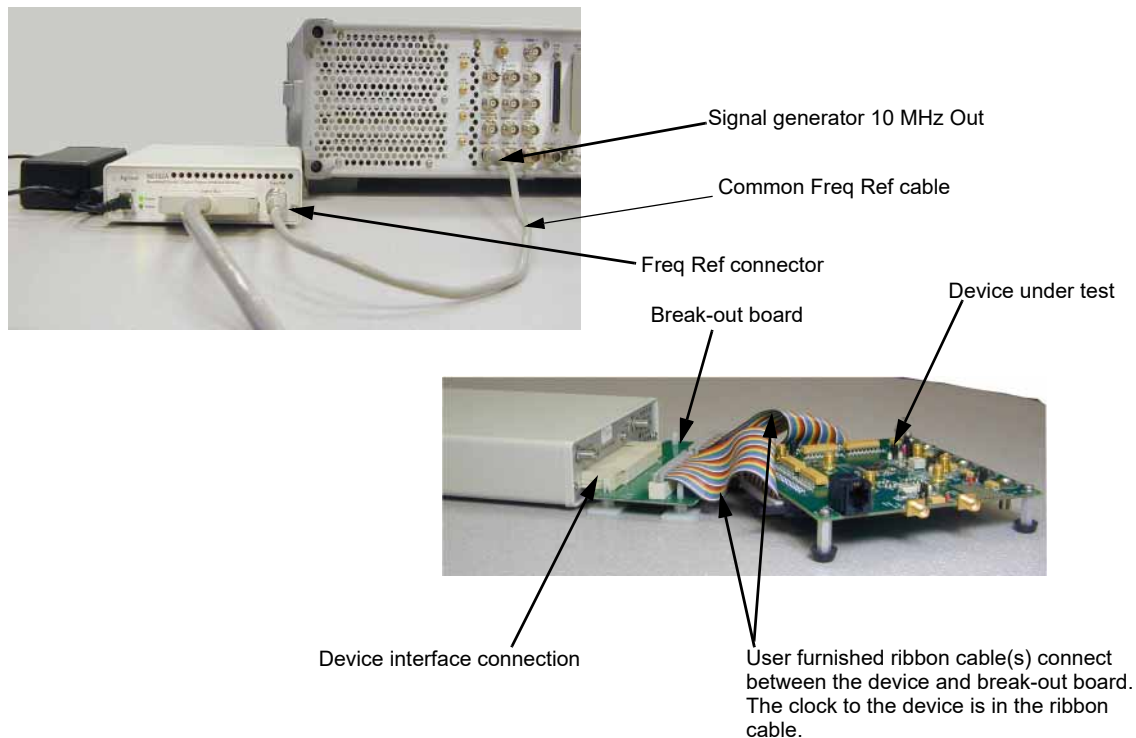
## Connecting the Clock Source and the Device Under Test

As shown in **Figure 10-3 on page 308**, there are numerous ways to provide a common frequency reference to the system components (signal generator, N5102A module, and the device under test). **Figure 10-8** shows an example setup where the signal generator supplies the common frequency reference and the N5102A module is providing the clock to the device.

### CAUTION

The Device Interface connector on the interface module communicates using high speed digital data. Use ESD precautions to eliminate potential damage when making connections.

Figure 10-8 Example Setup using the Signal Generator 10 MHz Frequency Reference



### NOTE

You must disconnect the digital bus cable and the digital module while downloading firmware to the signal generator.

1. Refer to the five setup diagrams in **Figure 10-3 on page 308** and connect the frequency reference cable according to the clock source.
2. If an external clock source is used, connect the external clock signal to the Ext Clock In connector on the interface module.

3. Select the break-out board that has the output connector suited for the application.

**NOTE**

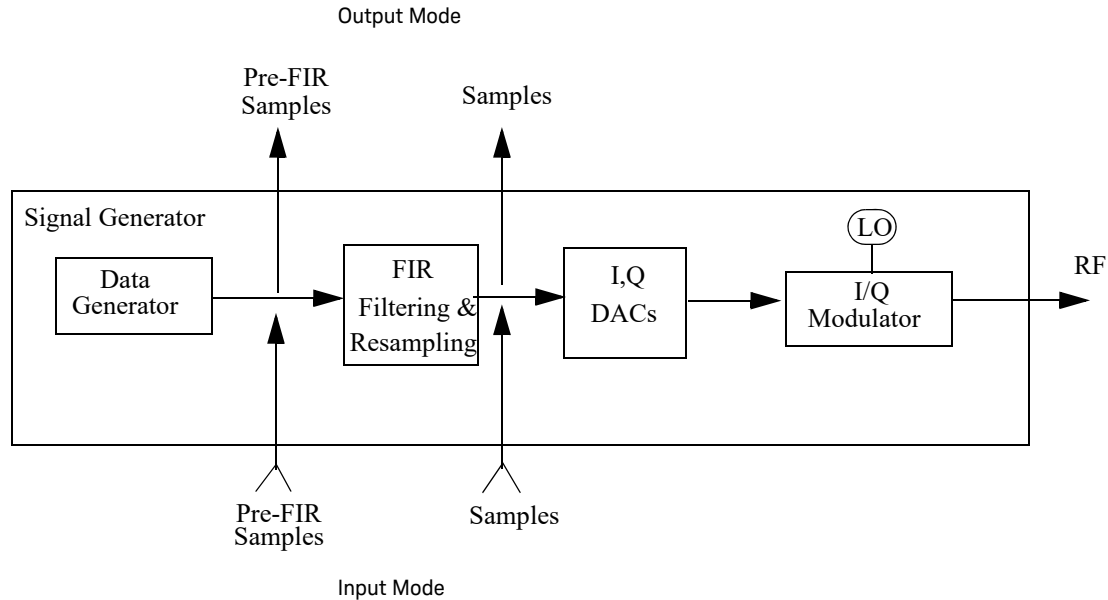
If the Device Interface mating connector is used with the device under test, refer to [Figure 10-8](#) for the device interface connection and connect the device to the N5102A module. Then proceed to [“Operating the N5102A Module in Output Mode” on page 318](#) or [“Operating the N5102A Module in Input Mode” on page 328](#).

---

4. Refer to [Figure 10-8](#). Connect the break-out board to the Device Interface connector on the N5102A module.
5. Connect the device to the break-out board.

## Data Types

The following block diagram indicates where in the signal generation process the data is injected for input mode or tapped for output mode.



### Output Mode

When using an ARB format with no real-time modulation filter, the data type is always Samples and no filtering is applied to the data samples. The samples are sent to the digital module at the ARB sample clock rate and resampled.

For real-time formats or Dual ARB with a real-time modulation filter, choosing Samples as the data type will send filtered samples to the digital module at the module's clock rate. Selecting Pre-FIR Samples, sends unfiltered but potentially resampled samples to the module at the module's clock rate.

### Input Mode

When the data type is Samples, the data samples coming through the digital module are injected at a point that bypasses the filtering process.

If Pre-FIR Samples is selected, the data samples are injected before the filtering process.

The **Filter** softkey accesses a menu that enables you to set the desired filtering parameters.

## Operating the N5102A Module in Output Mode

This section shows how to set the parameters for the N5102A module using the signal generator UI in the output direction. Each procedure contains a figure that shows the softkey menu structure for the interface module function being performed.

### Setting up the Signal Generator Baseband Data

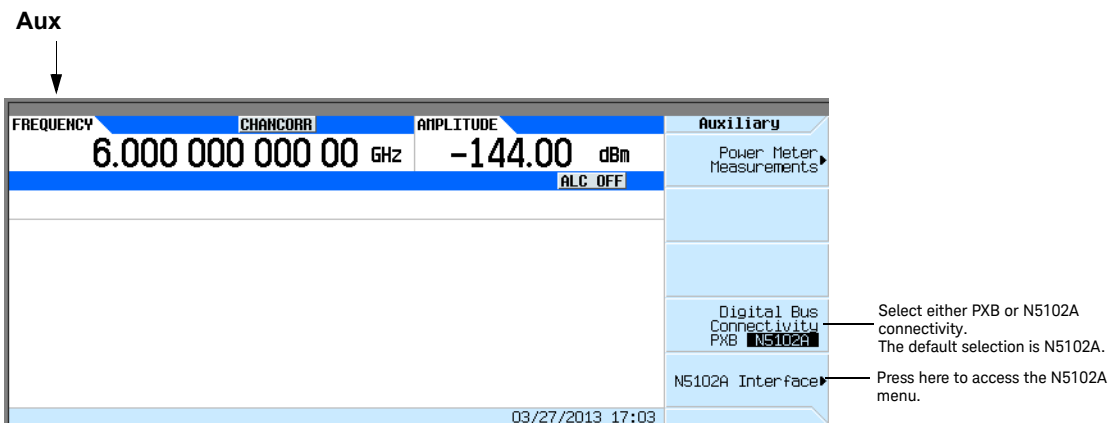
The digital signal interface module receives data from a baseband source and outputs a digital IQ or digital IF signal relative to the selected logic type. Because a signal generator provides the baseband data, the first procedure in operating the interface module is configuring the signal generator using one of the real-time or ARB modulation formats, or playing back a stored file using the Dual ARB player. For information on configuring the signal generator, refer to **Chapter 9, “Basic Digital Operation (Option 653/655/656/657)”**, on page 203.

1. Preset the signal generator.
2. Select the modulation format (GSM, Custom, and so forth) and set the desired parameters.
3. Turn-on the modulation format.

### Accessing the N5102A Module User Interface

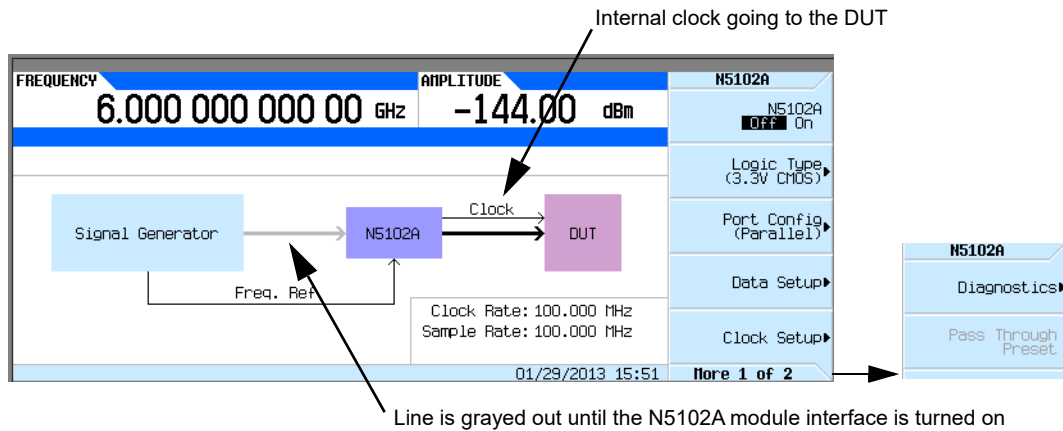
**Figure 10-9** shows the Auxiliary menu that is accessed by pressing the Aux Fctn key on the front panel of the signal generator.

Figure 10-9 First-Level Softkey Menu



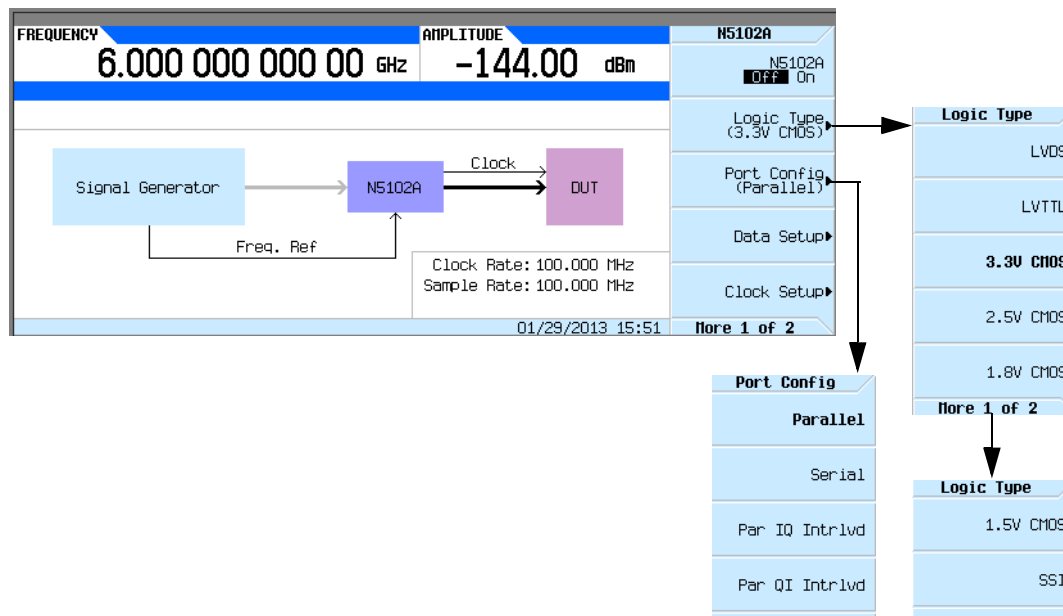
Press N5102A Interface to access the UI (first-level softkey menu shown in **Figure 10-10**) that is used to configure the digital signal interface module. Notice the graphic in the signal generator display, showing a setup where the N5102A module is generating its own internal clock signal. This graphic changes to reflect the current clock source selection.

Figure 10-10 N5102A Interface Menu



### Choosing the Logic Type and Port Configuration

Figure 10-11 Logic and Port Configuration Softkey Menus



1. Refer to **Figure 10-11**. Press the **Logic Type** softkey.

From this menu, choose a logic type.

**CAUTION**

Changing the logic type can increase or decrease the signal voltage level going to the device under test. To avoid damaging the device and/or the N5102A module, ensure that both are capable of handling the voltage change.

---

2. Select the logic type required for the device being tested.

A caution message is displayed whenever a change is made to the logic types, and a softkey selection appears requesting confirmation.

3. Refer to **Figure 10-11**. Press the **Port Config** softkey.

In this menu, select either a serial, parallel, or parallel interleaved data transmission.

**NOTE**

Within the data and clock setup softkey menus, some softkeys function relative to the current configuration. Softkeys that are grayed out are not available for the current setup.

---

4. Select the port configuration for the device.

## Selecting the Output Direction

Press **Data Setup** > **Direction Input Output** to Output and press **Return**.

**NOTE**

If Option 003 is the only option installed, the direction softkey will be unavailable and the mode will always be output. With both Option 003 (output mode) and Option 004 (input mode) installed, the default direction is output.

---

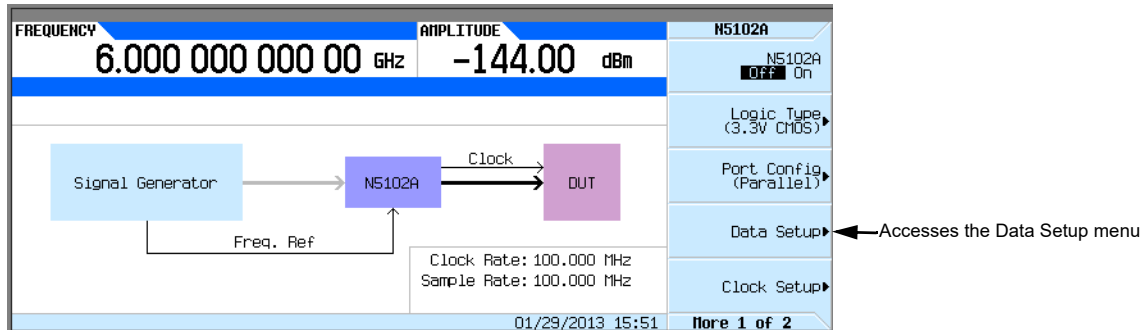
## Selecting the Data Parameters

This procedure guides you through the data setup menu. Softkeys that have self-explanatory names are generally not mentioned. For example, the **Word Size** softkey.

1. Refer to **Figure 10-12**. Press the **Data Setup** softkey.

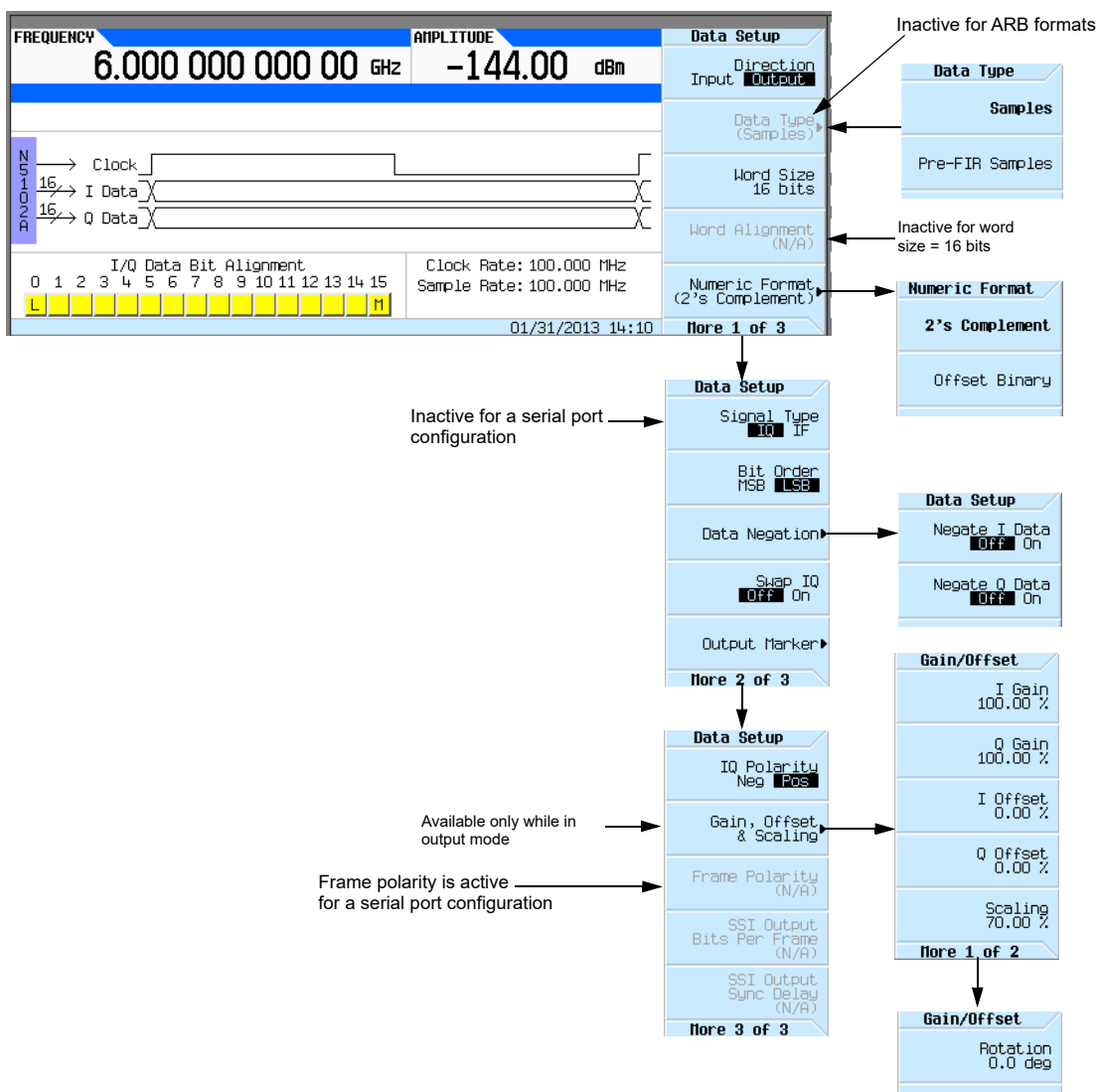


Figure 10-12 Data Setup Menu Location



This softkey menu accesses the various parameters that govern the data received by the device under test. The status area of the display shows the number of data lines used for both I and Q along with the clock position relative to the data. When the port configuration is parallel or parallel interleaved, the number of data lines indicated is equivalent to the word (sample) size. When the port configuration is serial, the display will show that only one I and one Q data line is being used along with the frame marker that delineates the beginning of a sample. Figure 10-13 shows the data setup menu structure.

**Figure 10-13** Data Setup Softkey Menu with Parallel Port Configuration



2. If a real-time modulation format or the real-time modulation filter feature in Dual ARB is being used, press the **Data Type** softkey.

In this menu, select whether the real-time baseband data from the signal generator is either filtered (**Samples**) or unfiltered (**Pre-FIR Samples**). The selection is dependent on the test needs. The **Samples** selection provides FIR filtered baseband samples according to the communication standard of the active modulation format. This is the preset selection and the one most commonly used. However if the device being tested already incorporates FIR filters, the **Pre-FIR Samples** selection should be used to avoid double filtering.

3. Select the data type that is appropriate for the test.
4. Press the **Numeric Format** softkey.

From this menu, select how the binary values are represented. Selecting 2's complement allows both positive and negative data values. Use the Offset Binary selection when components cannot process negative values.

5. Select the numeric format required for the test.

6. Press the **More (1 of 2)** softkey.

From this softkey menu, select the bit order, swap I and Q, select the polarity of the transmitted data, and access menus that provide data negation, scaling, gain, offset, and IQ rotation adjustments.

7. Press the **Data Negation** softkey.

Negation differs from changing the I and Q polarity. Applied to a sample, negation changes the affected sample by expressing it in the two's complement form, multiplying it by negative one, and converting the sample back to the selected numeric format. This can be done for I samples, Q samples, or both.

The choice to use negation is dependent on the device being tested and how it needs to receive the data.

8. Press the **Gain, Offset & Scaling** softkey.

Use the softkeys in this menu for the following functions:

- reduce sample values for both I and Q using the **Scaling** softkey
- increase or decrease the sample values independently for I and Q using the **I Gain** and **Q Gain** softkeys
- compensate for or add a DC offset using the **I Offset** and **Q Offset** softkeys
- rotate the data on the IQ plane using the **Rotation** softkey

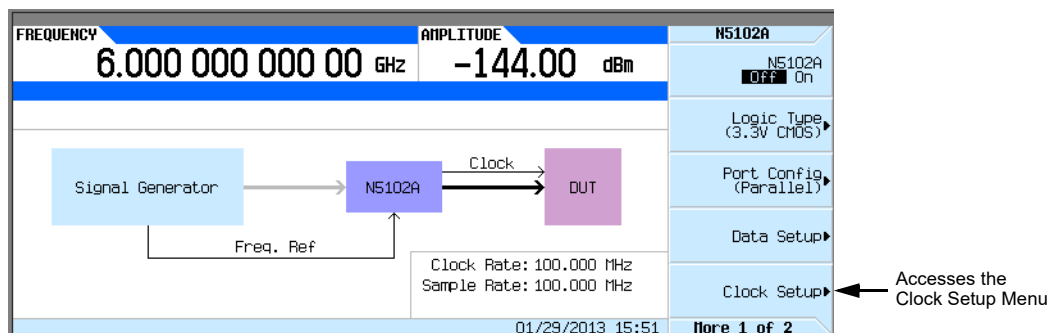
9. Make any required scaling, gain, offset, or rotation adjustments to properly test the device.

10. Press **Return** > **Return** to return to the first-level softkey menu.

## Configuring the Clock Signal

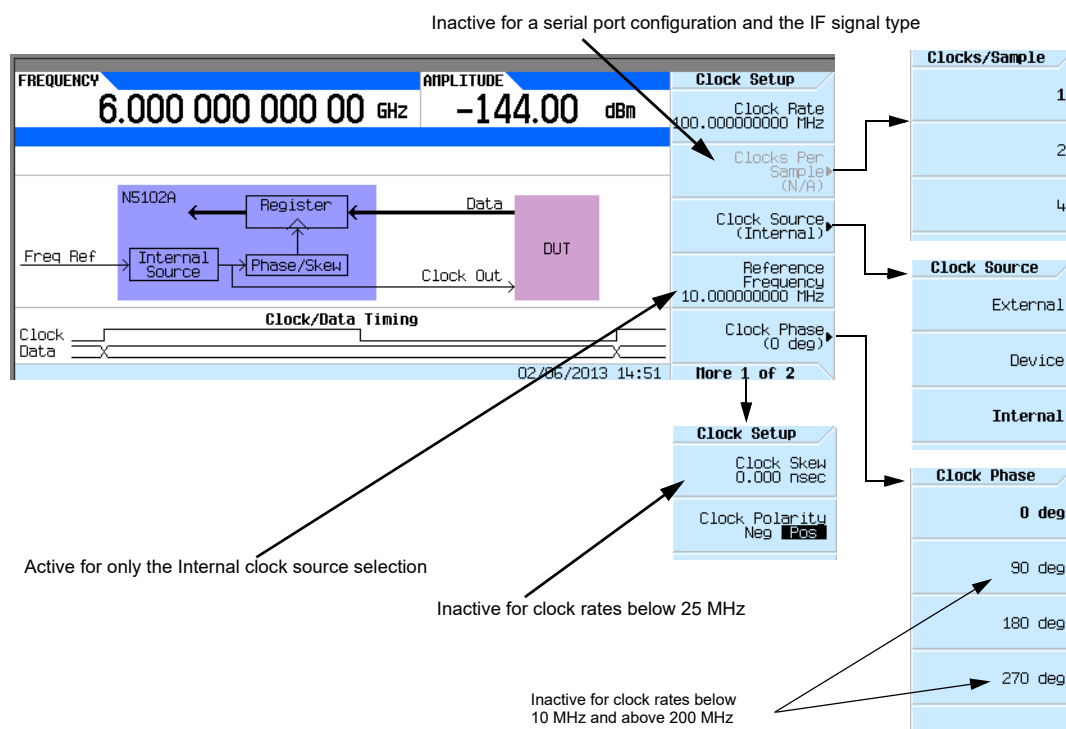
1. Refer to **Figure 10-14**. Press the **Clock Setup** softkey.

**Figure 10-14** Clock Setup Menu Location



From this softkey menu, set all of the clock parameters that synchronize the clocks between the N5102A module and the signal generator. You can also change the clock signal phase so the clock occurs during the valid portion of the data. **Figure 10-15** shows the clock setup menu.

**Figure 10-15** Clock Setup Softkey Menu for a Parallel Port Configuration



The top graphic on the display shows the current clock source that provides the output clock signal at the Clock Out and Device Interface connectors. The graphic changes to reflect the clock source selection discussed later in this procedure. The bottom graphic shows the clock position relative to the data. The displayed clock signal will change to reflect the following:

- clocks per sample selection
- clock phase choice
- clock skew adjustment
- clock polarity selection

If the device or external clock does not match the frequency, one of the following error messages will appear on the signal generator:

805 Digital module output FIFO overflow error; There are more samples being produced than can be consumed at the current clock rate. Verify that the digital module clock is set up properly.

This error is reported when the output FIFO is overflowing in the digital module. This error can be generated if an external clock or its reference is not set up properly, or if the internal VCO is unlocked.

806 Digital module output FIFO underflow error; There are not enough samples being produced for the current clock rate. Verify that the digital module clock is set up properly.

This error is reported when the output FIFO is underflowing in the digital module. This error can be generated if an external clock or its reference is not set up properly, or if the internal VCO is unlocked.

2. If the port configuration is parallel or parallel interleaved, using an IQ signal type, press the **Clocks Per Sample** softkey.

Notice that multiple clocks per sample can be selected. Some DACs require the ability to clock multiple times for each sample; having a clocks per sample value greater than one reduces the rate by a factor equal to the selected number of clocks per sample. The sample rate is viewed on the first-level and Data Setup softkey menus.

3. Select the clocks per sample value to fit the test.
4. Press the **Clock Source** softkey.

From this menu, select the clock signal source. With each selection, the clock routing display in the signal generator clock setup menu will change to reflect the current clock source. This will be indicated by a change in the graphic.

5. Select the clock source.

#### If External or Device is Selected

Press the **Clock Rate** softkey and enter the clock rate of the externally applied clock signal.

#### NOTE

The clock phase and clock skew may need to be adjusted any time the clock rate setting is changed. Refer to [“Clock Timing for Phase and Skew Adjustments” on page 313](#).

For the **External** selection, the signal is supplied by an external clock source and applied to the Ext Clock In connector. For the **Device** selection, the clock signal is supplied through the Device Interface connector, generally by the device under test.

#### If Internal is Selected

Using an external frequency reference, the N5102A module generates its own internal clock signal. The reference frequency signal must be applied to the Freq Ref connector on the digital module.

- a. Press the **Reference Frequency** softkey and enter the frequency of the externally applied frequency reference.

b. Press the **Clock Rate** softkey and enter the appropriate clock rate.

**Table 10-7** provides a quick view of the settings and connections associated with each clock source selection.

Table 10-7 Clock Source Settings and Connectors

Clock Source	Softkeys		N5102A Module Connection		
	Reference Frequency	Clock Rate <sup>1</sup>	Freq Ref	Ext Clock In	Device Interface
External		l		l	
Device		l			l
Internal <sup>2</sup>	l	l	l		

1. For the Internal selection, this sets the internal clock rate. For the External and Device selections, this tells the interface module the rate of the applied clock signal.
2. There should be no clock signal applied to the Ext Clock In connector.

6. Press the **Clock Phase** softkey.

From the menu that appears, you can adjust the phase of the clock relative to the data in 90 degree increments. The selections provide a coarse adjustment for positioning the clock on the valid portion of the data. Selecting 180 degrees is the same as selecting a negative clock polarity.

The 90 degree and 270 degree selections are not available when the clock rate is set below 10 MHz or above 200 MHz. If 90 degrees or 270 degrees is selected when the clock rate is set below 10 MHz or above 200 MHz, the phase will change to 0 degrees or 180 degrees, respectively.

**NOTE**

The clock phase and clock skew may need to be adjusted any time the clock rate setting is changed. Refer to **“Clock Timing for Phase and Skew Adjustments”** on page 313.

7. Enter the required phase adjustment.

8. Press the **Return** softkey to return to the clock setup menu.

9. Press the **Clock Skew** softkey.

This provides a fine adjustment for the clock relative to its current phase position. The skew is a phase adjustment using increments of time. This enables greater skew adjustment capability at higher clock rates. For clock rates below 25 MHz, this softkey is inactive.

The skew has discrete values with a range that is dependent on the clock rate. Refer to **“Clock Timing for Phase and Skew Adjustments”** on page 313 for more information on skew settings.

10. Enter the skew adjustment that best positions the clock with the valid portion of the data.

**11. Press the **Clock Polarity Neg Pos** softkey to Neg.**

This shifts the clock signal 180 degrees, so that the data starts during the negative clock transition. This has the same affect as selecting the 180 degree phase adjustment.

**12. Make the clock polarity selection that is required for the device being tested.**

**13. Press the **Return** hardkey to return to the first-level softkey menu.**

The clock source selection is also reflected in the first-level softkey menu graphic. For example, if the device is the new clock source, the graphic will show that the frequency reference is now connected to the DUT and the DUT has an input clock line going to the N5102A module.

## Generating Digital Data

Press the **N5102A Off On** softkey to On.

Digital data is now being transferred through the N5102A module to the device. The green status light should be blinking. This indicates that the data lines are active. If the status light is solidly illuminated (not blinking), all the data lines are inactive. The status light comes on and stays on (blinking or solid) after the first time the N5102A module is turned on (**N5102A Off On** to On). The status light will stay on until the module is disconnected from its power supply.

The interface module can only be turned on while a modulation format is active. If the modulation format is turned off while the module is on, the module will turn off and an error will be reported.

### NOTE

If changes are made to the baseband data parameters, it is recommended that you first disable the digital output (**N5102A Off On** softkey to Off) to avoid exposing your device and the N5102A module to the signal variations that may occur during the parameter changes.

---

## Operating the N5102A Module in Input Mode

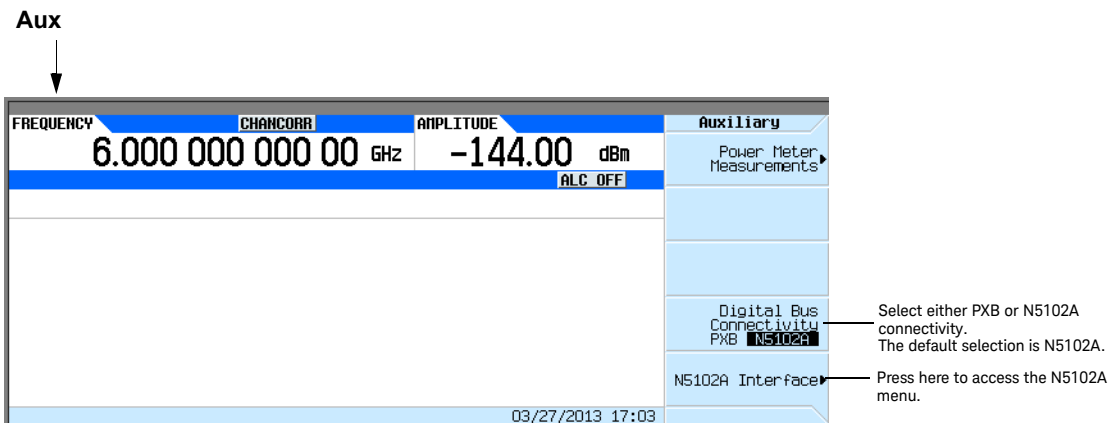
This section shows how to set the parameters for the N5102A module using the signal generator UI in the input direction. Each procedure contains a figure that shows the softkey menu structure for the interface module function being performed.

Refer to **“Connecting the Clock Source and the Device Under Test” on page 315** and configure the test setup.

### Accessing the N5102A Module User Interface

**Figure 10-16** shows the Auxiliary menu that is accessed by pressing the Aux Fctn key on the front panel of the signal generator.

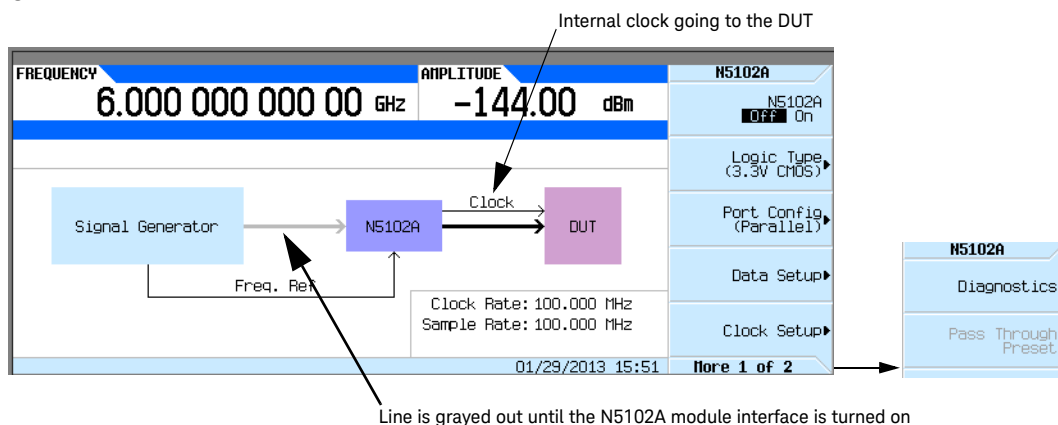
Figure 10-16 First-Level Softkey Menu



All parameters for the N5102A module are set with softkeys on the signal generator.

Press N5102A Interface to access the UI (first-level softkey menu shown in **Figure 10-17**) that is used to configure the digital signal interface module. Notice the graphic in the signal generator display, showing a setup where the N5102A module is generating its own internal clock signal. This graphic changes to reflect the current clock source selection.

Figure 10-17 N5102A Interface Menu





## Selecting the Input Direction

If both Option 003 (output mode) and Option 004 (input mode) are installed, you must select the input direction.

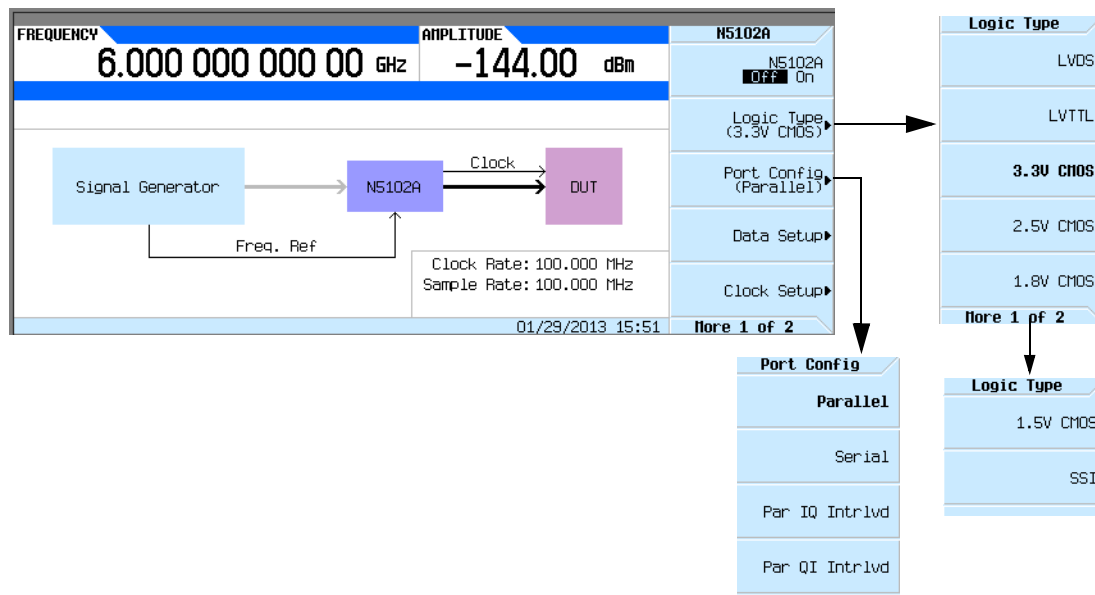
Press **Data Setup** > **Direction Input Output** to Input and press **Return**.

### NOTE

If only Option 004 is installed, the direction softkey will be unavailable and the mode will always be input.

## Choosing the Logic Type and Port Configuration

Figure 10-18 Logic and Port Configuration Softkey Menus



1. Refer to **Figure 10-18**. Press the **Logic Type** softkey.

From this menu, choose a logic type.

### CAUTION

Changing the logic type can increase or decrease the signal voltage level. To avoid damaging the device and/or the N5102A module, ensure that both are capable of handling the voltage change.

2. Select the logic type required for the device being tested.

A caution message is displayed whenever a change is made to the logic types, and a softkey selection appears asking for confirmation.

3. Refer to **Figure 10-18**. Press the **Port Config** softkey.

In this menu, select either a serial, parallel, or parallel interleaved data transmission.

**NOTE**

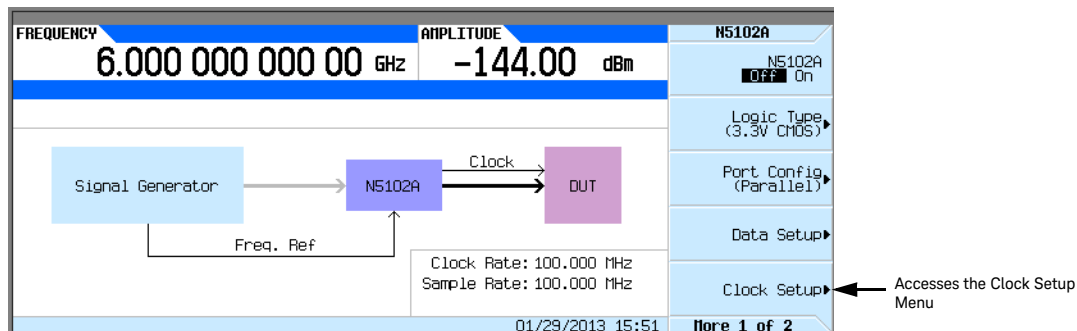
Within the data and clock setup softkey menus, some softkeys function relative to the current configuration. Softkeys that are grayed out are not available for the current setup. Refer to the help text to determine which parameter is causing the softkey to be unavailable. Press the **Help** hardkey on the signal generator front panel and then the softkey that is unavailable.

4. Select the port configuration for the device being tested.

### Configuring the Clock Signal

1. Refer to **Figure 10-19**. Press the **Clock Setup** softkey.

**Figure 10-19** Clock Setup Menu Location



From this softkey menu, set all of the clock parameters that synchronize the data between the N5102A module and the device. From this menu, the clock signal phase can be changed so the clock occurs during the valid portion of the data. **Figure 10-20** shows the clock setup menu.

If the device or external clock does not match the frequency, one of the following error messages will appear on the signal generator:

803 Digital module input FIFO overflow error; There are more samples being produced than can be consumed at the current clock rate. Verify that the digital module clock is set up properly.

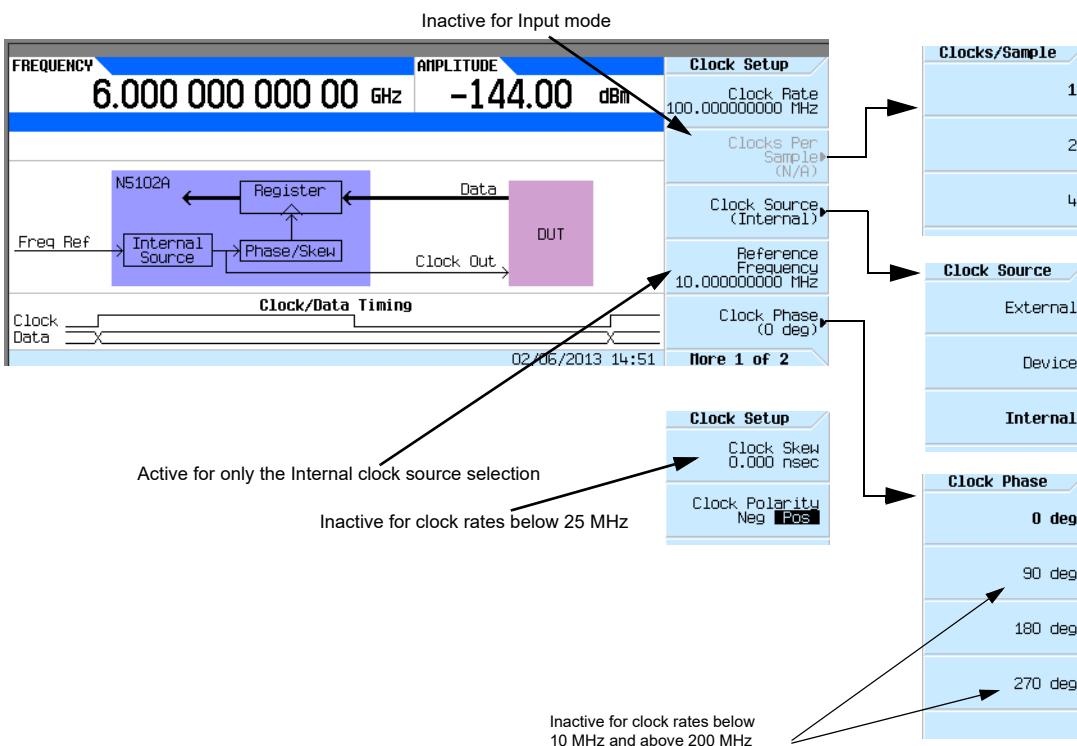
This error is reported when the digital module clock setup is not synchronized with the rate the samples are entering the digital module. Verify that the input clock rate matches the specified

clock rate under the clock setup menu.

804 Digital module input FIFO underflow error; There are not enough samples being produced for the current clock rate. Verify that the digital module clock is set up properly.

This error is reported when the digital module clock setup is not synchronized with the rate the samples are entering the digital module. Verify that the input clock rate matches the specified clock rate under the clock setup menu.

**Figure 10-20** Clock Setup Softkey Menu for a Parallel Port Configuration



The top graphic on the display shows the current clock source that provides the output clock signal at the Clock Out and Device Interface connectors. The graphic changes to reflect the clock source selection discussed later in this procedure. The bottom graphic shows the clock edges relative to the data. The displayed clock signal will change to reflect the following:

- clock phase choice
- clock skew adjustment
- clock polarity selection

2. Press the **Clock Source** softkey.

From this menu, select the clock signal source. With each selection, the clock routing display in the signal generator clock setup menu will change to reflect the current clock source. This will be indicated by a change in the graphic.

**3.** Select the clock source.

**If External or Device is Selected**

Press the **Clock Rate** softkey and enter the clock rate of the externally applied clock signal.

**NOTE**

The clock phase and clock skew may need to be adjusted any time the clock rate setting is changed. Refer to [“Clock Timing for Phase and Skew Adjustments” on page 313](#).

For the **External** selection, the signal is supplied by an external clock source and applied to the Ext Clock In connector. For the **Device** selection, the clock signal is supplied through the Device Interface connector, generally by the device being tested.

**If Internal is Selected**

Using an external frequency reference, the N5102A module generates its own internal clock signal. The reference frequency signal must be applied to the Freq Ref connector on the digital module.

- a. Press the **Reference Frequency** softkey and enter the frequency of the externally applied frequency reference.
- b. Press the **Clock Rate** softkey and enter the appropriate clock rate.

[Table 10-8](#) provides a quick view of the settings and connections associated with each clock source selection.

Table 10–8 Clock Source Settings and Connectors

Clock Source	Softkeys		N5102A Module Connection		
	Reference Frequency	Clock Rate <sup>1</sup>	Freq Ref	Ext Clock In	Device Interface
External		l		l	
Device		l			l
Internal <sup>2</sup>	l	l	l		

1. For the Internal selection, this sets the internal clock rate. For the External and Device selections, this tells the interface module the rate of the applied clock signal.
2. There should be no clock signal applied to the Ext Clock In connector when Internal is being used.

**4. Press the Clock Phase softkey.**

From the menu that appears, the phase of the clock relative to the data can be changed in 90 degree increments. The selections provide a coarse adjustment for positioning the clock on the valid portion of the data. Selecting 180 degrees is the same as selecting a negative clock polarity.

The 90 degree and 270 degree selections are not available when the clock rate is set below 10 MHz or above 200 MHz. If 90 degrees or 270 degrees is selected when the clock rate is set below 10 MHz or above 200 MHz, the phase will change to 0 degrees or 180 degrees, respectively.

**NOTE** The clock phase and clock skew may need to be adjusted any time the clock rate setting is changed. Refer to **“Clock Timing for Phase and Skew Adjustments”** on page 313.

**5. Enter the required phase adjustment.**

**6. Press the Return softkey to return to the clock setup menu.**

**7. Press the Clock Skew softkey.**

This provides a fine adjustment for the clock relative to its current phase position. The skew is a phase adjustment using increments of time. This enables greater skew adjustment capability at higher clock rates. For clock rates below 25 MHz, this softkey is inactive.

The skew has discrete values with a range that is dependent on the clock rate. Refer to **“Clock Timing for Phase and Skew Adjustments”** on page 313 for more information on skew settings.

**8. Enter the skew adjustment that best positions the clock with the valid portion of the data.**

**9. Press the Clock Polarity Neg Pos softkey to Neg.**

This shifts the clock signal 180 degrees, so that the data starts during the negative clock transition. This has the same affect as selecting the 180 degree phase adjustment.

**10. Make the clock polarity selection that is required for the device being tested.**

**11. Press the Return hardkey to return to the first-level softkey menu.**

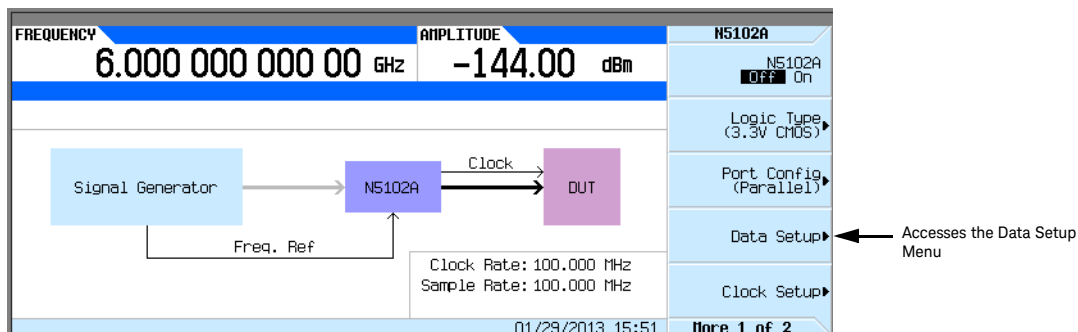
The clock source selection is also reflected in the first-level softkey menu graphic. For example, if the device is the new clock source, you will see that the frequency reference is now connected to the DUT and the DUT has an input clock line going to the N5102A module.

### Selecting the Data Parameters

This procedure guides you through the data setup menu. Softkeys that have self-explanatory names are generally not mentioned. For example, the **Word Size** softkey.

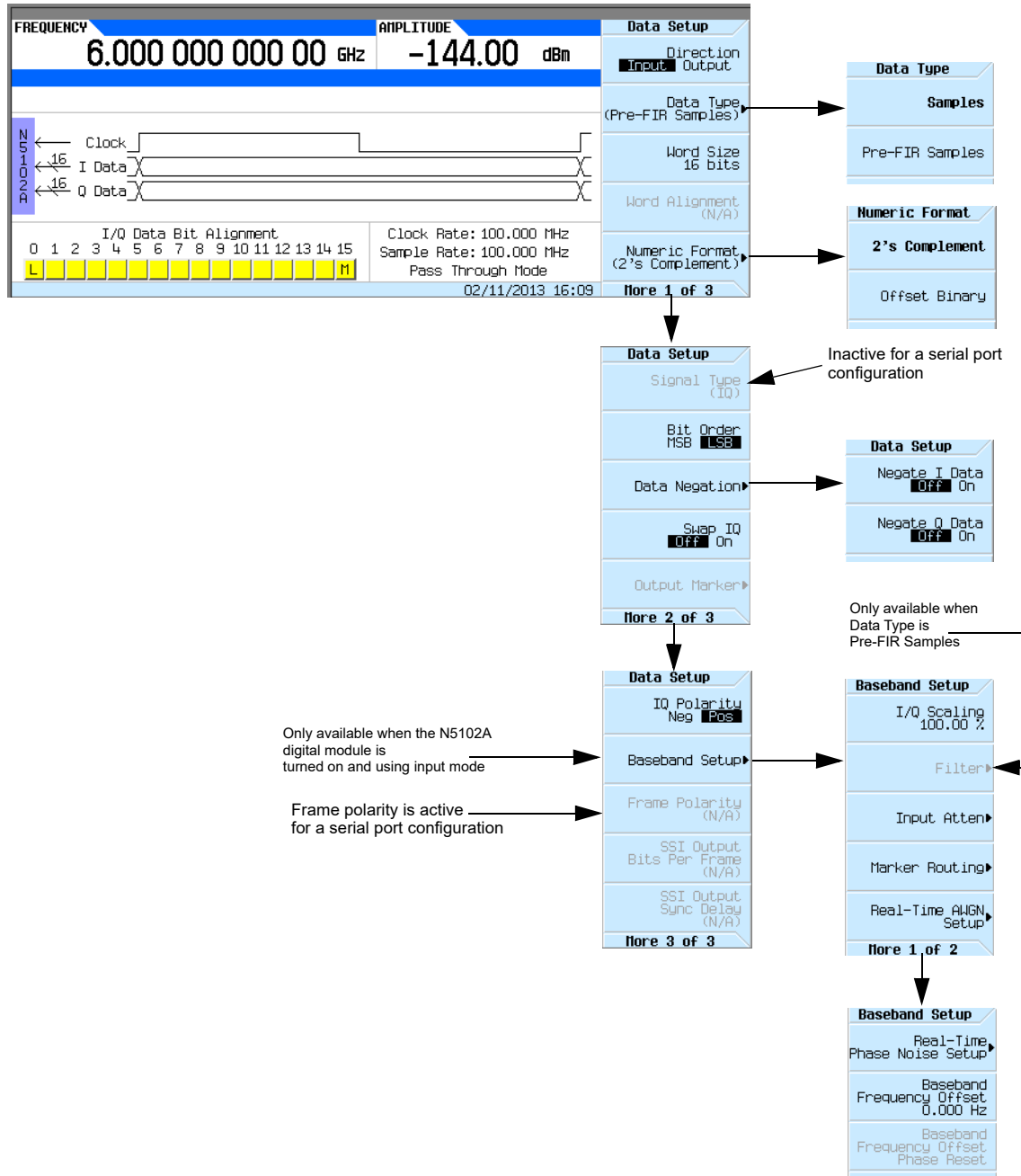
**1. Refer to Figure 10-21. Press the Data Setup softkey.**

**Figure 10-21** Data Setup Menu Location



This softkey menu accesses the various parameters that govern the data received by the signal generator. The status area of the display shows the number of data lines used for both I and Q along with the clock position relative to the data. Figure 10-22 shows the data setup menu structure.

Figure 10-22 Data Setup Softkey Menu with Parallel Port Configuration



2. Press the **Data Type** softkey.

In this menu, select the data type to be either filtered (**Samples**) or unfiltered (**Pre-FIR Samples**). The selection is dependent on the test needs and the device under test. However if the device being tested already incorporates FIR filters, the **Pre-FIR Samples** selection should be used to avoid double filtering. Refer to “Data Types” on page 317, for more information.

3. Select the data type that is appropriate for the test needs.

4. Press the **Numeric Format** softkey.

From this menu, select how the binary values are represented. Selecting 2's complement allows both positive and negative data values. Use the Offset Binary selection when components cannot process negative values.

5. Select the numeric format required for the test.
6. Press the **More (1 of 2)** softkey.

From this softkey menu, select the bit order, swap I and Q, the polarity of the data, and access menus that provides data negation, scaling, and filtering parameters.

7. Press the **Data Negation** softkey.

Negation differs from changing the I and Q polarity. Applied to a sample, negation changes the affected sample by expressing it in the two's complement form, multiplying it by negative one, and converting the sample back to the selected numeric format. This can be done for I samples, Q samples, or both.

The choice to use negation is dependent on the device being tested.

8. To access I/Q scaling and filter parameters, press **Return** > **N5102A Off On** to On. This will invoke the real time Custom format in the signal generator's baseband generator. This is needed to set the filter parameters when Pre-FIR Samples is selected as the data type.
9. Press the **Baseband Setup** softkey.

Use this softkey menu to adjust the I/Q scaling and access filter parameters. If the selected data type is Samples, the **Filter** softkey is grayed out (inactive). For more information on user-defined filtering, refer to the [“Using Finite Impulse Response \(FIR\) Filters in the Dual ARB Real-Time Modulation Filter” on page 272](#) and [“Modifying a FIR Filter Using the FIR Table Editor” on page 278](#).

## Digital Data

If the N5102A digital module is not on, press **Return** > **Return** > **N5102A Off On** to On.

Digital data is now being transferred through the N5102A module to the signal generator. The green status light should be blinking. This indicates that the data lines are active. If the status light is solidly illuminated (not blinking), all the data lines are inactive. The status light comes on and stays on (blinking or solid) after the first time the N5102A module is turned on (**N5102A Off On** to On). The status light will stay on until the module is disconnected from its power supply.

### NOTE

If changes are made to the baseband data parameters, it is recommended that you first disable the digital input (**N5102A Off On** softkey to Off) to avoid exposing the device and the N5102A module to the signal variations that may occur during the parameter changes.

---



## 11 Baseband Operating Mode—Primary, BERT, or N5102A

### NOTE

With firmware version B.01.75 or later, option numbers for software internal to the instrument have changed. For more information, see [“Enabling an Option” on page 53](#).

### NOTE

Baseband Operating Mode is available on all Keysight N5172B EXG and N5182B MXG X-Series signal generators that have installed firmware version B.01.70 or later.

This chapter describes the Baseband Operating Mode feature used by Keysight N5172B EXG and N5182B MXG X-Series signal generators.

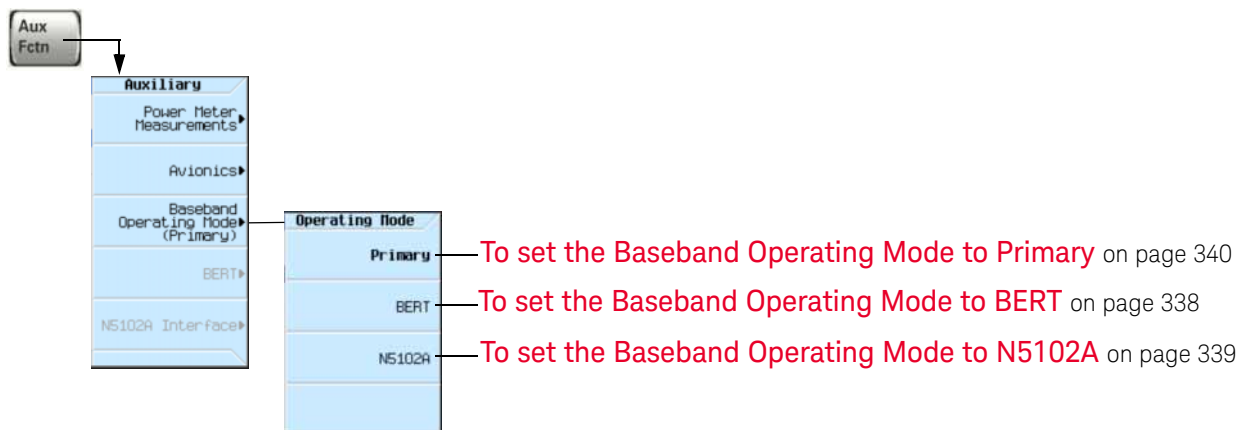
The Baseband Operating Mode can be one of three different ARB FPGA images; each ARB FPGA image changes the supported features available while in the selected mode.

The selected Baseband Operating Mode is a persistent instrument setting and its value is maintained through power cycles, Preset, or \*RST.

The default Baseband Operating Mode is set to Primary and can only be changed when one or more of the following options are installed. (BERT and/or N5102A will appear grayed-out if they are not available.)

- Internal Bit Error Rate Analyzer (BERT), Option N5180UN7B
- Digital Output Connectivity with the N5102A, Option 003 or 004 or both.

Figure 11-1 Baseband Operating Mode Softkeys

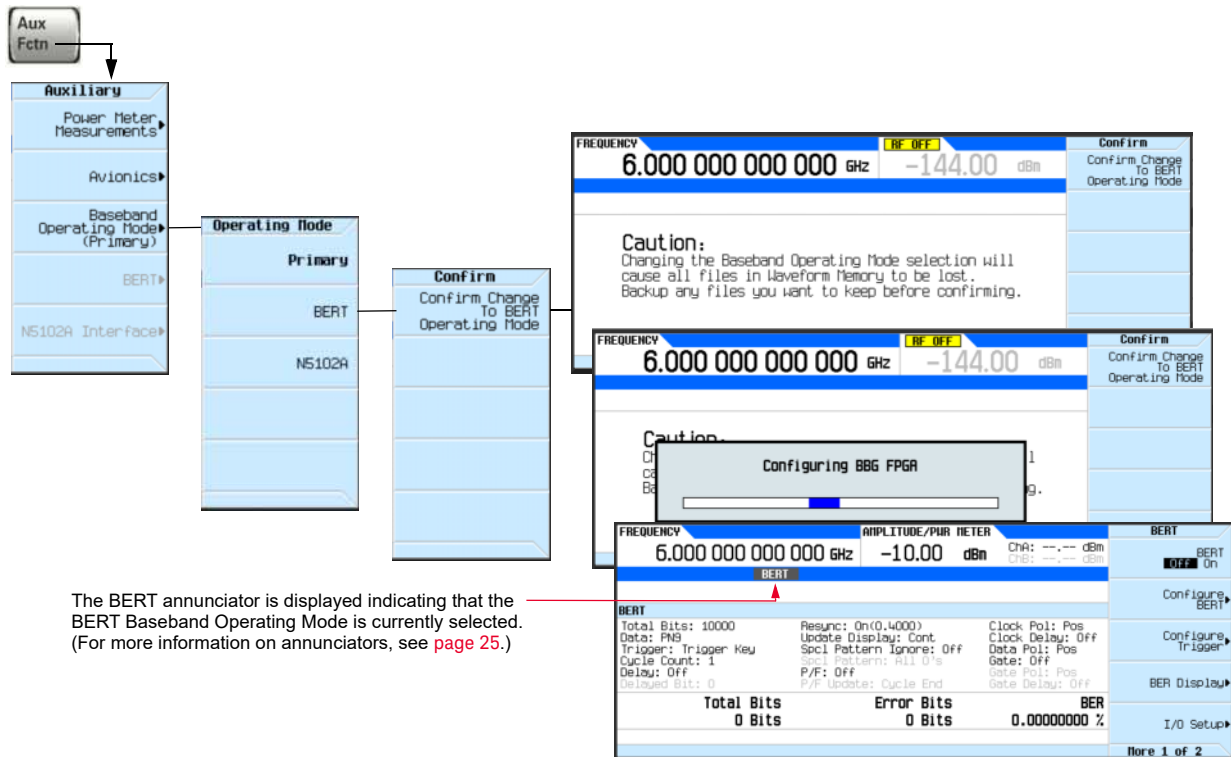


Baseband Operating Mode—Primary, BERT, or N5102A  
 To set the Baseband Operating Mode to BERT

## To set the Baseband Operating Mode to BERT

In this mode, all installed and licensed signal generator features as well as all BERT features are fully supported, but N5102A features are not available.

Figure 11-2 Changing to the BERT Baseband Operating Mode



1. Press **Aux Fctn**.
2. Press **Baseband Operating Mode**. (Default selection is **Primary**.)
3. Press **BERT**. (Press the **Return** key to cancel the change.)

### CAUTION

Changing the Baseband Operating Mode selection will cause all files in volatile waveform memory to be lost. Backup any files you want to keep before confirming the change.  
 See “Working with Files” on page 74.

4. After reading the above caution and taking any needed actions, press **Confirm Change to BERT Operating Mode** or **Return** to cancel.

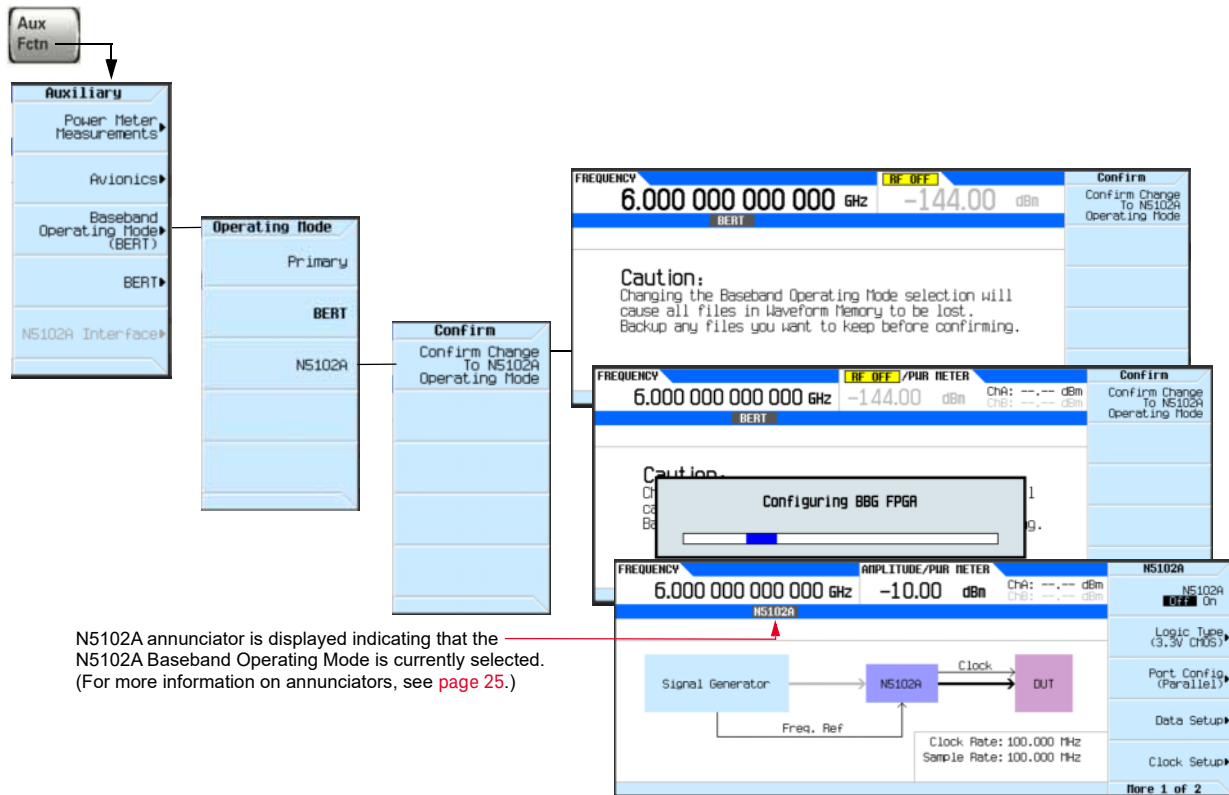
This confirmation selects the BERT ARB FPGA image. All BERT features are fully supported, but N5102A is not available in this mode. The BERT ARB FPGA image contains all functionality and features from the B.01.65 PXB Input FPGA image. For backwards compatibility, selecting the BERT Baseband Operating Mode sets the I/Q Digital Bus Connectivity to PXB.

Baseband Operating Mode—Primary, BERT, or N5102A  
To set the Baseband Operating Mode to N5102A

## To set the Baseband Operating Mode to N5102A

In this mode, all installed and licensed signal generator features as well as all N5102A features are fully supported, but BERT features are not available.

Figure 11-3 Changing to the N5102A Baseband Operating Mode



1. Press **Aux Fctn**.
2. Press **Baseband Operating Mode**.  
(Default selection is **Primary**, but image above shows changing from **BERT**.)
3. Press **N5102A**. (Press the **Return** key to cancel the change.)

### CAUTION

Changing the Baseband Operating Mode selection will cause all files in the volatile waveform memory to be lost. Backup any files you want to keep before confirming the change.

See “Working with Files” on page 74.

4. After reading the above caution and taking any needed actions, press **Confirm Change to N5102A Operating Mode** or **Return** to cancel.

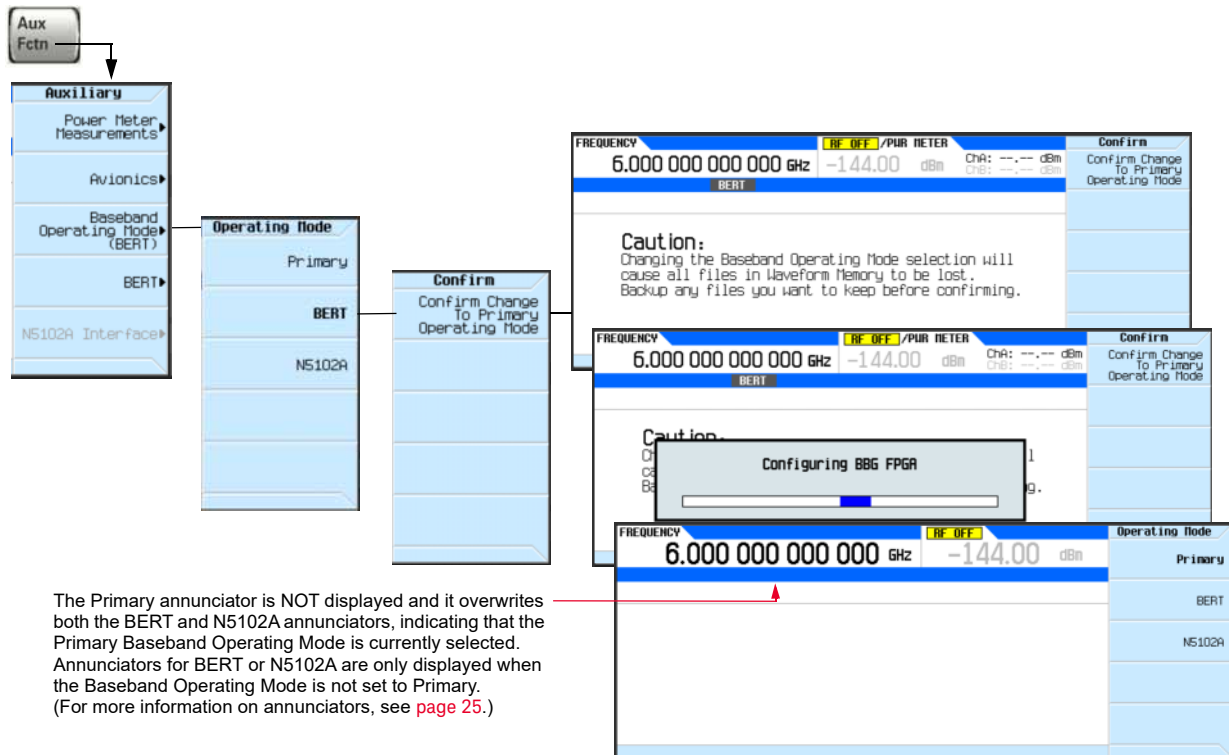
This confirmation selects the N5102A ARB FPGA image. All N5102A features are fully supported, but BERT is not available in this N5102A Baseband Operating Mode. For backwards compatibility, selecting the N5102A Baseband Operating Mode sets the I/Q Digital Bus Connectivity to N5102A.

Baseband Operating Mode—Primary, BERT, or N5102A  
To set the Baseband Operating Mode to Primary

## To set the Baseband Operating Mode to Primary

In this mode, all installed and licensed signal generator features are fully supported, but BERT and N5102A features are not available.

Figure 11-4 Changing to the Primary Baseband Operating Mode



1. Press **Aux Fctn**.
2. Press **Baseband Operating Mode**.
3. Press **Primary**. (Press the **Return** key to cancel the change.)

### CAUTION

Changing the Baseband Operating Mode selection will cause all files in the volatile waveform memory to be lost. Backup any files you want to keep before confirming the change.

See **“Working with Files”** on page 74.

4. After reading the above caution and taking any needed actions, press **Confirm Change to Primary Operating Mode** or **Return** to cancel.

This confirmation selects the PXB Input ARB FPGA image. All signal generator features are available in this mode except BERT and N5102A functionality. For backwards compatibility, selecting the Primary Baseband Operating Mode sets the I/Q Digital Bus Connectivity to PXB.

## 12 BERT (Option N5180UN7B)

### NOTE

With firmware version B.01.75 or later, option numbers for software internal to the instrument have changed. For more information, see [“Enabling an Option” on page 53](#).

---

The bit error rate test (BERT) capability allows you to perform bit error rate (BER) analysis on digital communications equipment. This enables functional and parametric testing of receivers and components including sensitivity and selectivity.

This feature is available in X-Series vector signal generators (N5172B and N5182B).

The following options are recommended:

- Option 653 or 655 (N5172B) -- Internal Baseband Generator
- Option 656 or 657 (N5182B) -- Internal Baseband Generator
- Option N5180431B -- Custom Digital Modulation

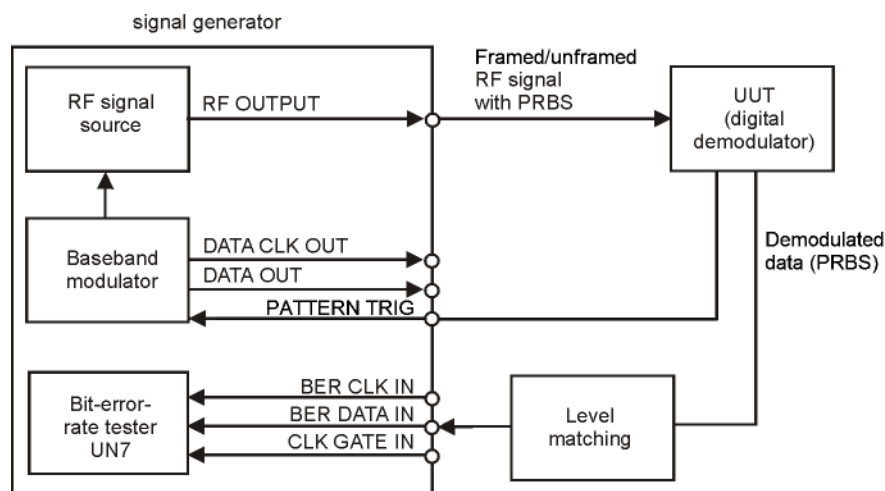
## Bit Error Rate Tester–Option N5180UN7B

The bit error rate test (BERT) capability allows you to perform bit error rate (BER) analysis on digital communications equipment. This enables functional and parametric testing of receivers and components including sensitivity and selectivity.

### Block Diagram

When measuring BER, a clock signal that corresponds to the unit under test (UUT) output data must be input to the BER CLK IN connector. If the clock is not available from the UUT, use the DATA CLK OUT signal from the X-Series baseband modulator. Refer to [Figure 12-16](#) for information about these connections.

Figure 12-1



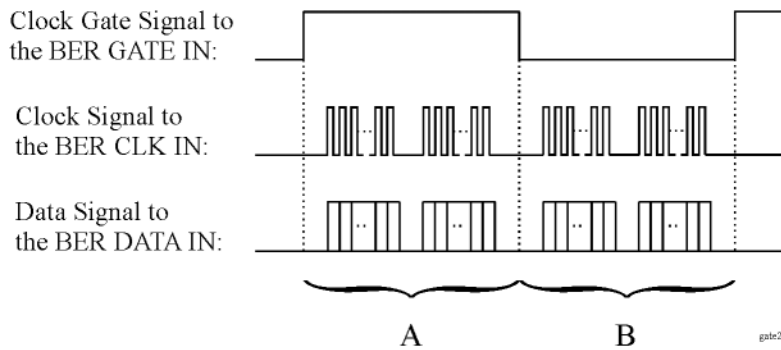
### Clock Gate Function

When you use the clock gate function, the clock signal to the BER CLK IN (rear panel BB TRIG 1) connector is valid only when the clock gate signal to the BER GATE IN connector is ON.

Press the **Clock Gate Off On** softkey to toggle the clock gate function off and on. The **Clock Gate Polarity Neg Pos** softkey sets the input polarity of the clock gate signal supplied to the rear panel BER GATE IN connector. When you select **Pos** (positive), the clock signal is valid when the clock gate signal is high; when you select **Neg** (negative), the clock signal is valid when the clock gate signal is low.

The following figure shows an example of the clock gate signal.

Figure 12-2



- When the **Clock Gate Off On** softkey is set to Off:  
The clock signal in both “A” and “B” parts is effective and no gate function is required. Therefore, the bit error rate is measured using the clock and data signal in both “A” and “B” parts.
- When the **Clock Gate Off On** softkey is set to **On**, and the **Clock Gate Polarity Neg Pos** softkey is set to **Pos**:  
The clock signal in “A” part is effective. Therefore, the bit error rate is measured using the clock and data signals in “A” part.
- When the **Clock Gate Off On** softkey is set to **On**, and the **Clock Gate Polarity Neg Pos** softkey is set to **Neg**:  
The clock signal in “B” part is effective. Therefore, the bit error rate is measured using the clock and data signals in “B” part.

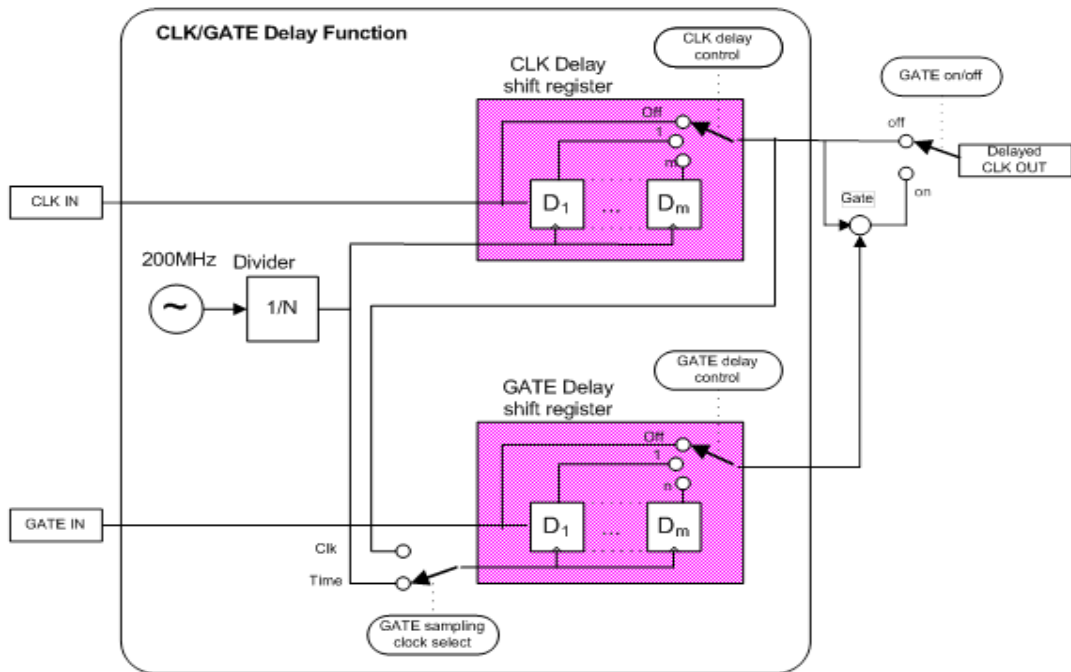
## Clock/Gate Delay Function

This function enables you to restore the timing relationship between the clock/gate timing as it passes through the unit under test (UUT) and the packet data.

The shifted clock signal is emitted from pin 17 of the AUX I/O rear panel connector. When you use the clock delay function, the clock signal to the BER CLK IN connector is delayed by the clock delay function. When you use the gate delay function with the clock gate function, the clock signal is gated by the gate signal which is delayed by the gate delay function.

To see the signal flow using the clock and gate functions, refer to [Figure 12-3](#).

Figure 12-3

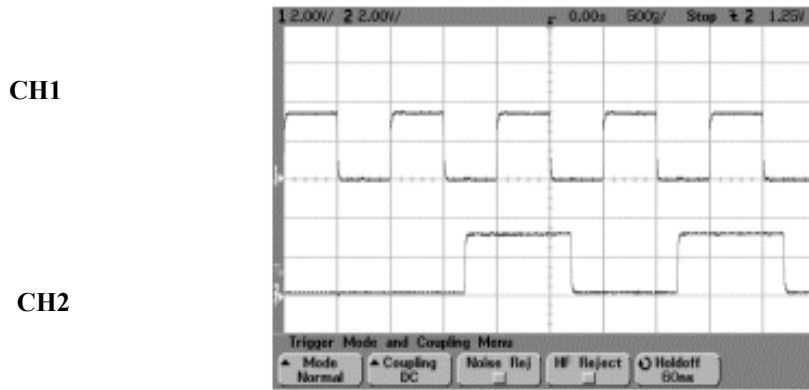




## Clock Delay Function

In this example, the clock delay function is off. **Figure 12-4** shows the input of the internal error detector of N5180UN7B through AUX I/O and indicates that the data is delayed from the clock.

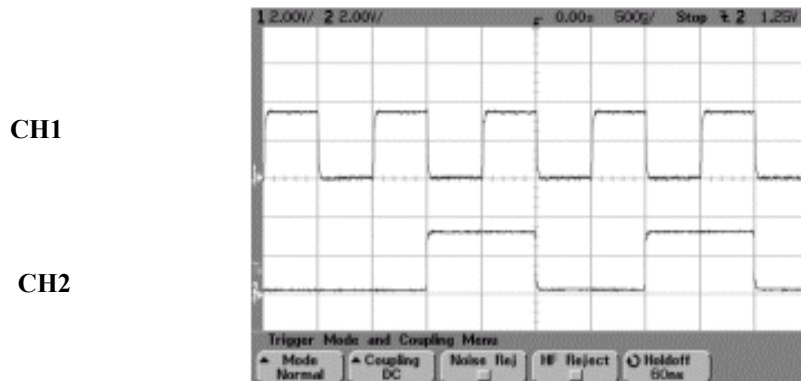
Figure 12-4



CH1: BER TEST OUT (pin 17 of AUX I/O connector)  
CH2: BER MEAS END (pin 15 of AUX I/O connector)

In this example, the clock delay function is on. The rising edge of the clock was delayed by 200 ns and was adjusted to the center of the data. **Figure 12-5** indicates the result of the using the clock delay function.

Figure 12-5

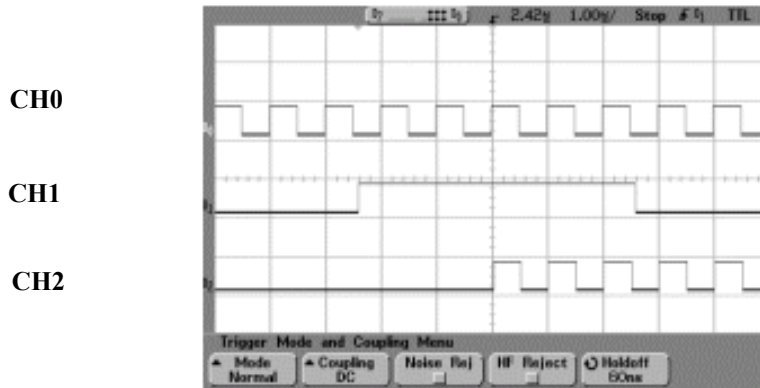


## Gate Delay Function in the Clock Mode

To use this function, the clock must be set to continuous mode.

In this example, the clock is used to delay the gate function. The clock of the internal error detector was gated by the gate signal which is delayed by two clocks. **Figure 12-6** shows that CH0 and CH1 are the input of the clock and data from the rear panel input connectors of Option N5180UN7B. CH2 is the gated clock through the AUX I/O connector.

Figure 12-6

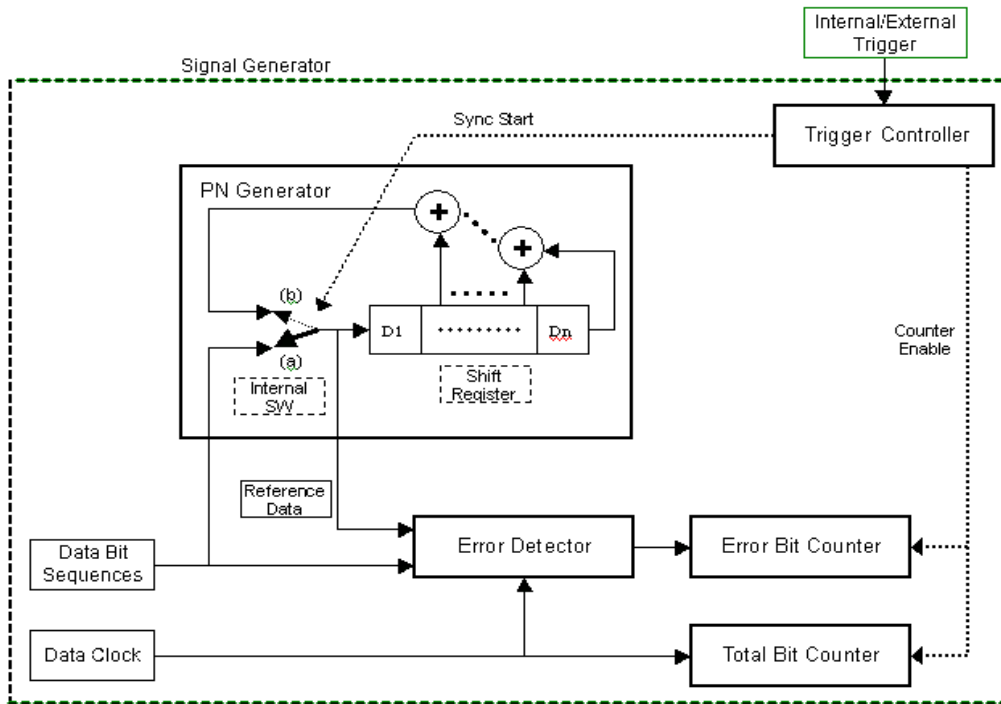


CH0: BER CLK IN (rear panel BNC connector labeled BB TRIG 1)  
CH1: BER GATE IN (rear panel BNC connector labeled BB TRIG 2)  
CH2: BER TEST OUT (pin 17 of AUX I/O connector)

## Triggering

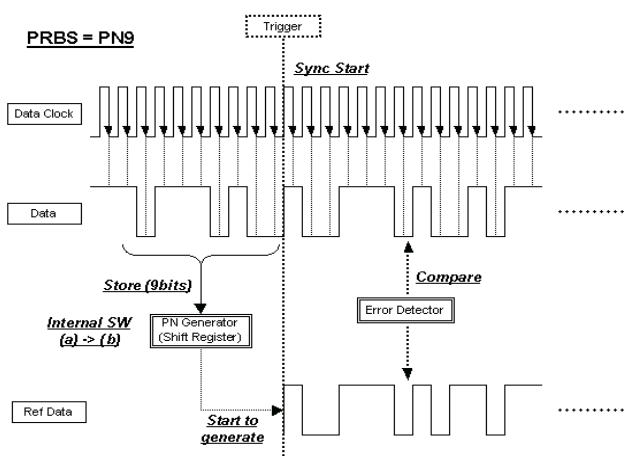
This section describes the operating principles of the triggering function for Option N5180UN7B. To see the signal flow of the triggering function refer to **Figure 12-7**.

Figure 12-7



In this example, the triggering sequence is where you have an incoming data clock and data bit sequences, the trigger is active, and the BERT measurement begins. Refer to **Figure 12-8**.

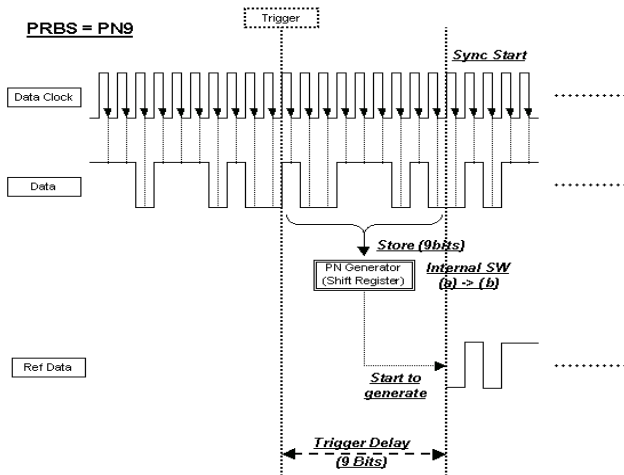
Figure 12-8



In this example, synchronization occurs after receiving a trigger.

The reference data is generated by stored data bits. If the BERT measurement accepts data bits immediately after receiving a trigger, set the trigger delay to On and the trigger delay count to a value corresponding to the data format. For PN9 set the delay to 9. Refer to [Figure 12-9](#).

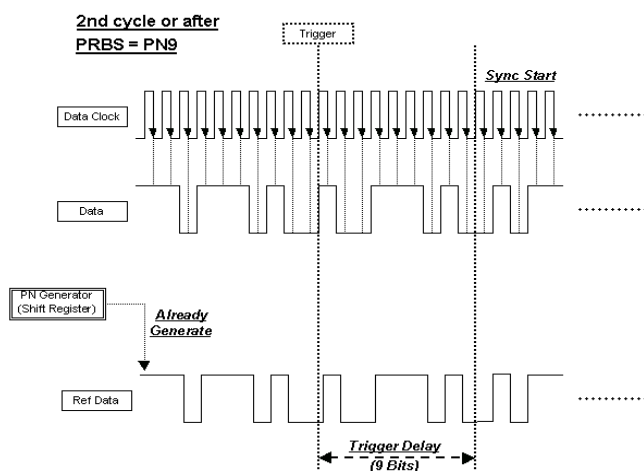
Figure 12-9



In this example, the triggering sequence is where the trigger delay is active with a cycle count.

The reference data is generated by stored data bits. If the BERT measurement accepts data bits immediately after receiving a trigger, set the trigger delay to On and the trigger delay count to a value corresponding to the data format. For PN9 set the delay to 9. If the cycle count is set to more than 1, it is not necessary to store data bits and no unnecessary delay occurs. Refer to **Figure 12-10** and **“Repeat Measurements” on page 350**.

Figure 12-10



## Data Processing

### Data Rates

Data rates up to 90 MHz are supported for BERT analysis on unframed or framed PN sequences. Note that the BERT analyzer supports only continuous PN sequences.

### Synchronization

Immediately after the trigger event, the DSP for the BERT measurement tries to establish synchronization using the first incoming bit stream.

If the **Bit Delay Off On** softkey is set to **On**, the number of bits specified by the **Delayed Bits** are ignored. The synchronization checking is repeated using an error-free bit string, lengthened by the **Delayed Bits**, until synchronization is established.

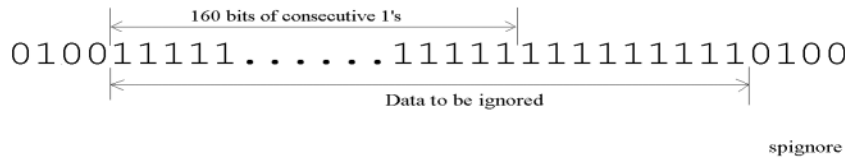
When the **BERT Resync Off On** softkey is set to **On**, the BERT measurements will automatically be restarted if the intermediate BERT measurement result exceeds the value specified by the **BERT Resync Limits**.

### Special Pattern Ignore Function

The special pattern ignore function is especially useful when performing BERT analysis on radios that generate consecutive 0's or 1's data for traffic channels when they fail to detect the Unique Word or lose synchronization. If 160 or more consecutive incoming data bits are either 1's or 0's,

and the **Spcl Pattern Ignore Off On** softkey is set to **On**, then all of the consecutive 0's or 1's are ignored. Select either 0's or 1's as the data to ignore by using the **Spcl Pattern 0's 1's** softkey. The following figure shows an example of the special pattern ignore function.

Figure 12-11 Pattern Ignore Function Example



The 160 or more ignored bits can be anywhere in the PN sequence. The signal generator ignores these bits as error, but they are counted in the PN sequence bit count.

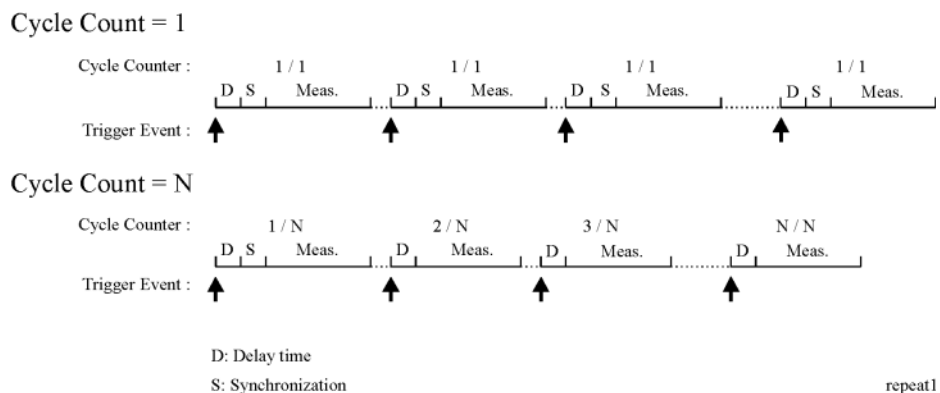
### Pass/Fail Judgement

There are two pass/fail judgement update modes: cycle end and fail hold. With cycle end selected, either pass or fail judgement is made for the results of each measurement cycle. With fail hold selected, the fail judgement is retained whenever a failure occurs during one loop of BERT repeat measurements. Fail hold mode allows you to determine when a failure occurs at least once during an entire cycle of measurements.

### Repeat Measurements

When the **Cycle Count** softkey is set to more than 1, the synchronization performed before the start of each measurement is only executed the first time; then it keeps track of the clock signal and the PRBS generation for the incoming data. This function can reduce the total time for BERT measurements. Also, once synchronization is established, it is retained even if the BERT measurement result degrades. You may wish to adjust the signal level to find a specific BERT value. However, once synchronization is lost in a repeat sequence, it will not be restored until the initiation of a new sequence. The following figure shows an example of the repeat measurements.

Figure 12-12 Repeat Measurements Example

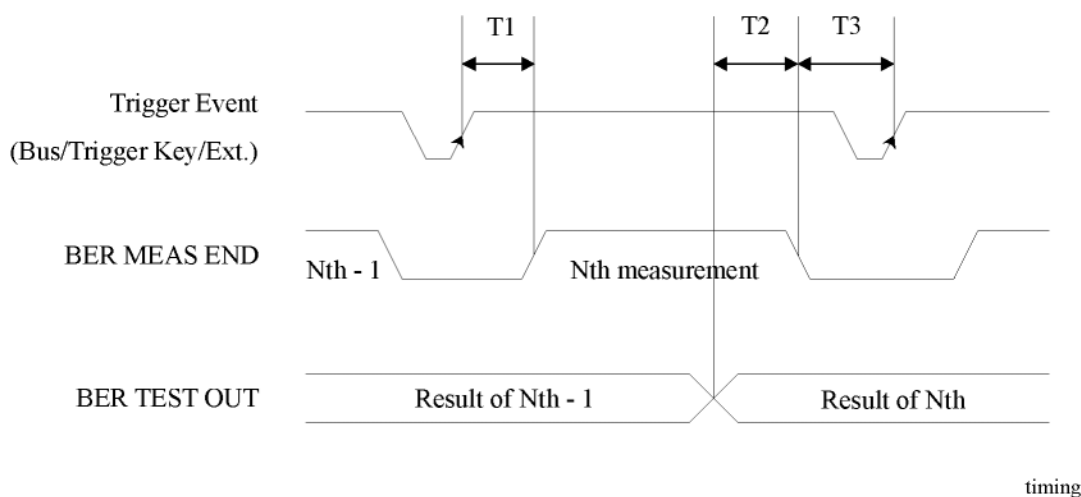


## Testing Signal Definitions

The timing diagram <Keysight Red >Figure 12-13, “Testing Signal Definitions,” shows the relationships between a trigger event and the output signals at the BER MEAS END and BER TEST OUT connectors.

If a BER MEAS END signal stays high following a trigger event, the BERT measurement is in progress and other trigger events are ignored. This state is stored in the status register and can be queried.

**Figure 12-13 Testing Signal Definitions**



- T1 is a firmware handling time measured from a Trigger event to the rising edge of a BER MEAS END signal.
- T2 is a firmware handling time measured from the falling edge of a BER TEST OUT signal to the falling edge of the BER MEAS END signal.
- T3 is a minimum requirement time measured from the falling edge of the BER MEAS END signal to the next trigger event. T3 should be greater than 0 second.

The pulse output of the BER TEST OUT for the Nth-1 test result ends prior to the falling edge of the BER MEAS END signal for the Nth measurement; so you can use this edge to start latching the Nth test result.

## Verifying BERT Operation

The following procedures verify the operation of the signal generator's bit error rate test (BERT) function. The tests can be performed as part of a daily validation routine or can be used whenever you want to check the validity of your BERT measurements.

**NOTE**

The following procedures check the signal generator's BERT operation and do not ensure system performance to specifications.

Figure 12-14 BERT Softkeys

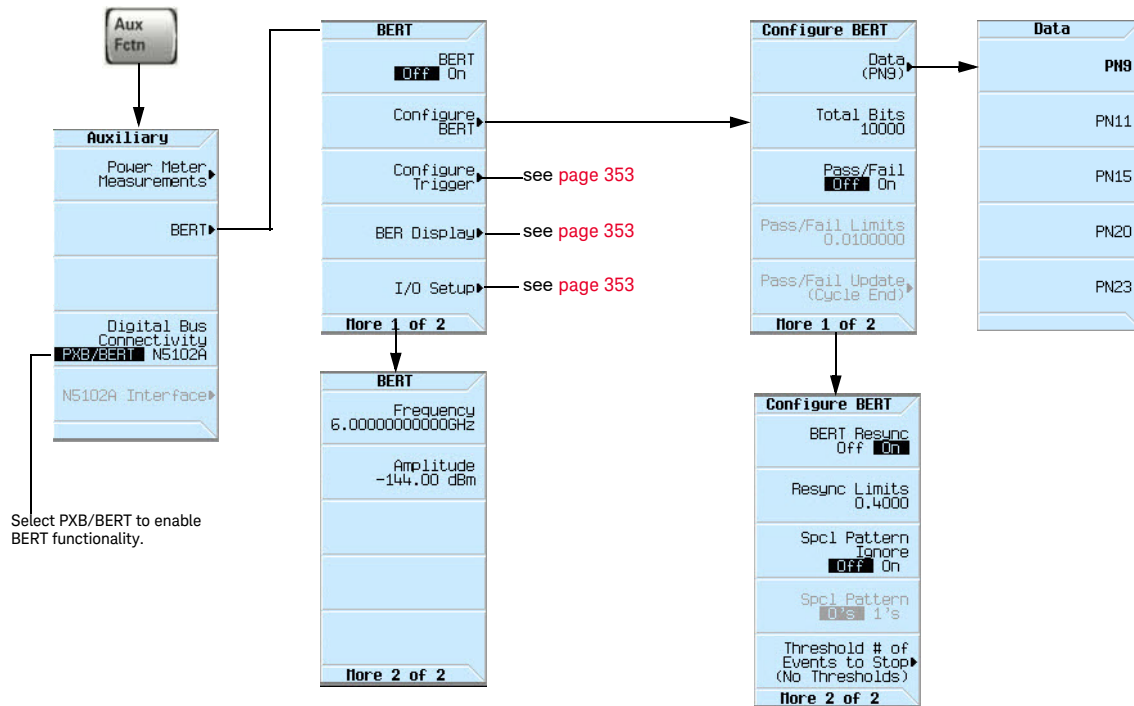
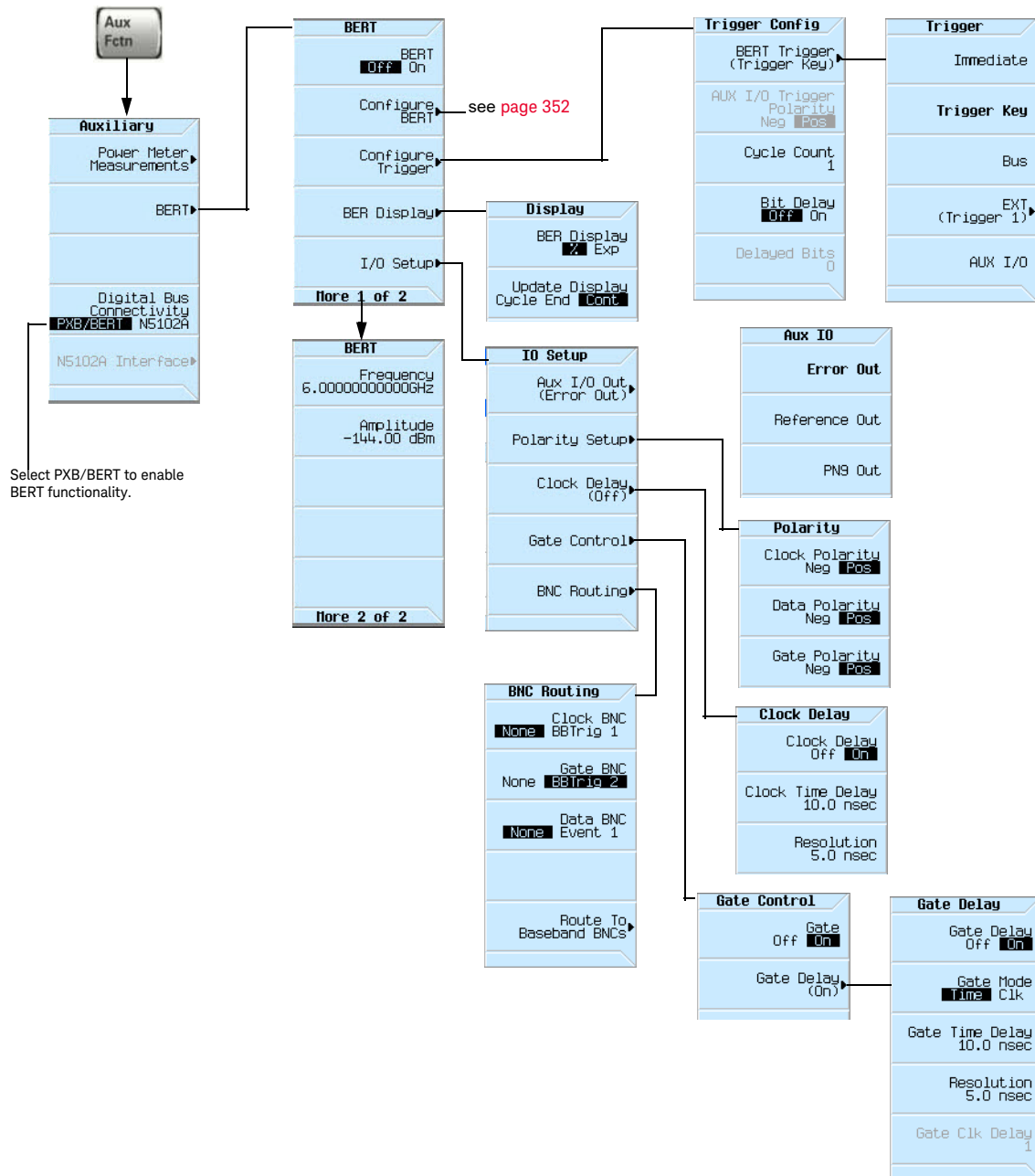




Figure 12-15 BERT I/O Setup Softkeys



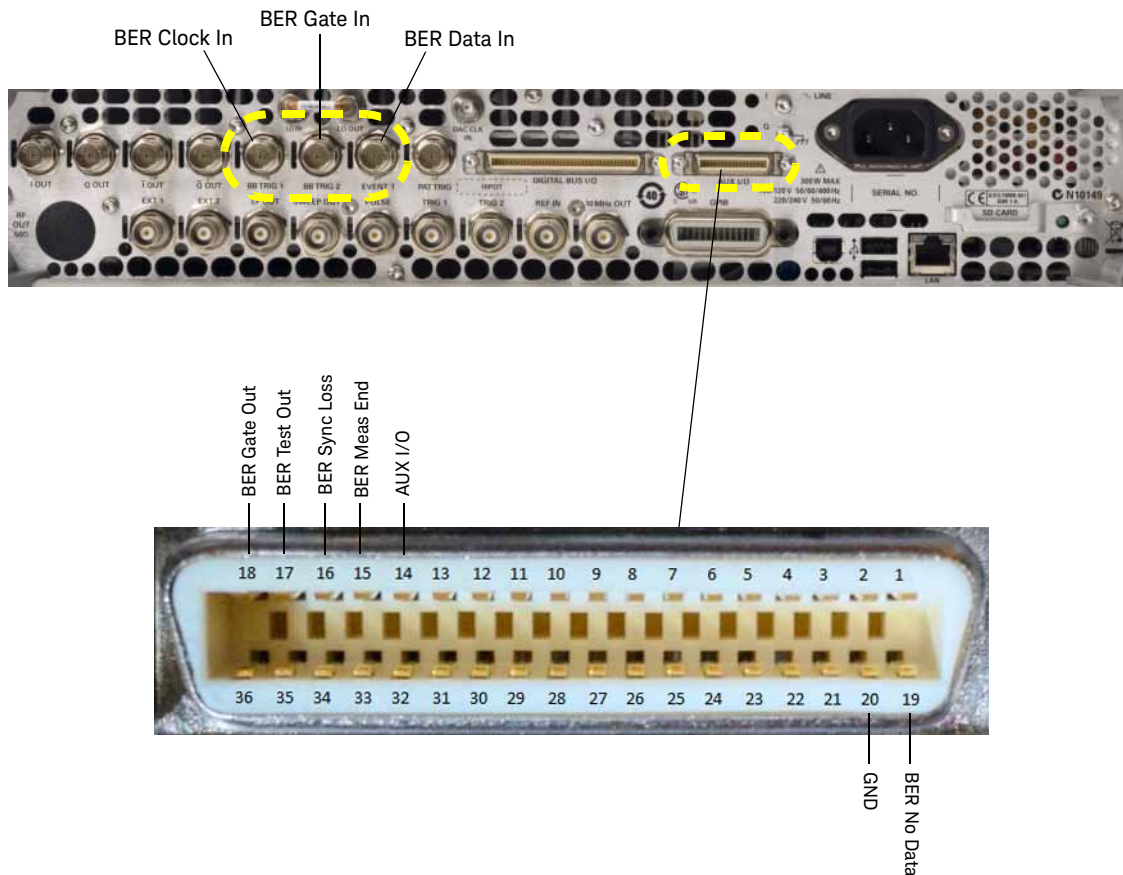
The highlighted BNC connectors in **Figure 12-16** are used for different signals in the BERT capability mode. The BERT-specific configuration is shown here. The AUX I/O connector configuration is customizable for the applications/options being used. **Figure 12-16** shows the rear panel connectors used for the BERT capability, and the configuration of the AUX I/O connector. For more information about the AUX I/O connector, refer to **Rear Panel Overview (N5171B, N5172B, N5181B, & N5182B)** on page 28.

## Measurement Setup Using Self-Test Mode

The following steps set up the signal generator for the BERT measurement self-test.

1. Refer to **Figure 12-16** and make the following connections on the signal generator's rear panel.
  - DATA OUT (Aux I/O connector pin 15) to BER DATA IN (BNC connector labeled EVENT 1).
  - DATA CLK OUT (Aux I/O connector pin 17) to BER CLK IN (BNC connector labeled BB TRIG1).

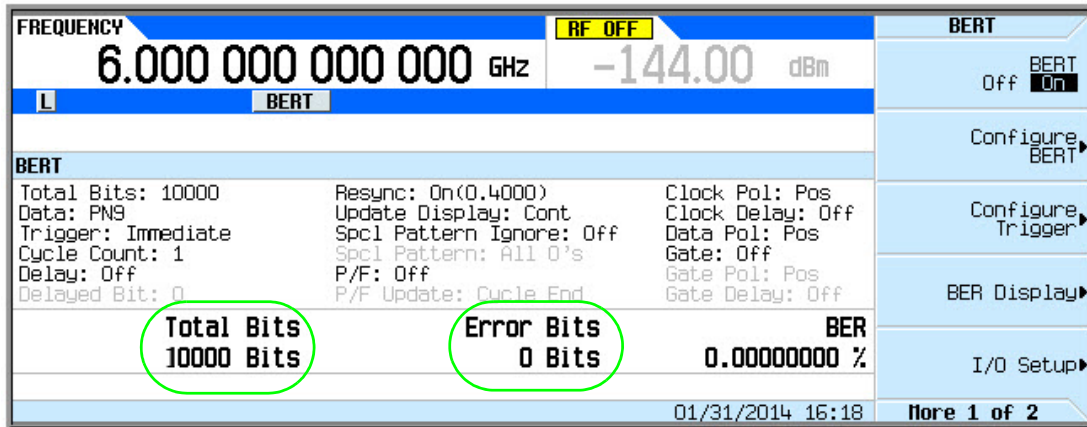
**Figure 12-16** Rear Panel Connectors for BERT Configuration



2. Press the **Preset** hardkey. This configures the signal generator to a pre-defined state.
3. Press the **Aux Fctn** hardkey.
4. Press **Digital Bus Connectivity PXB/BERT N5102A to PXB/BERT > Confirm Changes > BERT > BERT Off On to On > BER Display > BER Display % Exp to % > Display Update Cycle End Cont to Cont.**
5. Press **BERT > I/O Setup > AUX I/O Out > PN9 Out.**
6. Press **Return > Configure Trigger > BERT Trigger > Immediate.**
7. Press **Return > BERT > On.**

The Total Bits will count to 10000 Bits (default setting) and the Error Bits should read 0 Bits. See [Figure 12-17](#).

Figure 12-17 Self-Test Mode Results



## Measurement Example Using Custom Digital Modulation (Requires Option N5180431B)

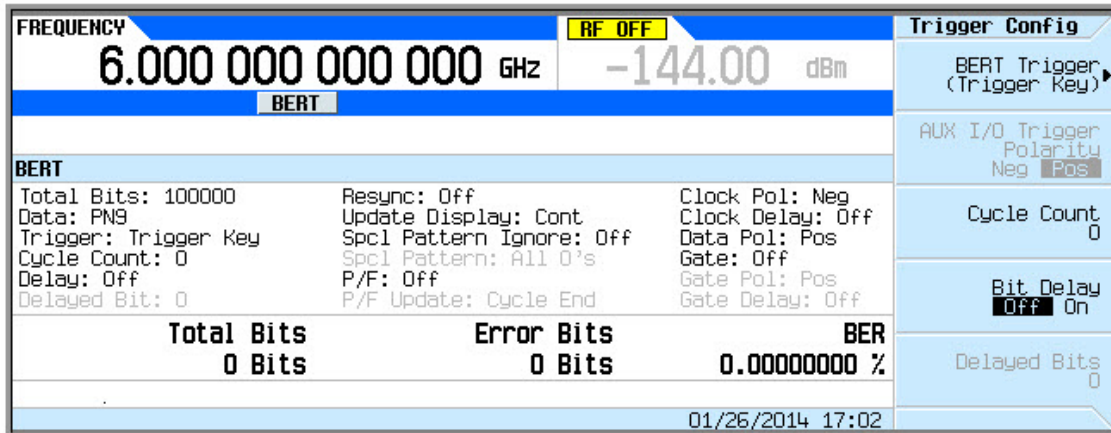
The following steps set up the signal generator for a BERT measurement using Custom Digital Modulation.

1. Refer to **Figure 12-16** and make the following connections on the signal generator's rear panel.
  - DATA OUT (Aux I/O connector pin 33) to BER DATA IN (BNC connector labeled EVENT 1).
  - DATA CLK OUT (Aux I/O connector pin 7) to BER CLK IN (BNC connector labeled BB TRIG1).
2. Press the **Preset** hardkey. This configures the signal generator to a pre-defined state.
3. Press the **Mode** hardkey.
4. Press **Real-Time Custom > Modulation Setup > Modulation Type > QPSK**.
5. Press **Return > Return > Return > Data > PN Sequence > More > PN9**.
6. Press **Return > More > More > Data/Clk/Sync Signal Polarity Setup > Data/Clk/Sync Rear Outputs On**.
7. Press the **Aux Fctn** hardkey.
8. Press **Digital Bus Connectivity PXB/BERT N5102A to N5102A > Confirm Changes > BERT > BERT Off On to On > BER Display > BER Display % Exp to % > Display Update Cycle End Cont to Cont**.

The following steps configure BERT measurement parameters.

9. Press **Return > Configure BERT > Total Bits to 100000 > Enter > More > Special Pattern Ignore Off On to Off**.
10. Press **BERT Resync Off On to Off > Return > Pass/Fail Off On to Off**.
11. Press **Return > I/O Setup > Gate Control > Gate Off On to Off**.
12. Press **Return > Polarity Setup > Clock Polarity Pos Neg to Neg > Data Polarity Pos Neg to Pos**.
13. Press **Return > Return > Configure Trigger > Cycle Count 0 > Enter**.
14. Press **Bit Delay Off On to Off > BERT Trigger to Trigger Key**.
15. Press the **Trigger** hardkey. **Figure 12-18** shows the signal generator's front-panel display after completion of these steps.

**Figure 12-18** Configuration Using Custom Digital Modulation



### BERT Verification

1. Press **BERT Trigger** to Immediate.

Notice the cycle counter updating in the lower left-hand corner of the signal generator display.

2. Disconnect the cable connecting the DATA OUT to BER DATA IN connectors.

Notice the **No Data** annunciator in the lower left corner of the display and the BER result is approximately 50%. The Error Bits counter updates the error bit count. Re-establishing the connection turns the annunciator off, and sets the error bits count to 0 bits and BER 0.00000000%.

3. Disconnect the cable connecting the DATA CLK OUT to BER CLK IN connectors.

Notice the **No Clock** annunciator in the lower left corner of the display. This annunciator turns off when you re-connect the cable, but the error bits counter and BER % readings indicate loss of synchronization.

4. Press **Return**.

Toggle the **BERT Off On** softkey to Off and to On. You will see the new BER result as shown in the previous front-panel display with the Error Bits counter reading 0 Bits and BER 0.00000000%.

If the verification procedures produce the expected results, then the signal generator BERT measurement function is operating correctly. If the above procedure produces unexpected results, then contact the Keysight Service Center. For a list of Keysight Service Centers, refer to the X-Series Signal Generators Getting Started Guide.

BERT (Option N5180UN7B)  
Verifying BERT Operation

## 13 Real-Time Noise—AWGN (Option N5180403B)

### NOTE

With firmware version B.01.75 or later, option numbers for software internal to the instrument have changed. For more information, see [“Enabling an Option” on page 53](#).

---

Before using this information, you should be familiar with the basic operation of the signal generator. If you are not comfortable with functions such as setting the power level and frequency, refer to [Chapter 3, “Basic Operation”, on page 57](#) and familiarize yourself with the information in that chapter.

This feature is available only in Keysight X-Series vector signal generators with Option N5180403B. Option N5180431B requires Option 653 or 655 (N5172B) or Option 656 or 657 (N5182B).

This chapter contains examples of using the additive white gaussian noise (AWGN) waveform generator.

- [Adding Real-Time Noise to a Dual ARB Waveform](#) on page 360
- [Using Real Time I/Q Baseband AWGN](#) on page 366

## Adding Real-Time Noise to a Dual ARB Waveform

### NOTE

The procedures in this section that pertain specifically to adding Real-Time Noise (AWGN) to a waveform, are applicable to the Custom ARB, Multitone, and Two-Tone modulation standards too.

---

A vector signal generator with Option N5180403B enables you to apply additive white gaussian noise (AWGN) to a carrier in real time while the modulating waveform plays in the dual ARB waveform player. This feature appears in each of the arb formats and as a stand-alone menu (Refer to [Figure 13-7 on page 366](#)).



Figure 13-1 Real Time I/Q Baseband AWGN Softkeys

For details on each key, use key help as described on page 58.

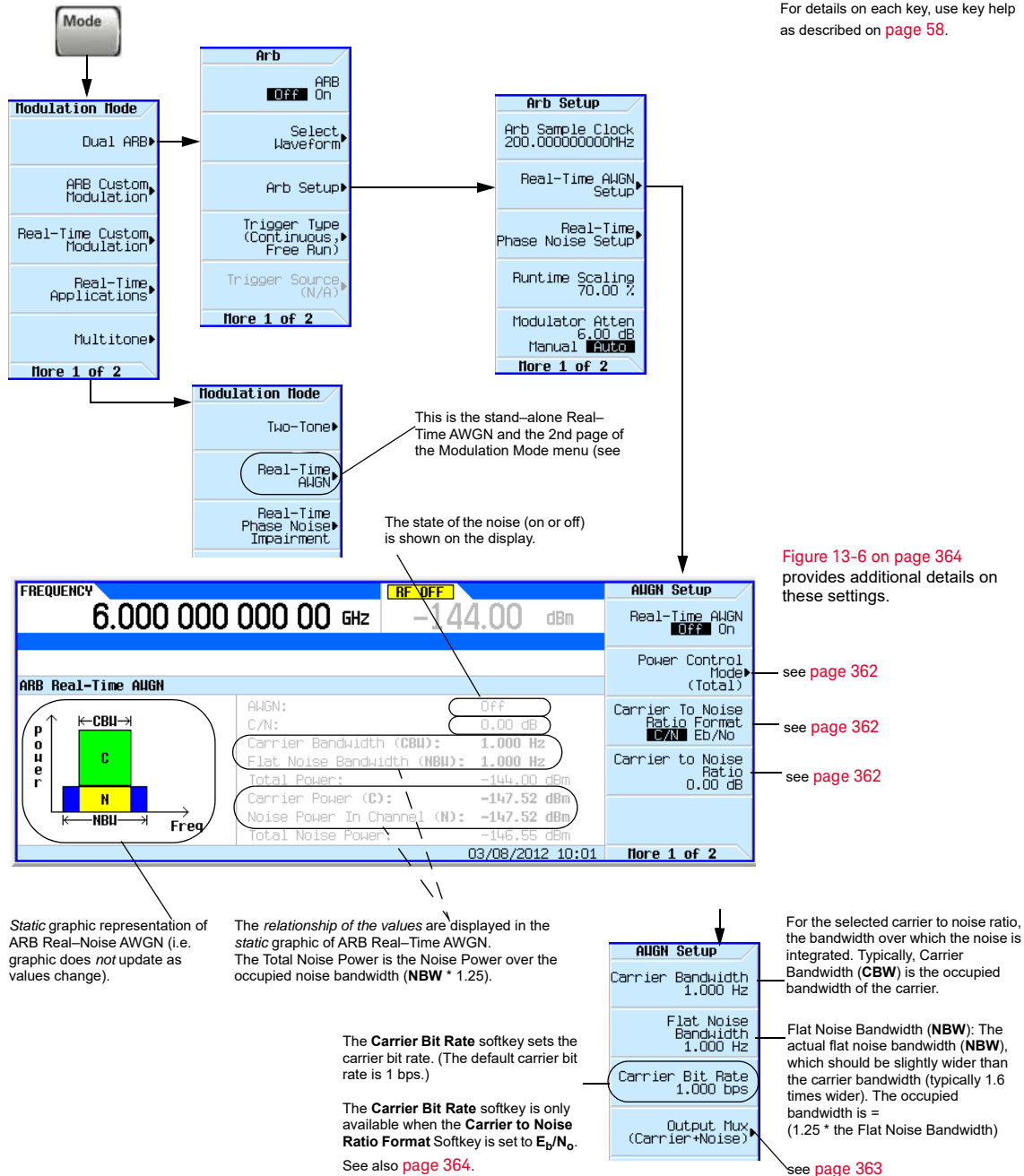


Figure 13-2 Real Time I/Q Baseband AWGN - Power Control Mode Softkeys

Mode > Dual ARB > Arb Setup >  
 Real-Time AWGN Setup

For details on each key, use key help  
 as described on [page 58](#).

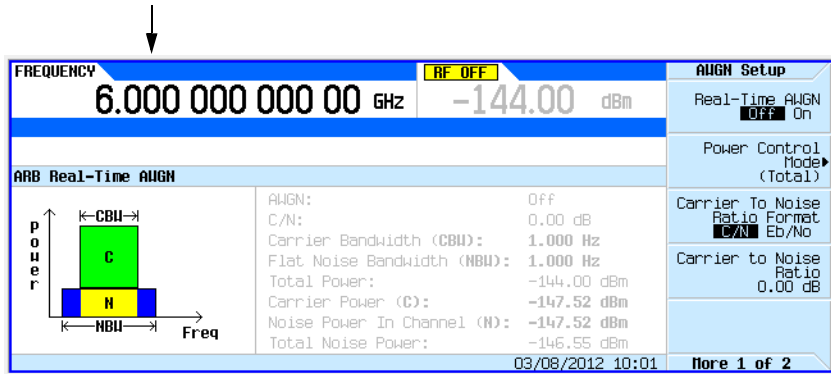
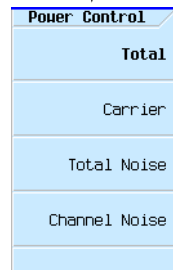


Figure 13-6 on [page 364](#)  
 provides additional details on  
 these settings.

— see [page 363](#)

Selecting **Total** as the power control mode makes the total power and C/N independent variables while making the carrier power and total noise power dependent variables. The dependent variables carrier power and total noise power are set by the total power, C/N, and the rest of the Noise settings. The carrier power and total noise power change as any noise parameter is adjusted to keep the total power and the C/N at their last specified values.

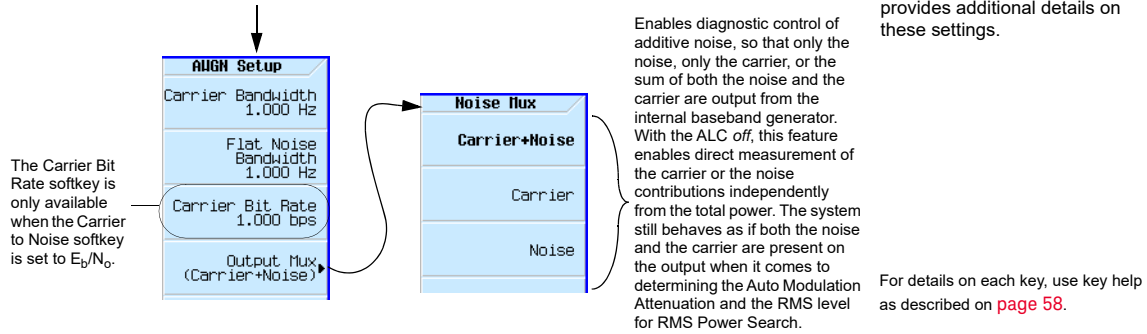


Selecting **Carrier** as the power control mode makes the carrier power and C/N independent variables while making the total power and total noise power dependent variables. The dependent variables total power and total noise power are set by the carrier power, C/N, and the rest of the Noise settings. The total power and total noise power change as any noise parameter is adjusted to keep the carrier power and the C/N at their last specified values.

Selecting **Total Noise** as the power control mode makes the total noise power and C/N independent variables while making the total power and carrier power dependent variables. The dependent variables total power and carrier power are set by the total noise power, C/N, and the rest of the Noise settings. The total power and carrier power change as any noise parameter is adjusted to keep the total noise power and the C/N at their last specified values.

Figure 13-3 Real Time I/Q Baseband AWGN - Noise Mux Menu Softkeys

Mode > Dual ARB > Arb Setup >  
 Real-Time AWGN Setup > More



### $E_b/N_0$ Adjustment Softkeys for Real Time I/Q Baseband AWGN

This feature allows the AWGN C/N to be set using the  $E_b/N_0$  (energy per bit over noise power density at the receiver or signal to noise ratio per bit) form. This requires the carrier bit rate to be known. Refer to Figure 13-4, “ $E_b/N_0$  Carrier Bit Equation.”

Figure 13-4  $E_b/N_0$  Carrier Bit Equation

$$\frac{C}{N_{dB}} = \left(\frac{E_b}{N_0}\right) dB + 10 \log_{10} \left( \frac{bitRate}{carrierBandwidth} \right)$$

Figure 13-5 Real Time I/Q Baseband AWGN -  $E_b/N_0$  Adjustment Softkeys

Mode > Dual ARB > Arb Setup > Real-Time AWGN Setup

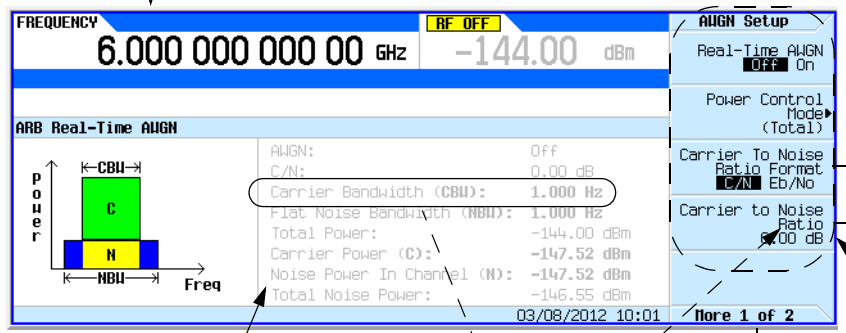


Figure 13-6 on page 364 provides additional details on these settings.

Selects either the Carrier to Noise Ratio (C/N) or energy per bit over noise power density at the receiver ( $E_b/N_0$ ) as the variable controlling the ratio of the carrier power to noise power in the carrier bandwidth. When  $E_b/N_0$  is selected, the second page of the AWGN Setup menu shows the **Carrier Bit Rate** softkey to enable the  $E_b/N_0$  value to be calculated.

The active softkey changes with the Carrier to Noise Ratio Format selected (C/N or  $E_b/N_0$ ). See below.

Display remains grayed out until real-time AWGN is enabled.

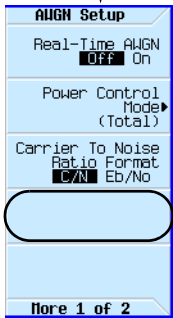
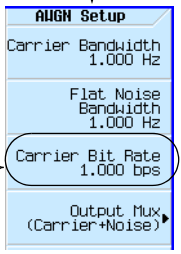
$E_b/N_0$  is displayed when **Carrier to Noise Ratio Format** softkey is set to  $E_b/N_0$ .



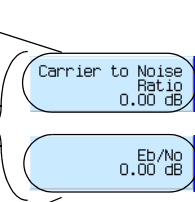
The **Carrier Bit Rate** softkey sets the carrier bit rate. (The default carrier bit rate is 1 bps.)

The **Carrier Bit Rate** softkey is only available when the **Carrier to Noise Ratio Format** Softkey is set to  $E_b/N_0$ .

To view the carrier bit rate equation, refer to [page 58](#).



Whether a softkey is available depends on the **Carrier to Noise Ratio Format** softkey setting (e.g. C/N or  $E_b/N_0$ ).



For details on each key, use key help as described on [page 58](#).

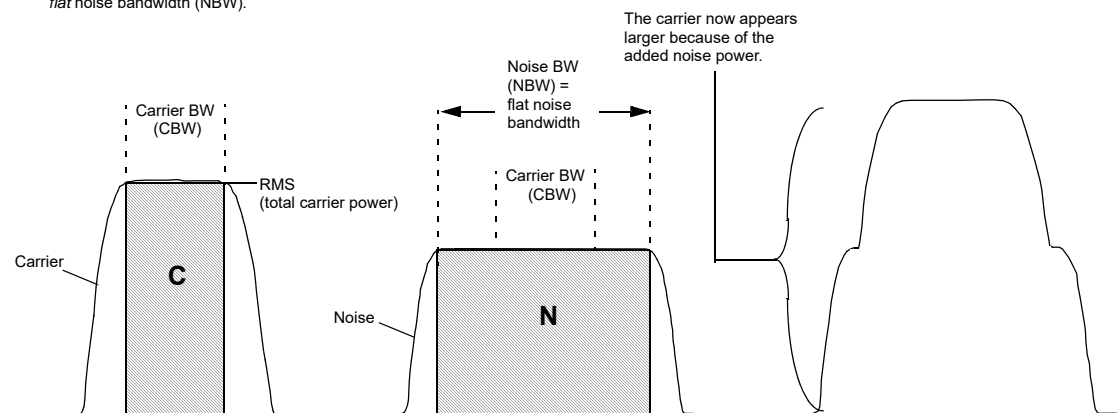
Figure 13-6 Carrier to Noise Ratio Components

Example

Use the following steps to modulate a 1 GHz, -10 dBm carrier with the factory-supplied waveform SINE\_TEST\_WFM, and then apply noise with a 45 MHz bandwidth signal that has a 30 dB carrier-to-noise ratio across a 40 MHz carrier bandwidth.

1. Preset the signal generator and set the following:

**Carrier Bandwidth (CBW)** is typically the occupied bandwidth of the carrier and the **Noise Bandwidth** is the *flat* noise bandwidth (NBW).

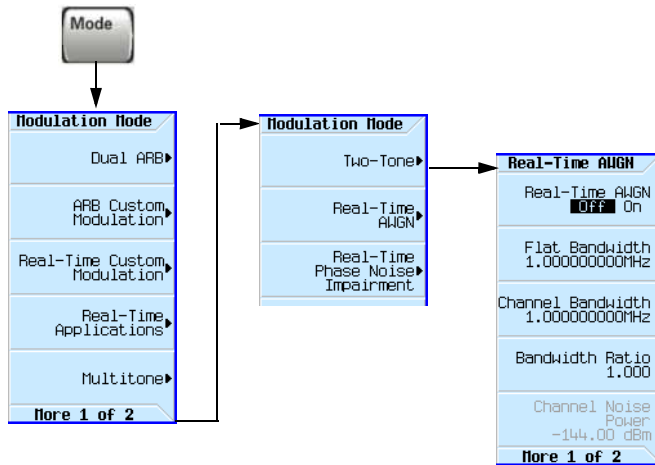


- Frequency: 1 GHz
  - Amplitude: -10 dBm
  - RF output: on
2. Select the factory-supplied waveform `SINE_TEST_WFM`:
    - a. Press **Mode** > **Dual ARB** > **Select Waveform**.
    - b. Highlight `SINE_TEST_WFM` and press **Select Waveform**.
  3. Turn on the dual ARB player: press **ARB Off On** to highlight On.
  4. Set the ARB sample clock to 50 MHz: Press **ARB Setup** > **ARB Sample Clock** > **50** > **MHz**.
  5. Press **Real-Time AWGN Setup** and set the following:
    - Carrier to Noise Ratio: 30 dB
    - Carrier Bandwidth: 40 MHz
    - Noise Bandwidth: 45 MHz
    - Real-time AWGN: on

The signal generator's displayed power level (-10 dBm) **includes** the noise power.

## Using Real Time I/Q Baseband AWGN

Figure 13-7 Real Time I/Q Baseband AWGN Softkeys



For details on each key, use key help as described on [page 58](#).

Use the following steps to apply 10 MHz bandwidth noise to a 500 MHz, -10 dBm carrier.

1. Configure the noise:
  - a. Preset the signal generator.
  - b. Press **Mode** > **More** > **Real-Time AWGN**
  - c. Press **Bandwidth** > **10** > **MHz**.

2. Generate the noise:

Press **Real-Time AWGN Off On** until On highlights.

During generation, the AWGN and I/Q annunciators activate (as shown at right). AWGN is now available to modulate the RF carrier.

FREQUENCY	AMPLITUDE
500.000 000 00 MHz	-10.00 dBm
I/Q	AWGN
Ampld: -10.00 dBm	Incr: 1.00dB

3. Configure the RF output:

- Frequency: 500 MHz
- Amplitude: -10 dBm
- RF output: on

The carrier with AWGN is now available at the signal generator's RF OUTPUT connector.

## 14 Real-Time Phase Noise Impairments (Option N5180432B)

### NOTE

With firmware version B.01.75 or later, option numbers for software internal to the instrument have changed. For more information, see [“Enabling an Option” on page 53](#).

---

Before using this information, you should be familiar with the basic operation of the signal generator. If you are not comfortable with functions such as setting the power level and frequency, refer to [Chapter 3, “Basic Operation”, on page 57](#) and familiarize yourself with the information in that chapter.

This feature is available only in Keysight X-Series vector signal generators with Option N5180431B. Option N5180431B requires Option 653 or 655 (N5172B) or Option 656 or 657 (N5182B).

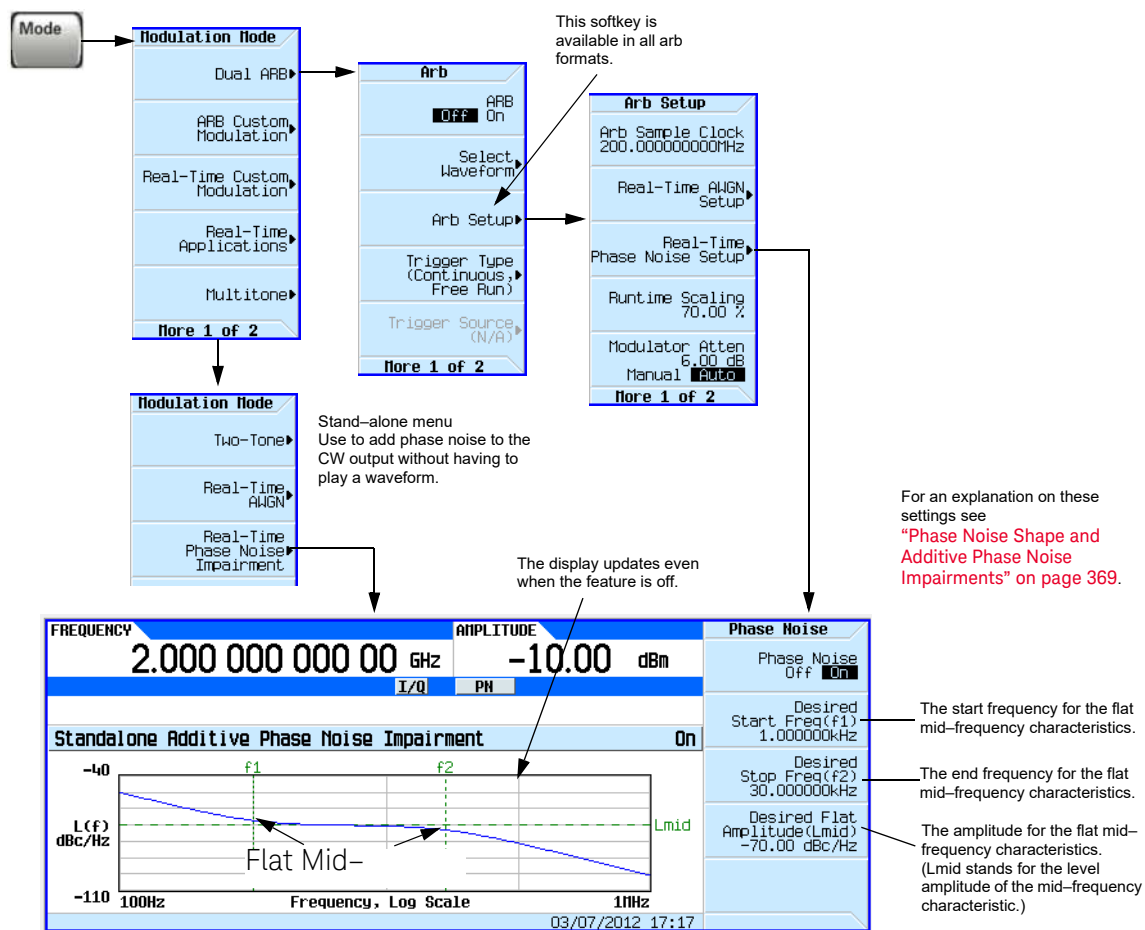
This chapter contains the softkey maps to locate the Phase Noise Impairment option functions and information on the use of this feature.

- [Real-Time Phase Noise Impairment](#) on page 368
- [Phase Noise Shape and Additive Phase Noise Impairments](#) on page 369
- [Understanding the Phase Noise Adjustments](#) on page 371
- [DAC Over-Range Conditions and Scaling](#) on page 372

## Real-Time Phase Noise Impairment

This feature lets you degrade the phase noise performance of the signal generator by controlling two frequency points and an amplitude value. The signal generator adds this phase noise to the phase noise normally produced by the signal generator. This feature appears in each of the arb formats and as a stand-alone menu. While the following figure shows how to access the controls using both the stand-alone menu and the Dual ARB player, the location and softkeys within each arb format is the same as for the Dual ARB player.

Figure 14-1 Stand-Alone and Dual ARB Player Real-Time Phase Noise Softkeys



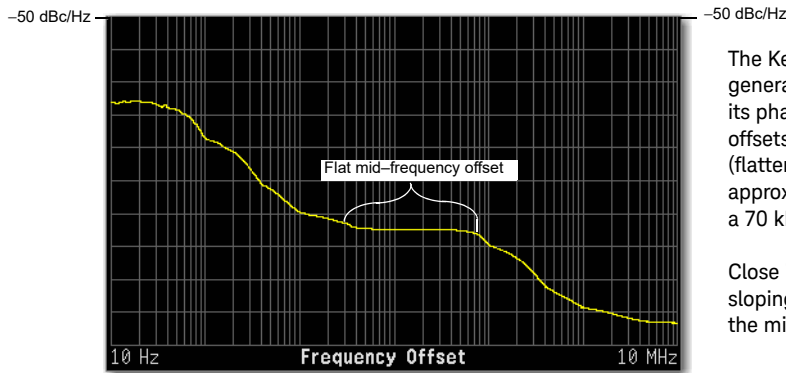
**NOTE:** The phase noise impairment is added to the base phase noise of the signal generator.

For details on each key, use key help as described on page 58.



## Phase Noise Shape and Additive Phase Noise Impairments

**Keysight X-Series Phase Noise Plots Without Phase Noise Impairment**



The Keysight X-Series vector signal generator demonstrates a definitive shape to its phase noise plot. The mid-frequency offsets are characterized by a leveling (flattening) of the phase noise amplitude from approximately a 3 kHz offset to approximately a 70 kHz offset.

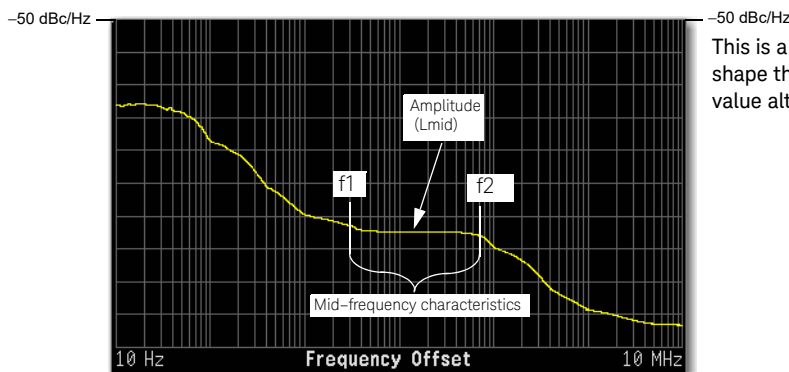
Close in and far out offsets demonstrate sloping characteristics (areas before and after the mid-frequency offsets).

The signal generator degrades the phase noise by moving the mid-frequency characteristics and/or changing its amplitude using the following settings:

Start frequency ( $f_1$ ) of the mid-frequency characteristics

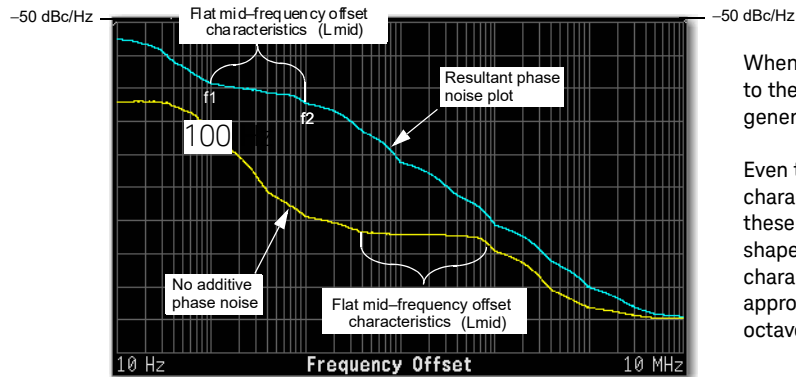
Stop frequency ( $f_2$ ) of the mid-frequency characteristics

Amplitude ( $L_{mid}$ ) of the mid-frequency characteristics



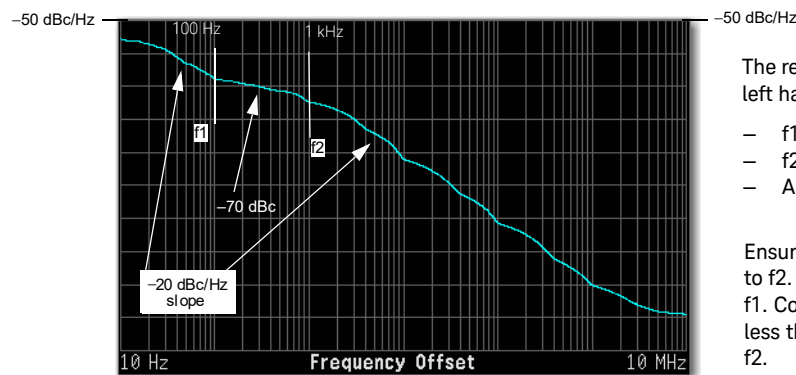
This is a plot of the unmodified phase noise shape that shows the location that each value alters.

### Phase Noise Plots With Phase Noise Impairments



When turned on, this phase noise is added to the base phase noise of the signal generator.

Even though it is only the mid-frequency characteristics placement that are modified, these changes affect the entire phase noise shape. The close in and far out offset characteristics change by exhibiting approximately a 20 dBc/Hz slope for each octave of frequency offset.

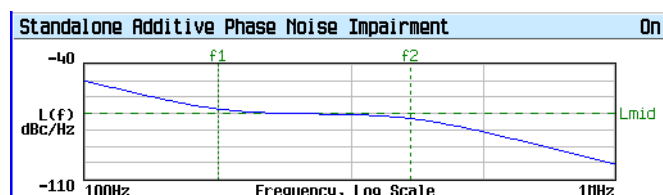


The resultant phase noise plot shown on the left has the following settings:

- f1 = 100 Hz
- f2 = 1 kHz
- Amplitude (Lmid) = -70 dBc

Ensure that the f1 value is less than or equal to f2. If not, f2 changes its value to match f1. Conversely if f2 is set to a value that is less than f1, f1 changes its value to match f2.

The frequency values entered for the impairments may not be the exact values when viewed on the RF output. The entered values are guidelines that the signal generator uses to calculate the real values. See [“Understanding the Phase Noise Adjustments” on page 371](#) for more information.



Signal generator front panel plot:

- f1 = 100 Hz
- f2 = 1 kHz
- Lmid = -70 dBc

## Understanding the Phase Noise Adjustments

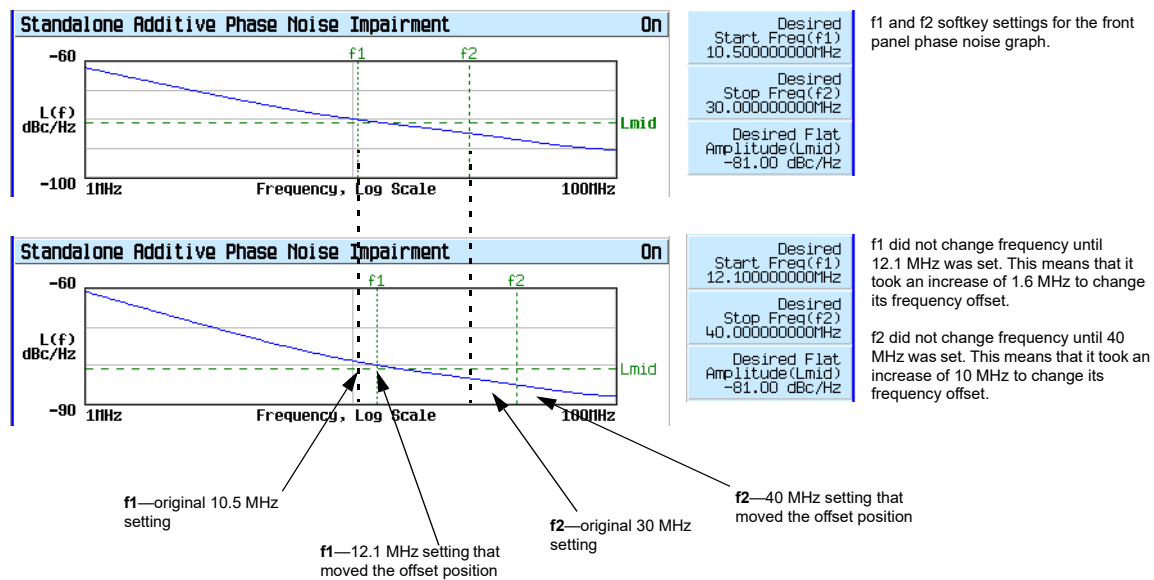
The signal generator bases the resultant phase noise shape on three settings, Lmid (amplitude), f1 (start frequency), and f2 (stop frequency).

The range for Lmid is coupled to f2, so as f2 increases in value, Lmid's upper boundary decreases. If the current Lmid setting is too high for the new f2 setting, the signal generator changes the Lmid value and generates an error to alert you to the change. In addition, the actual Lmid value can vary by 0.28 dBc/Hz from the entered value.

The frequency settings (f1 and f2) are really guidelines that the signal generator uses to calculate the real frequency offset values seen on the RF OUTPUT. This means that the entered start and stop frequency values are an approximation and may not be the values seen on a measurement instrument, however they will be close.

The effects of the f1 and f2 parameters are based on a varying logarithmic scale. This scale is determined by the f2 value. The higher the f2 value the larger the scale, which makes this behavior more noticeable at higher frequency settings. This becomes apparent when a change in the f1 or f2 value causes little to no change in the f1 or f2 position. This is easy to view using the signal generator's front panel phase noise graph and demonstrated in **Figure 14-2**. This behavior makes the frequency adjustments coarser as the f2 frequency value increases.

Figure 14-2 f1 and f2 Frequency Setting Behavior



For details on each key, use key help as described on [page 58](#).

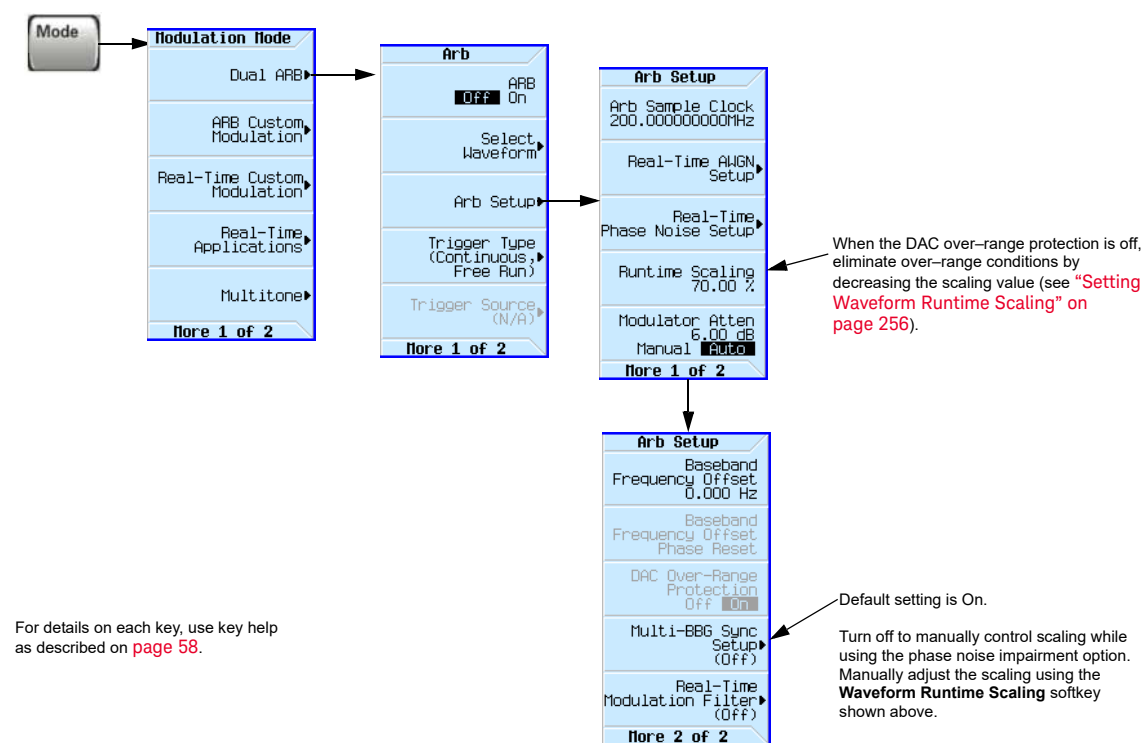
The only way to make an accurate determination of the effect of the f1 and f2 values is by viewing the front panel graph or making a measurement. You can view the front panel graph remotely by using the LXI interface. For more information on the LXI interface, see the *Programming Guide*.

## DAC Over-Range Conditions and Scaling

When using phase noise impairment, it is possible to create a DAC over-range condition, which causes the signal generator to generate an error. To minimize this condition with the phase noise impairment feature, the Keysight X-Series signal generator incorporates an automatic DAC over-range protection feature that scales down the I/Q data. Because it can scale the data by more than what is actually need, it typically decreases the dynamic range of the waveform. This is especially noticeable when using a constant amplitude signal such as GSM.

For the Dual ARB Player, the automatic over-range protection can be turned off (on is the factory default). The control for the Dual ARB DAC over-range protection feature is located in the key path as shown in **Figure 14-3**.

**Figure 14-3** Dual ARB DAC Over-Range Protection Softkey Location



In the Dual ARB Player, to avoid excessive scaling or to just perform scaling manually, turn the over-range protection off and use the **Waveform Runtime Scaling** softkey to eliminate DAC over-range conditions.

When the automatic feature is disabled, the other options to eliminate a DAC over-range condition are to reduce the f2 value, or the Lmid value, or both until the condition corrects itself.

## 15 Real-Time Fading (Option 660)

The feature described in this chapter is available only in Keysight N5172B EXG and N5182B MXG X-Series signal generators with Option 660 Upgrade Baseband Generator with Real-Time Capability.

Option 660 requires Option 653 or 655 (N5172B) or Option 656 or 657 (N5182B).

Before using the information in this chapter, you should be familiar with the basic operation of the signal generator. If you are not comfortable with functions such as setting the power level and frequency, refer to **Chapter 3, "Basic Operation", on page 57** and familiarize yourself with the information in that chapter.

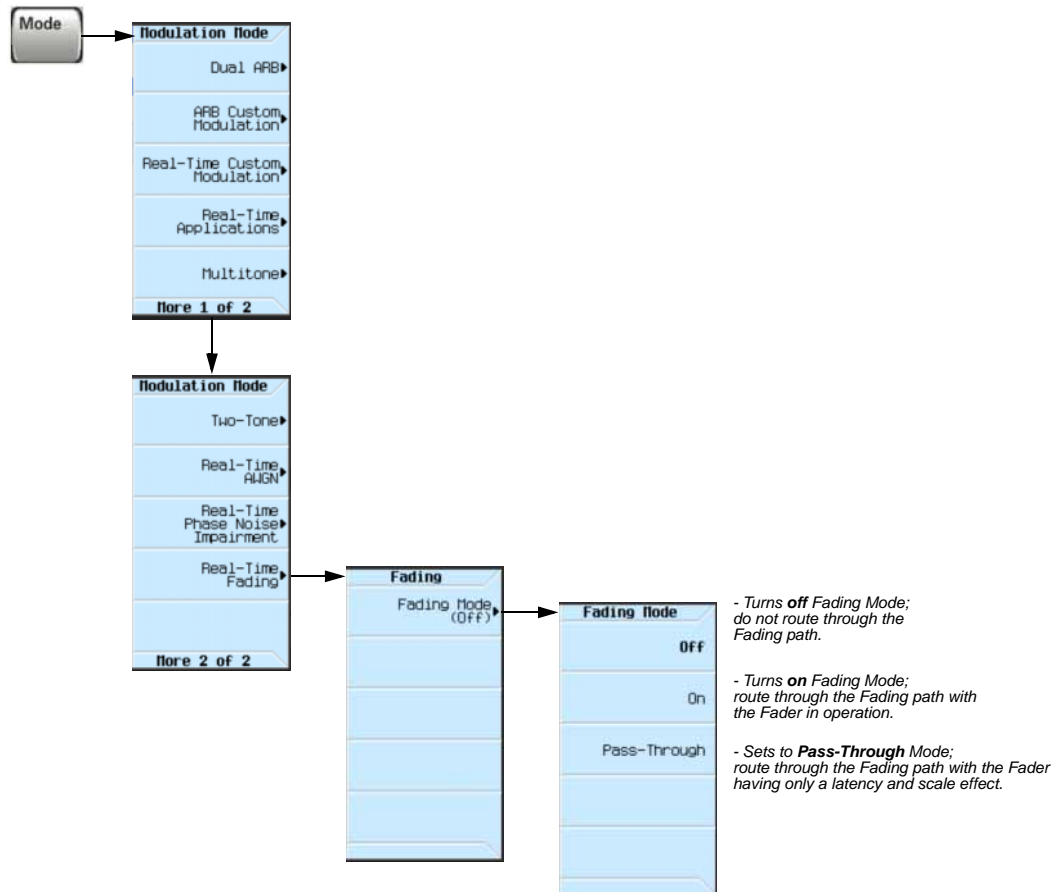
This chapter contains the softkey maps to locate the Real-Time Fading information for this feature.

– **Using Real-Time Fading Softkeys** on page 374

## Using Real-Time Fading Softkeys

This feature lets you open a menu to configure Real-Time Fading simulations.

Figure 15-1 Real-Time Fading Softkeys



For details on each key, use key help as described on [page 58](#).

## To configure a Real-Time Fading simulation

When configuring a Real-Time Fading simulation, perform the following steps:

1. Press **Mode**
2. Press **Fading Mode**  
(Default selection is **Off**.)
3. Select either: **Off | On | Pass-Through**
  - Selecting **Off** sets the state of the Real-Time Fading simulation to Off; do not route through the Fading path.
  - Selecting **On** sets the state of the Real-Time Fading simulation to On; route through the Fading path with the Fader in operation. When Real-Time Fading is On, the FADING annunciator appears in the same annunciator position as ALC OFF. See **3. Annunciators** on page 25.
  - Selecting **Pass-Through** sets the state of the Real-Time Fading simulation to Pass-Through; route through the Fading path with the Fader having only a latency and scale effect.

### NOTE

Before **Real-Time Fading** can be set to **On** or **Pass-Through**, a modulation format must be selected and **Real-Time Custom Modulation** must be set to **On**; if this is not done, an `Error: -221 Setting Conflict` is generated and written to the error queue.

If an error occurs, clear the error queue and turn on a modulation format.

To clear the error queue

1. Press **Error**
2. Press **Clear Error Queue(s)**.

To turn on a modulation format

1. Press **Mode**
  2. Press **Real-Time Custom Modulation**
  3. Press **Modulation Setup > Modulation Type** and select a modulation type.  
(Default selection is **QPSK**.)
  4. Press **Mode > More > Real-Time Custom Modulation** and change the selection to **On**.  
(Default selection is **Off**.)
  5. Press **Mode > Fading Mode**  
(Default selection is **Off**.)
  6. Select **On** or **Pass-Through**
-





## 16 Custom Digital Modulation (Option N5180431B)

### NOTE

With firmware version B.01.75 or later, option numbers for software internal to the instrument have changed. For more information, see [“Enabling an Option” on page 53](#).

---

Before using this information, you should be familiar with the basic operation of the signal generator. If you are not comfortable with functions such as setting the power level and frequency, refer to [Chapter 3, “Basic Operation”, on page 57](#) and familiarize yourself with the information in that chapter.

This feature is available only in Keysight X-Series vector signal generators with Option N5180431B. Option N5180431B requires Option 653 or 655 (N5172B) or Option 656 or 657 (N5182B).

- [Custom Modulation](#) on page 378
- [Creating and Using Bit Files](#) on page 386
- [Using Customized Burst Shape Curves](#) on page 391
- [Using the Arbitrary Waveform Generator](#) on page 397
- [Using Finite Impulse Response \(FIR\) Filters with Custom Modulation](#) on page 412
- [Modifying a FIR Filter Using the FIR Table Editor](#) on page 419
- [Differential Encoding](#) on page 422

## Custom Modulation

For creating custom modulation, the signal generator offers two modes of operation: the ARB custom modulation mode and the real-time custom modulation mode. The ARB custom modulation mode has built-in modulation formats such as NADC or GSM and pre-defined modulation types such as BPSK and 16QAM that can be used to create a signal. It also provides the flexibility to modify the digital format's attributes. The real-time custom modulation mode can be used to create custom data formats using built-in PN sequences or custom-user files along with various modulation types and different built-in filters such as Gaussian or Nyquist.

Both modes of operation are used to build complex, digitally modulated signals that simulate communication standards with the flexibility to modify existing digital formats, define or create digitally modulated signals, and add signal impairments.

### ARB Custom Modulation Waveform Generator

The signal generator's ARB Custom Modulation mode is designed for out-of-channel test applications. This mode can be used to generate data formats that simulate random communication traffic and can be used as a stimulus for component testing. Other capabilities of the ARB Custom Modulation mode include:

- configuring single or multicarrier signals. Up to 100 carriers can be configured.
- creating waveform files using the signal generator's front panel interface.

The waveform files, when created as random data, can be used as a stimulus for component testing where device performance such as adjacent channel power (ACP) can be measured. The `AUTOGEN_WAVEFORM` file, that is automatically created when you turn the ARB Custom Modulation on, can be renamed and stored in the signal generator's non-volatile memory. This file can later be loaded into volatile memory and played using the dual ARB waveform player.

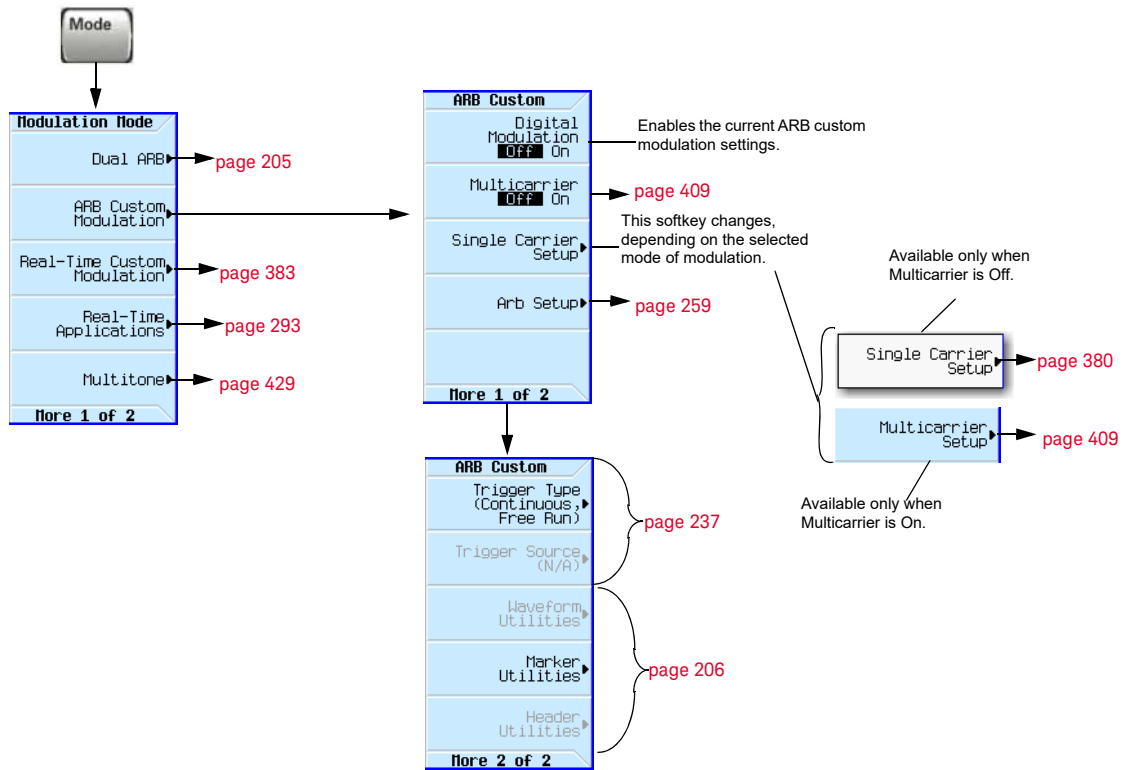
For more information, refer to [“Waveform File Basics” on page 205](#) and [“Modes of Operation” on page 19](#).

### Real-Time Custom Modulation Waveform Generator

The real-time mode simulates single-channel communication using user-defined modulation types along with custom FIR filters, and symbol rates. Data can be downloaded from an external source into PRAM memory or supplied as real-time data using an external input. The real-time I/Q baseband mode can also generate pre-defined data formats such as PN9 or FIX4. A continuous data stream generated in this mode can be used for receiver bit error analysis. This mode is limited to a single carrier. The real-time custom modulation mode:

- has more data and modulation types available than the ARB waveform generator mode
- supports custom I/Q constellation formats
- has the capability to generate continuous PN sequences for bit error rate testing (BERT)
- needs no waveform build time when signal parameters are changed.

Figure 16-1 ARB Custom Modulation Softkeys



For details on each key, use key help as described on page 58.

Figure 16-2 Quick Setup Softkeys

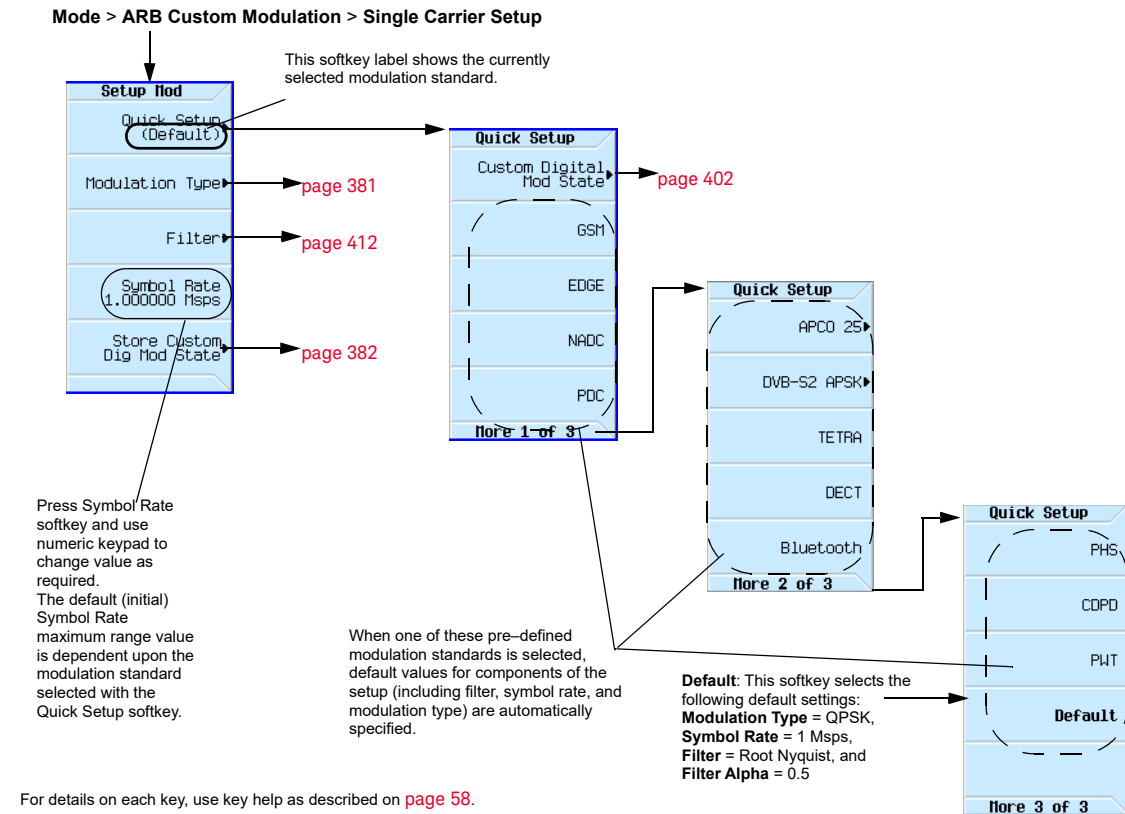
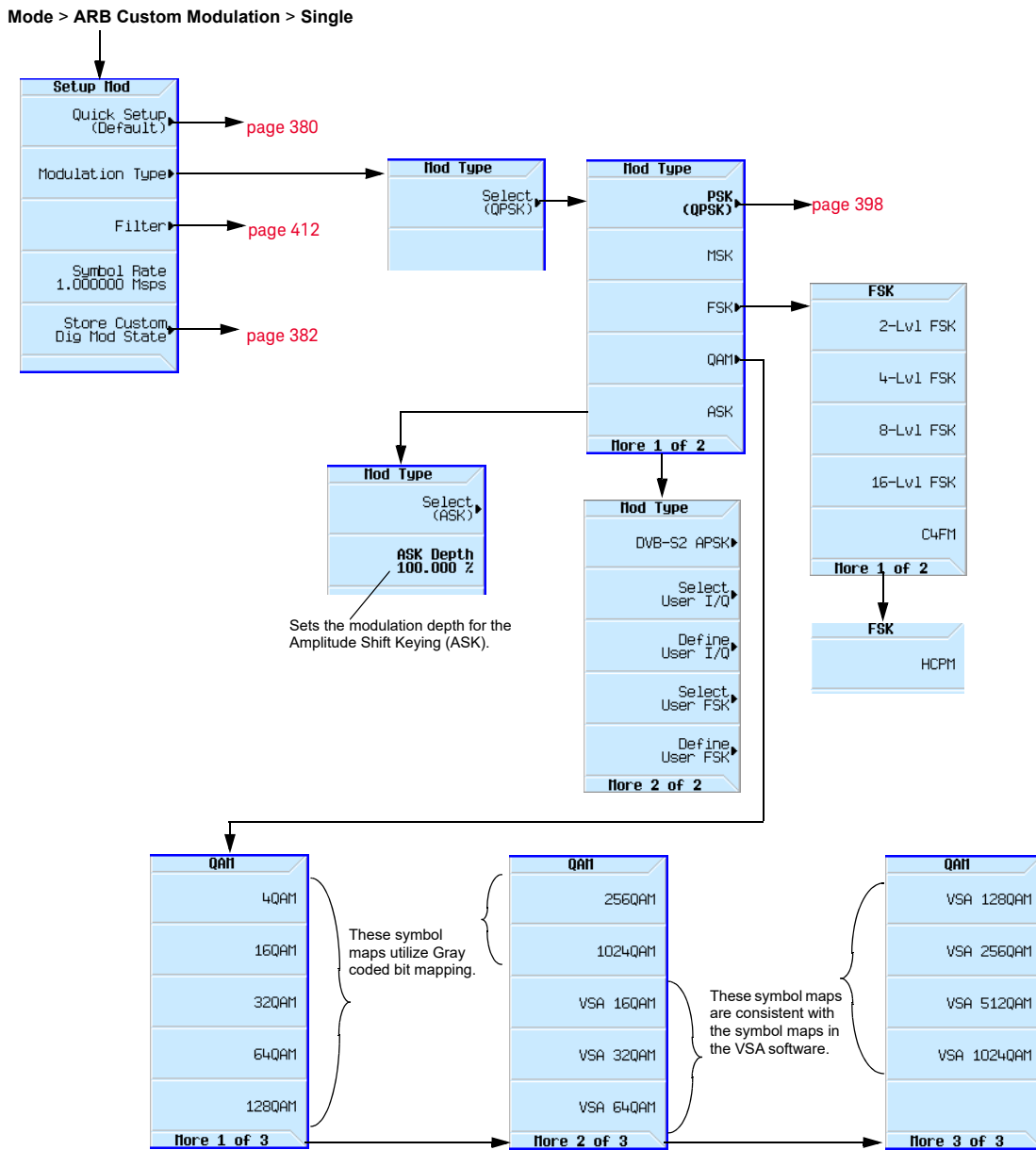


Figure 16-3 Mod Type Softkeys



For details on each key, use key help as described on page 58.

Figure 16-4 Custom Modulation Formats and Applications

Modulation format	Application where used
MSK, GMSK	GSM, CDPD
BPSK	Deep space telemetry, cable modems
QPSK	Satellite, CDMA, NADC, TETRA, PHS, PDC, LMDS, DVB-S, cable (return path), cable modems, TFTS
QOQPSK	CDMA, satellite
FSK	DECT, paging, RAM mobile data, AMPS, CT2, ERMES, land mobile radio, public safety
8, 16 VSB	North American digital TV (ATV), broadcast, cable
8PSK	Satellite, aircraft
16 QAM	Microwave digital radio, modems, DVB-C, DVB-T
32 QAM	Terrestrial microwave, DVB-T
64 QAM	DVB-C, modems, broadband set top boxes, MMDS
256 QAM	Modems, DVB-C (Europe), Digital Video (US)

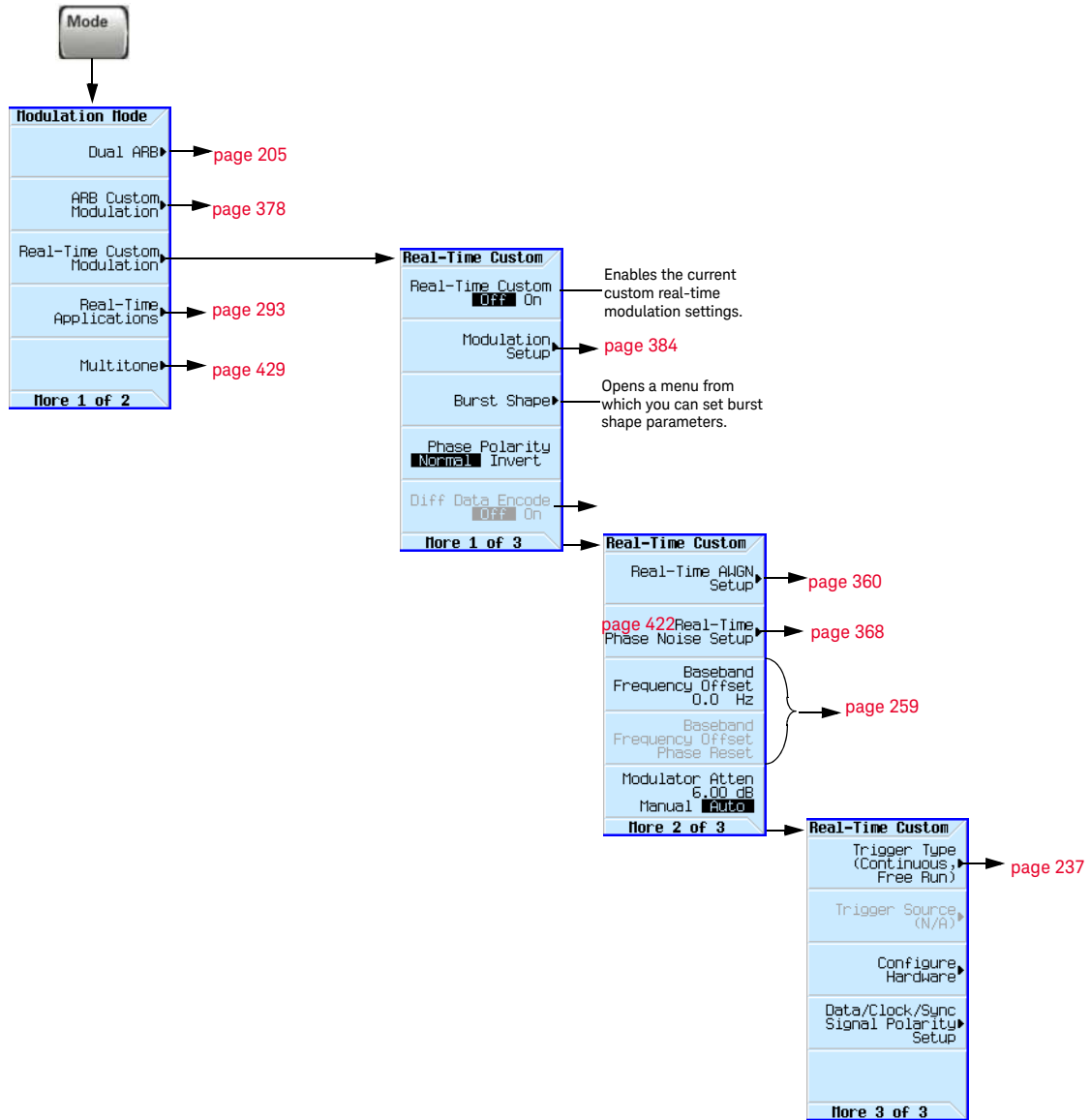
Figure 16-5 Store Custom Dig Mod State Softkeys

Mode > ARB Custom Modulation > Single Carrier Setup > Store Custom Dig Mod State

The screenshot shows the 'Store Custom Dig Mod State' screen. At the top, it displays 'FREQUENCY' as 6.000 000 000 00 GHz and 'AMPLITUDE' as -144.00 dBm. Below this is a 'Catalog of DMOD Files in Int Storage' table with columns for File Name, Type, Size, and Modified. A single entry is shown: '1 FIR\_EXAM DMOD 832 B 02/20/12 14:12'. To the right of the catalog are softkeys: 'Store To File', 'Delete File', and 'Goto Row'. The 'Store To File' softkey is linked to a 'Confirm Delete' dialog box. The 'Delete File' softkey is also linked to a 'Confirm Delete' dialog box. The 'Goto Row' softkey is linked to a 'Goto Row' menu with options: Enter, Goto Top Row, Goto Middle Row, and Goto Bottom Row. A red arrow points to the 'Confirm Delete' dialog boxes with the text 'page 401'. A note at the bottom states: 'Catalog displays digital modulation (DMOD) files that have been previously saved.'

For details on each key, use key help as described on page 58.

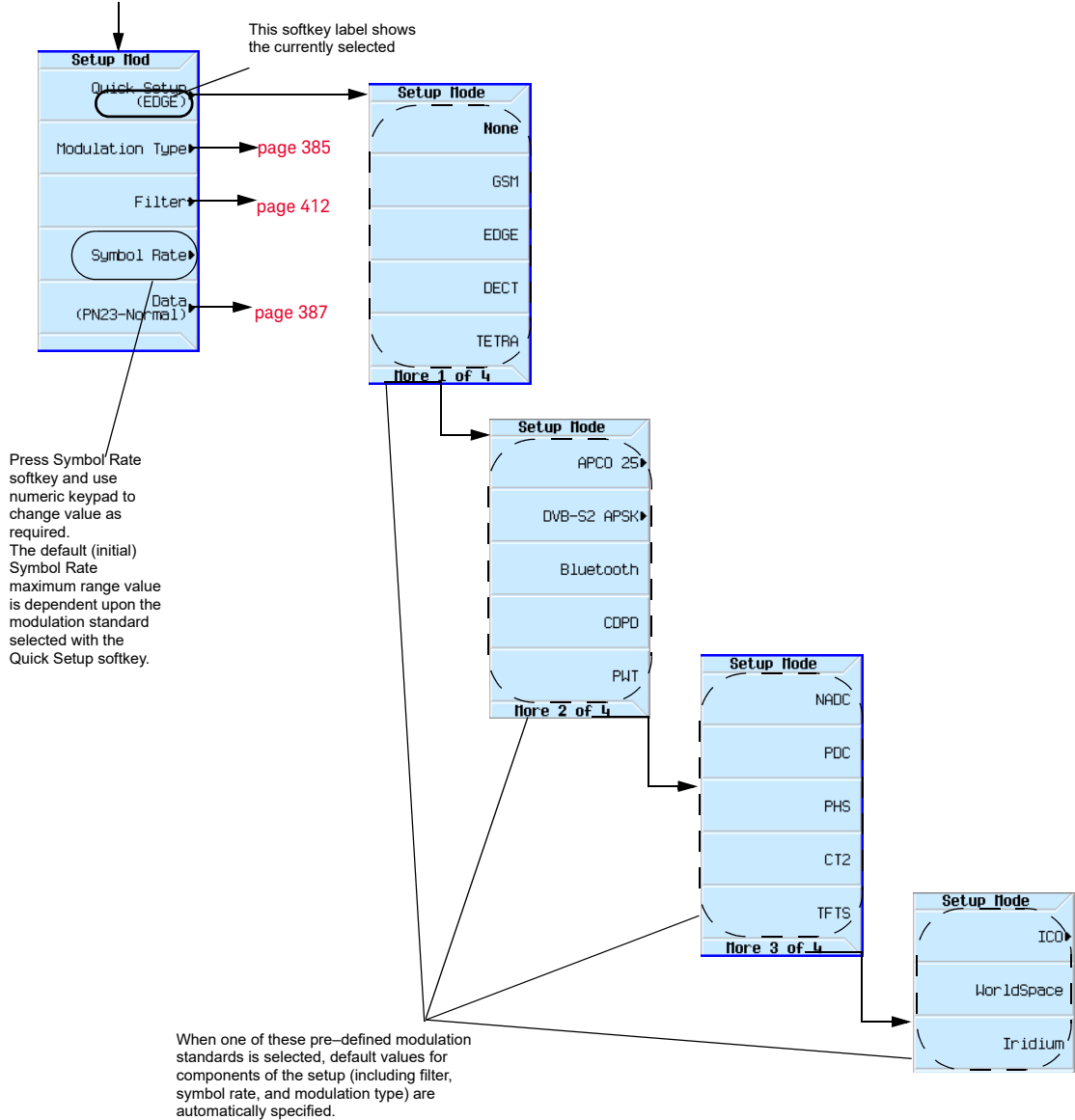
Figure 16-6 Real-Time Custom Modulation Softkeys



For details on each key, use key help as described on page 58.

Figure 16-7 Modulation Setup Softkeys

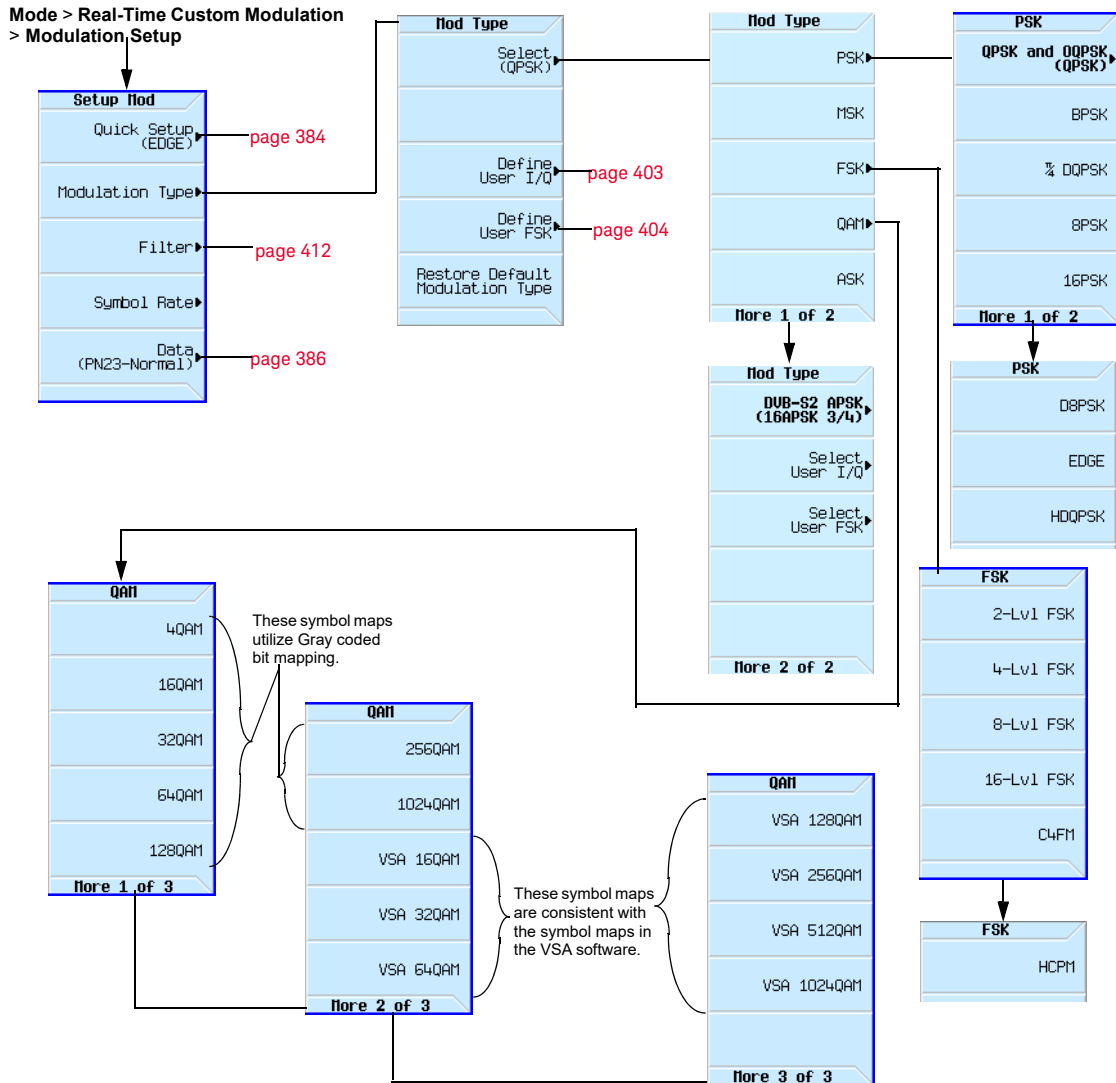
Mode > Real-Time Custom Modulation > Modulation Setup



For details on each key, use key help as described on page 58.



Figure 16-8 Modulation Type Softkeys



For details on each key, use key help as described on page 58.

## Creating and Using Bit Files

This procedure teaches you how to use the **Bit File Editor** to create, edit, and store user-defined files for data transmission within real time I/Q baseband generated modulation. For this example, a user file is defined within a custom digital communications format.

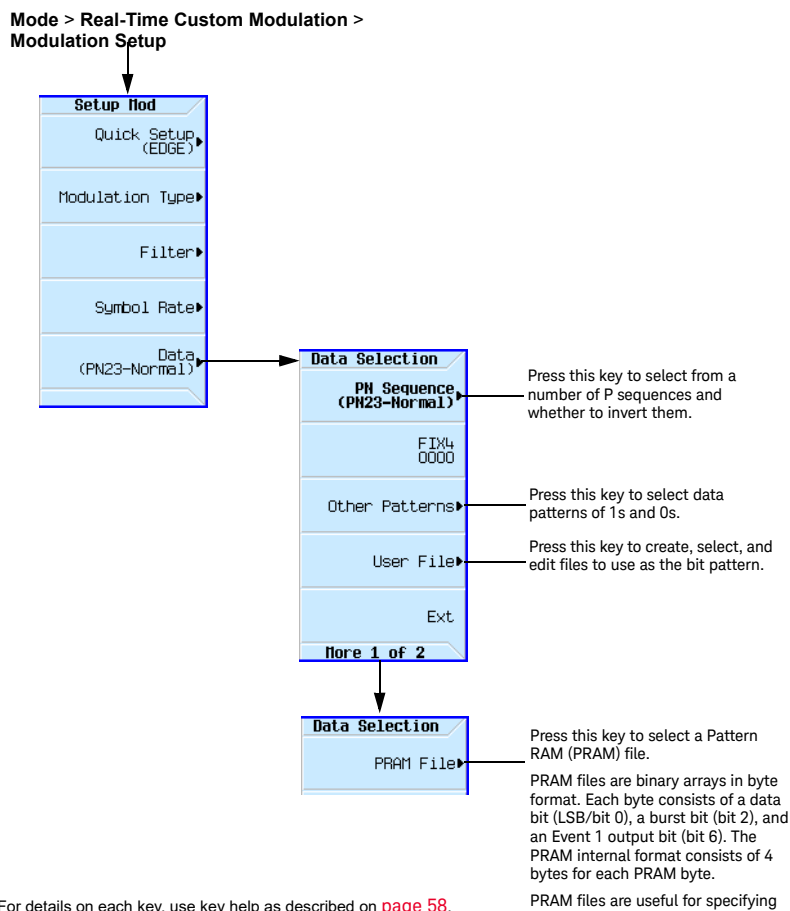
User files (user-defined data files) can be created on a remote computer and moved to the signal generator for subsequent modification, or they can be created and modified using the signal generator's **Bit File Editor**.

These user files can then be transmitted data as a continuous unframed data stream according to the protocol of the active format, transmitted as the data for a custom ARB modulation or real-time format. User files are not available for signals generated by the dual ARB waveform generator.

### NOTE

For information on creating user-defined data files on a remote computer, see the **Keysight Signal Generators Programming Guide**.

Figure 16-9 Data Selection Softkeys



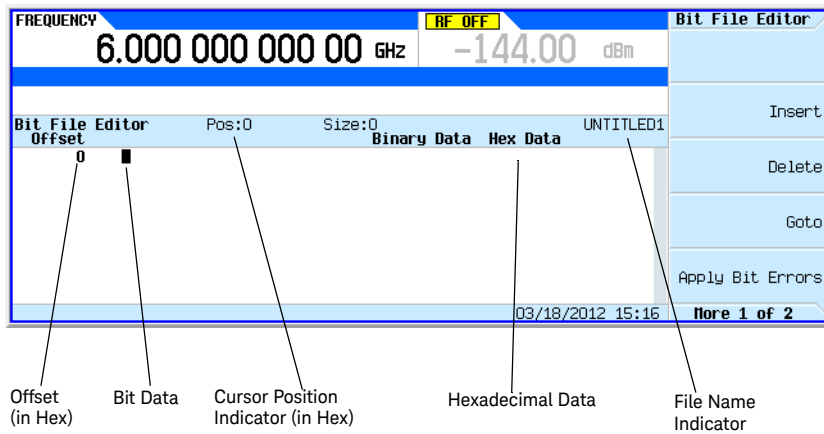
## Creating a User File

### Accessing the Table Editor

1. Press **Preset**.
2. Press **Mode** > **Real-Time Custom Modulation** > **Modulation Setup** > **Data** > **User File** > **Create File**.

This opens the Bit File Editor. The Bit File Editor contains three columns: Offset, Binary Data, and Hex Data, as well as cursor position (Position) and file name (Name) indicators, as shown in the following figure.

**Figure 16-10** Bit File Display



#### NOTE

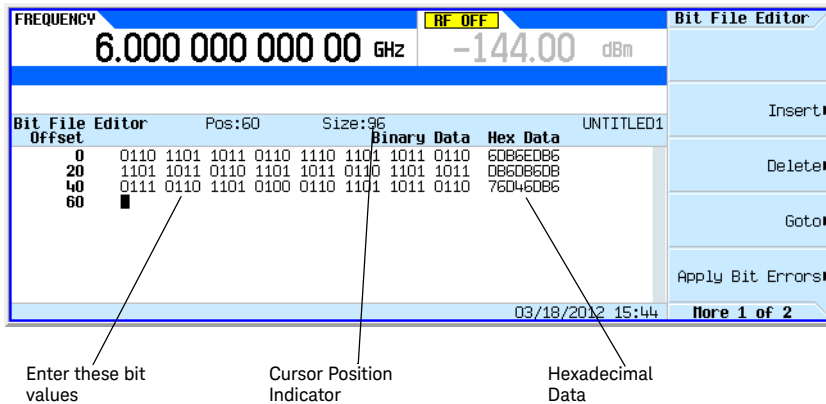
When you create new file, the default name appears as UNTITLED, or UNTITLED1, and so forth. This prevents overwriting previous files.

### Entering Bit Values

Bit data is entered into the table editor in 1-bit format. The current hexadecimal value of the binary data is shown in the Hex Data column, and the cursor position (in hexadecimal) is shown in the Position indicator.

1. Refer to the following figure.
2. Enter the 32 bit values shown.

Figure 16-11 Entering Bit Values



## Renaming and Saving a User File

In this example, you learn how to store a user file. If you have not created a user file, complete the steps in the previous section, [“Creating a User File” on page 387](#).

1. Press **More (1 of 2) > Rename > Editing Keys > Clear Text**.
2. Enter a file name (for example, `USER1`) using the alpha keys and the numeric keypad.
3. Press **Enter**.

The user file has now been renamed and stored to the Bit memory catalog with the name `USER1`.

## Recalling a User File

In this example, you learn how to recall a user-defined data file from the memory catalog. If you have not created and stored a user-defined data file, complete the steps in the previous sections, **“Creating a User File” on page 387** and **“Renaming and Saving a User File” on page 388**.

1. Press **Preset**.
2. Press **Mode** > **Real-Time Custom Modulation** > **Modulation Setup** > **Data** > **User File**.
3. Highlight the file **USER1**.
4. Press **Edit File**.

The Bit File Editor opens the file **USER1**.

## Modifying an Existing User File

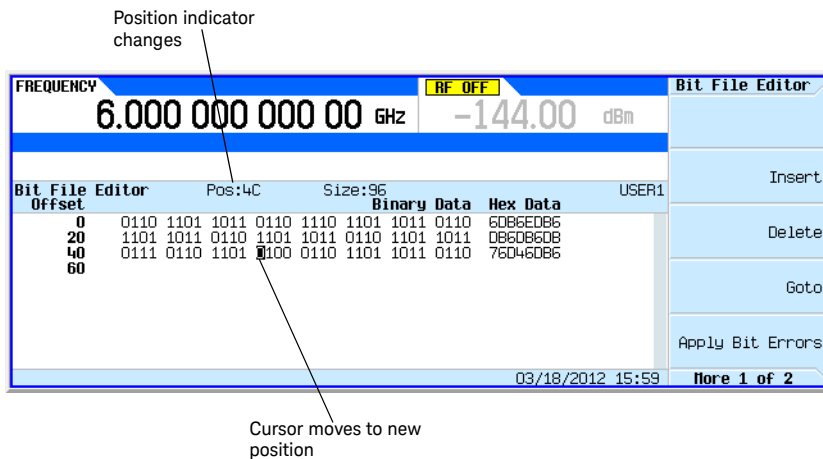
In this example, you learn how to modify an existing user-defined data file. If you have not created, stored, and recalled a user-defined data file, complete the steps in the previous sections, **“Creating a User File” on page 387**, **“Renaming and Saving a User File” on page 388** and **“Recalling a User File” on page 389**.

## Navigating the Bit Values

1. Press **Return** > **Goto** > **4** > **C** > **Enter**.

This moves the cursor to bit position 4C in the table, as shown in the following figure.

Figure 16-12 Navigating the Bit Values

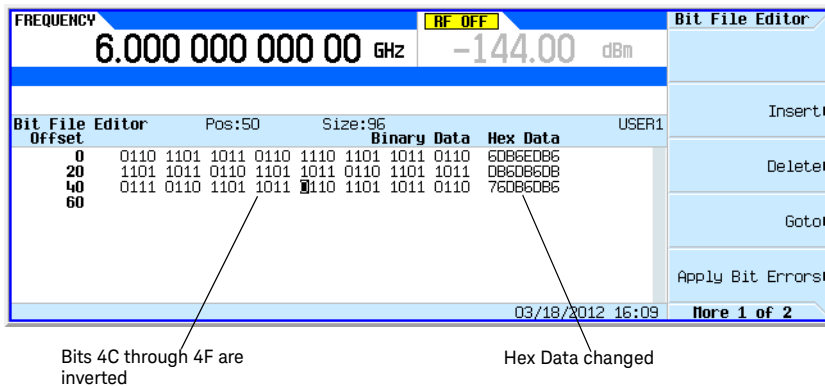


## Inverting Bit Values

### 1. Press 1011.

This inverts the bit values that are positioned 4C through 4F. Notice that hex data in this row has now changed to 76DB6DB6, as shown in the following figure.

Figure 16-13 Inverting Bit Values



## Applying Bit Errors to a User File

In this example, you learn how to apply bit errors to a user-defined data file. If you have not created and stored a user-defined data file, complete the steps in the previous sections, [“Creating a User File” on page 387](#) and [“Renaming and Saving a User File” on page 388](#).

1. Press **Apply Bit Errors**.
2. Press **Bit Errors > 5 > Enter**.
3. Press **Apply Bit Errors**.

Notice both **Bit Errors** softkeys change value as they are linked.

## Using Customized Burst Shape Curves

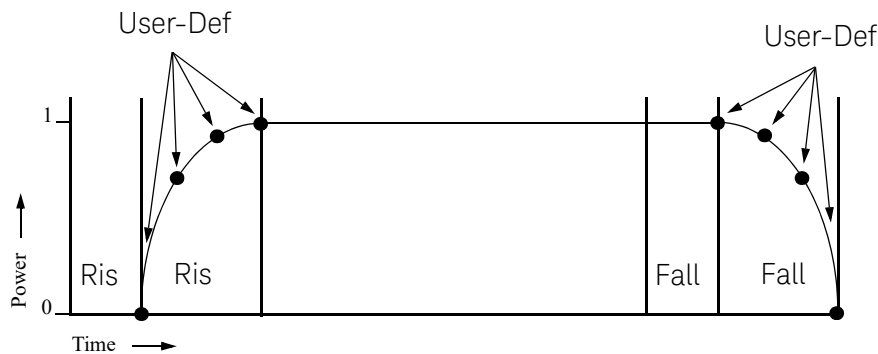
You can adjust the shape of the rise time curve and the fall time curve using the **Rise Shape** and **Fall Shape** editors. Each editor allows you to enter up to 256 values, equidistant in time, to define the shape of the curve. The values are then resampled to create the cubic spline that passes through all of the sample points.

The **Rise Shape** and **Fall Shape** table editors are available for custom real-time I/Q baseband generator waveforms.

## Understanding Burst Shape

The default burst shape of each format is implemented according to the standards of the format selected. You can, however, modify the following aspects of the burst shape:

Rise time	the period of time, specified in symbols or bits, where the burst increases from a minimum of $-70$ dB (0) to full power (1).
Fall time	the period of time, specified in symbols or bits, where the burst decreases from full power (1) to a minimum of $-70$ dB (0).
Rise delay	the period of time, specified in symbols or bits, that the start of the burst rise is delayed. Rise delay can be either negative or positive. Entering a delay other than zero shifts the full power point earlier or later than the beginning of the first useful symbol.
Fall delay	the period of time, specified in symbols or bits, that the start of the burst fall is delayed. Fall delay can be either negative or positive. Entering a delay other than zero shifts the full power point earlier or later than the end of the last useful symbol.
User-defined burst shape	up to 256 user-entered values which define the shape of the curve in the specified rise or fall time. The values can vary between 0 (no power) and 1 (full power) and are scaled linearly. Once specified, the values are resampled as necessary to create the cubic spline that passes through all of the sample points.

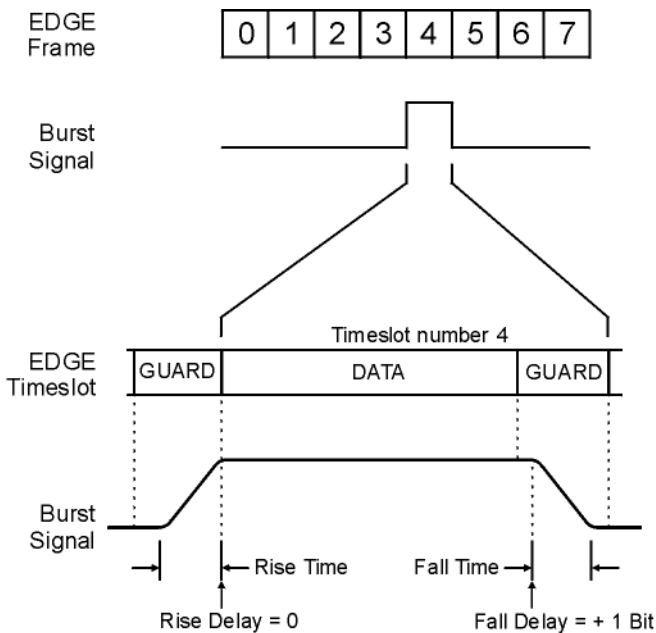


Burst shape maximum rise and fall time values are affected by the following factors:

- the symbol rate

- the modulation type

When the rise and fall delays equal 0, the burst shape is attempting to synchronize the maximum burst shape power to the beginning of the first valid symbol and the ending of the last valid symbol of the timeslot. The following figure illustrates a burst signal in an EDGE frame with a rise delay of 0 and a fall delay of +1 bit.



pk743b

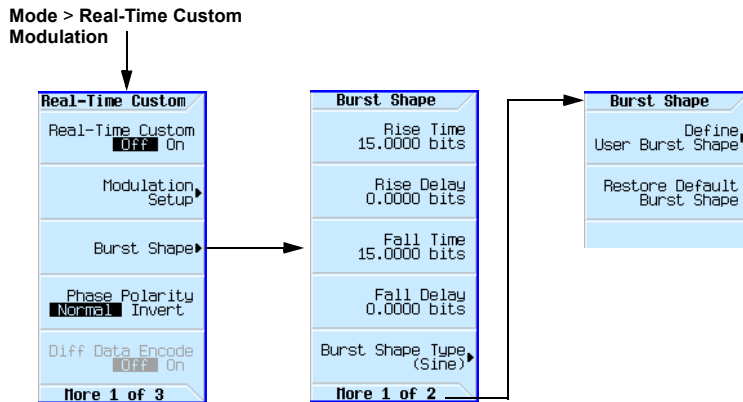
The signal generator firmware computes optimum burst shape based on the settings you've chosen for modulation. You can further optimize burst shape by lining up the data portion with the modulation. For example, if you're designing a new modulation scheme, do the following:

- Adjust the modulation and filtering to set the spectrum you want.
- Adjust the burst rise and fall delay and rise and fall time for the timeslots.

If you find that the error vector magnitude (EVM) or adjacent channel power (ACP) increases when you turn bursting on, you can adjust the burst shape to assist with troubleshooting.



Figure 16-14 Burst Shape Softkeys



For details on each key, use key help as described on [page 58](#).

## Creating a User-Defined Burst Shape Curve

Using this procedure, you learn how to enter rise shape sample values and mirror them as fall shape values to create a symmetrical burst curve.

This section teaches you how to perform the following tasks:

- “[Accessing the Table Editors](#)” on [page 393](#)
- “[Entering Sample Values](#)” on [page 394](#)

### Accessing the Table Editors

1. Press **Preset**.
2. Press **Mode > Real-Time Custom Modulation > Burst Shape**.
3. Press **More > Define User Burst Shape > More (1 of 2) > Delete All Rows > Confirm Delete Of All Rows**.

## Entering Sample Values

Use the sample values in the following table.

Rise Shape Editor			
Sample	Value	Sample	Value
0	0.000000	4	0.830000
1	0.400000	5	0.900000
2	0.600000	6	1.000000
3	0.750000		

1. Highlight the value (1.000000) for sample 1.
2. Press **.4** > **Enter**.
3. Press **.6** > **Enter**.
4. Enter the remaining values for samples 3 through 6 from the table above.
5. Press **Return** > **Edit Fall Shape** > **Load Mirror Image of Rise Shape** > **Confirm Load Mirror Image Of Rise Shape**.

This changes the fall shape values to a mirror image of the rise shape values, as shown in [Figure 16-15 on page 394](#).

**Figure 16-15** Mirror Image of Rise Shape

The screenshot shows the Rise Shape Editor interface. At the top, it displays 'FREQUENCY 6.000 000 000 00 GHz', 'RF OFF', and 'User Fall Burst -144.00 dBm'. Below this, there are two tables side-by-side. The left table is 'Rise Shape Editor (UNSTORED)' and the right table is 'Fall Shape Editor (UNSTORED)'. The Fall Shape Editor values are the mirror image of the Rise Shape Editor values. The 'Sample 1' value in the Fall Shape Editor is highlighted in red.

Rise Shape Editor (UNSTORED)		Fall Shape Editor (UNSTORED)	
Sample	Value	Sample	Value
0	0.000000	0	1.000000
1	0.400000	1	0.900000
2	0.600000	2	0.830000
3	0.750000	3	0.750000
4	0.830000	4	0.600000
5	0.900000	5	0.400000
6	1.000000	6	0.000000
7	-----	7	-----

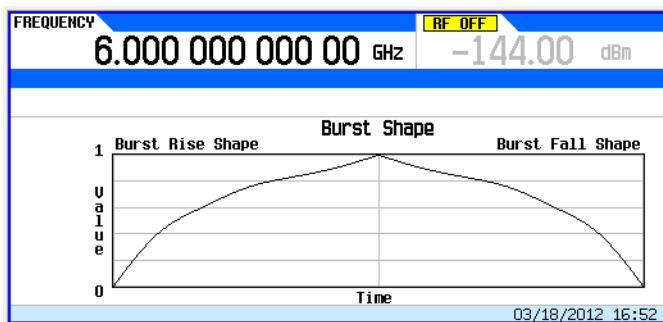
03/18/2012 16:46 **More 2 of 2**

## Display the Burst Shape

Press **Display Burst Shape**.

This displays a graphical representation of the waveform's rise and fall characteristics, as shown in [Figure 16-16](#).

Figure 16-16 Burst Shape



To return the burst to the default conditions, press the following keys:

**Return > Return > Return > Confirm Exit From Table Without Saving > Restore Default Burst Shape.**

## Storing a User-Defined Burst Shape Curve

1. Press **Define User Burst Shape > More (1 of 2) > Load/Store > Store To File.**

If there is already a file name from the **Catalog of SHAPE Files** occupying the active entry area, press the following keys:

**Editing Keys > Clear Text**

2. Enter a file name (for example, **NEWBURST**) using the alpha keys and the numeric keypad.

The maximum file name length is 23 characters (alphanumeric and special characters).

3. Press **Enter**.

The contents of the current **Rise Shape** and **Fall Shape** table editors are stored to the **Catalog of SHAPE Files**. This burst shape can now be used to customize a modulation or as a basis for a new burst shape design.

## Recalling a User-Defined Burst Shape Curve

Once a user-defined burst shape file is stored in memory, it can be recalled for use with real-time I/Q baseband generated digital modulation.

This example requires a user-defined burst shape file stored in memory. If you have not created and stored a user-defined burst shape file, complete the steps in the previous sections, [“Creating a User-Defined Burst Shape Curve” on page 393](#) and [“Storing a User-Defined Burst Shape Curve” on page 395](#).

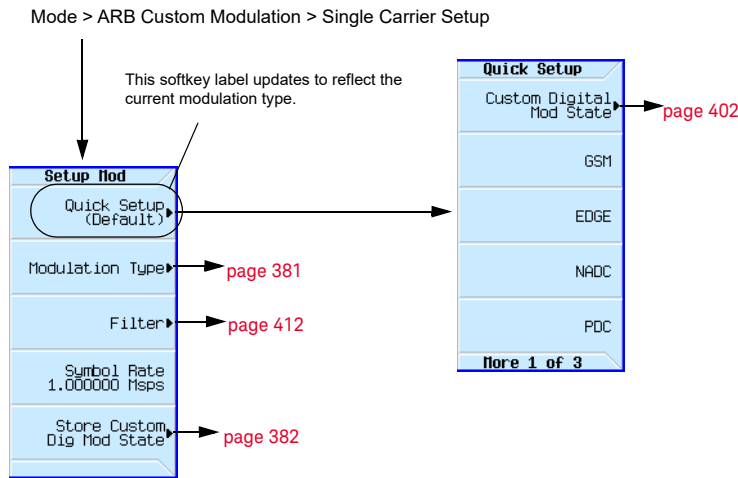
1. Press **Preset**.
2. Press **Mode** > **Real-Time Custom Modulation** > **Burst Shape** > **Burst Shape Type** > **User File**.
3. Highlight the desired burst shape file (for example, `NEWBURST`).
4. Press **Select File**.

The selected burst shape file is now applied to the current real time I/Q baseband digital modulation state.

## Using the Arbitrary Waveform Generator

This section teaches you how to build dual arbitrary (ARB) waveform files containing custom digital modulation for testing component designs.

Figure 16-17 Adding Custom Modulation to a Waveform



For details on each key, use key help as described on page 58.

## Using Predefined Custom Digital Modulation

This section teaches you how to perform the following tasks:

- [Selecting a Predefined EDGE Setup](#) on page 397
- [Generating the Waveform](#) on page 397
- [Configuring the RF Output](#) on page 397

### Selecting a Predefined EDGE Setup

1. Press **Preset**.
2. In the ARB Custom Modulation menu ([page 397](#)), press **Single Carrier Setup > Quick Setup > EDGE**.

### Generating the Waveform

Press **Digital Modulation Off On**.

This generates a waveform with the pre-defined EDGE state selected in the step. The display changes to **Dig Mod Setup: EDGE**. During waveform generation, the **DIGMOD** and **I/Q** annunciators appear and the pre-defined digital modulation state is stored in volatile memory (BBG). The waveform is now modulating the RF carrier.

### Configuring the RF Output

1. Set the RF output frequency to 891 MHz.

2. Set the output amplitude to  $-5$  dBm.

3. Press **RF On/Off**.

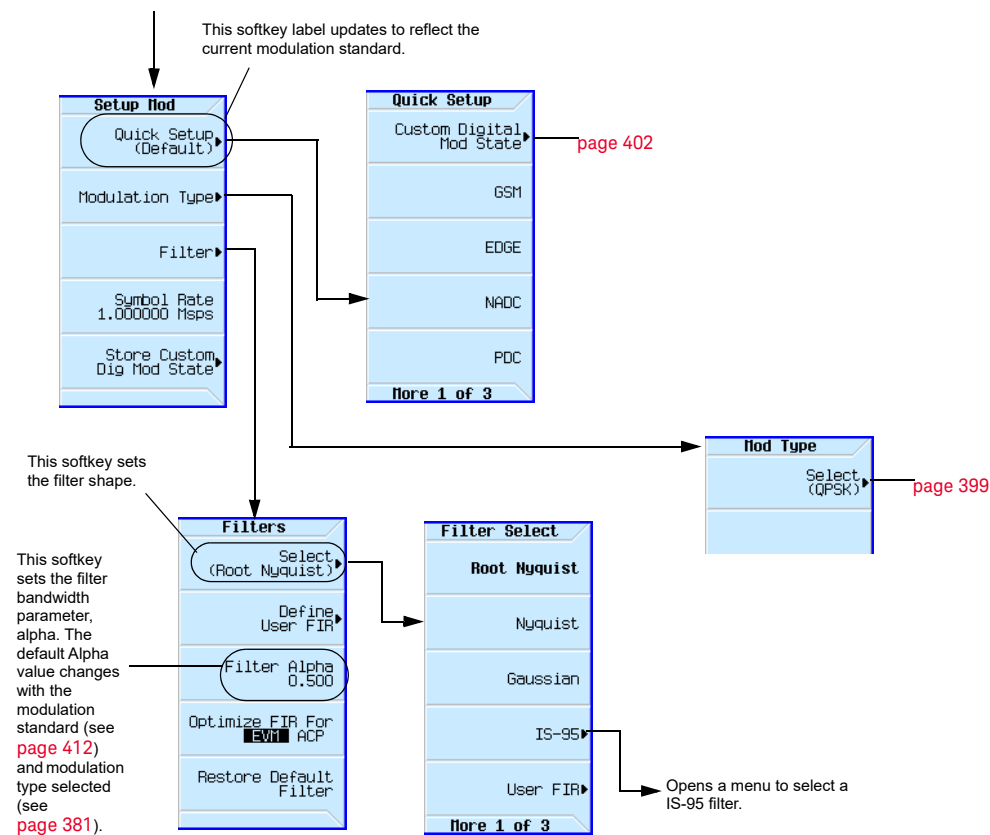
The predefined EDGE signal is now available at the signal generator's RF OUTPUT connector.

## Creating a Custom Digital Modulation State

In this procedure, you learn how to set up a single-carrier NADC digital modulation with customized modulation type, symbol rate, and filtering.

Figure 16-18 Setting a Digital Modulation Filter

Mode > ARB Custom Modulation > Single Carrier Setup

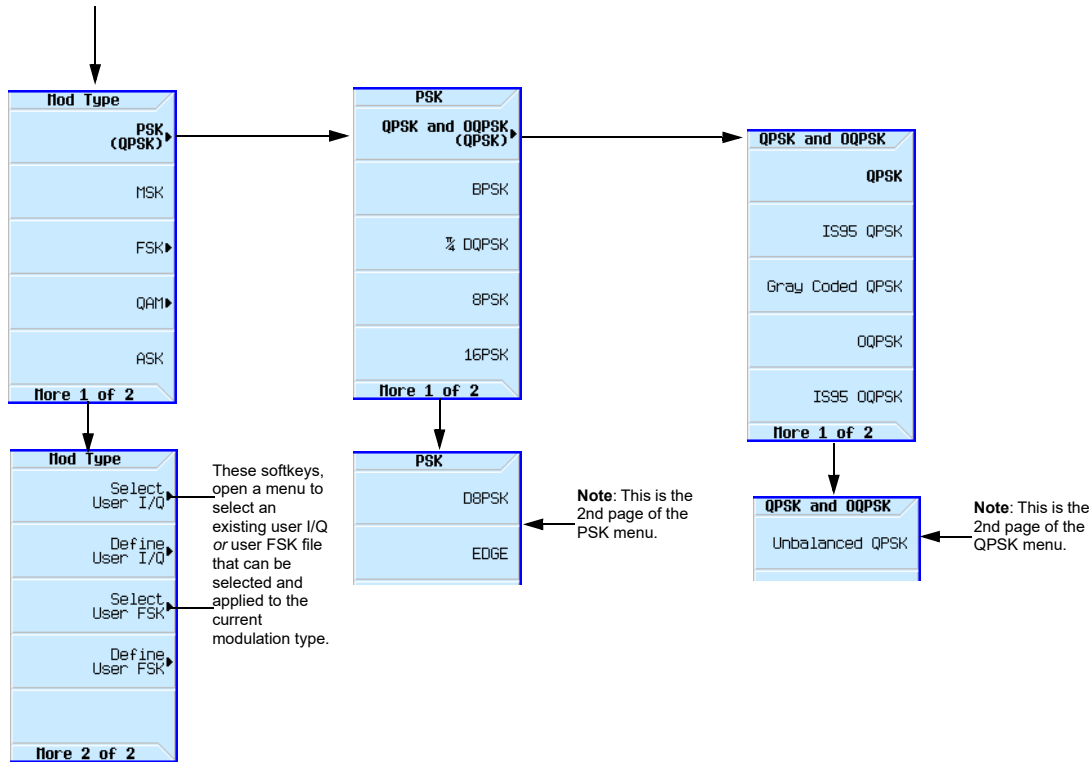


For details on each key, use key help as described on page 58.

Figure 16-19 Modifying a Digital Modulation Type

Mode > ARB Custom Modulation > Single Carrier Setup > Modulation Type > Select

For details on each key, use key help as described on page 58.



This section teaches you how to perform the following tasks:

- **Selecting a Digital Modulation Setup** on page 399
- **Configuring the RF Output** on page 397
- **Selecting the Filter** on page 400
- **Configuring the RF Output** on page 397

### Selecting a Digital Modulation Setup

1. Press **Preset**.
2. In the ARB Custom Modulation menu (page 398), press **Single Carrier Setup > Quick Setup > NADC**.

### Modifying the Modulation Type and Symbol Rate

1. In the ARB Custom Modulation menu (page 398), press **Single Carrier Setup > Modulation Type > Select > PSK > QPSK and OQPSK > QPSK**.
2. Press **Return > Symbol Rate > 56 > ksp**.

## Selecting the Filter

1. In the Setup Mod menu ([page 398](#)), press **Filter** > **Select** > **Nyquist**.
2. Press **Return** > **Return**.

## Generating the Waveform

Press **Digital Modulation Off On**.

This generates a waveform with the custom, single-carrier NADC, digital modulation state created in the previous sections. The display changes to **Dig Mod Setup: NADC (Modified)**. During waveform generation, the **DIGMOD** and **I/Q** annunciators appear and the custom single-carrier digital modulation state is stored in volatile memory. The waveform is now modulating the RF carrier.

For instructions on storing this custom, single-carrier NADC, digital modulation state to the non-volatile memory catalog, see [Storing a Custom Digital Modulation State](#) on page 400.

## Configuring the RF Output

1. Set the RF output frequency to 835 MHz.
2. Set the output amplitude to 0 dBm.
3. Press **RF On/Off**.

The user-defined NADC signal is now available at the RF OUTPUT connector.

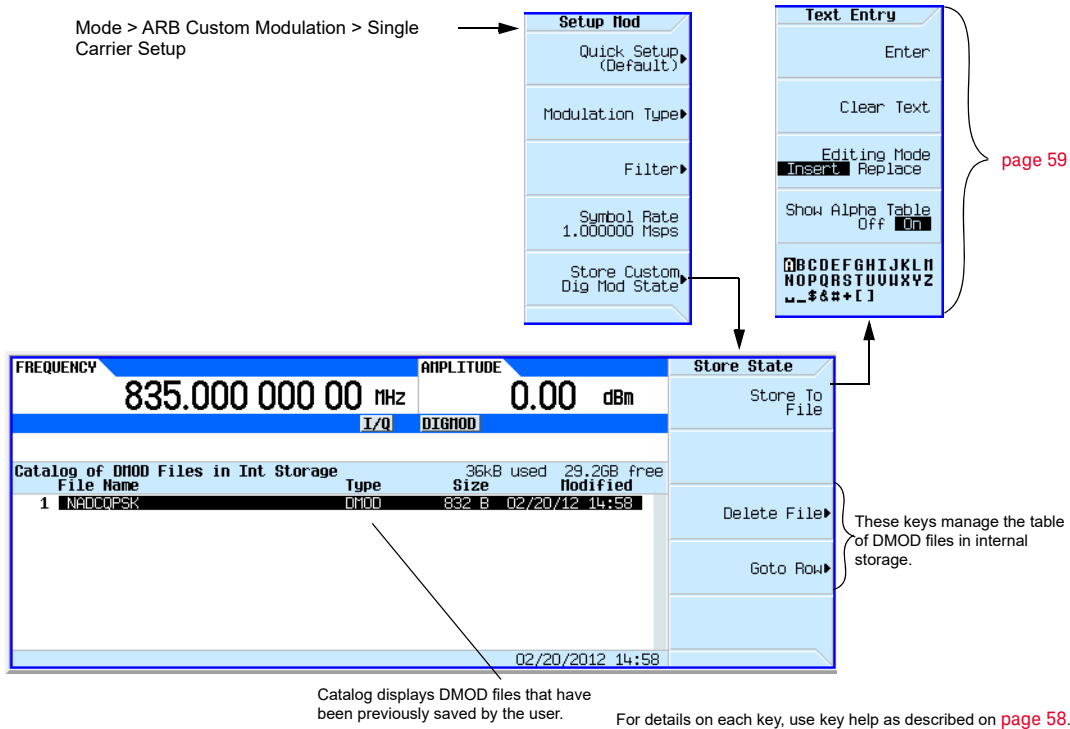
## Storing a Custom Digital Modulation State

Using this procedure, you learn how to store a custom digital modulation state and a custom multicarrier digital modulation state to non-volatile memory.

If you have not created a custom, single-carrier, digital modulation state, complete the steps in the previous section, [Creating a Custom Digital Modulation State](#) on page 398.



Figure 16-20 Storing a Custom Digital Modulation State



1. Return to the top-level ARB Custom Modulation menu, where **Digital Modulation Off On** is the first softkey.
2. In the ARB Custom Modulation menu (page 401), press **Single Carrier Setup > Store Custom Dig Mod State > Store To File**.

If there is already a file name from the Catalog of DMOD Files occupying the active entry area, press the following key: **Clear Text**

3. Enter a file name (for example, NADCQPSK) using the alpha keys and the numeric keypad with a maximum length of 23 characters.
4. Press **Enter**.

The user-defined, single-carrier, digital modulation state is now stored in non-volatile memory.

**NOTE**

The RF output amplitude, frequency, and operating state settings are not stored as part of a user-defined, digital modulation state file.

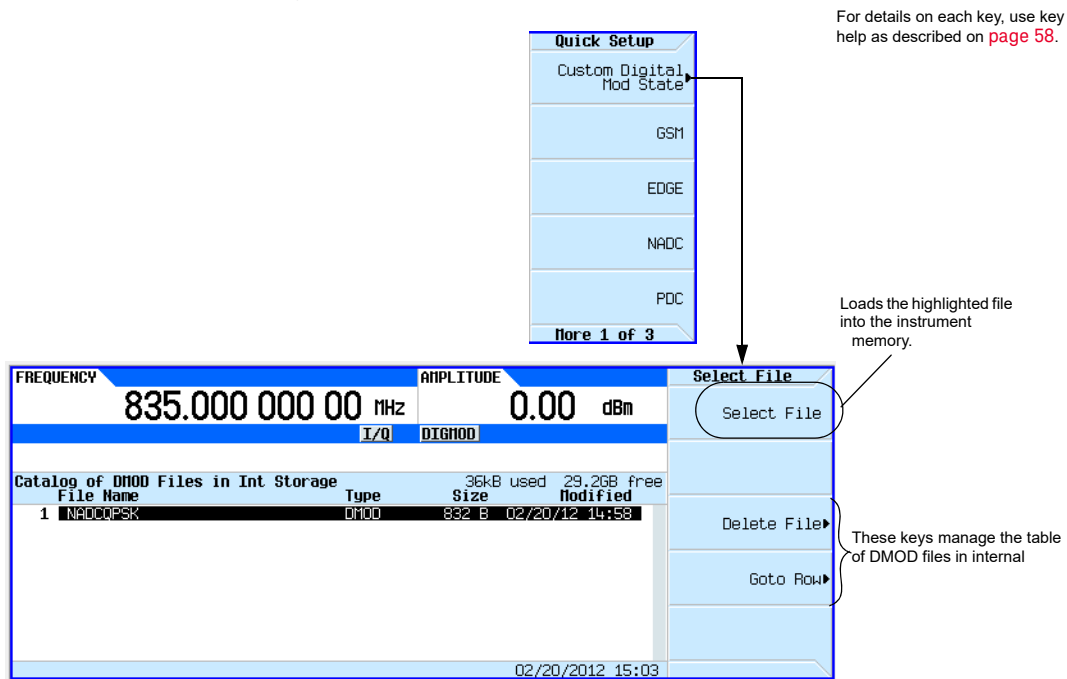
### Recalling a Custom Digital Modulation State

Using this procedure, you will learn how to recall a custom digital modulation state from signal non-volatile memory.

If you have not created and stored a user-defined, single-carrier, digital modulation state, complete the steps in the previous sections, [Creating a Custom Digital Modulation State](#) on page 398 and [Storing a Custom Digital Modulation State](#) on page 400, then preset the signal generator to clear the stored user-defined, digital modulation waveform from volatile ARB memory.

Figure 16-21 Recalling a Custom Digital Modulation State

Mode > ARB Custom Modulation > Single Carrier Setup > Quick Setup



1. In the Quick Setup menu, press **Custom Digital Mod State**.
2. Highlight the desired file (for example, **NADCQPSK**).
3. Press **Select File** > **Return**.
4. Press **Digital Modulation Off On** until **On** is highlighted.

The instrument regenerates the custom, digital modulation waveform in volatile memory. After waveform generation, the custom, digital modulation waveform is available to be modulated on the RF output.

For instruction on configuring the RF output, see [Configuring the RF Output](#) on page 397.

## Defining a Modulation

You can build a unique modulation by utilizing two tools, the FSK table editor or the I/Q table editor. These tables map data onto specific absolute modulation states. To map transitions between states, a differential table editor is provided.

## Building an Asymmetric FSK Modulation with the FSK Table Editor

You can use the FSK table editor to create customized asymmetric FSK modulation of up to 16 levels, then apply the custom FSK modulation to one of the modulation standards. An example of this capability is to create an interfering signal for adjacent channel selectivity testing of FLEXTM pagers. To do this, build a 4-level FSK modulation at 4.8 kHz and 1.6 kHz in the FSK table editor, shown in **Figure 16-22**. Then use this signal to modulate a PN15 data transmission. In the FLEXTM protocol, each of the levels in 4-level FSK represents a 2-bit sequence.

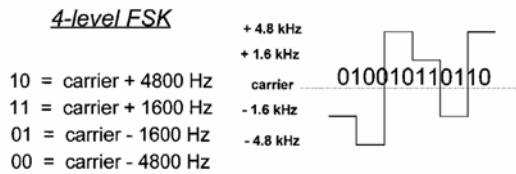
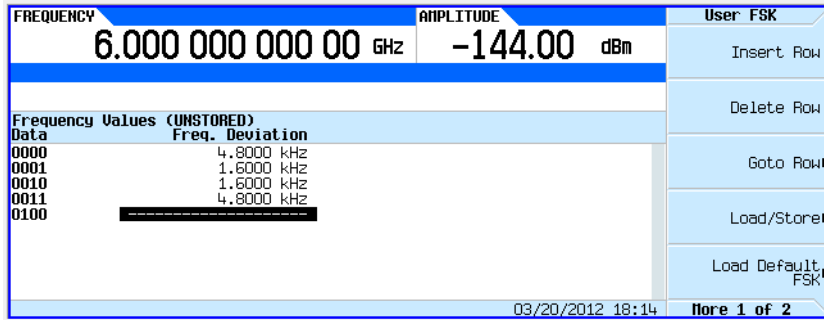
### Create a Continuous 4-Level FSK Signal

Use this procedure to create a 4-level FSK signal for adjacent channel testing of FLEXTM pagers.

1. Press **Preset** on the signal generator.
2. Press **Mode** > **Real-Time Custom Modulation** > **Modulation Setup** > **Modulation Type** > **Define User FSK**.
3. Enter the frequency deviations shown in **Figure 16-22** into the FSK table editor.
4. Store the file as 4FSK. Press **Load/Store** > **Store To File** > **4FSK** > **Enter**.
5. Load the file. Press **Load from Selected File** > **Confirm Load From File**.
6. Turn on Custom Modulation. Press **Return** > **Return** > **Return** > **Real-Time Custom On**.
7. Set the Frequency to the desired carrier frequency for the adjacent channel.
8. Set the desired Amplitude.
9. Press **RF On**. The amplitude of the interferer can then be adjusted to measure the performance of the device under test.

Figure 16-22 FSK Table Editor

Mode > Real-Time Custom Modulation > Modulation Setup > Modulation Type > Define User FSK

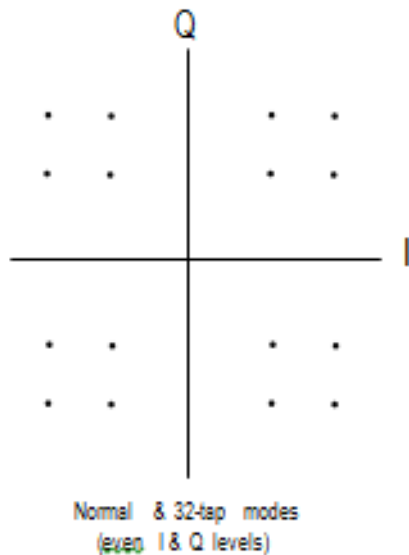


For details on each key, use key help as described on [page 58](#).

### Mapping I/Q Values with the I/Q Table Editor

In most digital radio systems, the frequency of the carrier is fixed so only phase and magnitude need to be considered. The phase and magnitude of symbols can be represented as a discrete point in the I/Q plane. I represents "in phase" and Q represents "quadrature".

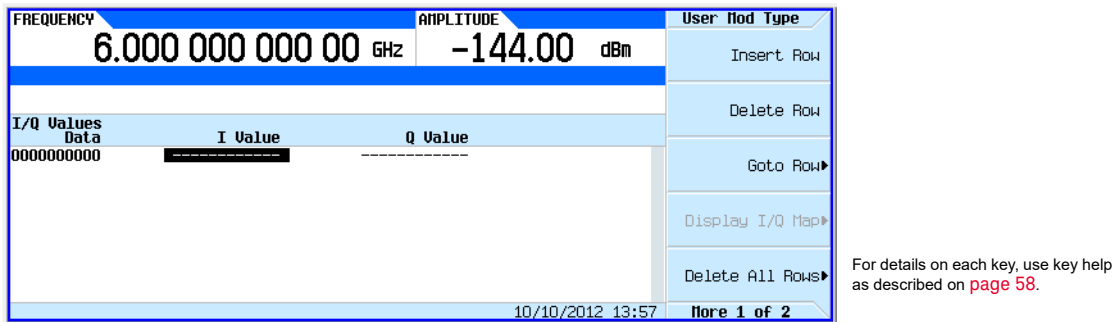
Figure 16-23 I/Q Constellation Diagram



By modulating the carrier to one of several predetermined positions in the I/Q plane, you can then transmit encoded information. Each position or state represents a certain bit pattern that can be decoded at the receiver. The mapping of the states at each symbol decision point on the I/Q plane is referred to as a constellation diagram. You can create a unique signal by mapping your constellation diagram into the I/Q table editor, shown in **Figure 16-24**. The table editor also has a display feature, which provides a quick visual check of the expected I/Q constellation.

**Figure 16-24** I/Q Table Editor

Mode > Real-Time Custom Modulation > Modulation Setup > Modulation Type > Define User I/Q

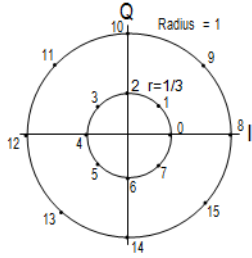


Utilizing this I/Q mapping flexibility, you can create unique modulation schemes. For example, a circular constellation arrangement called a STAR QAM is easily implemented and saved for later recall with the real-time I/Q baseband generator. **Figure 16-25** shows that the STAR QAM has 16 states or symbols. Four data bits define each symbol. Thus, the diagram and the table are equivalents.

### Create a STAR QAM Modulation Scheme

1. Press Preset on the signal generator.
2. Press Mode > Real-Time Custom Modulation > Modulation Setup > Modulation Type > Define User IQ.
3. Enter the values shown in **Figure 16-25** for I and Q using the numeric keypad and arrow keys. Press Display IQ Map to check your entry and adjust any entry errors.
4. Press Return > Store To File > Clear Text.
5. Turn on Custom Modulation. Press Return > Return > Return > Real-Time Custom On.
6. Name the file STAR and press Enter.
7. Load the file. Highlight STAR and press Load from Selected File > Confirm Load From File.
8. Turn on Custom Modulation. Press Return > Return > Return > Return > Real-Time Custom On.
9. Set the Frequency and Amplitude to the desired values.
10. Press RF On.

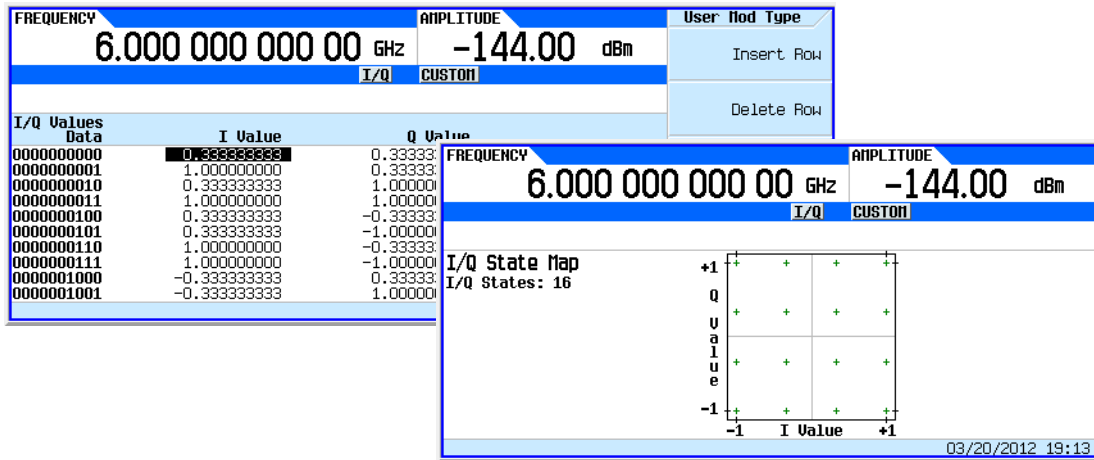
Figure 16-25 STAR QAM Diagram and Table



Symbol	Data bits	I Value	Q Value
0	0000	0.333333	0.000000
1	0001	0.235702	0.235702
2	0010	0.000000	0.333333
3	0011	-0.235702	0.235702
4	0100	-0.333333	0.000000
5	0101	-0.235702	-0.235702
6	0110	0.000000	-0.333333
7	0111	0.235702	-0.235702
8	1000	1.000000	0.000000
9	1001	0.707107	0.707107
10	1010	0.000000	1.000000
11	1011	-0.707107	0.707107
12	1100	-1.000000	0.000000
13	1101	-0.707107	-0.707107
14	1110	0.000000	-1.000000
15	1111	0.707107	-0.707107

Figure 16-26 shows the X-Series setup and the I/Q display.

Figure 16-26 Custom Modulation and I/Q Display



### Hints for Constructing Modulations

- The map is limited to 16 total signal levels for I and Q combined. The readout on the right-hand side of the table tracks the number of I and Q levels utilized. Levels are I or Q values. Figure 16-27 shows an 8PSK signal built in two different ways. The 8PSK signal in Figure 16-27 utilizes five of the available sixteen I/Q values on the left, and utilizes four of the available sixteen I/Q values on the right.
- Following this example, the real-time I/Q baseband generator supports a symmetric 256QAM constellation but not an asymmetric 256QAM constellation, since the asymmetry requires more than sixteen I/Q values.
- The levels do not have to be equally spaced or symmetric in the I/Q plane. For example, the 16QAM modulations shown in Figure 16-28 are both possible.

Figure 16-27 8PSK Signal Built Two Ways

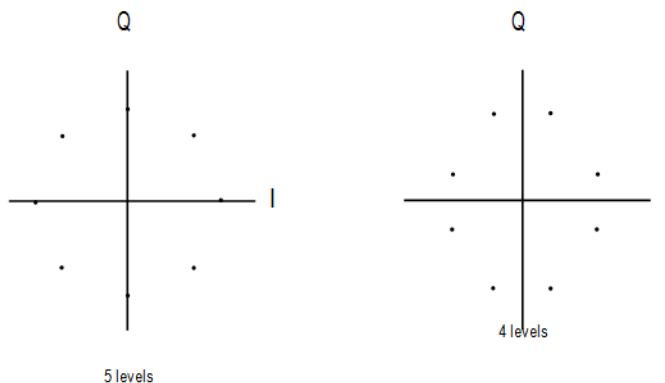
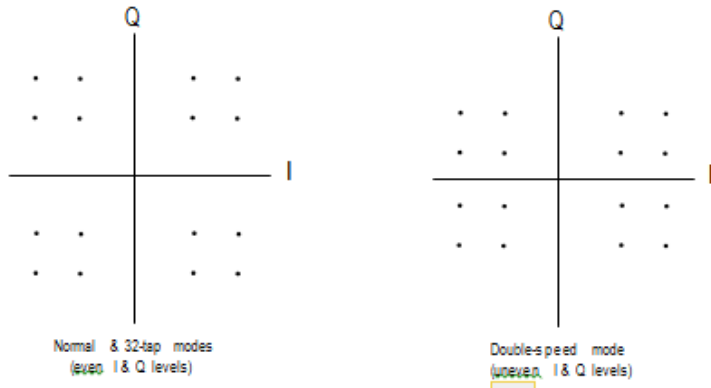


Figure 16-28 16QAM I/Q Map with Even and Uneven Levels





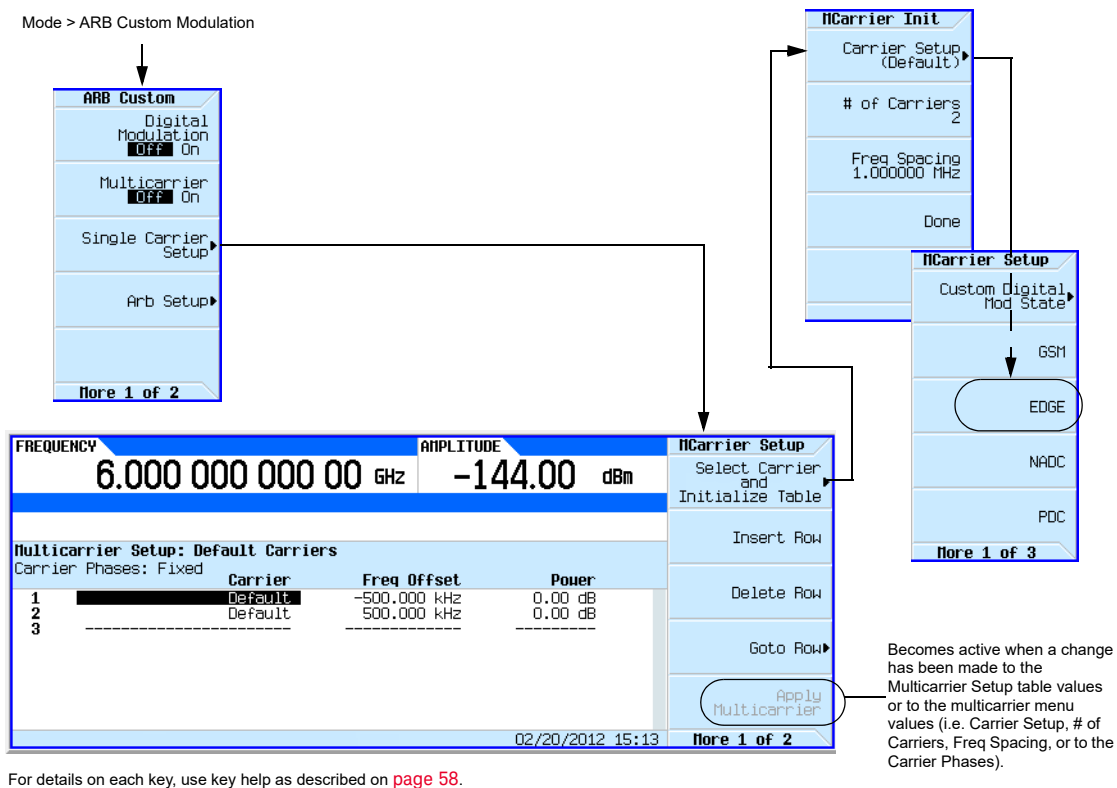
## Creating a Custom Multicarrier Digital Modulation State

In this procedure, you learn how to customize a predefined, multicarrier, digital modulation setup by creating a custom, 3-carrier EDGE, digital modulation state.

This section teaches you how to perform the following tasks:

- **Creating a Multicarrier Digital Modulation Setup** on page 410
- **Modifying Carrier Frequency Offset** on page 410
- **Modifying Carrier Power** on page 410
- **Generating the Waveform** on page 410
- **Configuring the RF Output** on page 410

Figure 16-29 Creating a Multicarrier Digital Modulation Setup



## Creating a Multicarrier Digital Modulation Setup

1. Press **Preset**.
2. Press **Mode** > **ARB Custom Modulation** > **Multicarrier Off On to On**.
3. Press **Multicarrier Setup** > **Select Carrier and Initialize Table** > **Carrier Setup** > **EDGE** > **Done**.

## Modifying Carrier Frequency Offset

1. Highlight the **Freq Offset** value (500.000 kHz) for the carrier in row 2.
2. Press **-625** > **kHz**.

## Modifying Carrier Power

1. Highlight the **Power** value (0.00 dB) for the carrier in row 2.
2. Press **-10** > **dB**.

You now have a custom 2-carrier EDGE waveform with a carrier at a frequency offset of -625 kHz and a power level of -10.00 dBm, as shown in the following figure.

The screenshot shows the 'Multicarrier Setup: EDGE Carriers' screen. At the top, the carrier frequency is set to 6.000 000 000 00 GHz and the amplitude to -144.00 dBm. Below this is a table of carrier parameters:

	Carrier	Freq Offset	Power
1	EDGE	-500.000 kHz	0.00 dB
2	EDGE	-625.000 kHz	-10.00 dB
3			

On the right side of the screen is a menu with the following options: 'Select Carrier and Initialize Table', 'Insert Row', 'Delete Row', 'Goto Row', and 'Apply Multicarrier'. A note on the right states: 'For details on each key, use key help as described on page 58.' and 'If Digital Modulation is already on, you must press Apply Multicarrier to apply the changes and generate a new custom multicarrier digital modulation waveform based on the updated values.'

## Generating the Waveform

Press **Return** > **Digital Modulation Off On**.

This generates a waveform with the custom, multicarrier, EDGE state created in the previous sections. The display changes to **Dig Mod Setup: Multicarrier (Modified)**. During waveform generation, the **DIGMOD** and **I/Q** annunciators appear and the new custom, multicarrier, EDGE state is stored in volatile memory. The waveform is now modulating the RF carrier.

For instructions on storing this custom, multicarrier, EDGE state to non-volatile memory, see **“Storing a Custom Multicarrier Digital Modulation State” on page 411**.

## Configuring the RF Output

1. Set the RF output frequency to 890.01 MHz.
2. Set the output amplitude to -10 dBm.
3. Press **RF On/Off**.

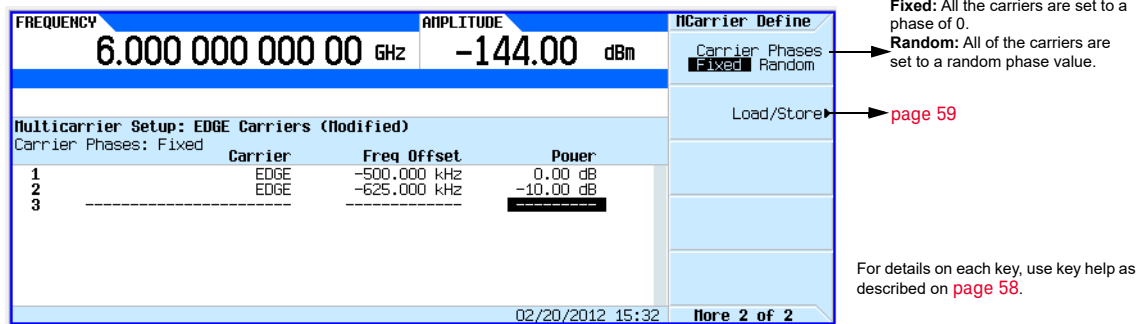
The custom multicarrier EDGE signal is now available at the RF OUTPUT connector.

## Storing a Custom Multicarrier Digital Modulation State

Using this procedure, you learn how to store a custom, multicarrier, digital modulation state to non-volatile memory.

If you have not created a custom, multicarrier, digital modulation state, complete the steps in the previous section, **“Creating a Custom Multicarrier Digital Modulation State” on page 409.**

Figure 16-30 Storing a Custom Multicarrier Softkeys



1. Return to the top-level Digital Modulation menu, where **Digital Modulation Off On** is the first softkey.
2. Press **Multicarrier Setup > More > Load/ Store > Store To File.**  
If there is already a file name from the Catalog of MDMOD Files occupying the active entry area, press the following key: **Clear Text**
3. Enter a file name (for example, EDGEM1) using the alpha keys and the numeric keypad with a maximum length of 23 characters.
4. Press **Enter.**

The user-defined, multicarrier, digital modulation state is now stored in non-volatile memory.

### NOTE

The RF output amplitude, frequency, and operating state settings are not stored as part of a user-defined, digital modulation state file.

## Applying Changes to an Active Multicarrier Digital Modulation State

If the digital modulation format is currently in use (**Digital Modulation Off On** set to On) while changes are made in the **Multicarrier Setup** table editor, you must apply the changes before the updated waveform will be generated.

From the **Multicarrier Setup** table editor, press **Apply Multicarrier** to apply the changes and generate a new custom multicarrier digital modulation waveform based on the updated values.

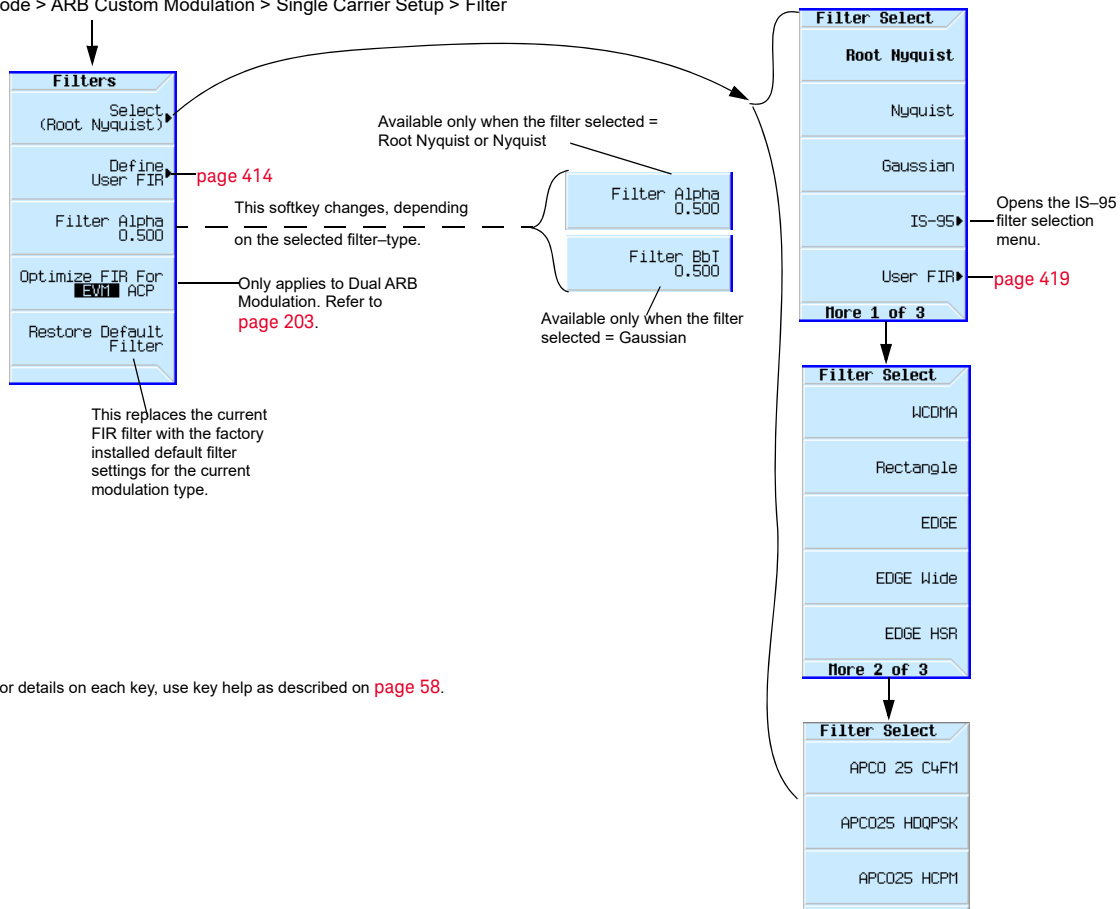
## Using Finite Impulse Response (FIR) Filters with Custom Modulation

Finite Impulse Response filters can be used to refine the transitions between symbol decision points of the generated waveforms.

Figure 16-31

### Filter Menu

Mode > ARB Custom Modulation > Single Carrier Setup > Filter



## Understanding FIR Filters

FIR filters are used to limit the bandwidth of the input to the I and Q modulators. Several different types of FIR filters exist. The NADC, PDC, PHS, and TETRA standards specify a root Nyquist filter in both the transmitter and the receiver. The combined response is equivalent to a Nyquist filter. The Nyquist filter has an impulse response that rings at the data clock rate so nulls appear at all symbol decision points except the desired one at the center of the impulse response. Since each symbol causes zero response at all undesired decision points, there can be no inter-symbol interference (ISI). The alpha term ( $\alpha$ ) defined for Nyquist-type filters identifies the frequency cutoff point where the filter response is zero. The closer the alpha term is to zero, the steeper the filter roll-off becomes. Alpha gives a direct measure of the occupied bandwidth of the system and is calculated as

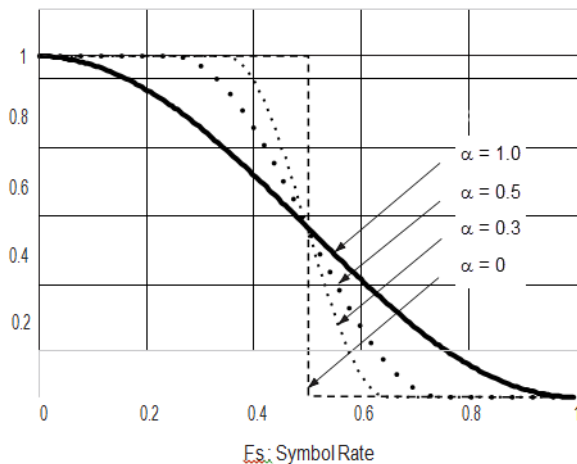
$$\text{Occupied Bandwidth} = \text{Symbol Rate} \times (1 + \alpha)$$

The NADC and TETRA standards specify an alpha of 0.35. PDC and PHS standards specify an alpha of 0.50. For each of these standards, the Keysight X-Series signal generator provides a root Nyquist filter with the designated alphas as the default premodulation filter. **Figure 16-32** shows the Nyquist impulse response for several values of alpha.

Notice that the half-amplitude point is always at the half-symbol rate. Since all of the information is contained within the half symbol rate bandwidth, alpha is a measure of the additional occupied bandwidth.

Another type of FIR filter, which is specified in the GSM and DECT standards, is the Gaussian filter. Gaussian filters typically have more inter-symbol interference than Nyquist filters, but their adjacent channel power performance is better for constant-amplitude modes like MSK, where Nyquist filtering of I and Q is not possible. The bandwidth bit time (BbT) product (similar to  $\alpha$ ) is defined by the GSM standard as 0.30 and by the DECT standard as 0.50. For each of these standards, the Keysight X-Series signal generator provides a Gaussian filter with the designated BbT product as the default premodulation filter.

**Figure 16-32** Nyquist Filter Impulse Response



### Selecting a Filter and the Alpha ( $\alpha$ ) or Bandwidth Bit Time (Bbt) Product

Due to individual system design requirements, you may decide to change the filter or the filter  $\alpha$  or BbT. You can adjust the alpha from 0 to 1 and the BbT from 0.1 to 1.

To change the filter alpha:

1. Preset the instrument.
2. Press Mode > Real-Time Custom Modulation > Modulation Setup > Filter > Select Nyquist > Filter Alpha.
3. Enter a new value between 0 and 1. Press Enter.
4. To restore the default filter values, press Restore Default Filter.

**NOTE**

To change the filter Bbt, press **Mode > Real-Time Custom Modulation > Modulation Setup > Filter > Select Gaussian > Filter Bbt.**

Enter a new value between 0.1 and 1.

## Creating a User-Defined FIR Filter Using the FIR Table Editor

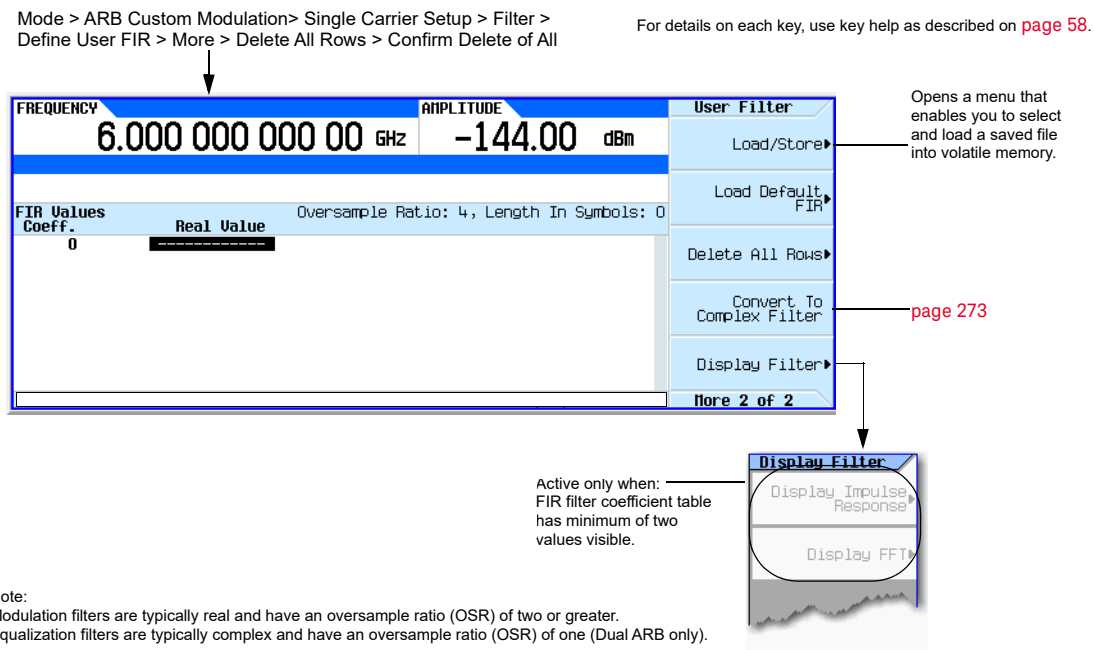
In this procedure, you use the **FIR Values** table editor to create and store an 8-symbol, windowed sync function filter with an oversample ratio of 4.

### Accessing the Table Editor

1. Press **Preset**.
2. Press **Mode > ARB Custom Modulation > Single Carrier Setup > Filter > Select > Nyquist**.
3. Press **Filter > Define User FIR**.
4. Press **More 2 of 2 > Delete All Rows > Confirm Delete of All Rows**.

This will initialize the table editor as shown in **Figure 16-33**.

**Figure 16-33** Creating a User-Defined FIR Filter Using the FIR Filter Table Editor



### Entering the Coefficient Values

1. Press the **Return** softkey to get to the first page of the table editor.
2. Use the cursor to highlight the **Value** field for coefficient 0.

3. Use the numeric keypad to type the first value (–0.000076) from **Table 16-1**. As you press the numeric keys, the numbers are displayed in the active entry area. (If you make a mistake, you can correct it using the backspace key.)
4. Continue entering the coefficient values from the table in step 1 until all 16 values have been entered.

Table 16-1

Coefficient	Value
0	–0.000076
1	–0.001747
2	–0.005144
3	–0.004424
4	0.007745
5	0.029610
6	0.043940
7	0.025852

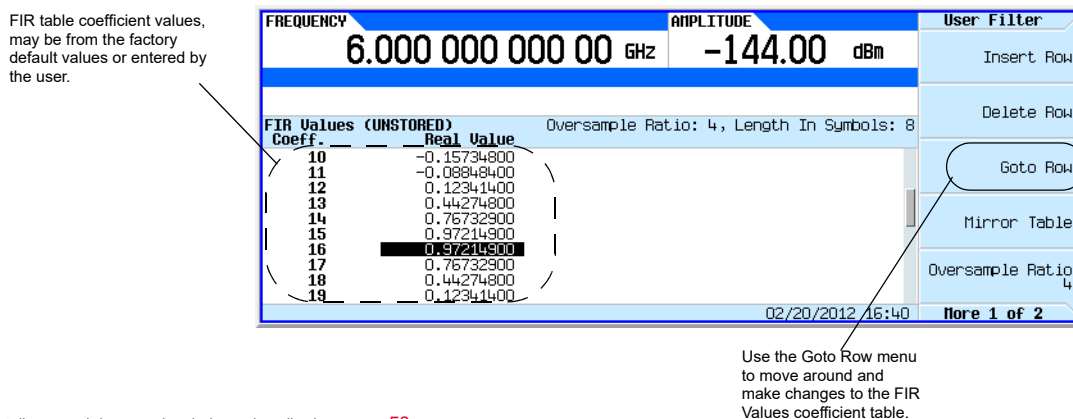
Coefficient	Value
8	–0.035667
9	–0.116753
10	–0.157348
11	–0.088484
12	0.123414
13	0.442748
14	0.767329
15	0.972149

## Duplicating the First 16 Coefficients Using Mirror Table

In a windowed sinc function filter, the second half of the coefficients are identical to the first half in reverse order. The signal generator provides a mirror table function that automatically duplicates the existing coefficient values in the reverse order.

1. Press **Mirror Table**. The last 16 coefficients (16 through 31) are automatically generated and the first of these coefficients (number 16) highlights, as shown in **Figure 16-34** on page 416.

Figure 16-34



## Setting the Oversample Ratio

### NOTE

Modulation filters must be real and have an oversample ratio (OSR) of two or greater.

The oversample ratio (OSR) is the number of filter coefficients per symbol. Acceptable values range from 1 through 32; the maximum combination of symbols and oversampling ratio allowed by the table editor is 1024. The instrument hardware, however, is actually limited to 32 symbols, an oversample ratio between 4 and 16, and 512 coefficients. So if you enter more than 32 symbols or 512 coefficients, the instrument is unable to use the filter. If the oversample ratio is different from the internal, optimally selected one, then the filter is automatically resampled to an optimal oversample ratio.

For this example, the desired OSR is 4, which is the default, so no action is necessary.

## Displaying a Graphical Representation of the Filter

The signal generator has the capability of graphically displaying the filter in both time and frequency dimensions.

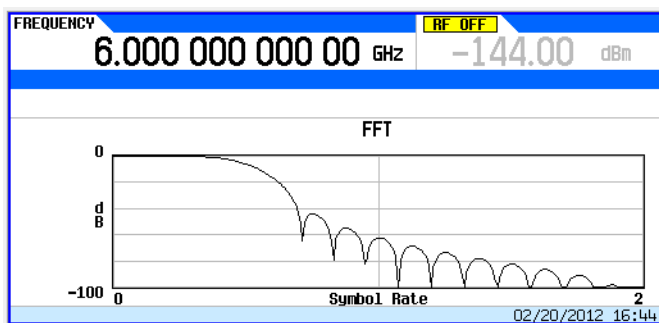
1. Press **More > Display Filter > Display FFT** (fast Fourier transform).

Refer to **Figure 16-35** on page 417.



Figure 16-35

For details on each key, use key help as described on page 58.

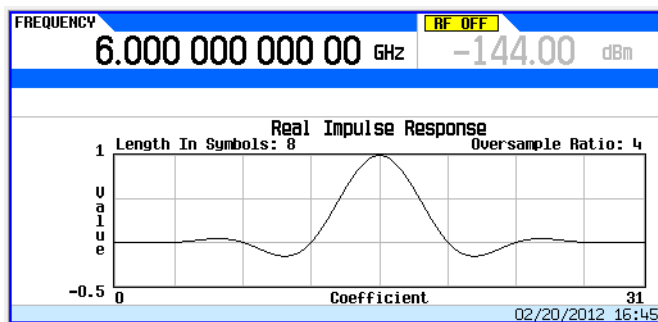


2. Press **Return**.
3. Press **Display Impulse Response**.

Refer to [Figure 16-36](#).

Figure 16-36

For details on each key, use key help as described on page 58.



4. Press **Return** to return to the menu keys.

### Storing the Filter to Memory

Use the following steps to store the file.

1. Press **Load/Store** > **Store To File**. The catalog of FIR files appears along with the amount of memory available.
2. As described in [Storing, Loading, and Playing a Waveform Segment](#) on page 207, name and store this file as `FIR_1`.

The `FIR_1` file is the first file name listed. (If you have previously stored other FIR files, additional file names are listed below `FIR_1`.) The file type is FIR and the size of the file is 260 bytes. The amount of memory used is also displayed. The number of files that can be saved depends on the size of the files and the amount of memory used. Refer to [Figure 16-37](#).

Custom Digital Modulation (Option N5180431B)  
 Using Finite Impulse Response (FIR) Filters with Custom Modulation

Figure 16-37

File Name	Type	Size	Modified
1   FIR_1	FIR	268 B	02/20/12 16:50

Catalog displays FIR files that have been previously saved by the user.

For details on each key, use key help as described on [page 58](#).

Memory is also shared by instrument state files and list sweep files.

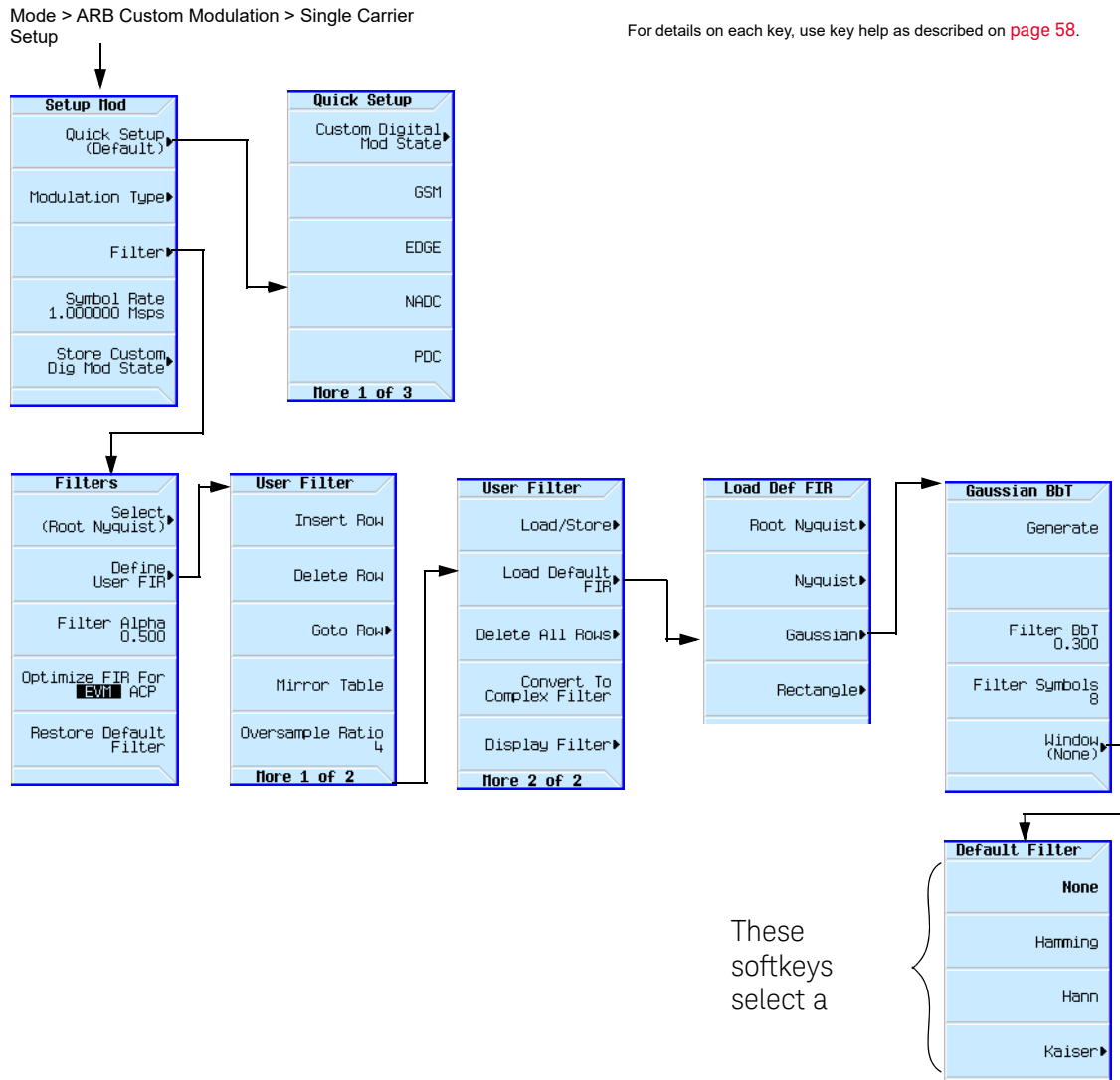
This filter can now be used to customize a modulation format or it can be used as a basis for a new filter design.

## Modifying a FIR Filter Using the FIR Table Editor

FIR filters stored in signal generator memory can easily be modified using the FIR table editor. You can load the FIR table editor with coefficient values from user-defined FIR files stored in non-volatile memory or from one of the default FIR filters. Then you can modify the values and store the new files.

### Loading the Default Gaussian FIR File

Figure 16-38 Loading the Default Gaussian FIR File



1. Press **Preset**.
2. Press **Mode** > **ARB Custom Modulation** > **Single Carrier Setup** > **Quick Setup** > **NADC**.
3. Press **Filter** > **Define User FIR** > **More 1 of 2** > **Load Default FIR** > **Gaussian**.
4. Press **Filter BbT** > **0.300** > **Enter**.

5. Press **Filter Symbols** > **8** > **Enter**.

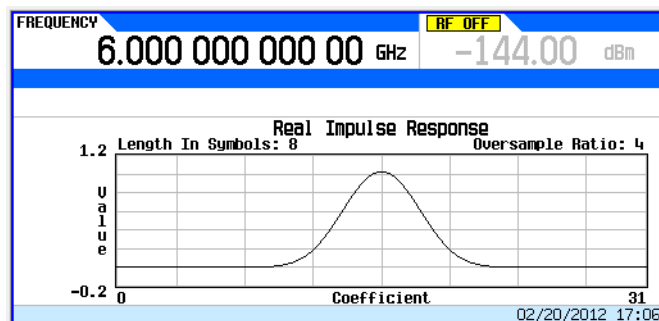
6. Press **Generate**.

**NOTE**

The actual oversample ratio during modulation is automatically selected by the instrument. A value between 4 and 16 is chosen dependent on the symbol rate, the number of bits per symbol of the modulation type, and the number of symbols.

7. Press **Display Filter** > **Display Impulse Response** (refer to [Figure 16-39](#)).

**Figure 16-39** Impulse Response Display



For details on each key, use key help as described on [page 58](#).

8. Press **Return**.

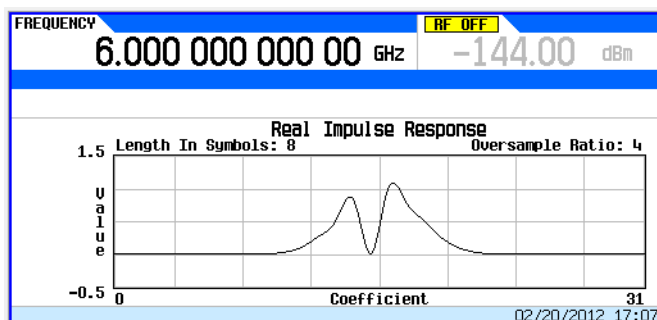
## Modifying the Coefficients

1. Using the front panel arrow keys, highlight coefficient 15.

2. Press **0** > **Enter**.

3. Press **Display Impulse Response**.

**Figure 16-40** Impulse Response Display with Modified Coefficients



For details on each key, use key help as described on [page 58](#).

Refer to [Figure 16-40 on page 420](#). The graphic display can provide a useful troubleshooting tool (in this case, it indicates that a coefficient value is missing, resulting in an improper Gaussian response).

4. Press **Return**.

**5. Highlight coefficient 15.**

**6. Press 1 > Enter.**

### Storing the Filter to Memory

The maximum file name length is 23 characters (alphanumeric and special characters).

**1. Press Return > Load/Store > Store To File.**

**2. Name the file NEWFIR2.**

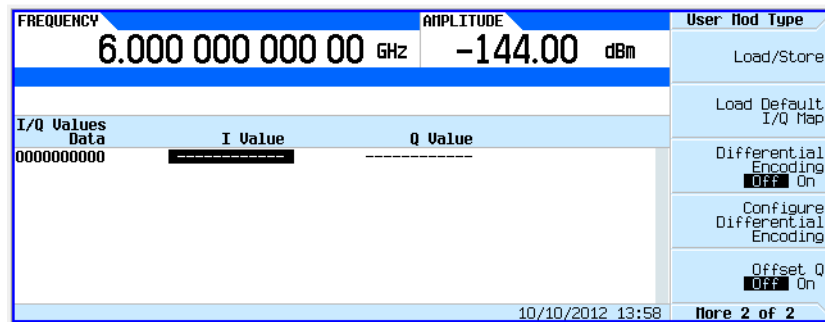
**3. Press Enter.**

The contents of the current FIR table editor are stored to a file in non-volatile memory and the catalog of FIR files is updated to show the new file.

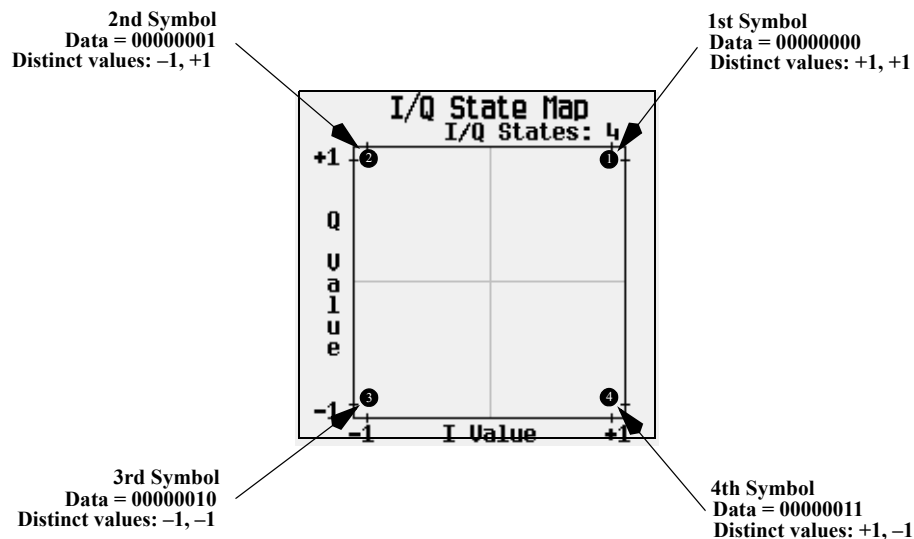
## Differential Encoding

Differential encoding is a digital-encoding technique whereby a binary value is denoted by a signal **change** rather than a particular signal state. Using differential encoding, binary data in any user-defined I/Q or FSK modulation can be encoded during the modulation process via symbol table offsets defined in the Differential State Map.

For example, consider the signal generator's default 4QAM I/Q modulation. With a user-defined modulation based on the default 4QAM template, the I/Q Values table editor contains data that represent four symbols (00, 01, 10, and 11) mapped into the I/Q plane using two distinct values, 1.000000 and -1.000000. The following illustration shows the 4QAM modulation in the I/Q Values table editor.



The following illustration shows a 4QAM modulation I/Q State Map.



Differential encoding employs relative offsets between the states in the symbol table to encode user-defined modulation schemes. The **Differential State Map** table editor is used to introduce symbol table offset values which in turn cause transitions through the I/Q State Map based on their associated data value. Whenever a data value is modulated, the offset value stored in the Differential State Map is used to encode the data by transitioning through the I/Q State Map in a direction and distance defined by the symbol table offset value.

Entering a value of +1 will cause a 1-state forward transition through the I/Q State Map, as shown in the following illustration.

**NOTE**

The following I/Q State Map illustrations show all of the possible state transitions using a particular symbol table offset value. The actual state-to-state transition would depend upon the state in which the modulation had started.

---

As an example, consider the following data/symbol table offset values.

Table 16-2

Data	Offset Value
00000000	+1
00000001	-1

00000010	+2
00000011	0

**NOTE**

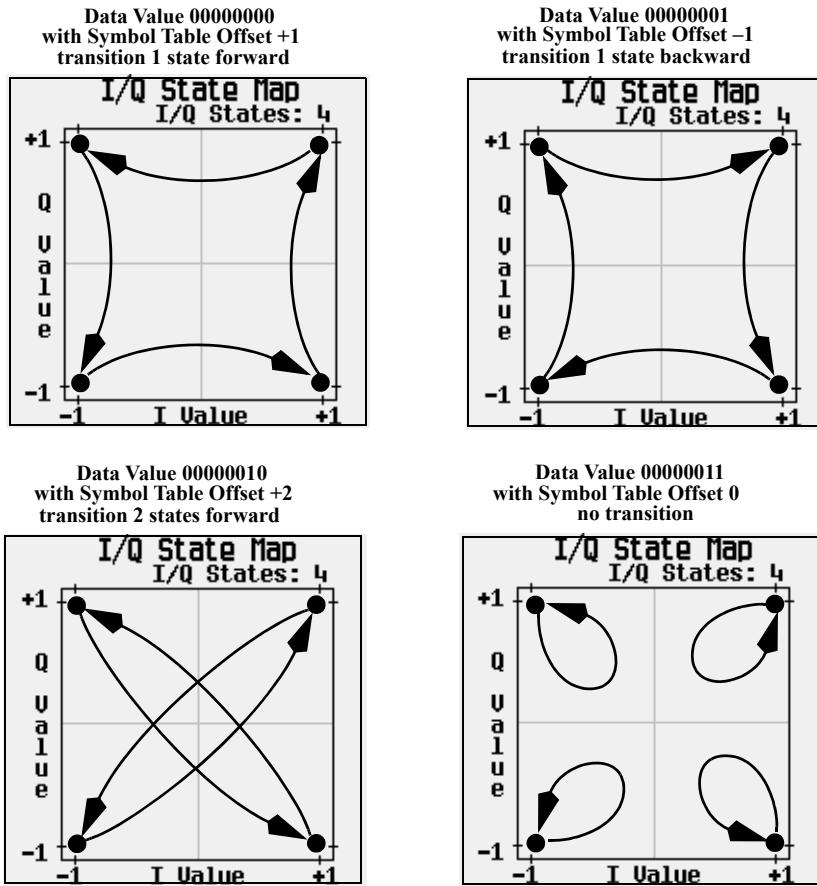
The number of bits per symbol can be expressed using the following formula. Because the equation is a ceiling function, if the value of x contains a fraction, x is rounded up to the next whole number.

$$x = \lceil \log_2(y) \rceil$$

Where x = bits per symbol, and y = the number of differential states.

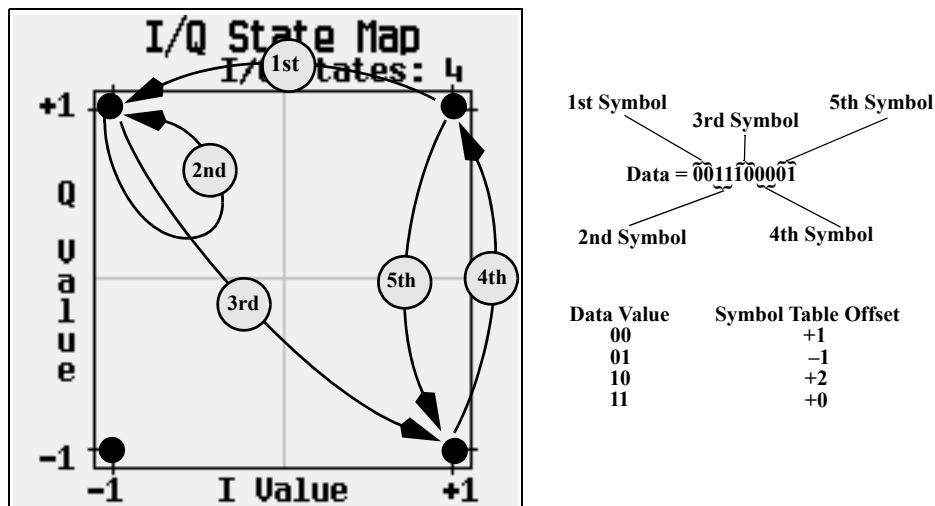
---

These symbol table offsets will result in one of the transitions, as shown.





When applied to the user-defined default 4QAM I/Q map, starting from the 1st symbol (data 00), the differential encoding transitions for the data stream (in 2-bit symbols) 0011100001 appear in the following illustration.



As you can see from the previous illustration, the 1st and 4th symbols, having the same data value (00), produce the same state transition (forward 1 state). In differential encoding, symbol values do not define location; they define the direction and distance of a **transition** through the I/Q State Map.

## Using Differential Encoding

The signal generator's **Differential State Map** table editor enables you to modify the differential state map associated with user-defined I/Q and user-defined FSK modulations. In this procedure, you create a user-defined I/Q modulation and then configure, activate, and apply differential encoding to the user-defined modulation. For more information, see **"Differential Encoding"** on page 422.

## Configuring User-Defined I/Q Modulation

1. Press **Preset**.
2. Perform the following keypress sequence required for your format type.

For Custom ARB Format

Press **Mode** > **ARB Custom Modulation** > **Single Carrier Setup** > **Modulation Type** > **Select** > **More 1 of 2** > **Define User I/Q** > **More** > **Load Default I/Q Map** > **QAM** > **4QAM**.

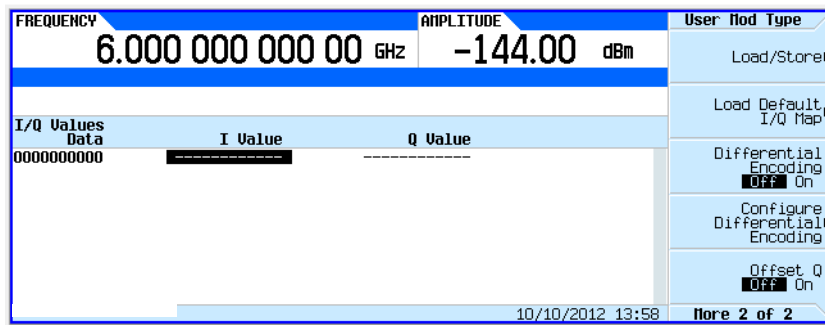
Or this alternate sequence:

Press **Mode** > **ARB Custom Modulation** > **Single Carrier Setup** > **Quick Setup (desired format)** > **Modulation Type** > **Select** > **More** > **Define User I/Q** > **More 1 of 2** > **Load Default I/Q Map** > **QAM** > **4QAM**.

This loads a default 4QAM I/Q modulation and displays it in the I/Q table editor.

The default 4QAM I/Q modulation contains data that represent 4 symbols (00, 01, 10, and 11) mapped into the I/Q plane using 2 distinct values (1.000000 and -1.000000). These 4 symbols will be traversed during the modulation process by the symbol table offset values associated with each symbol of data. Refer to **Figure 16-41**.

Figure 16-41

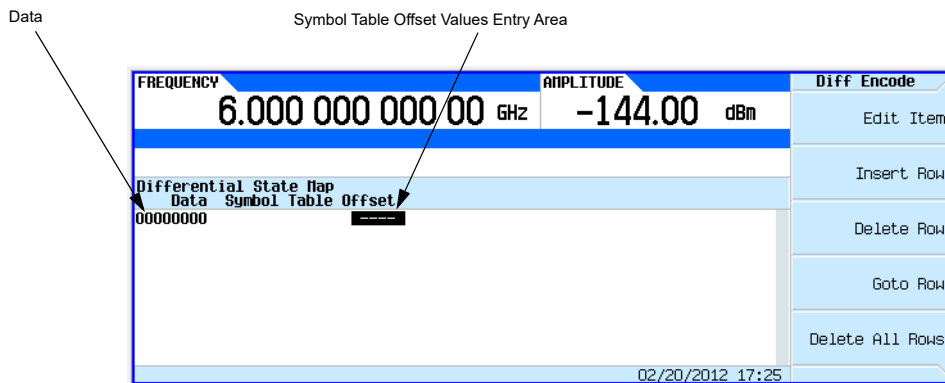


### Accessing the Differential State Map Table Editor

Press **Configure Differential Encoding**.

This opens the **Differential State Map** table editor, as shown. At this point, you see the data for the 1st symbol (00000000) and the cursor prepared to accept an offset value. You are now prepared to create a custom differential encoding for the user-defined default 4QAM I/Q modulation. Refer to **Figure 16-42 on page 426**.

Figure 16-42



### Editing the Differential State Map

1. Press **1** > **Enter**.

This encodes the first symbol by adding a symbol table offset of 1. The symbol rotates **forward** through the state map by 1 value when a data value of 0 is modulated.

**2. Press +/- > 1 > Enter.**

This encodes the second symbol by adding a symbol table offset of

-

1. The symbol rotates **backward** through the state map by 1 value when a data value of 1 is modulated.

**NOTE**

At this point, the modulation has one bit per symbol. For the first two data values (00000000 and 00000001) only the last bits (the 0 and the 1, respectively) are significant.

---

**3. Press 2 > Enter.**

This encodes the third symbol by adding a symbol table offset of 2. The symbol rotates **forward** through the state map by 2 values when a data value of 10 is modulated.

**4. Press 0 > Enter.**

This encodes the fourth symbol by adding a symbol table offset of 0. The symbol does **not** rotate through the state map when a data value of 11 is modulated.

**NOTE**

At this point, the modulation has two bits per symbol. For the data values 00000000, 00000001, 00000010, 00000011, the symbol values are 00, 01, 10, and 11 respectively.

---

## Applying Custom Differential Encoding

Press **Return > Differential Encoding Off On.**

This applies the custom differential encoding to a user-defined modulation.

**NOTE**

Notice that (UNSTORED) appears next to `Differential State Map` on the signal generator's display. Differential state maps are associated with the user-defined modulation for which they were created.

In order to save a custom differential state map, you must store the user-defined modulation for which it was designed. Otherwise the symbol table offset data is purged when you press the **Confirm Exit From Table Without Saving** softkey when exiting from the I/Q or FSK table editor.

---

Custom Digital Modulation (Option N5180431B)  
Differential Encoding

## 17 Multitone and Two-Tone Waveforms (Option N5180430B)

### NOTE

With firmware version B.01.75 or later, option numbers for software internal to the instrument have changed. For more information, see [“Enabling an Option” on page 53](#).

---

Before using this information, you should be familiar with the basic operation of the signal generator. If you are not comfortable with functions such as setting the power level and frequency, refer to [Basic Operation](#) on page 57 and familiarize yourself with the information in that chapter.

This feature is available only in Keysight X-Series vector signal generators with Option N5180430B. Option N5180430B requires Option 653 or 656.

## Creating a Custom Two-Tone Waveform

Using the **Two-Tone** menu, you can define, and modify user-defined Two-Tone waveforms. Two-Tone waveforms are generated by the dual arbitrary waveform generator.

The section **Using Two-Tone Modulation** on page 431 teaches you how to perform the following tasks:

- **Creating a Two-Tone Waveform** on page 432
- **Viewing a Two-Tone Waveform** on page 432
- **Minimizing Carrier Feedthrough** on page 433
- **Changing the Alignment of a Two-Tone Waveform** on page 434

## Creating a Custom Multitone Waveform

Using the **Multitone Setup** table editor, you can define, modify and store user-defined multitone waveforms. Multitone waveforms are generated by the dual arbitrary waveform generator.

The **Using Multitone Modulation** on page 436 teaches you how to perform the following tasks:

- **Initializing the Multitone Setup Table Editor** on page 436
- **Configuring Tone Powers and Tone Phases** on page 437
- **Removing a Tone** on page 437
- **Generating the Waveform** on page 437
- **Configuring the RF Output** on page 437

## Using Two-Tone Modulation

In the following sections, this chapter describes the two-tone mode, which is available only in Keysight X-Series vector signal generators with Option N5180430B:

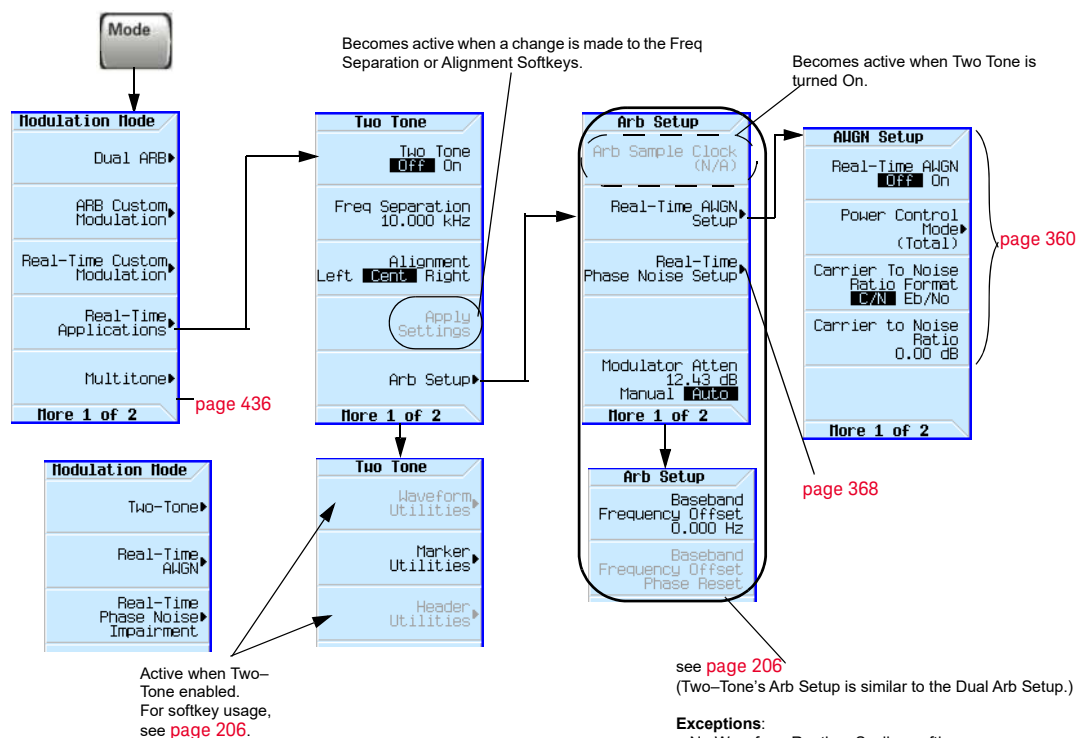
- [Creating a Two-Tone Waveform](#) on page 432
- [Viewing a Two-Tone Waveform](#) on page 432
- [Minimizing Carrier Feedthrough](#) on page 433
- [Changing the Alignment of a Two-Tone Waveform](#) on page 434

See also: [Saving a Waveform's Settings & Parameters](#) on page 215

### NOTE

For more information about two-tone waveform characteristics, and the two-tone standard, download **Application Note 1410** from our website by going to <http://www.keysight.com> and searching for “AN 1410” in Test & Measurement.

## Two-Tone Modulation Softkeys



For details on each key, use key help as described on page 58.

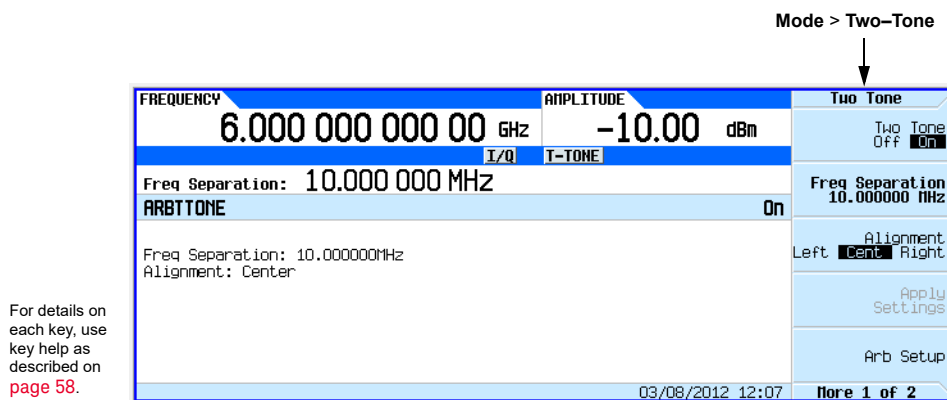
## Creating a Two-Tone Waveform

This procedure describes how to create a basic, centered, two-tone waveform.

1. Preset the signal generator.
2. Set the signal generator RF output frequency to 6 GHz.
3. Set the signal generator RF output amplitude to -10 dBm.
4. Press **Mode** > **More** > **Two-Tone** > **Freq Separation** > **10** > **MHz**.
5. Press **Two Tone Off On** to On.
6. Turn on the RF output.

The two-tone signal is now available at the signal generator RF OUTPUT connector. **Figure 17-1 on page 432** shows what the signal generator display should look like after all steps have been completed. Notice that the **T-TONE**, **I/Q**, annunciators are displayed; the **RF ON**, **MOD ON** are on; and the parameter settings for the signal are shown in the status area of the signal generator display.

Figure 17-1



## Viewing a Two-Tone Waveform

This procedure describes how to configure the spectrum analyzer to view a two-tone waveform and its IMD products. Actual key presses will vary, depending on the model of spectrum analyzer you are using.

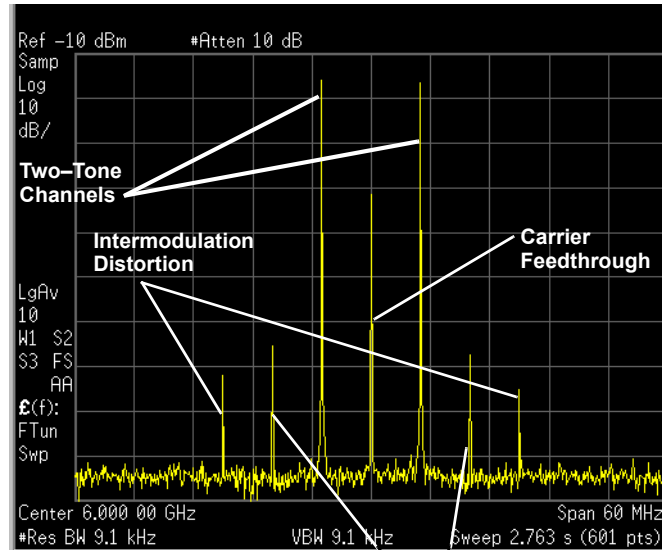
1. Preset the spectrum analyzer.
2. Set the carrier frequency to 6 GHz.
3. Set the frequency span to 60 MHz.
4. Set the amplitude for a 10 dB scale with a -10 dBm reference.
5. Adjust the resolution bandwidth to sufficiently reduce the noise floor to expose the IMD products. A 9.1 kHz setting was used in our example.
6. Turn on the peak detector.



7. Set the attenuation to 4 dB, so you're not overdriving the input mixer on the spectrum analyzer.

You should now see a two-tone waveform with a 6 GHz center carrier frequency that is similar to the one shown in [Figure 17-2 on page 433](#). You will also see IMD products at 10 MHz intervals above and below the generated tones, and a carrier feedthrough spike at the center frequency with carrier feedthrough distortion products at 10 MHz intervals above and below the center carrier frequency.

Figure 17-2



For details on each key, use key help as described on [page 58](#).

Carrier Feedthrough  
Distortion

## Minimizing Carrier Feedthrough

This procedure describes how to minimize carrier feedthrough and measure the difference in power between the tones and their intermodulation distortion products. Before beginning this procedure, it is important that a recent I/Q calibration has been performed on the instrument. The procedure for performing an I/Q calibration (refer to [“I/Q Calibration” on page 268](#)).

This procedure builds upon the previous procedure.

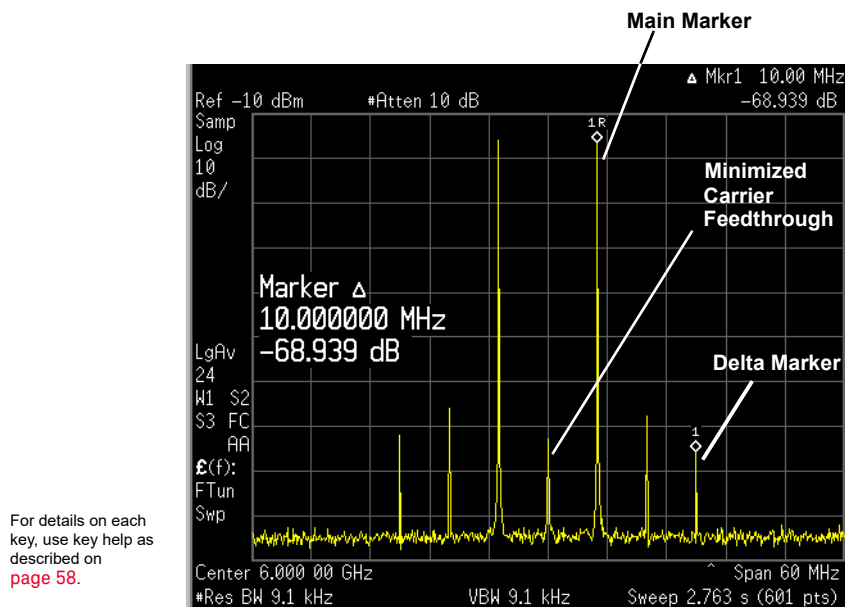
1. On the spectrum analyzer, set the resolution bandwidth for a sweep rate of about 100 to 200 ms. This will allow you to dynamically view the carrier feedthrough spike as you make adjustments.
2. On the signal generator, press **I/Q > I/Q Adjustments > I/Q Adjustments Off On** to On.
3. Press **Internal Baseband Adjustments > I Offset** and turn the rotary knob while observing the carrier feedthrough with the spectrum analyzer. Changing the I offset in the proper direction will reduce the feedthrough level. Adjust the level as low as possible.
4. Press **Q Offset** and turn the rotary knob to further reduce the carrier feedthrough level.

5. Repeat steps 3 and 4 until you have reached the lowest possible carrier feedthrough level.
6. On the spectrum analyzer, return the resolution bandwidth to its previous setting.
7. Turn on waveform averaging.
8. Create a marker and place it on the peak of one of the two tones.
9. Create a delta marker and place it on the peak of the adjacent intermodulation product, which should be spaced 10 MHz from the marked tone.
10. Measure the power difference between the tone and its distortion product.

You should now see a display that is similar to the one shown in [Figure 17-3 on page 434](#). Your optimized two-tone signal can now be used to measure the IMD products generated by a device-under-test.

Note that carrier feedthrough changes with time and temperature. Therefore, you will need to periodically readjust your I and Q offsets to keep your signal optimized.

Figure 17-3



## Changing the Alignment of a Two-Tone Waveform

This procedure describes how to align a two-tone waveform left or right, relative to the center carrier frequency. Because the frequency of one of the tones is the same as the carrier frequency, this alignment typically hides any carrier feedthrough. However, image frequency interference caused by left or right alignment may cause minor distortion of the two-tone signal. This procedure builds upon the previous procedure.

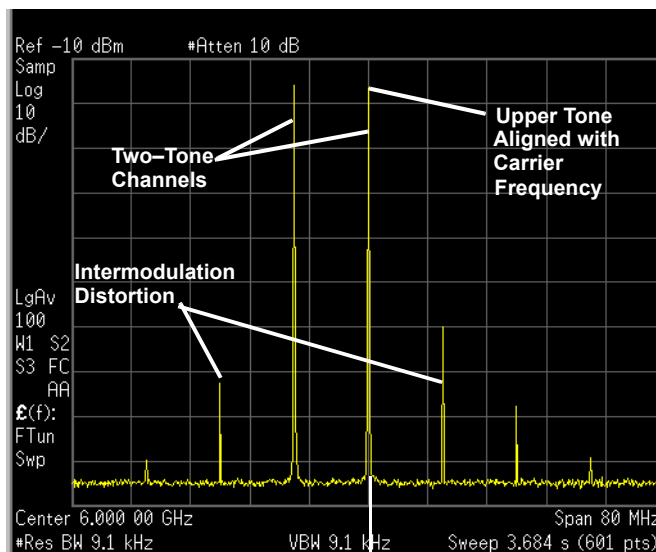
1. On the signal generator, press **Mode > Two Tone > Alignment Left Cent Right to Left**.
2. Press **Apply Settings** to regenerate the waveform.

**NOTE**

Whenever a change is made to a setting while the two-tone generator is operating (**Two Tone Off On** set to On), you must apply the change by pressing the **Apply Settings** softkey before the updated waveform will be generated. When you apply a change, the baseband generator creates a two-tone waveform using the new settings and replaces the existing waveform in ARB memory.

3. On the spectrum analyzer, temporarily turn off waveform averaging to refresh your view more quickly. You should now see a left-aligned two-tone waveform that is similar to the one shown in [Figure 17-4](#).

Figure 17-4

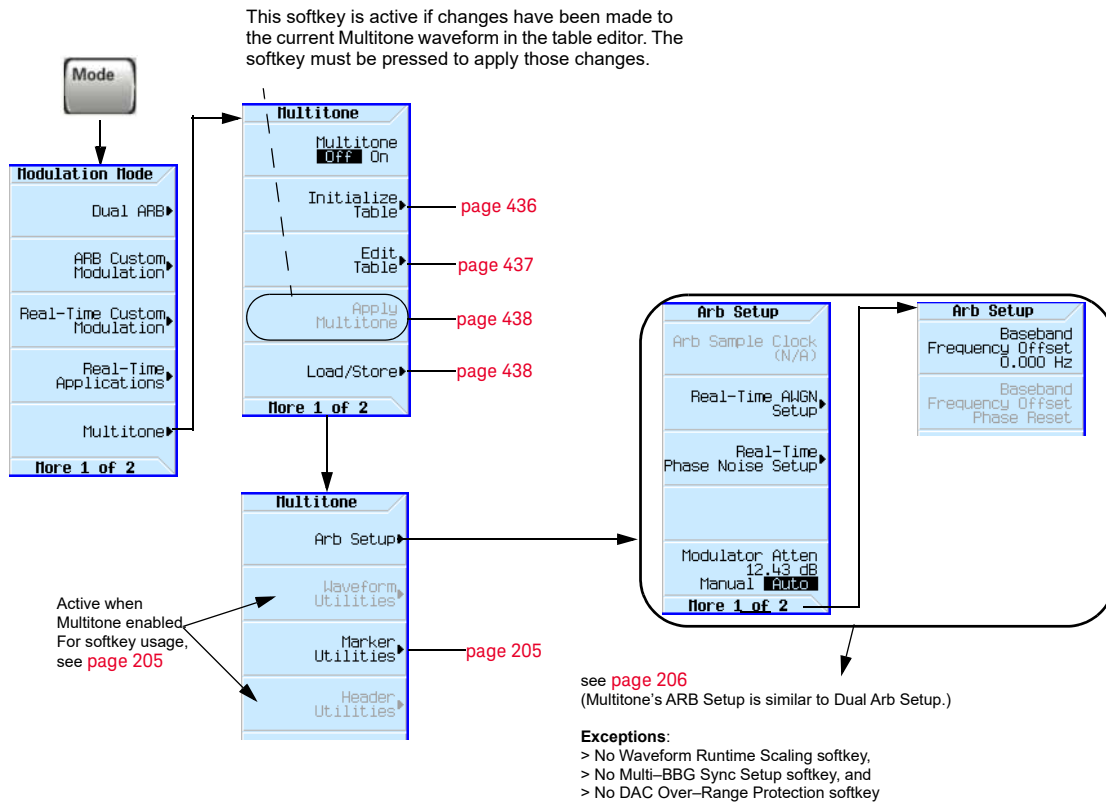


For details on each key, use key help as described on [page 58](#).

**Carrier  
Frequency**

## Using Multitone Modulation

### Multitone Modulation Softkeys



For details on each key, use key help as described on [page 58](#).

### Initializing the Multitone Setup Table Editor

1. Press **Preset**.
2. Press **Mode** > **Multitone**
3. Press **Initialize Table** > **Number of Tones** > **5** > **Enter**.
4. Press **Freq Spacing** > **20** > **kHz**.

Figure 17-5

FREQUENCY		RF OFF		Init Tones	
6.000 000 000 00 GHz		-144.00 dBm		Number Of Tones 5	
Number of Tones: 5				Freq Spacing 20.000 kHz	
Multitone Setup: default (UNSTORED)				Initialize Phase Fixed Random	
Tone	Freq Offset	Power	Phase	State	
1	-40.000 kHz	0.00 dB	0	On	
2	-20.000 kHz	0.00 dB	0	On	
3	0.000 kHz	0.00 dB	0	On	
4	20.000 kHz	0.00 dB	0	On	
5	40.000 kHz	0.00 dB	0	On	
03/08/2012 12:14				Done	
				More 1 of 2	



The Random Seed softkey that affects the Multitone's phase values is *not* used in the following examples and is shown for reference, only.

For details on each key, use key help as described on page 58.

### 5. Press Done.

You now have a multitone setup with five tones spaced 20 kHz apart. The center tone is placed at the carrier frequency, while the other four tones are spaced in 20 kHz increments from the center tone.

## Configuring Tone Powers and Tone Phases

1. Highlight the value (0 dB) in the **Power** column for the tone in row 2.
2. Press **Edit Table > Edit Item > -4.5 > dB**.
3. Highlight the value (0) in the **Phase** column for the tone in row 2.
4. Press **Edit Item > 123 > deg**.

## Removing a Tone

1. Highlight the value (On) in the **State** column for the tone in row 4.
2. Press **Toggle State**.

## Generating the Waveform

Press **Return > Multitone Off On** until On is highlighted.

This generates the multitone waveform with the parameters defined in the previous sections. During waveform generation, the **M-TONE** and **I/Q** annunciators activate and the multitone waveform is stored in volatile ARB memory. The waveform is now modulating the RF carrier.

## Configuring the RF Output

1. Set the RF output frequency to 100 MHz.

**2. Set the output amplitude to 0 dBm.**

**3. Press RF On/Off.**

The multitone waveform is now available at the signal generator's RF OUTPUT connector.

## Applying Changes to an Active Multitone Signal

If the multitone generator is currently in use (**Multitone Off On** set to On) while changes are made in the **Multitone Setup** table editor, you must **apply** the changes before the updated waveform will be generated.

From the **Multitone Setup** table editor, press the following key to apply the changes and generate a multitone waveform based on the updated values: **Apply Multitone**

## Storing a Multitone Waveform

In this example, you learn how to store a multitone waveform. If you have not created a multitone waveform, complete the steps in the previous section, **Creating a Custom Multitone Waveform** on page 430.

**1. Press Load/Store > Store To File.**

If there is already a file name from the **Catalog of MTONE Files** occupying the active entry area, press the following keys (see [page 59](#)):

**Edit Keys > Clear Text**

**2. Enter a file name (for example, 5TONE) using the alpha keys and the numeric keypad with a maximum length of 23 characters (see [page 59](#)).**

**3. Press Enter.**

The multitone waveform is now stored in the **Catalog of MTONE Files**.

### NOTE

The RF output amplitude, frequency, and operating state settings are not stored as part of a multitone waveform file. Similarly, the multitone settings are not stored as part of the instrument state. Therefore, in most cases you should save both the instrument states and the multitone settings to be able to restore all of your settings later.

---

## Recalling a Multitone Waveform

Using this procedure, you learn how to recall a multitone waveform from the signal generator's memory catalog.

If you have not created and stored a multitone waveform, complete the steps in the previous sections, [Creating a Custom Multitone Waveform](#) on page 430 and [Storing a Multitone Waveform](#) on page 438, then preset the signal generator to clear the stored multitone waveform from volatile ARB memory.

1. Press **Mode** > **Multitone**.
2. Press **Load/Store**.
3. Highlight the desired file (for example, 5TONE).
4. Press **Load From Selected File** > **Confirm Load From File**.
5. Press **Multitone Off On** until **On** is highlighted.

The firmware generates the multitone waveform in ARB memory. After waveform generation, the multitone waveform is available to be modulated on the RF output.

For instruction on configuring the RF output, see [Configuring the RF Output](#) on page 437.

Multitone and Two-Tone Waveforms (Option N5180430B)  
Using Multitone Modulation



## 18 Troubleshooting

- **Display** on page 442
- **Signal Generator Lock-Up** on page 442
- **RF Output** on page 443
  - **No RF Output**
  - **Power Supply Shuts Down**
  - **No Modulation at the RF Output**
  - **RF Output Power too Low**
  - **Distortion**
  - **Signal Loss While Working with a Spectrum Analyzer**
  - **Signal Loss While Working with a Mixer**
- **Sweep** on page 447
  - **Cannot Turn Off Sweep**
  - **Sweep Appears Stalled**
  - **Incorrect List Sweep Dwell Time**
  - **List Sweep Information is Missing from a Recalled Register**
  - **Amplitude Does Not Change in List or Step Sweep**
- **Internal Media Data Storage** on page 448
  - **Instrument State Saved but the Register is Empty or Contains the Wrong State**
- **USB Media Data Storage** on page 448
  - **Instrument Recognizes USB Media Connection, but Does Not Display Files**
- **Preset** on page 448
  - **The Signal Generator Does Not Respond**
  - **Pressing Preset Performs a User Preset**
- **Error Messages** on page 449
- **Front Panel Tests** on page 450
- **Self Test Overview** on page 450
- **Licenses** on page 452
- **Contacting Keysight Technologies** on page 453
  - **Returning a Signal Generator to Keysight**

## Display

### The Display is Too Dark to Read

Brightness may be set to minimum. Use the figure in **“Display Settings” on page 43** to locate the brightness softkey and adjust the value so that you can see the display.

### The Display Turns Black when Using USB Media

Removing the USB media when the instrument begins to use it can cause the screen to go black. Cycle instrument power.

## Signal Generator Lock-Up

- Ensure that the signal generator is not in remote mode (the  $\mathbb{R}$  annunciator shows on the display). To exit remote mode and unlock the front panel, press **Local Cancel/(Esc)**.
- Ensure that the signal generator is not in local lockout, which prevents front panel operation. For information on local lockout, refer to the **Programming Guide**.
- If a progress bar appears on the signal generator display, an operation is in progress.
- Preset the signal generator.
- Cycle power on the signal generator.

## RF Output

### No RF Output

- Check the **RF ON/OFF** LED (shown on [page 21](#)). If it is off, press **RF On/Off** to turn the output on.
- Ensure that the amplitude is set within the signal generator's range.
- If the instrument is playing a waveform, ensure that marker polarity and routing settings are correct (see [“Saving Marker Polarity and Routing Settings” on page 222](#)).

### Power Supply Shuts Down

If the power supply does not work, it requires repair or replacement. If you are unable to service the instrument, send the signal generator to an Keysight service center for repair (see [“Contacting Keysight Technologies” on page 453](#)).

### No Modulation at the RF Output

Check both the Mod On/Off LED and the **<modulation> Off On** softkey, and ensure that both are on. See also [“Modulating the Carrier Signal” on page 72](#).

For digital modulation on a vector signal generator, ensure that the internal I/Q modulator is on (the I/Q annunciator displays).

If using an external modulation source, ensure that the external source is on and that it is operating within the signal generator's specified limits.

### RF Output Power too Low

- If the **AMPLITUDE** area of the display shows the **OFFS** indicator, eliminate the offset:  
Press **Amptd > More 1 of 2 > Amptd Offset > 0 > dB**. See also [“Setting an Output Offset” on page 124](#).
- If the **AMPLITUDE** area of the display shows the **REF** indicator, turn off the reference mode:
  1. Press **Amptd > More > Amptd Ref Off On** until **OFF** highlights.
  2. Reset the output power to the desired level.See also [“Setting an Output Reference” on page 125](#).
- If you are using the signal generator with an external mixer, see [page 445](#).
- If you are using the signal generator with a spectrum analyzer, see [page 444](#).
- If pulse modulation is on, turn off the ALC, and check that pulse width is within specifications.

### Distortion

If you edit and resave a segment in a waveform sequence, the sequence does not automatically update the RMS value stored in its header. This can cause distortion on the output signal. Display the sequence header information and recalculate the RMS value (see [page 215](#)).

## Signal Loss While Working with a Spectrum Analyzer

### CAUTION

To avoid damaging or degrading the performance of the signal generator, do not exceed 33 dBm (2W) maximum of reverse power levels at the RF input. See also **Tips for Preventing Signal Generator Damage** on [www.keysight.com](http://www.keysight.com).

---

The effects of reverse power can cause problems with the RF output when you use the signal generator with a spectrum analyzer that does not have preselection. Use an unleveled operating mode (described on [page 120](#)).

A spectrum analyzer can have as much as +5 dBm LO feedthrough at its RF input port at some frequencies. If the frequency difference between the LO feedthrough and the RF carrier is less than the ALC bandwidth, the LO's reverse power can amplitude modulate the signal generator's RF output. The rate of the undesired AM equals the difference in frequency between the spectrum analyzer's LO feedthrough and the signal generator's RF carrier.

Reverse power problems can be solved by using one of the unleveled operating modes.

See:

- [“ALC Off Mode” on page 120](#)
- and
- [“Power Search Mode” on page 121](#)

## Signal Loss While Working with a Mixer

### CAUTION

To avoid damaging or degrading the performance of the signal generator, do not exceed 33 dBm (2W) maximum of reverse power levels at the RF input. See also **Tips for Preventing Signal Generator Damage** on [www.keysight.com](http://www.keysight.com).

To fix signal loss at the signal generator's RF output during low-amplitude coupled operation with a mixer, add attenuation and increase the RF output amplitude.

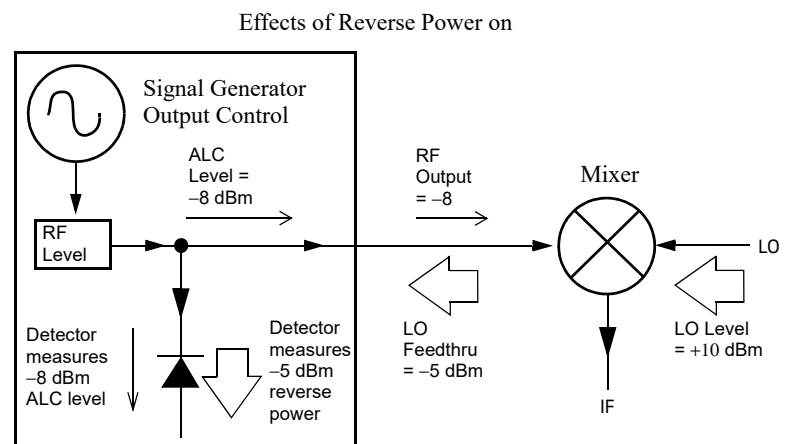
The figure at right shows a configuration in which the signal generator provides a low amplitude signal to a mixer.

The internally leveled signal generator RF output (and ALC level) is

-8 dBm. The mixer is driven with an LO of +10 dBm and has an LO-to-RF isolation of 15 dB. The resulting

-5 dBm LO feedthrough enters the signal generator's RF output connector and arrives at the internal detector.

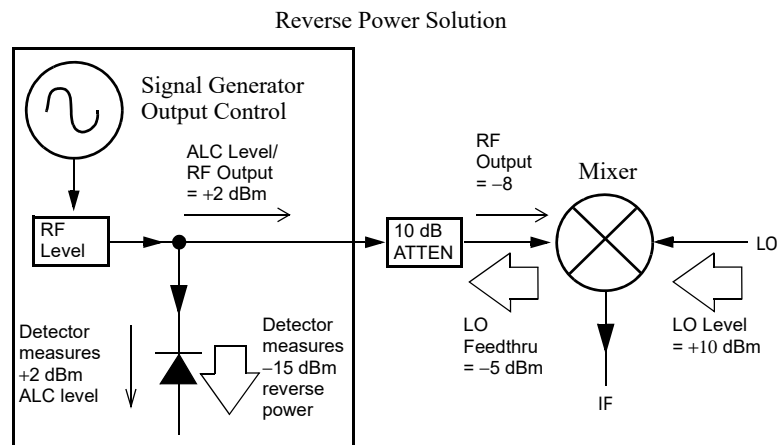
Depending on frequency, it is possible for most of this LO feedthrough energy to enter the detector. Because the detector responds to its total input power regardless of frequency, this excess energy causes the ALC to reduce the RF output. In this example, the reverse power across the detector is actually greater than the ALC level, which can result in loss of signal at the RF output.



The solution at right shows a similar configuration with the addition of a 10 dB attenuator connected between the RF output of the signal generator and the input of the mixer. The signal generator's ALC level increases to +2 dBm and transmits through a 10 dB attenuator to achieve the required -8 dBm amplitude at the mixer input.

Compared to the original configuration, the ALC level is 10 dB higher while the attenuator reduces the LO feedthrough (and the signal generator's RF output) by 10 dB. Using the attenuated configuration, the detector is exposed to a +2 dBm desired signal versus the

-15 dBm undesired LO feedthrough. This 17 dB difference between desired and undesired energy results in a maximum 0.1 dB shift in the signal generator's RF output level.



## Sweep

### Cannot Turn Off Sweep

Press **Sweep** > **Sweep** > **Off**.

### Sweep Appears Stalled

The current status of the sweep is indicated as a shaded rectangle in the progress bar (see [“Configuring a Swept Output” on page 64](#)). If the sweep appears to stall, check the following:

1. Turn on the sweep with one of the following key sequences:
  - Sweep** > **Sweep** > **Freq**
  - Sweep** > **Sweep** > **Amptd**
  - Sweep** > **Sweep** > **Waveform** (vector instruments only)
2. If the sweep is in single mode, press the **Single Sweep** softkey.
3. If the sweep trigger (indicated by the **Sweep Trigger** softkey) is **not** set to Free Run, set it to Free Run to determine if a missing sweep trigger is blocking the sweep.
4. If the point trigger (indicated by the **Point Trigger** softkey) is **not** set to Free Run, set it to Free Run to determine if a missing point trigger is blocking the sweep.
5. Set the dwell time to one second to determine if the dwell time was set to a value that was too slow or too fast to see.
6. Ensure that you set at least two points in the step sweep or list sweep.

### Incorrect List Sweep Dwell Time

1. Press **Sweep** > **More** > **Configure List Sweep**.
2. Check that the list sweep dwell values are accurate.
3. If the dwell values are incorrect, edit them.  
If the dwell values are correct, continue to the next step.
4. Press **More**, and ensure that the **Dwell Type List Step** softkey is set to List.  
If Step is selected, the signal generator sweeps the list points using the dwell time set for step sweep rather than list sweep.

See also [“Configuring a Swept Output” on page 64](#).

### List Sweep Information is Missing from a Recalled Register

List sweep information is not stored as part of the instrument state in an instrument state register. Only the current list sweep is available to the signal generator. You can store list sweep data in the instrument catalog (see [“Loading \(Recalling\) a Stored File” on page 79](#)).

## Amplitude Does Not Change in List or Step Sweep

Verify that sweep type is set to amplitude (Amptd); the amplitude does not change when the sweep type is set to frequency (Freq) or waveform.

## Internal Media Data Storage

### Instrument State Saved but the Register is Empty or Contains the Wrong State

If the register number you intended to use is empty or contains the wrong instrument state, recall register 99. If you selected a register number greater than 99, the signal generator automatically saves the instrument state in register 99.

See also **“Working with Instrument State Files” on page 80.**

## USB Media Data Storage

### Instrument Recognizes USB Media Connection, but Does Not Display Files

If the USB media works on other instruments or computers, it may simply be incompatible with the signal generator; try a different USB media. Refer to <http://www.keysight.com/find/mxg> for details on compatible USB media.

## Preset

### The Signal Generator Does Not Respond

If the signal generator does not respond to a preset, the instrument may be in remote mode, which locks the keypad.

To exit remote mode and unlock the preset keys, press **Local Cancel/(Esc)**.

### Pressing Preset Performs a User Preset

This behavior results from the use of a backward-compatible SCPI command. To return the signal generator to normal use, send the command `:SYST:PRESet:TYPE NORM`.

For information on SCPI commands, refer to the **SCPI Command Reference**.



## Error Messages

### Error Message Types

Events do not generate more than one type of error. For example, an event that generates a query error does not generate a device-specific, execution, or command error.

**Query Errors (–499 to –400)** indicate that the instrument’s output queue control has detected a problem with the message exchange protocol described in IEEE 488.2, Chapter 6. Errors in this class set the query error bit (bit 2) in the event status register (IEEE 488.2, section 11.5.1). These errors correspond to message exchange protocol errors described in IEEE 488.2, 6.5. In this case:

- Either an attempt is being made to read data from the output queue when no output is either present or pending, or
- data in the output queue has been lost.

**Device Specific Errors (–399 to –300, 201 to 703, and 800 to 810)** indicate that a device operation did not properly complete, possibly due to an abnormal hardware or firmware condition. These codes are also used for self-test response errors. Errors in this class set the device-specific error bit (bit 3) in the event status register (IEEE 488.2, section 11.5.1).

The <error\_message> string for a **positive** error is not defined by SCPI. A positive error indicates that the instrument detected an error within the GPIB system, within the instrument’s firmware or hardware, during the transfer of block data, or during calibration.

**Execution Errors (–299 to –200)** indicate that an error has been detected by the instrument’s execution control block. Errors in this class set the execution error bit (bit 4) in the event status register (IEEE 488.2, section 11.5.1). In this case:

- Either a <PROGRAM DATA> element following a header was evaluated by the device as outside of its legal input range or is otherwise inconsistent with the device’s capabilities, or
- a valid program message could not be properly executed due to some device condition.

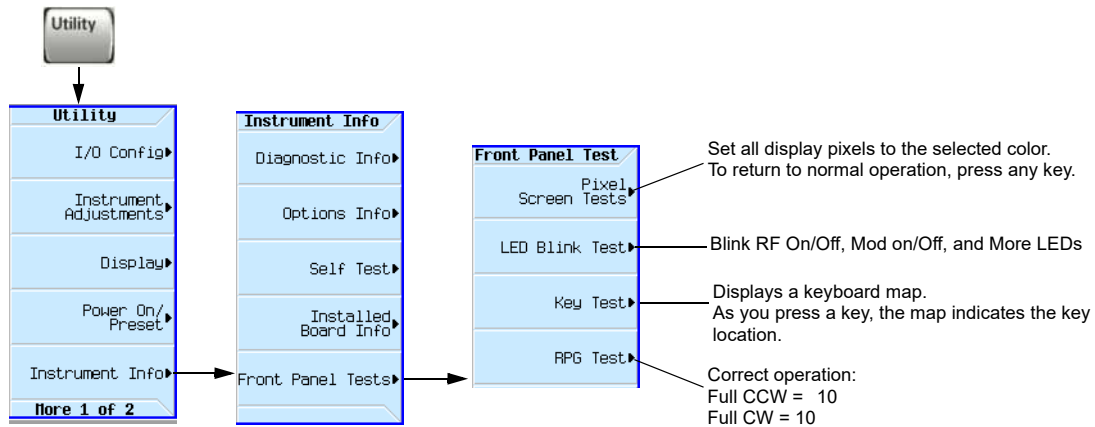
Execution errors are reported **after** rounding and expression evaluation operations are completed. Rounding a numeric data element, for example, is not reported as an execution error.

**Command Errors (–199 to –100)** indicate that the instrument’s parser detected an IEEE 488.2 syntax error. Errors in this class set the command error bit (bit 5) in the event status register (IEEE 488.2, section 11.5.1). In this case:

- Either an IEEE 488.2 syntax error has been detected by the parser (a control-to-device message was received that is in violation of the IEEE 488.2 standard. Possible violations include a data element that violates device listening formats or whose type is unacceptable to the device.), or
- an unrecognized header was received. These include incorrect device-specific headers and incorrect or unimplemented IEEE 488.2 common commands.

**Error Message File** A complete list of error messages is provided on the CDROM supplied with the instrument. In the error message file, an explanation is generally included with each error to further clarify its meaning. The error messages are listed numerically. In cases where there are multiple listings for the same error number, the messages are in alphabetical order.

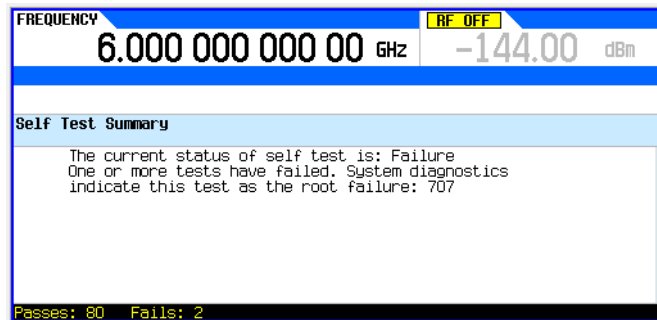
## Front Panel Tests

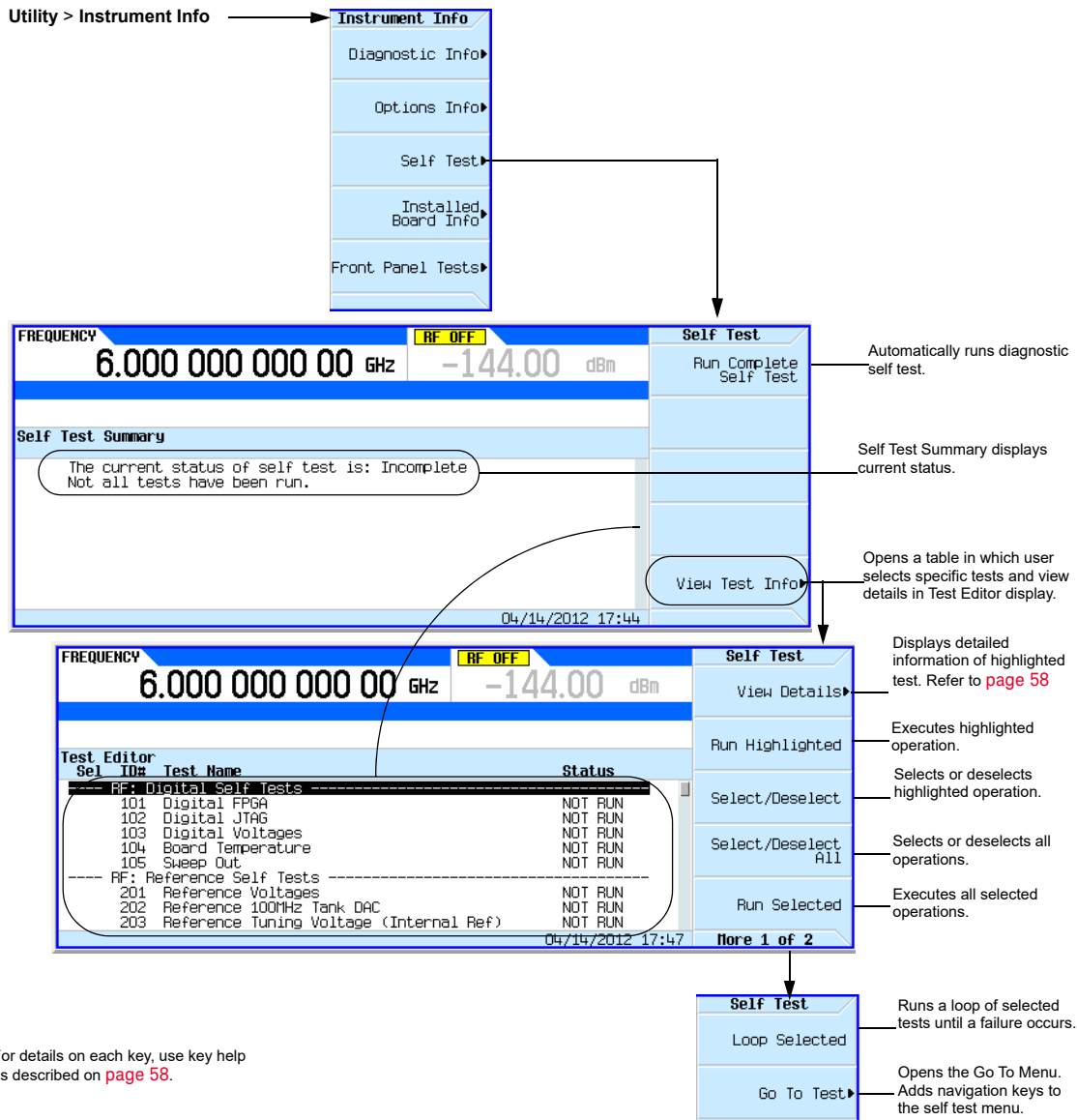


For details on each key, use key help as described on [page 58](#).

## Self Test Overview

The self test is a series of internal tests that checks different signal generator functions. The self test, is also available by via the remote web interface. For more information on the Web-Enabled MXG, refer to the **Programming Guide**.





For details on each key, use key help as described on page 58.

## Licenses

### A Time-Based License Quits Working

- The instrument's time or date may have been reset forward causing the time-based license to expire.
- The instrument's time or date may have been reset backward more than approximately 25 hours, causing the instrument to ignore time-based licenses.

See [page 45](#) for details and cautions on setting time and date.

### Cannot Load a Time-Based License

The instrument's time or date may have been reset backward more than approximately 25 hours, causing the instrument to ignore time-based licenses.

See [page 45](#) for details and cautions on setting time and date.

## Contacting Keysight Technologies

- assistance with test and measurements needs, and information on finding a local Keysight office:  
**<http://www.keysight.com/find/assist>**
- accessories or documentation: **[http://www.keysight.com/find/X-Series\\_SG](http://www.keysight.com/find/X-Series_SG)**.
- new firmware releases: **<http://www.keysight.com/find/upgradeassistant>**.

If you do not have access to the Internet, please contact your field engineer.

### NOTE

In any correspondence or telephone conversation, refer to the signal generator by its model number and full serial number. With this information, the Keysight representative can determine whether your unit is still within its warranty period.

---

## Returning a Signal Generator to Keysight

Use the following steps to return a signal generator to Keysight Technologies for servicing:

1. Gather as much information as possible regarding the signal generator's problem.
2. Call the phone number listed on the Internet (**<http://www.keysight.com/find/assist>**) that is specific to your geographic location. If you do not have access to the Internet, contact your Keysight field engineer.

After sharing information regarding the signal generator and its condition, you will receive information regarding where to ship your signal generator for repair.

3. Ship the signal generator in the original factory packaging materials, if available, or use similar packaging to properly protect the signal generator.



## 19 Working in a Secure Environment

If you are using the instrument in a secure environment, you may need details of how to clear or sanitize its memory, in compliance with published security standards of the United States Department of Defense, or other similar authorities.

For the Series B MXG and EXG instruments, this information is contained in the PDF document "*Security Features and Document of Volatility*". This document is **not** included in the Documentation CD, but it may be downloaded from Keysight's web site, as described below.

The document includes the following topics:

- Security Terms and Definitions
- Instrument Memory Types
- Memory Clearing and Sanitization (Erase All, Erase and Sanitize All functions—requires Option 006)
- Clearing Persistent State information
- Using the Secure Display feature (also documented in **Using Secure Display (Option 006)** on page 456 below and requires Option 006)
- **Using Restricted Display** on page 457—*not* in the "Security Features and Document of Volatility"
- Declassifying a Faulty Instrument

### How to Obtain the Security Features Document

Step	Action
1	Click on or browse to the following URL: <a href="http://www.keysight.com/find/security">http://www.keysight.com/find/security</a>
2	To locate and download the document, select Model Number "N5183B", "N5182B", "N5181B", "N5173B", "N5172B", or "N5171B", then click "Submit".
3	Follow the on-screen instructions to download the PDF file.

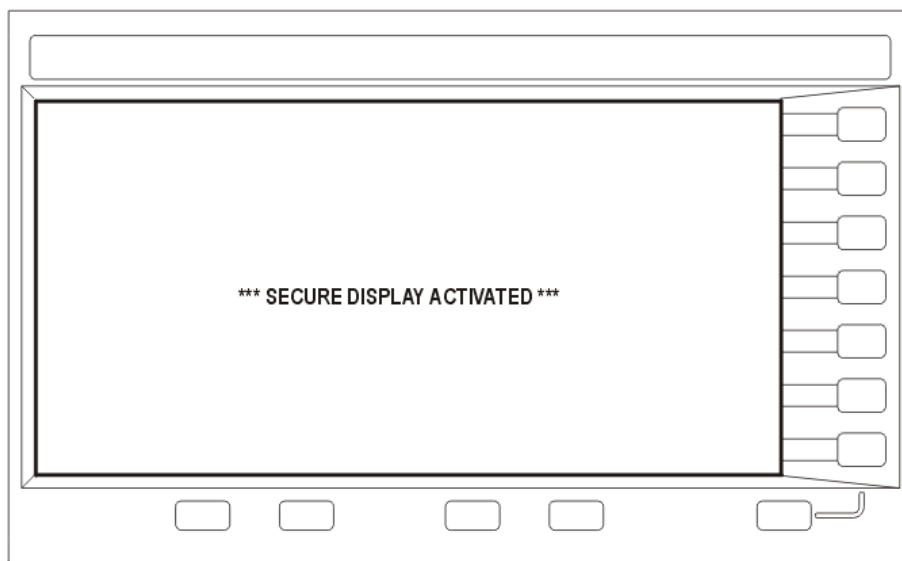
## Using Secure Display (Option 006)

This function prevents unauthorized personnel from reading the instrument display or tampering with the current configuration via the front panel. When Secure Display is active, the display is blank, except for an advisory message, as shown in **Figure 19-1** below. All front panel keys are disabled.

To set Secure Display, press: **Utility > Display > More > Activate Secure Display > Confirm Secure Display.**

Once Secure Display has been activated, the power must be cycled to re-enable the display and front panel keys.

**Figure 19-1** Signal Generator Screen with Secure Display Activated





## Using Restricted Display

While in restricted display mode, all frequency information is hidden and the front panel frequency control is disabled.

To set Restricted Display, perform the following key presses:

**Utility > Display > More > Activate Restricted Display > Confirm Restricted Display.**

Once Restricted Display has been activated, an instrument preset or power cycle is required to re-enable the front panel frequency control.

Working in a Secure Environment  
Using Restricted Display

# Glossary

## A

**Active Entry** The currently selected, and therefore editable, entry or parameter

**ARB** Arbitrary waveform generator

**Avionics** Avionics is a term used to describe the electronic instrumentation on aircraft.

**AWG** Arbitrary waveform generator. Additive white Gaussian noise

## B

**BBG Media** Baseband generator media. Volatile memory, where waveform files are played or edited.

**BNC Connector** Bayonet Neill-Concelman connector. A type of RF connector used to terminate coaxial cable.

## C

**CCW** Counterclockwise

**C/N** Carrier-to-noise ratio

**CW** Continuous wave. Clockwise

## D

**DHCP** Dynamic host communication protocol

**Dwell Time** In a step sweep (see [page 65](#)), the time that the signal is settled and you can make a measurement before the sweep moves to the next point.

## E

**EVM** Error vector magnitude; the magnitude of the vector difference at a given instant between the ideal reference signal and the measured signal.

## F

**Filter factor Alpha** The filter's alpha coefficient. It is only valid for root Nyquist and Nyquist filters.

**Filter Factor BbT** The filter's bandwidth-bit-time (BbT). It is only valid for a Gaussian filter (similar to alpha). BbT is defined by the GSM standard as 0.3 and by the DECT standard as 0.5.

## G

**Gaussian filter** The Gaussian filter does not have a zero Inter-Symbol Interference (ISI). Wireless system architects must decide just how much of the ISI can be tolerated in a system and combine that with noise and interference. The Gaussian filter is Gaussian shaped in both the time and frequency domains, and it does not ring like the root Nyquist filters do. The effects of this filter in the time domain are relatively short and each symbol interacts significantly (or causes ISI) with only the preceding and succeeding symbols. This reduces the tendency for particular sequences of symbols to interact, which makes amplifiers easier to build and more efficient.

**GPIB** General purpose interface bus. An 8-bit parallel bus common on test equipment.

## H

**Hard key** A labeled button on the instrument.

## I

**IF** Intermediate frequency

**Int Media** Internal media. Nonvolatile signal generator memory, where waveform files are stored.

**IP** Internet protocol. The network layer for the TCP/IP protocol suite widely used on Ethernet networks.

## L

**LAN** Local area network

**LO** Local oscillator

**LXI** LAN eXtension for Instrumentation. An instrumentation platform based on industry standard Ethernet technology designed to provide modularity, flexibility, and performance to small- and medium-sized systems. See also <http://www.lxistandard.org>

## M

**Modulation Format** Custom modulation, Two-Tone, or Multitone.

**Modulation Mode** Dual ARB, Custom modulation, Two-Tone, or Multitone.

**Modulation Standard** Refers to a Cellular standard format (i.e. NADC, PDC, PHS, etc.).

**Modulation Type** Refers to the various I/Q constellation types (i.e. PSK, MSK, FSK, C4FM, etc.)

## N

**Non - volatile** That which survives a power cycle (such as files stored in USB media).

Nyquist filter Also referred to as a cosine filter. These filters have the property that their impulse response rings at the symbol rate. Adjacent symbols do not interfere with each other at the symbol times because the response equals zero at all symbol times except the center (desired) one.

## P

Persistent That which is unaffected by preset, user preset, or power cycle.

Point-to-point Time In a step sweep (page 65), the sum of the dwell time, processing time, switching time, and settling time.

## R

Rectangular filter Also referred to as a ideal low pass filter. These filters have very steep cut-off characteristics. The pass band is set to equal the symbol rate of the signal. Due to a finite number of coefficients, the filter has a predefined length and is not truly “ideal”. The resulting ripple in the cut-off band is effectively minimized with a Hamming window. This filter is recommended for achieving optimal ACP. A symbol length of 32 or greater is recommended for this filter.

Root Nyquist filter Also referred to as a Root cosine filter. These filters have the property that their impulse response rings at the symbol rate. Adjacent symbols do not interfere with each other at the symbol times because the response equals zero at all symbol times except the center (desired) one. Root Nyquist filters heavily filter the signal without blurring the symbols together at the symbol times. This is important for transmitting information without errors caused by ISI. Note that ISI does exist at all times except the symbol (decision) times. A cascade of two of these filters has the transfer function of a Nyquist filter. One is in the transmitter, the other in the receiver, so that the system taken as a whole has the zero-ISI properties of an ISI filter.

RMS Root mean square. A time-varying signal’s effective value (the equivalent DC voltage required to generate the equivalent heat across a given resistor). For a sinewave,  $RMS = 0.707 \times \text{peak value}$ .

## S

Softkey A button located along the instrument’s display that performs whatever function is shown next to it on that display.

## T

TCP Transmission control protocol. The most common transport layer protocol used on Ethernet and the Internet.

Terminator A unit indicator (such as Hz or dBm) that completes an entry. For example, for the entry 100 Hz, **Hz** is the terminator.

Type-N Connector Threaded RF connector used to join coaxial cables.

## U

USB Universal serial bus. See also <http://www.usb.org>

User FIR Selects a user-defined set of coefficient values. Each line in the FIR values table contains one coefficient value. The number of coefficient values listed must be a multiple of the selected oversampling ratio. Each coefficient applies to both I and Q components.

V

Volatile That which does not survive a power cycle (such as files stored in BBG media).

## Index

### Symbols

, 272

ΦM

- annunciator, 25
- dc offset, removing, 181
- hardkey, 177
- softkeys, 177, 181

# points softkey, 65

# Skipped Points softkey, 226

### Numerics

10 MHz OUT connector, 30, 39, 40

100Base-T LAN cable, 48

128 QAM softkey, 381, 385, 386, 387, 388, 389, 390, 393

16-Lvl FSK softkey, 381, 385, 386, 387, 388, 389, 390, 393

16QAM softkey, 381, 385, 386, 387, 388, 389, 390, 393

2's complement  
description, 322, 336

256 QAM softkey, 381, 385, 386, 387, 388, 389, 390, 393

2-Lvl FSK softkey, 381, 385, 386, 387, 388, 389, 390, 393

32QAM softkey, 381, 385, 386, 387, 388, 389, 390, 393

4-Lvl FSK softkey, 381, 385, 386, 387, 388, 389, 390, 393

4QAM softkey, 381, 385, 386, 387, 388, 389, 390, 393

628, error, 259

64QAM softkey, 381, 385, 386, 387, 388, 389, 390, 393

651/652/654, option  
description, 20

multitone mode, 436

two-tone mode, 431

8557D GPIB only softkey, 49, 51

8648A/B/C/D GPIB only  
softkey, 49, 51

8656B, 8657A/B GPIB only  
softkey, 49, 51

8-Lvl FSK softkey, 381, 385, 386, 387, 388, 389, 390, 393

### A

AC power receptacle, 28, 37

ACP, 378

Activate Secure Display  
softkey, 43

active

entry, 459

entry area, 25

Active High softkey, 238

Active Low softkey, 238

Add Comment To softkey, 81

additive white Gaussian noise.  
See AWGN

address, GPIB, 47

Adjust Phase softkey, 61, 63

Adjustable doublet  
softkey, 188

adjustments

I/Q, 200, 267

quadrature, 267

real-time phase noise, 371

advance, segment, 240

Advanced Settings softkey, 48

Aeroflex softkey, 49, 51

ALC

hold, 222, 223

OFF annunciator, 25

off mode, 120

softkeys, 61, 63, 226

alc

setting, 63

All softkey, 75

Alpha, 459

AM

annunciator, 25

external source, 181

hardkey, 177

softkeys, 177

wideband, 182

amplitude

display area, 26

hardkey, 61, 63

LF output, 184, 185

modulation, 177

offset, 124

reference, 125

setting, 61, 63

troubleshooting sweep, 448

AMPTD hardkey, 61, 63

analog modulation, 19, 177

configuring, 178, 183

angle, quadrature, 200

annunciators, 25

APCO 25 w/C4FM softkey, 380, 384

APCO 25 w/CQPSK  
softkey, 380, 384

apodization settings, FIR  
filter, 278, 419

Apply To Waveform  
softkey, 226

ARB

definition, 459

player, dual, 205

softkeys, 205, 236, 361, 362, 363, 364, 368, 374

waveform clipping, 244

arb, 378

Arb Custom

FIR filters, 412

FIR table editor, 419

Arb Segment softkey, 80

Arb Sequence softkey, 80

arb setup

softkey, 281

ARMED annunciator, 25

arrow keys, 59

ASK Depth softkey, 381, 385, 386, 387, 388, 389, 390, 393

ASK softkey, 381, 385, 386, 387, 388, 389, 390, 393

ATTEN HOLD annunciator, 25

Atten/ALC Control softkey, 61, 63

Auto softkeys

(DHCP/Auto-IP), 48

Auto, 97, 120

Recall, 130

AUTOGEN\_WAVEFORM

file, 378

auto-IP, 48

Auto-IP softkey, 48

Automatically Use USB Media

If Present softkey, 75

AUX I/O connector, 33

Auxiliary Software Options

softkey, 54

Avionics

definition, 459

- Avionics Softkey Menus, 131, 337, 338, 339, 340
- Avionics VOR/ILS, 131
- AWGN
  - adding, 359
  - annunciator, 25
  - definition, 459
  - dual ARB player, 360
  - softkeys, 366
- AWGN softkeys, 361, 362, 363, 364
- B**
- backspace hardkey, 59
- bandwidth ratio, 366
- Bandwidth softkey, 366
- baseband, 33
  - aligning signals at, 222
  - clipping, 244
  - frequency offset
    - softkey location, 259
  - frequency offset, setting, 259
  - I/Q output connectors, 31
  - memory, 205
  - noise, 359
  - noise annunciator, 25
  - quadrature adjustment, 267
  - real time I/Q AWGN, 361, 362, 363, 364, 366
  - softkey, 259
  - summing signals, 266
  - waveforms convert to analog, 254
- baseband frequency offset
  - DAC over range & scaling, 261
  - softkey, 259
- baseband generator, 378
- custom arb mode, 20
- dual arb mode, 20
- multiple BBG
  - synchronization, 283
- multitone mode, 20, 436
- two-tone mode, 431
- BB GEN, 266
- BBG
  - media, 205, 207
  - media (definition), 459
  - Memory softkey, 80
  - Memory to USB softkey, 80
  - routing, 266
  - Segments softkey, 75, 215
- BBG sync, 283
  - configure setup, 286
  - equipment setup, 286
  - resynchronization, 288
  - system, 285
  - system delay, 284
  - trigger setup, 285
- BbT, 459
- BERT
  - Option N5180UN7B, 337
- Binary softkey, 75
- bit file editor, using, 386
- bits per symbol, equation, 423
- Bk Sp hardkey, 59
- Bluetooth softkey, 380, 381, 384, 385, 386, 387, 388, 389, 390, 393
- BNC, 459
- Bright Color softkey, 43
- brightness adjustment, 43
- Brightness softkey, 43
- Buffered Trig softkey, 238
- Build New Waveform Sequence softkey, 210, 234
- Burst Envelope softkey, 264
- Bus softkey, 64
- C**
- C/N, 459
- C4FM softkey, 381, 385, 386, 387, 388, 389, 390, 393
- cables
  - crossover, 48
  - multi-BBG sync, 284
- cables, 100Base-T LAN, 48
- Calculate softkey, 215
- calibration
  - I/Q, 268
  - softkey, 268
- Calibration Type softkey, 268
- Cancel hardkey, 22
- carrier
  - bandwidth, 360
  - configuring, 62
  - feedthrough, 200
  - modulating, 72
  - softkeys, 361, 362, 363, 364
  - to noise ratio, 360
- Carrier Bandwidth softkey, 361, 362, 363, 364
- carrier feedthrough, minimizing, 433
- Carrier Softkey, 361, 362, 363, 364
- Carrier to Noise softkey, 361, 362
- Carrier+Noise softkey, 361, 363, 364
- Catalog Type softkey, 75, 76, 80, 215
- catalog, state files, 84
- ccw, 459
- CDPD softkey, 380, 381, 384, 385, 386, 387, 388, 389, 390, 393
- ceiling function, bits per symbol, 423
- Channel Band softkey, 61, 63
- channel bandwidth, 366
- Channel Number softkey, 61, 63
- circular clipping, 248, 251
- classified. See security
- Clear softkeys
  - Error Queue(s), 86
  - Header, 215
  - Text, 59
- clipping
  - circular, 248, 251
  - rectangular, 249, 252
  - softkeys, 244
- clock adjustment
  - phase and skew, 313
- clock gate, 342
- clock rate limits, logic type output, 304
- clock source
  - setting, 325, 332
- clock timing
  - parallel data, 309
  - parallel interleaved data, 311
  - phase and skew, 313
  - serial data, 312
- clock, sample rate, 33
- clocking, frequency reference
  - reference, 307
- clocking, frequency reference diagrams, 308
- clocks per sample
  - parallel data, 309
  - parallel interleaved data, 311
- coefficient values, entering, 273, 414
- color palette, display, 43
- COM/ID Softkey Menus, 142
- comments, adding & editing (instrument state), 82
- common frequency reference diagrams, 308
- component test, 378
- Config Type softkey, 48
- Configure softkeys
  - Cal Array, 101
  - List Sweep, 64, 67
  - Step Array, 101



- Step Sweep, 64, 65
- Confirm Load From File
  - softkey, 79
- Connection Monitoring
  - softkey, 48
- Connection Type softkeys
  - Sockets, 103
  - USB, 103
  - VXI-11, 103
- connections
  - common frequency
    - reference, 308
- connectors
  - external triggering
    - source, 241, 243
  - front panel, 21
  - rear panel
    - n5161a, 28, 37
    - n5162a, 28, 37
    - n5181a, 28, 37
    - n5182a, 28, 37
  - routing signals, 65
- Continuous softkey, 238
- continuous step sweep
  - example, 70
- continuous wave
  - description, 19
- continuous wave output, 62
- contrast adjustment, 43
- Contrast softkey, 43
- Copy & softkeys
  - Play Sequence, 79
  - Play Waveform, 79
  - Select User Flatness, 79
  - Select User Flatness
    - Corrections, 79
- Copy softkeys
  - All Files, 80
  - File, 75
  - File to Instrument, 75, 80
  - File to USB, 80
- correction array (user flatness), 106
  - viewing, 107
  - See also user flatness
    - correction
- corrections, internal
  - channel, 109
- cosine filter. See nyquist filter
- Create Directory softkey, 75, 80
- crossover cable, 48
- custom
  - multicarrier TDMA waveforms
    - creating, 409
  - TDMA digital modulation, 397
- custom arb, 293, 378
- Custom ARB softkeys, 293, 379, 383
  - custom arb waveform
    - generator, 20
  - custom mode, 378
  - custom modulation
    - adding to a waveform, 397
    - waveform, adding to, 397
  - cw, 459
  - CW (no modulation)
    - softkey, 67
  - CW mode
    - description, 19
- D
- DAC over range error, 254, 259
- DAC over range protection
  - baseband frequency
    - offset, 261
  - phase noise, 372
- Dark Color softkey, 43
- data
  - entry softkeys, 59
  - erasing, 455
  - files, 74 to 80
  - removing, 455
  - serial, synchronizing, 33
  - storage
    - comments, adding and
      - editing, 82
    - troubleshooting, 448
    - type, 85
    - using, 74
- data files
  - creating, 387
  - modifying, 389
- data filtering, pre or post
  - fir, 322, 335
- data processing, 349
- data types, 317
- date, setting, 45
- dc offset, 200
- dc offset, removing, 181
- DCFm $\Phi$ /DCfM Cal softkey, 179
- Declassifying faulty
  - instrument, 455
- DECT softkey, 380, 384
- Default Gateway softkey, 48
- default settings
  - restoring, 44, 48, 268
  - system, restoring, 58
- Default softkey, 380, 384
- delay
  - I/Q, 267
- multiple BBG sync, 284
- Delete softkeys
  - All Regs in Seq, 81
  - All Segments On Int
    - Media, 207
  - All Segments On USB
    - Media, 207
  - All Sequence Files, 75
  - All Sequences, 81, 130
  - All Waveforms, 210
  - All Waveforms softkey, 234
  - File, 75
  - File or Directory, 75, 77, 80, 85
  - Item, 67
  - Row, 67
  - Selected Waveform, 210, 234
  - Seq Reg, 81
  - Waveform Sequence, 234
- description & plots, phase
  - noise, 369
- DETHTR annunciator, 25
- device clock source
  - selection, 325, 332
- Device softkey, 61, 63
- DHCP, 48, 459
- DHCP softkey, 48
- diagram
  - data types, 317
- diagrams
  - clock timing
    - parallel data, 309
    - parallel
      - interleaved
        - data, 311
      - phase and skew, 313
      - serial data, 312
  - common frequency
    - reference, 308
- Diff Mode softkeys, 267
- differential encoding, 422
- differential encoding, bits per
  - symbol, 423
- differential state map, bits per
  - symbol, 423
- DIGBUS annunciator, 25
- digital bus, 32
- digital modulation
  - formats, 20
  - IQ map, QAM, 422
  - multitone, 436 to 439
  - TDMA, 397
  - two tone, 431 to 435
- digital modulation type
  - modifying, 399
- digital operation, 203, 294
- Digital Signal Interface Module
  - Option 003 or 004, 337

- digital signal interface module
  - N5102A, 303
- digital signal to analog
  - waveform, 254
- discrete steps, skew range, 313
- display
  - blanking, 455
  - error message area, 26
  - overview, 21
  - overview,
    - N5181A/82A/83A, 25
  - secure, 455
  - settings, 43
  - softkey labels, 27
  - softkeys, 41, 59, 226
  - tests, 450
  - text area, 27
  - troubleshooting, 442
- Display softkeys
  - Case, 59
  - display, 41
  - Waveform And Markers, 226
- Displayed Case softkeys, 59
- distortion, troubleshooting, 443
- DNS Server Override
  - softkey, 48
- DNS Server softkey, 48
- documentation, 15
- Domain Name softkey, 48
- doublet
  - adjustable, 190
  - softkeys, 188
  - trigger, 190
- Dual ARB
  - FIR table editor, 273, 278
  - real-time modulation, 281
  - user-defined FIR, 273
- dual ARB
  - multi-BBG sync, 283
  - player, 205
  - real-time noise, 360
  - softkeys, 206, 361, 362, 363, 364, 368, 374
- dual arb, 378
- dual ARB player, 20
- Dual ARB Real-Time
  - filters, 272
- dual arbitrary waveform
  - generator, 20
- dual display, power meter, 88
- dwelt time, 67, 459
- Dwell Type softkey, 67
- dwelt, troubleshooting, 447
- Dynamic DNS Naming
  - softkey, 48
- Dynamic Hostname Services
  - softkey, 48
- E
  - E4428C, E4438C softkey, 49, 51
  - E442xB, E443xB softkey, 49, 51
  - E8241A, E8244A, E8251A,
    - E8254A softkey, 49, 51
  - E8247C, E8257C, E8267C
    - softkey, 49, 51
  - E8257D, E8267D softkey, 49, 51
  - EDGE
    - custom digital modulation,
      - predefined, 397
  - EDGE softkey, 380, 384
  - Edit softkeys
    - Description, 215
    - Noise RMS Override, 215
    - Repetitions, 234
    - RMS, 215
    - Selected Waveform
      - Sequence, 210, 234
  - Editing Keys softkey, 59
  - Editing Mode softkey, 59
  - editor, bit file, 386
  - Enable/Disable Markers
    - softkey, 210, 234
  - Enter Directory softkey, 79
  - entry, active, 459
  - equalization
    - filter, 270
    - filter, user, 270
  - equipment setup, 286
  - equipment, user flatness
    - correction, 102, 103
  - Erase All, 455
  - Erase and Sanitize All, 455
  - ERR annunciator, 26
  - Error hardkey, 86
  - error messages, 86
    - DAC over range, 254, 259
    - display area, 26
    - message format, 86
    - types, 449
  - Esc hardkey, 22
  - EVENT
    - connector, AUX I/O, 33
    - connector, BNC, 31, 221
    - output jitter, 236
    - outputs, 221
  - EVM, 459
  - EVM error, 200
  - example
    - Waveform license, Opt 25x
      - adding a waveform, 299
- locking a slot, 299
- examples
  - FIR filters
    - creating, 273, 412, 414
    - modifying, 278, 419
  - LF output, configuring, 183
  - Execute Cal softkey, 268
  - EXT CLOCK connector, 31
  - EXT REF annunciator, 25, 26
  - Ext softkeys
    - Delay, 239
    - Delay Time, 239
    - Ext, 64
    - I/Q Output, 264, 265
    - Pulse, 188
    - Source, 239
  - extension, file, 79
  - external
    - I and Q signals, 266
    - media, 85, 448
    - modulation source, 181
    - reference oscillator, using, 62
    - trigger source, 241, 243
    - triggering, 243
  - external clock source
    - selection, 325, 332
  - external leveling, 113 to 119
    - softkeys, 113
  - external leveling,
    - configuring, 116
  - External softkeys
    - External, 264
    - Input, 267
    - Input I Offset, 200
    - Input Q Offset, 200
    - Output, 267
- F
  - factory defaults, restoring, 44, 48, 268
  - Fading, 374
  - Fading, Baseband Generator
    - with Real-Time Capability
      - Option 660, 373
  - features, 18
  - feedthrough, 200
  - feedthrough, carrier,
    - minimizing, 433
  - File hardkey, 75, 84
  - file headers
    - creating, 215
    - editing, 217
    - example, 218
    - viewing a different file, 219
  - files

- catalog. See data storage
- extensions, 79
- working with, 74
- filter
  - equalization, 270
  - real-time modulation
    - softkey location, 281
  - user, equalization, 270
- filter, interpolator, 254
- filtered & unfiltered
  - samples, 322, 335
- filters
  - finite impulse response, 272, 412
  - FIR, 272, 412
  - gaussian, loading
    - default, 278, 419
  - nyquist, selecting, 400
- filters Dual ARB, 272
- finite impulse response filters
  - using, 272, 412
- FIR filter
  - apodization settings, 278, 419
  - Hamming, 278, 419
  - Hann, 278, 419
  - Kaiser, 278, 419
  - window settings, 278, 419
- FIR filters
  - Arb Custom, 412
  - creating, 273, 412, 414
  - modifying, 278, 419
  - storing, 276, 417
  - using, 272, 412
- FIR table editor
  - accessing, 273, 414
  - Arb Custom, 419
  - coefficients, duplicating, 274, 416
  - coefficients, entering
    - values, 273, 414
  - coefficients, modifying, 279, 420
  - Dual ARB, 273, 278
  - files, loading, 278, 419
  - filters
    - creating, 273, 412, 414
    - modifying, 278, 419
    - storing, 276, 280, 417, 421
  - oversample ratio, setting, 275, 416
- firmware
  - upgrading, 47, 453
- First Mkr Point softkey, 226
- First Sample Point softkey, 226
- Fixed softkey, 97, 120
- flat bandwidth, 366
- flatness correction. See user flatness correction
- Flatness softkey, 101
- FM
  - annunciator, 26
  - dc offset, removing, 181
  - external source, 181
  - hardkey, 177
  - softkeys, 177
- formula, skew discrete
  - steps, 313
- Free Run softkey, 64, 128, 238
- Free-Run softkey, 188
- Freq Dev softkey, 381, 385, 386, 387, 388, 389, 390, 393
- FREQ hardkey, 61, 63
- Freq softkeys, 101
- frequency
  - display area, 25
  - hardkey, 23, 24, 61, 63
  - LF output, 184
  - start and stop, swept-sine, 185
  - modulation, 177
  - multiplier, 126
  - offset, 124
  - offset, baseband, 259
  - offset, softkeys, 259
  - reference, 125
  - setting, 61, 63
  - softkeys, 61, 63
- frequency output limits, clock
  - rates & logic levels, 304
- frequency reference
  - common, 307
- hookup diagrams, 308
- frequency units, 61
- front panel
  - disabling keys, 455
  - display, N5181A, 25
  - display, N5182A, 25
  - display, N5183A, 25
  - I/Q inputs, using, 201
  - knob resolution, 44
  - overview, 21
  - tests, 450
- FSK softkey, 381, 385, 386, 387, 388, 389, 390, 393
- FTP Server softkey, 48
- fundamental operation See basic operation
- G
  - Gated softkey, 188, 238
- gated triggering, 239, 241
- Gaussian
  - definition, 460
- gaussian filter, loading
  - default, 278, 419
- Gaussian. See AWGN
- glossary, 459
- Go To Default Path softkey, 75, 77, 85
- Goto Row softkey, 67, 75
- GPIB
  - connector, 30, 39
  - definition, 460
  - setup, 47
  - softkeys
    - Address, 47
    - Setup, 47
- green LED, 24
- GSM softkey, 380, 384
- guides, content of, 15
- H
  - hardkeys
    - help on, 58
    - overview, 21
    - See also specific key
  - header utilities softkeys, 215
  - Help hardkey, 22, 58
  - Hostname softkey, 48
  - hostname, setting, 48
  - HP 3300A, emulating, 130
- I
  - I connector, 23
  - I Offset softkey, 267
  - I OUT connector, 31
  - I/O Config softkey, 41
  - I/Q
    - adjustments, 200, 267
    - front panel inputs, using, 201, 266
    - Int Equalization Filter
      - softkeys location, 271
    - modulation, 200, 263
    - optimizing, 265
    - rear panel outputs, 31
    - rear panel outputs, using, 265
    - signal path, optimizing, 265
    - signal, aligning, 222
    - softkey, 271
    - softkeys, 200, 264 to 269
    - waveform, clipping, 244
- ideal low-pass filter. See rectangular filter

- IF, 460
- ILS Glide Slope 334.70 MHz w/ 90 Hz AM (Up), 150 Hz AM (Down) @ 40%, 148, 160
- ILS Glide Slope Softkey Menus, 161
- ILS Localizer 108.10 MHz w/ 90 Hz AM (Left), 150 Hz AM (Right) @ 20%, 148, 160
- ILS Localizer Softkey Menus, 149
- ILS Marker Beacon Softkey Menus, 171
- ILS Marker Beacons 75 MHz w/ Inner 4000 kHz, Middle 1300 Hz, Outer 400 Hz, 148, 160
- images, 200
- impairments
  - I/Q adjustments, 200
- impairments, real-time phase noise, 367
- Import Waveform softkey, 234
- improve non-harmonics, 61
- Incr Set hardkey, 24
- information, removing from memory, 455
- Insert softkeys
  - Insert, 210
  - Item, 67
  - Row, 67
  - Waveform, 210
  - Waveform Sequence Contents, 210
- Install Assembly softkey, 55
- Install licenses softkey, 79
- installation guide content, 15
- instrument
  - firmware, upgrading, 47
  - softkeys
    - Adjustments, 41
    - Info, 41
    - Options, 54
  - state
    - associating with waveform, 82
    - files, 80, 84
    - register. See data storage
    - softkey, 80
- Int Equalization Filter softkeys, 271
- int media, 460
- Int Phase Polarity softkey, 264
- interface
  - GPIB, 47
  - LAN, 48
  - internal
    - reference oscillator, using, 46
  - Internal Baseband Adjustments softkey, 267
  - internal clock source selection, 325, 332
  - internal media, 85
  - Internal Storage to USB softkey, 80
  - Internal/USB Storage Selection softkey, 75
  - interpolator filter, 254
  - IP
    - Address softkey, 48
    - address, setting, 48
    - auto, 48
    - definition, 460
  - IQ
    - clock rates, 306
  - IQ map, QAM modulation, 422
- J
  - jitter on EVENT output, 236
- K
  - keyboard, using, 130
  - keys
    - definition, 460
    - disabling, 455
    - front panel, 21
    - help on, 58
    - numeric, 21
    - test, 450
    - See also specific key
  - Keysight MXG
    - modes of operation, 19
  - Keysight sales and service offices, 453
  - knob, 24, 44, 59
- L
  - L annunciator, 26
  - LAN
    - connector, 30, 39
    - definition, 460
    - Services Setup softkey, 47
    - setup, 48
    - Setup softkey, 47
  - Last Mkr Point softkey, 226
  - Last softkey, 44
  - LEDs, 24
  - blink test, 450
  - front panel, 24
  - modulation, 72
  - leveling
    - external, 113 to 119
    - turn off ALC, 120
  - LF Out, 183
  - LF output
    - amplitude, 184, 185
    - configuration example, 184, 185
    - description, 183
    - frequency, 184
    - source
      - function generator, 185
      - internal modulation monitor, 184
    - swept-sine
      - start frequency, 185
      - stop frequency, 185
    - waveform, 178, 183, 185
  - LFO. See LF output
  - licenses
    - manager, 53
    - service software, 53
    - signal studio, 53
    - time-based, 45
    - troubleshooting, 452
    - viewing, 53
    - waveform, 53
  - limits, clock & sample rates, logic outputs, 304
  - line power (green) LED, 24
  - linear sweep, 65
  - list mode values, 68
  - List softkey, 75
  - list sweep
    - parameters, 68
    - status information, 68
    - troubleshooting, 447
    - using, 67
    - waveform, 69
  - listener mode annunciator, 26
  - LO, 460
  - Load From Selected File softkey, 78, 79
  - Load List softkey, 79
  - Load softkeys
    - All From Int Media, 207
    - All From USB Media, 207
    - Cal Array From Step Array, 101
    - From Selected File, 78, 79
    - Load/Store, 67, 78, 79
    - Segment From Int Media, 207

- Segment From USB
  - Media, 207
  - Store, 207
  - Sweep List, 79
- Load/Store softkey, 67, 78, 79
- Local hardkey, 22
- lock up, troubleshooting, 442
- logarithmic sweep, 65
- logic type
  - output levels, 304
  - selecting, 319
- low frequency output. *See* LF output
- low spurs, 61
- LVDS compatibility with the PXB, 19
- LXI, 460

## M

- manual control, sweep, 71
- Manual softkey, 97, 120
- Manual softkeys
  - Config Settings, 48
  - Manual, 48
  - Mode, 64
  - Point, 64
- manuals, content of, 15
- Marker softkeys, 226
- markers, aligning signal, 222
- markers, waveform, 221 to 236
- media
  - BBG, 459
  - erasing, 455
  - Flash Drive, 85
  - int, 460
  - storage, 85
  - types, 205, 455
  - USB, 85, 448
- memory
  - erasing data from, 455
  - See also* media
- menu keys, 22
- messages, error, 449
- messages, warning
  - Opt 25x Licensing, 301
- mirror table, duplicating
  - coefficients, 274, 416
- mixer, troubleshooting signal loss, 445
- Mod On/Off hardkey, 23, 72
- Mod On/Off, Option UNT, 177
- Mod Type Softkeys, 381, 385, 386, 387, 388, 389, 390, 393
- Mode hardkey, 206, 361, 362, 363, 364, 366, 368

- Mode key, 374
- mode, modulation, 460
- modes of operation, 19
- Modulated softkey, 97, 120
- modulation
  - AM, 177
  - analog, 19
    - configuring, 178, 183
  - annunciators, 26
  - carrier signal, 72
  - digital, 20
  - external source, using, 181
  - FM, 177
  - generating, 72
  - I/Q, 200, 263
  - phase, 177
  - pulse, 19, 187
  - real-time filter, softkeys, 281
  - simultaneous, 73
  - troubleshooting, 443
- Modulator Atten softkey, 366
- module user interface
  - location, 318, 328
- monochrome display, setting, 43
- Monochrome softkey, 43
- MSK softkey, 381, 385, 386, 387, 388, 389, 390, 393
- MULT annunciator, 26
- multi-BBG sync, 283
  - configure setup, 286
  - equipment setup, 286
  - resynchronize, 288
  - system delay, 284
  - system sync, 285
  - trigger setup, 285
- multicarrier setup
  - APCO 25 w/C4FM, 409
  - APCO 25 w/CQPSK, 409
  - Bluetooth, 409
  - CDPD, 409
  - DECT, 409
  - Default, 409
  - EDGE, 409
  - GSM, 409
  - NADC, 409
  - PDC, 409
  - PHS, 409
  - PWT, 409
  - TETRA, 409
- multicarrier setup softkeys, 409
- multicarrier TDMA waveforms
  - creating, 409

- multicarrier, Default softkey. *See* quick setup, Default softkey, settings
- multiplier, using, 126
- multitone, 378, 436 to 439
- multitone mode, 20
- Multitone softkeys, 436
- multitone waveform, setup, 430

## N

- N5102A
  - baseband data, 318
  - clock rates, 304
  - clock settings, 323, 330
  - clock source
    - description, 306
  - clock timing, 304, 309
  - common frequency
    - reference, 307
  - connections to clock and device, 315
  - data parameters, setting, 320, 334
  - data types, 317
  - digital data, 336
  - digital signal interface
    - module, 303
  - frequency reference
    - connector, 307
  - generating data, 327
  - input direction, 329
  - input mode, 317, 328
  - interleaving clock timing, 311
  - logic type, port
    - configuration, 329
  - logic types, 319
  - Option 003 or 004, 337
  - output direction, 320
  - output mode, 317, 318
  - phase and skew clock timing, 313
  - serial clock timing, 312
  - user interface, 318
  - user interface module, 328
- N5180430B, option
  - multitone mode, 436
  - two-tone, 431
  - two-tone mode, 431
- NADC softkey, 380, 384
- Name And Store softkey, 234
- negation description, 323, 336
- Next REG softkey, 130
- Next SEQ softkey, 130
- No action softkey, 79

- No Retrigger softkey, 238
- noise, 359
- noise bandwidth factor, 360
- Noise Bandwidth softkey, 361
- Noise Mux softkeys, 363, 364
- Noise softkey, 361, 363, 364
- non-harmonics, 61
- non-volatile memory, 205
- non-volatile, definition, 460
- number keys, 59
- numeric format selection, 322, 336
- numeric keypad, 21
- nyquist filter
  - definition
- nyquist filter, selecting, 400
- O
- OFFS annunciator, 26
- offset, 200
- offset binary use, 322, 336
- offsets
  - baseband frequency, 259
  - I/Q, 267
  - output, using, 124
- on/off switch, 24
- operation
  - modes of, 19
- operation, basic, 57
- operation, remote, 47
- optimization, I/Q, 200, 264
- option
  - N5180430B
    - multitone mode, 436
    - two tone mode, 431
    - two-tone mode, 431
- Option U01, 109
  - internal channel correction, 109
- Option UNT
- Mod On/Off hardkey, 177
- Options
  - 003 or 004 Digital Signal Interface Module, 337
  - 660 Real-Time Fading, 374
  - 660 Upgrade Baseband Generator with Real-Time Capability, Fading, 373
  - N5180UN7B BERT, 337
- options
  - 651/652/654
    - description, 20
    - multitone mode, 436
    - two-tone mode, 431
  - enabling, 41, 53
  - resource, 19
  - UNT, 19
  - UNU, 19
  - UNW, 19
- Options 250-259, 294
- Options Info softkey, 54
- oscillator, external
  - reference, 62
- oscillator, internal
  - reference, 46
- Output Blanking softkey, 61, 63
- output levels, logic types, 304
- Output Mux softkeys, 361
- output, swept, 64
- over range error, DAC, 254, 261, 372
- overshoot, 254
- overview, signal generator, 17
- P
- Page Up hardkey, 22
- parallel
  - clock rates, 306
  - data clock timing, 309
  - interleaved data clock timing, 311
  - sample rates, 306
- parameters, saving a waveform's, 215
- path delay, 200
- PATT TRIG IN connector, 32
- Patt Trig In softkeys, 239
- PDC softkey, 380, 384
- peak-to-average power, reducing, 248
- performance, optimizing, 87
- persistent settings
  - definition, 461
  - resetting, 58
  - restoring defaults, 44
- phase clock timing, 313
- phase noise
  - adjustments, 371
  - DAC over range & scaling, 372
  - description & plots, 369
  - impairments, 367
  - softkeys, 368, 374
- Phase Ref Set softkey, 61, 63
- phase skew, 200
- PHS softkey, 380, 384
- pixel test, 450
- Plot CDDF softkey, 253
- PM Config
  - Calibrate Sensor, 103
  - Zero Sensor, 103
- PM Config softkeys
  - Connection Type, 103
  - PM VXI-11 Device Name, 103
  - Power Meter IP Address, 103
  - Power Meter IP Port, 103
- Point Trigger softkey, 64
- point-to-point time, 461
- polarity, external trigger, 239
- polarity, marker, setting, 233
- port configuration, selecting, 319
- power
  - meter, 100, 105
  - on, settings, 44
  - peak-to-average, reducing, 248
  - receptacle, 28, 37
  - search, 121
  - search automatic, 123
  - search settings, 123
  - sensor, models, 102, 103
  - setting, 61, 63
  - softkeys, 41, 44, 97, 120
  - supply, troubleshooting, 443
  - switch, 24
  - troubleshooting, 443
  - user settable, maximum, 63
- Power Control Mode
  - softkeys, 362
- power meter
  - configuration, 104
  - U2000 Series, 104
  - U2000A/01A/02A/04A, 104
  - dual display, 88
- power meter configuration softkeys. See PM Config softkeys
- power meter softkeys. See PM Config softkeys
- Power Search Reference softkey, 97, 120
- Power Search References, 121
- Power softkeys
  - On, 44
  - On/Preset, 41
  - Search, 97, 120
- power units, 61
- preferences, setting, 41
- pre-fir samples selection, 322, 335
- preset
  - hardkey location, 23
  - settings, 44

- troubleshooting, 448
- using, 58
- Preset softkeys
  - Language, 44
  - List, 67, 101
  - Preset, 44
- Prev REG softkey, 130
- Prev SEQ softkey, 130
- Proceed With Reconfiguration softkey, 48
- programming guide
  - content, 15
- protection, DAC over range
  - baseband offset
    - frequency, 261
  - phase noise impairment, 372
- PSK softkey, 381, 385, 386, 387, 388, 389, 390, 393
- pulse
  - annunciator, 26
  - characteristics, 189
  - connector, 29, 38
  - marker, viewing, 230
  - modulation, 187
  - narrow, 120
  - sync signal, 65
  - video signal, 65
- Pulse hardkey, 188
- pulse modulation, 19
- Pulse softkeys, 65, 188
- Pulse/RF Blank softkey, 226
- PWT softkey, 380, 384
  
- Q**
- Q connector, 24
- Q Offset softkey, 267
- QAM modulation IQ map, 422
- QAM softkey, 381, 385, 386, 387, 388, 389, 390, 393
- quadrature adjustment, 267
- quadrature angle, 200
- Quadrature Angle Adjustment softkey, 200, 267
- queue, error, 86
- quick setup
  - Default softkey
    - settings, 380, 384
- Quick Setup Softkeys, 380, 384
  
- R**
- R annunciator, 26
- raised cosine filter. *See* nyquist filter
- real time, 293, 378
- real-time
  - AWGN
    - softkeys, 361, 362, 363, 364
  - I/Q Baseband AWGN
    - softkeys, 366
  - modulation filter, 281
  - modulation filter, setting, 281
  - noise, 360
  - phase noise, 367
    - adjustments, 371
  - DAC over range & scaling, 372
  - description & plots, 369
  - impairments, 367
    - softkeys, 368, 374
- real-time AWGN, bandwidth ratio, 366
- real-time AWGN, channel bandwidth, 366
- real-time AWGN, flat bandwidth, 366
- Real-Time Fading Option 660, 374
- real-time modulation
  - Dual ARB, 281
- real-time modulation filter softkey, 281
- rear panel
  - I/Q outputs, 265
  - overview
    - n5161a, 28, 37
    - n5162a, 28, 37
    - n5181a, 28, 37
    - n5182a, 28, 37
- Recall hardkey, 81
- Recall keys
  - hardkey, 130
  - Instrument State, 75, 79
  - Reg, 130
  - State, 79
- recall register,
  - troubleshooting, 447
- receiver test, 378
- rectangular clipping, 249, 252
- rectangular filter
  - definition, 461
- REF annunciator, 26
- REF IN connector, 29, 38
- Ref Oscillator Ext Bandwidth key, 62
- Ref Oscillator Ext Freq key, 62
- Ref Oscillator Source softkey, 61, 63
- Ref Oscillator Tune key, 46
- reference oscillator tune,
  - internal, 46
- reference oscillator,
  - external, 62
- reference, using, 125
- references, content of, 15
- regrowth, spectral, 247
- remote interface, emulate HP 3300A, 130
- Remote Language softkey, 47, 49, 51
- remote operation
  - annunciator, 26
- remote operation preferences, 47
- Remove Assembly softkey, 55
- Rename File softkey, 75
- Rename Segment softkey, 207
- repeat measurements, 350
- Reset & Run softkey, 238
- Restart on Trig softkey, 238
- Restore softkeys
  - LAN Settings to Default Values, 48
  - System Settings to Default Values, 44
- resynchronize,
  - multi-BBGs, 288
- Return hardkey, 24
- Reverse Power Protection softkey, 44
- Revert to Default Cal Settings softkey, 268
- RF**
  - blanking
    - marker function, 232
    - settings, saving, 222
  - hardkey, 23
  - output
    - configuring, 62
    - connector, 23
    - leveling, external, 113 to 119
    - troubleshooting, 443
- RF During Power Search softkey, 97, 120
- RF Output softkey, 264, 265
- RFC NETBIOS Naming softkey, 48
- ringing, 254
- ripple, 254
- RMS, 461
- RMS softkey, 97, 120

- Rohde & Schwarz softkey, 49, 51
- root, 461
- root cosine filter. *See* root nyquist filter
- root mean square, 461
- Root Nyquist Filter
  - definition, 461
- root nyquist filter
  - definition, 461
- rotary knob, 59
- Route Connectors softkey, 64, 188
- Route To softkeys, 65, 188
- routing
  - I/Q, 200, 264
  - marker
    - ALC hold, 223
    - RF blanking, 232
    - saving settings, 222
- RPG test, 450
- runtime scaling, 256
  
- S
- S annunciator, 26
- sales, Keysight offices, 453
- sample
  - rates, 304
    - parallel/parallel intrlvd port configuration, 306
    - serial port configuration, 305
  - type selection, 322, 335
- sample rate clock, 33
- sample rate softkey, 236
- Save hardkey, 81
- SAVE Seq Reg softkey, 81
- Save Setup To Header softkey, 215
- Scale Waveform Data softkey, 253
- scaling softkeys, 253
- SCPI
  - enabling, 48
  - reference content, 15
  - softkey, 49, 51
- screen saver settings, 43
- Screen Saver softkey, 43
- search, power, 121
- secure display, 455
- security, 455
- Security softkey, 75
- Segment Advance softkey, 238
- segment advance triggering, 239
- segments
  - advance triggering, 240
  - file headers, 215
  - loading, 207
  - softkeys, 207
  - storing, loading, & playing, 207
- Select hardkey, 59
- Select Seq softkey, 130
- Select softkeys
  - Color Palette, 43
  - Different Header, 215, 219
  - Header, 215
  - Internal File(s) to Copy to USB, 80
  - Reg, 81
  - Seq, 81
  - Waveform, 67
- self test, 450
- Sequence softkey, 75, 215
- sequences
  - editing, 212
  - file headers, 215
  - marker control, 233
  - playing, 213
  - waveform, 210
- serial
  - clock and sample rates, 305
  - clock timing, 312
- serial data, synchronizing, 33
- server, enabling, 48
- service
  - guide content, 15
  - Keysight offices, 453
  - request annunciator, 26
- Set Marker softkeys, 226
- settings, persistent, 461
- settings, phase noise, 371
- Show softkeys
  - Alpha Table, 59
  - Waveform Sequence, 210
  - Waveform Sequence Contents, 210, 234
- signal generator
  - modes, 19
- Signal Studio, 19
- signal studio licenses, 53
- sinewave, 461
- Single softkey, 238
- Single Sweep softkey, 64
- skew
  - clock timing, 313
  - range, 313
- skew, I/Q, 267
- Sockets SCPI softkey, 48
- sockets, enabling, 48
- Softkeys, 132
- softkeys
  - definition of, 461
  - help on, 58
  - label area, 27
  - location, 21
  - See also* specific key
- source settled signal, 65
- Source Settled softkey, 65, 188
- Span softkey, 97, 120
- special pattern ignore function, 349
- Specify Default Storage Path for User Media softkey, 75
- spectral regrowth, 247
- spectrum analyzer, troubleshooting signal loss, 444
- square root raised cosine filter. *See* root nyquist filter
- Square softkey, 188
- standard, modulation, 460
- standby (yellow) LED, 24
- State softkey, 75
- states, persistent, 461
- step array (user flatness), 106
  - See also* user flatness correction
- Step Dwell softkey, 65, 128
- Step Spacing softkey, 65
- step sweep
  - spacing, 65
  - troubleshooting, 447
  - using, 65
- Step/Knob Ratio softkey, 44
- Storage Type softkey, 77, 85
- Store Custom Dig Mod State softkey, 382
- Store To File softkey, 78, 79
- Stored Segments softkey, 75, 215
- Subnet Mask softkey, 48
- Sum softkey, 264
- sweep
  - annunciator, 26
  - hardkey, 64
  - linear, 65
  - list parameters, 68
  - list status information, 68
  - logarithmic, 65
  - manual control, 71



- mode, 19
- out connector, 29, 38, 65
- out signal, 65
- softkeys, 64 to 71, 188
- step, 65
- troubleshooting, 447
- waveform, including, 69
- SWEEP hardkey, 64
- Sweep softkeys, 64 to 71, 80, 188
- swept output, 64
- switch, power, 24
- SWMAN annunciator, 26
- synchronization, 349, 350
- synchronize multi-BBGs, 283
  - configure setup, 286
  - equipment setup, 286
  - resynchronize, 288
  - system delay, 284
  - system sync, 285
  - trigger setup, 285
- system defaults, restoring, 44

## T

- T annunciator, 26
- talker mode annunciator, 26
- TCP, 461
- TCP Keep Alive softkeys, 48
- TDMA
  - custom digital modulation, predefined, 397
- TDMA digital modulation, 397
- terminator, 461
- test, self, 450
- test, self-web-enabled, 450
- tests, front panel, 450
- TETRA softkey, 380, 384
- text area (on display), 27
- text entry softkeys, 207
- time, dwell, 459
- time, setting, 45
- time/date reference point, 45
- Time/Date softkey, 45
- time-based license, 45, 452
- Timer Trigger softkey, 64, 128
- Toggle softkeys, 234
- Total Noise softkey, 362
- Total softkey, 362
- Trig
  - in connector, 29, 38
  - out connector, 65
  - out signal, 65
- trigger
  - connectors, 29, 38
  - hardkey, 22
  - initiating, 22

- multiple BBG sync, 285
- Trigger setup softkeys, 129
- Trigger softkeys
  - & Run, 238
  - Doublet, 188
  - Key, 64
  - Out Polarity, 64
  - Source, 237
  - Triggered, 188
  - Type, 237
- Triggered softkey, 188
- triggering
  - gated, 239, 241
  - multiple BBG sync, 285
  - equipment setup, 286
  - segment advance, 239
  - softkeys, 237
  - waveforms, 237
- troubleshooting, 441
- two tone, 378, 431 to 435
- two tone softkeys, 431
- two-tone softkeys, 431
- two-tone waveform, setup, 430
- type, modulation, 460

## U

- unfiltered & filtered
  - samples, 322, 335
- UNLEVEL annunciator, 26
- unleveled operation, 120
- UNLOCK annunciator, 26
- Unspecified softkey, 215
- UNT, option, 19
- UNU, option, 19
- UNW, option, 19
- Up Directory softkey, 75, 77, 80
- Update in Remote softkey, 43
- urls, 19, 47, 53, 453
- USB
  - connecting media, 85
  - definition, 461
  - device connector, 30, 39
  - host connector, 21, 30, 39
  - keyboard, using, 130
  - softkeys
    - File Manager, 75, 76
    - Keyboard Control, 130
  - to BBG Memory softkey, 80
  - to Internal Storage
    - softkey, 80
  - troubleshooting, 448
- Use softkeys
  - As, 79
  - Current Directory As Default Path, 75, 85

- Only Internal Storage, 75
- Only USB Media, 75
- user
  - documentation content, 15
  - files, backup and restore, 74
  - flatness correction, 100
  - preset, 58
  - preset, troubleshooting, 448
- user files
  - modifying, 389
- user files, data, 387, 389
- user FIR
  - definition, 462
- user interface location, module, 318, 328
- User softkeys
  - Configure Power Meter, 101
  - Current Directory As Default Path, 77
  - Do Cal, 101
  - Flatness, 61, 63, 75
  - Flatness Correction, 101
  - Flatness Corrections, 80
  - Span, 97, 120
  - User, 44
- user-defined FIR
  - Dual ARB, 273
- Utility hardkey, 41
- Utility softkey, 55

## V

- vector operation, 203, 294
- Using VOR, 132
- View Next Error Page
  - softkey, 86
- View Previous Error Page
  - softkey, 86
- volatile memory, 205, 207
- volatile, definition, 462
- VOR mode, producing a full or partial VOR signal, 134, 338, 339, 340
- VOR Softkey Menus, 133
- VOR Transmitter Antenna Pattern, 132, 136
- VXI-11, enabling, 48
- VXT-11 SCPI softkey, 48

## W

- warranted logic output clock
  - rates, 304
- waveform
  - adding custom modulation, 397

- Waveform license, Opt 25x
    - adding a waveform, 296
    - backup warning, 301
    - file missing warning, 301
    - license status messages, 297
    - licensing, installing, 294
    - licensing, understanding, 294
    - licensing, warning
      - messages, 301
    - lock warning, 301
    - replacing a waveform, 296
    - status messages, 298
    - using, 294
    - waveform licensing
      - softkeys, 296
  - Waveform softkeys
    - Licenses, 54
    - Runtime Scaling, 253
    - Segments, 207
    - Sequences, 210, 234
    - Utilities, 253
    - Waveform, 64, 67
  - waveforms
    - clipping, 244
    - file headers, 215
    - from digital baseband
      - waveform, 254
    - in a sweep, 69
    - license, 53
    - markers, 221, 222
    - multiple BBG
      - synchronization, 283
    - multitone, 436 to 439
    - overview, 205
    - saving instrument state, 82
    - scaling, 253
    - segment softkeys, 207
    - sequence, 210
    - storing, loading, & playing, 207
    - triggering, 237
    - two-tone, 431 to 435
  - Web Server softkey, 48
  - wideband AM, 182
  - window settings, FIR filter, 278, 419
  - WINIT annunciator, 26
- Y
- yellow LED, 24
- Z
- Zoom softkeys, 226



This information is subject to change without notice.

© Keysight Technologies 2012-2019

Edition 1, February 2019

N5180-90056

[www.keysight.com](http://www.keysight.com)