

User's Guide

P-Series Power Meters

Compatibility with the 8480 and E-series sensors will be available in a future Firmware release.

N1911A and N1912A



Agilent Technologies

Manufacturing Part Number: N1912-90002

Printed in UK

February 2005

© Copyright Agilent Technologies UK Limited 2005

Notices

No part of this manual may be reproduced in any form or by any means (including electronic storage and retrieval or translation into a foreign language) without prior agreement and written consent from Agilent Technologies, Inc. as governed by United States and international copyright laws.

Station Road, South Queensferry, Scotland, EH30 9TG, UK.

General Warranty

The material contained in this document is provided “as is,” and is subject to being changed, without notice, in future editions. Further, to the maximum extent permitted by applicable law, Agilent disclaims all warranties, either express or implied with regard to this manual and any information contained herein, including but not limited to the implied warranties of merchantability and fitness for a particular purpose. Agilent shall not be liable for errors or for incidental or consequential damages in connection with the furnishing, use, or performance of this document or any information contained herein. Should Agilent and the user have a separate written agreement with warranty terms covering the material in this document that conflict with these terms, the warranty terms in the separate agreement will control.

Restricted Rights Legend

If software is for use in the performance of a U.S. Government prime contract or subcontract, Software is delivered and licensed as “Commercial computer software” as defined in DFAR 252.227-7014 (June 1995), or as a “commercial item” as defined in FAR 2.101(a) or as “Restricted computer software” as defined in FAR 52.227-19 (June 1987) or any equivalent agency regulation or contract clause. Use, duplication or disclosure of Software is subject to Agilent Technologies’ standard commercial license terms, and non-DOD Departments and Agencies of the U.S. Government will receive no greater than Restricted Rights as defined in FAR 52.227-19(c)(1-2) (June 1987). U.S. Government users will receive no greater than Limited Rights as defined in FAR 52.227-14 (June 1987) or DFAR 252.227-7015 (b)(2) (November 1995), as applicable in any technical data.

Certification

Agilent Technologies certifies that this product met its published specifications at the time of shipment from the factory. Agilent Technologies further certifies that its calibration measurements are traceable to the United States National Institute of Standards and Technology, to the extent allowed by the Institute's calibration facility, and to the calibration facilities of other International Standards Organization members.

Technology Licenses

The hardware and/or software described in this document are furnished under a license and may be used or copied only in accordance with the terms of such license.

Safety Symbols

The following symbols on the instrument and in the documentation indicate precautions which must be taken to maintain safe operation of the instrument.



The Instruction Documentation Symbol. The product is marked with this symbol when it is necessary for the user to refer to the instructions in the supplied documentation.



Alternating current (AC)



This symbol indicates the operating switch for 'Stand-by' mode. Note, the instrument is NOT isolated from the mains when the switch is pressed. To isolate the instrument, the mains coupler (mains input cord) should be removed from the power supply.

Safety Notices

This guide uses warnings and cautions to denote hazards

WARNING

A warning calls attention to a procedure, practice or the like, which, if not correctly performed or adhered to, could result in injury or loss of life. Do not proceed beyond a warning until the indicated conditions are fully understood and met.

CAUTION

A caution calls attention to a procedure, practice or the like which, if not correctly performed or adhered to, could result in damage to or the destruction of part or all of the equipment. Do not proceed beyond a caution until the indicated conditions are fully understood and met.

General Safety Information

The following general safety precautions must be observed during all phases of operation, service, and repair of this instrument. Failure to comply with these precautions or with specific warnings elsewhere in this manual violates safety standards of design, manufacture, and intended use of the instrument. Agilent Technologies assumes no liability for the customer's failure to comply with these requirements.

WARNING

This is a Safety Class I instrument (provided with a protective earthing ground, incorporated in the power cord). The mains plug shall only be inserted in a socket outlet provided with a protective earth contact. Any interruption of the protective conductor inside or outside of the instrument is likely to make the instrument dangerous. Intentional interruption is prohibited.

DO NOT operate the product in an explosive atmosphere or in the presence of flammable gasses or fumes.

DO NOT use repaired fuses or short-circuited fuseholders: For continued protection against fire, replace the line fuse(s) only with fuse(s) of the same voltage and current rating and type.

DO NOT perform procedures involving cover or shield removal unless you are qualified to do so: Operating personnel must not remove equipment covers or shields. Procedures involving the removal of covers and shields are for use by service-trained personnel only.

DO NOT service or adjust alone: Under certain conditions, dangerous voltages may exist even with the equipment switched off. To avoid dangerous electrical shock, service personnel must not attempt internal service or adjustment unless another person, capable of rendering first aid and resuscitation, is present.

DO NOT operate damaged equipment: Whenever it is possible that the safety protection features built into this product have been impaired, either through physical damage, excessive moisture, or any other reason, **REMOVE POWER** and do not use the product until safe operation can be verified by service-trained personnel. If necessary, return the product to a Agilent Technologies Sales and Service Office for service and repair to ensure the safety features are maintained.

DO NOT substitute parts or modify equipment: Because of the danger of introducing additional hazards, do not install substitute parts or perform any unauthorized modification to the product. Return the product to a Agilent Technologies Sales and Service Office for service and repair to ensure the safety features are maintained.

Welcome

Welcome to the P-series Power Meter User's Guide!

Together with the P-Series Wideband Power Sensors and E9320 Series Power Sensors, the P-series power meters can measure complex modulation formats such as TDMA, CDMA and W-CDMA. Pre-installed measurement setups for GSM900, EDGE, NADC, iDEN, Bluetooth, cdmaOne, W-CDMA, MCPA, Radar (pulse), 802.11a, 802.11b/g, 1xEV-DO, 1xEV-DV, TD-SCDMA, DVB and cdma2000 help reduce the time required to measure these common wireless communications formats.

Power measurements include peak, peak-to-average ratio and average power of RF and microwave signals. Extensive triggering features such as continuous and level are available for making time gated measurements. Time parameter measurements of pulse rise time, fall time, pulse width, time to positive occurrence and time to negative occurrence are also provided. These can be made manually or remotely over USB, LAN or GPIB.

In addition, the P-series power meters are compatible with E-series E9320, E-series E9300, E-series 4410, and 8480 series power sensors giving you additional choice for conventional, average power measurements.

Documentation Information

As shown in the Installation Guide, this guide is only part of the information supplied. The documentation consists of:

- The Installation Guide - Shows you how to check your power meter, switch it on and connect it to an Agilent power sensor.
- The User's Guide - This book, shows you how to operate your power meter from the front panel interface to make measurements using the Agilent E-series E9320, E-series E9300, E-series E4400, and 8480 series power sensors. You can find the User's Guide as Adobe Acrobat PDF (Portable Document Format) files on the supplied CD-ROM in English.
- The Programming Guide - Shows you how to operate your power meter using the remote interfaces. You can find the Programming Guide as an Adobe Acrobat PDF file on the supplied CD-ROM in English language only.

NOTE

The Programming Guide is supplied in English Language only.

What You'll Find in this Guide

This User's Guide shows you how to operate your P-Series Power Meter using the front panel interface to make measurements with the P-series, E-series E9320, E-series E9300, E-series 4410, and 8480 series power sensors.

Some P-series power meter features and capabilities depend on the type of power sensor connected. Other features are general and independent of the power sensor. This User's Guide is therefor divided into 3 main blocks.

- Chapters 1 and 2 show you the main P-series power meter functions. These functions are typically independent of the connected sensor type.
- Chapter 3 show you how to use the P-series power meters with P-series sensor.
- Chapters 4 and 4 describe general maintenance and specifications.

For remote programming information, refer to the *P-Series Power Meter Programming Guide*.

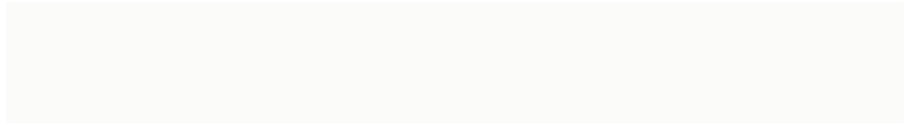

1. Introduction

What You'll Find In This Chapter	2
Power Meter and Sensor Capability	3
Conventions Used in this Guide	4
Front Panel Keys and Connections	5
The Display Layout	10
Window Symbols and Pop-ups.	18

2. General Power Meter Functions

What You'll Find in This Chapter	22
Setting the Units of Measurement	23
Setting the Measurement Frequency	25
Setting the Resolution	26
Making Relative Measurements	27
Setting Offsets	29
Procedure.	31
Selecting a Frequency Dependent Offset Table.	33
Procedure.	33
Editing Frequency Dependent Offset Tables.	35
Procedure.	35
Setting Measurement Averaging	38
Step Detection	40
Setting the Video Averaging	41
Setting the Video Bandwidth	43
Setting Measurement Channel Gates.	46
Setting up the Channel Trace	49
Setting the Trigger	52
Rising edge:	56
Falling edge:.	57
Setting Measurement Limits.	58
Procedure.	59
Setting the Measurement Display	61
Scaling the Analog Display	67
Recorder Output.	69
Saving and Recalling Power Meter States	72
Zeroing and Calibrating the P-Series Sensor	75
When to Zero?	75
Automatic Zero	75

Contents

Manual Zeroing	76
Automatic Calibrate	77
Manually Calibrate	77
Presetting the Power Meter	79

3. Using P-Series Power Sensor

What You'll Find In This Chapter	82
Introduction	83
Configuring a Power Measurement	84
Setting the Trace Display	85
Gate Control in a Single Enlarged Window	90
Viewing the Results in a Full Screen Window	94
Channel Setup	95
Trigger Setup	96
Measurement Setup	97
Display	97

4. Maintenance

What You'll Find in This Chapter	100
Self Test	101
Instrument Self Test	102
Fan	104
Calibrator	104
Display	104
Error Messages	105
Operator Maintenance	117
Contacting Agilent Technologies	119
Erasing Memory Data	122
Returning Your Power Meter for Service	123
Agilent Sales and Service Offices	125

5. Specifications and Characteristics

What You'll Find in This Chapter	128
Introduction	129
Warranted specifications	129
Characteristic specifications	129

Conditions	130
Measurement uncertainties	130
Power Meter Specifications	131
Measurement Characteristics	134
Rear Panel Inputs and Output Connections	137
1 mW Power Reference	138
Environmental Conditions	139
Physical Characteristics	140
Regulatory Information	141
System Specifications and Characteristics	142
Effect of Video Bandwidth Setting:	144
Effect of time-gating on measurement noise	144

Contents

Contents

1 Introduction

What You'll Find In This Chapter

This Chapter introduces you to the front panel and display of the P-series power meters.

It contains these sections:

- “Power Meter and Sensor Capability” on page 3.
- “Conventions Used in this Guide” on page 4.
- “Front Panel Keys and Connections” on page 5.
- “The Display Layout” on page 10.
- “Window Symbols and Pop-ups” on page 18.

Power Meter and Sensor Capability

Your P-Series power meter is compatible with Agilent P-series, E-series E9320, E-series E9300, E-series E4400, and the 8480 series power sensors. However, not all sensor and meter combinations have the same features or capabilities. The main differences are:

Features	P-Series N1920	E-Series E9320	E-Series E9300	E-Series E4400	8480 Series
Average Power of CW Signal	•	•	•	•	•
Average Power of modulated signal	•	•	•		•
Peak Power	•	•			
Cal Factors stored on EEPROM	•	•	•	•	
≥200 Readings/sec.	•	•	•	•	
Peak/Burst Average Power	•	•			
Time Gated Measurements	•	•			
Rising Edge Trigger	•	•			
Falling Edge Trigger	•	•			

NOTE The E-series and 8480 series power sensors require N1917A/B/C cables for connection to the P-series power meters.

Specifications

The specifications for the power meter are listed in Chapter 5, “Specifications and Characteristics,” on page 127.

Conventions Used in this Guide

The following conventions are used throughout this guide.





	<p>This symbol and text represents a labeled key on the power meter front panel.</p>
<p>Softkey</p>	<p>This symbol and text represents a labeled softkey and is used to indicate you should press the unmarked key beside the displayed text.</p>
<p>Message</p>	<p>This text represents a displayed message.</p>
<p>Parameter</p>	<p>This is used to represent a parameter, value, or title.</p>
<p>“Channel”</p>	<p>This User’s Guide describes the operation for both the single channel and the dual channel power meter. To identify channels on a dual channel meter a Channel softkey on an N1911A meter becomes Channel A and Channel B on N1912A.</p> <p>When you are asked to press “the channel” Softkey in a procedure, make sure you select the relevant channel.</p>

Front Panel Keys and Connections

This section briefly describes the functions of the front panel keys and connectors.



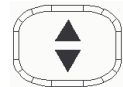





These keys are located to the left of the display.

Key	Function
	Press this key to preset the power-meter. An option list of pre-installed measurement configurations is presented. Select an option and press the confirm key.
	Press this key to control the power meter from the front panel when it is operating via the remote interfaces (when Local Lock Out is not enabled).
	Press this key to select the upper or lower measurement window. The selected window is highlighted by a blue line on the right side of the window. Any measurement setup you create is performed in the selected window.
	Press this key to choose windowed, expanded, or full-screen display of a numeric measurement. It also provides quick access to the Gate Control screen and menu when a trace window is selected.
	Press this key to switch the meter between on and standby. When power is supplied, the background LED is red. Pressing the key, switches the power meter on and the background LED is green.





These keys are located along the lower edge of the display.

Key	Function
 System	Press this key to access general configuration-menus, such as GPIB address. You can also access the Self-Test and Table entry menus. The measurement screen remains visible.
 Channel	Press this key to access the channel configuration menus. Channel parameters such as averaging and offsets are configured from this menu.
 Trig/Acq	Press this key to access the triggering menu. Unless a P-series or an E-series E9320A sensor is connected, all the menu keys are disabled (greyed out).
 Meas	Press this key to setup relative measurements or set display offsets. Use this key to configure the selected measurement.
 Disp	Press this key to access the measurement display menu. You can choose the displayed measurement resolution, units and display format. Use this key together with  Meas to configure measurement displays.



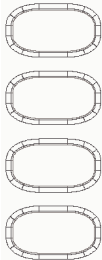



These keys are all associated with the menu labels and data entry. They are located to the right of the display.

Key	Function
	Press this key to return to the previous screen. This key also cancels pop-up entry.
	These unmarked keys are called 'softkeys' and are referred to by the text on the display next to them. For example, during a Preset, you are given an option to confirm the command. Press Confirm to continue, that is, press the softkey beside the displayed word 'confirm'.
	The lowest of the unmarked softkeys is used when there is a two page menu to be displayed. For example, a 1 of 2 is displayed beside the key indicating the first page of a two page menu. Press the key to access the next page or second page. (A 2 of 2 is displayed).

Introduction
Front Panel Keys and Connections



These keys and connectors are associated with the measurement channels and are located on the right-hand side of the front panel.

Key	Function
	The arrow keys are used for navigation around the parameter entry screens. The up and down arrows are used for selecting values from a pop-up list, they can also be used for stepping two values, X Scale and Y Scale. They are also used to enter text, for example, table names.
	Press this key to select a highlighted field to allow data entry, check a checkbox and terminate entry of a popup list.
	Press this key to access the zero and calibration menus.
	Press this key to start and stop the acquisition of the measurement.
	Press these keys to enter numeric values in the pop-up fields, for example, the offset values. To complete the entry use the softkey.

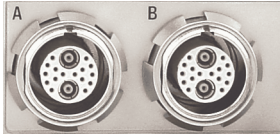
Connector	Function
 A close-up photograph of a silver-colored N-type connector. The connector has a central pin and a surrounding shield. The text "REF" is printed on the top left and "50 MHz" is printed on the top right of the connector's body.	<p>The power reference is a 1 mW (0 dBm) 50 MHz signal available from a 50 Ω type-N connector. It is used for calibrating an 8480 or E-Series power sensor and meter system. If the meter is configured with Option 003, the connector is fitted to the rear panel. The Green LED beside the connector is lit when the calibrator is turned on.</p>
 Two side-by-side photographs of circular sensor input connectors. The left one is labeled "A" and the right one is labeled "B". Both connectors have a central pin and a surrounding shield with multiple small holes around the perimeter.	<p>The sensor input connectors (N1912A shown, the N1911A has one input). If the meter is configured with Option 003, the connectors are fitted to the rear panel.</p>

The Display Layout

Figure 1-1 shows the display layout when two windows are configured in dual numeric mode.

Pressing , **Disp Type** the other display formats are available.

Figure 1-1

Dual Numeric Display

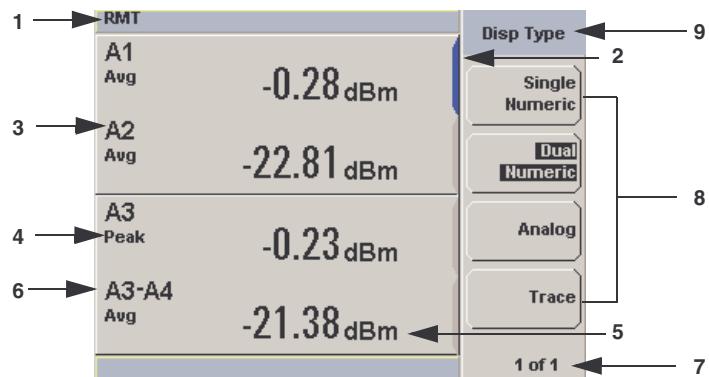

1. The status reporting line displays messages and the control status of the power meter. For example, the status can be either **RMT** (remote, GPIB, USB or LAN operation) or **LCL** (local, front panel operation).

The message fields indicate **ERR** for any error conditions that occur or informing you to **Please Zero** the power sensor.

2. The blue highlight on the right hand side of the window shows it is the currently selected measurement display line.

This measurement line is the Upper Window/Upper Measurement.

3. The measured channel is shown.

With a P-series or an E-series E9320 power sensor connected, and channel in trigger mode, the associated gate number is shown.

4. The associated measurement type is shown below the channel and gate number.

5. This displays the measurement units, either dBm, dB, Watts, or percent (%).

NOTE

With a P-series or an E-series E9320 power sensor connected, a measurement result of -270 dBm indicates the input power level is beyond the sensitivity of the sensor.





6. With a P-series or an E-series E9320 power sensor connected, you can make combined measurements with a single channel meter. A dual channel meter extends this feature across both channels.
7. This displays the number of pages in the current menu. For example, **1 of 2** indicates that there are two pages in the menu and the first page is currently displayed. Pressing the softkey displays the next page, indicated by **2 of 2**. (Press the softkey to display the previous menu page.)
8. The available softkey labels are displayed in these four fields. Additionally, settings associated with the labelled function are displayed under the label.
9. This field displays the menu title. For example, **Channel Setup** or press  and the **Zero/Cal** menu is displayed.

Figure 1-2 Single Numeric and Analog Display

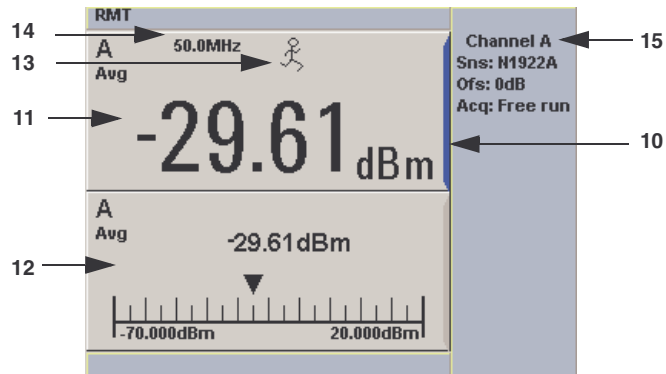

10. Figure 1-2 shows the default display mode of two measurement windows. The upper measurement window has a blue highlight on the right hand side of the window showing it has been selected.

Using the , , or  keys you can change the selection of the measurement window.

Using the  key on numeric measurement results window you can choose either two rectangular windows, a single enlarged window, or a full screen display by pressing. The display style is applied to the currently selected window or measurement line.





11. The upper window is configured to show a single numeric display.
12. The lower window is configured to show an analog meter which displays the measurement result and the meter scaling.
13. With a P-series or an E-series E9320 power sensor connected, the symbol shows the trigger state  (Free Run),  (Stopped),  (Negative Slope), or  (Positive Slope).
14. The channel measurement frequency.
15. This displays the connected sensor, the offset value, and the acquisition mode on the channel. On dual channel models it shows for both channels.

Figure 1-3 Full Screen Numeric Display



16. Figure 1-3 shows a single numeric full screen displaying a relative result.

This field displays **Rel** if relative mode is on.

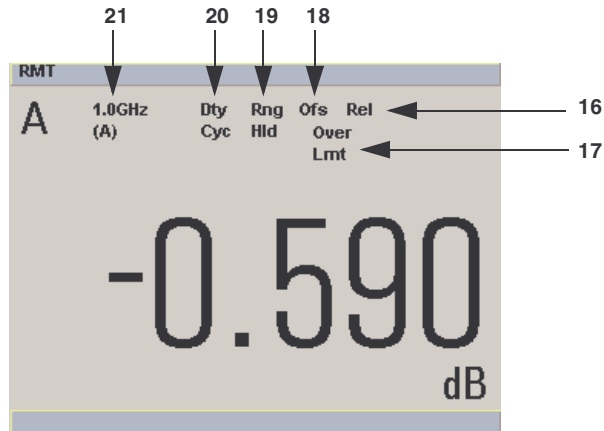
17. This field indicates the measurement result is beyond the configured upper or lower limit. If the measurement is within the limits this field is empty. If the measurement result is less than the minimum limit set, **Undr Lmt** is displayed. If the measurement result is more than the maximum limit set, **Over Lmt** is displayed.

18. This field displays **Ofs** if an offset is set.

19. This field displays **Rng Hld** if a range is selected.

20. This field displays **Dty Cyc** if a duty cycle is set.

21. The information in this field is displayed on two lines and depends on the sensor type, sensor calibration table, frequency dependent offset table currently selected, and the measurement frequency.

NOTE The following trace displays are only available when a P-series or an E-series E9320 power sensor is connected.

Figure 1-4 Trace Display in Both Windows



22. Figure 1-4 shows both windows configured to trace display mode. This is only available with an a P-series or an E-series E9320 power sensor is connected. The captured trace, channel, and scaling are displayed.

The upper window is the selected window.

23. The  indicates the point on the trace where trigger event occurs.

NOTE Single or continuous triggering (**Sing Trig** or **Cont Trig**) must be selected from the **Acqn** menu to view a trace window. The **Acqn** menu is accessed by pressing , **Trigger**.

Trace is disabled when **Free Run** is selected.

Figure 1-5 Trace Display in Single Enlarged Window in Markers Mode

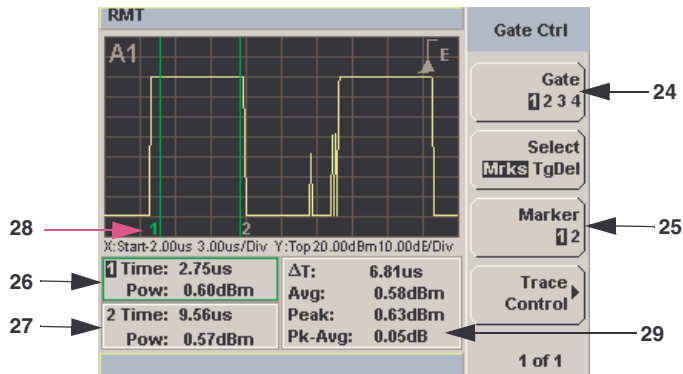

Figure 1-5 shows a single enlarged window with the **Gate Ctrl** menu and associated tables and markers. The Gate Control is the default display when using trace display.

- 24. Pressing **Gate** scrolls through the 4 gates available for each channel.
- 25. The markers, **1** and **2**, indicate the start and end points of the selected gate. Pressing **Marker** toggles between the two markers. You can use the **←** and **→** keys to move the active marker along the trace.
- 26. The highlighted table, with the green border, shows the time (**Time:**) and the instantaneous power level (**Pow:**) of the active marker at the configured point. A negative time value indicates a measurement before the trigger point.

NOTE

Gate timing parameters are all related to your chosen trigger point. This may be different from the timing of the triggering event if you have configured a trigger delay. Refer to item No 30 for more information.

- 27. This table shows the time (**Time:**) and the instantaneous power level (**Pow:**) of the inactive marker at the configured point.
- 28. The highlighted marker shows the active marker at the configured point.
- 29. This table shows the width of the gate **ΔT:** (time between the markers), the average, peak, and peak-to-average ratio power measurements within the active gate.

Figure 1-6 Trace Display in Single Enlarged Window in Trigger Delay Mode

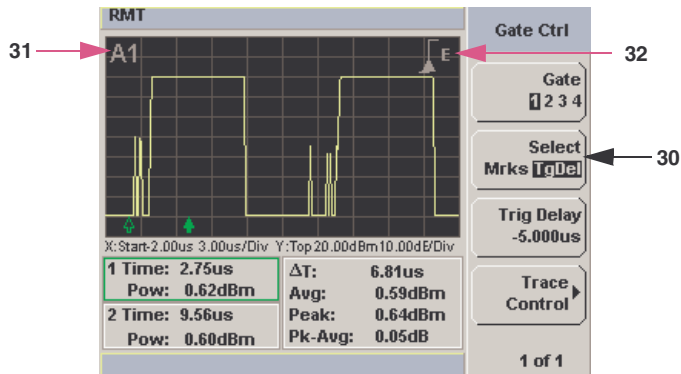

Figure 1-6 shows a single enlarged window with the **Gate Ctrl** menu and associated tables and trigger delay.

30. Pressing **Select TgDel** removes the gate markers and displays the trigger marker(s). The indicates when the trigger event occurs, whilst shows the delayed trigger point. When the two points coincide only the trigger is shown.

In the example shown in Figure 1-6, the appears ahead of the as a trigger delay of $-5.00 \mu\text{s}$ has been configured, placing the measurement trigger before the trigger event. You can configure the trigger delay by pressing and entering a numeric value.

To indicate an off-screen trigger event, is displayed. To indicate an off-screen trigger point, is displayed.

31. The selected channel and gate number is displayed.

32. The trigger setting and slope is displayed. In the example shown in Figure 1-6 these are External and a Positive Slope.

Figure 1-7 Trace Display in Single Enlarged Window in Trace Control Mode

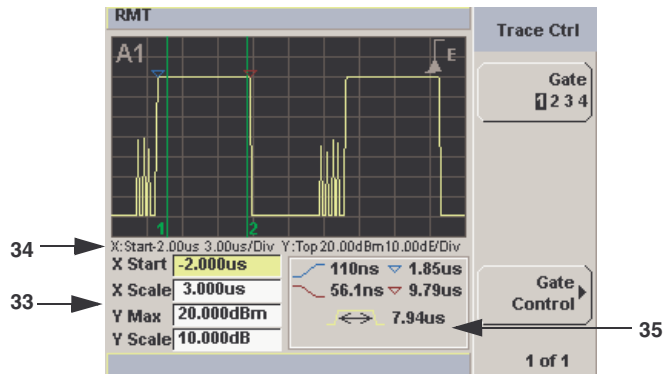

Figure 1-7 shows a single enlarged window with the **Trace Ctrl** menu with information on the pulse and associated X and Y control.

- 33. This is the X and Y trace setup fields. Using the or keys you can highlight the item and change its value.
- 34. The current settings of the X and Y scale are displayed in this reporting line.
- 35. This table shows 5 automatic time measurements performed on the first complete captured pulse after the trigger. The 5 measurements are rise time , fall time , time to positive occurrence , time to negative occurrence , and the pulse duration .

Window Symbols and Pop-ups

There are several different graphic symbols and pop up windows that can occur on the power meter display. These can occur for a variety of reasons, for example:

- an error or warning occurs.
- you are required to wait while the power meter carries out a procedure.
- you are required to select an entry from a list.
- you are required to enter a numeric value.

There are three different colors used to signify the pop-up status.

- Green - used to allow data entry.
- Orange - used to display information.
- Red - used to display an error.

Warning Symbol Pop-up

The warning symbol is displayed either in a pop up window or directly in the measurement window when such an event occurs. A pop up window is displayed for approximately two seconds. The text in the pop up window gives details of the warning type, for example, to indicate that a power sensor has insufficient bandwidth or a previous entered frequency value in a table. Depending on the severity of the warning, the pop-up may be displayed in Orange or Red.

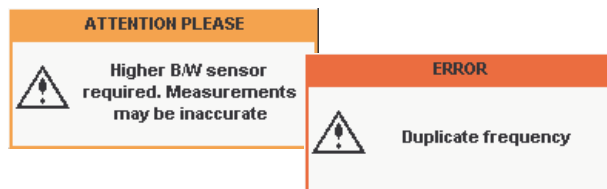

Wait Symbol Pop-up

The wait symbol is displayed when the power meter is carrying out a procedure and no action is required from you. The symbol appears in a pop up window. It may appear, for example, during a calibration.

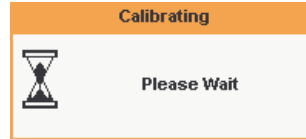

Confirm Symbol Pop-up

This type of pop up window is displayed when you are required to press **Confirm** to verify your previous selection. For example, prior to a Save being carried out.

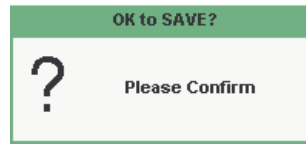

Numeric Entry Pop-up

This type of pop-up window is displayed when you need to modify numeric data. The numeric keys allow you to enter the value.

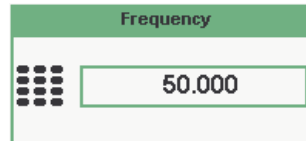

Text Entry Pop-up

This type of pop-up window is displayed when you need to modify alphanumeric data, for example, table names. The up/down arrow keys increment and decrement the alphanumeric digit that the cursor is currently positioned. The left/right arrow keys move the cursor to another alphanumeric digit.

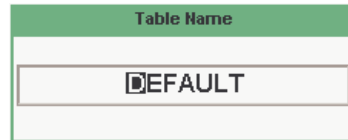

Trace Scaling Pop-up

This pop up window is displayed when you are in the Trace Control menu and you can either use the up/down arrow keys increment and decrement, or the numeric keys to set, the values of the X scale and Y scale.

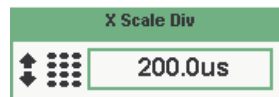

List Pop-up

This pop up window is displayed when you are required to select an entry from a list. Using the up/down arrow keys to highlight your choice. Press select to complete the entry.

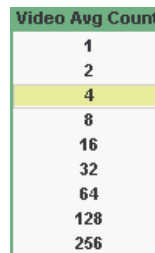

2

General Power Meter Functions

What You'll Find in This Chapter

This chapter describes the general operation of the P-series power meters. It contains the following sections:

- Setting the Units of Measurement on page 23.
- Setting the Measurement Frequency on page 25.
- Setting the Resolution on page 26.
- Making Relative Measurements on page 27.
- Setting Offsets on page 29.
- Setting Measurement Averaging on page 38.
- Step Detection on page 40.
- Setting the Video Averaging on page 41.
- Setting the Video Bandwidth on page 43.
- Setting Measurement Limits on page 58.
- Setting Measurement Channel Gates on page 46.
- Setting up the Channel Trace on page 49.
- Setting the Measurement Display on page 61.
- Scaling the Analog Display on page 67.
- Recorder Output on page 69.
- Saving and Recalling Power Meter States on page 72.
- Zeroing and Calibrating the P-Series Sensor on page 75.
- Presetting the Power Meter on page 79.

Setting the Units of Measurement

The Units menu is used to select the measurement units for the currently selected window. These can either be logarithmic (dBm or dB)

or linear (Watt or%) units. Presetting () the power meter sets the measurement units to dBm (logarithmic units). Table 2-1 and Table 2-2 show the units applicable to each measurement mode.

Press  , **Units** . Select the unit of measurement from **dBm** , **W** , **dB** , and **%** . Softkeys which cannot be selected in your particular mode of operation are grayed out.

NOTE

When the measurement unit is set to Watt, it is possible that negative power results are displayed when measuring low power levels.

Table 2-1 Measurement Units - Single Channel Meters

Measurement Mode	Relative Mode Off	Relative Mode On
Log	dBm	dB
Linear	Watt	%

Table 2-2 Measurement Units - Dual Channel Meters

Measurement Mode	Relative Mode Off	Relative Mode On
Ratio	Log	dB
	Linear	%
Difference	Log	dBm
	Linear	Watt

Selecting Units of Measurement from the Softkeys

In some menus, for example, Units in the Trace Setup menu, you are required to enter the units of measurement for power. In some cases, due to the wide power range available, the following menu is displayed:

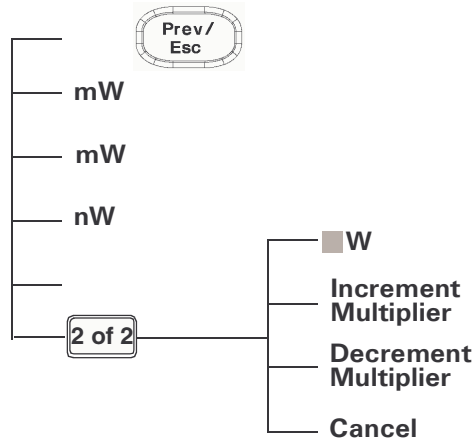

Pressing **Increment Multiplier** or **Decrement Multiplier** increases or decreases the multiplier shown in front of **W**. Pressing **W** after the correct multiplier has been selected confirms the entry.

NOTE Invalid softkeys are grayed out so the value cannot be entered.

Setting the Measurement Frequency

Entering the frequency of the RF signal you are measuring optimizes the accuracy and minimizes measurement uncertainty, especially when making comparative measurements between signals.

Procedure

Set the measurement frequency as follows:







1. Press . On dual channel meters select the required channel.
2. Use the  and  keys to highlight the Frequency value field and press  to display the Frequency pop-up. Use the numeric keypad to enter the required value in the Frequency pop-up window.

Figure 2-1 Frequency Pop-up

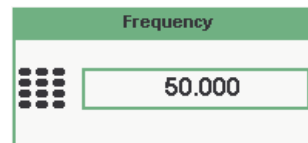

3. Confirm your choice by pressing **MHz** or **GHz**.
4. Press  key to close the Channel Setup screen.

Setting the Resolution

The resolution of each of the power meter's numeric type windows can be set to four different levels (1, 2, 3 or 4).

These four levels represent:

- 1, 0.1, 0.01, 0.001 dB respectively if the measurement suffix is dBm or dB.
- 1, 2, 3 or 4 significant digits respectively if the measurement suffix is W or %.

The default value is 0.01 dB (3 digits).

To set the resolution on the currently selected window:

1. Press . The current setting of the resolution is highlighted under the **Resolution** softkey.
2. To change this setting press **Resolution** repeatedly, until the required resolution setting is highlighted.

Making Relative Measurements

Relative mode enables comparison of a measurement result to a reference value. The relative reading, or difference, can be displayed in either dB or % terms. When the measurement result is displayed in % a prefix multiplier may be shown.

Procedure





1. Press  to display the Measurement Setup menu.
 Figure 2-2 shows a Measurement Setup display and the relative measurement items labeled.
2. Select the window you want to set a reference value on by pressing the **Meas Select** key.
 The currently selected window/measurement is displayed.
3. Use the  and  keys to highlight the Relative setting field.



Figure 2-2 Typical Relative Measurement Display

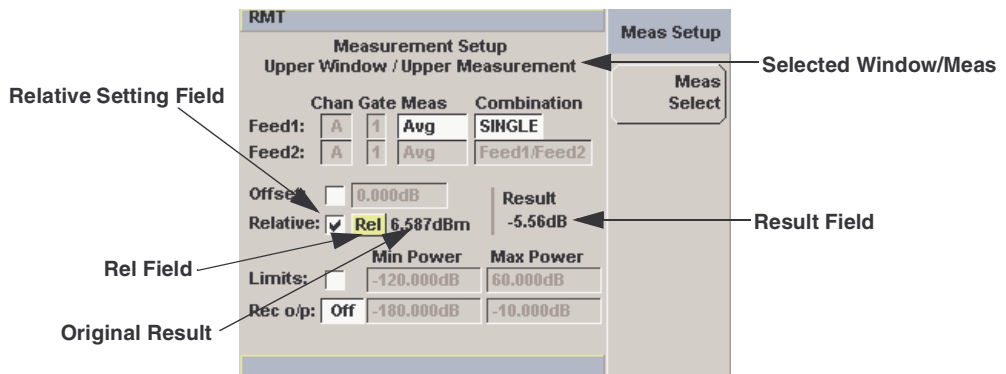

4. Press  to check the Relative setting field.
5. Confirm the power meter is measuring the signal you want to use as the reference.
 This is displayed under the **Result** field.

General Power Meter Functions

Making Relative Measurements

6. Press the , , key to highlight the **Rel** field.
7. Press  and the original result value now appears to the right hand side of the **Rel** check field.
8. As the measured signal varies the relative value displayed under **Result** field varies.

NOTE

If you return the power meter to display the numeric display there is a **Rel** symbol displayed in the window of the measurement it is applied to.

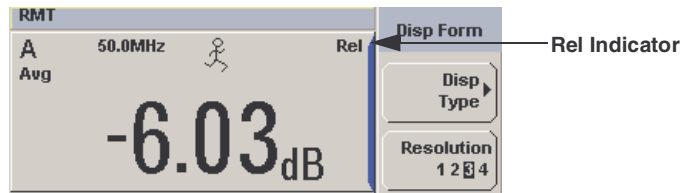

NOTE

The **Rel** symbol is not displayed when the associated measurement is displayed in **Dual Numeric** or **Analog** format.

Setting Offsets

The power meter can be configured to compensate for a signal loss or gain in your test setup. The power meter allows you to apply offsets at three different points in the measurement path.

Figure 2-3 Simplified Measurement Path

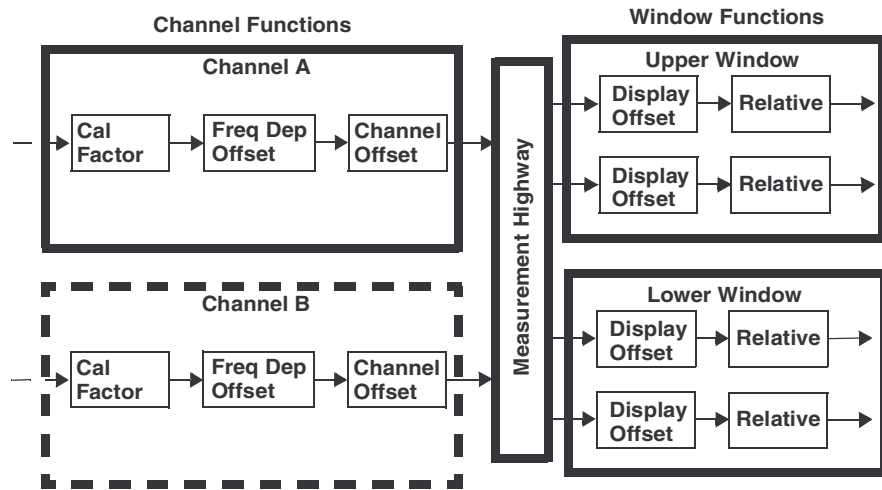

Figure 2-3 shows you can apply a Channel Offset or a Frequency Dependent Offset prior to any mathematical functions. These allows you to compensate each channel individually. An overall offset can be applied if required using the Display Offset.

Setting Channel Offsets

This gain or loss is applied to the measured power before any mathematical functions, display offsets or relative functions are included.

Offsets are entered in dB and the range of values is -100 dB to +100 dB.

A positive value compensates for a loss, and a negative value compensates for a gain.

Setting Offsets

Procedure

To enter a channel offset:









1. Press  to display the Channel Setup screen.
Confirm the channel requiring setup is displayed.
2. Press **Offsets** to display the Offsets Setup.
3. Use the  and  keys to highlight the Offset setting field.
4. Press  to check the Offset setting field.

Figure 2-4 Typical Channel Offset Display

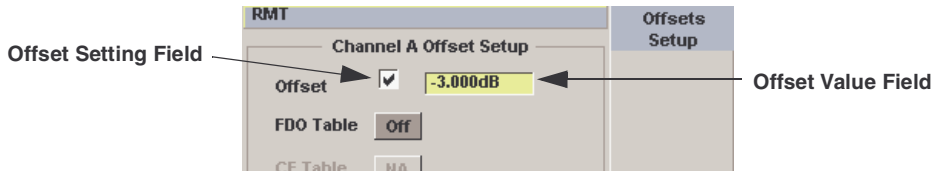

5. Press  to highlight the Offset value field and press  to display the Offset pop-up.
Use the numeric keypad to enter the required value in the Offset pop-up window.
6. Confirm your choice by pressing **dB**.

7. Press  key to complete the offset entry.

If either a channel or a display offset is set, the Ofs indicator is displayed.

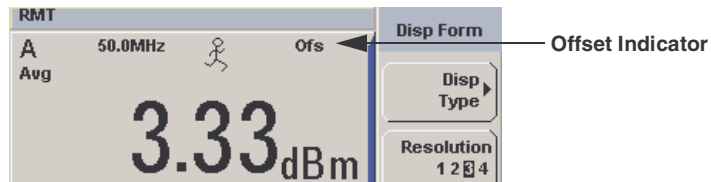

NOTE

The **Ofs** symbol is not displayed when the associated measurement is displayed in Dual Numeric or Analog format.

Setting Display Offsets

This gain or loss is applied to the measured power after any channel offsets or mathematical functions have been included.

Offsets are entered in dB and the range of values is -100 dB to +100 dB. A positive value compensates for a loss, and a negative value compensates for a gain.

Procedure

Enter a display offset on the currently selected window:

1. Press  to display the Measurement Setup screen.
2. Select the window you want to set the offset value on by pressing the **Meas Select** key.

The currently selected window/measurement is displayed.







3. Use the  and  keys to highlight the Offset setting field.
4. Press  to check the Offset setting field.

Figure 2-5 Typical Display Offset Display

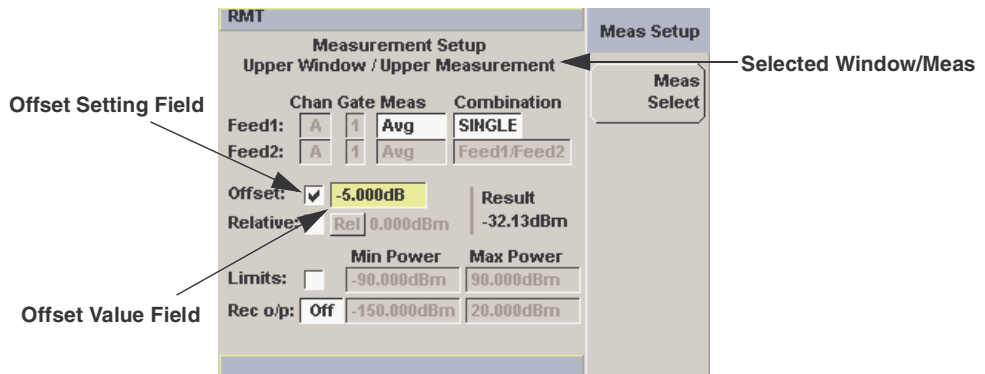

5. Press  to highlight the Offset value field and press  to display the Display Offset pop-up. Use the numeric keypad to enter the required value in the Offset pop-up window.
6. Confirm your choice by pressing **dB**.

Setting Offsets

7. Press  key to complete the offset entry.

NOTE

The **Ofs** indicator is displayed if Display Offset is selected.

Setting Frequency Dependent Offsets

Frequency dependent offset tables provide a quick and convenient method of compensating for frequency related changes in the response of your test system. Note that when selected, frequency dependent offset corrections are applied IN ADDITION to any correction for sensor frequency response.

The power meter is capable of storing 10 frequency dependent offset tables with a maximum of 80 frequency points each.

To use frequency dependent offset tables:





1. Select the table to be applied to a channel. Refer to “Selecting a Frequency Dependent Offset Table” on page 33 for further information. If you require to edit the table refer to “Editing Frequency Dependent Offset Tables” on page 35 for further information.
2. If using an 8480 series or an E-series sensor, zero and calibrate the power meter. The reference calibration factor used during the calibration is automatically set by the power meter from the sensor calibration table (if selected).
3. Specify the frequency of the signal you want to measure. The calibration factor/offset is automatically set by the power meter from the sensor calibration table (if selected) and the frequency dependent offset table. Refer to “Procedure” on page 33 for further information.
4. Make the measurement.

Selecting a Frequency Dependent Offset Table

You can select a frequency dependent offset table from the  key menu followed by **Tables** and **Freq. Dep. Offset**.

The State column indicates if any frequency dependent offset tables are currently selected. The Offset Tables screen is shown in Figure 2-6.

NOTE

You can also view which FDO table is being used by pressing the , **Offsets** and use the  and  keys to highlight the FDO Table setting field and press  to display the table.

Procedure

Select an offset table as follows:

1. Press, either:

- a. , **Tables**, **Freq. Dep. Offset**.
- b. , **Offsets** and use the  and  keys to highlight the FDO Table setting field and press  to display the table.

Figure 2-6 Frequency Dependent Offset Tables Display

RMT			Offset Tbls	
Tbl Name	State	Pts		
A CUSTOM_A	off	1	Edit Table	
B CUSTOM_B	on	1		
C CUSTOM_C	off	0	Table Off On	
D CUSTOM_D	off	0		
E CUSTOM_E	off	0	Done	
F CUSTOM_F	off	0		
G CUSTOM_G	off	0		
H CUSTOM_H	off	0		
I CUSTOM_I	off	0		
J CUSTOM_J	off	0		
				1 of 1

Setting Offsets

- Use the  and  keys to highlight one of the 10 table titles and press **Table** to highlight **On**.





NOTE

When no data is contained in the highlighted table, the **Table** key is disabled (greyed out).

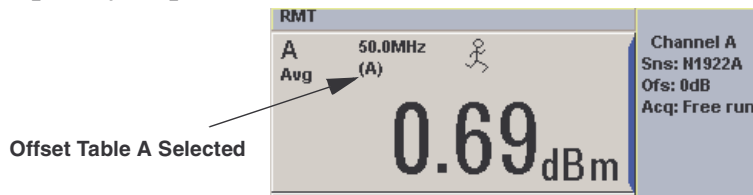
- Press **Done** to complete the selection of the offset table.
- Press **Done** again to display the measurement screen. Figure 2-7 shows which offset table is selected.

Figure 2-7 Frequency Dependent Offset Indicator



- To change the frequency, press  and use the  and  keys to highlight the Frequency field.
- Press  to display the Frequency pop-up window. Use the numeric keypad to enter the required value in the Frequency pop-up window.
- To confirm your choice press the appropriate unit softkey.
- Connect the power sensor to the signal to be measured.
- The measurement result, including offset, is now displayed.

NOTE

If the measurement frequency does not correspond directly to a frequency in the sensor calibration table (if selected) and the frequency dependent offset table being used, the power meter calculates the calibration factor and offset using linear interpolation. If you enter a frequency outside the frequency range defined in the sensor calibration table or the frequency dependent offset table, the power meter uses the highest or lowest frequency point in the

appropriate table to set the calibration factor and offset.

Editing Frequency Dependent Offset Tables

There are ten frequency dependent offset tables named CUSTOM_A through CUSTOM_J. They are empty of any data when the power meter is shipped from the factory.

You cannot delete any of the 10 existing frequency dependent offset tables or create any additional tables. However, you can enter values into the 10 existing tables. Each frequency dependent offset table can contain a maximum of 80 frequency points.

To view the frequency dependent offset tables currently stored in the power meter, press , **Tables**, **Freq. Dep. Offset**. The Frequency Dependent Offset Tables screen is displayed as shown in Figure 2-6 on page 33.

Creating frequency dependent offset tables requires the following steps:



1. Identify and select the table you want to edit.
2. Rename the table.
3. Enter the frequency and offset pairs.
4. Save the table.

Procedure

First select the table you want to edit as follows:

NOTE

A frequency in the range of 0.001 MHz to 1000.0 GHz can be entered. A calibration factor in the range of 1% to 150% can be entered.

1. Press , **Tables**, **Freq. Dep. Offset** to display the Offset Tbls screen.
2. Choose the table you want to edit using the  and  keys. Press

Setting Offsets

Edit Table to display the Edit Offset screen as shown in Figure 2-8.

Figure 2-8 “Edit Offset” Display with data added

RMT		Edit Offset
Name: CUSTOM_C		Change
Freq	Offset	Insert
1kHz	125.0%	Delete
5kHz	150.0%	Done
200kHz	96.0%	1 of 1
10.000MHz	90.0%	
10.000GHz	100.0%	
600.000GHz	99.0%	
1000.000GHz	40.0%	







- Highlight the table title using the  and  keys. Press **Change** and use the , ,  and  keys to select and change the characters in the Table Name pop-up to create the name you want to use.

Figure 2-9 Edit Table Title Pop-up

RMT		Cancel		
Name: CUSTOM_C		Enter		
Freq	Offset	Insert Char		
--	1.0%	Delete Char		
1kHz	125.0%	1 of 1		
<table border="1"> <thead> <tr> <th>Table Name</th> </tr> </thead> <tbody> <tr> <td>CUSTOM_C</td> </tr> </tbody> </table>		Table Name	C USTOM_C	
Table Name				
C USTOM_C				

- Pressing **Insert Char** adds a new character to the right of the selected character.
 - Pressing **Delete Char** removes the selected character.
- Press **Enter** to complete the entry.

NOTE

The following rules apply to naming sensor calibration tables:

- The name must consist of no more than 12 characters.
- All characters must be upper or lower case alphabetic characters, or numeric (0-9), or an underscore (_).
- No other characters are allowed.
- No spaces are allowed in the name.

Enter (or edit) the frequency and offset pairs as follows:

1. Press **Insert** to add a new frequency value (or press **Change** to edit). Use the numeric keypad to enter the required value in the Frequency pop-up window. Complete the entry by pressing the **GHz**, **MHz** keys.
2. Enter the new offset value (or press **Change** to edit). Use the numeric keypad to enter the required value in the Offset pop-up window. Complete the entry by pressing the **%** key.
3. Continue adding/editing values until you have entered all the data you require.
4. When you have finished editing the table press **Done** to save the table.

NOTE

If you measure a signal with a frequency outside the frequency range defined in the frequency dependent offset table, the power meter uses the highest or lowest frequency point in the frequency dependent offset table to calculate the offset.

Setting Measurement Averaging

The power meter uses a digital filter to average power readings. The number of readings averaged can range from 1 to 1024. This filter is used to reduce noise, obtain the desired resolution and to reduce the jitter in the measurement results. Increasing the value of the measurement average reduces measurement noise. However, the measurement time is increased. You can manually select the measurement average or you can set the power meter to auto measurement average mode. The default is **AUTO**.

When the auto measurement average mode is enabled, the power meter automatically sets the number of readings averaged together to satisfy the filtering requirements for most power measurements. The number of readings averaged together depends on the resolution setting and the power level currently being measured.

Figure 2-10 Typical Averaged Readings

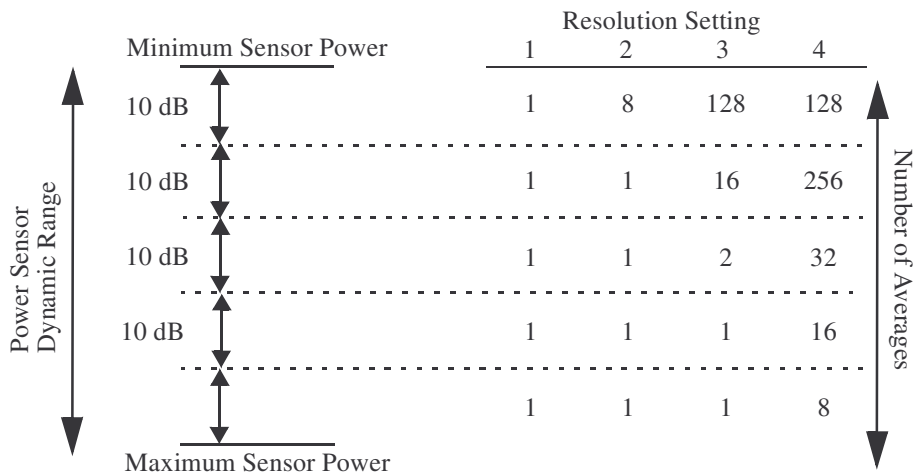

Figure 2-10 shows the typical number of averages for each range and resolution when the power meter is in auto filter mode and is set to normal speed mode. P-series power meters recognize different sensor types when they are connected, and configures suitable averaging automatically.

Resolution is a measurement display function and not a channel function. In the case where a channel is set up in both the upper and lower window and the resolution settings are different, the highest resolution setting is taken to calculate the averaging number.

These four resolution levels represent:

- 1, 0.1, 0.01, 0.001 dB respectively if the measurement suffix is dBm or dB.
- 1, 2, 3 or 4 significant digits respectively if the measurement suffix is W or %.

Procedure

Set measurement averaging as follows:











1. Press . On dual channel meters select the required channel.
The current setting is shown in the Meas Avg field (**AUTO**, **MAN**, or **OFF**) on the Channel Setup screen. The default is **AUTO**.
2. Use the  and  keys to select the Filter setting field.
3. Press  and use the  and  to step through the available settings.
If you have selected **AUTO** or **OFF** proceed at step 7. If you have selected **MAN** proceed as follows:
4. Use the  key to select the Meas Avg: value field.
5. Press  to display the Meas Avg Count Pop-up.

Figure 2-11 Meas Avg Count Pop-up





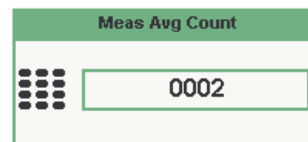

6. Use the numeric keys to enter the required value and press **Enter**.
7. Press  key to close the Channel Setup screen.

Step Detection

To reduce the filter settling time after a significant step in the measured power the filter can be set to re-initialize upon detection of a step increase or decrease in the measured power. Step detection can be set in both manual and automatic measurement average modes.

Procedure

Set step detection as follows:

1. Press . On dual channel meters select the required channel.
2. Use the  and  keys to select the Step Detect setting field.
3. Press  to check the step detection to on or off.
4. Press  key to close the Channel Setup screen.

Setting the Video Averaging

NOTE

This feature is only available when a P-series or an E-series E9320 power sensor is connected.

Video averaging uses a digital filter to average repetitions of a triggered signal. The number of acquisitions averaged can range from 1 to 256, in multiples of 2^n . With video averaging the average of a number of acquisitions is calculated to smooth the displayed trace and reduce apparent meaning noise. The measurement requires a continuously repeating signal. Increasing the value of the filter reduces noise but increases the time required to make the measurement.

Procedure

Set the video average as follows:











1. Press . On dual channel meters select the required channel.
2. Use the  and  keys to select the Video Avg setting field.
3. Press  to check the video averaging to on or off.
4. Use the  key to select the Video Avg: value field.
5. Press  to display the Video Avg Count Pop-up.

Figure 2-12 Video Avg Count Pop-up

Video Avg Count
1
2
4
8
16
32
64
128
256

6. Use the  and  keys to highlight the required Video Avg Count value and press .
7. Press  key to close the Channel Setup screen.

Setting the Video Bandwidth

NOTE

This feature is only available when a P-series or an E-series E9320 power sensor is connected.

Selecting a bandwidth value close to or slightly greater than required by the modulating signal bandwidth can help reduce noise and improve accuracy on peak measurements (See Table 2-3). It can however, reduce the processing speed for long acquisition times.

Table 2-3

P-Series Sensor Video Bandwidth Setting

Low:	Medium:	High:	Off
5.0 MHz	15.0 MHz	30.0 MHz	>30.0 MHz

The Low, Medium, and High pass band shapes achieved by the video bandwidth settings provide flat filter responses with very sharp cut-off points by applying digital signal processing techniques to ensure accurate power measurement within the specified band.

Figure 2-13

Bandwidth Filter Shapes

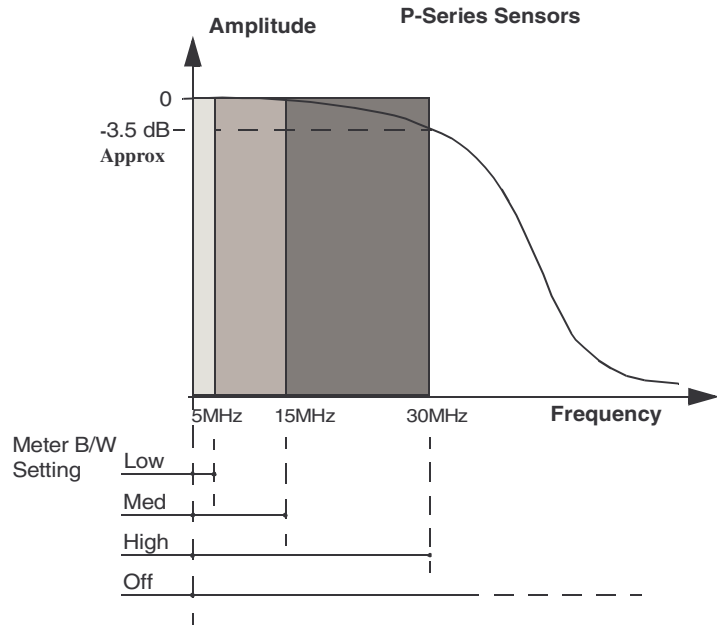

When video bandwidth is set to Off, it removes all signal conditioning. This provides approximately 3dB roll off at the maximum sensor's bandwidth and is best suited for accurate trace capture, minimizing overshoot, and removing any ringing effects caused by the sharp cut-off filters used in the Low, Med and High settings. Figure 2-13 shows the filter shapes associated with the P-Series wideband power sensors.





Procedure

Set the video bandwidth as follows:

1. Press . On dual channel meters select the required channel.
2. Use the and keys to select the Video B/W setting field.
3. Press to display the Video B/W Pop-up.

Figure 2-14 Video Bandwidth Pop-up



4. Use the  and  keys to highlight the required Video Bandwidth setting and press .
5. Press  key to close the Channel Setup screen.

Setting Measurement Channel Gates

NOTE

This feature is only available when a P-series or an E-series E9320 power sensor is connected.

A system of gates, controlled by and referenced to a trigger point, are used to obtain measurement data from a captured trace. The trace data within each gate period is subsequently used for the individual measurement calculations. Up to 4 gates can be set up for each channel. Figure 2-15 shows an example of 4 gates setup to perform the following measurements simultaneously:

- The average power level of the pulse:
Gate 1, average measurement
- The average “off” power level ahead of the pulse:
Gate 2, average measurement.
- The Peak to average ratio:
Gate 1, peak-to-average measurement
- The Pulse droop:
Gate 3, average measurement, minus Gate 4, average measurement

Figure 2-15 Example of Measurement Gates

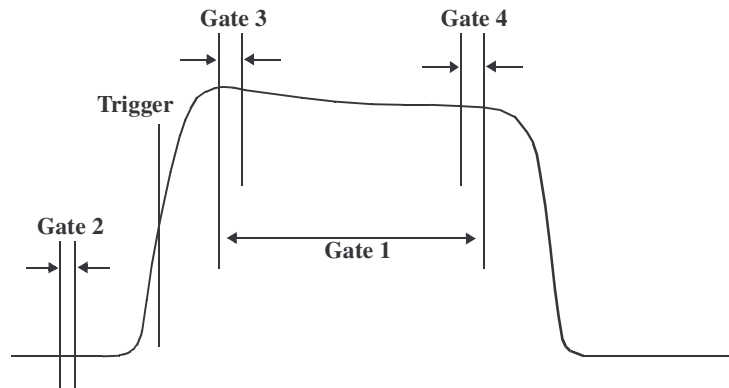

NOTE Figure 2-37 shows measurement results using this gate example.





Procedure

NOTE This procedure uses the **Gates Setup** under the **Channel Setup** menu. Alternatively, you can use a more visual method, when in the Graphical Trace Mode (Gate Control Menu), to set the channel's Gate Control. (See “Setting the Trace Display” on page 85).

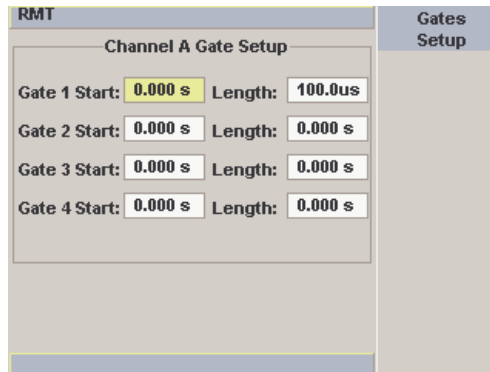
- Press **Gates Setup**. The Channel Gate Setup screen is displayed.

Figure 2-16 Gate Setup screen



1. Highlight the Gate Start you want to configure using the , , , and  keys.

NOTE The gate start time is relative to the trigger event. Positive values set a measurement gate, to a maximum time of 1 second, after the trigger. Negative time gate start values set a measurement gate, to a maximum time of 1 second, before the trigger.

Setting Measurement Channel Gates





- Press  and use the numeric keypad to enter the required value in the Time Gating Start pop-up window.

Figure 2-17 Time Gating Start Pop-up

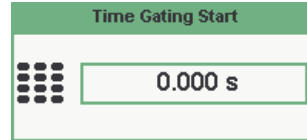

- Complete the entry by pressing the required second, millisecond, microsecond or nanosecond (**s**, **ms**, **us** or **ns**) softkey.
- Highlight the Gate Length you want to configure using the , , , and  keys.

NOTE

The gate length is the length of time from the gate start. It can only have positive values.

- Press  and use the numeric keypad to enter the required value in the Time Gating Length pop-up window.

Figure 2-18 Time Gating Length Pop-up



- Complete the entry by pressing the required second, millisecond, or microsecond or nanosecond (**s**, **ms**, **us** or **ns**) softkey.
- Repeat this process until you have setup all the required gates.

Setting up the Channel Trace

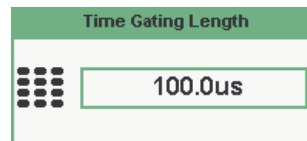
NOTE This feature is only available when a P-series or an E-series E9320 power sensor is connected.

NOTE The **Trace Setup** is only location where you can change the Y-scale units from **dBm** to **Watts**.

Procedure

NOTE This procedure uses the **Trace Setup** under the **Channel Setup** menu. Alternatively, you can use a more visual method, when in the Graphical Trace Mode (Trace Control Menu), to set the channel's Trace Control. (See “Setting the Trace Display” on page 85).

1. Press , **Trace Setup** to display the **Trace Setup** menu.

Figure 2-19 Trace Setup Display

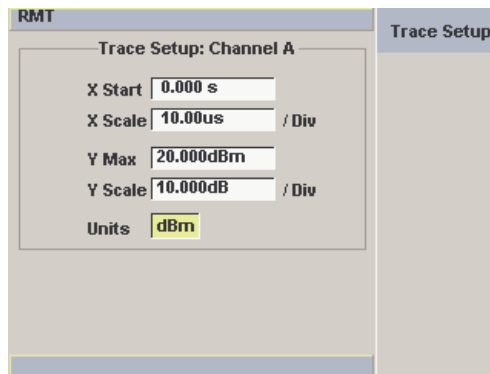

2. Use the  and  keys to highlight the X Start field.

3. Press  to display the Trace Start Time pop-up, and use the numeric keypad to enter the required value in the Trace Start Time pop-up window.

Figure 2-20 Trace Start Time Pop-up









4. Complete the entry by pressing the required second, millisecond, microsecond or nanosecond (**s**, **ms**, **us** or **ns**) softkey.
5. Use the  and  keys to highlight the X Scale field.
6. Press  to display the X Scale/Division pop-up.
 - a. Use the numeric keypad to enter the required value in the X Scale/Division pop-up window.
 - b. Use the  and  keys to increase or decrease the value.

Figure 2-21 X Scale/Division Pop-up



7. Complete the entry by pressing:
 - a. The required second, millisecond, microsecond or nanosecond (**s**, **ms**, **us** or **ns**) softkey.
 - b. The **Enter** softkey.
8. Use the  and  keys to highlight the Units field.

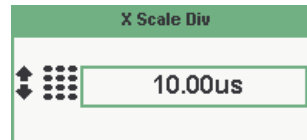

If you are wanting to view the trace in linear mode use this field, otherwise the default unit value is log.
9. Press  to display the Units pop-up, and use the  and  to highlight **Watt** or **dBm**.

Figure 2-22 Trace Units Pop-up







10. Press  to complete the entry.
11. Use the  and  keys to highlight the Y Max field.
12. Press  to display the Trace Maximum pop-up, and use the numeric keypad to enter the required value in the Trace Maximum pop-up window.

Figure 2-23 Y Scale Maximum Value Pop-up







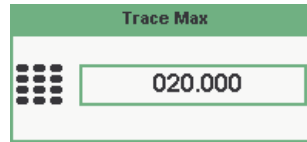

13. Complete the entry by pressing the **dBm** or the linear value.
14. Use the  and  keys to highlight the Y Scale field.
15. Press  to display the Y Scale/Division pop-up.
 - a. Use the numeric keypad to enter the required value in the Y Scale/Division pop-up window.
 - b. Use the  and  keys to increase or decrease the value.

Figure 2-24 Y Scale/Division Pop-up

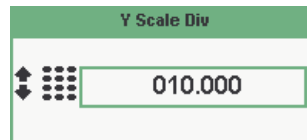

16. Complete the entry by pressing the **dB** or the linear value.
17. Press  key to complete the setup and display the measurements results.

Setting the Trigger

NOTE This feature is only available when a P-series or an E-series E9320 power sensor is connected.

The trigger can be taken from a rising or falling measured power level or controlled externally using the Ext Trig input. Additional control features such as; hold-off, hysteresis, and delay are provided to help you achieve a stable and reliable trigger. To use of the measurement gates the power meter must be triggered.

- Press . The **Trigger** menu is displayed.

The trigger status is displayed below the **Acqn** label in the **Trigger** menu. Figure 2-25 shows the power meter display in Free Run mode. In this mode the meter is not synchronized to any modulated RF signal at the sensor input. Consequently, power levels within the configured time gates are random and the displayed measurement results are not valid.

Figure 2-25 Trigger menu - Free Run Mode

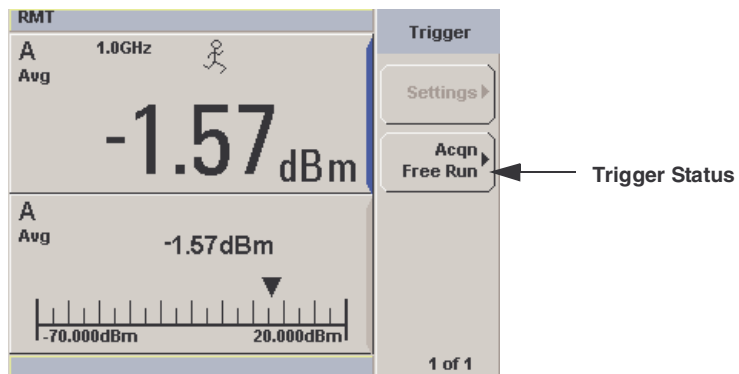

NOTE The  symbol in the upper window indicates the power meter is in free run mode.

Procedure

1. Press **Acqn** softkey to configure a trigger.
2. Select either **Sing Trig** or **Cont Trig**.
 - **Sing Trig** is a single shot mode. After triggering, the measurement is halted, the \otimes symbol is displayed. You can start another measurement by pressing the  key.
 - **Cont Trig** is a continuous trigger mode. The symbol \downarrow or \uparrow is displayed. Figure 2-26
3. Press **Settings** to configure the remaining trigger parameters.

The trigger Settings menu have 2 pages. Figure 2-26 shows page 1 and Figure 2-29 shows page 2.

Figure 2-26 Trigger Setting Menu 1 of 2

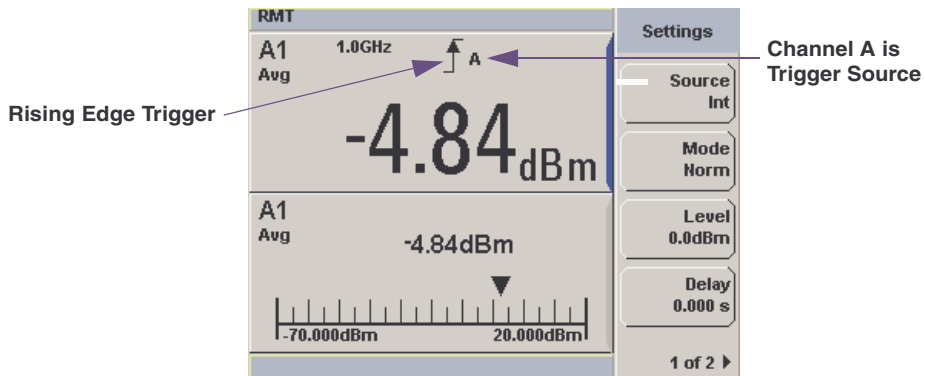

To help you quickly check the triggering setup, the current settings for all the trigger parameters are shown with their respective softkey labels.

Setting the Trigger

Source

The current setting is shown below the **Source** label.

To change the setting press **Source** and choose **Ext** or **Int**.

The trigger source is shown beside the trigger symbol when a measurement window is configured in single numeric mode. When an external trigger (**Ext**) is selected, the power meter can be triggered via the Ext Trig input.

Mode

The **Mode** key is only available when trigger **Source Int** is selected.

To change the setting press **Mode** and choose **Norm** or **AutoLvl**.

The current setting is displayed below the label. When **Norm** is selected you can choose the RF power level transition used as the trigger. The power meter automatically finds a triggering power level transition when **AutoLvl** is selected.

Level

Level is only available when **Norm** trigger mode has been selected. The current value is shown below the **Level** label. The minimum power level you can enter is limited to 40 dB below the maximum sensor power. To change the setting press **Level** and use the numeric keypad to enter the required value in the Trigger Level pop-up window to enter the new value.

Figure 2-27

Trigger Level Pop-up

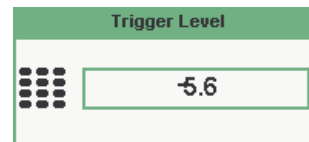

Complete the entry by pressing **dBm**.

Delay

The current setting is displayed below the **Delay** label. The delay time is applied between the trigger event and all the gate start times. This allows you to time-shift all the gates by the same amount with one setting change. A delay of up to 1 second can be entered. To enter or change the setting press **Delay** and use the numeric keypad to enter the required value in the Trigger Delay pop-up window to enter the new value.

Figure 2-28 Trigger Delay Pop-up

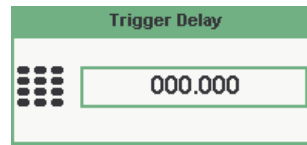

Complete the entry by pressing the required second, millisecond, microsecond or nanosecond (**s** , **ms** , **us** or **ns**) softkey.

NOTE

The trigger delay time can also be entered or changed in the Trace Display mode when the **Gate Control** menu is displayed. (See “Setting the Trace Display” on page 85 for further detail.

Press **1 of 2** to display the second menu page.

Figure 2-29 Trigger Setting Menu 2 of 2



Slope

The current setting is displayed below the **Slope** label and the ↓ or ↑ symbol is displayed in single numeric display mode. + (and ↑) is used to generate the trigger from an increasing power level. Similarly, - (and ↓) is used to generate the trigger from a decreasing power level

To change the setting press **Slope** to highlight + or - as required.

Setting the Trigger**Holdoff**

The current setting is displayed below the **Holdoff** label. After a trigger event occurs, the trigger mechanism is disabled for the configured time period. This allows stable triggering to be achieved even when a signal has multiple edges, for example, a TDMA signal with non-constant amplitude modulation. Values up to 400 ms can be configured.

To change the setting press **Holdoff** and use the numeric keypad to enter the required value in the Trigger Holdoff pop-up window to enter the new value.

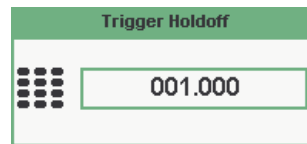
Figure 2-30**Trigger Holdoff Pop-up**

Complete the entry by pressing **ms**, **us** or **ns**.

Hysteresis

Hysteresis is only available when **Norm** trigger mode has been selected. The current setting is displayed below the **Hysteresis** label. You can use the hysteresis function to help generate a more stable trigger by preventing triggering unless the RF power level achieves the trigger level and the additional hysteresis value. It can be applied to both rising and falling edge trigger generation. A maximum of 3 dB hysteresis can be entered.

Rising edge:

When a rising power transition triggers the power meter, the triggering system is disabled. The power meter does not trigger again if another rising power transition is presented. The triggering system is rearmed only when the input power falls below a level equal to the trigger level minus the configured hysteresis value.

Falling edge:

When a falling power transition triggers the power meter, the triggering system is disabled. The power meter does not trigger again if another falling power transition is presented. The triggering system is rearmed only when the input power rises above a level equal to the trigger level plus the configured hysteresis value.

To change the setting press **Hysteresis** and use the numeric keypad to enter the required value in the Trigger Hysteresis pop-up window to enter the new value.

Figure 2-31

Trigger Hysteresis Pop-up

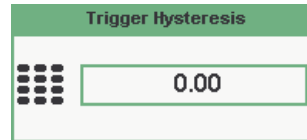

Complete the entry by pressing **dB**.

Output

The current setting is displayed below the **Output** label. A TTL level high is produced at the rear panel TRIG OUT BNC connector when the power meter is triggered when **On** is configured.

To change the setting press **Output** to highlight **On** or **Off** as required.

Setting Measurement Limits

You can configure the power meter to detect when a measurement has crossed over a predefined upper and/or lower limit value.

Limits are windows or measurement display line based and can be applied to power, ratio or difference measurements.

Figure 2-32 Limits Checking Application.

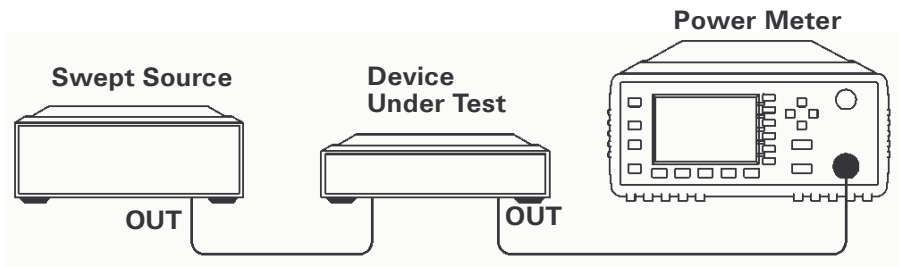

In this application a swept frequency signal is applied to the input of the Device Under Test. The power meter measures the output power. The limits have been set at +4 dBm and +10 dBm. A fail occurs each time the output power is outside these limits as shown in Figure 2-33.

Figure 2-33 Limits Checking Results

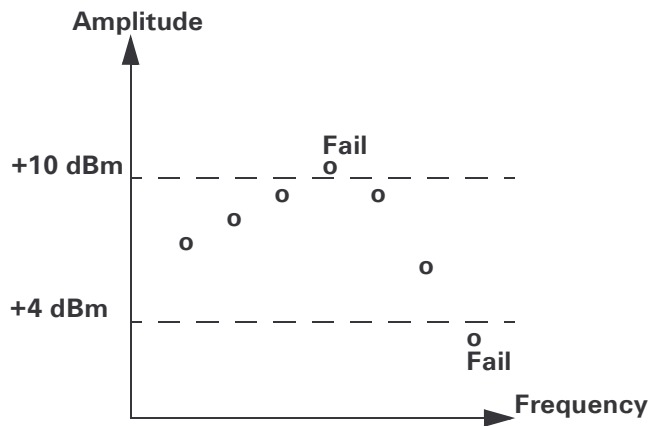

Setting Limits

The power meter can be configured to verify the current measurement in any measurement line against predefined upper and/or lower limit values. The range of values that can be set for the upper and lower limits and the default values depends on the measurement units in the currently selected measurement line - see Table 2-4

Table 2-4 Range of Values for Window Limits

Window Units	Maximum	Minimum	Default Maximum	Default Minimum
dB	+200 dB	-180 dB	60 dB	-120 dB
dBm	+230 dBm	-150 dBm	90 dBm	-90 dBm
%	999.9 X%	100.0 a%	100.0 M%	100.0 p%
W	100.000 XW	1.000 aW	1.000 MW	1.000 pW

Procedure

Set the limits as follows:

NOTE

Ensure you have selected the channel you want to set up.









1. Press , **Meas Select** to display the Measurement Setup menus.
2. Use the  and  keys to highlight the Limits: setting field.
3. Press  to check the Limits: setting field
4. Use the  key to highlight the Minimum Limits: value field.
5. Press  to display the Minimum Limit Pop-up.

Figure 2-34 Minimum Limit Pop-up



6. Use the numeric keys to enter the required value and press **dBm**.
7. Use the  key to highlight the Maximum Limits: value field.
8. Press  to display the Maximum Limit Pop-up.
9. Use the numeric keys to enter the required value and press **dBm**.
10. Press  key to close the Measurement Setup screen.

NOTE

The Limits can be disabled and re-enabled by checking the Limits: setting field.

Checking for Limit Failures

Limit failures are displayed in the appropriate field in the measurement window on the power meter's display as shown in Figure 2-35.

Figure 2-35 Limit Failures

Limit Failures

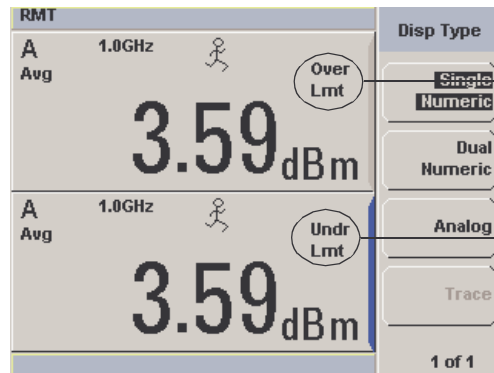

This measurement has failed as the result is greater than the set limit level.

This measurement has failed as the result is less than the set limit level.

Setting the Measurement Display

Using the gate settings, up to 4 measurements or a combination of measurements can be shown on the display. Any of the 4 measurement display lines can show any of the measurement results from any of the 4 gates allowing you complete control of the displayed information.

The power meter cannot display all 12 (or 24) measurements simultaneously.

Average, peak, and peak-to-average ratio measurements are made within each gate period generating 12 possible measurement results per channel as shown in Figure 2-36.

Figure 2-36

Twelve Measurements per Channel

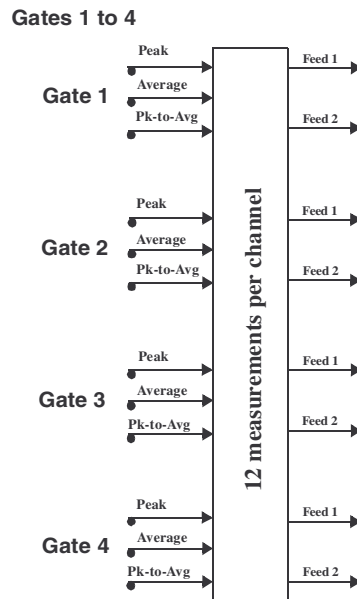
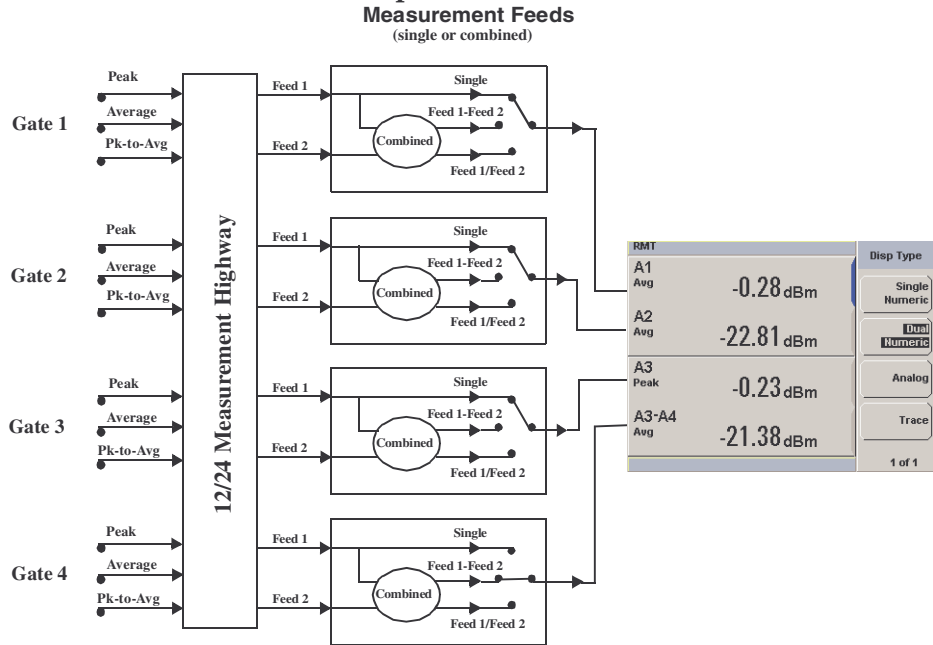

Figure 2-37

Measurement Feed Example



Each displayed line has a measurement feed. Each measurement feed has two independent inputs, Feed 1 and Feed 2. The two Feeds, 1 and 2, can carry any of the 12 measurement results from the 4 gates. (24 measurements from 8 gates in the dual channel N1912A.) Only Feed 1 can be displayed in Single Mode. In Combined Mode, Feed 1 - Feed 2 or Feed 1 / Feed 2 can be displayed.

Numeric Format

Configure a measurement displayed in **Single Numeric** or **Dual Numeric** format as follows:

- Press **Meas**, **Meas Select** to select the measurement window or measurement line you want to configure.

Figure 2-38 Measurement Setup Showing Single Configuration

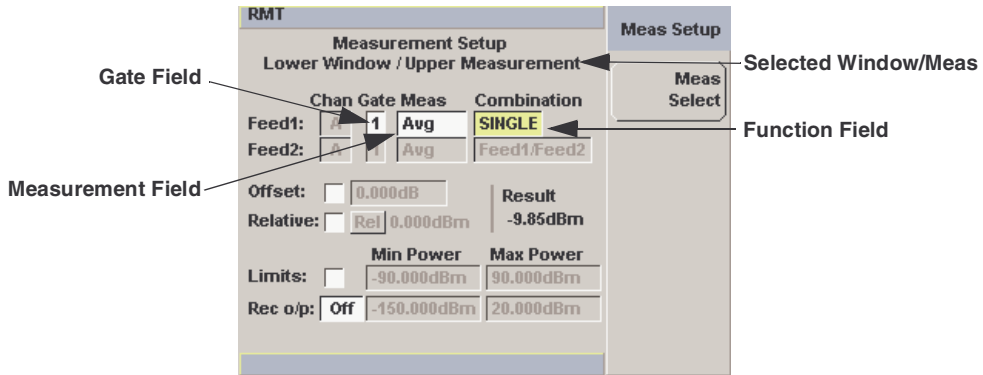

Single Function Measurement

Figure 2-38 shows Gate 1 with an average measurement assigned in the upper measurement line of the lower window. (The Channel field is disabled as a single channel meter is shown).

NOTE

The Gate field is disabled if Trigger Acquisition is Free Run.

1. Use the , , , , to highlight the Combination function field.
2. Press to display the Function pop-up, and use the and to highlight **Single**.

Figure 2-39 Function Pop-up



3. Press to complete the entry.
4. Use the , , , , to highlight the measurement type field.
5. Press to display the Feed Measurement pop-up, and use the and in assign a measurement type.

Figure 2-40 Measurement Type Pop-up

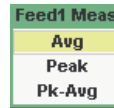









6. Press  to complete the entry.
7. Use the , , , , to highlight the Gate field.
8. Press  to display the Gate Number pop-up, and use the numeric keypad to enter the required value in the Gate Number pop-up window.

Figure 2-41 Gating Number Pop-up

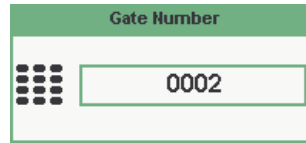

9. Press **Enter** to complete the entry.
10. Repeat this process until you have setup all the required gates and measurements.
11. Press  key to complete the setup and display the measurements results.

Combined Measurement





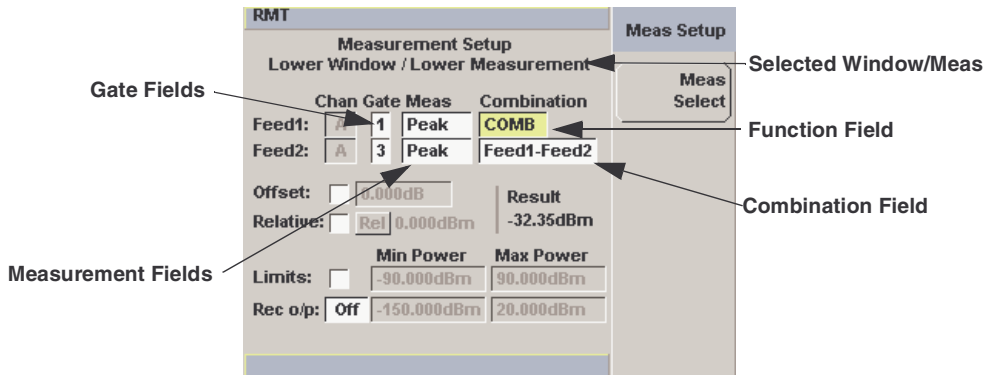















Figure 2-42 shows a Combined Measurement configuration; channel A, gate 1 peak power minus gate 3 peak power, to be displayed in the lower measurement line of the lower display window. (Again, the Channel field is disabled as a single channel power meter is shown.)

Figure 2-42 Measurement Setup Showing Combined Configuration



NOTE

The Gate field is disabled if Trigger Acquisition is Free Run.

1. Use the , , , , to highlight the Combination function field.
2. Press  to display the Function pop-up, see Figure 2-39, and use the  and  to highlight **Combined**.
3. Press  to complete the entry.
4. Use the , , , , to highlight the measurement type field.
5. Press  to display the Feed Measurement pop-up, see Figure 2-40, and use the  and  in assign a measurement type.
6. Press  to complete the entry.
7. Use the , , , , to highlight the Gate field.

Setting the Measurement Display







8. Press  to display the Gate Number pop-up, see Figure 2-41, and use the numeric keypad to enter the required value in the Gate Number pop-up window.
9. Press **Enter** to complete the entry.
10. Repeat this process until you have setup all the required gates and measurements.
11. Press  key to complete the setup and display the measurements results.

Figure 2-43 Measurement example display

Scaling the Analog Display

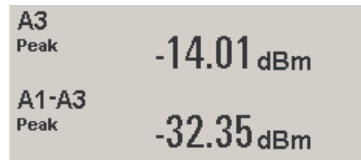
NOTE

Ensure you have highlighted an Analog window.

Use the , , or  keys to select the analog measurement window.

Press **dBm**, **mW**, **uW**, or **nW**, to complete the entry.

Configure a measurement displayed in **Analog** format as follows:

1. Press , **Anlg Mtr Scaling** to display the Analog Scaling softkeys.
The **Max** and **Min** scale values are shown on the analog display and adjacent to the softkey labels.
2. Press **Max** to display the Meter Maximum Pop-up.

Figure 2-44 Maximum Limit Pop-up



3. Use the numeric keys to enter the required value and press **dB**.
4. Press **Min** to display the Meter Minimum Pop-up.

Figure 2-45 Minimum Limit Pop-up

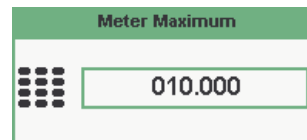
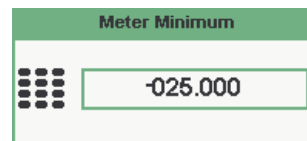

5. Use the numeric keys to enter the required value and press **dB**.

TIP

If you have selected linear scaling for the analog measurement and the units you require are beyond the range of the displayed menu, an additional menu is available. When the pop-up is displayed, you can press **1 of 2** to access the increment/decrement multiplier menu.

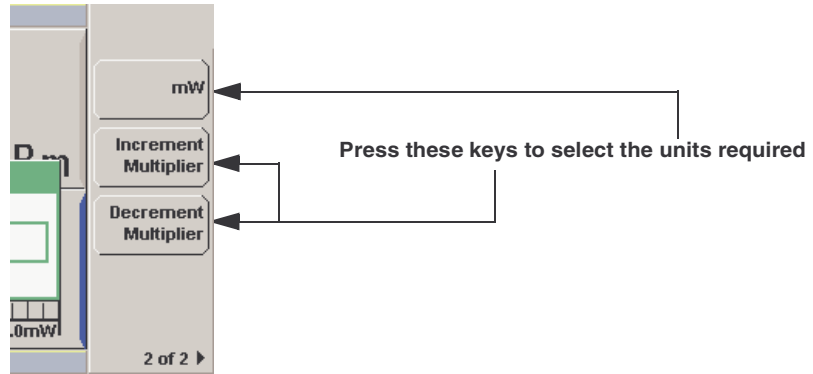

Use the **Increment Multiplier** or **Decrement Multiplier** to display the required units. Press the units softkey (**xW**) to complete the entry.

Recorder Output

The rear panel Recorder Output connectors (1 and 2) produce a dc voltage that corresponds to the power level in Watts of the channel, This is dependant on the measurement mode. This dc voltage ranges from 0 to +1 Vdc. The output impedance is typically 1 k Ω Channel and display offsets, and duty cycle have no effect on the Recorder Outputs.

For example, the Recorder Outputs can be used to:

- record swept measurements
- level an output from a source using external leveling
- monitor the output power







To access the Recorder menu press , and enable Rec o/p. This allows you to switch the Recorder Output signal either on or off. The **Max Power** and **Min Power** softkeys allow you to scale the power levels to represent the 1 Vdc maximum and 0 Vdc minimum output voltage of the Recorder Output.

Procedure

Set the recorder output as follows:

NOTE

Ensure you have selected the channel you want to set up.

1. Press , **Meas Select** to display the Measurement Setup menus.
2. Use the  and  keys to highlight the Rec o/p: setting field.
3. Press  to reveal the Recorder option menu.
4. Use the  and  keys to highlight the option you require.
 - The N1911A has only two options On or Off.
 - The N1912A have three options of 1, 2 or Off.

Recorder Output



5. Press .
6. Use the  key to highlight the Recorder Minimum: value field.
7. Press  to display the Recorder Minimum Pop-up.

Figure 2-46 Recorder Minimum Pop-up



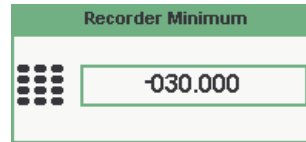

8. Use the numeric keys to enter the power level you want to generate a 1 Vdc output in the Recorder Maximum Pop-up and press **dBm**.
9. Use the  key to highlight the Recorder Maximum: value field.
10. Press  to display the Recorder Maximum Pop-up.

Figure 2-47 Recorder Maximum Pop-up

11. Use the numeric keys to enter the power level you want to generate a 0 Vdc output in the Recorder Minimum Pop-up and press **dBm**.
12. Press  key to close the Measurement Setup screen.

NOTE

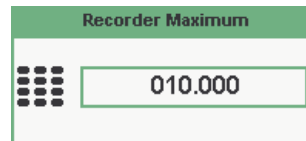
The recorder output can be disabled and re-enabled by checking the Rec o/p: setting field.

NOTE

The highest power you are going to measure is used to determine the value which you should set for the Recorder Output maximum setting. For example, if you are measuring a power less than 1 mW and greater than 100 μ W, then set the recorder maximum value to 1 mW.

Log	50	40	30	20	10	0
Lin	100 W	10 W	1 W	100 mW	10 mW	1 mW

Log	-10	-20	-30	-40	-50	-60
Lin	100 μ W	10 μ W	1 μ W	100 nW	10 nW	1 nW

TIP

If you have selected linear scaling for the recorder output and the units you require are beyond the range of the displayed menu, an additional menu is available. When the pop-up is displayed, you can press **1 of 2** to access the increment/decrement multiplier menu.

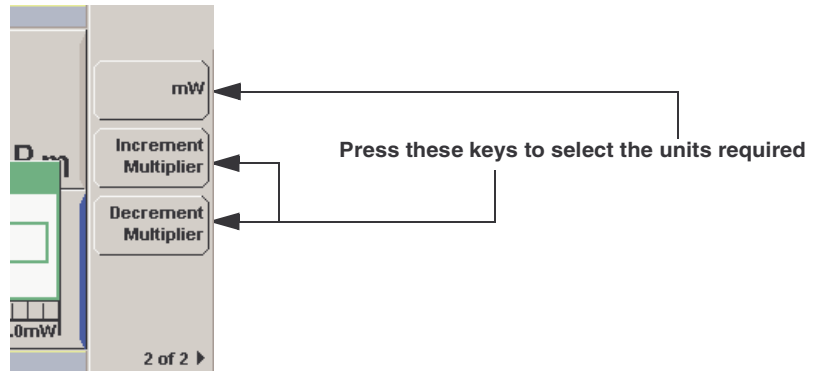

Use the **Increment Multiplier** or **Decrement Multiplier** to display the required units. Press the units softkey (**xW**) to complete the entry.

Saving and Recalling Power Meter States

To reduce repeated setup sequences, you can save a maximum of ten power meter states in non-volatile memory.

The save/recall functions are part of the **Sys/Inputs** menu, accessed by pressing the  key.

NOTE

Your power meter has measurement configurations suitable for common wireless communication and radar (pulse) formats already saved as Instrument States. These require P-series or E-series E9320 power sensors.

To save a measurement setup:

1. Press , **Save/Recall** to display the Save/Recall screen as shown in Figure 2-48.

Figure 2-48 Save/Recall screen

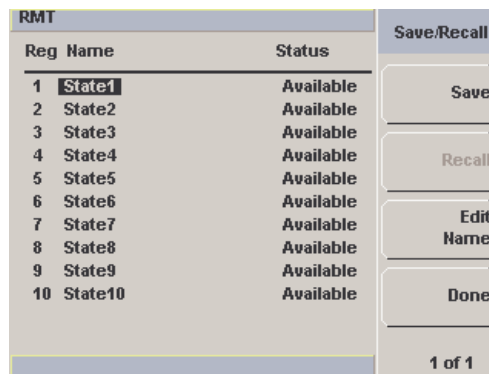

RMT		Save/Recall
Reg	Name	Status
1	State1	Available
2	State2	Available
3	State3	Available
4	State4	Available
5	State5	Available
6	State6	Available
7	State7	Available
8	State8	Available
9	State9	Available
10	State10	Available

Buttons on the right: Save, Recall, Edit Name, Done. Bottom: 1 of 1



2. Using the  and  keys, select an available name from the displayed list. To change the name of a register - See “Editing a Register’s Name” on page 73, otherwise press **Save** .
3. The power meter prompts you to press **Confirm** to proceed.

Figure 2-49 Save Confirm Pop-up



Editing a Register's Name



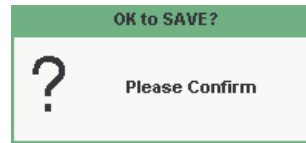





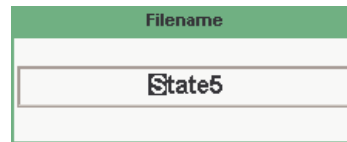

1. If you have not already done so, press , **Save/Recall**.
2. Use the  and  keys to select the required register and press **Edit Name**. The selected name is displayed in a pop up window. Modify this as required:

Figure 2-50 File Name Pop-up



3. Use  and  keys to modify the character on which the cursor is currently positioned.
4. Use  or  to move to other characters.
5. Use **Insert Char** and **Delete Char** as required.
6. To confirm your choice press **Enter**.

Recalling a Measurement Setup

1. Press , **Save/Recall**.
2. Use the  and  keys to select the required register and press **Recall**.

The **Recall** key is disabled (greyed out) when an unused register is selected.

Figure 2-51 “Recall” Pop-up

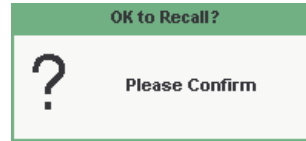

3. Press **Confirm**.

Zeroing and Calibrating the P-Series Sensor

This section describes how to zero and calibrate the power meter when using a P-Series Wideband Power Sensor.

Zeroing

Zeroing adjusts the power meter for a zero power reading on each power meter channel and P-series sensor combination. This is achieved without removing it from a power source. The power meter can be set to automatically zero *on-the-fly* while you are using the it. Alternatively, you can perform a zero at your preference. During zeroing a wait symbol is displayed.

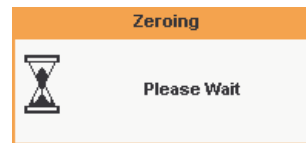

When the P-series power sensor is initially connected to the power meter, it automatically performs a Zero and Calibration routine.

When to Zero?

Zeroing of the power meter is recommended:

- when a 5°C change in temperature occurs.
- every 24 hours.
- prior to measuring low level signals. For example, 10 dB above the lowest specified power for your power sensor.

Automatic Zero

The automatic zero can be enabled as follows:

- Press , **1 of 2** and toggle the **Auto Zero A** to On.

The Zeroing Pop-up is displayed when a zero occurs.

NOTE

When you are making measurements this may cause delays in obtaining

Zeroing and Calibrating the P-Series Sensor

results. On these occasions you may want to disable the automatic zero.

Manual Zeroing

To manually zero the power meter and sensor:

- Press  and the channel **Zero** softkey.

The Zeroing Pop-up is displayed.

NOTE

On dual channel meters you can zero each channel independently or both channels sequentially by pressing the **Zero** softkey - choosing **Zero A**, **Zero B** or **Zero Both**.

Calibration

Calibration sets the gain of each power meter channel and P-series sensor combination. This is achieved without the need to connect it to 1.0 mW Power Reference. The power meter can be set to automatically calibrate *on-the-fly* while you are using the it. Alternatively, you can perform a calibration manually. The reference calibration factor is automatically set for all P-series power sensors.

During calibration the wait symbol is displayed.

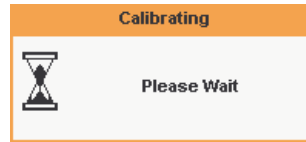

Offset and relative settings are ignored during calibration.

Automatic Calibrate

The automatic zero feature is not available with first release.

Manually Calibrate

To manually calibrate the power meter and sensor combination:

1. Press  and the channel **Cal** softkey to start the calibration routine.

The Calibrating Pop-up is displayed.

NOTE

On dual channel meters you calibrate each channel independently by pressing the **Cal** softkey - choosing **Cal A** or **Cal B**.

TIP

You can reduce the steps required to carry out the manual zero and calibration procedure as follows:

Press  and **Zero + Cal**. (For dual channel meters, press

Zero + Cal , **Zero + Cal A** or **Zero + Cal B** as required.)

Zero/Cal Lockout

The Zero/Cal Lockout facility can help you make sure that a measurement cannot be made until the power meter and sensor combination has been zeroed and calibrated.

When the Zero/Cal Lockout facility is enabled and a sensor is initially connected, the message **Please Zero and Cal** is displayed.

Figure 2-52

Please Zero and Calibrate

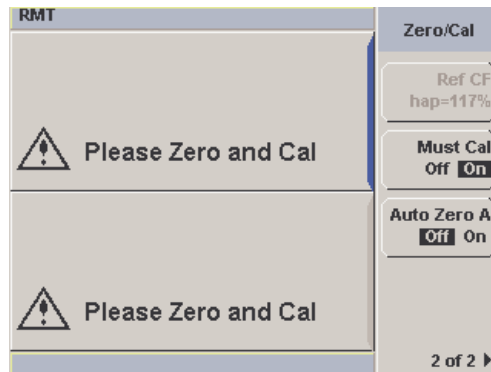

When you zero the sensor the message changes to **Please Cal**. If you calibrate the sensor before zeroing it, the message changes to **Please Zero**.

Dual channel meters display channel specific messages when a sensor is connected. The Zero/Cal Lockout configuration is applied to both channels - it cannot be applied to one channel only.

You can enable and disable the Zero/Cal Lockout facility from the System menu or the Cal menu as follows:

Press **System** , 1 of 2, **Must Cal** **Off** or **On**.

Similarly,

press **Cal** , 1 of 2, **Must Cal** **Off** or **On**.

Presetting the Power Meter

This section details the power meter's preset conditions.

Pressing the  (Preset) key to display the preset options as shown in Figure 2-53.

Figure 2-53

Preset Display Options

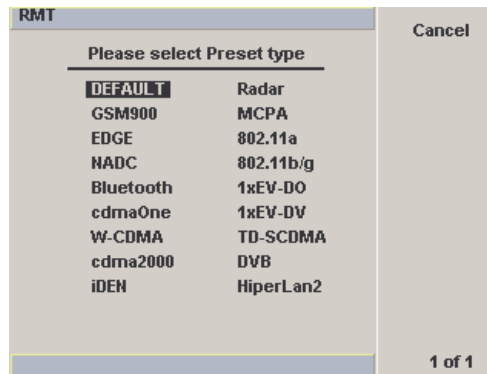

Please select Preset type	
DEFAULT	Radar
GSM900	MCPA
EDGE	802.11a
HADC	802.11b/g
Bluetooth	1xEV-DO
cdmaOne	1xEV-DV
W-CDMA	TD-SCDMA
cdma2000	DVB
iDEN	HiperLan2

Cancel

1 of 1

The remote addresses, the data stored in the sensor calibration tables, the calibration table selected, and the zeroing and calibration data are not affected by a preset.

NOTE

With all preset states, the number of windows displayed is two.

3 Using P-Series Power Sensor

What You'll Find In This Chapter

This Chapter describes how to use your P-Series Power Sensor with your P-Series Power Meter.

It contains the following sections:

- “Introduction” on page 83
- “Configuring a Power Measurement” on page 84
- “Setting the Trace Display” on page 85

Introduction

The P-Series Wideband Power Sensor's mode of operation is optimized to measure the peak and average power of pulsed or modulated signals with a wide bandwidth.

The power meter automatically recognize a P-Series Wideband Power Sensor when it is connected. The sensor's calibration data, characterizing the sensor output versus input power, frequency and temperature, is automatically read by the power meter. After the sensor's data is read, the power meter automatically performs a zero and calibration, this process is described in "Zeroing and Calibrating the P-Series Sensor" on page 75.

The power meter and P-Series Wideband Power Sensor continuously sample the RF signal at a 100 mega-samples per second. Similarly, the Dual Channel meter samples both channels at the same rate.

The instantaneous power of an RF signal can be detected with up to 30 MHz of video¹ bandwidth (modulation bandwidth).

The triggering methods used by the system (power meter and sensor) enable the continuous measurement of modulated signals or single events. A trigger can be taken from a rising or falling edge of an RF signal pulse or controlled externally.

NOTE

Maximum dynamic range is related to the maximum sensor bandwidth. Refer to the documentation supplied with your P-Series Wideband Power Sensor for specification information.

1. The term *video* is applied to a signal that has been amplitude demodulated from an RF carrier, but contains components in the RF part of the spectrum. For a power meter it refers to the output of the sensor diodes.

Configuring a Power Measurement

While the P-series power meter may at first seem complex, configuring a measurement and displaying the results are quickly achieved.

You can configure the required measurements using the data entry from the channel setup gate and trace menus.

However, it can be easier using the trace display's gate control and trace control menus to configure your initial set up, as it is a more interactive process and may require less iterations between channel, triggering, gate, and display functions to make a measurement.

Before configuring the measurements, you should have some information about the signal you want to measure. For example, the following information can help you quickly establish stable triggering and reliable measurement data:

- the Center Frequency (CF)
- the bandwidth of any modulating signal
- the expected maximum and minimum power levels
- timing information for any pulsed signals

Setting the Trace Display

The P-series power meter is optimized to operate in the trace display mode when measuring a pulsed signal.

The swiftest method to get the power meter into a trace display is described in the following procedure.

NOTE

The procedure assumes you are starting from a default preset.

1. Connect the power sensor to the power meter and connect it to the power source.
2. Set the Channel Frequency.
3. Set the Trigger to Continuous.
4. Set the Display to Trace.
5. Expand window and use the Gate control and Trace control menus to set the gate markers, trigger delay, and scale.

NOTE

You can return to other menus later to add more accuracy on the measurement, for example, **Channel Setup**, to set the measurement average, the video average and the bandwidth of a modulating signal.

6. When you are satisfied with the configuration you may want to save it for future use. See “Saving and Recalling Power Meter States” on page 72 for further information

Step 1. Connecting the Power Sensor

When you initially connect a P-Series Wideband Power Sensor to the power meter, the sensor’s calibration data is automatically read by the power meter. After the sensor’s data is read the power meter automatically performs a zero and calibration, see “Zeroing and Calibrating the P-Series Sensor” on page 75 for further information.

Connect the sensor to the power source.

Setting the Trace Display

Step 2. Setting the Channel Frequency

- Press . The **Channel Setup** screen is displayed.

If using an N1912A, select the channel you want to configure.

Use the , , , and  keys to highlight the frequency field. Press

 to configure the setting. See “Setting the Measurement Frequency” on page 25 for further information.

Figure 3-1

P-Series Power Sensor Default Channel Setup

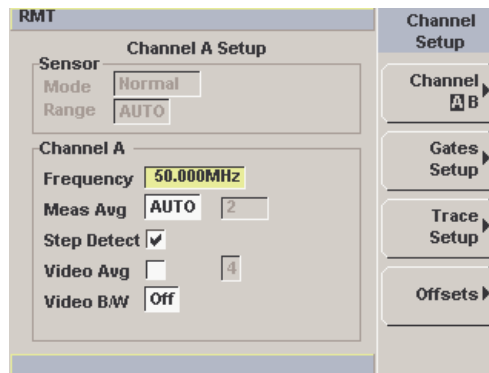

When you have completed the procedure you can return to this menu later to add more accuracy on the measurement.

Step 3. Setting the Trigger

To use the measurement gates the power meter must be triggered.

A trigger can be taken from a rising or falling measured power level or controlled externally using the Ext Trig input.

- Press . The **Trigger** menu is displayed.

The trigger status is displayed below the **Acqn** label in the **Trigger** menu. Press the **Acqn** softkey and select **Cont Trig** to configure a continuous trigger. See “Setting the Trigger” on page 52 for further information.

When you have completed the procedure you may return to the Trigger menu later to add more accuracy to the remaining trigger parameters, to help you achieve a stable and reliable trigger.

Setting the Trace Display

Step 4. Setting the Display to Trace

Using trace display provides a visual representation of the signal of interest.





- Press , **Disp Type**, **Trace** to display the Trace the highlighted window.

Figure 3-2

Trace Display in Dual Channel Power Meter

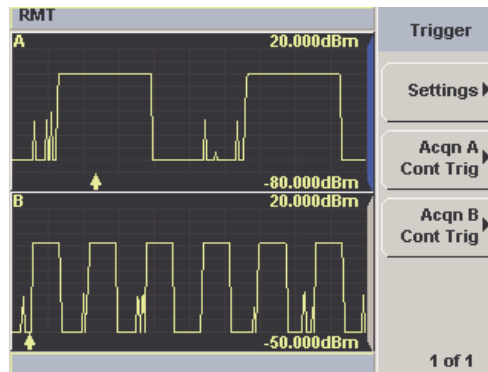
- Use the , , or  keys to select a measurement window. Choose the type of display you require from the menu.

Step 5. Expanding the Trace Display

Expanding the trace to display a Single Enlarged Window provides a more detailed visual representation of the signal of interest and display of the measured results. Figure 3-3 is an example of this display. This display type also provides a visual method of setting up the gate, trigger delay, and trace controls.





Use the  key to configure the display from two rectangular windows to a single enlarged window, or a full screen display by pressing repeatedly. The display style is applied to the currently highlighted window.

Figure 3-3 Trace Display in Single Enlarged Window

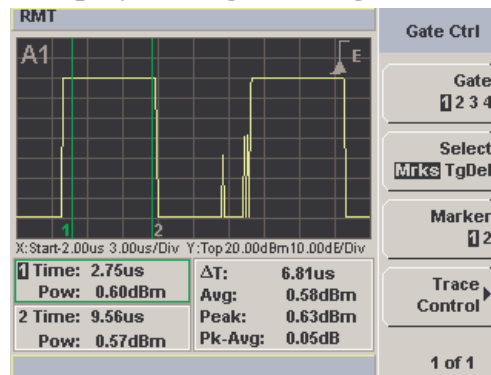

NOTE When you alter a parameter in another menu, you are returned to a two window display use the , , or  keys to highlight the trace measurement window and use the  key to enlarge the display.

NOTE If the bandwidth of a modulated signal is unknown you may discover, during the set up process, that a power sensor of lesser or greater bandwidth is required.

Setting the Trace Display

After you have completed this initial set up you can, if required, return to the following setup to improve your measurement results:

- The **Channel Setup** to configure any averaging and offsets.
- The **Trigger** setup to configure any additional setting there.
- The **Meas Setup** to configure any additional setting there.

Gate Control in a Single Enlarged Window

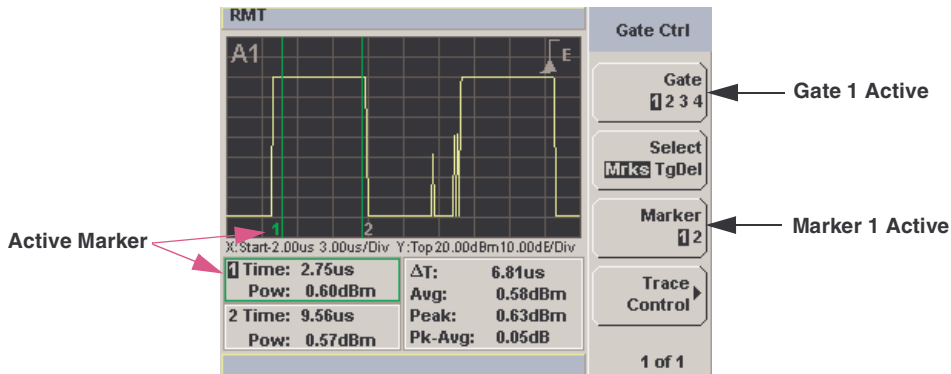

When you initially display a Single Enlarged Window the **Gate Control** menu is available. Setting the gate features are described in greater detail in “Setting Measurement Channel Gates” on page 46. However, the following sections are to give you an overview of the control and their impact on the displayed results.

Figure 3-4 Trace Display with Gate Control Menu



Gate Pressing **Gate** scrolls through the 4 gates available for each channel. The gate displayed is highlighted below the **Gate** softkey. It is also displayed in the channel/gate annotation in the top left of the screen.

Select Pressing **Select Mrks Tgdel** displays the gate markers or trigger markers.

Markers When **Mrks** is selected, markers **1** and **2** indicate the start and end points of the selected measurement gate. Pressing **Marker** toggles between the two markers, the highlighted marker is active. Use the  and  keys to move the markers left or right across the display.

The tables on the lower left of the screen show the time (**Time:**) and the instantaneous power level (**Pow:**) of the markers at their configured points. The table highlighted with the green border represents the active marker also highlighted in green. A negative time value indicates a measurement before the trigger point. (See Figure 3-4).



NOTE

Gate timing parameters are all related to your chosen trigger point. This may be different from the timing of the triggering event if you have configured a trigger delay.

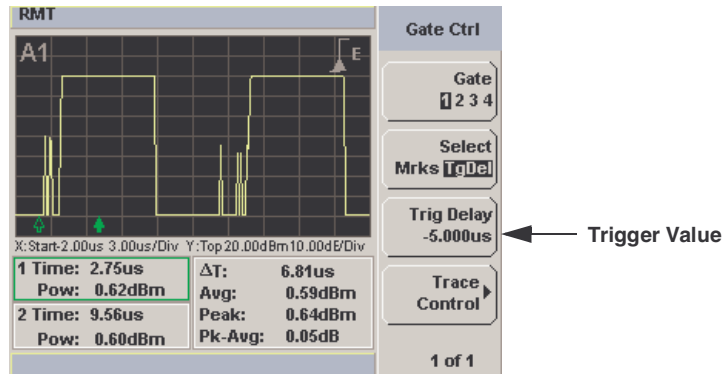

Figure 3-5 Trace Display with Trigger Delay Menu



Setting the Trace Display

TgDel When **TgDel** is selected you can adjust the trigger delay. The display changes to remove the gate markers and displays the trigger marker(s). The  indicates when the trigger event occurs, whilst  shows the delayed trigger point. When the two points coincide only the  trigger is shown.

The configured value is displayed below the **Trig Delay** softkey. This value is shown in Figure 3-5.

To indicate an off-screen trigger event,  is displayed. To indicate an off-screen trigger point,  is displayed.

NOTE

Your chosen trigger point is used as the reference point for the timing of all the measurement gates

Trig Delay The trigger delay value is shown below the **Trig Delay** softkey. You configure the trigger delay by pressing **Trig Delay** and entering a numeric value in the pop-up window.

Pressing **Select** highlights **Mrks** to display the trace markers again.

NOTE

You can also setup the trigger delay in the **Trigger** menu, by pressing **Settings**, **Delay** and entering a value in the pop-up window.

Trace Control Press **Trace Control** to display the **Trace Control** menu. Setting the trace features are described in greater detail in “Setting up the Channel Trace” on page 49.

Figure 3-6 Trace Display with Trace Control Menu

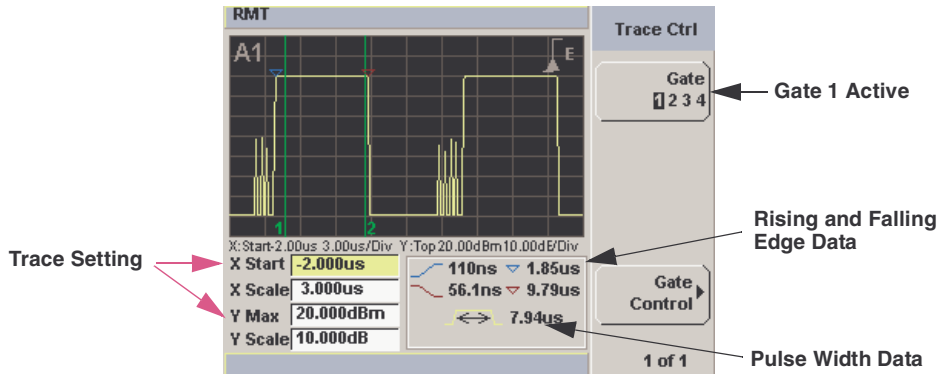

The fields on the lower left of the screen are the X and Y trace setup fields. Using the \uparrow or \downarrow keys you can highlight the item and change its value. (See Figure 3-6)

This table on the lower right of the screen show the 5 automatic time measurements performed on the first complete captured pulse after the trigger. The 5 measurements are rise time, fall time, time to positive occurrence, time to negative occurrence, and the pulse duration.

The current settings of the X and Y scale are displayed on the reporting line above both tables.

NOTE

If you are wanting to view the trace in linear mode, the **Trace Setup** is only location where you can change the Y-scale units from **dBm** to **Watts**, otherwise the default unit is log.

Gate Control Press **Gate Control** to display the **Gate Ctrl** menu and display and continue with the gate setup.

Setting the Trace Display

Viewing the Results in a Full Screen Window



Use the  key to display the trace in a full screen window display. This provides a better resolution on the display. You can press **Trace Meas** or **Gate Meas** to display the results as set in Single Enlarged Window mode. The current settings of the X and Y scale are displayed on the reporting line above the results. You need to toggle the  key to allow the softkeys to be displayed.

Figure 3-7 Trace Display in Full Screen



Improving the Accuracy with Additional Settings

You can now return to the setup menus and adjust the default setting to obtain greater measurement accuracy.

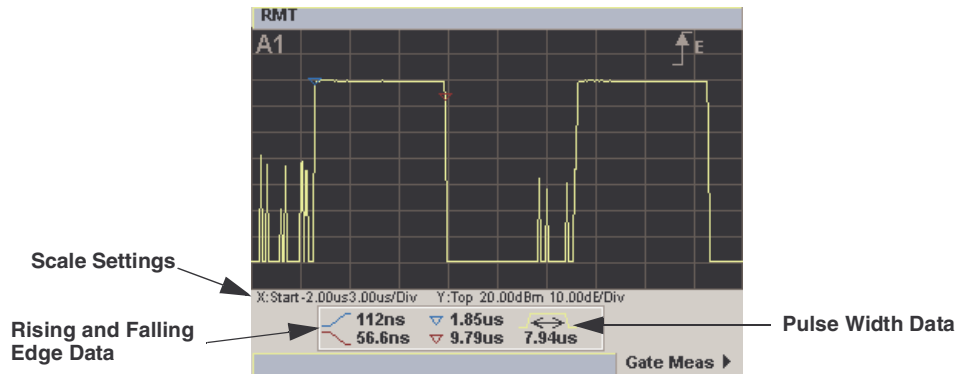
Channel Setup







- Press . The **Channel Setup** screen is displayed.
If using an N1912A, select the channel you want to configure.

Figure 3-8

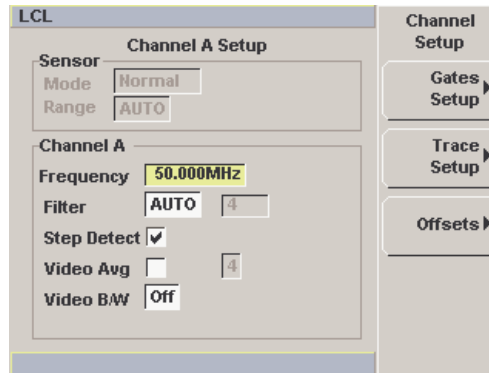
P-Series Power Sensor default Channel Setup



Use the , , , and  keys to highlight the setting field and press  to configure the setting. For further detail on setting these, refer the appropriate section.

- **Meas Avg:** “Setting Measurement Averaging” on page 38
- **Video Avg:** “Setting the Video Averaging” on page 41
- **Step Detect:** “Step Detection” on page 40
- **Video B/W:** “Setting the Video Bandwidth” on page 43

Setting the Trace Display

Setting Offsets Press **Offsets**. The **Offsets Setup** screen is displayed.

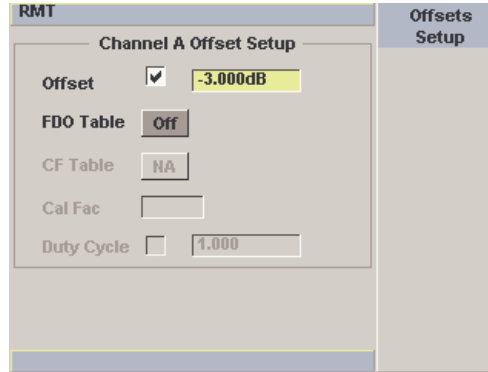
Figure 3-9**Channel Offset Display**

Use the , , , and  keys to highlight any parameters you want

to change. Press  to configure the required settings. For further detail on setting these, refer the appropriate section.

- **Offset:** “Setting Channel Offsets” on page 29
- **FDO Table:** “Setting Frequency Dependent Offsets” on page 32

Trigger Setup





Press . The **Trigger** menu is displayed.

The trigger status is displayed below the **Acqn** label in the **Trigger** menu.

Press the **Settings** softkey and add more accuracy to the remaining trigger parameters, for example, hold-off and hysteresis, to help you achieve a stable and reliable trigger. Hence, ensure the gates you have set up are capturing the required signal information. See “Setting the Trigger” on page 52 for further information.

Measurement Setup

Press . The **Measurement Setup** menu is displayed.

Use the , , , and  keys to highlight the setting field and press  to configure the setting.

When you have configured the measurements gates, you can assign the measurement feed and display the results in numeric formats. For example, dual numeric display with Gate 1 peak measurement minus Gate 3 peak measurement. Also, from this menu you can add offset or measurement limits. For further detail on setting these, refer the appropriate section.

- **Feed1/2** “Setting the Measurement Display” on page 61
- **Offset** “Setting Display Offsets” on page 31
- **Limits** “Setting Measurement Limits” on page 58

Display

Press . The **Display Form** menu is displayed.

Choose the display format to present the measurements results. The options, other than trace, are as follows:

Single Numeric If you need to configure the numeric format when using a P-Series sensor, refer to “Numeric Format” on page 62 for more detail.

Dual Numeric If you need to configure the numeric format when using a P-Series sensor, refer to “Numeric Format” on page 62 for more detail.

Analog If you need to configure the analog format when using a P-Series sensor refer to “Scaling the Analog Display” on page 67 for more detail.

Using P-Series Power Sensor

Setting the Trace Display

4 Maintenance

What You'll Find in This Chapter

This chapter describes the built in tests, error messages, and general maintenance. It contains these sections:

- Self Test on page 101
- Error Messages on page 105
- Operator Maintenance on page 117
- Contacting Agilent Technologies on page 119
- Returning Your Power Meter for Service on page 123
- Agilent Sales and Service Offices on page 125
- Erasing Memory Data on page 122

Self Test

The power meter has two self test modes:

- Power on self test - occurs automatically when you turn on the power meter.
- Troubleshooting mode - accessed via the front panel or remotely. The front panel softkey menu allows you to run individual tests, whereas the remote command runs a complete series of tests as listed in Remote Testing on page 103.

Power On Self Test

The power on self test is performed automatically when the power meter is turned on and takes approximately 10 seconds to complete.

As the power on self test occurs, the message Testing... appears next to the name of the test which is being performed. When each test is complete, the message Testing... is replaced by either the message Passed or Failed. If a failure occurs the message Power-up H/W Err appears. Any errors are also written to the error queue and can be

examined in the Errors screen by pressing , **Error List**.

Front Panel Selection of Self Tests

Press , **1 of 2**, **Service**, **Self Test** to access the Self Test menu consisting of the following:

- Instrument Self Test
- Keyboard
- Bitmaps Displays

Instrument Self Test

If **Self Test** is selected, the following tests are run: (These are the same tests which are run using the *TST? command.)

- Test Point Voltages
- Calibrator
- Fan
- Battery
- Channel Peak Path
- Channel DAP Check

As each test takes place, the name of the test is listed on the screen. While a test is running, the message Testing... appears beside the name of the test. As each stage of the test is completed, the Testing... message is replaced by either Passed or Failed.

Figure 4-1

Self Test Complete

RMT		Self Test
TEST	RESULT	
Test Point Voltages	Passed	
Calibrator	Passed	
Fan	Passed	
Battery	Passed	
ChA Peak Path	Passed	
ChA DAP Check	Passed	
ChB Peak Path	Passed	
ChB DAP Check	Passed	
		Done

When the test is complete, the result is displayed. Press **Done** to return to the **Service** menu.

If the self test failed, information about the failure is displayed on the screen.

Remote Testing

To invoke the remote self test, the IEEE 488.1 compliant standard command, *TST? is used. This command runs a full self test and returns one of the following codes:

- 0 - no tests failed
- 1 - one or more tests failed

The remote self test consists of the following tests:

The communications assembly is tested implicitly, in that the command will not be accepted or return a result unless the remote interface is functioning correctly.

Refer to Test Descriptions on page 104 if you require a description of each individual test.

When the *TST? command is executed, the screen is cleared. As each test takes place, the name of the test is listed on the screen. While a test is running, the message Testing... appears beside the name of the test. As each stage of the test is completed, the message Testing... is replaced by either the message Passed or Failed.

Test Descriptions

This section specifies what is actually checked by each of the tests. Some of the tests may only be applicable to one method of invocation (for example, from the front panel). If this is the case, it is specified in the test description. Most of the tests have an associated error message which is added to the error queue if the test fails. The exception to this is the bitmap display test. Refer to Error Messages on page 105 for more details.

Fan

This test confirms that the internal cooling fan is operating.

Calibrator

The reference calibrator is turned on (indicated by the POWER REF LED) and measured internally. A pass or fail result is returned.

Display

Three tests are available for the display: the display assembly, display RAM and bitmap display.

A read/write is performed on the display RAM. If the value which is written is read back correctly, a pass is recorded, otherwise a fail is recorded.

The liquid crystal display/ light emitting diode (LCD/LED) control circuits are tested by making separate voltage measurements via the multiplexer and digital signal processor. If the expected voltages are measured, a pass is recorded, otherwise a fail is recorded. The three circuits tested are the LCD contrast control, the LED brightness control, and the display temperature sensing diode.

Error Messages

Introduction

This section contains information about error messages. It explains how to read the power meter's error queue and lists all error messages and their probable causes.

When there is a hardware related problem, for example, a power sensor overload, the error message is displayed on the status line at the top of the display. In addition, the errors are also written to the error queue. If there are any errors in the error queue the front panel error indicator is displayed as shown in Figure 4-2.

Other errors can also be generated when the power meter is being operated over the remote interface. These errors also display the error indicator and are written to the error queue.

Figure 4-2

Error Indicator Position

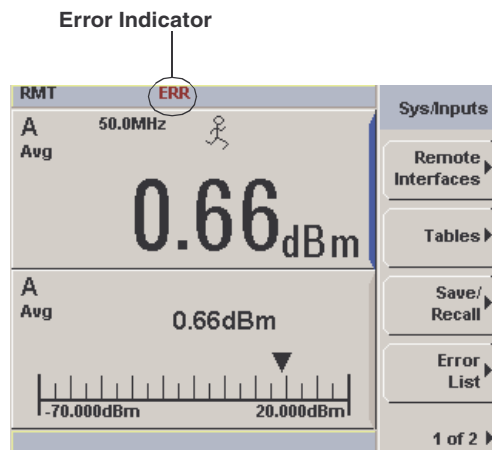

To read the error queue from the front panel:

- Press **System**, **1 of 2**, **Service**, **Error List** and use **Next** to scroll through each error message.

To read the error queue from the remote interface use:

Error Messages

- the `SYSTEM:ERROR?` command.

Error queue messages have the following format:

**Error Queue Message**

For example, -330, “Self-test Failed;Battery Fault”.

Errors are retrieved in a first in first out (FIFO) order. If more than 30 errors occur, the error queue overflows and the last error in the queue is replaced with error -350, “Queue Overflow”. Any time the queue overflows the most recent error is discarded.

When the errors are read they are removed from the error queue. This opens a position at the end of the queue for a new error message, if one is subsequently detected. When all errors have been read from the queue, further error queries return +0, “No errors”.

To delete all the errors in the queue from the front panel press:

- Press , **1 of 2**, **Service**, **Error List** and use **Clear Errors**.

To delete all the errors in the queue remotely use:

- the `*CLS` (clear status) command.

The error queue is also cleared when the instrument power has been switched off.

Error Message List

-101	<p>Invalid character An invalid character was found in the command string. You may have inserted a character such as #, \$, or % in the command header or within a parameter. For example, LIM:LOW O#.</p>
-102	<p>Syntax error Invalid syntax was found in the command string. For example, LIM:CLE:AUTO, 1 or LIM:CLE: AUTO 1.</p>
-103	<p>Invalid separator An invalid separator was found in the command string. You may have used a comma instead of a colon, semicolon, or blank space; or you may have used a blank space instead of a comma. For example, OUTP:ROSC,1.</p>
-105	<p>GET not allowed A Group Execute Trigger (GET) is not allowed within a command string.</p>
-108	<p>Parameter not allowed More parameters were received than expected for the command. You may have entered an extra parameter, or added a parameter to a command that does not accept a parameter. For example, CAL 10.</p>
-109	<p>Missing parameter Fewer parameters were received than expected for the command. You omitted one or more parameters that are required for this command. For example, AVER:COUN.</p>
-112	<p>Program mnemonic too long A command header was received which contained more than the maximum 12 characters allowed. For example, SENSEAVERageCOUNT 8.</p>

-113	<p>Undefined header A command was received that is not valid for this power meter. You may have misspelled the command, it may not be a valid command or you may have the wrong interface selected. If you are using the short form of the command, remember that it may contain up to four letters. For example, TRIG:SOUR IMM.</p>
-121	<p>Invalid character in number An invalid character was found in the number specified for a parameter value. For example, SENS:AVER:COUN 128#H.</p>
-123	<p>Exponent too large A numeric parameter was found whose exponent was larger than 32,000. For example, SENS:COUN 1E34000.</p>
-124	<p>Too many digits A numeric parameter was found whose mantissa contained more than 255 digits, excluding leading zeros.</p>
-128	<p>Numeric data not allowed A numeric value was received within a command which does not accept a numeric value. For example, MEM:CLE 24.</p>
-131	<p>Invalid suffix A suffix was incorrectly specified for a numeric parameter. You may have misspelled the suffix. For example, SENS:FREQ 200KZ.</p>
-134	<p>Suffix too long A suffix used contained more than 12 characters. For example, SENS:FREQ 2MHZZZZZZZZZZZZ.</p>
-138	<p>Suffix not allowed A suffix was received following a numeric parameter which does not accept a suffix. For example, INIT:CONT 0Hz.</p>

-148	<p>Character data not allowed A discrete parameter was received but a character string or a numeric parameter was expected. Check the list of parameters to verify that you have used a valid parameter type. For example, MEM:CLE CUSTOM_1.</p>
-151	<p>Invalid string data An invalid string was received. Check to see if you have enclosed the character string in single or double quotes. For example, MEM:CLE "CUSTOM_1".</p>
-158	<p>String data not allowed A character string was received but is not allowed for the command. Check the list of parameters to verify that you have used a valid parameter type. For example, LIM:STAT 'ON'.</p>
-161	<p>Invalid block data A block data element was expected but was invalid for some reason. For example, *DDT #15FET. The 5 in the string indicates that 5 characters should follow, whereas in this example there are only 3.</p>
-168	<p>Block data not allowed A legal block data element was encountered but not allowed by the power meter at this point. For example SYST:LANG #15FETC?.</p>
-178	<p>Expression data not allowed A legal expression data was encountered but not allowed by the power meter at this point. For example SYST:LANG (5+2).</p>
-211	<p>Trigger ignored Indicates that <GET> or *TRG, or TRIG:IMM was received and recognized by the device but was ignored because the power meter was not in the wait for trigger state.</p>

-213	<p>Init ignored Indicates that a request for a measurement initiation was ignored as the power meter was already initiated.</p> <p>For example, INIT:CONT ON INIT.</p>
-214	<p>Trigger deadlock TRIG:SOUR was set to HOLD or BUS and a READ? or MEASure? was attempted, expecting TRIG:SOUR to be set to IMMEDIATE.</p>
-220	<p>Parameter error;Frequency list must be in ascending order.</p> <p>Indicates that the frequencies entered using the MEMory:TABLE:FREQuency command are not in ascending order.</p>
-221	<p>Settings conflict This message occurs under a variety of conflicting conditions. The following list gives a few examples of where this error may occur:</p> <p>If the READ? parameters do not match the current settings.</p> <p>If you are in fast mode and attempting to switch on for example, averaging, duty cycle or limits.</p> <p>Trying to clear a sensor calibration table when none is selected.</p>
-222	<p>Data out of range A numeric parameter value is outside the valid range for the command. For example, SENS:FREQ 2KHZ.</p>
-224	<p>Illegal parameter value A discrete parameter was received which was not a valid choice for the command. You may have used an invalid parameter choice. For example, TRIG:SOUR EXT.</p>
-226	<p>Lists not same length This occurs when SENSE:CORRection:CSET[1] CSET2:STATe is set to ON and the frequency and calibration/offset lists do not correspond in length.</p>

-230	<p>Data corrupt or stale This occurs when a FETC? is attempted and either a reset has been received or the power meter state has changed such that the current measurement is invalidated (for example, a change of frequency setting or triggering conditions).</p>
-230	<p>Data corrupt or stale;Please zero and calibrate Channel A When CAL[1 2]:RCAL is set to ON and the sensor currently connected to channel A has not been zeroed and calibrated, then any command which would normally return a measurement result (for example FETC?, READ?, or MEAS?) will generate this error message.</p>
-230	<p>Data corrupt or stale;Please zero and calibrate Channel B When CAL[1 2]:RCAL is set to ON and the sensor currently connected to channel B has not been zeroed and calibrated, then any command which would normally return a measurement result (for example FETC?, READ?, or MEAS?) will generate this error message.</p>
-230	<p>Data corrupt or stale;Please zero Channel A When CAL[1 2]:RCAL is set to ON and the sensor currently connected to channel A has not been zeroed, then any command which would normally return a measurement result (for example FETC?, READ?, or MEAS?) will generate this error message.</p>
-230	<p>Data corrupt or stale;Please zero Channel B When CAL[1 2]:RCAL is set to ON and the sensor currently connected to channel B has not been zeroed, then any command which would normally return a measurement result (for example FETC?, READ?, or MEAS?) will generate this error message</p>
-230	<p>Data corrupt or stale;Please calibrate Channel A When CAL[1 2]:RCAL is set to ON and the sensor currently connected to channel B has not been calibrated, then any command which would normally return a measurement result (for example FETC?, READ?, or MEAS?) will generate this error message</p>

-230	Data corrupt or stale;Please calibrate Channel B When CAL[1 2]:RCAL is set to ON and the sensor currently connected to channel B has not been calibrated, then any command which would normally return a measurement result (for example FETC?, READ?, or MEAS?) will generate this error message
-231	Data questionable;CAL ERROR Power meter calibration failed. The most likely cause is attempting to calibrate without applying a 1 mW power to the power sensor.
-231	Data questionable;CAL ERROR ChA Power meter calibration failed on channel A. The most likely cause is attempting to calibrate without applying a 1 mW power to the power sensor.
-231	Data questionable;CAL ERROR ChB Power meter calibration failed on channel B. The most likely cause is attempting to calibrate without applying a 1 mW power to the power sensor.
-231	Data questionable;Input Overload The power input to Channel A exceeds the power sensor's maximum range.
-231	Data questionable;Input Overload ChA The power input to Channel A exceeds the power sensor's maximum range.
-231	Data questionable;Input Overload ChB The power input to Channel B exceeds the power sensor's maximum range.
-231	Data questionable;Lower window log error This indicates that a difference measurement in the lower window has given a negative result when the units of measurement were logarithmic.

-231	Data questionable;Upper window log error This indicates that a difference measurement in the upper window has given a negative result when the units of measurement were logarithmic.
-231	Data questionable;ZERO ERROR Power meter zeroing failed. The most likely cause is attempting to zero when some power signal is being applied to the power sensor.
-231	Data questionable;ZERO ERROR ChA Power meter zeroing failed on channel A. The most likely cause is attempting to zero when some power signal is being applied to the power sensor.
-231	Data questionable;ZERO ERROR ChB Power meter zeroing failed on channel B. The most likely cause is attempting to zero when some power signal is being applied to the power sensor.
-241	Hardware missing The power meter is unable to execute the command because either no power sensor is connected or it expects an E-series power sensor and one is not connected.
-310	System error;Dty Cyc may impair accuracy with ECP sensor This indicates that the sensor connected is for use with CW signals only.
-310	System error;Ch A Dty Cyc may impair accuracy with ECP sensor This indicates that the sensor connected to channel A is for use with CW signals only.
-310	System error;Ch B Dty Cyc may impair accuracy with ECP sensor This indicates that the sensor connected to channel B is for use with CW signals only.
-310	System error;Sensor EEPROM Read Failed - critical data not found or unreadable This indicates a failure with your E-series power sensor. Refer to your power sensor manual for details on returning it for repair.

-310	System error;Sensor EEPROM Read Completed OK but optional data block(s) not found or unreadable This indicates a failure with your E-series power sensor. Refer to your power sensor manual for details on returning it for repair.
-310	System error;Sensor EEPROM Read Failed - unknown EEPROM table format This indicates a failure with your E-series power sensor. Refer to your power sensor manual for details on returning it for repair.
-310	System error;Sensor EEPROM < > data not found or unreadable Where < > refers to the sensor data block covered, for example, Linearity, Temp - Comp (temperature compensation). This indicates a failure with your E-series power sensor. Refer to your power sensor manual for details on returning it for repair.
-310	System error;Sensors connected to both front and rear inputs. You cannot connect two power sensors to the one channel input. In this instance the power meter detects power sensors connected to both it's front and rear channel inputs.
-321	Out of memory The power meter required more memory than was available to run an internal operation.
-330	Self-test Failed; The -330, "Self-test Failed" errors indicate that you have a problem with your power meter. Refer to Contacting Agilent Technologies on page 119 for details of what to do with your faulty power meter.
-330	Self-test Failed;Measurement Channel Fault
-330	Self-test Failed;Measurement Channel A Fault
-330	Self-test Failed;Measurement Channel B Fault

-330	Self-test Failed;Calibrator Fault Refer to “Calibrator” on page 104 if you require a description of the calibrator test.
-330	Self-test Failed;ROM Check Failed
-330	Self-test Failed;RAM Check Failed
-330	Self-test Failed;Display Assy. Fault Refer to “Display” on page 104 if you require a description of the Display test.
-350	Queue overflow The error queue is full and another error has occurred which could not be recorded.
-361	Parity error in program The serial port receiver has detected a parity error and consequently, data integrity cannot be guaranteed.
-362	Framing error in program The serial port receiver has detected a framing error and consequently, data integrity cannot be guaranteed.
-363	Input buffer overrun The serial port receiver has been overrun and consequently, data has been lost.
-410	Query INTERRUPTED A command was received which sends data to the output buffer, but the output buffer contained data from a previous command (the previous data is not overwritten). The output buffer is cleared when power has been off, or after *RST (reset) command has been executed.

-
- 420 **Query UNTERMINATED**
The power meter was addressed to talk (that is, to send data over the interface) but a command has not been received which sends data to the output buffer. For example you may have executed a CONFIGure command (which does not generate data) and then attempted to read data from the remote interface.
-
- 430 **Query DEADLOCKED**
A command was received which generates too much data to fit in the output buffer and the input buffer is also full. Command execution continues but data is lost.
-
- 440 **Query UNTERMINATED after indefinite response**
The *IDN? command must be the last query command within a command string.

Operator Maintenance

This section describes how to replace the power line fuse and clean the power meter. If you need additional information about replacing parts or repairing the power meter, refer to the P-series power meter Service Guide.

To clean the power meter, disconnect its supply power and wipe with a damp cloth only.

The power line fuse is located within the power meter's fuse holder assembly on the rear panel. For all voltages the power meter uses a 250 V, F3.15AH, 20mm fast blow fuse with high breaking capacity (Agilent part number 2110-0957).

NOTE

The power meter also has an internal fuse. If you suspect that this fuse needs replaced it must be done by trained service personnel. Please refer to “Returning Your Power Meter for Service” on page 123.

Replacing the Power Line Fuse

1. Slide the fuse holder assembly from the rear panel as shown in Figure 4-3.
2. Install the correct fuse in the “In line” position as shown in Figure 4-3. (A spare fuse can be stored in the fuse holder assembly.)
3. Replace the fuse holder assembly in the rear panel.

Figure 4-3 Replacing the Fuse

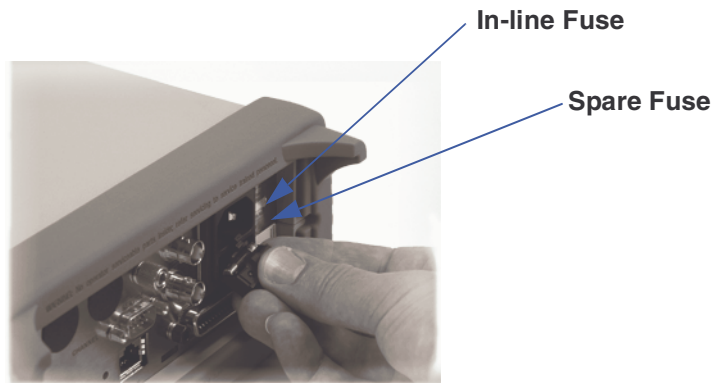

Contacting Agilent Technologies

This section details what to do if you have a problem with your power meter.

If you have a problem with your power meter, first refer to the section “Before calling Agilent Technologies”. This chapter contains a checklist that will help identify some of the most common problems.

If you wish to contact Agilent Technologies about any aspect of the power meter, from service problems to ordering information, refer to “Agilent Sales and Service Offices” on page 125.

If you wish to return the power meter to Agilent Technologies refer to “Returning Your Power Meter for Service” on page 123.

Before calling Agilent Technologies

Before calling Agilent Technologies or returning the power meter for service, please make the checks listed in “Check the Basics” on page 119. If you still have a problem, please read the warranty printed at the front of this guide. If your power meter is covered by a separate maintenance agreement, please be familiar with the terms.

Agilent Technologies offers several maintenance plans to service your power meter after warranty expiration. Call your Agilent Technologies Sales and Service Center for full details.

If the power meter becomes faulty and you wish to return the faulty instrument, follow the description on how to return the faulty instrument in the section Contacting Agilent Technologies on page 119.

Check the Basics

Problems can be solved by repeating what was being performed when the problem occurred. A few minutes spent in performing these simple checks may eliminate time spent waiting for instrument repair. Before calling Agilent Technologies or returning the power meter for service, please make the following checks:

- Check that the line socket has power.
- Check that the power meter is plugged into the proper ac power

source.

- Check that the power meter is switched on.
- Check that the line fuse is in working condition.
- Check that the other equipment, cables, and connectors are connected properly and operating correctly.
- Check the equipment settings in the procedure that was being used when the problem occurred.
- Check that the test being performed and the expected results are within the specifications and capabilities of the power meter.
- Check the power meter display for error messages.
- Check operation by performing the self tests.
- Check with a different power sensor.

Instrument serial numbers

Agilent Technologies makes frequent improvements to its products to enhance their performance, usability and reliability. Agilent Technologies service personnel have access to complete records of design changes for each instrument. The information is based on the serial number and option designation of each power meter.

Whenever you contact Agilent Technologies about your power meter have a complete serial number available. This ensures you obtain the most complete and accurate service information. The serial number can be obtained by:

- interrogating the power meter over the remote interface using the *IDN? command.
- from the front panel by pressing  , 1 of 2, **Service** , **Version** .
- from the serial number label.

The serial number label is attached to the rear of each Agilent Technologies instrument. This label has two instrument identification entries. The first provides the instruments serial number and the second provides the identification number for each option built into the instrument.

The serial number is divided into two parts: the prefix (two letters and the first four numbers), and the suffix (the last four numbers).

- The prefix letters indicate the country of manufacture. This code is based on the ISO international country code standard, and is used to designate the specific country of manufacture for the individual product. The same product number could be manufactured in two different countries. In this case the individual product serial numbers would reflect different country of manufacture codes. The prefix also consists of four numbers. This is a code identifying the date of the last major design change.
- The suffix indicates an alpha numeric code which is used to ensure unique identification of each product throughout Agilent Technologies.

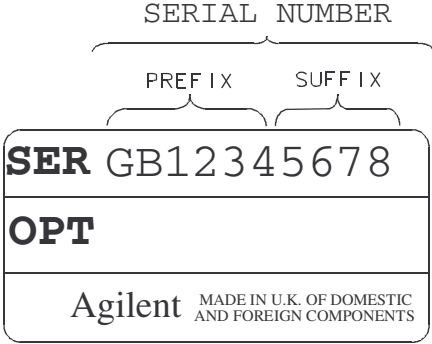

Erasing Memory Data

If you need to erase the P-series power meter's memory, for example, before you return it to Agilent Technologies for repair or calibration, of all data stored in it.

The memory data erased, includes the save/recall states and power on last states.

The following procedure explains how to do this.

1. Press the  key.
2. Press **1 of 2**.
3. Press **Service**.
4. Press **Secure Erase**.
5. If you are sure, press the **Confirm** key.
6. A pop-up appears, as shown in Figure 4-4 informing you of the status of the procedure.

Figure 4-4 Secure Erase Status Pop-up



Returning Your Power Meter for Service

Use the information in this section if you need to return your power meter to Agilent Technologies.

Package the Power Meter For Shipment

Use the following steps to package the power meter for shipment to Agilent Technologies for service:

- Fill in a blue service tag (available at the end of this guide) and attach it to the power meter. Please be as specific as possible about the nature of the problem. Send a copy of any or all of the following information:
 - Any error messages that appeared on the power meter display.
 - Any information on the performance of the power meter.

CAUTION

Power meter damage can result from using packaging materials other than those specified. Never use styrene pellets in any shape as packaging materials. They do not adequately cushion the power meter or prevent it from shifting in the carton. Styrene pellets cause power meter damage by generating static electricity and by lodging in the rear panel.

-
- Use the original packaging materials or a strong shipping container that is made of double-walled, corrugated cardboard with 159 kg (350 lb) bursting strength. The carton must be both large enough and strong enough to accommodate the power meter and allow at least 3 to 4 inches on all sides of the power meter for packing material.

Returning Your Power Meter for Service

- Surround the power meter with at least 3 to 4 inches of packing material, or enough to prevent the power meter from moving in the carton. If packing foam is not available, the best alternative is SD-240 Air Cap™ from Sealed Air Corporation (Commerce, CA 90001). Air Cap looks like a plastic sheet covered with 1-1/4 inch air filled bubbles. Use the pink Air Cap to reduce static electricity. Wrap the power meter several times in the material to both protect the power meter and prevent it from moving in the carton.
- Seal the shipping container securely with strong nylon adhesive tape.
- Mark the shipping container “FRAGILE, HANDLE WITH CARE” to ensure careful handling.
- Retain copies of all shipping papers.

Agilent Sales and Service Offices

In any correspondence or telephone conversations, refer to the power meter by its model number and full serial number. With this information, the Agilent representative can quickly determine whether your unit is still within its warranty period.

UNITED STATES	Agilent Technologies (tel) 1 800 829 4444
CANADA	Agilent Technologies Canada Inc. Test & Measurement (tel) 1 877 894 4414
EUROPE	Agilent Technologies Test & Measurement European Marketing Organization (tel) (31 20) 547 2000
JAPAN	Agilent Technologies Japan Ltd. (tel) (81) 426 56 7832 (fax) (81) 426 56 7840
LATIN AMERICA	Agilent Technologies Latin America Region Headquarters, USA (tel) (305) 267 4245 (fax) (305) 267 4286
AUSTRALIA and NEW ZEALAND	Agilent Technologies Australia Pty Ltd. (tel) 1-800 629 4852 (Australia) (fax) (61 3) 9272 0749 (Australia) (tel) 0-800 738 378 (New Zealand) (fax) (64 4) 802 6881 (New Zealand)
ASIA PACIFIC	Agilent Technologies, Hong Kong (tel) (852) 3197 7777 (fax) (852) 2506 9284

You can visit our website: - <http://www.agilent.com/find/assist>.

Maintenance

Agilent Sales and Service Offices

5**Specifications and
Characteristics**

What You'll Find in This Chapter

This Chapter describes the specifications and characteristics of your P-Series Power Meter.

It contains the following sections:

- Power Meter Specifications on page 131
- Measurement Characteristics on page 134
- Environmental Conditions on page 139
- Regulatory Information on page 141
- System Specifications and Characteristics on page 142

Introduction

This chapter details the P-Series Power Meters's specifications and supplemental characteristics. Information contained in this chapter refers to operation with P-Series Wideband Power Sensors.

Specification Definitions

There are two types of product specifications:

- Warranted specifications
- Characteristic specifications

Warranted specifications

Warranted specifications are covered by the product warranty and apply over 0°C to 55°C, unless otherwise noted. Warranted specifications include Measurement Uncertainty calculated with 95% confidence.

Characteristic specifications

Characteristic specifications are not warranted. They describe product performance that is useful in the application of the power sensors by giving typical, but non-warranted performance parameters. These characteristics are shown in *italics* or denoted as “*typical*”, “*nominal*” or “*approximate*”.

Characteristic information is representative of the product. In many cases, it may also be supplemental to a warranted specification. Characteristic specifications are not verified on all power sensors. The types of characteristic specifications can be placed in two groups:

- The first group of characteristic types describes 'attributes' common to all products of a given model or option.

Examples of characteristics that describe 'attributes' are product weight, and 50ohm input Type-N connector. In these examples product weight is an *approximate* value and a 50ohm input is *nominal*. These two terms are most widely used when describing a product's 'attributes'.

Introduction

- The second group of characteristic types describes 'statistically' the aggregate performance of the population of products.

These characteristics describe the expected behavior of the population of products. They do not guarantee the performance of any individual product. No measurement uncertainty value is accounted for in the specification. These specifications are referred to as *typical*.

Conditions

The power meter and sensor meet its specifications when:

- Stored for a minimum of two hours at a stable temperature within the operating temperature range, and turned on for at least 30 minutes.
- The power meter and power sensor are within their recommended calibration periods.
- Used in accordance to the information provided in the Power Meter's User's Guide.

Measurement uncertainties

For information on measurement uncertainty calculations, refer to Agilent Application Note 64-1 “Fundamentals of RF and Microwave Power Measurements”, Literature Number 5965-6380E.

Power Meter Specifications

Number of Channels

- N1911A P-Series power meter, single channel
- N1912A P-Series power meter, dual channel

Frequency Range

- N1921A P-Series wideband power sensor, 50 MHz to 18 GHz
- N1922A P-Series wideband power sensor, 50 MHz to 40 GHz

Dynamic Range

- -35 dBm to +20 dBm (> 500 MHz)
- -30 dBm to +20 dBm (50 MHz - 500 MHz)

Measurements

The following power measurements are provided with free-run or time gated definition.

- Average
- Peak
- Peak-to-Average

Time parameter measurements of pulse rise time, fall time, pulse width, time to positive occurrence and time to negative occurrence are also provided.

Power Sensors Compatibility

P-Series power meters are compatible with all Agilent P-Series Wideband Power Sensors.

The P-Series Power Meters also operates with the existing 8480 series and E-series (E4410, E9300, and E9320) ranges of power sensors.¹

Meter Uncertainty

Instrumentation Linearity	±0.8%
---------------------------	-------

Average Power Measurement Accuracy²

- N1921A: $\leq \pm 0.2$ dB or $\pm 4.5\%$
- N1922A: $\leq \pm 0.3$ dB or $\pm 6.7\%$

1. For specifications when using an 8480 and E-series sensors (except E9320A range), refer to Lit Number 5965-6382E. For specifications when using an E932XA sensors, refer to Lit Number 5980-1469E.
2. Specification is valid over -15 to +20 dBm, and a frequency range 0.5 to 10 GHz, DUT Max. SWR < 1.27 for the N1921A, and a frequency range 0.5 to 40 GHz, DUT Max. SWR < 1.2 for the N1922A. Averaging set to 32, in Free Run mode.

Remote Programming

Interface:	<p>GPIB interface operates to IEEE 488.2 and IEC-625.</p> <p>10/100BaseT Lan Interface.</p> <p>USB 2.0 Interface.</p>
Command Language:	SCPI standard interface commands ^a
GPIB Compatibility:	SH1, AH1, T6, TE0, L4, LE0, SR1, RL1, PP1, DC1, DT1, C0

a. The P-Series Power Meters are not compatible with the 436A, 437B, or the 438A power meter command sets.

Timebase

Timebase Range	<i>2 ns to 100 msec/div</i>
Accuracy	± 10 ppm
Jitter	≥ 1 ns

Bandwidth

Video Bandwidth	≥ 30 MHz
Single Shot Bandwidth	≥ 30 MHz

NOTE

The video bandwidth represents the ability of the power sensor and meter to follow the power envelope of the input signal. The power envelope of the input signal is, in some cases, determined by the signal's modulation bandwidth, hence, video bandwidth is sometimes referred to as modulation bandwidth.

Measurement Characteristics

Trigger

Internal Trigger	Range: - 20 to +20 dBm Resolution: 0.1dB Level Accuracy: ±0.5 dB Latency: ^a 160ns±10ns Jitter: ≤5 ns rms
External TTL Trigger Input	High: >2.4V Low: <0.7V Latency: ^a 90ns±10ns Minimum trigger pulse width: 15ns Minimum trigger repetition period: 50ns Impedance: 50Ω Jitter: ≤5ns rms
External TTL Trigger Output	<i>Low to High transition on trigger event.</i> High: >2.4V Low: <0.7V Latency: ^a 30ns ±10ns Impedance: 50Ω Jitter: ≤5 ns rms
Trigger Delay	Delay range: ±1.0 s, maximum Delay resolution: 1% of delay setting <i>(10 ns maximum)</i>
Trigger Hold-off	Range: 1 μs to 400 ms Resolution: 1% of selected value <i>(to a minimum of 10 ns)</i>
Trigger Level Threshold Hysteresis	Range: ±3dB Resolution: 0.05dB

a. Latency is defined as the delay between the applied RF crossing the trigger level and the power meter switching into the triggered state.

Measurement Speed

Measurement speed using remote interface	≥ 1500 readings per second
--	---------------------------------

Pulse Characteristic

These pulse characteristics are only applicable when a P-series wideband sensor is used.

Rise Time and Fall Time	≤ 13 ns ^{ab}
Minimum Pulse Width	50 ns ^c
Overshoot	$\leq 5\%$
Maximum Pulse Repetition Rate	10 MHz ^d

- a. Applies to frequencies >500 MHz (See Figure 5-1).
- b. Applies only when the video bandwidth selected is Off.
- c. The Minimum Pulse Width is the recommended minimum pulse width viewable on the power meter, where power measurements are meaningful and accurate, but not warranted.
- d. Based on 10 samples per period

Maximum Sample Rate and Capture Length

Maximum Sampling Rate	100 Msamples / second, continuous sampling
Maximum Capture Length	1 second

Figure 5-1 Measured Rise Time Percentage Error Versus Signal Under Test Rise Time

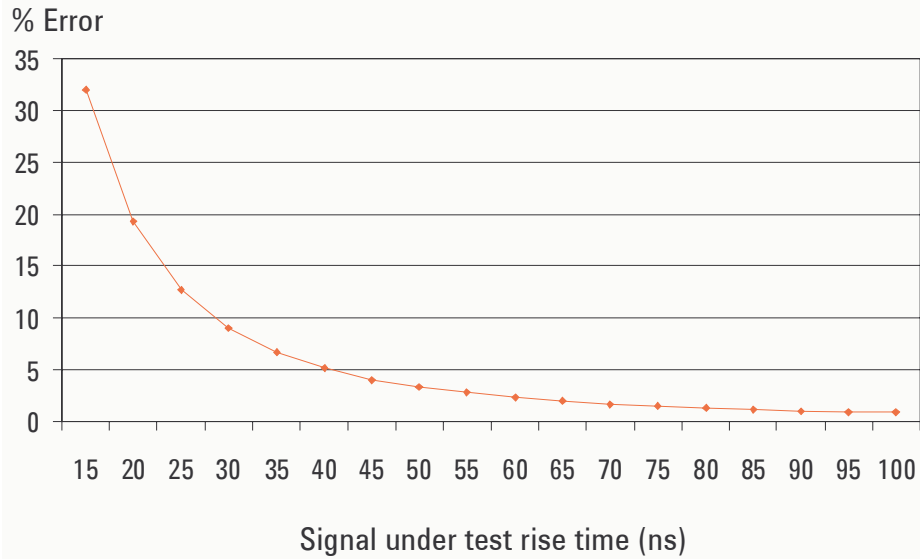

Although the rise time specification is ≤ 13 ns, this does not mean that the P-Series meter and sensor combination can accurately measure a signal with a known rise time of 13 ns. The measured rise time is the root sum of the squares (RSS) of the signal under test rise time and the system rise time (13 ns).

Equation 5-1 Measured Rise Time

$$\sqrt{((SignalUnderTestRiseTime)^2 + (SystemRiseTime)^2)}$$

Equation 5-2 Percentage Error

$$\frac{(MeasuredRiseTime - SignalUnderTestRiseTime)}{(SignalUnderTestRiseTime) \times 100}$$

Rear Panel Inputs and Output Connections

Recorder Output(s):^a	Analog 0 to 1 V, 1 k Ω output impedance, BNC connector.
GPIB USB 2.0 10/100BaseT LAN	Interfaces allow communication with an external controller.
Trigger Input:	Input has TTL compatible logic levels and uses a BNC connector.
Trigger Out:	Output provides TTL compatible logic levels and uses a BNC connector
Ground:	Binding post, accepts 4mm plug or bare wire connection

- a. Two recorder outputs are available on the dual channel N1912A P-Series Power Meter.

Line Power

Input Voltage Range:	90 to 264 Vac, automatic selection
Input Frequency Range:	47 to 63 Hz and 440 Hz
Power Requirement:	50VA (30 Watts) (N1912A: not exceeding 75 VA (50 Watts))

1 mW Power Reference

NOTE

The 1mW Power Reference is provided for calibration of the E-series and the 8480 series power sensors. The P-Series sensors are automatically calibrated, hence, do not need this power reference for calibration

Power Output:	1.00 mW (0.0 dBm). Factory set to $\pm 0.4\%$ traceable to the National Physical Laboratories (NPL), UK
Accuracy: (over 2-years)	$\pm 0.9\%$ (0 - 55°C) $\pm 0.5\%$ (25 \pm 10°C)
Frequency:	50 MHz nominal
SWR:	1.10 (0 - 55°C) 1.09 (25 \pm 10°C) 1.08 (23 \pm 3°C) 1.05 typical
Connector Type:	Type N (f), 50 ohms

Environmental Conditions

General

Complies with the requirements of the EMC Directive 89/336/EEC.

Operating Environment

Temperature:	0°C to 55°C
Maximum Humidity:	95% at 40°C (non-condensing)
Minimum Humidity:	15% at 40°C (non-condensing)
Maximum Altitude:	3,000 meters (9,840 feet)

Storage Conditions

Non-Operating Storage Temperature:	-40°C to +70°C
Non-Operating Maximum Humidity:	90% at 65°C (non-condensing)
Non-Operating Maximum Altitude:	15,240 meters (50,000 feet)

Physical Characteristics

Dimensions

The following dimensions exclude front and rear panel protrusions:

- 88.5 mm H x 212.6 mm W x 348.3 mm D (3.5 in x 8.5 in x 13.7 in)

Weight

Weight (Net):	<i>N1911A: ≤3.5 kg (7.7 lb) approximately</i>
	<i>N1912A: ≤3.7 kg (8.1 lb) approximately</i>
Weight (Shipping):	<i>N1911A: ≤7.9 kg (17.4 lb) approximately</i>
	<i>N1912A: ≤8.0 kg (17.6 lb) approximately</i>

Regulatory Information

Electromagnetic Compatibility

This product complies with the protection requirements of European Council Directive 89/336/EEC for Electromagnetic Compatibility (EMC).

The conformity assessment requirements have been met using the technical construction file route to compliance, using EMC test specifications EN 55011:1991 (Group 1, Class A) and EN 50082-1:1992. In order to preserve the EMC performance of the product, any cable which becomes worn or damaged must be replaced with the same type and specification.

The product also meets the following EMC standards

- Australia/New Zealand: AS/NZS 2064.1
- Canada: ICES-001:1998

Product Safety

This product conforms to the requirements of the following safety standards:

- EN61010-1: 2001 / IEC 61010-1:2001
- Canada: CSA C22.2 No. 1010-1:1993
- IEC 60825-1:1993/A2:2001
- IEC 60825-1:1993+A1:1997+A2:2001

Low Voltage Directive

This product conforms to the requirements of European Council Directive 73/23/EEC.

System Specifications and Characteristics

The video bandwidth in the meter can be set to High, Medium, Low and Off. The video bandwidths stated in the table below are not the 3 dB bandwidths, as the video bandwidths are corrected for optimal flatness (except the Off filter). Refer to Figure 5-2 for information on the flatness response of the High, Medium, Low and Off filters. The Off video bandwidth setting provides the warranted rise time and fall time specification and is the recommended setting for minimizing overshoot on pulse signals.

Rise Time, Fall Time, and Overshoot versus Video Bandwidth Settings

Parameter	Video Bandwidth Setting				
	Low: 5 MHz	Medium: 15 MHz	High: 30 MHz	Off	
				< 500MHz	> 500MHz
Rise Time/ Fall Time ^a	< 56 ns	< 25 ns	≤ 13 ns	< 36 ns	≤ 13 ns
Overshoot ^b	-	-	-	< 5%	< 5%

- a. Specified as 10% to 90% for rise time and 90% to 10% for fall time on a 0 dBm pulse.
b. Specified as the overshoot relative to the settled pulse top power.

NOTE For option 107 (10m cable), add 5 ns to the rise time and fall time specifications.

Characteristic Peak Flatness

The peak flatness is the flatness of a peak-to-average ratio measurement for various tone-separations for an equal magnitude two-tone RF input. Figure 2 refers to the relative error in peak-to-average ratio measurements as the tone separation is varied. The measurements were performed at -10 dBm with power sensors with 1.5m cable lengths.

Figure 5-2 P-Series Sensor Error in Peak-to-Average Measurements for a Two-Tone Input

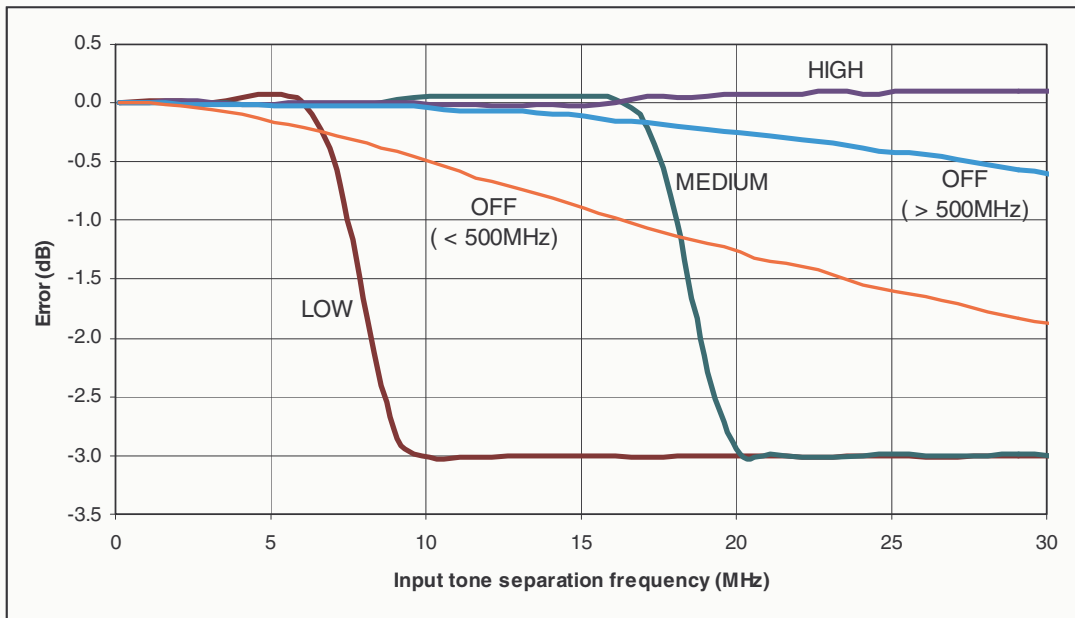

Noise and Drift

Sensor Model	Zeroing	Zero Set		Zero Drift ^a	Noise per Sample	Measurement Noise (Free Run) ^b
		<500MHz	> 500MHz			
N1921A/ N1922A	No RF at input	200 nW		100 nW	2 μ W	50 nW
	RF Present	550 nW	200 nW			

- a. Within 1 hour after a zero, at a constant temperature, after 24 hour warm-up of the power meter. This component can be disregarded with Auto-zero mode set to ON.
- b. Measured over a one-minute interval, at a constant temperature, two standard deviations, with averaging set to 1.

Measurement Average Setting	1	2	4	8	16	32	64	128	256	512	1024
Free Run Noise Multiplier	1	0.9	0.8	0.7	0.6	0.5	0.45	0.4	0.3	0.25	0.2

Video BW setting		Low 5 MHz	Medium 15 MHz	High 30 MHz	Off
Noise per Sample Multiplier	< 500 MHz	0.5	1	2	1
	\geq 500 MHz	0.45	0.75	1.1	1

Effect of Video Bandwidth Setting:

The noise per sample is reduced by applying the meter video bandwidth filter setting (High, Medium or Low). If averaging is implemented, this will dominate any effect of changing the video bandwidth.

Effect of time-gating on measurement noise

The measurement noise on a time-gated measurement depends on the time gate length. 100 averages are carried out every 1 us of gate length. The Noise-per-Sample contribution in this mode can approximately be reduced by $\sqrt{(\text{gate length} / 10\text{ns})}$ to a limit of 50nW.