

# Agilent Infiniium 90000 X-Series Oscilloscopes

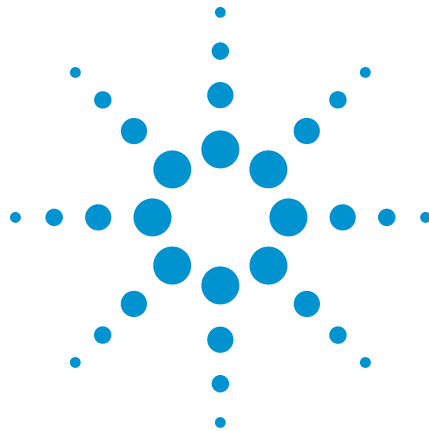

Data Sheet

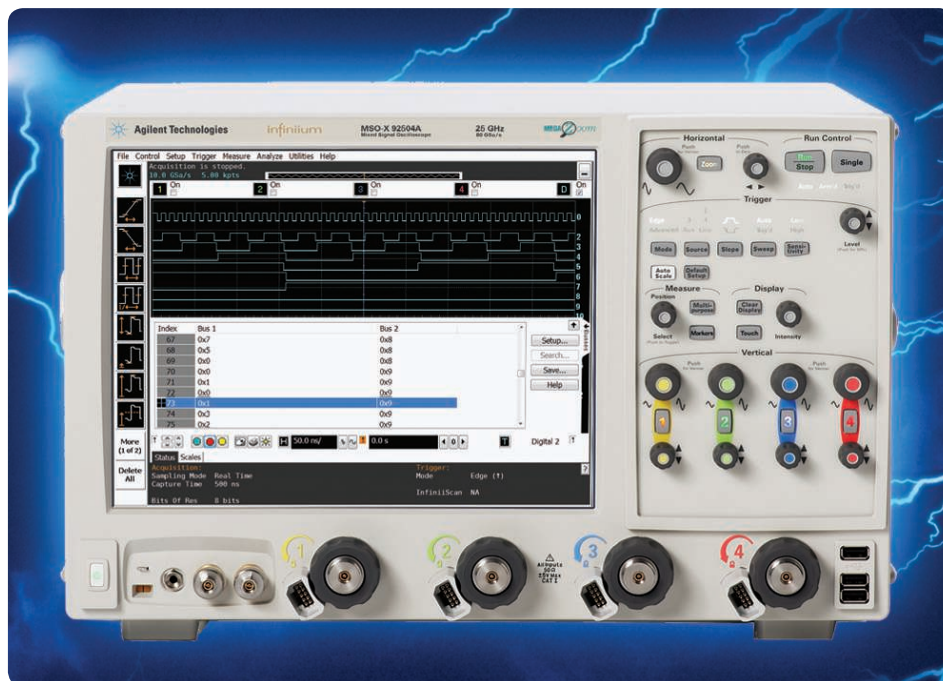

**Combining deep logic analysis with the industry's highest performance oscilloscope**

**Featuring the world's fastest mixed signal oscilloscope**

*Anticipate — Accelerate — Achieve*



**Agilent Technologies**

# Engineered for 33 GHz true analog bandwidth that delivers:

## Need bandwidth?

When you're deploying leading edge high-speed serial bus designs like FibreChannel, SAS 12 G, or 10 Gb Ethernet KR, jitter matters and picoseconds count. When you're doing spectral analysis of wide-bandwidth RF signals or investigating transient phenomena, bandwidth is critical. You need the most accurate real-time oscilloscope you can get. Agilent Infiniium 90000 X-Series scopes are engineered for **33 GHz** true analog bandwidth that delivers:

- The industry's highest real-time scope measurement accuracy
- The industry's only 30 GHz oscilloscope probing system
- The industry's fastest logic analysis on an oscilloscope (16 channels at up to 50 ps timing resolution)

## 33 GHz and still improving

The industry experts have spoken, and the 90000 X-Series is one of the most award-winning oscilloscopes in the history of the oscilloscope industry. With Agilent's 90000 X-Series oscilloscope, you get up to 33 GHz of real-time bandwidth and the best measurement accuracy.

Even with all of the 90000 X-Series' success, Agilent's software and hardware teams still continue to improve its accuracy and capability. The 90000 X-Series now features a more accurate calibration, PrecisionProbe software, InfiniiView software, and EZJIT Complete; making it the go-to tool for not only your compliance needs, but also your design and validation needs.

## Need more than just a regular oscilloscope?

As part of its continual improvement, 90000 X-Series now has 16 digital channels with time resolution as fast as 50 ps. The mixed signal oscilloscope is the ideal tool for debugging tough memory challenges with unique triggering specific to memory technologies.

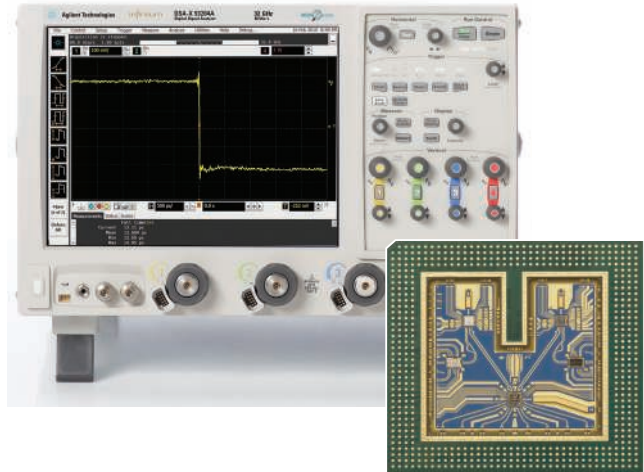

Custom front end technology requiring over five years of design effort yields the fastest real-time oscilloscope hardware available today.



Model number	Analog bandwidth		Sample rate		Max Memory
	2 channel	4 channel	2 channel	4 channel	depth 4 channel
DSAX93204A	33 GHz	16 GHz	80 GSa/s	40 GSa/s	2 Gpts
DSOX93204A	33 GHz	16 GHz	80 GSa/s	40 GSa/s	2 Gpts
DSAX92804A	28 GHz	16 GHz	80 GSa/s	40 GSa/s	2 Gpts
DSOX92804A	28 GHz	16 GHz	80 GSa/s	40 GSa/s	2 Gpts
DSAX92504A	25 GHz	16 GHz	80 GSa/s	40 GSa/s	2 Gpts
DSOX92504A	25 GHz	16 GHz	80 GSa/s	40 GSa/s	2 Gpts
DSAX92004A	20 GHz	16 GHz	80 GSa/s	40 GSa/s	2 Gpts
DSOX92004A	20 GHz	16 GHz	80 GSa/s	40 GSa/s	2 Gpts
DSAX91604A	16 GHz	16 GHz	80 GSa/s	40 GSa/s	2 Gpts
DSOX91604A	16 GHz	16 GHz	80 GSa/s	40 GSa/s	2 Gpts
DSAX91304A	13 GHz	13 GHz	80 GSa/s	40 GSa/s	2 Gpts
DSOX91304A	13 GHz	13 GHz	80 GSa/s	40 GSa/s	2 Gpts

### BW Upgradeable

Buy the performance you need today knowing you have the headroom you need for tomorrow with bandwidth upgradability to 33 GHz

## Engineered for 33 GHz true analog bandwidth that delivers:

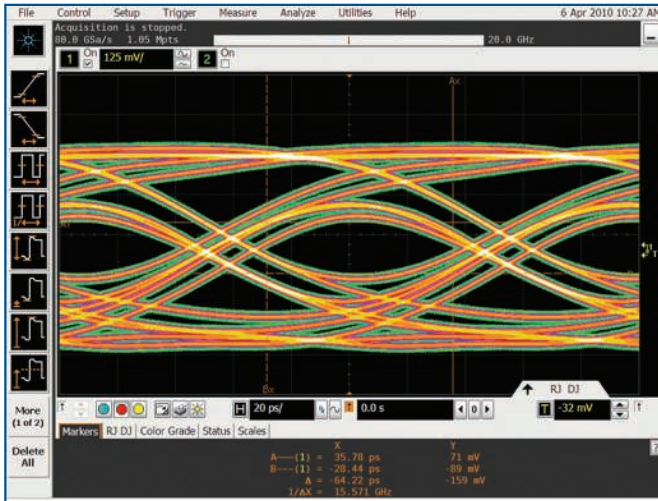

### The industry's highest real-time scope measurement accuracy.

When you're designing with faster signals, shrinking eyes and tighter jitter budgets errors introduced by your oscilloscope can seriously impact your design margins. The Agilent Infiniium 90000 X-Series scopes deliver the highest measurement accuracy available by offering the following characteristics:

- True analog bandwidth to 33 GHz
- Lowest oscilloscope noise floor (2.10 mV at 50 mV / div, 33 GHz)
- Lowest jitter measurement floor (100 fs)

Having the most accurate analog bandwidth and lowest noise floor available means better spectral analysis of transients and wide-bandwidth RF signals.

### Industry's first and only 30 GHz oscilloscope probing system.

No matter how much bandwidth your scope has, if your probes can't match the scope's bandwidth, your measurements are compromised. The Agilent Infiniium 90000 X-Series scopes offer probing solutions that are up to the tough challenges today's high-speed signal data rates with the following:

- InfiniiMax III high frequency probes with automatic AC calibration (PrecisionProbe)
- Fully-integrated probe amplifier s-parameter correction
- The industry's first bandwidth-upgradable probe amplifier

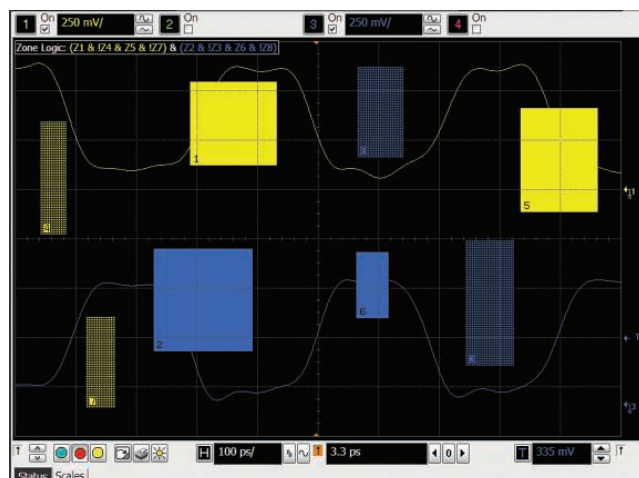

Easily isolate signals of interest with zone qualified view using InfiniiScan software triggering, just one of more than 40 application-specific software options.

### The industry's most comprehensive application-specific measurement software.

When time is of the essence, you need tools that can speed true understanding of your signal activity. From serial bus debug and compliance testing to jitter measurements to sophisticated triggering capability, Agilent stays on top of the test standards and your requirements by working to ensure that you get accurate results more quickly.

The Agilent Infiniium 90000 X-Series scopes offer the following:

- The broadest range of jitter, triggering, analysis and display tools
- Pre-built compliance testing software based on the expertise of our engineers on the standards committees
- Support for emerging technologies including FibreChannel, SAS 12G, or MIPI-MPhy

## Engineered for 33 GHz true analog bandwidth that now combines deep logic analysis with the industry's highest performance oscilloscope:

33 GHz true analog bandwidth of the oscilloscope and 80 GSa/s sample rate provides ultra-low noise.

Capture your longest signal with up to 25 ms data using 2 Gpt of acquisition memory at 80 GSa/s.

See your signal more clearly with a 12.1-inch XGA (1024 x 768) high-resolution color touch screen display.

Identify anomalies easily with a 256-level intensity-graded or color-graded persistence display that provides a three dimensional view of your signals.

Remote access through 10/100/1000 BaseT LAN interface with web-enabled connectivity uses ultra-responsive Ultra VNC.

GPIB and LAN provide remote measurements. Optional Infiniium application remote program interface allows application/compliance software automation. LXI class C compliant. MATLAB support.

An additional four USB 2.0 host ports and a USB 2.0 device port on the back panel. Perfect for extra connectivity including an optical drive. A USB 2.0 device port lets you control the scope and transfer data via a USB 2.0 480-Mbpts connection.

Calibration edge with a rise time of less than 15 ps enables TDT calibration with PrecisionProbe software.

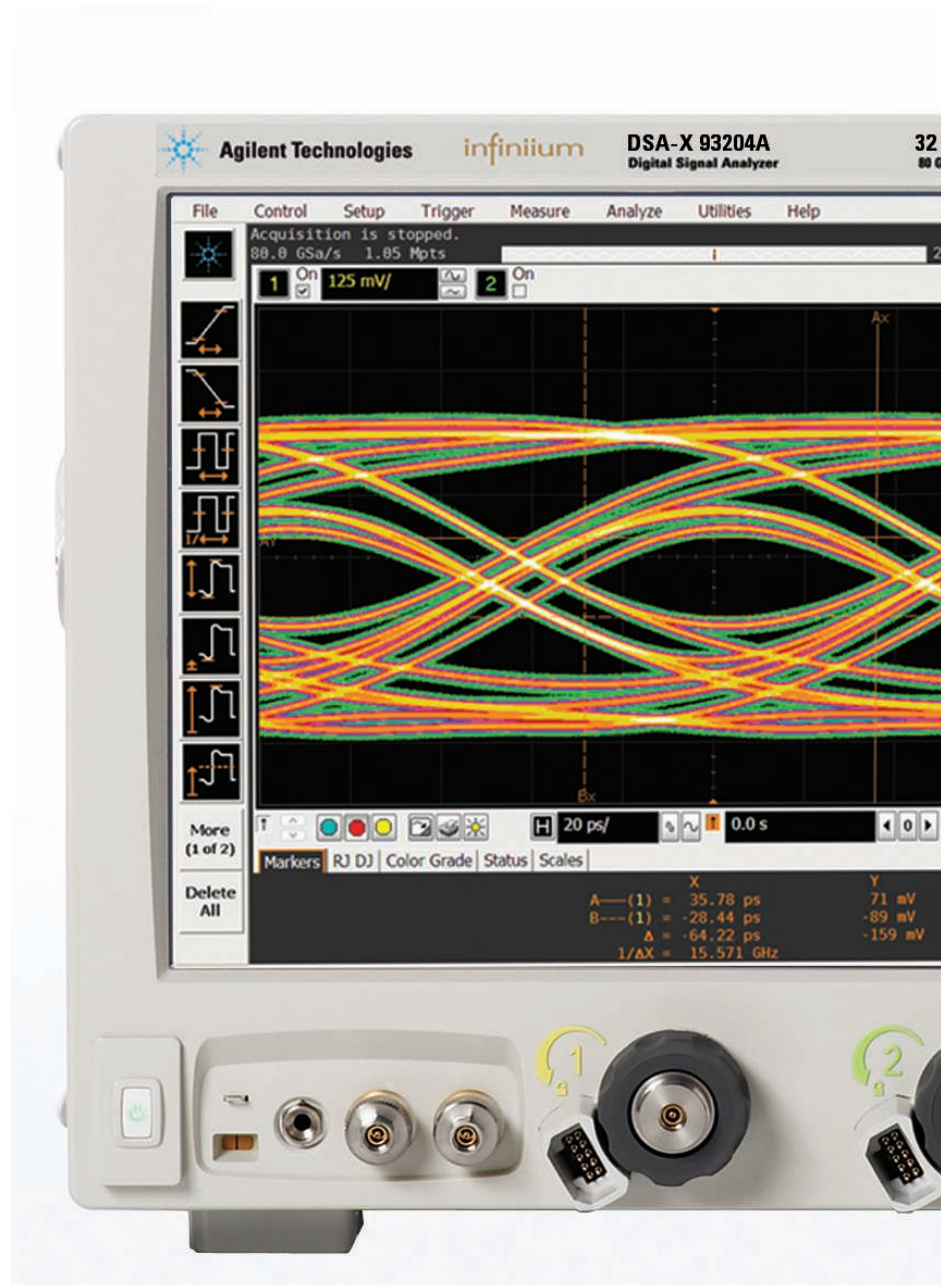

Optional x4 PCIeExpress slot speeds up offload times by a factor of 5, using socket drivers. Use this option (823) for faster deep offloads of the waveforms.

## Featuring bandwidths from 13 to 33 GHz

10 MHz reference clock can be input to or output from the scope to allow precise timebase synchronization with more than one oscilloscope, RF instruments or logic analyzers.

Dedicated single acquisition button provides better control to capture a unique event.

Customizable multipurpose key gives you any five automated measurements with a push of a button. You can also configure this key to execute a script, print/save screen shots, save waveforms or load a favorite setup.

Measure section, including a toggling marker button and a dedicated marker knob, provides quick access to your marker control.

Quick access to fine/vernier control by pressing the horizontal and vertical sensitivity knobs.

Increase your productivity with a familiar Infiniium graphical user interface, including your favorite drag-and-drop measurement icons. Infiniium's analog-like front panel has a full set of controls color-coded to the waveforms and measurements, making your tasks simple.

Three front panel USB 2.0 host ports match your USB keyboard, mouse, and USB memory drive connection for saving setup and data files and screen shots.

Removable solid state drive option is available. It offers improved data security and speed.



Threaded RF connectors ensure the most reliable signal integrity for high-performance instruments. The AutoProbe II interface combines the tried-and-true, robust 3.5 mm threaded RF connector of Agilent sampling scopes with a convenient automatic torque mechanism (clutch) that ensures a consistent 8 in. lbs. connection is made without the hassles of a torque wrench.

# Engineered for 33 GHz true analog bandwidth that delivers:

## *The Oscilloscope: highest real-time scope measurement accuracy*

Whether you're deploying emerging high speed bus technology, identifying spectral content of wide-bandwidth RF signals, or analyzing transient physical phenomena, you need the truest representation of your signals under test. Agilent invested in leading edge technology to bring you the highest real-time oscilloscope measurement accuracy available today.

Custom integrated circuits using a proprietary Indium Phosphide (InP) process and breakthrough packaging technology enable industry-leading performance, including the:

- Up to 33 GHz of true analog bandwidth
- Lowest oscilloscope noise floor
- Lowest oscilloscope jitter measurement floor

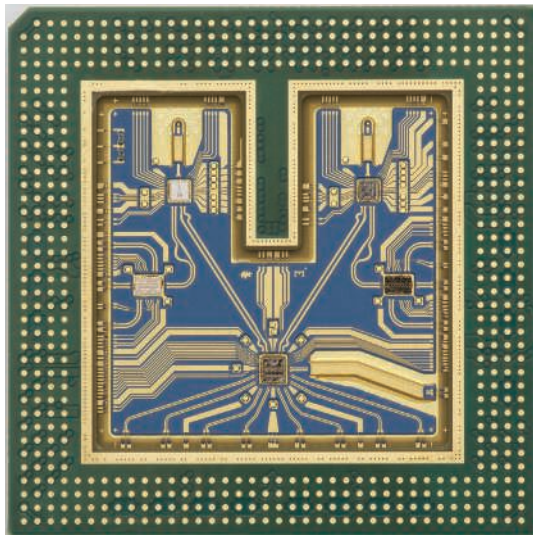

### **True-analog bandwidth- 33 GHz**

The engineering of a high-performance real-time oscilloscope front end requires designing pre-amplifiers, triggering capability, and sampling technology, then seamlessly tying them together. Using fine line microcircuit processes and relying extensively on years of experience with RF design, Agilent developed the front end multi-chip modules shown here for the Infiniium 90000 X-Series oscilloscopes. Packaging technology provides excellent high-frequency electrical properties along with superior heat dissipation. It is a key enabling technology block in Agilent's 90000 X-Series' high measurement accuracy.

### **Low noise floor**

One of the keys to measurement accuracy at high bandwidths is minimizing the noise generated by the oscilloscope itself. Agilent utilizes a proprietary Indium Phosphide (InP) integrated circuit process in the design of the Infiniium 90000 X-Series oscilloscopes because other oscilloscope techniques just can't deliver the necessary combination of high-bandwidth and low noise. Not only does that mean you're purchasing the best tool today, but it also means you can count on technology leadership from Agilent in the future.

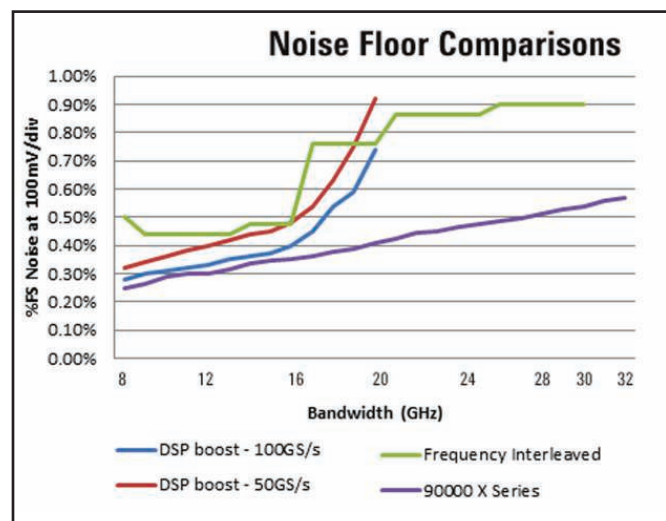

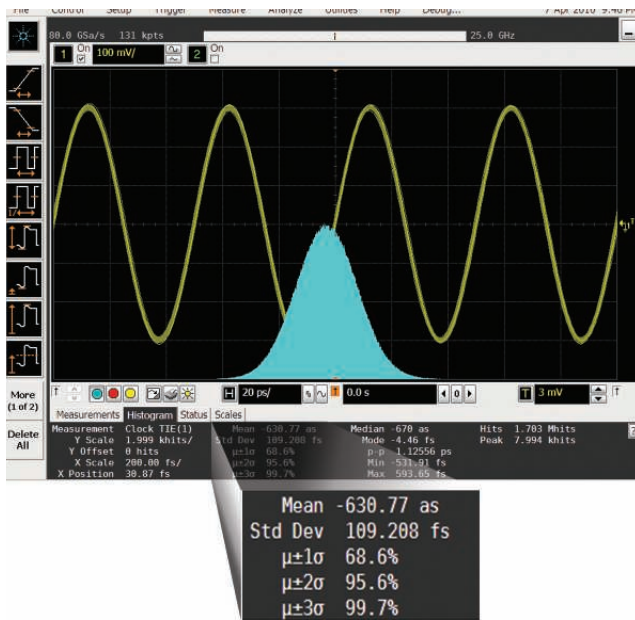

**Jitter measurement floor of less than 100 fs**

## Low real-time oscilloscope jitter measurement floor, just got lower (now 100 fs)

Oscilloscope bandwidth allows signal rise times to be more accurately depicted. The oscilloscope noise floor directly impacts the y-axis voltage placement of each signal data point. The Infiniium 90000 X-Series scopes combine superiority in these characteristics with extremely low sample clock jitter (< 100 femtoseconds). This ensures the lowest possible contribution to jitter measurements from the scope itself so you're using your jitter budget on your design.

In addition to its low jitter measurement floor, the 90000 X-Series has the industry's deepest memory with up to 2 Gpts, allowing you to resolve low frequency jitter components in a single measurement.

The 90000 X-Series now features an even more advanced calibration system known as sine wave cal. This sine wave calibration further lowers spurs caused by ADC interleaving errors and enables lower jitter and higher spurious free dynamic range. Sine wave calibration simply builds on its industry leading accuracy.

## Better calibration improves spectral purity

Agilent oscilloscopes are constantly improving their measurement accuracy. The latest innovation is a new, improved calibration routine that better aligns the sample points of the analog to digital converter.

The improved calibration results in higher spurious free dynamic range (SFDR) and effective number of bits (ENOB). For instance, the SFDR is improved by as much as 15 dBc depending on the carrier frequency. The higher SFDR is ideal for making RF and optical measurements where spectral purity is of the utmost importance. Improved SFDR and ENOB also means better jitter performance.

Ultimately this means the 90000 X-Series now features the highest SFDR and ENOB of any oscilloscope on the market.



**Improved calibration improves the spurious free dynamic range by up to 15 dBc**

# Engineered for 33 GHz true analog bandwidth that delivers:

## The Industry's Fastest Mixed Signal Oscilloscope

### A mixed signal oscilloscope integrates traditional analog channels with 16 digital channels

In 1996, Agilent pioneered the mixed signal oscilloscope. Innovative IC technology we called 'MegaZoom,' which delivered highly responsive deep memory so designers can see both cause and effect in digitally controlled analog phenomena. The first MSO was named Test & Measurement World Test Product of the Year in 1997.

Agilent MSOs seamlessly integrate the familiar controls of an oscilloscope with the additional digital data collection and pattern recognition of a logic analyzer. You can trigger across any combination of analog and digital channels; integrate serial bus triggering and decode and even see inside your FPGA designs.

### Agilent continues to lead the way with MSOs

The MSO 90000 X-Series is specifically targeted at the DDR2/3/4 technologies, simplifying the complicated task of debugging memory technologies. The 20 GSa/s on 8 channels means you can easily separate reads and writes on all DDR4 speeds. The MSO 90000 X-Series is fully compatible with Agilent 90-pin logic analysis connectors, making it easy to connect to your devices.

### Combining analog and digital performance

Today's designs require access to complex triggers and multiple instruments. The 90000 X-Series mixed signal oscilloscopes provide up to 20 channels you can use at once. Each channel can be combined in a unique pattern trigger. The 90000 X-Series has the ability to label each individual channel as part of a bus for decoding, saving hours of manual work.

The 90000 X-Series also features application-specific decode applications that are designed for up to 20 channels. These applications include many low-speed serial and parallel busses. For instance, the JTAG protocol decode is available only on Agilent oscilloscopes.

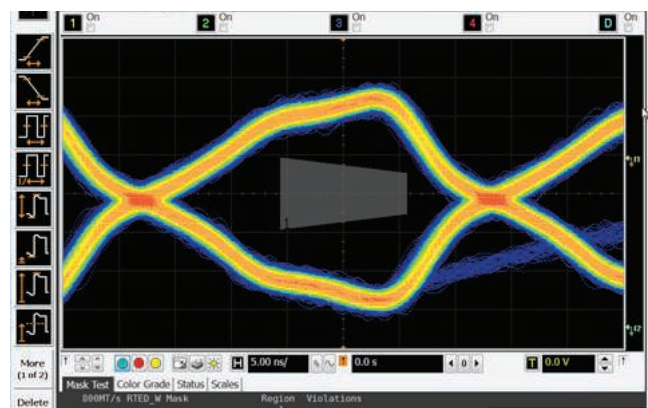





## Analysis tools: PrecisionProbe (option 001)

Turn your 90000 X-Series oscilloscope into a time-domain transmissometry (TDT) and quickly characterize and compensate any input into your scope.

PrecisionProbe technology turns your oscilloscope into the ultimate characterization tool. Not only can you do the normal de-embedding through InfiniiSim, PrecisionProbe allows quick characterization of your entire probe system (including cables and switches) without the need for extra equipment. PrecisionProbe takes advantage of the fast “cal output” signal on the 90000 X-Series to characterize and compensate for loss on the measurement system.

PrecisionProbe technology:

- Properly creates custom probe transfer function =  $V_{Out} / V_{In}$
- Properly characterizes probed system transfer function such that  $V_{Out} / V_{Inc} = V_{Out} / V_{Src}$
- Removes unwanted S21 cable insertion loss

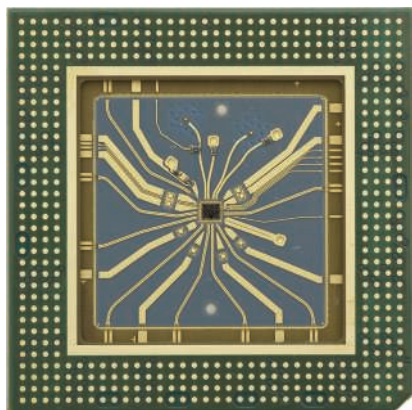

**Agilent's uses Indium Phosphide to procure a sub 12 ps edge perfect for characterizing cable and probe frequency response**

Now every probe and cable in the system can have the exact same frequency response – probe to probe or cable to cable – without measurement variation caused by probe variation. Now you can properly characterize custom probes. In addition to characterizing the cables, PrecisionProbe allows for immediate use on the same instrument. PrecisionProbe saves you time and money while increasing your measurement accuracy.

When you combine InfiniiMax probes with switches between the amplifier and the probe head, PrecisionProbe allows for full correction and automation of each probe's path. Full automation is then available to allow for quick swapping of the inputs via InfiniiSim's compliance framework. For increased accuracy, purchase PrecisionProbe Advanced for faster edge speeds and true differential measurements.

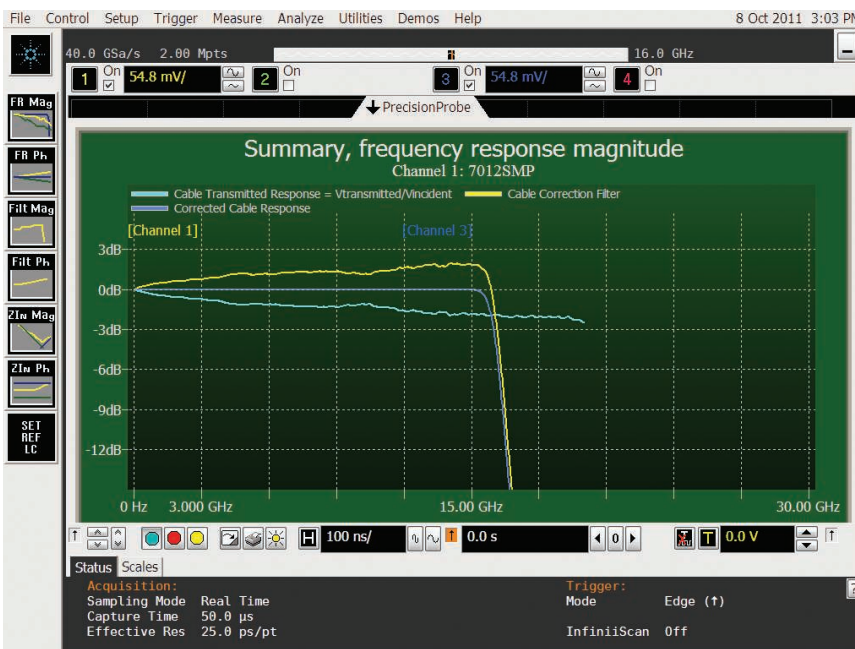

### PCI Express measurement comparisons

Root complex device	Eye height (mV)	Eye height PrecisionProbe	Gain
2.5 GT/s_12 GHz	517.19	553.94	7.1%
5 GT/s_12 GHz_3.5 dB	312.22	348.19	11.5%
5 GT/s_12 GHz_6 dB	341.1	376	10.2%
5 GT/s_16 GHz_3.5 dB	306.6	348.33	13.6%
5 GT/s_16 GHz_6 dB	344.4	374.41	8.7%
8 GT/s_12 GHz_P7	96.83	103.09	6.5%
8 GT/s_12 GHz_P8	100.16	108.33	8.2%
8 GT/s_16 GHz_P7	96.92	106.01	9.4%
8 GT/s_16 GHz_P8	100.24	108.24	8.0%

By characterizing and compensating for cable loss on the cable connected to the PCI Express test fixture, the designer was able to gain between 6.5% and 13.6% margin that would have been lost otherwise.

## Analysis tools: EZJIT, EZJIT + and SDA (standard on DSA models)

### Gain insight into the causes of signal jitter to ensure high reliability of your design

With faster edge speeds and shrinking data-valid windows in today's high-speed digital designs, insight into the causes of jitter has become critical for success. Using EZJIT and EZJIT + jitter analysis software the 90000 X-Series oscilloscopes help you identify and

quantify jitter components that affect the reliability of your design. Time correlation of jitter to the real-time signal makes it easy to trace jitter components to their sources. Additional compliance views and a measurement setup wizard simplify and automate RJ/DJ separation for testing against industry standards.

EZJIT Plus automatically detects embedded clock frequencies and repetitive data patterns on the oscilloscope inputs and calculates the level of data-dependent jitter (DDJ) that is contributed to the total jitter (TJ) PDF by each transition in the pattern, a feature not available on any other real-time oscilloscope today.

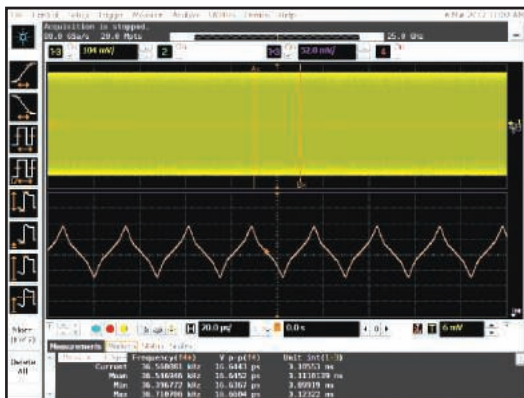

Use EZJIT software to extract spread spectrum clocks

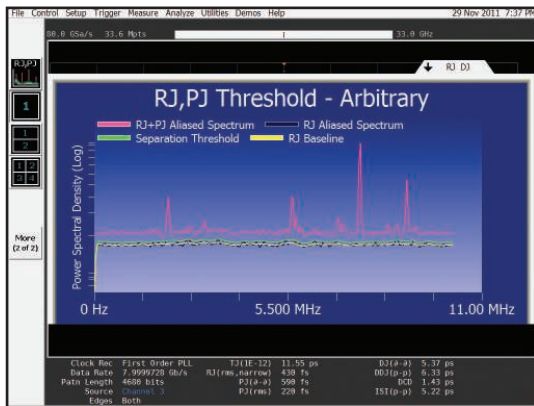

The RJ/PJ threshold tools, provides more jitter analysis

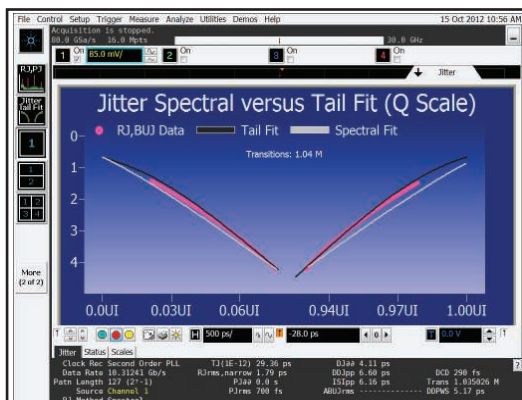

Jitter separation makes debugging your device easy

### Measurement trends and jitter spectrum

EZJIT's simple tools help you quickly analyze the causes of jitter. Measurement trends allow you to see deeper views of factors affecting measurements. Jitter spectrum is a fast method to find the causes of jitter.

### Two ways to separate jitter

EZJIT + comes with two ways to separate jitter: the industry standard spectral method and the emerging tail-fit method. Both methods allow for simple separation of RJ and DJ, but the tail-fit method provides jitter separation in the unique case of non-symmetrical histograms and aperiodic bounded uncorrelated jitter.

### Unique RJ/DJ threshold view

EZJIT + also provides a unique spectral view of the jitter spectrum with the threshold drawn on the chart. The spectral view provides insight into the decision point of the separation and allows for narrow or wide, tail-fit or Dual-Dirac.

### Real-time eye and clock recovery

Serial data analysis (SDA) software provides flexible clock recovery including 1st and 2nd-order PLL and constant algorithms. With a stable clock, you can look at real-time eyes of transition and non-transition bits. 90000 X-Series scopes with SDA software also provide a new unique view of bits preceding an eye.

### Tools to determine the correct settings

SDA, EZJIT, and EZJIT+ come with an array of visual tools to make analyzing the data simple and ensure that the correct settings are chosen for difficult design decisions. For example, the improved bathtub curve (see image to the left) allows an easy visual tool to determine which jitter separation method best fits the data.

## Analysis tools: EZJIT Complete (standard on DSA models)

Discover signal anomalies to the noise of the waveform

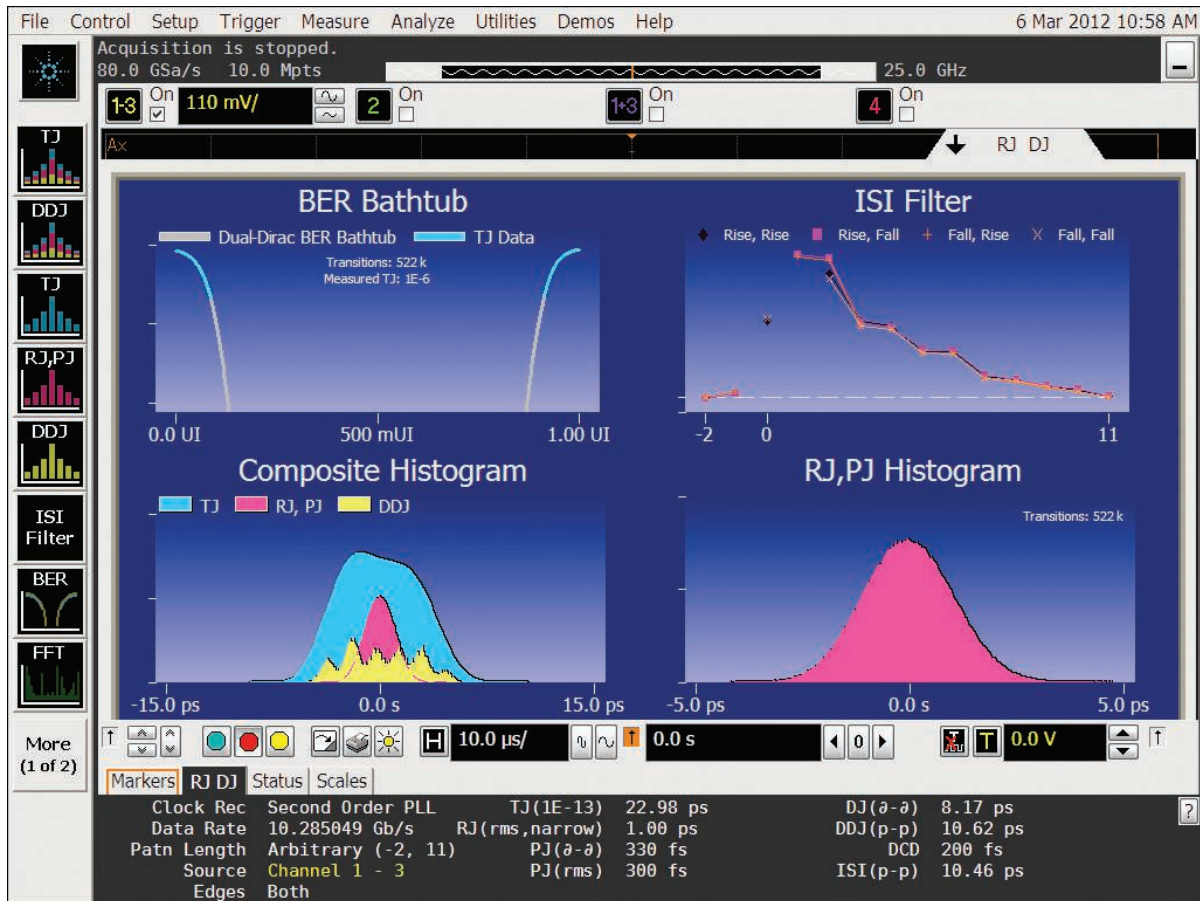

### More than your standard jitter package

In order to efficiently determine root cause for any type of signal degradation in the amplitude domain, you must first determine whether the problem is caused by random or deterministic sources. In order to help you accomplish this task, EZJIT Complete takes analysis techniques used in the time domain (jitter analysis) and extends them into the amplitude domain.

### More than just an eye contour

EZJIT Complete is an in-depth view into impairments related to signal levels – either logic ones or logic zeroes – deviating from their ideal positions. Some tools simply provide a view of an eye contour, but provide no real measurement data other than nice graphics.

EZJIT Complete uses separation techniques to allow each bit to be examined to determine correlated effects and to make multiple measurements on individual bits to determine uncorrelated effects. Use FFTs to analyze the frequency domain and extract random components. Dual-Dirac modeling

techniques are also carried from the jitter domain and used in the interference domain.

### Key measurements

With EZJIT Complete, 90000 X-Series scopes offer the following unique measurements:

- Total interference (TI)
- Deterministic interference (DI)
- Random noise (RN)
- Periodic interference (PI)
- Inter-symbol interference (ISI)
- RIN (dBm or dB/Hz)
- Q-factor

## Analysis tools: InfiniiSim (options 013 and 014)

The most advanced waveform transformation software helps you render waveforms anywhere in a digital serial data link

InfiniiSim waveform transformation toolset provides the most flexible and accurate means to render waveforms anywhere in a digital serial data link. The highly configurable system modeling enables you to remove the deleterious effects of unwanted channel elements, simulate waveforms with channel models inserted, view waveforms in physically improbable locations, compensate for loading of probes and other circuit elements, and do so simply and quickly on your tool of choice, the 90000 X-Series at up to 33 GHz of bandwidth.

### Circuit models to define your setup

The InfiniiSim waveform transformation toolset provides a graphical user interface for you to define your system as you understand it and even make it arbitrarily complex. You do this by selecting topologies and defining circuit blocks.

### Model reflections

With the InfiniiSim waveform transformation toolset, you can transform signals with confidence, whether you are inserting or removing channel elements or relocating the measurement plane. InfiniiSim's advanced toolset lets you model up to 27 different elements at once and model the interaction between elements. Only toolsets with the ability to model more than one element will properly reflect a model including the oscilloscope's input. The 90000 X-Series scopes provide their own s11 parameter to allow modeling of their own input.

### Model your system with as much detail as you need

InfiniiSim features the model setup that best matches your design. Whether it is a simple single-element model or an advanced general-purpose model with up to 27 elements in the link, you can perfectly model your design and simulate the exact probing point you want.

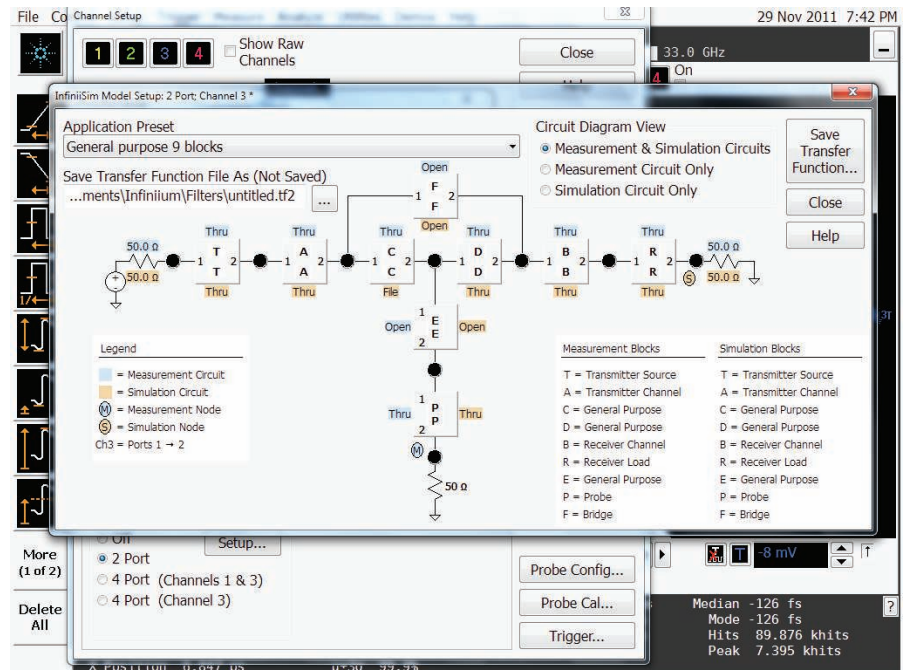

## Analysis tools: Serial data equalization (option 012)

Significantly reduce receiver errors by opening even tightly shut eyes through equalization emulation

Serial data equalization for the 90000 X-Series provides fast and accurate equalization using decision feedback equalization (DFE), feed-forward equalization (FFE), and continuous-time linear equalization (CTLE) modeling in real time. Serial data equalization software allows you to input your own self-designated tap values to verify your design. If you prefer, the software will find the optimal tap values for you. CTLE allows DC gain and two-pole modeling.

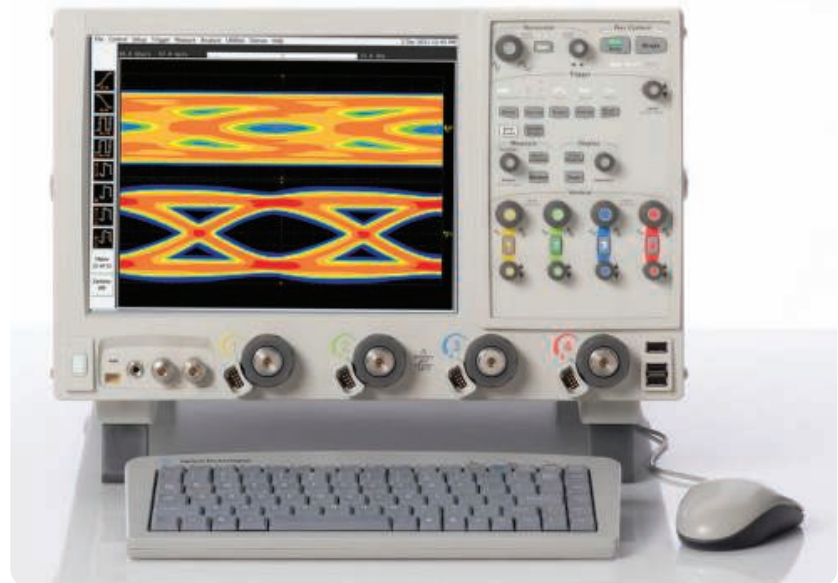

## Analysis Tools: InfiniiScan (Option 009)

Trigger on events that hardware triggers can't handle.

InfiniiScan software allows you to use an oscilloscope to identify signal integrity issues that hardware triggering is unable to find in your electronic designs. This innovative software scans through thousands of acquired waveforms per second to help you isolate signal anomalies, saving you time and improving designs.

### Innovative triggers

The *zone qualify finder* allows you to draw a "must pass" or "must not pass" zone on the oscilloscope screen to visually determine the event identify condition. If you can see the event of interest on the screen, you can create a trigger that will isolate it, saving significant time over some complicated hardware triggers.

Other triggers include non-monotonic edge, measurement limit search, runt and pulse width.

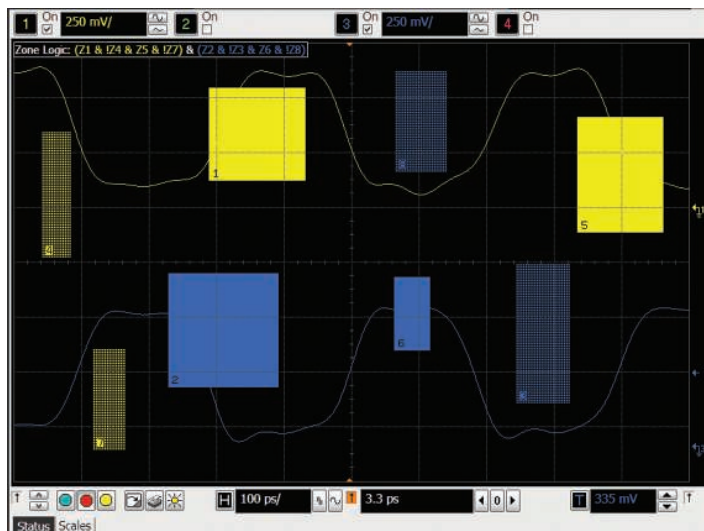

**Draw zones on your screen for a unique triggering experience**

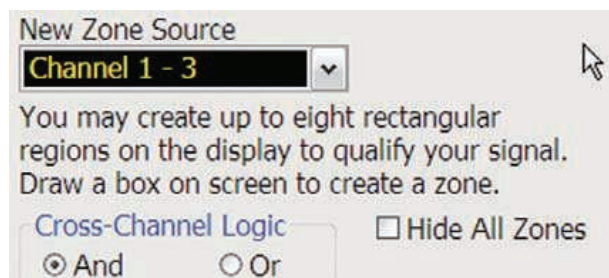

**By combining InfiniiScan and hardware-accelerated math, you can even trigger on differential math signals**

# Analysis tools: N8900A InfiniiView oscilloscope analysis software

View and analyze away from your scope and target system



**InfiniiView software supports a wide array of Infiniium applications**

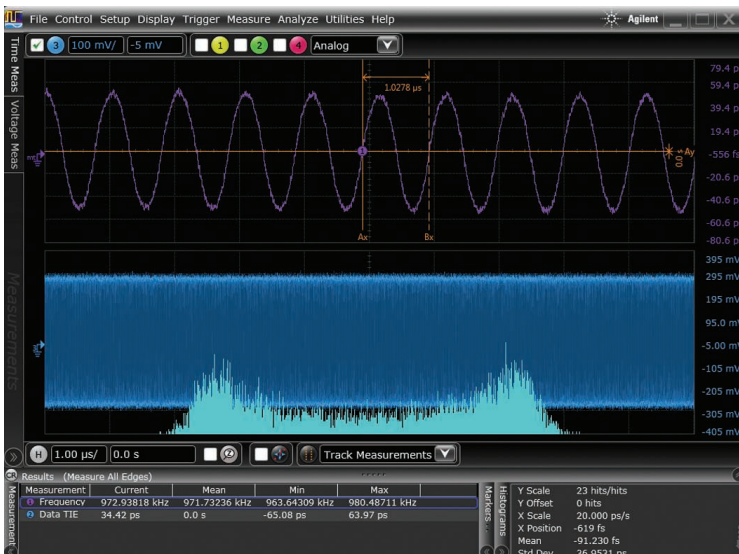

**Use InfiniiView to find signal anomalies, such as power supply coupling**



**Peak search capability makes InfiniiView a frequency domain tool**

Ever wish you could do additional signal viewing and analysis away from your scope and target system? Now you can. Capture waveforms on your scope, save to a file, and recall into Agilent's InfiniiView application.

## View and analyze anywhere your PC goes

Take advantage of large high-resolution and multiple displays found in your office. Use familiar scope controls to quickly navigate and zoom in to any event of interest. Use auto measurements and functions for additional insight.

## Share scope measurements more easily across your team

You can share entire data records instead of being limited exclusively to static screen shots.

## Create more useful documentation

Use features such as right-click cut-and-paste to move screen images between applications, without ever having to save the image to a file. Add up to 100 bookmark annotations and up to 20 simultaneous measurements.

## Need advanced analysis capability?

InfiniiView includes a variety of upgrade options including serial decode upgrades for a variety of serial buses, jitter analysis, and serial data analysis.

## Analysis tools: User-defined function (option 065)

### Combine Infiniium and MATLAB for even more analysis

Enhance the 90000 X-Series with a seamless gateway to powerful MATLAB analysis functionality. User-defined function software adds new analysis capabilities to the 90000 X-Series, beyond traditional math/analysis features. Now you have the freedom to develop your own math functions or filters using MATLAB and its Signal Processing Toolbox. With a seamless integration to MATLAB, Agilent Infiniium oscilloscopes allow you to display your math and analysis functions live on the oscilloscope screen, just like any other scope-standard functions.

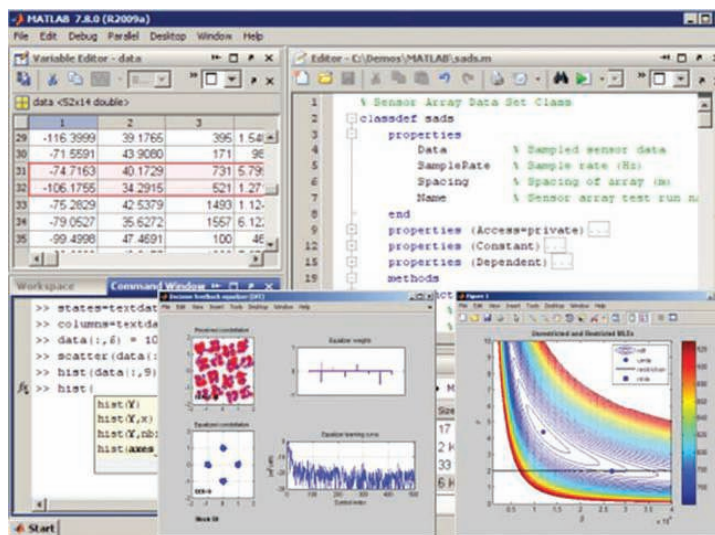

## Analysis Tools: complete list of analysis software

Analysis Tools	Description	Option	Standalone
PrecisionProbe	Characterize and compensate for loss from your input to your oscilloscope to 33 GHz	001	N2809A-001
InfiniiScan	Trigger on unique events including using zones on multiple channels and non-monotonic edges	009	N5414B
EZJIT	Basic jitter analysis with measurement trending, time interval error and many more measurements	002*	E2681A
EZJIT +	Get in-depth analysis of your jitter by decomposing your jitter	004*	N5400A
EZJIT Complete	Understand your full real time by decomposing the noise that is impacting your margins	070*	N8823A
Serial data analysis	Recover clocks to 120 Gbs/s and view real-time eyes. Run mask testing	003*	E2688A
InfiniiSim Basic	Waveform transformation software to remove or add three elements in your link	013	N5465A-001
InfiniiSim Advanced	Waveform transformation software to remove or add 27 elements in your link	014	N5465A-002
Serial Data Equalization	Easily emulate your equalizer settings for CTLE, FFE and DFE	012	N5461A
InfiniiView	Put your scope onto your PC and maximize Infiniium's analysis tools with a true offline analysis engine	-	N8900A
User-defined function	Create custom functions that run live on your oscilloscope with MathWorks MATLAB software	010	N5430A
MATLAB Basic	Purchase an introductory MATLAB software package to acquire scope measurements into the MATLAB environment	061	-
MATLAB Standard	Purchase a typical MATLAB software package, signal processing and filter design toolboxes on the same PO as your scope	062	-
User-defined function with MATLAB	Create and execute custom functions that run live on your oscilloscope. Includes MATLAB standard software (option 062)	065	N8806A
Agilent Spectrum Visualizer (ASV)	Analyze advanced FFT frequency domain analysis at a cost-effective price	-	64996A

\* Standard on DSA models



## Compliance and automated testing

Today's demanding environment means you have much less time to understand the intricacies of the technologies you are testing. You also have less time to develop and test automation software that is designed to increase measurement throughput and decrease time to market. Agilent's compliance applications save you time and money with measurement automation built into the compliance application. No longer do valuable resources need to be exclusively tied to writing automation software – instead they can be deployed to designing the next big project.

Compliance applications that run on 90000 X-Series oscilloscopes are certified to test to the exact specifications of each technology standard. If a test passes on the 90000 X-Series scope in your lab, you can be assured that it will pass in test labs and at plug fests worldwide. Agilent experts on technology boards and industry standards committees help define compliance requirements. As a result, you can be sure that 90000 X-Series oscilloscope tools deliver to critical specifications. Setup wizards combined with intelligent test filtering give you confidence you're running the right tests. Comprehensive HTML reports with visual documentation and pass/fail results guarantee that critical information is retained on each test.

### Quick and easy automated switching

Only Agilent's 90000 X-Series oscilloscopes feature compliance applications with both the user-defined application's add-in capability and integrated PrecisionProbe compensation. Switch paths can vary in their characteristics and have unwanted loss. By enabling PrecisionProbe in its compliance applications, 90000 X-Series scopes allow you to characterize and compensate for every path in the switch, making every path's frequency response identical in both magnitude and phase. These tools makes switch automation quick and painless. The 90000 X-Series and its compliance applications make automation more automated than ever. Your technicians no longer need to spend valuable time physically changing connections.

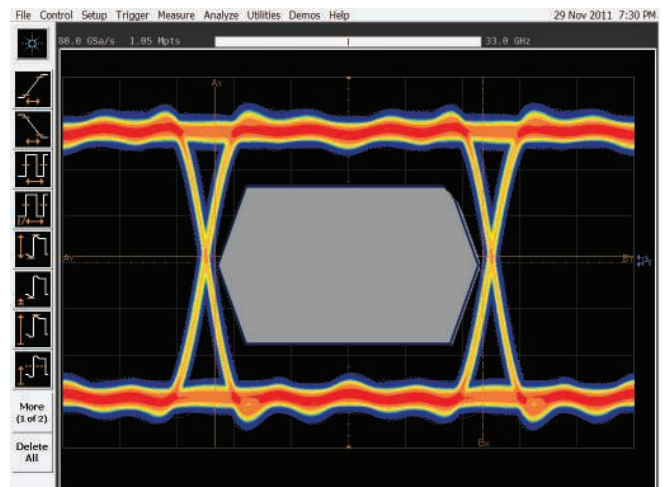

**Compliance applications make testing to today's technologies standards easy**

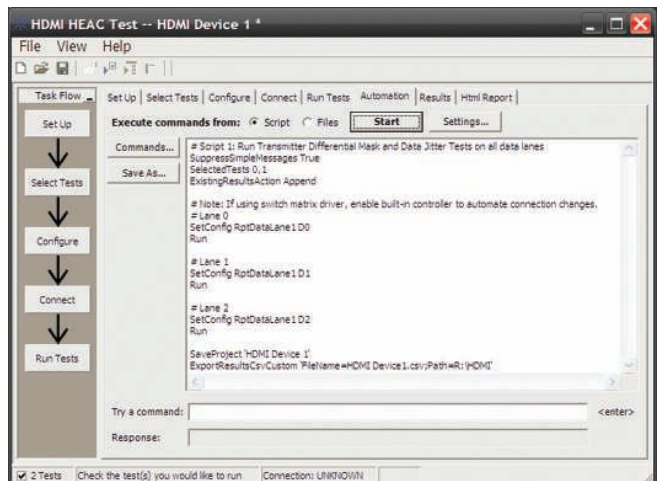

**The remote programming interface makes it easy to control automation applications via your PC**

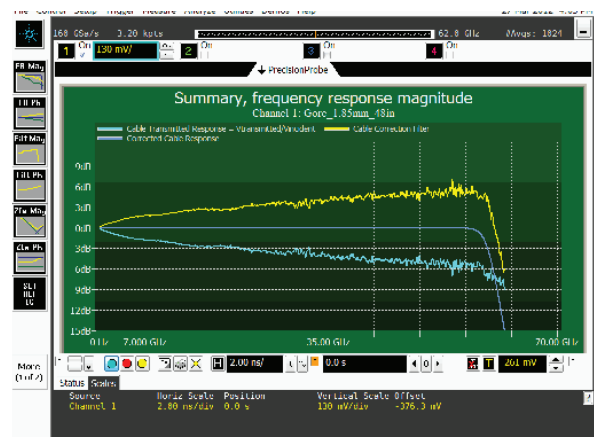

**PrecisionProbe is fully integrated in 90000 X-Series automation applications**

# Compliance and automation testing: Switch matrix support

## Comprehensive testing, easily achieved

### Eliminate reconnections (reducing errors)

Compliance applications on Agilent's 90000 X-Series now support a switch matrix, making testing simple by automating test for each lane of a multi-lane bus. Typical testing requires reconnecting the oscilloscope each time that you switch a lane, which causes wasted time and inaccuracies. The 90000 X-Series solves this problem by supporting switch matrix through its compliance test. Simply connect the switch to the oscilloscope and all the lanes, and then hit run to complete full testing of your entire device.

### Maintain accuracy

The framework fully supports Agilent's PrecisionProbe software (N2809A) and InfiniiSim software (N5465A). This gives you the ability to characterize every switch path to the device under test (both magnitude and skew) and ensure that all of them maintain the same level of accuracy.

### Customize your testing

Use the remote programming interface (standard feature on the 90000 X-Series) and N5467A user-defined application for device control, instrument control and test customization.

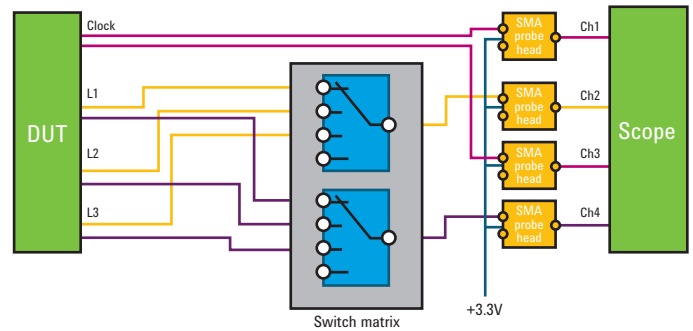

Typical switch configuration for HDMI testing (now supported in the 90000 X-Series)

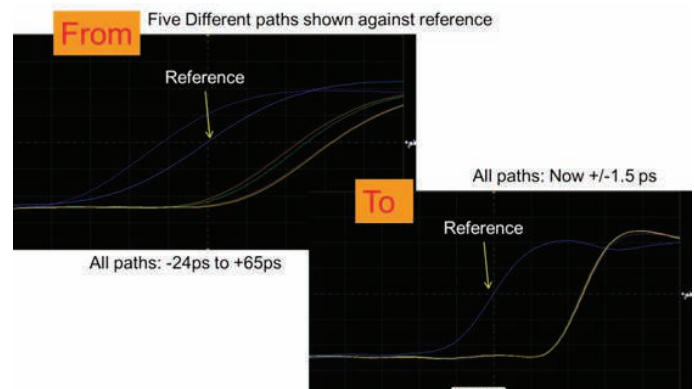

Skews between switch paths are easily maintained with Agilent's unique software

# Compliance and automation testing: User-defined application (option 040)

## Custom automation for your 90000 X-Series oscilloscope

The user-defined application is the only fully-customizable automated environment made for an oscilloscope by an oscilloscope designer. It provides full automation, including the ability to control other Agilent instruments, external applications such as MATLAB and your DUT software.

### Simplify your automation

The user-defined application (UDA) makes automation simple. The application takes the Infiniium compliance application framework and gives you full access to its interface. UDA allows for automation testing in as little as one minute. Use UDA to control other Agilent instruments such as signal generators and network analyzers to create a full suite of measurements.

### Full measurement report

No automation would be complete without a simple-to-view and easy-to-understand report. UDA provides a full report of the pass/fail criteria you have provided.

### Add-in capability

Ever wanted to add testing to your compliance applications? All Infiniium compliance applications support the industry's most flexible testing mechanism with UDA add-in capability. Create the custom testing you need and then plug it into your compliance application to expand the application to your testing needs. UDA add-in capability is only available on Infiniium oscilloscopes.

### PrecisionProbe and switch compatibility

UDA makes automation of switches in your system simple and accurate. Use PrecisionProbe to characterize the path of the switch and then let UDA's

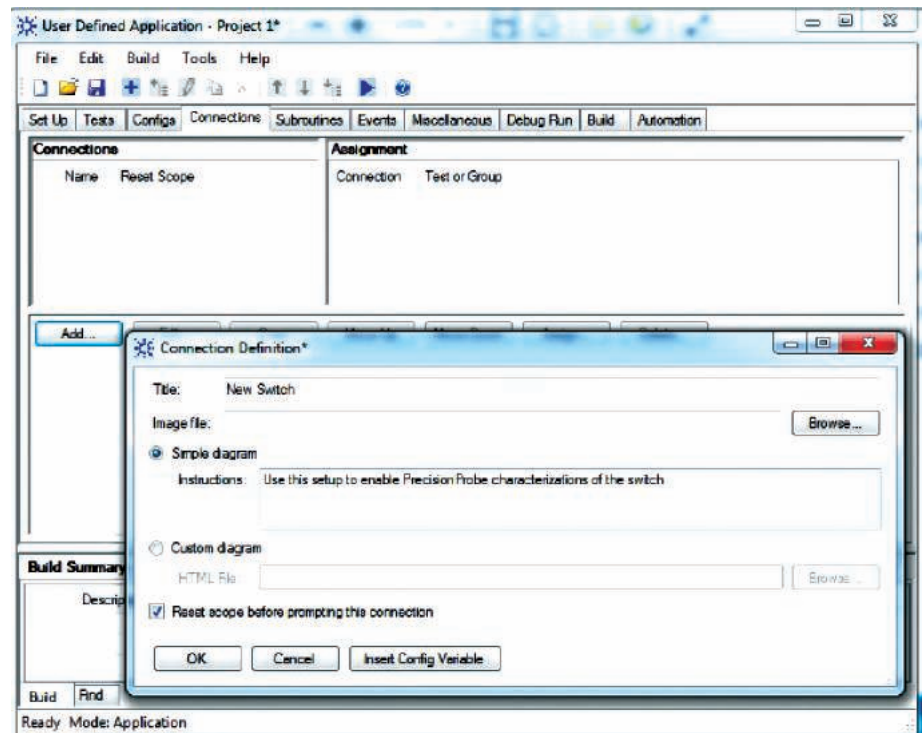
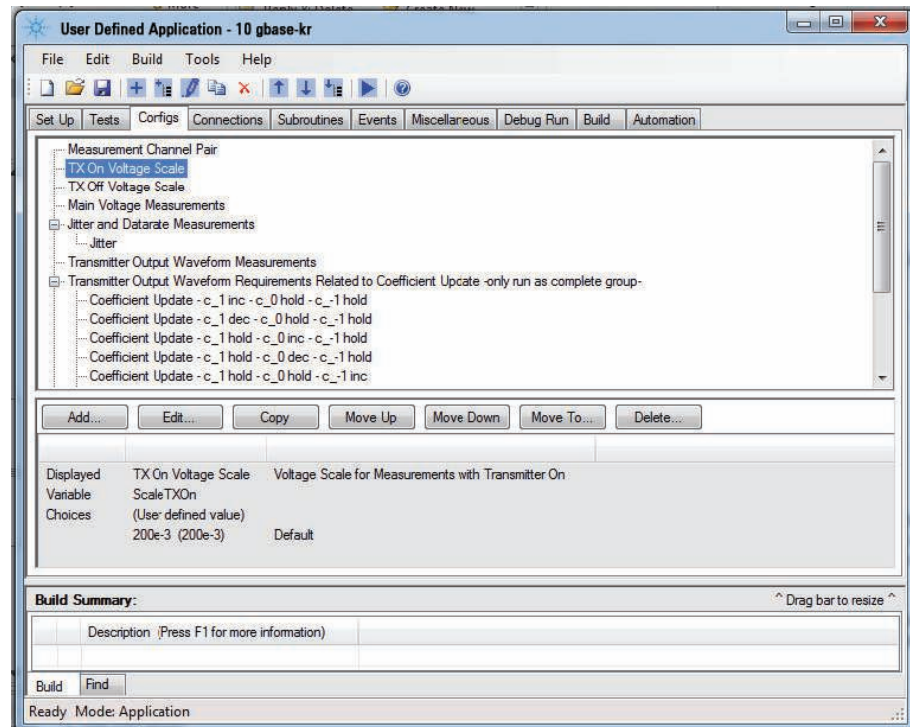

unique GUI switch between every input in your switch system. Every input can

look identical in its frequency response thanks to this advanced technology.

## Compliance and automation testing: Other options on 90000 X-Series oscilloscopes

In the previous pages we have highlighted a few of the key technologies that benefit from the industry's most accurate oscilloscope. The 90000 X-Series offers more than 20 compliance applications, and the list continues to grow. All applications are fully compatible with InfiniiSim, PrecisionProbe and UDA's unique add-in capability.

Compliance tools	Description	Option	Standalone
PCI Express gen 1/2/3	Guarantee your PCI Express gen3 designs	044	N5393C
HDMI 2.0 compliance	Quickly verify and debug your high-definition multimedia interface	077	N5399C
SAS -2 compliance	Automatically execute SAS electrical checklist tests at each of the IT, CT, IR and CR interface points	043	N5412A
SAS -3 compliance	Automatically execute SAS-3 electrical checklist tests	076	N5412C
DisplayPort source compliance	Verify and debug your DisplayPort interface designs for sink and source ICs, motherboard systems, computers and graphics cards	045	U7232B
DDR1 verification	Save time with automated testing based on JEDEC DDR1 and LPDDR1 specifications	031	U7233A
DDR3 verification	Save time with automated testing based on JEDEC DDR3 and LPDDR3 specifications	032	U7231B
DDR2 verification	Save time with automated testing based on JEDEC DDR2 and LPDDR2 specifications	033	N5413B
DDR4 verification	Save time with automated testing based on JEDEC DDR4 specifications	058	N6462A
MIPI D-Phy verification	Execute D-Phy electrical checklist tests for CSI and DSI architectures	035	U7238B
GDDR5 verification	Save time with automated testing based on JEDEC GDDR5 specification	–	U7245A
MIPI M-Phy verification	Execute M-Phy electrical tests	047	U7249B
Energy Efficient Ethernet	Debug your 1000BASE-T, 100BASE-TX and 10BASE-T Ethernet designs	060	N5392B
10 Gbase-T compliance	Coverage of the 10GBASE-T transmitter electrical specifications as described in section 55.5.3 of IEEE 802.3an-2006	036	U7236A
XAUI compliance	XAUI validation with 10GBASE-CX4, CPRI, OBSAI and Serial RapidIO support	030	N5431A
SATA 6G compliance	Automated compliance testing for 1.5-Gbps, 3.0-Gbps and 6.0-Gbps SATA and eSATA transmitter (PHY/TSG/OOB tests)	038	N5411B
User-defined application	Fully customizable automated application for your Infiniium oscilloscope	040	N5467A
USB 2.0 compliance	USB-IF recognized compliance for low/full and low/full/high-speed USB automated electrical test	029	N5416A
USB 3.0 compliance	Validate and debug your USB 3.0 silicon, host, hub or device	041	U7243A
USB HSIC	Validate and debug USB high-speed inter-connect devices	046	U7248A
MHL compliance	Validates MHL source designs as found in portable products such as cell phones and tablets according to the MHL 1.2 standard	054	N6460A
Thunderbolt compliance	Measure the transmitter with the accuracy of the 90000 X-Series	059	N6463A

# Protocol and triggering: Memory support (standard feature on the MSOX)

## DDR2, 3, and 4 protocol and triggering

Because of the introduction of MSO models on the 90000 X-Series, these oscilloscopes now support full protocol and triggering for DDR2, 3 and 4 technologies. The 90000 X-Series allows for full triggering on the following events: read, write, activate, precharge, and many more common memory commands.

The triggering makes read and write separation easy to do; it also helps you quickly find real time eyes in today's difficult-to-debug memory environment.

The DDR2, 3 and 4 protocol triggering is only available on the MSO and comes standard with an MSO purchase.

## LPDDR 2 and 3 protocol and search

The 90000 X-Series also provides LPDDR2 and LPDDR3 protocol standard on its MSO. A time-aligned listing window makes it easy to search for uncommon events.

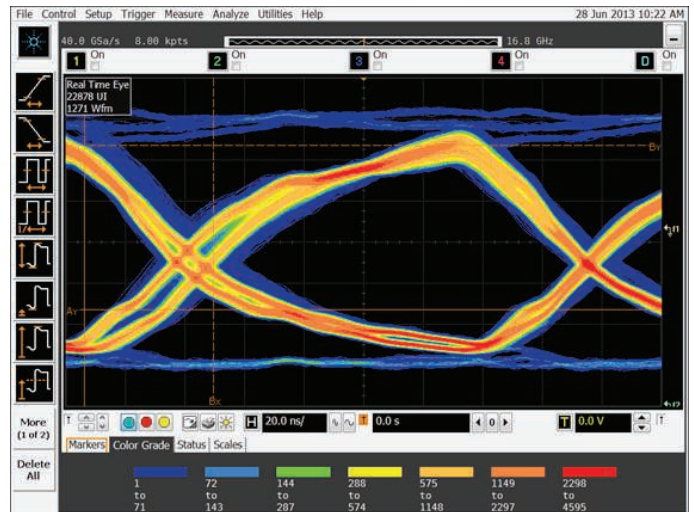

## Protocol analysis

90000 X-Series oscilloscopes come with more than 15 protocol decoders, including the industry's only 64/66b decoder. The 90000 X-Series protocol tools feature time-correlated markers that let you easily move between the listing window and the waveform. Protocol tools can be used on up to four lanes simultaneously.

These unique tools feature search and trigger capability that lets you scan through the waveform to find the trigger condition that interests you. Protocol tools are fully compatible with Infiniium's serial data analysis and are available on the Infiniium offline tool.

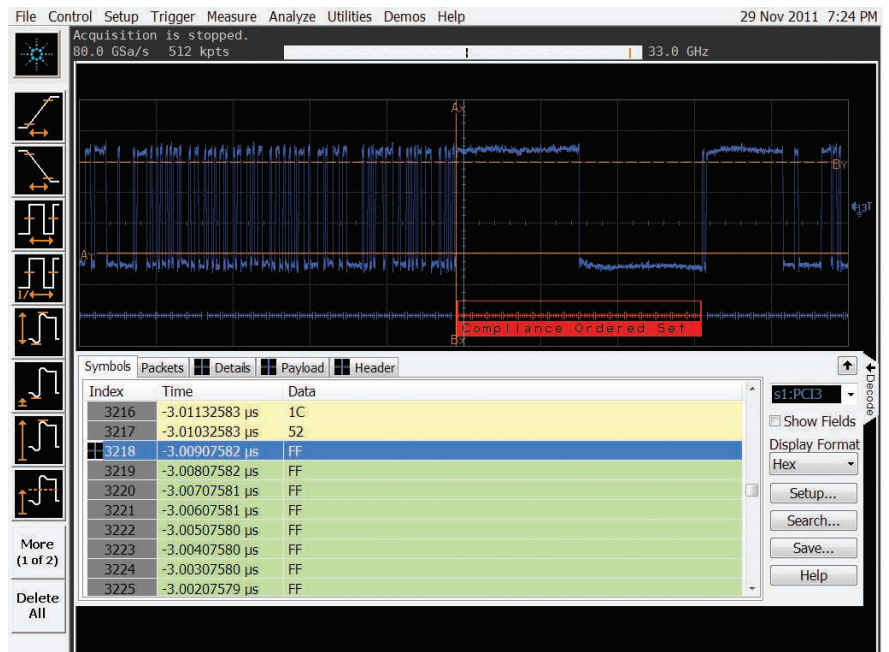

Protocol	Description	Option	Part number
PCI Express gen3	Time-correlated views of physical and transaction layer errors. 128/130-bit decoding on gen3 traffic	049	N8816A
Ethernet 10Gbase-KR	World's only protocol tool for 10Gbase-KR 64/66-bit decoder	048	N8815A
USB 3.0	Set up your scope to show USB 3.0 SuperSpeed protocol decode in less than 30 seconds		N8805A
SATA/SAS	Simplify the validation of your SATA/SAS designs with the full-capability protocol viewer for 3 G, 6 G and 12 Gbit/s	018	N5436A
DigRF v4	Extend your scope capability with DigRF v4 triggering and decode	051	N8807A
I <sup>2</sup> C/SPI	Extend your scope capability with I <sup>2</sup> C and SPI triggering and decode	007	N5391A
RS232/UART	Easily view the information sent over an RS-232 RS-422, RS-485 or other UART serial buses	015	N5462A
USB 2.0	Trigger on and quickly view USB packets, payload, header and detailed information	016	N5464A
PCI Express gen1 and 2	Quickly view packets, payload, header, and detailed information	017	N5463A
MIPI D-Phy	Easily view the information sent over MIPI serial buses	019	N8802A
CAN/FlexRay	View both protocol-layer information and physical-layer signal characteristics for CAN, LIN and FlexRay buses	063	N8803A
JTAG	Eliminate the difficult task of manually determining JTAG TAP controller states, instruction and data register decode	042	N8817A
SVID	Decode and search on SVID technology	056	N8812A
Unipro decode	Decode at the protocol level	052	–
DDR2/3/4	Trigger and search on difficult-to-find events	–*	–
LPDDR2/3	Decode and search on LPDDR2/3 technology	–*	–

\* Standard on MSO models, not available on DSO or DSA models

## Agilent Infiniium Oscilloscope Portfolio

Agilent's Infiniium oscilloscope lineup includes bandwidths from 600 MHz to 63 GHz. Use the following selection guide to determine which best matches your specific needs. All Infiniium real-time oscilloscopes feature the following:

- World's highest bandwidth on 4 channels in a single frame
- Industry's lowest noise floor
- Full PrecisionProbe compatibility



	9000 Series	90000A Series	90000 X-Series	90000 Q-Series
Available bandwidths	Up to 4 GHz	600 MHz, 1 GHz, 2.5 GHz, 4 GHz	2.5 GHz, 4 GHz,	
	6 to 16 GHz		6 GHz, 8 GHz 12 GHz, 13 GHz	13 GHz, 16 GHz
	20 to 63 GHz			20 GHz, 25 GHz, 28 GHz, 33 GHz
Max upgradable bandwidth	4 GHz	13 GHz	33 GHz	63 GHz
Sample rate (2-channel/4-channel)	10/20 GSa/s	40/40 GSa/s	80/40 GSa/s	160/80 GSa/s
Channel inputs and connector types	50Ω and 1 MΩ, BNCs	50 Ω, BNCs	50 Ω, 2.92 and 3.5 mm SMA's	50Ω, 1.85 mm, 2.4, mm 2.92 and 3.5 mm, SMA's
Memory depth (standard/max)	20 M/1 Gpts	20 M/2 Gpts	20 M/2 Gpts	20 M/2 Gpts
MSO models	Yes	No	Yes	No
Supported InfiniiMax probe families	InfiniiMax 2	InfiniiMax 2	InfiniiMax 3 InfiniiMax 2 with adapter	InfiniiMax 3 InfiniiMax 2 with adapter

# Engineered for 33 GHz true analog bandwidth that delivers

## Configure your high performance real-time oscilloscope solution today

Get the most out of your oscilloscope investment by choosing options and software to speed your most common tasks. Configure your Infiniium X-Series oscilloscope in three easy steps. Use option numbers when ordering at time of purchase. Use model numbers to add to an existing scope.

### 1. Choose your oscilloscope, memory and options

#### Mainframe:

Oscilloscopes	Description
DSAX93204A	33 GHz Signal Analyzer*
DSOX93204A	33 GHz Digital Signal Oscilloscope
MSOX93204A	33 GHz Mixed Signal Oscilloscope
DSAX92804A	28 GHz Signal Analyzer*
DSOX92804A	28 GHz Digital Signal Oscilloscope
MSOX92804A	28 GHz Mixed Signal Oscilloscope
DSAX92504A	25 GHz Signal Analyzer*
DSOX92504A	25 GHz Digital Signal Oscilloscope
MSOX92504A	25 GHz Mixed Signal Oscilloscope
DSAX92004A	20 GHz Signal Analyzer*
DSOX92004A	20 GHz Digital Signal Oscilloscope
MSOX92004A	20 GHz Mixed Signal Oscilloscope
DSAX91604A	16 GHz Signal Analyzer*
DSOX91604A	16 GHz Digital Signal Oscilloscope
MSOX91604A	16 GHz Mixed Signal Oscilloscope
DSAX91304A	13 GHz Signal Analyzer*
DSOX91304A	13 GHz Digital Signal Oscilloscope
MSOX91304A	13 GHz Mixed Signal Oscilloscope

**All models come with power cord, keyboard, mouse, stylus, calibration cable, wrench and (5) coax adapters.\*\***

\* DSA models come with 50 Mpts memory, EZJIT, EZJIT+, EZJIT Complete, and Serial Data Analysis standard.

\*\* 13, 16 and 20 GHz models come with adapters rated to 25 GHz (1250-3758), all other models come with adapters rated to 35 GHz (5061-5311).

\*\*\* 13 GHz models include two N5442A adapters

#### Memory:

Description	Options	Model number
20 Mpts/ch memory	Standard	
50 Mpts/ch memory	DSOX90000A-050	N2810A-050
100 Mpts/ch memory	DSOX90000A-100	N2810A-100
200 Mpts/ch memory	DSOX90000A-200	N2810A-200
500 Mpts/ch memory	DSOX90000A-500	N2810A-500
1 Gpts/ch memory	DSOX90000A-01G	N2810A-01G
2 Gpts/ch memory	DSOX90000A-02G	N2810A-02G



# Engineered for 33 GHz true analog bandwidth that delivers

## Configure your high performance real-time oscilloscope solution today

### 1. Choose your oscilloscope, memory and options *(Continued)*

#### Options:

Description	Options	Model number
ANSI Z540 Compliant calibration	DSOX90000-A6J	
ISO17025 calibration	DSOX90000-1A7	
DVD RW	DSOX90000-820	N5473A
GPIO card-interface	DSOX90000-805	82350B
PCI Express card-interface	DSOX90000-823	N4866A
Performance verification de-skew fixture	DSOX90000-808	N5443A
Rack mount kit option	DSOX90000-1CM	N5470A
Removable solid state drive with Windows 7	DSOX90000-801	
Additional removable solid state drive with Windows 7	(requires option 801)	N2892A

### 2(a). Choose your probes and accessories

Description	Oscilloscopes
30 GHz InfiniiMax III probe amp	N2803A
25 GHz InfiniiMax III probe amp	N2802A
20 GHz InfiniiMax III probe amp	N2801A
16 GHz InfiniiMax III probe amp	N2800A
ZIF probe head	N5439A
Browser (hand held) probe head	N5445A
16 GHz solder-in probe head	N5441A
26 GHz solder-in probe head	N2836A
3.5 mm/2.92-mm/SMA probe head	N5444A
450 Ω ZIF tip replacement (set of 5)	N5440A
250 Ω ZIF tip replacement (set of 5)	N5447A
25 GHz PC board ZIF tip	N2838A
Browser tip replacement (set of 4)	N5476A
PV/deskew fixture	N5443A
Precision BNC adapter (50 ohm)	N5442A
Sampling scope adapter	N5477A
2.92 mm head flex cable	N5448A
High impedance probe adapter	N5449A

For more information about Agilent's InfiniiMax III probing system, check out the InfiniiMax III data sheet with the Agilent literature number, 5990-5653EN.

### 2(b). Choose MSO options

Description	Oscilloscopes
Flying lead set	E5382A
Single-ended soft touch connectorless probe	E5390A
1/2 size soft touch connectorless probe	E5398A
Differential soft touch probe	E5387A

# Engineered for 33 GHz true analog bandwidth that delivers

## Configure your high performance real-time oscilloscope solution today

### 3. Choose your measurement-specific application software

#### Measurement, Analysis and Decode Software Packages

Description	Product number	Model number
PrecisionProbe software	DSOX90000-001	N2809A-001
CAN/FlexRay decode	DSOX90000-063	N8803A
EZJIT jitter analysis software	DSOX90000-002	E2681A
EZJIT Plus jitter analysis software	DSOX90000-004	N5400A
EZJIT Complete analysis software	DSOX90000-070	N8823A
High-Speed SDA and clock recovery	DSOX90000-003	E2688A
I <sup>2</sup> C/SPI Decode	DSOX90000-007	N5391A
InfiniiScan software triggering	DSOX90000-009	N5414B
InfiniiSim basic signal de-embedding	DSOX90000-013	N5465A-001
InfiniiSim advanced signal de-embedding	DSOX90000-014	N5465A-002
Serial data equalization	DSOX90000-012	N5461A
MATLAB - Basic digital analysis package	DSOX90000-061	
MATLAB - Standard digital analysis package	DSOX90000-062	
64b/66b 10Gbase-KR Ethernet Decode	DSOX90000-046	N8815A
MIPI D-PHY protocol	DSOX90000-019	N8802A
PCI-Express protocol	DSOX90000-017	N5463A
RS-232/UART decode	DSOX90000-015	N5462A
SATA/SAS protocol	DSOX90000-018	N8801A
USB protocol	DSOX90000-016	N5464A
User-defined function	DSOX90000-010	N5430A

#### Compliance Testing and Validation Software Packages

Description	Product Number	Model number
DDR1 and LPDDR compliance	DSOX90000A-031	U7233A
DDR2 and LPDDR2 compliance	DSOX90000A-033	N5413B
DDR3 up to 1660 MHz compliance	DSOX90000A-032	U7231A
DisplayPort compliance application	DSOX90000A-028	U7232A
Ethernet compliance application		N5392A
HDMI compliance application	DSOX90000A-023	N5399A
MIPI D-PHY compliance application	DSOX90000A-035	U7238A
PCI Express compliance application	DSOX90000A-022	N5393B
SAS compliance application	DSOX90000A-027	N5412A
SATA 6Gb/s compliance	DSOX90000A-038	N5411B
USB 3.0 compliance software	DSOX90000A-041	U7243A
User-defined application	DSOX90000A-040	N5467A
Xaui compliance application		N5431A
10GBASE-T Ethernet automated test application	DSOX90000A-036	U7236A
SAS-2 compliance test software	DSOX90000A-043	N5412B
PCI Express compliance test software for PCIe 1.0/2.0/3.0	DSOX90000A-004	N5393C
BroadR-Reach compliance	DSOX90000A-065	N6467A
MOST compliance	DSOX90000A-073	N6466A

# Engineered for 33 GHz true analog bandwidth that delivers

## Configure your high performance real-time oscilloscope solution today

### Upgrade your oscilloscope after purchase

#### Bandwidth upgrades

N5471M	13 GHz to 16 GHz Bandwidth upgrade
N5471G	16 GHz to 20 GHz Bandwidth upgrade
N5471H	20 GHz to 25 GHz Bandwidth upgrade
N5471I	25 GHz to 28 GHz Bandwidth upgrade
N5471J	28 GHz to 33 GHz Bandwidth upgrade

#### Memory upgrades

N2810A-050	Upgrade 20 Mpts/ch to 50 Mpts/ch memory
N2810A-100	Upgrade 50 Mpts/ch to 100 Mpts/ch memory
N2810A-200	Upgrade 100 Mpts/ch to 200 Mpts/ch memory
N2810A-500	Upgrade 200 Mpts/ch to 500 Mpts/ch memory
N2810A-01G	Upgrade 500 Mpts/ch to 1 Gpts/ch memory
N2810A-02G	Upgrade 1 Gpts/ch to 2 Gpts/ch memory

#### Operating systems upgrades

N2753A	Windows 7 for Infiniium 90000 X-Series
--------	--

#### Logic analysis upgrades

N2834A	MSO upgrade for the 90000 X-Series
--------	------------------------------------

# Infiniium 90000 X-Series Oscilloscopes

## Performance characteristics

### Vertical

Input channels	Four					
Analog bandwidth (−3 dB)*	<b>91304A</b>	<b>91604A</b>	<b>92004A</b>	<b>92504A</b>	<b>92804A</b>	<b>93204A</b>
2 channel	13 GHz	16 GHz	20 GHz	25 GHz	28 GHz	33 GHz
2 channel*	13 GHz	16 GHz	20 GHz	25 GHz	28 GHz	32 GHz
4 channel	13 GHz	16 GHz	16 GHz	16 GHz	16 GHz	16 GHz
Rise time/fall time	<b>91304A</b>	<b>91604A</b>	<b>92004A</b>	<b>92504A</b>	<b>92804A</b>	<b>93204A</b>
10 - 90%	32 ps	28.5 ps	20 ps	17.5 ps	14.4 ps	12.5 ps
20 - 80%	23 ps	21.5 ps	15 ps	13 ps	11 ps	9 ps
Input impedance <sup>3</sup>	50 Ω, ± 3%					
Sensitivity <sup>2</sup>	1 mV/div to 1 V/div					
Full scale hardware sensitivity	60 mV to 8 V					
Input coupling	DC					
Vertical resolution <sup>1</sup>	8 bits, ≥ 12 bits with averaging					
Channel to channel isolation (any two channels with equal V/div settings)	DC to 16 GHz: 40 dB 16 GHz to BW: 35 dB					
DC gain accuracy*	± 2% of full scale at full resolution channel scale (± 2.5% for 5mV/div)					
Maximum input voltage	± 5 V					
Offset range	<b>Vertical sensitivity</b>		<b>Available offset</b>			
	0 mV/div to ≥ 49 mV/div		± 0.4 V			
	> 50 mV/div to ≥ 100 mV/div		± 0.7 V			
	> 100 mV/div to ≥ 199 mV/div		± 1.2 V			
	> 200 mV/div to ≥ 499 mV/div		± 2.2 V			
	> 500 mV/div		± 2.4 V			
Offset accuracy*	≤ 3.5 V: ± (2% of channel offset + 1% of full scale + 1 mV) > 3.5 V: ± (2% of channel offset + 1% of full scale)					
Dynamic range	± 4 div from center screen					
DC voltage measurement accuracy	Dual cursor: ± [(DC gain accuracy) + (resolution)] Single cursor: ± [(DC gain accuracy) + (offset accuracy) + (resolution/2)]					
RMS noise floor (scope only)	<b>91304A</b>	<b>91604A</b>	<b>92004A</b>	<b>92504A</b>	<b>92804A</b>	<b>93204A</b>
<b>Volts/div (mVrms)</b>						
10 mV	0.28	0.35	0.43	0.50	0.53	0.60
50 mV	1.10	1.34	1.53	1.76	1.86	2.10
100 mV	2.30	2.63	3.02	3.39	3.62	3.98
1 V	21.2	26.65	30.05	34.15	36.57	39.92
	<b>13 GHz</b>	<b>16 GHz</b>	<b>20 GHz</b>	<b>25 GHz</b>	<b>28 GHz</b>	<b>33 GHz</b>
%FS Noise @ 50mV/div	0.295%	0.335%	0.383%	0.440%	0.465%	0.525%

\* Denotes warranted specifications, all others are typical. Specifications are valid after a 30-minute warm up period, and ± 5° C from annual calibration temperature

1. Vertical resolution for 8 bits = 0.4% of full scale, for 12 bits = 0.024% of full scale.

2. Full scale is defined as 8 vertical divisions. Magnification is used below 7.5 mV/div. Below 7.5 mV/div, full-scale is defined as 60 mV/div. The major scale settings are 5mV, 10mV, 20mV, 50mV, 100mV, 200mV, 500mV, and 1V.

3. Input impedance is valid when V/div scaling is adjusted to show all waveform vertical values within scope display.

# Infiniium 90000 X-Series Oscilloscopes

## Performance characteristics

Vertical: digital channels	On all MSO models
Input channels	16 digital channels
Threshold groupings	2 individual threshold settings (1 for channels 0-7 and 1 for channels 8-15)
Threshold selections	TTL (1.4V), CMOS, (2.5V), ECL (-1.3V), PECL (3.7V), user defined ( $\pm 3.00$ V in 100 mV increments)
Maximum input voltage	$\pm 40$ V peak CAT I
Threshold accuracy	$\pm(100$ mV + 3% of threshold setting)
Input dynamic range	$\pm 10$ V about threshold
Minimum input voltage swing	400 mV peak-to-peak
Input impedance (flying leads)	100 k $\Omega$ $\pm$ 2% (~ 8 pF) at probe tip
Resolution	1 bit
Analog bandwidth	3 GHz (depends on probing)

### Horizontal

Main timebase range	2 ps/div to 20 s/div real-time
Main timebase delay range	200 s to -200 s real-time
Zoom timebase range	1 ps/div to current main time scale setting
Channel deskew	$\pm 1$ ms range, 10 fs resolution
Time scale accuracy*	$\pm [0.1$ ppm (immediately after calibration) $\pm 0.1$ ppm/year (aging)]

### Delta-time measurement accuracy

Absolute,  
averaging disabled

$$5 \cdot \sqrt{\left(\frac{\text{Noise}}{\text{SlewRate}}\right)^2 + \text{SampleClock Jitter}^2} + \frac{\text{TimeScaleAccy} \cdot \text{Reading}}{2} \text{ sec rms}$$

Absolute,  
> - 256 averages

$$0.35 \cdot \sqrt{\left(\frac{\text{Noise}}{\text{SlewRate}}\right)^2 + \text{SampleClock Jitter}^2} + \frac{\text{TimeScaleAccy} \cdot \text{Reading}}{2} \text{ sec rms}$$

### Sample Clock Jitter

Acquired Time Range	Internal Timebase Reference	External Timebase Reference
10 ms	100 fs rms	100 fs rms
10 ms - 100 ms	190 fs rms	190 fs rms
100 ms - 1 sec	500 fs rms	190 fs rms
> 1 sec		190 fs rms

### Jitter measurement floor (6a, 6b, 6c)

TIE:

$$\sqrt{\left(\frac{\text{Noise}}{\text{SlewRate}}\right)^2 + \text{SampleClock Jitter}^2} \text{ sec rms}$$

Periodic Jitter:

$$\sqrt{2} \cdot \sqrt{\left(\frac{\text{Noise}}{\text{SlewRate}}\right)^2 + \text{SampleClock Jitter}^2} \text{ sec rms}$$

Cycle-Cycle:

$$\sqrt{3} \cdot \sqrt{\left(\frac{\text{Noise}}{\text{SlewRate}}\right)^2 + \text{SampleClock Jitter}^2} \text{ sec rms}$$

# Infiniium 90000 X-Series Oscilloscopes

## Performance characteristics

### Acquisition

Maximum real-time sample rate	91304A	91604A	92004A	92504A	92804A	93204A
(2 channels)	80 GSa/s	80 GSa/s	80 GSa/s	80 GSa/s	80 GSa/s	80 GSa/s
(4 Channels)	40 GSa/s	40 GSa/s	40 GSa/s	40 GSa/s	40 GSa/s	40 GSa/s

### Memory depth per channel

Standard	20 Mpts on 4 channels	40 Mpts on 2 channels
Option 050	50 Mpts on 4 channels (standard on DSA models)	100 Mpts on 2 channels
Option 100	100 Mpts on 4 channels	200 Mpts on 2 channels
Option 200	200 Mpts on 4 channels	400 Mpts on 2 channels
Option 500	500 Mpts on 4 channels	1 Gpt on 2 channels
Option 01G	1 Gpts on 4 channels	1 Gpt on 2 channels
Option 02G	2 Gpts on 4 channels	2 Gpts on 2 channels

### Maximum acquired time at highest real time resolution

Real-time resolution	40 Gsa/s	80 Gsa/s
Standard	0.5 mS	0.5 mS
Option 050	1.25 mS	1.25 mS
Option 100 M	2.5 mS	2.5 mS
Option 200 M	5 mS	5 mS
Option 500 M	12.5 mS	12.5 mS
Option 01G	25 mS	12.5 mS
Option 02G	50 mS	25 mS

### Acquisition: digital channels

Maximum real time sample rate	10 GSa/s at 16 channels, 20 GSa/s at 8 channels
Maximum memory depth per channel	Up to 1 Gpt
Minimum width glitch detection	50 pS

### Sampling modes

Real-time	Successive single shot acquisitions
Real-time with averaging	Averages are selectable from 2 to 65534
Real-time with peak detect	80 GSa/s in half channel mode, 40 GSa/s in full channel mode
Real-time with hi resolution	Real-time boxcar averaging reduces random noise and increases resolution
Gaussian magnitude, linear phase	Slower filter roll off while maintaining linear phase
Roll mode	Scrolls sequential waveform points across the display in a right-to-left rolling motion. Works at sample rates up to 10 MSa/s with a maximum record length of 40 Mpts
Segmented memory	Captures bursting signals at max sample rate without consuming memory during periods of inactivity Number of segments (Up to 524,288 with option 02G) Maximum time between triggers is 562,950 seconds Re-arm time: 4.5µs Maximum memory depth: Up to 4 Gpts in 1/2 channel mode with option 02G
Filters	
Sin(x)/x Interpolation	On/off selectable FIR digital filter. Digital Signal Processing adds points between acquired data points to enhance measurement accuracy and waveform display

# Infiniium 90000 X-Series Oscilloscopes

## Performance characteristics

### Hardware trigger

Sensitivity	Internal low: 2.0 div p-p 0 to 22 GHz Internal high: 0.3 div p-p 0 to 18 GHz, 1.0 div p-p 0 to 22 GHz Auxiliary: 2.5 GHz
Edge trigger bandwidth	>20 GHz
Minimum pulse width trigger	
Hardware	250 ps
Software (InfiniiScan)	40 ps
Level range	
Internal	$\pm 4$ div from center screen or $\pm 4$ Volts, whichever is smallest
Auxillary	$\pm 5$ V, also limit input signal to $\pm 5$ V
Sweep modes	Single, segmented, and continuous
Display jitter (displayed trigger jitter)	50 fs
Trigger sources	Channel 1, Channel 2, Channel 3, Channel 4, aux, and line
Trigger modes	
Edge	Triggers on a specified slope (rising, falling or alternating between rising and falling) and voltage level on any channel or auxiliary trigger. Edge trigger bandwidth is > 20 GHz.
Edge transition	Trigger on rising or falling edges that cross two voltage levels in > or < the amount of time specified. Edge transition setting from 250 ps.
Edge then edge (time)	The trigger is qualified by an edge. After a specified time delay between 10 ns to 10 s, a rising or falling edge on any one selected input will generate the trigger.
Edge then edge (event)	The trigger is qualified by an edge. After a specified delay between 1 to 16,000,000 rising or falling edges, another rising or falling edge on any one selected input will generate the trigger
Glitch	Triggers on glitches narrower than the other pulses in your waveform by specifying a width less than your narrowest pulse and a polarity. Triggers on glitches as narrow as 125 ps. Glitch range settings: < 250 ps to < 10 s.
Line	Triggers on the line voltage powering the oscilloscope.
Pulse width	Triggers on a pulse that is wider or narrower than the other pulses in your waveform by specifying a pulse width and a polarity. Triggers on pulse widths as narrow as 125 ps. Pulse width range settings 250 ps to 10 s. Trigger point can be "end of pulse" or "time out."
Runt	Triggers on a pulse that crosses one threshold but fails to cross a second threshold before crossing the first again. Can be time qualified with minimum setting of 250 ps.
Timeout	Triggers when a channel stays high, low, or unchanged for too long. Timeout setting: from 250 ps to 10 s.
Pattern/pulse range	Triggers when a specified logical combination of the channels is entered, exited, present for a specified period of time or is within a specified time range or times out. Each channel can have a value of high (H), low (L) or don't care (X).
State	Pattern trigger clocked by the rising, falling or alternating between rising and falling edge of one channel.
Window	Triggers on an event associated with a window defined by two-user adjustable thresholds. Event can be window "entered," "exited," "inside (time qualified)," or "outside (time qualified)" voltage range. Trigger point can be "cross window boundary" or "time out." Time qualify range: from 250 ps to 10 s.

# Infiniium 90000 X-Series Oscilloscopes

## Performance characteristics

### Hardware trigger *(Continued)*

Video	Triggers from negative sync composite video, field 1, field 2, or alternating fields for interlaced systems, any field, specific line, or any line for interlaced or non-interlaced systems. Supports NTSC, PAL-M (525/60), PAL, SECAM (625/50), EDTV (480p/60), EDTV (576p/50), HDTV (720p/60), HDTV (720p/50), HDTV (1080i/60), HDTV (1080i/50), HDTV (1080p/60), HDTV (1080p/50), HDTV (1080p/30), HDTV (1080p/25), HDTV (1080p/24), and user-defined formats.
Trigger sequences	Three stage trigger sequences including two-stage hardware (Find event (A) and Trigger event (B)) and one-stage InfiniiScan software trigger. Supports all hardware trigger modes except "edge then edge" and "video," and all InfiniiScan software trigger modes. Supports "delay (by time)" and "reset (by time or event)" between two hardware sequences. The minimum latency between "find event (A)" and "trigger event (B)" is 3 ns.
Trigger qualification AND qualifier	Single or multiple channels may be logically qualified with any other trigger mode.
Trigger holdoff range	100nS to 10s
Trigger actions	Specify an action to occur and the frequency of the action when a trigger condition occurs. Actions include e-mail on trigger and execute "multipurpose" user setting.

### Software trigger (requires InfiniiScan event identification software – Option 009)

Trigger modes	
Zone qualify	Software triggers on the user defined zones on screen. Zones can be specified as either "must intersect" or "must not intersect." Up to eight zones can be defined across multiple channels.
Generic serial	Software triggers on NRZ-encoded data up to 8.0 Gbps, up to 80-bit pattern. Support multiple clock data recovery methods including constant frequency, 1st-order PLL, 2nd-order PLL, explicit clock, explicit 1st-order PLL, explicit 2nd-order PLL, Fibre Channel, FlexRay receiver, FlexRay transmitter (requires E2688A except for the constant frequency clock data recovery mode).
Measurement limit	Software triggers on the results of the measurement values. For example, when the "pulse width" measurement is turned on, InfiniiScan measurement software trigger triggers on a glitch as narrow as 75 ps. When the "time interval error (TIE)" is measured, InfiniiScan can trigger on a specific TIE value.
Non-monotonic edge	Software triggers on the non-monotonic edge. The non-monotonic edge is specified by setting a hysteresis value.
Runt	Software triggers on a pulse that crosses one threshold but fails to cross a second threshold before crossing the first again. Unlike hardware runt trigger, InfiniiScan runt trigger can be further qualified via a hysteresis value.

### Trigger: digital channels MSO models

Threshold range (user defined)	±8.0 V in 100-mV increments
Threshold accuracy	±(100 mV + 3% of threshold setting)



# Infiniium 90000 X-Series Oscilloscopes

## Performance characteristics

Maximum measurement update rate	> 50,000 measurement/sec (one measurement turned on) > 250,000 measurement/sec/measurement (ten measurements turned on)
Measurement modes	Standard, Measure all edges mode
Waveform measurements	
Voltage	Peak to peak, minimum, maximum, average, RMS, amplitude, base, top, overshoot, preshoot, upper, middle, lower, overshoot, V preshoot, crossing, Pulse base, pulse amplitude, burst interval
Time	Rise time, fall time, positive width, negative width, burst width, Tmin, Tmax, burst period, Tvolt, + pulse count, - pulse count, burst and burst interval
Clock	Period, frequency, duty cycle to duty cycle
Data	Setup time, hold time
Mixed	Area, slew rate
Frequency domain	FFT frequency, FFT magnitude, FFT delta frequency, FFT delta magnitude, peak detect mode, amplitude modulation
Level qualification	Any channels that are not involved in a measurement can be used to level-qualify all timing measurements
Eye-diagram measurements	Eye height, eye width, eye jitter, crossing percentage, Q factor, and duty-cycle distortion
Jitter analysis measurements	Requires Option 002 (or E2681A), 004 (or N5400A), or 070 (or N8823A). Standard on DSA Series
Clock	Time interval error, N-period, period to period, positive width to positive width, neg width to neg width, and duty cycle to duty cycle
Data	Time interval error, unit interval, N Unit Interval, unit interval to unit interval, Data rate, CDR, de-emphasis
Jitter separation**	Spectral Method (narrow and wide), tailfit
Measurements**	Random Jitter (RJ), Deterministic Jitter (DJ), Aperiodic Bounded Uncorrelated Jitter (ABUJ), periodic jitter, data dependent jitter (DDJ), duty cycle distortion (DCD), Intersymbol Interference (ISI)
Fixed measurements**	Ability to fix random jitter (Rj) for cross-talk measurements
Statistics	Displays the current, mean, minimum, maximum, range (max-min), standard deviation, number of measurements value for the displayed automatic measurements
Histograms	
Source	Waveform or measurement
Orientation	Vertical (for timing and jitter measurements) or horizontal (noise and amplitude change) modes, regions are defined using waveform markers
Measurements	Mean, standard deviation, mean $\pm$ 1, 2, and 3 sigma, median, mode, peak-to-peak, min, max, total hits, peak (area of most hits), X scale hits, and X offset hits
Mask testing	Allows pass/fail testing to user-defined or Agilent-supplied waveform templates. Automask lets you create a mask template from a captured waveform and define a tolerance range in time/voltage or screen divisions. Test modes (run until) include test forever, test to specified time or event limit, and stop on failure. Executes "multipurpose" user setting on failure. "Unfold real time eye" feature will allow individual bit errors to be observed by unfolding a real time eye when clock recovery is on. Communications mask test kit option provides a set of ITU-T G.703, ANSI T1.102, and IEEE 802.3 industry-standard masks for compliance testing.

\* Requires the purchase of User Defined Function (option 010)

\*\* Requires purchase of DSA or EZJIT+ or EZJIT Complete software

# Infiniium 90000 X-Series Oscilloscopes

## Performance characteristics

---

Waveform math	
Number of functions	Sixteen
Hardware accelerated math	Differential and Common Mode
Operations/functions	Absolute value, add, average, Butterworth*, common mode, differentiate, divide, FFT magnitude, FFT phase, FIR*, high pass filter, histogram, integrate, invert, LFE*, low pass filter (4th-order Bessel Thompson filter), measurement trend, magnify, max, min, multiply, RT Eye*, smoothing, SqrtSumOf-Square*, square, square root, subtract, versus, and optional user defined function (Option 010)

---

Measurement gating	Supports up to 16 horizontal measurement gates
--------------------	--

---

FFT	
Frequency range	DC to 40 GHz (at 80 GSa/s) or 20 GHz (at 40 GSa/s)
Frequency resolution	Sample rate/memory depth = resolution
Window modes	Hanning, flattop, rectangular, Blackman-Harris

Measurement modes	
Automatic measurements	Measure menu access to all measurements, up to ten measurements can be displayed simultaneously
Multipurpose	
Drag-and-drop measurement toolbar	Front-panel button activates up to ten pre-selected or up to ten user-defined automatic measurements Measurement toolbar with common measurement icons that can be dragged and dropped onto the displayed waveforms
Snapshot	Takes 29 snap shot measurements (customizable)

---

Marker modes	Manual markers, track waveform data, track measurements
--------------	---

---

<b>Display</b>	
Display	12.1-inch color XGA TFT-LCD with touch screen
Intensity grayscale	256-level intensity-graded display
Resolution XGA	1024 pixels horizontally x 768 pixels vertically
Annotation	Up to 12 labels, with up to 100 characters each, can be inserted into the waveform area
Grids	Up to 16 waveform grids, each with 8-bit vertical resolution
Waveform styles	Connected dots, dots, infinite persistence, color graded infinite persistence. Includes up to 256 levels of intensity-graded waveforms

---

Waveform update rate	
Maximum update rate	> 400,000 waveforms per second (when in the segment memory mode)

---

# Infiniium 90000 X-Series Oscilloscopes

## Performance characteristics

---

Computer system and peripherals	
Operating system	Windows 7
CPU	Intel® Core 2 Duo 3.06 GHz
PC system memory	4GB DDR2
Drives	≥ 250-GB internal hard drive Optional removable solid state drive (Option 801) Optional USB external DVD-RW drive (Option 820)
Peripherals	Logitech optical USB mouse, compact USB keyboard and stylus supplied. All Infiniium models support any Windows-compatible input device with a serial, PS/2 or USB interface

---

File types	
Waveforms	Compressed internal format (*.wfm (200 Mpts)), comma-separated values (*.csv (2 Gpts)), tab separated values (*.tsv (2 Gpts)), public binary format (.bin (500 Mpts)), Y value files (*.txt (2 Gpts)), hierarchal data file (*.hf5 (2 Gpts)), composite data file (*.osc (2 Gpts))
Images	BMP, PNG, TIFF, GIF or JPEG

---

I/O ports	PCIe x4, GPIB, RS-232 (serial), Parallel, PS/2, USB 2.0 hi-speed (host), USB 2.0 hi-speed (device), Dual-monitor video output, Auxiliary output, Trigger output, Time base reference output
-----------	---

---

General Characteristics	
Temperature	Operating: 5 to +40 °C Non-operating: -40 to +65 °C
Humidity	Operating: up to 95% relative humidity (non-condensing) at +40 °C Non-operating: up to 90% relative humidity at +65 °C
Altitude	Operating: up to 4,000 meters (12,000 feet) Non-operating: up to 15,300 meters (50,000 feet)
Vibration	For operating random the 0.3 g(rms) should be 0.21 g(rms), for non-operating random the 2.41 g(rms) should be 2.0 g(rms) and for swept sines the (0.75g) should be (0.50g)
Power*	100 - 240 VAC at 50/60 Hz; input power 800 Watts
Weight	45.1 lbs (20.5 kg)
Dimensions	10.5 x 16.75 x 18.7" (27 x 43 x 48 cm)
Safety	Meets IEC 61010-1 +A2, CSA certified to C22.2 No.1010.1, self-certified to UL 3111
Pollution degree	2
Installation category	2
Measurement category	1
For indoor use only	

---

\* Main supply voltage fluctuations are not to exceed ±10% of the nominal supply voltage

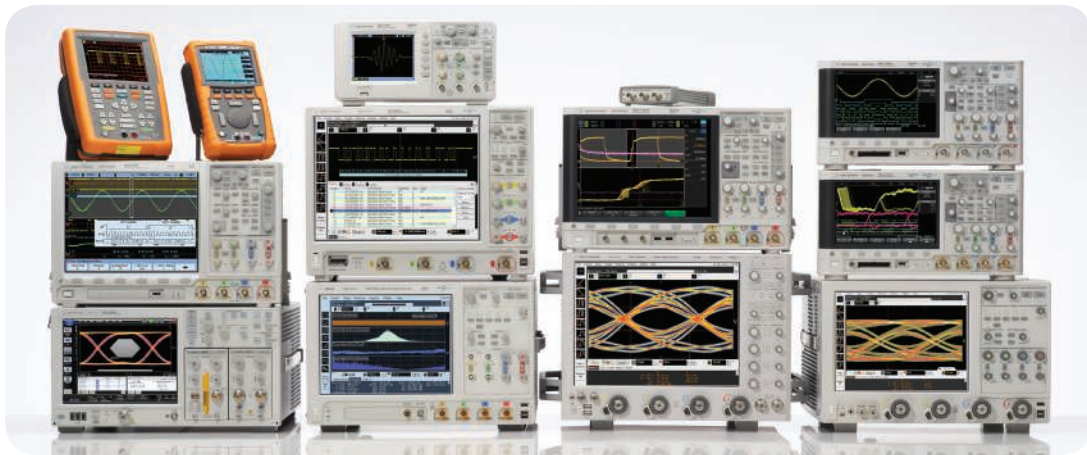

## Agilent Technologies Oscilloscopes

Multiple form factors from 20 MHz to > 90 GHz | Industry leading specs | Powerful applications



**myAgilent**

[www.agilent.com/find/myagilent](http://www.agilent.com/find/myagilent)

A personalized view into the information most relevant to you.



**www.lxistandard.org**

LAN eXtensions for Instruments puts the power of Ethernet and the Web inside your test systems. Agilent is a founding member of the LXI consortium.



**www.pxisa.org**

PCI eXtensions for Instrumentation (PXI) modular instrumentation delivers a rugged, PC-based high-performance measurement and automation system.



**Three-Year Warranty**

[www.agilent.com/find/ThreeYearWarranty](http://www.agilent.com/find/ThreeYearWarranty)

Beyond product specification, changing the ownership experience. Agilent is the only test and measurement company that offers three-year warranty on all instruments, worldwide.



**Agilent Assurance Plans**

[www.Agilent.com/find/AssurancePlans](http://www.Agilent.com/find/AssurancePlans)

Five years of protection and no budgetary surprises to ensure your instruments are operating to specifications and you can continually rely on accurate measurements.



**www.agilent.com/quality**

Agilent Electronic Measurement Group  
DEKRA Certified ISO 9001:2008  
Quality Management System

**Agilent Channel Partners**

[www.agilent.com/find/channelpartners](http://www.agilent.com/find/channelpartners)

Get the best of both worlds: Agilent's measurement expertise and product breadth, combined with channel partner convenience.

For more information on Agilent Technologies' products, applications or services, please contact your local Agilent office. The complete list is available at: [www.agilent.com/find/contactus](http://www.agilent.com/find/contactus)

**Americas**

Canada	(877) 894 4414
Brazil	(11) 4197 3600
Mexico	01800 5064 800
United States	(800) 829 4444

**Asia Pacific**

Australia	1 800 629 485
China	800 810 0189
Hong Kong	800 938 693
India	1 800 112 929
Japan	0120 (421) 345
Korea	080 769 0800
Malaysia	1 800 888 848
Singapore	1 800 375 8100
Taiwan	0800 047 866
Other AP Countries	(65) 375 8100

**Europe & Middle East**

Belgium	32 (0) 2 404 93 40
Denmark	45 45 80 12 15
Finland	358 (0) 10 855 2100
France	0825 010 700*
	*0.125 €/minute
Germany	49 (0) 7031 464 6333
Ireland	1890 924 204
Israel	972-3-9288-504/544
Italy	39 02 92 60 8484
Netherlands	31 (0) 20 547 2111
Spain	34 (91) 631 3300
Sweden	0200-88 22 55
United Kingdom	44 (0) 118 927 6201

For other unlisted countries:

[www.agilent.com/find/contactus](http://www.agilent.com/find/contactus)

(BP-10-29-13)

Product specifications and descriptions in this document subject to change without notice.

MATLAB® is a U.S. registered trademark of The Math Works, Inc.  
PCI Express®, PCIe and PCI-SIG are registered trademarks of PCI-SIG

