

Keysight Infiniium V-Series Oscilloscopes

Notices

© Keysight Technologies 2015-2016, 2018

No part of this manual may be reproduced in any form or by any means (including electronic storage and retrieval or translation into a foreign language) without prior agreement and written consent from Keysight Technologies, Inc. as governed by United States and international copyright laws.

Manual Part Number

54919-97006

Edition

Third Edition, April 2018

Available in electronic format only

Published by:

Keysight Technologies, Inc.
1900 Garden of the Gods Road
Colorado Springs, CO 80907 USA

Warranty

The material contained in this document is provided “as is,” and is subject to being changed, without notice, in future editions. Further, to the maximum extent permitted by applicable law, Keysight disclaims all warranties, either express or implied, with regard to this manual and any information contained herein, including but not limited to the implied warranties of merchantability and fitness for a particular purpose. Keysight shall not be liable for errors or for incidental or consequential damages in connection with the furnishing, use, or performance of this document or of any information contained herein. Should Keysight and the user have a separate written agreement with warranty terms covering the material in this document that conflict with these terms, the warranty terms in the separate agreement will control.

Technology Licenses

The hardware and/or software described in this document are furnished under a license and may be used or copied only in accordance with the terms of such license.

U.S. Government Rights

The Software is "commercial computer software," as defined by Federal Acquisition Regulation ("FAR") 2.101. Pursuant to FAR 12.212 and 27.405-3 and Department of Defense FAR Supplement ("DFARS") 227.7202, the U.S. government acquires commercial computer software under the same terms by which the software is customarily provided to the public. Accordingly, Keysight provides the Software to U.S. government customers under its standard commercial license, which is embodied in its End User License Agreement (EULA), a copy of which can be found at www.keysight.com/find/sweula. The license set forth in the EULA represents the exclusive authority by which the U.S. government may use, modify, distribute, or disclose the Software. The EULA and the license set forth therein, does not require or permit, among other things, that Keysight: (1) Furnish technical information related to commercial computer software or commercial computer software documentation that is not customarily provided to the public; or (2) Relinquish to, or otherwise provide, the government rights in excess of these rights customarily provided to the public to use, modify, reproduce, release, perform, display, or disclose commercial computer software or commercial computer software documentation. No additional government requirements beyond those set forth in the EULA shall apply, except to the extent that those terms, rights, or licenses are explicitly required from all providers of commercial computer software pursuant to the FAR and the DFARS and are set forth specifically in writing elsewhere in the EULA. Keysight shall be under no obligation to update, revise or otherwise modify the Software. With respect to any technical data as defined by FAR 2.101, pursuant to FAR 12.211 and 27.404.2 and DFARS 227.7102, the U.S. government acquires no greater than Limited Rights as defined in FAR 27.401 or DFAR 227.7103-5 (c), as applicable in any technical data.

Safety Notices

CAUTION

A **CAUTION** notice denotes a hazard. It calls attention to an operating procedure, practice, or the like that, if not correctly performed or adhered to, could result in damage to the product or loss of important data. Do not proceed beyond a **CAUTION** notice until the indicated conditions are fully understood and met.

WARNING

A **WARNING** notice denotes a hazard. It calls attention to an operating procedure, practice, or the like that, if not correctly performed or adhered to, could result in personal injury or death. Do not proceed beyond a **WARNING** notice until the indicated conditions are fully understood and met.

For more safety information, refer to the *For Your Safety* booklet included with your Infiniium oscilloscope.

Infiniium V-Series Oscilloscopes—At a Glance

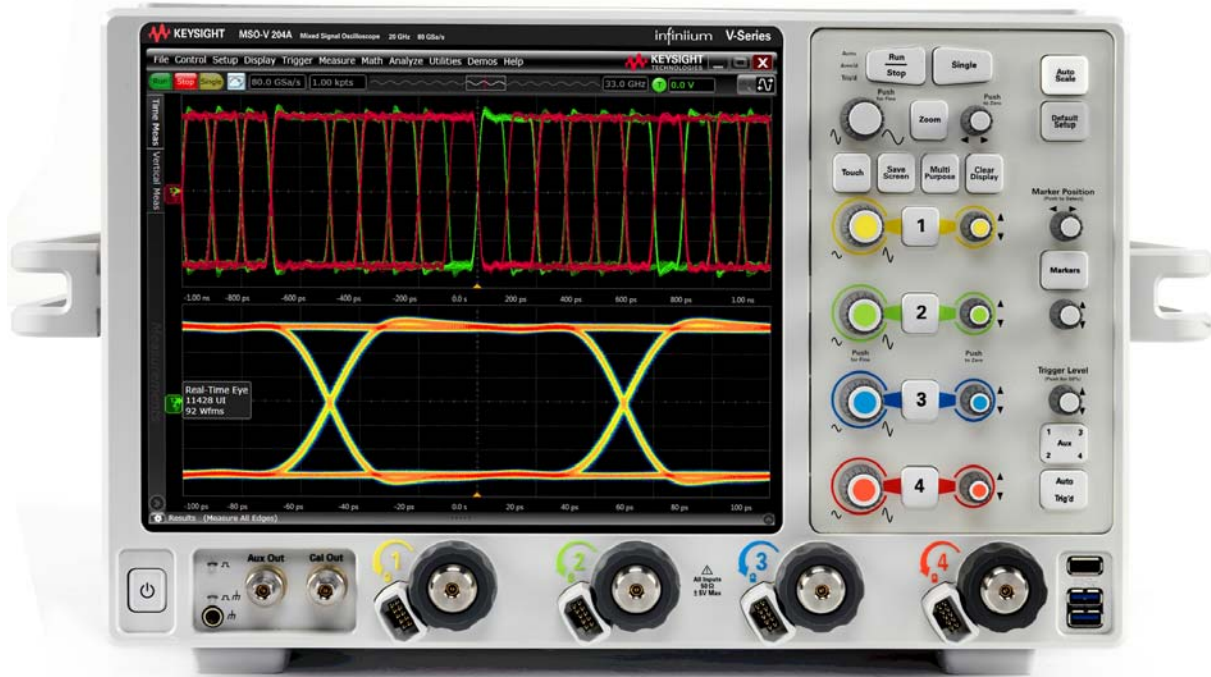

Model	Bandwidth
MSOV084A, DSOV084A, DSAV084A	8 GHz bandwidth
MSOV134A, DSOV134A, DSAV134A	13 GHz bandwidth
MSOV164A, DSOV164A, DSAV164A	16 GHz bandwidth
MSOV204A, DSOV204A, DSAV204A	20 GHz bandwidth
MSOV254A, DSOV254A, DSAV254A	25 GHz bandwidth
MSOV334A, DSOV334A, DSAV334A	33 GHz bandwidth (typical)

The Infiniium V-Series oscilloscopes provide superior measurements, advanced probing, and go-to applications, helping you move rapidly from first silicon to crucial insights.

Ease of use with high performance

The Infiniium V-Series oscilloscopes combine unprecedented ease-of use with high-performance digitizing oscilloscope functionality to simplify your design and analysis measurement tasks.

- Traditional oscilloscope front-panel interface provides direct access to the controls needed for most troubleshooting tasks.

- User interface with menus, windows, dialog boxes, toolbars, and wizards provides easy access to dozens of configuration and analysis tools, ensuring you can set up and make the most complex measurements.
- Models with bandwidths from 8 GHz to 33 GHz.
- All models feature 2 channels of 80 GS/s on all bandwidths.
- MSO models provide 10 GS/s at 16 channels and 20 GS/s at 8 channels.
- The high-speed hardware serial trigger option lets you quickly debug difficult problems, including discovering logic errors in your digital designs.

Display shows waveforms and user interface

- User interface allows direct interaction with waveforms, including drag-and-drop positioning and instant waveform zoom.
- Large capacitive touch screen with multi-touch (gestures), handles, and resizing allows oscilloscope operation without an external pointing device.
- Waveforms are displayed in color, making correlation easy.
- Current configuration parameters displayed near the waveform display area are color-coded to make identification easy.
- Menus and toolbars simplify complex measurement setups.

Acquisition and general controls start and stop the oscilloscope and do basic setup

- Run, stop, and single controls for continuous or single acquisitions.
- Clear display before one or more acquisitions.
- Default setup and Autoscale set initial configuration.

Removable solid-state drive and USB 2.0 and 3.0 ports for saving and restoring setups and measurement results

- Store measurement displays for inclusion in reports and test setup guides.
- Store oscilloscope setups to repeat tests another time.
- Hard disk stores oscilloscope operating system.

Trigger setup controls set mode and basic parameters

- Select Edge, Glitch, or Advanced Modes.
- Choose input source and slope.
- Use auxiliary trigger to increase triggering flexibility.

Vertical controls set attenuation and position

- Color-coded knobs make it easy to find the controls that affect each waveform.

Marker and quick measurements help measure waveform parameters

- Use multiple waveform markers to check voltage or Δ -time at any point on the displayed waveform.

In This Guide

This guide provides the information you need to begin using the Infiniium V-Series oscilloscopes.

Chapter 1, “Setting Up the Oscilloscope,” starting on page 11, includes power and air flow requirements, plus other setup information.

Chapter 2, “Using the Oscilloscope,” starting on page 25, familiarizes you with the inputs and outputs, front-panel controls, and user interface, and describes how to perform basic operations with the oscilloscope.

Chapter 3, “Online Help and Other Information,” starting on page 49, describes the Infiniium oscilloscope application’s online help contents and online demos. The online help describes how to use the Infiniium oscilloscope application in detail.

For More Information

- For detailed information on how the oscilloscope makes measurements and how to use the oscilloscope, see the Infiniium oscilloscope application’s online help. See **“Accessing the Online Help”** on page 49.
- For information on controlling the oscilloscope from a remote computer, see the *Keysight Infiniium Oscilloscopes Programmer’s Guide* found in the Infiniium oscilloscope application’s online help.
- For information on testing and servicing the oscilloscope, see the *Service Guide* found in the Infiniium oscilloscope application’s online help.

For technical assistance, contact your local Keysight Technologies representative at www.keysight.com/find/contactus.

Contents

Infiniium V-Series Oscilloscopes—At a Glance / 3

In This Guide / 5

1 Setting Up the Oscilloscope

Inspecting Package Contents / 12

Specifications and Characteristics / 13

Positioning for Proper Airflow / 14

Connecting Accessories and a LAN Cable to the Oscilloscope / 15

Connecting Power to the Oscilloscope / 16

Connecting Oscilloscope Probes / 17



Maximum Input Voltage / 17

Connecting Threaded RF Cables / 18

Tilting the Oscilloscope for Easier Viewing / 18

Turning On the Oscilloscope / 19

Verifying Basic Oscilloscope Operation / 20

Installing Application Programs on Infiniium / 21

Changing Windows Operating System Settings / 22

Turning Off the Oscilloscope / 23

Cleaning the Oscilloscope / 23

2 Using the Oscilloscope

Front Panel Inputs and Outputs / 26

Channel Inputs / 26

Ground / 26

Aux Out / 26

Cal Out / 26

Probe compensation terminal / 27

USB host ports / 27

Back Panel Inputs and Outputs	/ 28
Motherboard I/O	/ 28
10 MHz In, 10 MHz Out	/ 29
Trig Out	/ 29
Aux Trig	/ 29
Learning the Front Panel Controls (Keys and Knobs)	/ 30
Learning the Oscilloscope Display	/ 31
Using the Setup and Display Controls	/ 33
Using Auto Scale and Default Setup	/ 33
Using the Touch Screen	/ 33
Saving the Screen Image	/ 33
Using Quick Measurements	/ 34
Clearing the Waveform Display	/ 34
Starting and Stopping Waveform Acquisitions	/ 35
Adjusting the Horizontal Settings	/ 36
Adjusting the Horizontal Scale	/ 36
Adjusting the Horizontal Trigger Position (Delay)	/ 37
Magnifying a Part of the Waveform using Zoom	/ 37
Setting the Scale, Position, and Timebase Reference Point	/ 37
Adjusting the Vertical Settings	/ 39
Turning an Analog Channel On or Off	/ 39
Adjusting an Analog Channel's Vertical Scale and Offset	/ 40
Setting Up Triggers	/ 41
Setting the Oscilloscope to Trigger on an Edge	/ 41
Using Markers and Making a Measurement	/ 42
Making a Measurement on a Waveform	/ 43
Using Markers	/ 43
Controlling Digital Channels	/ 44
Saving and Printing Data	/ 45
Forcing a Default Setup	/ 46
Infiniium Hard Drive Recovery	/ 46

3 Online Help and Other Information

Accessing the Online Help	/ 49
Navigating the Online Help	/ 50
Using the Demo Wizard	/ 51
Safety	/ 52

Safety Compliance / 52
Acoustic Statement / 52
General Safety Notices / 52

Symbols / 53

Index

1 Setting Up the Oscilloscope

Inspecting Package Contents /	12
Specifications and Characteristics /	13
Positioning for Proper Airflow /	14
Connecting Accessories and a LAN Cable to the Oscilloscope /	15
Connecting Power to the Oscilloscope /	16
Connecting Oscilloscope Probes /	17
Connecting Threaded RF Cables /	18
Tilting the Oscilloscope for Easier Viewing /	18
Turning On the Oscilloscope /	19
Verifying Basic Oscilloscope Operation /	20
Installing Application Programs on Infiniium /	21
Changing Windows Operating System Settings /	22
Turning Off the Oscilloscope /	23
Cleaning the Oscilloscope /	23

This chapter shows how to set up and prepare your Infiniium oscilloscope for first-time use.

Inspecting Package Contents

- ✓ Inspect the shipping container for damage.
 - Keep the shipping container or cushioning material until you have inspected the contents of the shipment for completeness and have checked the oscilloscope mechanically and electrically.
 - If the shipping container is damaged, or the cushioning materials show signs of stress, notify the carrier and your Keysight Technologies Sales Office. Keep the shipping materials for the carrier's inspection. The Keysight Technologies Sales Office will arrange for repair or replacement at Keysight's option without waiting for claim settlement.

- ✓ Inspect the oscilloscope.

If there is mechanical damage or a defect, or if the oscilloscope does not operate properly or does not pass performance tests, notify your Keysight Technologies Sales Office.

- ✓ Verify that you received the following items in the Infiniium oscilloscope packaging.

- Infiniium oscilloscope
- Power cord
- Keyboard
- Mouse (USB optical)
- Front panel cover
- Calibration cable
- Connector saver collars (kit of 10)
- Connector savers, 3.5mm f-f (quantity of 5)
- ESD wrist strap
- Quick Start Guide
- *For Your Safety* document
- Digital channels cable (MSO models only)
- MSO calibrator board assembly (MSO models only)

If anything is missing, contact your nearest Keysight Technologies Sales Office.

- ✓ Verify that you received the options and accessories you ordered and that none were damaged.

For a complete list of options and accessories available for the V-Series oscilloscopes, see the [*Infiniium V-Series Oscilloscopes Data Sheet*](#).

Specifications and Characteristics

Environment	Indoor use only
Ambient Temperature	Operating +5 °C to +40 °C Non-operating -40 °C to +65 °C
Humidity	Operating: up to 95% relative humidity (non-condensing) at +40 °C Non-operating: up to 90% relative humidity at +65 °C
Altitude	Operating: up to 4,000 meters (13,000 feet) Non-operating: up to 15,300 meters (50,000 feet)
Installation Category	II
Weight	52.2 lbs.
Dimensions	10.5 in. tall (27 cm), 17.2 in. wide (44 cm), and 19.4 in. deep (49 cm)
Safety	IEC 61010-1:2010/EN 61010-1 3rd edition CAN/CSA-c22.2 No. 61010-1-12 UL 61010-1 3rd edition
Power Requirements	100-240 VAC at 50/60 Hz; Input power not to exceed 800 W
Voltage Fluctuations	The mains supply voltage fluctuations are not to exceed $\pm 10\%$ of the nominal supply voltage.
Pollution Degree	The Infiniium V-Series oscilloscopes may be operated in environments of Pollution Degree 2.
Pollution Degree Definitions	<p>Pollution Degree 1: No pollution or only dry, non-conductive pollution occurs. The pollution has no influence. Example: A clean room or climate-controlled office environment.</p> <p>Pollution Degree 2. Normally only dry non-conductive pollution occurs. Occasionally a temporary conductivity caused by condensation may occur. Example: General indoor environment.</p> <p>Pollution Degree 3: Conductive pollution occurs, or dry, non-conductive pollution occurs which becomes conductive due to condensation which is expected. Example: Sheltered outdoor environment.</p>

Positioning for Proper Airflow

Position the oscilloscope where it will have sufficient clearance for airflow around the back and sides.

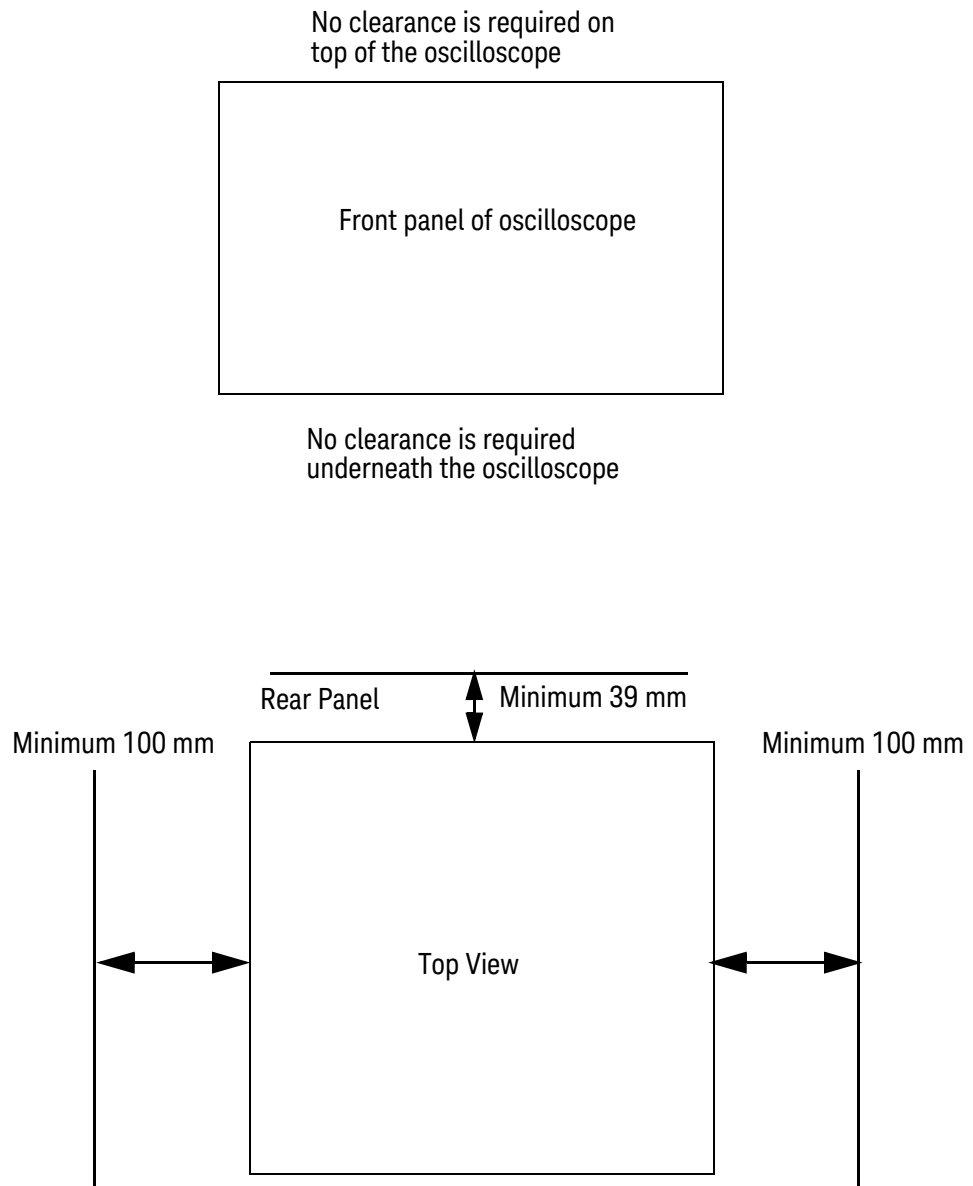

Figure 1 Positioning the V-Series oscilloscope with sufficient clearance

CAUTION

When installing the instrument(s) into a cabinet, consider the convection flow into and out of the cabinet. Also consider the individual instruments, to avoid having the heated discharge of one instrument become the cooling intake air for another instrument.

Connecting Accessories and a LAN Cable to the Oscilloscope

- 1 Plug the mouse and keyboard into the USB host ports. Four USB host ports are on the rear panel, with three more on the front panel.
- 2 If you want to connect to a Local Area Network, connect your LAN cable to the RJ-45 connector on the back panel of the oscilloscope. Connect the other end to an open LAN port.

If the oscilloscope is an MSO model, connect the digital channels cable to the accessory I/O connector, making sure to orient the cable as shown by the drawing on the back panel of MSO models. This connector is covered unless your oscilloscope is an MSO model or you purchased an accessory option.

CAUTION

Be sure to orient the MSO cable as shown in the drawing on the back panel of MSO models. Inserting the cable incorrectly could bend the pins or cause errors.

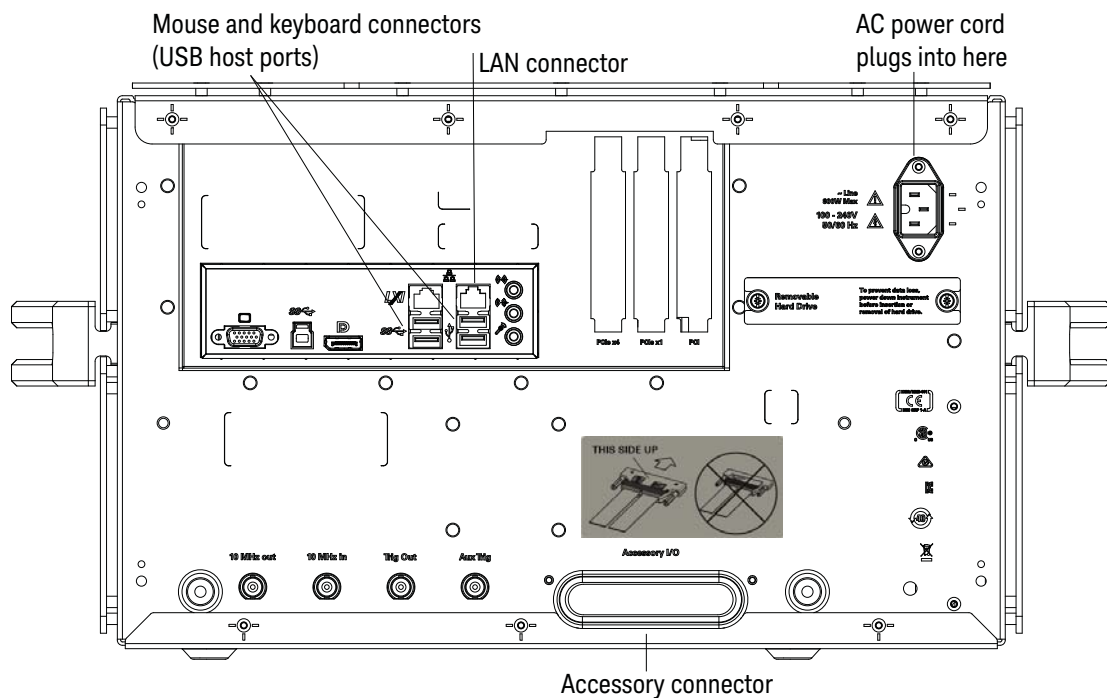

Figure 2 Accessory and cable connectors

Connecting Power to the Oscilloscope

Table 1 Power requirements

Power	100 - 240 VAC at 50/60 Hz Input power not to exceed 800 Watts
-------	--

- Connect the power cord to the rear of the oscilloscope, then to a suitable AC voltage source.

CAUTION

Use only power cords designed for your oscilloscope.

The power cord provided is matched to the country of origin of the order.

WARNING

To avoid electric shock, be sure the oscilloscope is properly grounded.

NOTE

Note that the oscilloscope's power supply has a built-in safety feature that, after the oscilloscope is turned off, requires the oscilloscope to remain off for about 10 seconds before it is turned back on.

Connecting Oscilloscope Probes

CAUTION

Maximum Input Voltage

Do not exceed the maximum input voltage rating.

Oscilloscope channels 1-4 are rated for maximum input of ± 5 V including transients.

The four Infiniium V-Series oscilloscope channel inputs have:

- 3.5 mm threaded RF connectors (like Keysight sampling oscilloscopes) to ensure the most reliable signal integrity.
- A convenient automatic torque mechanism that ensures a consistent 8 in-lbs connection.
- An AutoProbe II interface connector with pins that provide probe power, identification, and other communication signals.



Figure 3 V-Series oscilloscope probe connectors

The AutoProbe II interface works with the InfiniiMax III probing system. For information, see [Keysight Technologies InfiniiMax III/III+ Probing System Data Sheet](#).

Before using the InfiniiMax III probes, review the *InfiniiMax III Probe Handling Guide* included with the probes. These probes are ESD sensitive devices and there is a proper order for connecting probe amplifiers to the oscilloscope, probe heads to the device under test (DUT), and probe heads to the amplifier. You can also find the *InfiniiMax III Probe Handling Guide* on the Keysight web site (www.keysight.com) or with other Keysight oscilloscope probes documentation in the Probe Resource Center (www.keysight.com/find/prc).

The N5442A Precision BNC 50 Ω adapter lets you use the InfiniiMax II probing system with the V-Series oscilloscopes.

Connecting Threaded RF Cables

You can connect 3.5 mm threaded RF cables to the Infiniium V-Series oscilloscope inputs using the automatic torque “clutch” mechanism to ensure a consistent 8 in-lbs connection.

The **Aux Out** and **Cal Out** connectors also work with 3.5 mm threaded RF cables.

Tilting the Oscilloscope for Easier Viewing

Tabs under the oscilloscope's front feet can be flipped out to tilt the oscilloscope.



Figure 4 Flip-Out tabs under front feet

Turning On the Oscilloscope

- Press the power/standby switch in the lower left corner of the oscilloscope front panel.

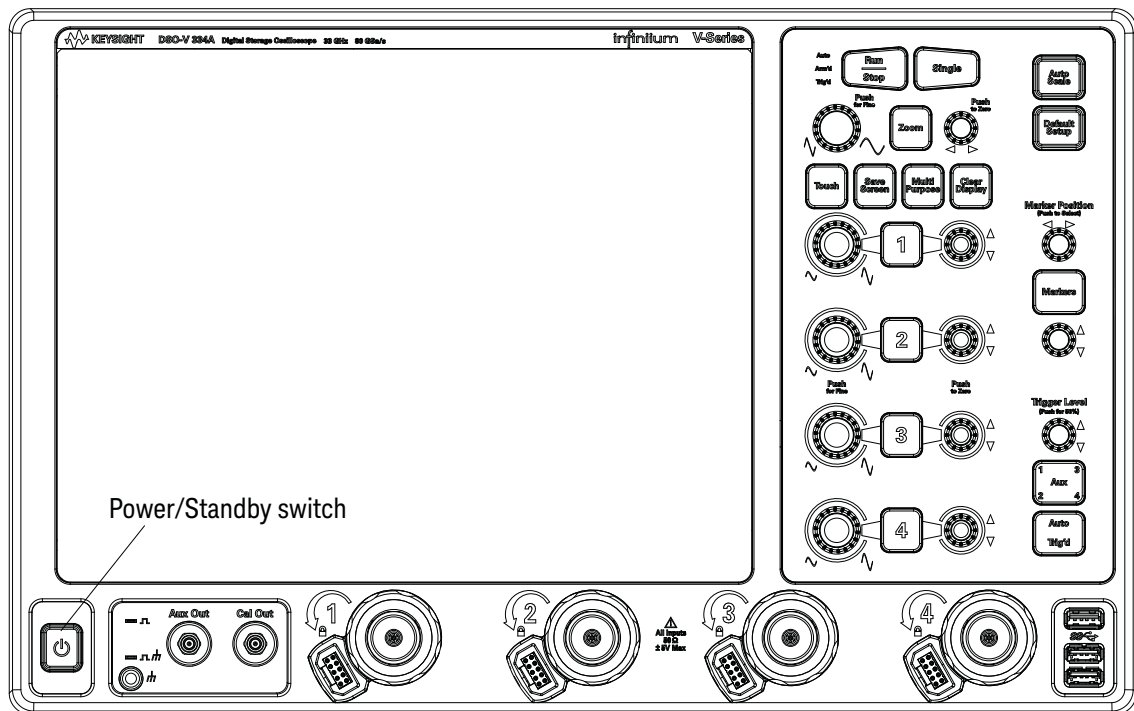

Figure 5 Turning On the oscilloscope

After a short initialization period, the oscilloscope display appears. The oscilloscope is ready to use.

- You can connect and disconnect probes and cables while the oscilloscope is turned on.

Verifying Basic Oscilloscope Operation

- 1 Install the supplied connector savers to each channel input. Keysight recommends using the connector savers to protect the input connectors.
- 2 Connect one end of the calibration cable to oscilloscope input channel 1.
- 3 Connect the other end of the cable to the **Cal Out** connector on the front panel.

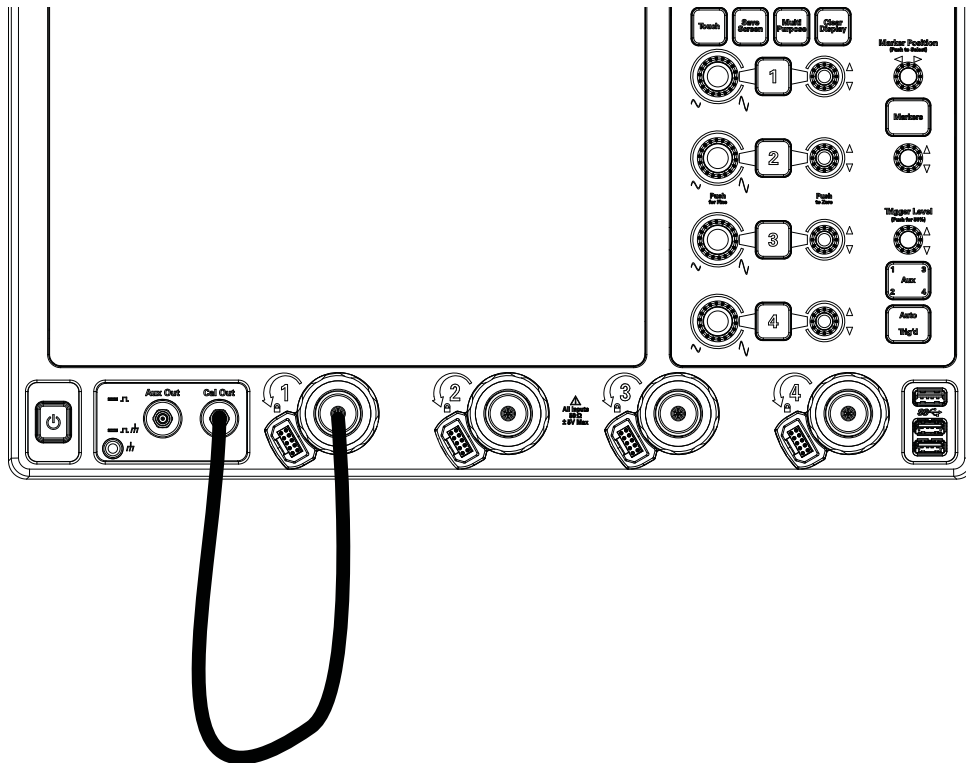

Figure 6 Verifying basic oscilloscope operation

- 4 Press [**Default Setup**] on the front panel.

The display will pause momentarily while the oscilloscope is configured to its default settings. The oscilloscope is now in a known operating condition.

- 5 Press [**Auto Scale**] on the front panel.

The display will pause momentarily while the oscilloscope adjusts the time/div setting and vertical scale so the oscilloscope can best display the input signals. You should then see a square wave with about four cycles on screen and a peak-to-peak amplitude of approximately five divisions.

If you do not see the waveform, make sure your power source is adequate, the oscilloscope is properly powered on, and the cable is connected securely to the front-panel channel input and to the calibration output.

- 6 Move the mouse around the mouse surface and verify that the on-screen pointer follows the mouse movement.
- 7 Press the **[Touch]** key on the front panel to turn on the touch screen. Press and hold your finger to the screen. A right-click menu appears, which verifies that the touch screen is working properly.

Installing Application Programs on Infiniium

Infiniium has an open Windows operating system, which lets you install your own application software. Any application that runs on Microsoft Windows 10 and uses 8 GB of RAM or less may be installed on your Infiniium oscilloscope.

NOTE

Exit the oscilloscope application before installing any software.

CAUTION

Installing an application that does not meet these requirements may break the oscilloscope application and require a hard drive recovery.

Changing Windows Operating System Settings

NOTE

Exit the oscilloscope application before changing any Windows operating system settings outside of the oscilloscope application.

Many Windows operating system settings can be changed to suit your own personal preferences. However, some operating system settings should not be changed because doing so would interfere with the proper operation of the oscilloscope.

- Do not change the Power Options.
- Do not change the Language settings.
- Do not remove Fonts.
- Do not change the screen resolution from 1024 by 768 pixels.
- Do not use the Administrative Tools to enable or disable Internet Information Services (IIS) Manager. Use the Infiniium Remote Setup dialog box (**Utilities > Remote...**) to enable or disable the Web Server.
- Do not delete or modify the Infiniium Administrator user account.

Turning Off the Oscilloscope

To turn the oscilloscope off, press the power/standby switch. The oscilloscope will go through a normal Windows operating system shutdown process.

Cleaning the Oscilloscope

WARNING

To prevent electrical shock, disconnect the Infiniium oscilloscope from mains before cleaning.

Clean the external case parts of the oscilloscope with a soft dry cloth or one slightly dampened with a mild soap and water solution. Do not attempt to clean internally.

CAUTION

Do not use too much liquid in cleaning the oscilloscope. Water can enter the Infiniium front panel, damaging sensitive electronic components.

To avoid electrostatic discharge (ESD), wear a grounded wrist strap when cleaning connectors.

WARNING

Use alcohol to clean connectors. The power cord must be removed, and the oscilloscope must be in a well-ventilated area. Allow all residual alcohol moisture to evaporate, and the fumes to dissipate prior to powering up the oscilloscope. Dispose of the cleaning materials in a responsible manner.

1 Setting Up the Oscilloscope

2 Using the Oscilloscope

Front Panel Inputs and Outputs /	26
Back Panel Inputs and Outputs /	28
Learning the Front Panel Controls (Keys and Knobs) /	30
Learning the Oscilloscope Display /	31
Using the Setup and Display Controls /	33
Starting and Stopping Waveform Acquisitions /	35
Adjusting the Horizontal Settings /	36
Adjusting the Vertical Settings /	39
Setting Up Triggers /	41
Using Markers and Making a Measurement /	42
Saving and Printing Data /	45
Saving and Printing Data /	45
Forcing a Default Setup /	46

This chapter describes how to use the Infiniium V-Series oscilloscope's inputs and outputs, front-panel controls, and user interface.

- The familiar front-panel oscilloscope interface with knobs and keys is optimized for common tasks and basic measurements.
- With the user interface for the Infiniium oscilloscope you can access all of the oscilloscope's configuration and measurement features through an easy-to-use system of windows, menus, dialog boxes, toolbars, and buttons, making it easy for you to set up and make complex measurements.
- You have the option of using either the front panel controls or the user interface for many common tasks.

Front Panel Inputs and Outputs

On the Infiniium V-Series oscilloscopes, the channel inputs and the **Aux Out** and **Cal Out** outputs appear on the lower part of the front panel. The ground plug, probe compensation terminal, and three USB host ports are also located here.

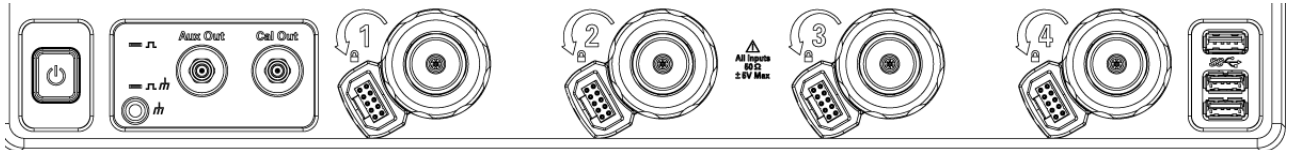

Figure 7 Infiniium V-Series oscilloscope front panel I/O

Channel Inputs

The four channel inputs have:

- 3.5 mm threaded RF connectors
- A convenient automatic torque mechanism
- An AutoProbe II interface connector with pins that provide probe power, identification, and other communication signals

The AutoProbe interface works with the InfiniiMax III probing system. See [“Connecting Oscilloscope Probes”](#) on page 17.

You can also connect 3.5 mm threaded RF cables to the channel inputs.

Ground

The ground plug is convenient for ESD wrist straps.

Aux Out

This output signal is selected by the Infiniium oscilloscope application's Calibration Output dialog box (**Utilities > Calibration Output...**). It can be a DC level, the probe compensation trigger signal (a square wave used to adjust compensated passive probes), the trigger out signal, or a demo signal.

Cal Out

This calibration output is used when performing a user calibration on the oscilloscope. A calibration cable is included with the oscilloscope.

You can also use the Infiniium oscilloscope application's Calibration Output dialog box (**Utilities > Calibration Output...**) to select other output signals, just like you can for the **Aux Out** output.

Probe compensation terminal

This terminal is located above the ground plug. It has a square wave signal that is used to adjust compensated passive probes. Be sure to use an N5449A high-impedance adapter.

You can also output a DC level on this terminal using the Infiniium oscilloscope application's Calibration Output dialog box.

USB host ports

Three USB host ports are located on the right side of the front panel.

Back Panel Inputs and Outputs

The Infiniium V-Series oscilloscope's back panel has the motherboard I/O connectors, reference clock synchronization connectors, and trigger I/O connectors.

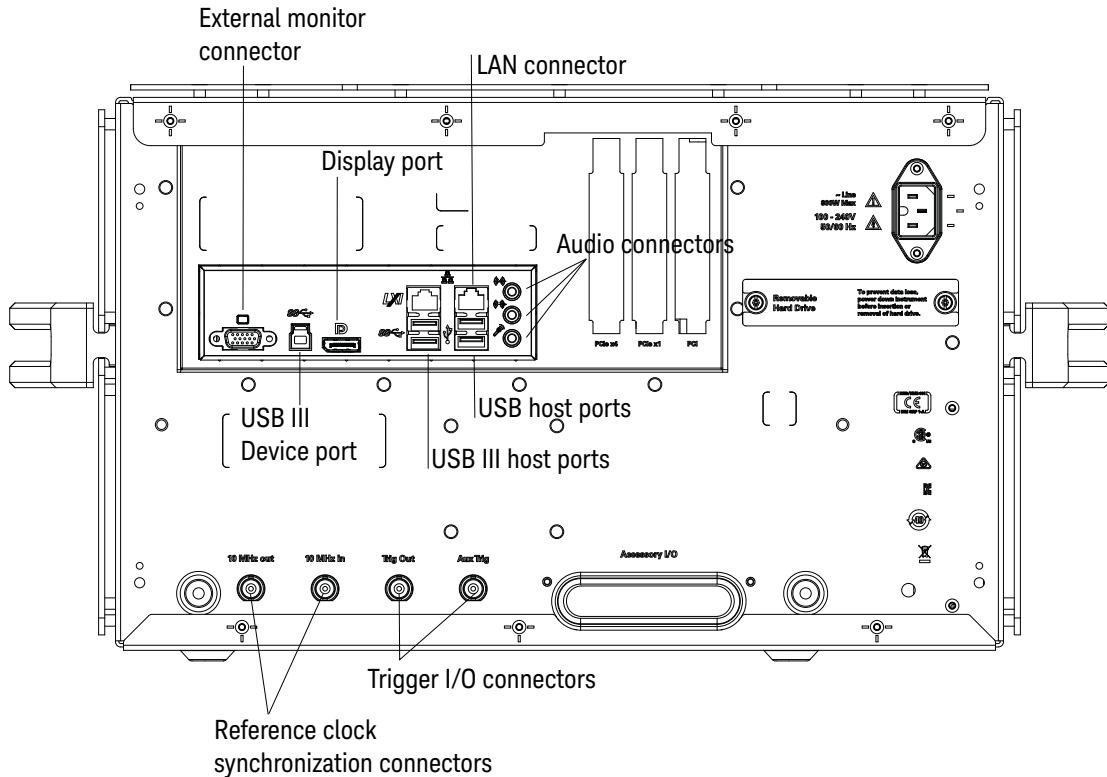

Figure 8 Back panel I/O

Motherboard I/O

The motherboard provides these inputs/outputs/ports in the oscilloscope: four USB ports for peripherals, an external monitor connector, a USB III device port (for remote control of the oscilloscope from a PC), a LAN port, and speaker and microphone connectors.

10 MHz In, 10 MHz Out

The 10 MHz In BNC connector is used to synchronize the oscilloscope's horizontal timebase system to a reference clock that you provide. The clock that you provide must meet the following specifications:

- Amplitude: 178 mV peak to 1 V peak.
- Frequency: 10 MHz \pm 5 ppm high-quality sine wave or square wave.

To use an external reference clock, connect the external clock to the 10 MHz In BNC connector; then, in the Infiniium oscilloscope application's Horizontal dialog box (**Setup > Horizontal...**), enable the 10 MHz External Reference Clock.

You can use the 10 MHz Out BNC connector to send the oscilloscope's 10 MHz reference clock output signal to another instrument's reference clock input.

Trig Out

Pulses corresponding to oscilloscope triggers can be sent to this BNC output.

Aux Trig

You can set up the oscilloscope to trigger on the auxiliary trigger signal connected to this BNC input.

Learning the Front Panel Controls (Keys and Knobs)

The Infiniium V-Series oscilloscope front panel controls provide direct access to the functions needed to perform the most common measurements. Knobs and keys let you directly set vertical and horizontal parameters. You can see the oscilloscope's configuration at a glance.

The oscilloscope uses color consistently throughout the front panel and user interface. For example, the color of the knob for channel 1 is the same color as the waveform for channel 1. All the configuration items and values related to channel 1 are displayed in the same color.

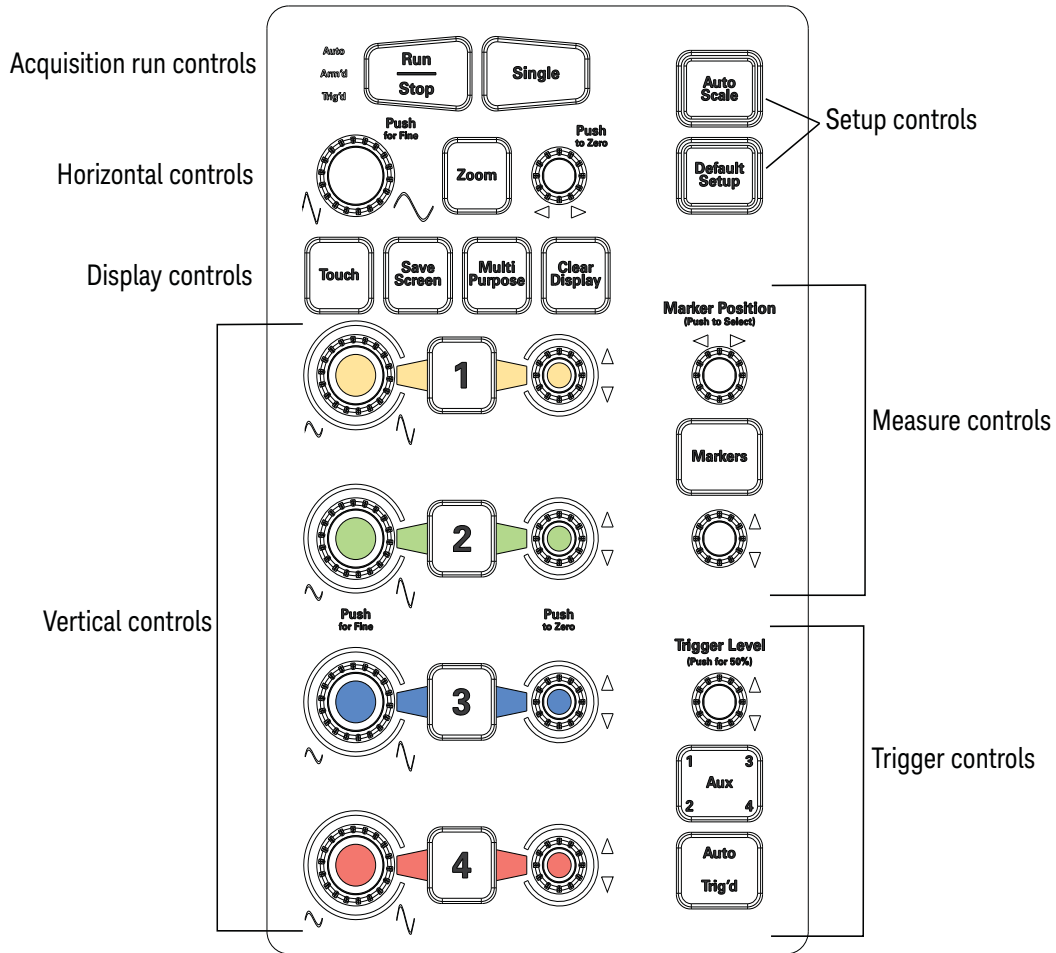

Figure 9 Front panel controls

Learning the Oscilloscope Display

The user interface is arranged so the most common functions affecting the waveform display are located around the edge of the waveform display area.

Context-sensitive menus are available by right-clicking something in the waveform display area, such as the grid, a signal, a bookmark, or a measurement. You can mouse over or touch other areas, such as the drag & drop measurements area and horizontal and acquisition control regions, to find more information about those areas or to enter data.

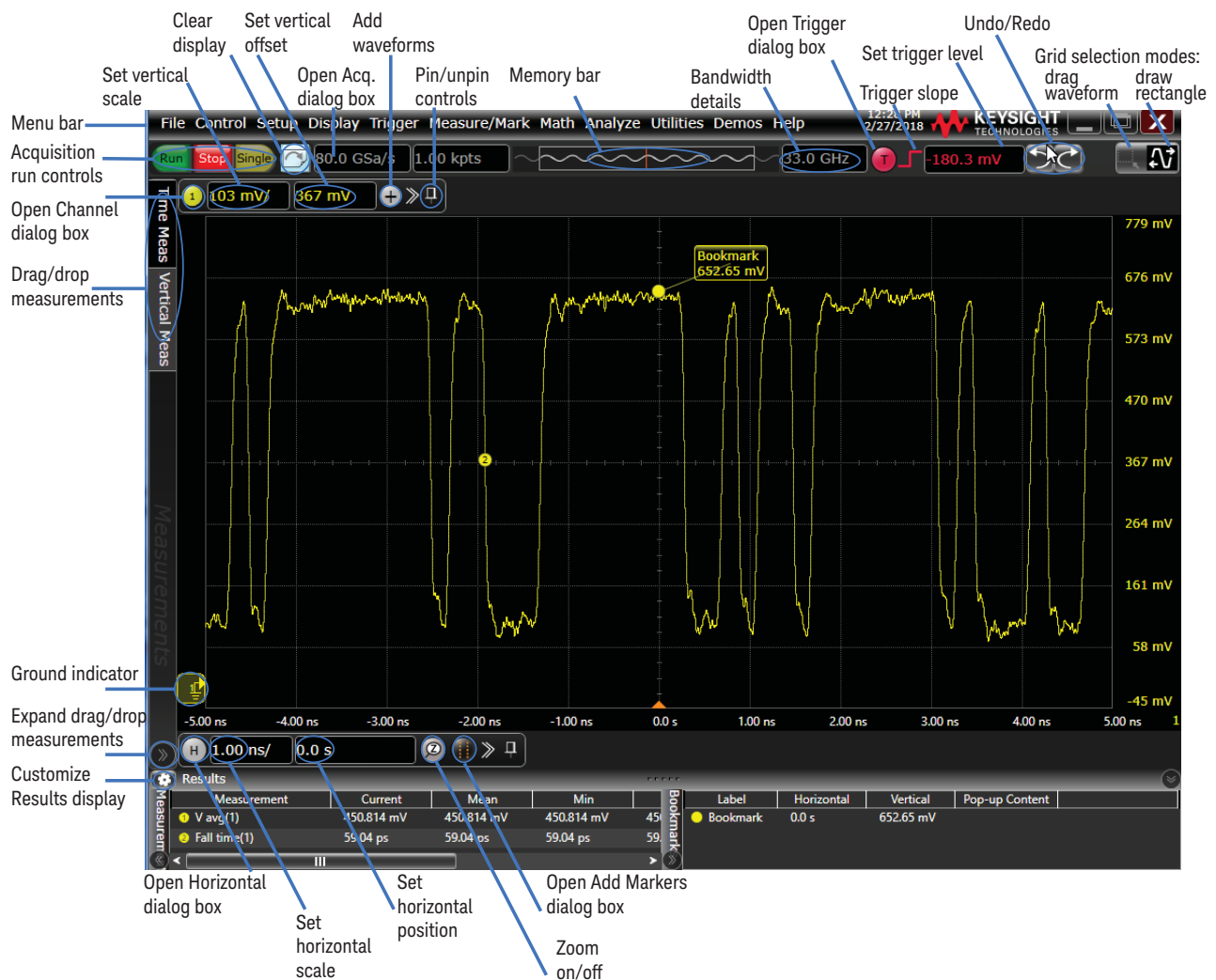

Figure 10 Infiniium display

Table 2 Infiniium display descriptions

Menu bar	Use menu selections to perform defined operations and access every function the oscilloscope provides.
Grid selection modes	The selected grid mode determines whether you draw a selection box or manipulate waveforms when you touch the screen.
Waveform display area	The waveform display area shows up to eight waveform windows. Several display options are available, such as grids or horizontal and vertical scales.
Results pane	A Results pane is visible at the bottom of the display when you do something that produces results, such as taking a measurement or using bookmarks. When it is not needed, the Results pane is not visible.

Using the Setup and Display Controls

With the setup and display controls you can set the oscilloscope to a known starting condition, set the display to suit your preference, and define a key to perform automatic measurements or other quick actions.

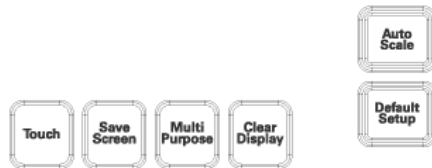



Figure 11 Setup and display control keys

Using Auto Scale and Default Setup

To automatically configure the oscilloscope to best display the current input signal(s), press **[Auto Scale]** or choose **Control > Autoscale**.

To reset the oscilloscope to its default setup, press **[Default Setup]**. You can use the Undo button  to return the oscilloscope to its original configuration.

NOTE

Save the Current Oscilloscope Configuration

Before using the default setup, you may want to save the current oscilloscope configuration for later use. See the online help (described in chapter 3) for instructions on saving setups, and for information on the exact configuration that is set when you use the default setup.

Using the Touch Screen

- 1 To enable the touch screen so it responds to multi-touch gestures, similar to those used on tablets and smart phones, press **[Touch]** or choose **Utilities > User Preferences...** and select the **Enable Touch Screen** check box.
- 2 Touch the drag waveform icon  to highlight it.

Now you can use gestures to flick items horizontally, drag a waveform vertically, drag horizontally to change the horizontal delay, pinch horizontally to adjust time/div and delay settings, pinch vertically to adjust a waveform's V/div and offset settings, or tap to select waveforms and other selections on the display.

Saving the Screen Image

To save the screen image to a file for use in other programs or documents, press **[Save Screen]** or choose **File > Save > Screen Image....**

The first time you save a screen image you will be prompted to enter a location for the saved file. Subsequent saves automatically place the file in that location.

Using Quick Measurements

You can define the **[Multi Purpose]** key to perform one of many quick actions, such as loading a setup file, saving composite data or a measurement report to a file, saving the screen image to a bitmap file, or performing automatic measurements.

The action taken when **[Multi Purpose]** is pressed (or **Utilities > Multipurpose** is chosen) depends on the feature selected in the Customize Multipurpose dialog box (**Utilities > Customize Multipurpose...**). The default feature is QuickMeas.

- To turn on the quick measurement display, press **[Multi Purpose]**. The 10 preset measurements defined in the Quick Measurement configuration are enabled and results appear on the screen for the first waveform source.
- To measure parameters for another waveform, press **[Multi Purpose]** until that waveform is the one shown in the measurement readout. Continuing to press **[Multi Purpose]** cycles through each of the waveforms available.
- To turn off the quick measurement display, cycle through all channels until the measurements are turned off.

See the Infiniium oscilloscope application's online help for information on how to configure the quick measurement capability.

Clearing the Waveform Display

When you press **[Clear Display]** or click , the oscilloscope clears acquired waveform data from the display in preparation for another acquisition. If the oscilloscope is in Run mode and is receiving triggers, it will update the display as it collects new waveform data.

Clearing the waveform display also resets averaging, infinite persistence, color grade persistence, histograms, measurement statistics, and the mask testing database.

Starting and Stopping Waveform Acquisitions

Use the acquisition run controls to run and stop acquisitions or make a single acquisition. The boxed area of the memory bar above the waveform display area shows which portion of the channel's acquisition memory you are viewing.



Figure 12 Acquisition run control keys and buttons

- To start waveform acquisition, press **[Run/Stop]** or click **Run**.
The oscilloscope begins acquiring data. When it receives a trigger signal, it finishes acquiring data, updates the display, and then starts another acquisition cycle if it is in Trig'd or Auto trigger mode.
- To stop waveform acquisition, press **[Run/Stop]** or click **Stop**. Data was last acquired remains on the screen.
- To make a single acquisition, press **[Single]** or click **Single**.
- You can also choose the **Run**, **Stop**, and **Single** commands from the **Control** menu.
- To set up how you want the signals to be sampled, such as sampling rate and mode, choose **Setup > Acquisition...**

Adjusting the Horizontal Settings

Use the horizontal controls to configure the horizontal scale (time per division) and horizontal position of the waveform. You can view a magnified section of the waveform using the zoom window.

To adjust the horizontal scale and position, use gestures on the touch screen or use the horizontal knobs, horizontal controls, or Horizontal dialog box.

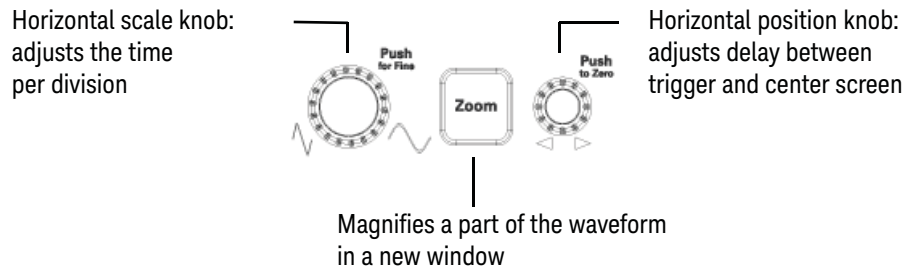

Figure 13 Horizontal scale and position knobs, **[Zoom]** key

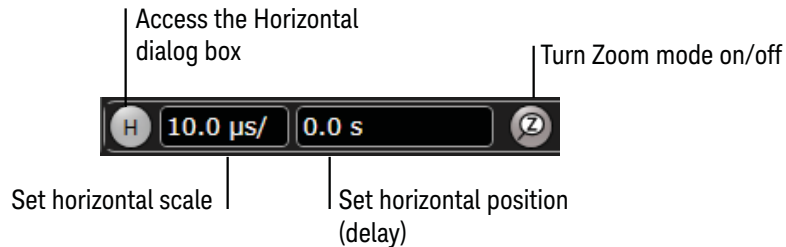

Figure 14 User interface horizontal controls

Adjusting the Horizontal Scale

- The horizontal scale knob is the larger of the two horizontal control knobs. To stretch the waveform horizontally (displaying fewer seconds per division), turn the knob clockwise. To shrink it horizontally, turn the knob counter-clockwise.
- Push and turn the horizontal scale knob to change the scaling in finer (Vernier) increments.
- You can also use multi-touch gestures to stretch or shrink the waveform.
- To adjust the horizontal scale using the controls in the horizontal toolbar, mouse over or touch the horizontal scale field and use the resulting controls to set a particular horizontal scale. Click the **Scale** field to enter an exact value, or click the “narrower” or “wider” buttons.

Adjusting the Horizontal Trigger Position (Delay)

- The horizontal position knob is the smaller of the two horizontal control knobs. Turn it to move the waveform to the right or left.

Moving the waveform to the right shows more of the pre-trigger data (data acquired before the trigger event). Moving it to the left shows more post-trigger data.

When you drag a waveform, the horizontal position will change for all channels and functions on the display. Waveform memories will also move if you select the **Tie To Timebase** check box in the Waveform Memories dialog box.

- To adjust the horizontal position using the controls in the horizontal toolbar, mouse over or touch the horizontal position field and use the resulting controls to set a particular horizontal position (time relative to the trigger at the highlighted horizontal reference point).

Magnifying a Part of the Waveform using Zoom

- To turn on zoom, press the  key or click the Zoom button .

The waveform display area splits into two regions. The top one is the main timebase. The bottom is the zoomed timebase, which represents an expansion of the acquired waveform data. A section of the waveform in the main timebase window is highlighted to indicate the part shown in the zoomed timebase window.

The horizontal scale and position controls now change how the waveform is shown in the zoomed timebase window. The horizontal scale will change the amount of magnification, while the position will change the part of the waveform in the main window that is shown in the zoomed window.

- To turn off zoom, press  or click  again.

NOTE

Avoid Overdriving Vertical Input Amplifiers

When zooming on a waveform with the oscilloscope running, be careful to keep the signal within the screen vertically to avoid overdriving the vertical input amplifiers. Overdriving causes waveform distortion and erroneous measurement results.

Setting the Scale, Position, and Timebase Reference Point

To set scale, position, and timebase reference, use the Horizontal dialog box or set up the zoomed timebase window.

To access the Horizontal dialog box, click the  in the horizontal toolbar, or choose **Setup > Horizontal...** from the main menu.

2 Using the Oscilloscope

The Timebase Reference range is from 0 to 100% of the screen. The center of the screen is at 50%. The slider correlates to the hollow orange triangle at the bottom of the display area, showing where the horizontal offset is on the screen.

Adjusting the Vertical Settings

Use the vertical controls to set the vertical scaling and vertical offset for each analog channel, and to turn the display on or off for a specific channel.

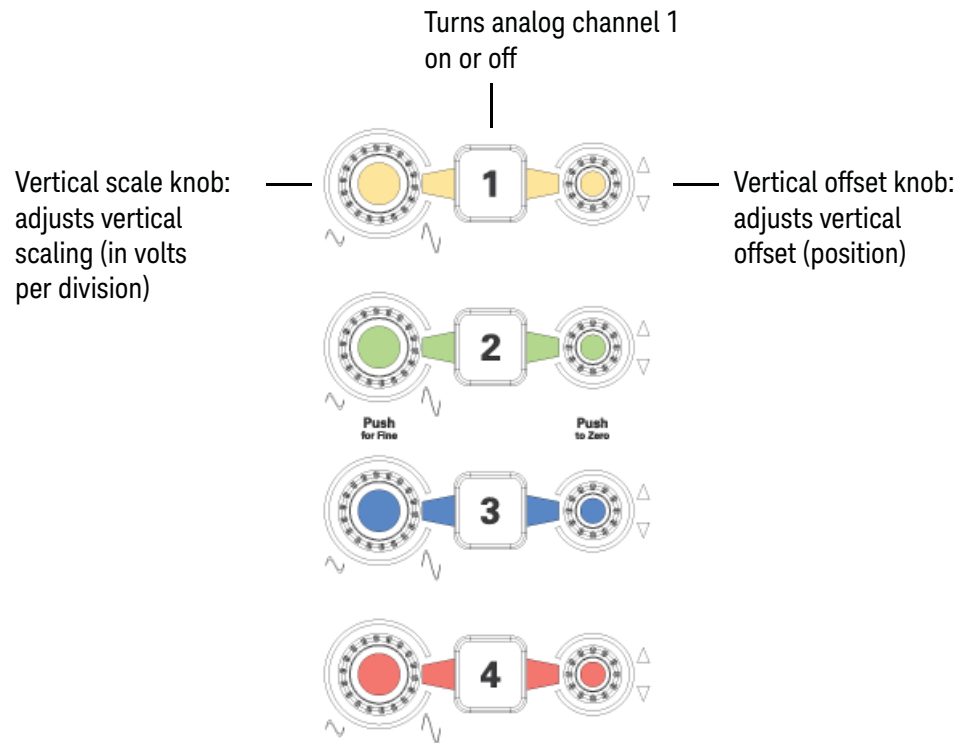

Figure 15 Channel keys and vertical knobs

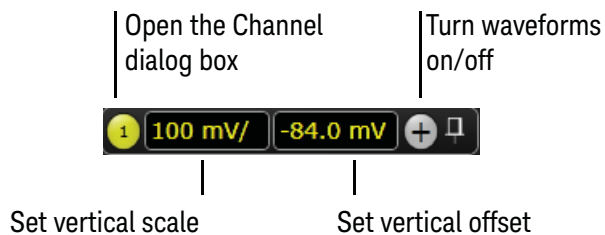

Figure 16 User interface vertical controls

Turning an Analog Channel On or Off

To turn an analog channel on or off, press the channel number key on the front panel or click the Add Waveforms button **+**. When you turn off a channel, the current vertical scale and offset fields for that channel disappear.

If you are not using a particular analog channel, you can turn it off to simplify the waveform display and increase the display update rate. Functions continue to run on a channel source that is turned off. Data acquisition continues for a channel if a function requires it.

NOTE

Using an Analog Channel as Trigger

Any analog channel can be used as a trigger source. If you need a trigger but do not need all analog channels, you can use an analog channel as a trigger without displaying it by turning the analog channel display off.

Adjusting an Analog Channel's Vertical Scale and Offset

To adjust the vertical scale and offset, use the vertical scale and offset knobs, vertical user interface controls, or Channel dialog box.

The vertical scale knob is the larger of the two knobs for a channel. Turn it to make the waveform bigger (fewer volts per division) or smaller. You can also mouse over or touch the vertical scale field and use the resulting controls to set an exact value for the scaling.

The vertical offset knob is the smaller knob for a channel. Turn it to move the waveform up or down.

You can drag the waveform or its ground reference indicator to the desired vertical offset if the grid is in drag mode .

Choose **Setup > Channel N...** or click a channel number to open the Channel dialog box, in which you can set the vertical scale, offset, skew, and labels. You can also specify the characteristics of a probe, or perform a probe calibration.

For Keysight Technologies probes that are compatible with AutoProbe II interfaces, the oscilloscope will automatically set these characteristics (except for skew) after identifying the probe when it is connected to the channel input.

Setting Up Triggers

Use the trigger controls to set the conditions on which the oscilloscope will trigger and acquire an input signal. You can set up a variety of trigger conditions. Edge triggers and the parameters for edge triggering can be set up from the front panel.

Trigger configuration settings you make using the user interface are reflected in the front-panel status indicators, and will remain set unless you change them or press **[Default Setup]**.

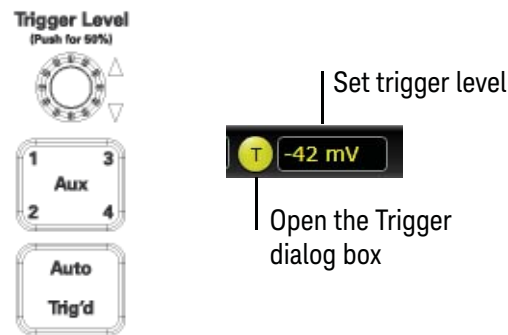

Figure 17 Trigger controls and indicators

Setting the Oscilloscope to Trigger on an Edge

- 1 Press **[Aux]** until the desired trigger source LED is illuminated.
You can choose any channel or the **Aux** input as the source for an edge trigger.
- 2 Press **[Auto/Trig'd]** until the desired one is selected.
When **Auto** is selected, an acquisition is automatically saved and displayed if a trigger does not occur within a certain amount of time. In Auto trigger mode, you are able to see your signals while setting up the desired trigger.
When **Trig'd** is selected, the oscilloscope must find the trigger before saving and displaying captured data.
- 3 Turn the Trigger Level knob to adjust the voltage level at which the oscilloscope will trigger.

Use the Trigger dialog box to select any of the modes of triggering, the parameters and conditions for each trigger mode, and advanced configuration items.

You can also mouse over the Trigger Level field and use the resulting controls to set a particular trigger level when the oscilloscope is set for edge trigger on a particular channel. You can drag the trigger reference indicator at the left side of the display, or drag the trigger line itself, which appears when you click or touch the grid.

Using Markers and Making a Measurement

Use the measure controls to display and adjust markers and make measurements.

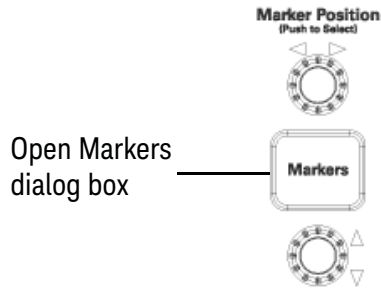

Figure 18 Front panel measure controls

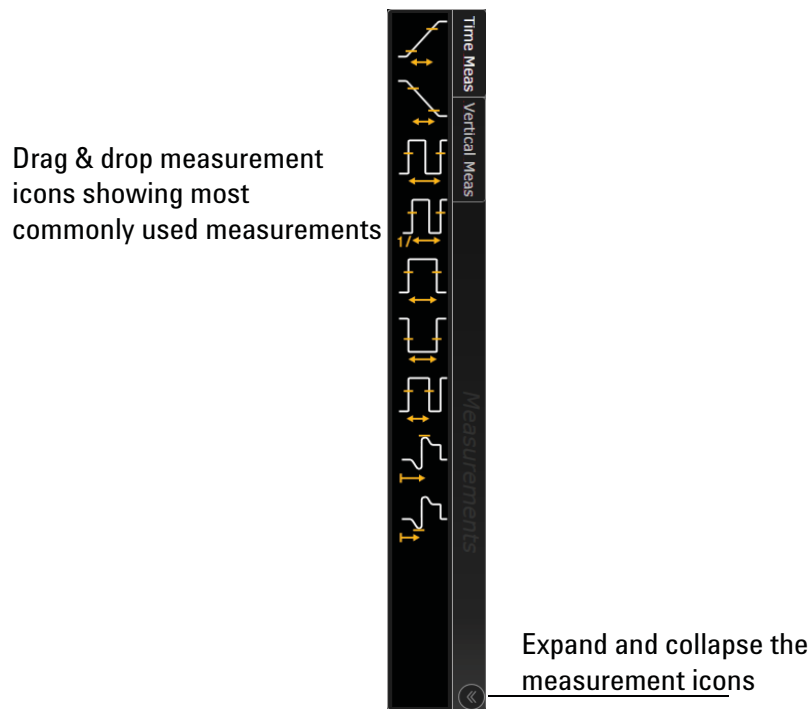

Figure 19 Drag & Drop measurements

Making a Measurement on a Waveform

To make a measurement, either drag a measurement icon to the waveform event you want to measure, or click a measurement icon and use the resulting dialog box to specify which source you want to measure.

For measurements on waveform features, such as those that involve waveform edges, if you click a measurement icon and specify a source, the measurement defaults to using the feature closest to the horizontal reference point. If you make the measurement using drag & drop, the measurement uses the waveform feature closest to the point where you drop the icon.

The most commonly used measurements are available in the drag and drop area. Others are available from the Add Measurement dialog box (**Measure/Mark > Add Measurement...**).

When you drag and drop a measurement icon on a waveform, the icon outline changes color to match the color of each waveform it touches so you can easily see which waveform will be measured.

For edge-sensitive measurements, a circled number appears in the waveform marker color when you drop the measurement icon on a waveform. This number shows exactly where the measurement is being made. It appears next to the measurement readout in the Results pane. This feature helps you distinguish measurement results from each other when you make multiple measurements on the same waveform but at different waveform features.

Using Markers

Markers make it easier to make precise measurements because the marker measurement readouts show exact voltage and time positions for the markers. The measurements are based on actual waveform data from the acquisition system, not on approximations based on the display position, so you can be sure the values are highly accurate.



Using the marker and measurement controls, you can control multiple sets of markers within the oscilloscope grid.

Both time and voltage differences between the markers are updated continuously on the screen. By default, the markers track the source waveform. Voltage measurements from the markers are the value of the waveform at the time set with the marker arrow keys.

- To add a marker, press the **[Markers]** key or choose **Measure/Mark > Add Markers...** or click the Markers button , then select the sources and mode in the pop-up dialog box. Notice the drawing in the Description area of the dialog box.
- To move a horizontal marker, turn the upper Marker Position knob. To move a vertical marker, turn the lower knob.
- Push the respective knob to toggle between markers.

- In Track Measurements mode, the marker position cannot be changed.
- You can drag a marker to quickly move it to the desired waveform event.
- You can use the front panel Position knobs for fine adjustment, or use the Add Markers dialog box and set the marker position precisely.

Controlling Digital Channels

- If your oscilloscope is an MSO model or has the digital channels upgrade, you can set up controls for the digital channels and turn them on. To open the Digital dialog box, choose **Setup > Digital Channels...**
- To easily turn the digital channels on, press the Add Waveforms button  and select the check box next to the .

Saving and Printing Data

- Choose **File > Save >** to save your composite, setup, waveform, screen image, or measurement data. You can also save to a waveform memory.
- Choose **File > Print...** to send waveform and setup data to a specified printer.
- Choose **File > Copy Screen Image** to easily copy and paste a screen image into a document.
- You can customize the **[Multi Purpose]** key to perform a QuickPrint.

Forcing a Default Setup

If your Infiniium oscilloscope is not working properly when you start it up, follow these steps to perform a default setup and return the Infiniium to normal operation.

- 1 Choose **Control > Default Setup** or press **[Default Setup]**.
- 2 If the oscilloscope is still not working properly, choose **Control > Factory Default** to return the oscilloscope to the default settings it had when it left the factory.
- 3 If the oscilloscope is still not working properly, turn it off.
- 4 Turn the oscilloscope back on. If it does not successfully restart, try recycling the power again.
- 5 As soon as the Windows load screen disappears, press **[Default Setup]**. If the oscilloscope still does not successfully restart, follow the instructions for recovering the hard drive.

Infiniium Hard Drive Recovery

Follow these steps to recover your Infiniium hard drive.

- 1 Back up your cal and license files if they are still accessible:
 - a If the Infiniium application is available, launch the Keysight License Manager (**Utilities > Launch License Manager...**) and capture a screen shot of the page. It lists the transportable and fixed perpetual licenses that Keysight will need to reissue.
 - b Copy the calibration folder (**C:\ProgramData\Infiniium\cal**) to an external device, such as a flash drive.
 - c Copy the license file (**C:\ProgramData\Infiniium\license.dat**), which contains legacy licenses, to an external device.
- 2 Turn off the oscilloscope.
- 3 Make sure a keyboard and mouse are connected to the USB host ports.
- 4 Turn on the oscilloscope and watch closely for the system prompts. As soon as you see the prompt to choose Microsoft Windows or Instrument Image Recovery System, select **Instrument Image Recovery System** and follow the on-screen instructions.
- 5 Once the recovery process is finished and the oscilloscope is running, check in the About Infiniium dialog box under installed options to see if all of the options you ordered are installed. If the options are not installed, install them using the license keys provided on the oscilloscope option license certificates you received, or refer to the back of the oscilloscope.
- 6 Restore the calibration folder and license files back to their original locations.
- 7 Restart the oscilloscope application to ensure the license.dat file reflects any factory bandwidth licenses.

- 8 Send an email message to **csupport@keysight.com**. Provide the License Manager screen shot page you captured earlier, the oscilloscope's model and serial number from the rear panel of the scope, and the zip file you created earlier.
- 9 From the oscilloscope desktop, launch the Infiniium application. When the application is active, perform a scope self-test (**Utilities > Self Test...**).

2 Using the Oscilloscope

3 Online Help and Other Information

Accessing the Online Help / 49

Navigating the Online Help / 50

Using the Demo Wizard / 51

Almost anything you want to know about the Infiniium oscilloscope is available in the online help.

Accessing the Online Help

There are two ways to access the online help:

- Click the question mark near the top right corner of a dialog box to open the help topic for that dialog box (**Figure 20**).
- Choose **Help > Contents...** from the main menu to open the online help home page (**Figure 21**).

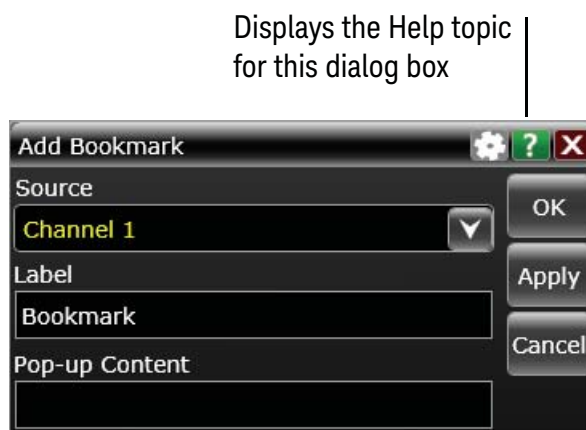

Figure 20 Help button for dialog box Help

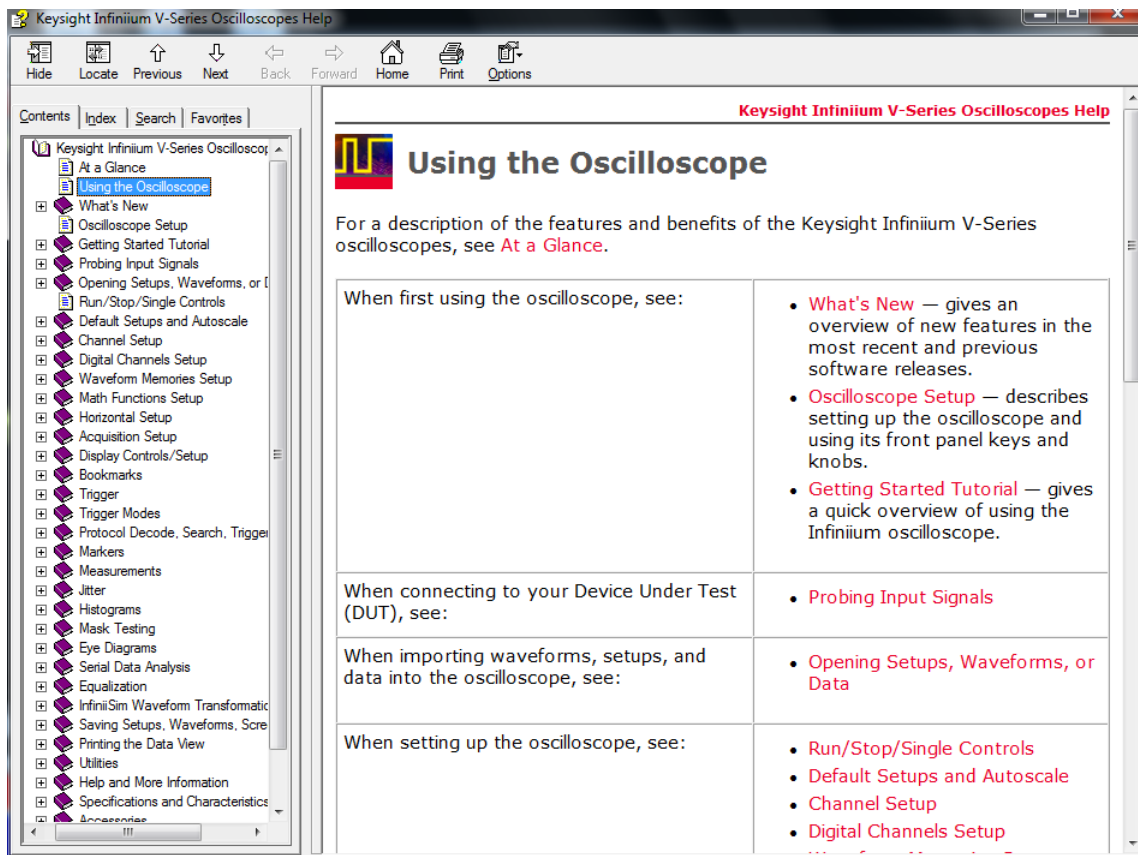

Figure 21 Online Help home page

Navigating the Online Help

The online help provides several ways to find the information you need.

- Use the **Search** tab to search for a word or phrase. Use quotation marks to search for an exact phrase, such as “add waveform”.
- Use the **Contents** tab to browse topics by double-clicking topics in the left pane.
- Use the **Index** tab to type in a keyword and search the index for that keyword, or scroll through the alphabetical list to find a topic.
- Use the **Favorites** tab to add preferred help topics to a list for easy reference.

For details on using online help, click **How to Use This Help** under the **Help and More Information** topic in the **Contents** tab.

Using the Demo Wizard

Your V-Series oscilloscope comes with a built-in demo wizard that showcases many Infiniium features. To see the demos, choose **Help > Show Demo Wizard...** You can then select a specific demo, such as one for a particular protocol or one for a user interface showing bookmarks.

For example, the following screen display shows the initial demo page for the FFT function. To experiment with the demo, click **Load Demo...**



Figure 22 FFT Demo

Safety

This product has been designed and tested in accordance with accepted industry standards, and has been supplied in a safe condition. The documentation contains information and warnings that must be followed by the user to ensure safe operation and to maintain the product in a safe condition.

Safety Compliance

This product complies with the current editions of the following standards:

- CAN/CSA-C22.2 No. 61010-1-12
- UL Std. No. 61010-1 (3rd edition)

Acoustic Statement

This is to declare that this instrument is in conformance with the German Regulation on Noise Declaration for Machines (Laermangabe nach der Maschinenlaermverordnung -3.GSGV Deutschland).

LpA < 70 dB

Operator position

Normal position per ISO 7779

General Safety Notices

WARNING

This is a Safety Protection Class I Product (provided with a protective earthing ground incorporated in the power cord). The mains plug shall only be inserted in a socket outlet provided with a protective earth contact. Any interruption of the protective conductor inside or outside of the product is likely to make the product dangerous. Intentional interruption is prohibited.

WARNING







If this product is not used as specified, the protection provided by the equipment could be impaired. This product must be used in a normal condition (in which all means for protection are intact) only.

WARNING

No operator-serviceable parts inside. Refer servicing to qualified personnel. To prevent electrical shock, do not remove covers.

Symbols

These symbols may be used on the Infiniium oscilloscope.

Symbol	Description
 N10149	The C-Tick mark is a registered trademark of the Australian Spectrum Management Agency.
	The CE mark is a registered trademark of the European Community.
	ICES / NMB-001 Cet appareil ISM est conforme a la norme NMB du Canada. This is a marking to indicate product compliance with the Industry Canadian Interference-Causing Equipment Standard (ICES-001). This is also a symbol of an Industrial Scientific and Medical Group 1 Class A product (CISPR 11, Clause 4).
	This symbol indicates separate collection for electrical and electronic equipment mandated under EU law as of August 13, 2005. All electric and electronic equipment are required to be separated from normal waste for disposal (Reference WEEE Directive 2002/96/EC).
	Indicates the time period during which no hazardous or toxic substance elements are expected to leak or deteriorate during normal use. Forty years is the expected useful life of the product.
	The symbol on all primary and secondary packaging indicates compliance to China standard GB 18455-2001. To return unwanted products, contact your local Keysight office.
	The CSA mark is a registered trademark of the CSA International.

3 Online Help and Other Information

Index

A

- accessing
 - online help, 49
- accessories
 - and options, 12
- adjusting
 - analog channel's vertical offset, 40
 - analog channel's vertical scaling, 40
- airflow requirements, 14
- application software, 21
- associating measurement results with waveforms, 43
- Autoscale, 20, 33

B

- buttons, 30
 - help, 51

C

- calibration
 - output, 20
- cautions
 - cleaning, 23
- channel keys, 39
- channels
 - controlling digital channels, 44
 - turning on or off analog channels, 39
- checking the oscilloscope, 12
- cleaning the oscilloscope, 23
- Clear Display key, 34
- clearing the display, 34
- color
 - use of, 30, 43
- configuration
 - default, 20
 - edge trigger, 41
- configuring
 - quick measurements, 34
- connecting
 - LAN card, 15
 - MSO cable, 15
 - pointing device, 15
 - power, 16
 - probes, 17
- contents
 - online help, 49
- contents topic, 50

- customizing display layout, 43
- cycling
 - measurements through channels, 34

D

- default setup, 20
- disk
 - hard disk recovery, 46
- display
 - clearing, 34
- display layout
 - customizing, 43
- drag-and-drop measurements, 43

E

- edge trigger
 - setting, 41
- erasing the display, 34

F

- finding information, 49, 50
- front panel
 - connections, 17
 - interface, 25, 30

G

- grid mode, 32

H

- hard disk
 - recovery, 46
- help
 - button, 51
- horizontal
 - zoomed timebase, 37
- horizontal position
 - in zoom mode, 37

I

- information
 - methods for accessing, 50
- inspecting the oscilloscope, 12
- installing
 - application software, 21

K

- keys, 30
 - analog channel, 39
 - Clear Display, 34
 - Markers, 43
 - Multi Purpose, 34
 - Zoom, 37
- knobs, 30
 - analog channel's vertical offset, 40
 - analog channel's vertical scaling, 40
 - trigger level, 41

L

- LAN card, 15
- LED indicators, 30
- level
 - trigger, 41
- line voltage, 16

M

- magnifying
 - a section of the waveform, 37
- main timebase, 37
- making
 - measurements, 43
 - quick measurements, 34
 - waveform bigger or smaller, 40
- markers
 - and measurements, 43
 - positioning, 43
 - turning on or off, 43
- measurement results
 - associating with waveform, 43
- measurement toolbar, 43
- measurements, 43
 - and markers, 43
 - quick, 34
 - using markers, 43

methods for accessing information, 50

mouse

connecting, 15

moving

markers, 43

waveform vertically, 40

MSO cable, 15

Multi Purpose key, 34

N

navigating the online help, 50

notes

online help access, 49

notices, 2

O

offset

adjusting analog channels, 40

online help

accessing, 49

navigating, 50

overview, 49

opening the online help, 49

options

and accessories, 12

oscilloscope

cleaning, 23

inspecting, 12

using, 25

oscilloscope front panel, 30

oscilloscope operation

verifying, 20

oscilloscope probes, see probes

P

pointing device

connecting, 15

verifying operation, 20

pollution degree, 13

position

adjusting analog channel's vertical, 40

positioning markers, 43

power

connecting, 16

requirements, 16

turning off, 23

preset measurements, 34

probes

connecting, 17

probing a circuit, 17

Q

quick measurements, 34

R

RJ-45 connector, 15

LAN card, 15

S

scaling

adjusting analog channel's vertical, 40

seconds per division

in zoom mode, 37

setting

edge trigger, 41

setup

default, 20

slope

trigger, 41

source

trigger, 41

status indicators

trigger, 41

T

toolbars

measurement, 43

topics

contents, 50

tracking waveforms

using markers, 43

trigger

level, 41

setting edge, 41

slope, 41

source, 41

status indicators, 41

triggered sweep, 41

turning analog channels on or off, 39

turning markers on and off, 43

U

use of color in interface, 30, 43

user interface

front panel, 30

use of color, 30

user interface elements, 51

using

markers, 43

oscilloscope, 25

V

verifying basic operation, 20

vertical inputs

overdriving, 37

vertical offset

adjusting analog channels, 40

vertical scaling

adjusting analog channels, 40

volts per division

adjusting, 40

W

waveform

magnifying, 37

waveform features

measurements on, 43

waveforms

associating with measurement

results, 43

drag-and-drop measurements on, 43

making quick measurements, 34

measuring using markers, 43

turning off, 39

window

zoom, 37

Windows operating system settings, 22

Z

zoom display, 37

Zoom key, 37



This information is subject to change without notice.

© Keysight Technologies 2015-2016, 2018
Third edition, April 2018
54919-97006

www.keysight.com