

VXG M9384B and VXG-m M9383B

Microwave Signal Generators, 1 MHz to 44 GHz

This data sheet provides key features and specifications for the M9384B VXG and M9383B VXG-m microwave signal generators.



Table of Contents

Definitions and Conditions	3
Block diagram	4
Frequency	5
Frequency Reference.....	6
Power	8
Spectral Purity	12
Pulse Modulation (Option PMR or PME)	17
Internal Pulse Generator (Option PMR or PME).....	19
Vector Modulation (Option Dxx)	21
Internal Baseband Generator (Option Dxx)	25
Error Vector Magnitude (EVM).....	28
Adjacent Channel Power Ratio (ACPR).....	30
Remote Programming	31
Environmental Specifications	32
M9384B VXG Physical Specifications	33
M9384B VXG Input and Output Connectors.....	33
M9383B VXG-m Physical Specifications	37
M9383B VXG-m Input and Output Connectors	37
Setup and Calibration Services.....	43
Support and Warranty	43

Definitions and Conditions

Specification (spec)

Specifications represent warranted performance of a calibrated instrument that has been stored for a minimum of 2 hours within the operating temperature range of 0 to 40 °C, unless otherwise stated, and after a 45-minute warm-up period. All Specifications apply over a 20 °C to 30 °C temperature range (unless otherwise stated). Specifications include guard bands to account for the expected statistical performance distribution, measurement uncertainties, and changes in performance due to environmental conditions. Data represented in this document are Specifications unless otherwise noted.

Typical (typ)

Typical describes additional product performance information that is not covered by the product warranty. It is performance beyond specifications that 80 percent of the units exhibit with a 90 percent confidence level at room temperature (approximately 23 °C). Typical performance does not include measurement uncertainty.

Nominal (nom)

Nominal values indicate the expected mean or average performance, or an attribute whose performance is by design, such as the 50-ohm connector. This data is not warranted and is measured at room temperature (approximately 23 °C).

Measured (meas)

Measured describes an attribute measured during the design phase for purposes of communicating expected performance, such as amplitude drift vs. time. This data is not warranted and is measured at room temperature (approximately 23 °C).

Block diagram

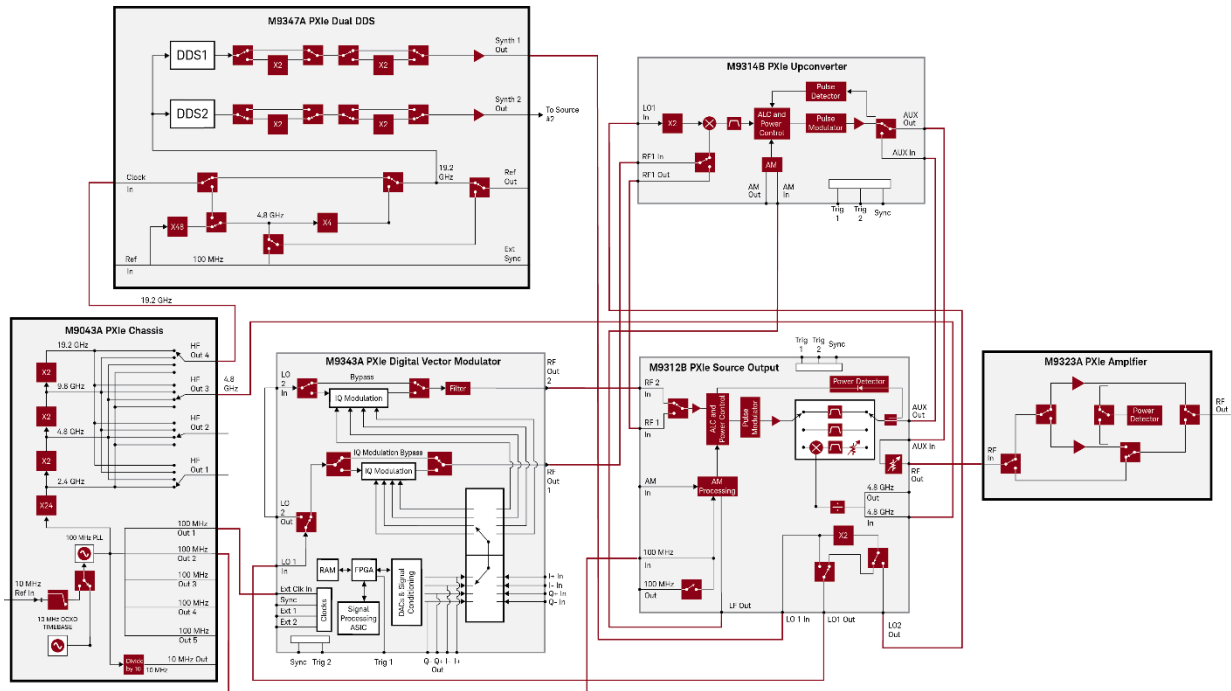
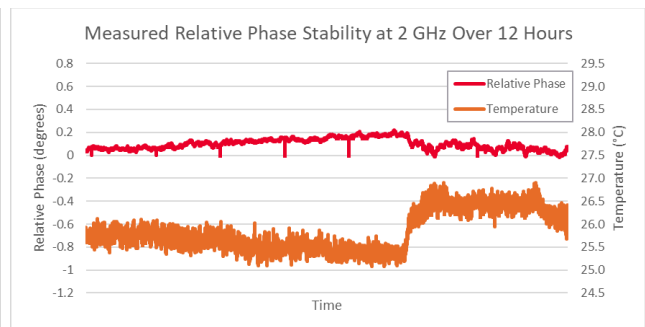
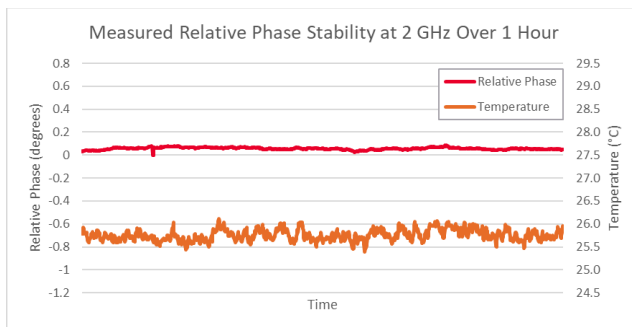

Figure 1: Block diagram for the VXG, a 44 GHz signal generator with 2 GHz RF bandwidth.

Frequency

Range	
Option F14 ¹	1 MHz to 14 GHz
Option F20 ¹	1 MHz to 20 GHz
Option F32 ¹	1 MHz to 31.8 GHz
Option F44	1 MHz to 44 GHz
Resolution	0.01 Hz
Phase adjustments	
Phase offset range	± 180 degrees
Phase offset resolution	0.001 degrees
Relative phase adjustments: channel 1 versus channel 2 (option PCH)	
Relative phase offset range	± 180 degrees
Relative phase offset resolution	0.001 degree
Relative phase repeatability ²	0.0001 degree



¹ Available on M9384B only.

² When tuning frequency from f_1 to f_2 and back to f_1 .

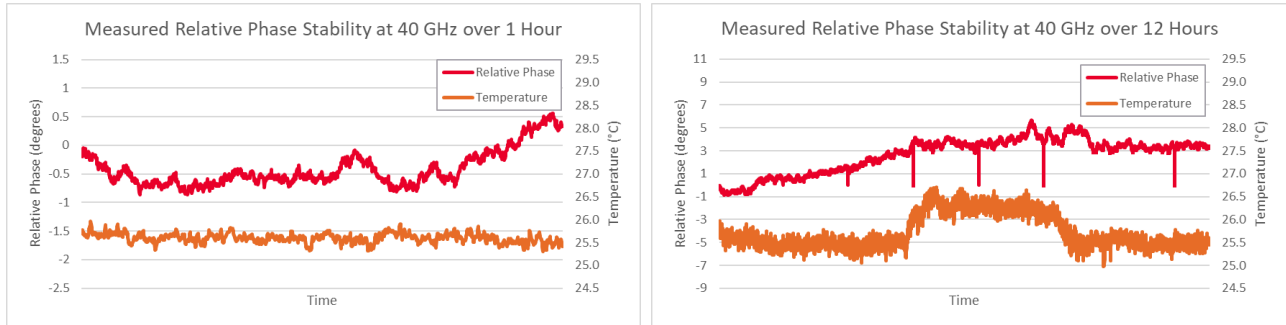
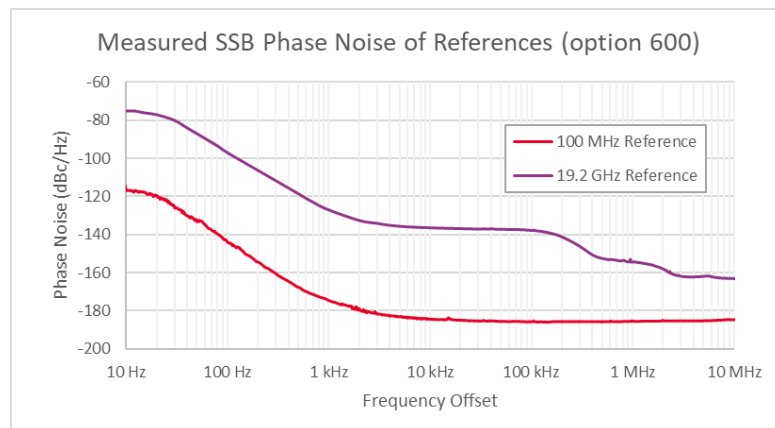

Figure 2: Relative phase stability between VXG channel 1 and channel 2 measured in an office environment.

Frequency Reference

Reference Outputs	
100 MHz out	
Amplitude	≥ 10 dBm, 15 dBm (typ.)
Connector	SMB male (M9383B), SMA female (M9384B)
Impedance	50 Ω (nom.)
10 MHz out	
Amplitude	≥ 10 dBm, 13 dBm (typ.)
Connector	SMB male (M9383B), BNC female (M9384B)
Impedance	50 Ω (nom.)
19.2 GHz out	
Amplitude	> 0 dBm, 1 dBm (typ.)
Connector	SMA female
Impedance	50 Ω (nom.)
External reference input	
Frequency	10 MHz or 100 MHz
Lock range	± 0.6 ppm (nom.)
Amplitude	-3 dBm to 20 dBm
Connector	SMB male (M9383B), BNC female (M9384B)
Impedance	50 Ω (nom.)

Frequency accuracy		
Calculation		± (time since last adjustment x aging rate) ± temperature effects ± calibration accuracy
Aging rate	Daily	< ± 0.5 ppb/day, after 72-hour warm-up
	Yearly	< ± 0.1 ppm/year, after 72-hour warm-up
	Total 10 years	< ± 0.6 ppm/10yrs, after 72-hour warm-up
Temperature effects	20 to 30 °C	< ± 10 ppb
	Full temperature range	< ± 50 ppb
Initial achievable calibration accuracy ³		± 5 x 10 ⁻⁸
Warm up		
5 minutes over +20 to +30 °C, with respect to 1 hour		< ± 0.1 ppm
15 minutes over +20 to +30 °C, with respect to 1 hour		< ± 0.01 ppm



³ At time of shipment.

Power

Output parameters	
Settable range	-120 dBm to +23 dBm
Resolution	0.01 dB
Output impedance	50 Ω (nom.)
Maximum reverse power	½ Watt, 0 VDC, nominal
Maximum output power ⁴ () = typical	
Options F14 and F20	
Frequency range	Standard
10 MHz to < 200 MHz (harmonic filters off)	+18 dBm (+19 dBm)
10 MHz to < 200 MHz (harmonic filters on)	+17 dBm (+19 dBm)
200 MHz to < 400 MHz (harmonic filters off)	+19 dBm (+20 dBm)
200 MHz to < 400 MHz (harmonic filters on)	+13 dBm (+15 dBm)
400 MHz to < 1 GHz (harmonic filters off)	+20 dBm (+21 dBm)
400 MHz to < 1 GHz (harmonic filters on)	+15 dBm (+17 dBm)
1 GHz to < 1.5 GHz (harmonic filters off)	+20 dBm (+21 dBm)
1 GHz to < 1.5 GHz (harmonic filters on)	+13 dBm (+15 dBm)
1.5 GHz to < 12 GHz	+22 dBm (+23 dBm)
12 GHz to < 18 GHz	+21 dBm (+23 dBm)
18 GHz to 20 GHz	+20 dBm (+22 dBm)

⁴ With option 1EH harmonic filters below 2 GHz switched off, unless otherwise specified.

Maximum output power⁵ () = typical**Options F32 and F44**

Frequency range	Standard	Option 1EB ⁶ or 1EE
10 MHz to < 200 MHz (harmonic filters off)	+14 dBm	+14 dBm (+18 dBm)
10 MHz to < 200 MHz (harmonic filters on)	+13 dBm	+13 dBm (+18 dBm)
200 MHz to < 400 MHz (harmonic filters off)	+12 dBm	+12 dBm (+17 dBm)
200 MHz to < 400 MHz (harmonic filters on)	+8 dBm	+8 dBm (+12 dBm)
400 MHz to < 1 GHz (harmonic filters off)	+11 dBm	+11 dBm (+16 dBm)
400 MHz to < 1 GHz (harmonic filters on)	+7 dBm	+7 dBm (+12 dBm)
1 GHz to < 1.5 GHz (harmonic filters off)	+18 dBm	+18 dBm (+22 dBm)
1 GHz to < 1.5 GHz (harmonic filters on)	+10 dBm	+10 dBm (+18 dBm)
1.5 GHz to < 18 GHz	+18 dBm	+20 dBm (+22 dBm)
18 GHz to < 20 GHz	+15 dBm	+19 dBm (+21 dBm)
20 GHz to < 35 GHz	+18 dBm	+19 dBm (+21 dBm)
35 GHz to < 37 GHz	+15 dBm	+17 dBm (+20 dBm)
37 GHz to < 41 GHz	+15 dBm	+18 dBm (+21 dBm)
41 GHz to 43.5 GHz	+13 dBm	+14 dBm (+18 dBm)
> 43.5 GHz to 44 GHz	+11 dBm	+14 dBm (+18 dBm)

⁵ With option 1EH harmonic filters below 2 GHz switched off, unless otherwise specified.

⁶ Expect a 1-2 dBm maximum output power improvement for M9383B.

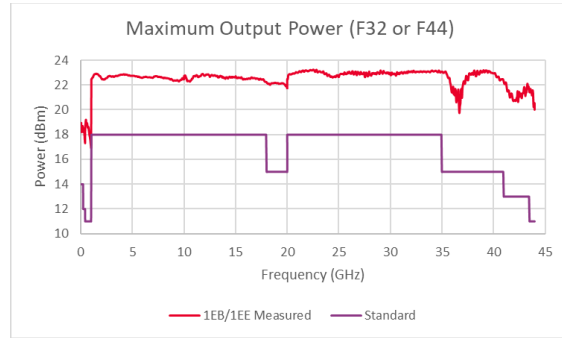
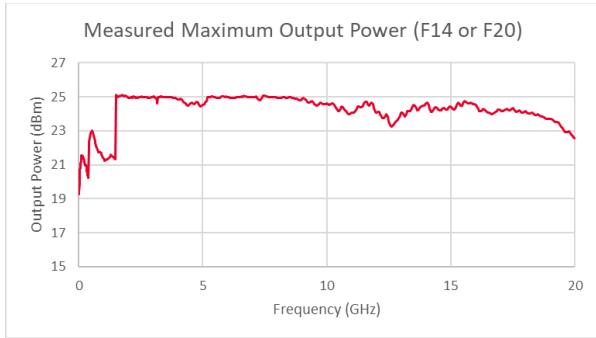

Absolute level accuracy (CW) ⁷ , () = typical				
Frequency	> +5 dBm	+5 dBm to -40 dBm	-40 dBm to -80 dBm	-80 dBm to -90 dBm
10 MHz to < 200 MHz	±1.3 dB (±0.4 dB)	±1.3 dB (±0.3 dB)	±1.3 dB (±0.3 dB)	±1.2 dB (±0.3 dB)
200 MHz to < 400 MHz	±1.1 dB (±0.2 dB)	±1.2 dB (±0.2 dB)	±1.0 dB (±0.3 dB)	±1.1 dB (±0.3 dB)
400 MHz to < 3.6 GHz	±1.5 dB (±0.3 dB)	±1.2 dB (±0.2 dB)	±1.4 dB (±0.4 dB)	±2.8 dB (±0.9 dB)
3.6 GHz to < 16 GHz	±1.4 dB (±0.4 dB)	±1.3 dB (±0.5 dB)	±1.4 dB (±0.5 dB)	±1.7 dB (±0.6 dB)
16 GHz to < 20 GHz	±1.3 dB (±0.3 dB)	±1.2 dB (±0.3 dB)	±1.2 dB (±0.4 dB)	±1.5 dB (±0.5 dB)
20 GHz to < 34 GHz	±1.5 dB (±0.4 dB)	±1.8 dB (±0.6 dB)	±2.0 dB (±1.0 dB)	±2.0 dB (±1.0 dB)
34 GHz to 44 GHz	±1.6 dB (±0.4 dB)	±1.9 dB (±0.6 dB)	±2.1 dB (±0.8 dB)	±2.4 dB (±1.5 dB)
Absolute level accuracy in IQ mode relative to CW (-15 dBm to +4 dBm)				
Frequency	Waveform type: 5G NR, SCS 120 kHz, 100 MHz BW, 256 QAM, 1CC			
1 GHz to 44 GHz	±0.7 dB (typ)			

⁷ ALC On or using Power Search.

SWR (measured CW mode)			
Frequency	Power range of high-power path	High power path	Standard path
< 50 MHz	-	-	2.2:1
50 MHz to < 500 MHz	-	-	1.7:1
500 MHz to < 1 GHz	-	-	1.5:1
1 GHz to < 3.2 GHz	≥ 10 dBm	1.8:1	1.5:1
3.2 GHz to < 11 GHz	≥ -3 dBm	1.5:1	1.7:1
11 GHz to < 20 GHz	≥ -3 dBm	1.4:1	1.4:1
20 GHz to < 30 GHz	≥ -3 dBm	2.3:1	2.6:1
30 GHz to < 39 GHz	≥ -3 dBm	1.9:1	2.2:1
39 GHz to 44 GHz	≥ -8.5 dBm	1.9:1	2.2:1

Spectral Purity

Harmonics ⁸ , () = typical, [] = measured			
Frequency	Harmonics measured in dBc at +5 dBm		
	Specified	Typical F32 & F44	Measured F14 & F20
10 MHz to < 200 MHz (1EH harmonic filters off/on)	-27/-27	(-35/-35)	[-40/-40]
200 MHz to < 300 MHz (1EH harmonic filters off/on)	-30/-43	(-36/-50)	[-39/-54]
300 MHz to < 400 MHz (1EH harmonic filters off/on)	-33/-44	(-40/-52)	[-45/-56]
400 MHz to < 2 GHz (1EH harmonic filters off/on)	-24/-46	(-31/-54)	[-36/-59]
2 GHz to < 3.2 GHz	-44	(-53)	[-58]
3.2 GHz to < 4.3 GHz	-31	(-39)	[-70]
4.3 GHz to < 4.8 GHz	-19	(-28)	[-37]
4.8 GHz to < 6.5 GHz	-29	(-36)	[-54]
6.5 GHz to < 6.8 GHz	-18	(-26)	[-35]
6.8 GHz to < 10 GHz	-26	(-32)	[-55]
10 GHz to < 11.4 GHz	-26	(-32)	-
11.4 GHz to < 17.1 GHz	-41	(-49)	-
17.1 GHz to < 20 GHz	-45	(-53)	-
20 GHz to 22 GHz	-29	(-36)	-

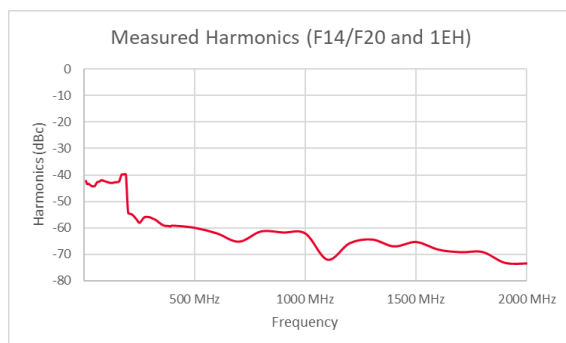

⁸ For configurations which do not include option 1ES

Sub-harmonics () = typical	
Frequency	Sub-harmonics measured at +9 dBm
10 MHz to < 50 MHz	-61 dBc (-77 dBc)
50 MHz to < 200 MHz	-82 dBc (-89 dBc)
200 MHz to < 210 MHz	-60 dBc (-67 dBc)
210 MHz to < 2 GHz	-81 dBc (-87 dBc)
2 GHz to < 2.45 GHz	-59 dBc (-69 dBc)
2.45 GHz to < 6 GHz	-81 dBc (-89 dBc)
6 GHz to < 9.5 GHz	-45 dBc (-75 dBc)
9.5 GHz to < 11 GHz	-38 dBc (-55 dBc)
11 GHz to < 12 GHz	-63 dBc (-73 dBc)
12 GHz to < 19 GHz	-36 dBc (-50 dBc)
19 GHz to < 19.5 GHz	-30 dBc (-47 dBc)
19.5 GHz to 44 GHz	-69 dBc (-80 dBc)

Non-harmonics () = typical	
Frequency	Non-harmonics measured at +10 dBm
10 MHz to < 400 MHz	-43 dBc (-52 dBc)
400 MHz to < 17.7 GHz	-50 dBc (-61 dBc)
17.7 GHz to < 27 GHz	-42 dBc (-54 dBc)
27 GHz to < 40 GHz	-36 dBc (-47 dBc)
40 GHz to 44 GHz	-42 dBc (-54 dBc)

Absolute SSB phase noise (CW) (dBc/Hz) (option ST6), () = typical

Frequency	1 Hz	10 Hz	100 Hz	1 kHz	10 kHz
≤ 100 MHz	-81 (-90)	-102 (-108)	-114 (-119)	-125 (-131)	-132 (-136)
≤ 250 MHz	-75 (-83)	-97 (-104)	-108 (-114)	-121 (-127)	-130 (-135)
≤ 500 MHz	-71 (-78)	-96 (-104)	-106 (-113)	-128 (-134)	-134 (-139)
≤ 1 GHz	-65 (-73)	-88 (-97)	-100 (-107)	-125 (-132)	-133 (-137)
≤ 2 GHz	-59 (-66)	-84 (-92)	-94 (-101)	-121 (-128)	-131 (-136)
≤ 3.2 GHz	-54 (-61)	-79 (-87)	-88 (-96)	-117 (-124)	-127 (-132)
≤ 10 GHz	-42 (-51)	-69 (-77)	-80 (-87)	-108 (-115)	-120 (-126)
≤ 20 GHz	-38 (-45)	-64 (-72)	-74 (-81)	-100 (-108)	-113 (-118)
≤ 30 GHz	-35	-61	-71	-97	-110
≤ 40 GHz	-32	-58	-68	-94	-107
Frequency	100 kHz	1 MHz	10 MHz ⁹	100 MHz ⁹	
≤ 100 MHz	-132 (-137)	-132 (-137)	-131 (-138)	-129	
≤ 250 MHz	-133 (-137)	-134 (-138)	-132 (-139)	-132 (-138)	
≤ 500 MHz	-133 (-138)	-133 (-139)	-131 (-139)	-131 (-138)	
≤ 1 GHz	-133 (-138)	-135 (-139)	-133 (-140)	-132 (-139)	
≤ 2 GHz	-134 (-139)	-137 (-141)	-136 (-143)	-135 (-142)	
≤ 3.2 GHz	-133 (-138)	-139 (-143)	-137 (-144)	-138 (-144)	
≤ 10 GHz	-128 (-133)	-136 (-141)	-140 (-146)	-139 (-146)	
≤ 20 GHz	-120 (-125)	-128 (-134)	-133 (-140)	-133 (-140)	
≤ 30 GHz	-117	-125	-130	-130	
≤ 40 GHz	-114	-122	-127	-127	

⁹ Offset only specified when frequency option F32 or F44 is present.

Absolute SSB phase noise (CW) (dBc/Hz) (option ST5 with F32 or F44), () = typical, serial prefix ≥ 6033

Frequency	1 Hz	10 Hz	100 Hz	1 kHz	10 kHz
≤ 100 MHz	-77 (-87)	-98 (-104)	-112 (-117)	-122 (-128)	-129 (-135)
≤ 250 MHz	-70 (-79)	-91 (-98)	-107 (-113)	-119 (-125)	-126 (-133)
≤ 500 MHz	-67 (-74)	-86 (-93)	-102 (-110)	-128 (-133)	-132 (-139)
≤ 1 GHz	-59 (-67)	-80 (-87)	-92 (-101)	-120 (-127)	-131 (-137)
≤ 2 GHz	-55 (-62)	-74 (-81)	-94 (-100)	-116 (-123)	-127 (-133)
≤ 3.2 GHz	-51 (-57)	-69 (-76)	-88 (-95)	-113 (-119)	-122 (-129)
≤ 10 GHz	-40 (-48)	-60 (-67)	-80 (-86)	-103 (-109)	-113 (-120)
≤ 20 GHz	-36 (-42)	-54 (-61)	-69 (-77)	-94 (-102)	-108 (-114)
≤ 30 GHz	-32	-50	-65	-90	-104
≤ 40 GHz	-30	-48	-63	-88	-102
Frequency	100 kHz	1 MHz	10 MHz	100 MHz	
≤ 100 MHz	-132 (-138)	-131 (-138)	-130 (-138)	-129 (-129)	
≤ 250 MHz	-132 (-138)	-133 (-139)	-131 (-140)	-130 (-139)	
≤ 500 MHz	-133 (-139)	-132 (-139)	-130 (-139)	-130 (-139)	
≤ 1 GHz	-133 (-139)	-134 (-140)	-132 (-141)	-130 (-139)	
≤ 2 GHz	-133 (-139)	-135 (-142)	-134 (-142)	-134 (-143)	
≤ 3.2 GHz	-131 (-137)	-136 (-142)	-136 (-144)	-137 (-145)	
≤ 10 GHz	-122 (-128)	-131 (-137)	-137 (-144)	-138 (-146)	
≤ 20 GHz	-115 (-122)	-125 (-131)	-131 (-139)	-132 (-140)	
≤ 30 GHz	-111	-121	-127	-128	
≤ 40 GHz	-109	-119	-125	-126	

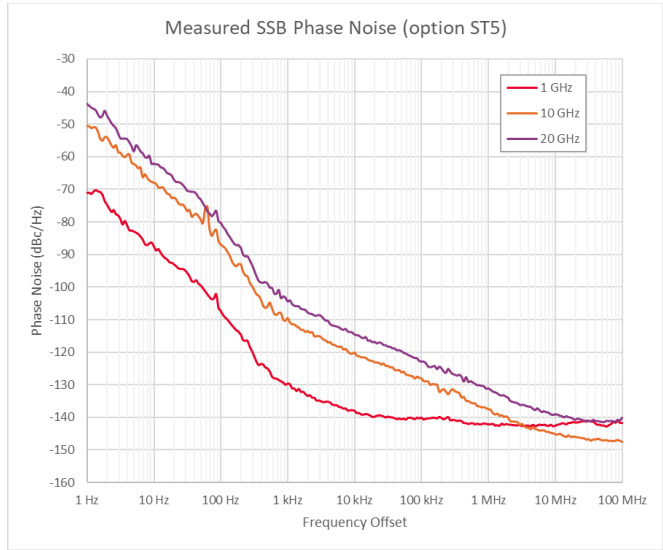
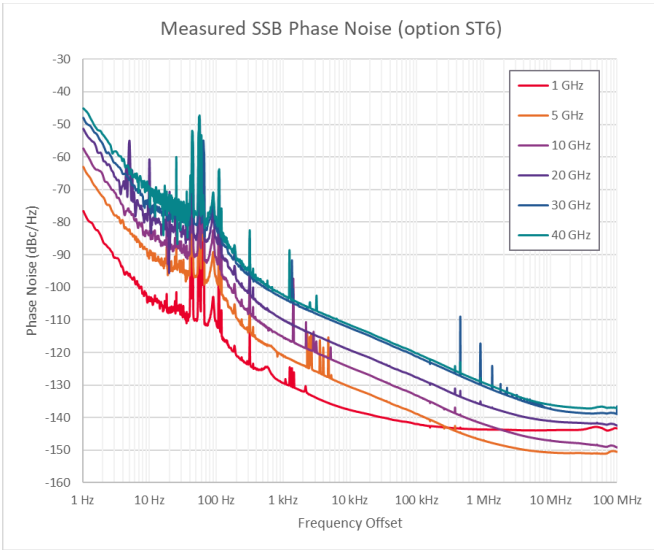

Pulse Modulation (Option PMR or PME)

Pulse paths			
Internal pulse generator, external input			
Minimum pulse width (T_w) with duty cycle $\leq 50\%$			
ALC on	1 μ s (nom.)		
ALC off, 10 MHz to 20 GHz	100 ns (nom.)		
ALC off, > 20 GHz	30 ns (nom.)		
On/off ratio			
Frequency	Without I/Q modulation (F14/F20 and no 1ES)	Without I/Q modulation (F32/44)	With I/Q modulation
< 3.2 GHz	88 dB (typ)	87 dB (95 dB typ)	80 dB (nom.)
3.2 GHz to < 11 GHz	78 dB (typ)	57 dB (66 dB typ)	80 dB (nom.)
11 GHz to < 12.5 GHz	64 dB (typ)	42 dB (52 dB typ)	80 dB (nom.)
12.5 GHz to < 17 GHz	72 dB (typ)	47 dB (57 dB typ)	80 dB (nom.)
17 GHz to < 20 GHz	69 dB (typ)	50 dB (52 dB typ)	80 dB (nom.)
20 GHz to < 30.8 GHz	-	74 dB (85 dB typ)	80 dB (nom.)
30.8 GHz to < 44 GHz	-	80 dB (92 dB typ)	80 dB (nom.)

Rise/fall times (T_r and T_f)	
ALC off	14 ns
Level accuracy relative to CW	
10 MHz to 44 GHz	± 1.2 dB (± 0.5 dB typical)
Width compression ($T_{rf} - T_w$)	
≤ 20 GHz	- 5 ns to +16 ns
> 20 GHz	-10 ns to +5 ns
Video feed-through (V_f)	
500 MHz to 3.1 GHz	493 mV pk-pk (269 mV pk-pk typical)
> 3.1 GHz to 4.2 GHz	135 mV pk-pk (60 mV pk-pk typical)
> 5.2 GHz to 44 GHz	44 mV pk-pk (19 mV pk-pk typical)
RF delay (external input to RF output)	
< 20 GHz	< 250 ns (nom)
>20 GHz	< 120 ns (nom)
Pulse overshoot, (%) = typical	
≤ 400.7 MHz	31% (19%)
400.7 MHz to < 26 GHz	13% (5%)
26 GHz to 44 GHz	30% (12%)
External input level	
RF on	+1 V (nom.)
RF off	0 V (nom.)
External input impedance	
50 Ω (nom.)	

- Td video delay (variable)
- Tw video pulse width (variable)
- Tp Pulse period (variable)
- Tm RF delay
- Trf RF pulse width
- Tf RF pulse fall time
- Tr RF pulse rise time
- Vor pulse overshoot
- Vf video feedthrough

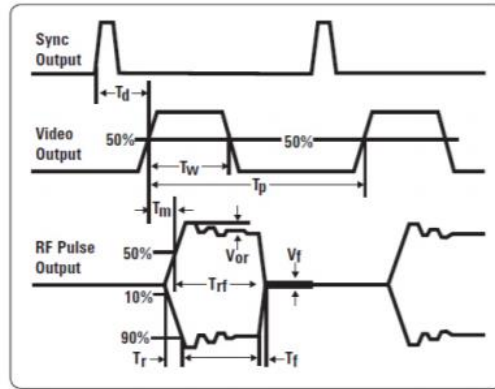

Internal Pulse Generator (Option PMR or PME)

Internal pulse generator			
Modes	Square, adjustable, doublet, pulse train (SCPI only)		
Triggering	Free run, triggered, triggered doublet, gated, external pulse		
Square wave rate	(50 MHz)/k from 0.1 Hz to 16.66 MHz where k is an integer (nom)		
Signal routing			
Signal	M9383B (F44)	M9384B (F14 or F20)	M9384B (F32 or F44)
External pulse input	M9314B Trig 1	Pulse In	Pulse In
Pulse video output	M9323A Trig 1	Trig 1	Pulse Video Out
Pulse sync output	M9323A Trig 2	Trig 2	Pulse Sync Out

Timing		
Pulse period (PRI) (T_p)		60 ns to 42 s
Pulse width (T_w)		30 ns to 41.99 s
Video delay (T_d)	Free run	0 to 42s
	Triggered modes	0 to 42s
Sync trigger		30 ns to 3.99 s
Pulse doublets	Delay 1	0 to 42s
	Pulse width 1	30 ns to 41.99 s
	Delay 2	60 ns to 42s
	Pulse width 2	30 ns to 41.99s
Pulse train generator (Option 320, SCPI only)		
Number of pulse patterns		2047
On/off time range		30 ns to 42 s

Vector Modulation (Option Dxx)

External I/Q input (option EXT)		
Type	Differential: I, \bar{I} , Q, \bar{Q}	
Input impedance	50 Ω (nom.)	
External recommended input level	-1 dBm or 0.2 V _{rms} (nom.)	
External input level range	0.1 V _{rms} minimum 1 V _{peak} maximum	
External I/Q offset	$\pm 50\%$	
External I/Q quadrature skew	< 3.2 GHz	None
	≥ 3.2 GHz	$\pm 20^\circ$
External I/Q gain balance	± 10 dB (nom.)	
External I/Q input bandwidth (option EXT)		
Frequency	I/Q Bandwidth	
1 MHz to < 375 MHz	20% of carrier	
375 MHz to < 550 MHz	200 MHz	
550 MHz to < 750 MHz	300 MHz	
750 MHz to < 1 GHz	400 MHz	
1 GHz to < 1.5 GHz	750 MHz	
1.5 GHz to < 3.2 GHz	1 GHz	
3.2 GHz to 44 GHz	2 GHz	

RF path filters ¹⁰ (nom.)	
Carrier frequency	Filter cut-off frequency
>3.2 to 4.3 GHz	5.3 GHz low pass filter
4.3 to 6.5 GHz	2.5 to 8 GHz high + low pass filter
6.5 to 11 GHz	5 GHz to 12.5 GHz high + low pass filter
11 to 19.5 GHz	8 GHz to 21 GHz high + low pass filter
19.5 to 22.3 GHz	18.5 to 23.3 GHz bandpass + low pass filter
22.3 to 25.1 GHz	21.3 to 26.1 GHz bandpass + low pass filter
25.1 to 28.5 GHz	24.1 to 29.5 GHz bandpass filter
28.5 to 30.5 GHz	27.5 to 31.5 GHz bandpass filter
30.5 to 32.9 GHz	29.5 to 33.9 GHz bandpass filter
32.9 to 35.3 GHz	31.9 to 36.3 GHz bandpass filter
35.3 to 38 GHz	34.3 to 39 GHz bandpass filter
38 to 40.4 GHz	37 to 41.4 GHz bandpass filter
40.4 to 44 GHz	39.4 to 45 GHz bandpass filter
Internal I/Q baseband generator adjustments	
Internal I and Q offset	± 20% (nom.)
Internal I/Q quadrature skew	± 20° (0.001° resolution)
Internal I/Q gain balance	± 10 dB (nom.) (0.001 dB resolution)
Internal I/Q time skew	± 19.5 ns (1 ps resolution)
Fine I/Q delay range	0 to 1.589609 µs
Fine I/Q delay resolution	1 ps

¹⁰ The IF filter cut off is 10.5 GHz when upconverting above 19.5 GHz. When above 19.5 GHz and center frequency $f < 28.5$ GHz, the IF is $\frac{f}{3}$. For $f \geq 28.5$ GHz, the IF is $\frac{f}{5}$. Therefore, modulation bandwidth is limited by how close $\frac{f}{3}$ or $\frac{f}{5}$ is to the cutoff of 10.5 GHz IF filter. For example, at 21 GHz, the IF is centered at $\frac{21}{3} = 7$ GHz, which provides 3.5 GHz overhead since $10.5 - 7 = 3.5$.

I/Q baseband output (option DIQ)		
Type	Single-ended, differential: I, \bar{I} , Q, \bar{Q}	
Output impedance	Single ended	50 Ω (nom.)
	Differential	100 Ω (nom.)
Frequency range	DC to 1 GHz (nom.) for < 1 dB bandwidth	
Common-mode I/Q offset	\pm 200 mV (0.001 mV resolution)	
Differential mode I or Q offset	\pm 50 mV (0.001 mV resolution)	
I/Q baseband output amplitude ¹¹		
Internal I/Q modulation	Single ended	0 V _{pp} to 0.8 V _{pp}
	Differential	0 V _{pp} to 1.6 V _{pp}
I/Q baseband output spectral purity		
SFDR (sine)	10 MHz tone	-75 dBc (measured)
	500 MHz tone	-66 dBc (measured)
Noise floor	100 MHz tone measured at 133 MHz	\leq -159 dBm/Hz (measured)
Phase noise	100 MHz tone, 10 MHz offset	-162 dBc/Hz (measured)

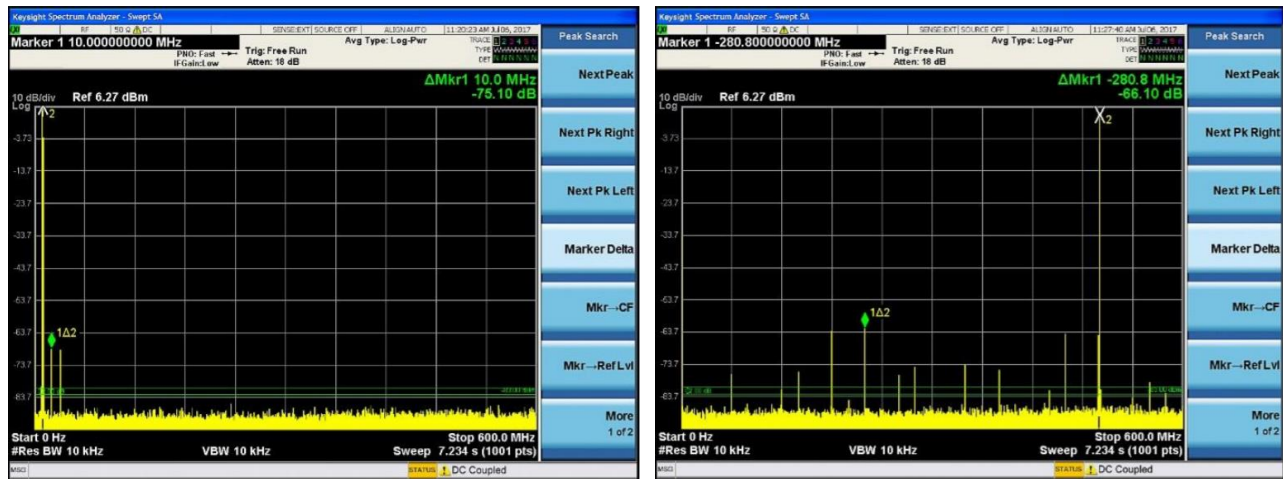

Figure 3: (Left) Measured IQ output, 10 MHz tone spectrum. (Right) Measured IQ output, 500 MHz tone spectrum.

¹¹ At maximum sample rate. Reducing sample rate will allow for higher amplitude settings.

Internal real-time complex digital I/Q filters

Factory channel corrections – corrects the linear phase and amplitude response of the baseband I/Q and RF outputs of the signal generator using factory calibration arrays.

RF amplitude flatness	1 GHz bandwidth	$< \pm 0.7$ dB (nom.)
	1.6 GHz bandwidth	$< \pm 0.7$ dB (nom.)
	2 GHz bandwidth	$< \pm 0.9$ dB (nom.)

User defined automatic channel response correction and S-parameter de-embedding (N7653APPC)

Methods for fixture error removal

Scatter parameters de-embedding/embedding files generated by a network analyzer or simulation

Automatic channel response correction using a power sensor or spectrum analyzer (amplitude and phase correction)

Scaler user flatness (absolute power correction)

Scatter parameters

File format	.s2p, .csv
Number of cascadeable calibration sets	4

Automated channel response correction (128 taps)¹²

Recommended maximum amplitude for error correction	± 15 dB
Recommended maximum phase error for correction	$\pm 25^\circ$

User flatness

File format	.uflat, .csv
Entry modes	USB or LAN direct power meter control

¹² Automated routine uses power sensor to correct for linear phase and amplitude response of DUT (equalizer). See [User Documentation](#) for more details.

Internal Baseband Generator (Option Dxx)

Internal baseband generator (option Dxx)				
Channels		In phase (I), quadrature (Q)		
DAC resolution		16 bits [1/65536]		
Waveform granularity		8 samples		
Sample rate	Option D05 or D06	1 Hz to 625 MHz		
	Option D10 or D11	1 Hz to 1.28 GHz		
	Option D20, D21, or D2E ¹³	1 Hz to 2.56 GHz		
Same rate resolution		1 Hz		
Interpolated DAC rate		Fixed 2.56 GHz		
RF (I + Q) bandwidth				
Frequency	Option D05 and D06	Option D10 and D11	Option D20 and D21	Option D2E
1 MHz to < 375 MHz	20% of carrier	20% of carrier	20% of carrier	20% of carrier
375 MHz to < 550 MHz	200 MHz	200 MHz	200 MHz	200 MHz
550 MHz to < 750 MHz	300 MHz	300 MHz	300 MHz	300 MHz
750 MHz to < 1 GHz	400 MHz	400 MHz	400 MHz	400 MHz
1 GHz to < 1.5 GHz	500 MHz	750 MHz	750 MHz	750 MHz
1.5 GHz to < 3.2 GHz	500 MHz	1 GHz	1 GHz	1 GHz
3.2 GHz to < 31.35 GHz	500 MHz	1 GHz	2 GHz	2 GHz
31.35 GHz to < 31.85 GHz	500 MHz	1 GHz	2 GHz	1 GHz
31.85 GHz to 36.95 GHz	500 MHz	1 GHz	2 GHz	550 MHz
> 36.95 GHz to 37.45 GHz	500 MHz	1 GHz	2 GHz	1 GHz
> 37.45 GHz to 44 GHz	500 MHz	1 GHz	2 GHz	2 GHz

¹³ Option D2E maximum sample rate is frequency dependent.

Arbitrary waveform memory		
Maximum arbitrary waveform playback memory		256 MSa (standard) 512 MSa (option M05) 1024 MSa (option M10)
Maximum storage capacity		16 GB shared with operating systems (nom.)
Triggers		
Trigger types		Continuous, single
Trigger sources		Trigger key, external, bus (LAN, GPIB)
Trigger modes	Continuous	Free run, trigger & run, reset & run
	Single	Buffered trigger, no retrigger, restart on trigger
Course trigger delay range		0 to 10 s
Course trigger delay resolution		3.125 ns
Fine I/Q delay range		See Internal I/Q baseband adjustment generator section
Fine I/Q delay resolution		See Internal I/Q baseband adjustment generator section
Trigger jitter		± 3.125 ns (320 MHz trigger sample rate)
Trigger latency with correction filter on		1086 ns + $(21 \times \text{sample clock in ns})$ + RF path latency
Trigger RF electrical latency		Variable depending on attenuator path and cabling

Multi-channel baseband synchronization master/subordinate (option PCH)

Trigger types	Continuous, single	
Trigger sources	Trigger key, external, bus (LAN, GPIB)	
Trigger modes	Continuous	Free run, trigger & run, reset & run
	Single	Buffered trigger, no retrigger, restart on trigger
Global course trigger delay range ¹⁴	0 ns to 12 s	
Global course trigger delay resolution ¹⁴	3.125 ns	
Global trigger jitter	± 50 ns relative to asynchronous external system trigger event	
Relative trigger repeatability	± 5 ps	
Relative trigger repeatability after power cycle	± 25 ps	
Relative fine I/Q delay range	Delay of channel 1 relative to channel 2. See Internal I/Q baseband adjustment generator section.	
Relative fine I/Q delay resolution	Delay of channel 1 relative to channel 2. See Internal I/Q baseband adjustment generator section.	
Relative phase adjust range	See Frequency section	
Relative phase adjust resolution	See Frequency section	
Relative phase repeatability	See Frequency section	
Trigger latency with correction filter on	1642.25 ns + (21 × sample clock in ns) + RF path latency	
Trigger RF electrical latency	Variable depending on attenuator path and cabling	

¹⁴ For channel 1 and channel 2 together.

Markers	
Markers are defined in a segment during the waveform generation process. A marker can also be routed to the RF blanking and/or external output. See User's Documentation for more information.	
Marker polarity	Positive
Number of markers	4
RF blanking/burst or on/off ratio	> 80 dB
Marker to waveform jitter	< 250 ps (sample rate is a submultiple of 2.56 GHz) < 3.125 ns (sample rate is not a submultiple of 2.56 GHz)

Error Vector Magnitude (EVM)

EVM for 5G NR FR2 bands and IFs, -14 dBm to +6 dBm (nom.) ¹⁵ , option ST6		
Frequency	100 MHz, 256QAM, 120 kHz SCS, NRB = 66 or 5GTF	400 MHz, 256QAM, 120 kHz SCS, NRB = 264
3.4 GHz	0.35%	0.65%
10 GHz	0.42%	0.73%
12 GHz	0.43%	0.71%
24.5 GHz	0.85%	1.50%
28 GHz	0.96%	1.60%
39 GHz	1.42%	1.86%
42.5 GHz	1.97%	2.10%
EVM for 5G NR FR1 bands, -14 dBm to +6 dBm (nom.) ¹⁵ , option ST6		
Frequency	100 MHz, 256QAM, 60 kHz SCS, NRB = 135	
2.3 GHz	0.49%	
3.55 GHz	0.47%	
4.9 GHz	0.37%	

¹⁵ Measured EVM after DC calibration.

EVM for LTE, -15 dBm to +5 dBm (nom.)¹⁶, option ST6

Frequency	LTE FDD E-TM 3.1, 10 MHz, 64 QAM PDSCH, full resource block
2 GHz	0.28%

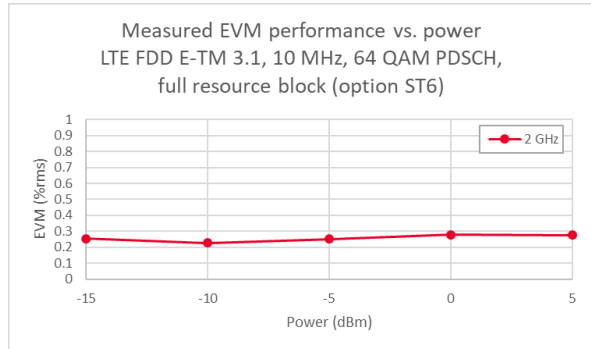
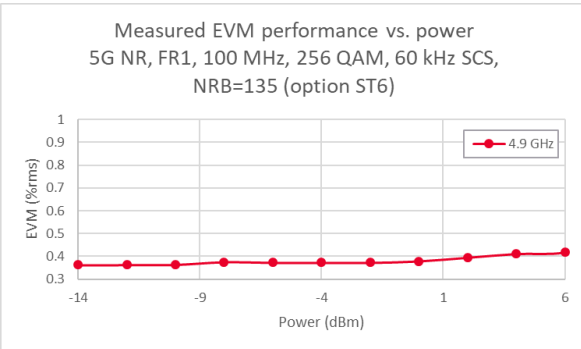
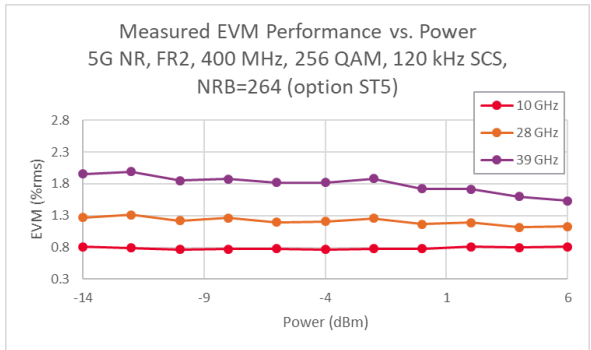
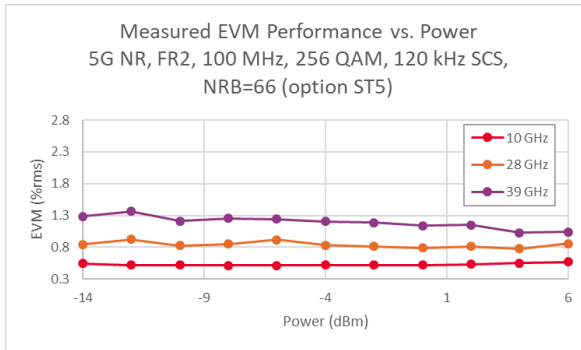
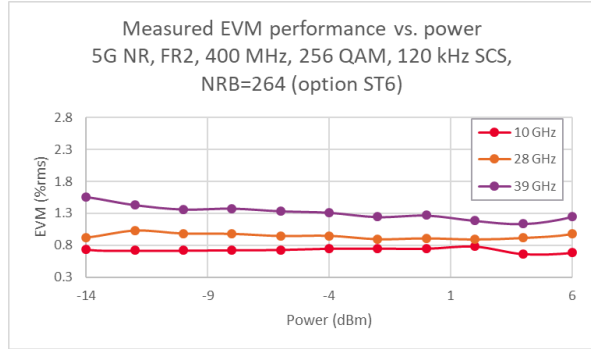
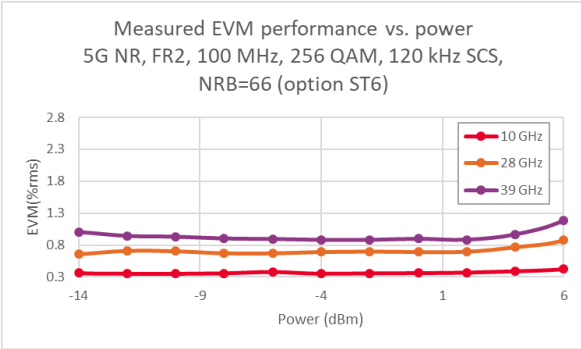

¹⁶ Measured EVM after DC calibration.

Adjacent Channel Power Ratio (ACPR)

ACPR for 5G NR FR2 bands and IFs, -15 dBm to +5 dBm (nom.)				
Frequency	100 MHz, 256QAM, 120 kHz SCS, NRB = 66	400 MHz, 256QAM, 120 kHz SCS, NRB = 264 ¹⁷	8cc x 100 MHz (800 MHz), 256QAM, 120 kHz SCS, NRB = 66 or 5GTF	14cc x 100 MHz (1.4 GHz), 256QAM, 120 kHz SCS, NRB = 66
10 GHz	-53 dBc	-48 dBc	-45 dBc	-41 dBc
24.5 GHz	-49 dBc	-45 dBc	-42 dBc	-38 dBc
28 GHz	-48 dBc	-44 dBc	-42 dBc	-38 dBc
39 GHz	-45 dBc	-40 dBc	-37 dBc	-34 dBc
42.5 GHz	-42 dBc	-37 dBc	-35 dBc	-32 dBc

ACPR for 5G NR FR1 bands, -15 dBm to +5 dBm (nom.)	
Frequency	100 MHz, 256QAM, 60 kHz SCS, NRB = 135
2.3 GHz	-51 dBc
3.55 GHz	-53 dBc
4.9 GHz	-53 dBc

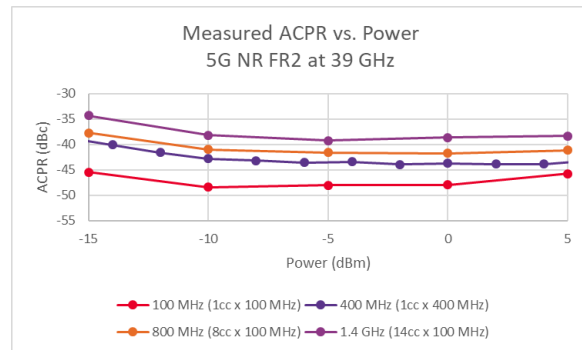
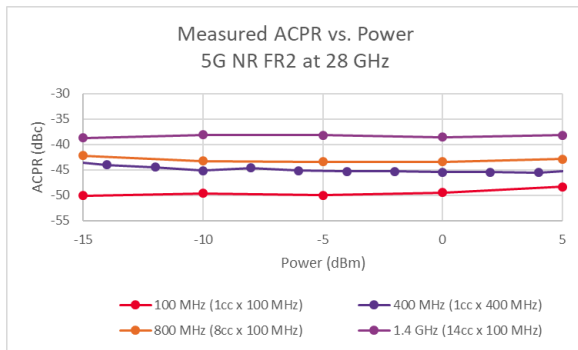

¹⁷ Over power range -14 dBm to +6 dBm.

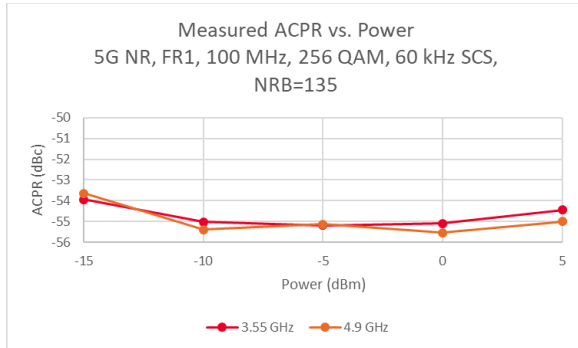

Remote Programming

Remote programming	
Software drivers	IVI.NET
Interfaces	GPIB (IEEE-488.2,1987) with listen and talk, and 1000BaseT LAN interface
Control languages	SCPI version 1999.0
IEEE-488 functions	SH1, AH1, T6, TE0, L4, LE0, SR1, RL1, PP0, DC1, DT0, C0, E2
Keysight IO libraries	Keysight's IO Library Suite helps you quickly establish an error-free connection between your PC and instruments – regardless of the vendor. It provides robust instrument control and works with the software development environment you choose.

Environmental Specifications

Environmental specifications and regulatory compliance		
Temperature	Operating	0 to 45 °C (single channel), 0 to 40 °C (dual channel)
	Storage	-40 to +70 °C
Humidity		Type tested at 95%, +40 °C (non-condensing) (From 40°C to 45°C, the maximum % relative humidity follows the line of constant dew point.)
Shock/Vibration	Operating random vibration	Type tested at 5 to 500 Hz, 0.21 g rms
	Survival random vibration	Type tested at 5 to 500 Hz, 2.09 g rms
	Functional shock	Type tested at half-sine, 30 g, 11 ms
	Bench handling	Type tested per MIL-PRF-28800F
Altitude	Operating	Up to 10,000 feet (3,048 meters)
	Storage	Up to 15,000 feet (4,572 meters)
EMC		<p>Complies with European EMC Directive</p> <ul style="list-style-type: none"> – IEC/EN 61326-1 – CISPR Pub 11 Group 1, class A – AS/NZS CISPR 11 – ICES/NMB-001 <p>This ISM device complies with Canadian ICES-001. Cet appareil ISM est conforme a la norme NMB-001 du Canada.</p>
Environmental testing		Samples of this product have been type tested in accordance with the Keysight Environmental Test Manual and verified to be robust against the environmental stresses of storage, transportation and end-use. Those stresses include but are not limited to temperature, humidity, shock, vibration, altitude and power-line conditions. Test methods are aligned with IEC 60068-2 and levels are similar to MIL-PRF-28800F Class 3.

M9384B VXG General Specifications

Physical specifications		
Weight	Single channel (F14 or F20)	29 kg (63.2 lbs.)
	Single channel (F32 or F44)	30 kg (66 lbs.)
	Dual channel (F14 or F20)	32 kg (71.2 lbs.)
	Dual channel (F32 or F44)	35 Kg (77.2 lbs.)
Dimensions (L x W x H)		583 mm x 445 mm x 194 mm
Power requirements		
Single channel		640 W
Dual channel		1000 W
Display		
Resolution		1280 x 768 pixels
Size		10.6 in (26.9 cm) diagonal
Data storage		
Internal		Removable solid state drive (240 GB)
External		Supports USB 3.0/2.0 compatible memory devices

M9384B VXG Input and Output Connectors

Front panel connectors		
Connectors	Type	Description
19.2 GHz Out 1	SMA female	Output of 19.2 GHz CW frequency reference, cabled from the factory to 19.2 GHz In. This port is always-on level is 7.3 dBm (nominal), if alternate 19.2 GHz In is provided this port should be terminated with 50 Ω load.
19.2 GHz Out 2	SMA female	Output of 19.2 GHz CW frequency reference switched from user interface; off by default. High impedance when off, 50 Ω when on, level is 7.3 dBm (nominal).
100 MHz Out	SMB male	Output of 100 MHz CW frequency reference, switched from the user interface; off by default. High impedance when off, 50 Ω when on, level is +15 dBm (nominal).
Trig 1	SMB male	For options F32/F44, reserved for future use. For options F14/F20 with options PME/PMR Pulse Video Out outputs signal following envelope of RF pulse. Instruments with option 002 have connector for CH2.

Trig 2	SMB male	For options F32/F44, reserved for future use. For options F14/F20 with options PME/PMR Pulse Sync Out outputs signal (trigger) related to pulse timing. VOL < 0.4 V, VOH is 2.8 V to 3.3 V into high impedance. 50 Ω impedance (nominal). Damage level is ± 5 V. Instruments with option 002 have connector for CH2.
Settled	SMB male	Output signal to determine when the signal level is settled: logic High while settled and low (approximately 0v) when change is in progress. CMOS +3.3V Logic. Damage level is <-5V and >6.5V. Instruments with option 002 have connector for CH2.
EFC In	SMB male	Reserved for future use. ESD damage level is 30 V.
LF1 Out	SMB male	Reserved for future use.
AM In	BNC female	Reserved for future use. 50 Ω impedance (nominal). Damage level is 10 V peak, 5 V rms. Instruments with option 002 have connector for CH2.
Pulse In	BNC female	For options PME/PMR externally provided Pulse modulation signal. 1 M Ω impedance (nominal). Damage level is 10 V peak, 5 V rms. Instruments with option 002 have connector for CH2.
Pulse Video Out	SMB male	For options F32/F44 with options PME/PMR, outputs signal following envelope of RF pulse. VOL < 0.4 V, VOH is 2.8 V to 3.3 V into high impedance. 50 Ω impedance (nominal). Damage level is ± 5 V. Instruments with option 002 have connector for CH2.
Pulse Sync Out	SMB male	For options F32/F44 with options PME/PMR, outputs signal (trigger) related to pulse timing. VOL < 0.4 V, VOH is 2.8 V to 3.3 V into high impedance. 50 Ω impedance (nominal). Damage level is ± 5 V. Instruments with option 002 have connector for CH2.
RF Out 1/2	Option F32/F44 – 2.4 mm male Option F14/F20 – APC 3.5 mm male	RF Output signal, level selected by user interface. 50 Ω impedance (nominal). Instruments with option 002 have connector for CH2.
CH1 +I Out	SMA female	Analog in-phase component of I/Q modulation from channel 1's internal baseband generator. Frequency range is DC to 1000 MHz (nominal). 50 Ω impedance (nominal). Damage level is ± 2 V.
CH2 I Out	SMA female	For instruments with option 002, outputs the in-phase component of channel 2's analog I/Q modulation. Frequency range is DC to 1000 MHz (nominal). 50 Ω impedance (nominal). Damage level is ± 2 V.
CH1 -I Out	SMA female	Analog in-phase component of I/Q modulation from channel 1's internal baseband generator, 180° out of phase from +I Out. Frequency range is DC to 1000 MHz (nominal). 50 Ω impedance (nominal). Damage level is ± 2 V.
CH1 +Q Out	SMA female	Analog quadrature-phase component of I/Q modulation from channel 1's internal baseband generator. Frequency range is DC to 1000 MHz (nominal). 50 Ω impedance (nominal). Damage level is ± 2 V.

CH2 Q Out	SMA female	For instruments with option 002, outputs the quadrature component of channel 2's analog I/Q modulation. Frequency range is DC to 1000 MHz (nominal). 50 Ω impedance (nominal). Damage level is ± 2 V.
CH1 -Q Out	SMA female	Analog quadrature-phase component of I/Q modulation from channel 1's internal baseband generator, 180° out of phase from +Q Out. Frequency range is DC to 1000 MHz (nominal). 50 Ω impedance (nominal). Damage level is ± 2 V.
CH1 I+ In	SMA female	For option EXT, externally supplied analog in-phase component of I/Q modulation to channel 1's internal baseband generator. Frequency range is DC to 1000 MHz (nominal). 50 Ω impedance (nominal). Damage level is 5 V peak, 1 V rms.
CH2 I In	SMA female	For option EXT and option 002, input for in-phase component of channel 2's analog I/Q modulation. Frequency range is DC to 1000 MHz (nominal). 50 Ω impedance (nominal). Damage level is 5 V peak, 1 V rms.
CH1 I- In	SMA female	For option EXT, externally supplied analog in-phase component of I/Q modulation to channel 1's internal baseband generator, 180° out of phase from I+ In. Frequency range is DC to 1000 MHz (nominal). 50 Ω impedance (nominal). Damage level is 5 V peak, 1 V rms.
CH1 Q+ In	SMA female	For option EXT, externally supplied analog quadrature-phase component of I/Q modulation to channel 1's internal baseband generator. Frequency range is DC to 1000 MHz (nominal). 50 Ω impedance (nominal). Damage level is 5 V peak, 1 V rms.
CH2 Q In	SMA female	For option EXT and option 002, input for quadrature component of channel 2's analog I/Q modulation. Frequency range is DC to 1000 MHz (nominal). 50 Ω impedance (nominal). Damage level is 5 V peak, 1 V rms.
CH1 Q- In	SMA female	For option EXT, externally supplied analog quadrature-phase component of I/Q modulation to channel 1's internal baseband generator, 180° out of phase from Q+ In. Frequency range is DC to 1000 MHz (nominal). 50 Ω impedance (nominal). Damage level is 5 V peak, 1 V rms.
19.2 GHz In	SMA female	Input for 19.2 GHz CW frequency reference required for instrument operation. +5 dBm (nominal). 50 Ω impedance (nominal). Damage level is +20 dBm.
BBG Sync	SMA female	Reserved for future use. In instruments with option 002 this is a wired-or of the two channels.
Ctrl M	uHDMI female	Reserved for future use. Damage level is <-0.5V and >6.5V.
Ctrl S	uHDMI female	Reserved for future use. Damage level is <-0.5V and >6.5V.
USB 3.0	USB Type-A female	Host controller, SuperSpeed, 900 mA (nominal)
USB 2.0	USB Type-A female	Host controller, high-speed, 1.2 A (nominal)
Display Port	DisplayPort	For external display devices. Display Port Dual Mode DisplayPort++ (DVI-D, VGA, HDMI with an adapter). NOTE: To duplicate the instrument's application on an external display it is recommended to set the resolution to 1280x768.

Power switch		Turns the instrument on and off.
Power Green LED		Indicates power is on.
Power Yellow LED		Indicates AC power is connected and some internal circuitry is live.
Rear panel connectors		
Connectors	Type	Description
10 MHz In	BNC female	Externally supplied 10 MHz CW frequency reference, switched by the user interface; off by default. Input level -3dBm to +20 dBm (nominal), 50 Ω impedance. ESD damage level is 30 V.
10 MHz Out	BNC female	Output of 10 MHz CW frequency reference, this port is always on. +15 dBm (nominal). 50 Ω impedance (nominal). ESD damage level is 30 V.
100 MHz Out	SMA female	Output of 100 MHz CW frequency reference, cabled from the factory to EXT CLK IN. This port is always-on level is +15 dBm (nominal). If alternate EXT CLK IN is provided this port should be terminated with 50 Ω load. Connector for CH1 and CH2.
CH1 EXT 1	BNC female	External baseband generator trigger input for channel 1. 10 k Ω input impedance (nominal). Damage level is ± 5 V.
CH2 EXT 1	BNC female	External baseband generator trigger input for channel 2. 10 k Ω input impedance (nominal). Damage level is ± 5 V. Unused if option 002 is not present.
CH1 SYNC OUT	BNC female	Output of TTL High as assigned to Signal's Marker Setup for channel 1. VOL < 0.4 V, VOH is 2.8 V to 3.3 V into high impedance. 50 Ω impedance (nominal). Damage level is ± 5 V.
CH2 SYNC OUT	BNC female	Output of TTL High as assigned to Signal's Marker Setup for channel 2. VOL < 0.4 V, VOH is 2.8 V to 3.3 V into high impedance. 50 Ω impedance (nominal). Damage level is ± 5 V. Unused if option 002 is not present.
EXT CLK IN	SMA female	Input of an external 100 MHz reference clock required for instrument operation. +10 dBm (nominal). 50 Ω impedance (nominal). Damage level is +20 dBm. One per channel, channel 2 is unused if option 002 is not present.
GPIB	Micro-D 25-pin	IEEE-488.2, 1987 with listen and talk. Use accessory Y1260A for GPIB cabling.
LAN	RJ45 Ethertwist	GbE 10/100/1000BASE-T Ethernet: the LAN supports DHCP, connection monitoring, dynamic hostname services, TCP/IP communication, TCP keep alive, and SCPI remote programming.

M9383B VXG-m Physical Specifications

Physical Specifications			
Module	Size	Dimensions (L x W x H)	Weight
M9312B	3 PXIe slots	205 mm x 61.8 mm x 130 mm	1.9 kg (4.2 lbs.)
M9314B	1 PXIe slot	205 mm x 21.2 mm x 130 mm	0.6 kg (1.4 lbs.)
M9323A	1 PXIe slot	205 mm x 21.2 mm x 130 mm	0.6 kg (1.4 lbs.)
M9343A	3 PXIe slots	205 mm x 61.8 mm x 130 mm	1.6 kg (3.6 lbs.)
M9347A	1 PXIe slot	205 mm x 20.2 mm x 130 mm	0.7 kg (1.6 lbs.)
Power requirements			
Single channel		630 W	
Dual channel		990 W	

M9383B VXG-m Input and Output Connectors

M9312B		
Connectors	Type	Description
4.8 GHz In	APC female (3.5 mm)	Inputs a 4.8 GHz reference clock from the M9043A Chassis 4.8 GHz Out 1 connector.
4.8 GHz Out	APC female (3.5 mm)	Outputs a copy of 4.8 GHz signal accepted by the 4.8 GHz In connector.
LO 2 Out	APC female (3.5 mm)	Outputs either a copy of LO 1 In signal or a doubled copy of LO 1 In signal (selectable) to the M9314B LO 1 In connector.
100 MHz In	SMP male	Inputs a 100 MHz reference signal from the M9043A Chassis 100 MHz Out 3 connector.
100 MHz Out	SMP male	Outputs a copy of the 100 MHz reference signal (received by 100 MHz In connector) to the M9347A Ref In connector.
LF Out	SMP male	Outputs a waveform from the internal function generator or a copy of the AM modulated signal.
AM In	SMP male	Reserved for future use. 0 to 1 MHz (nominal). 1.0V (nominal) for 100% AM. 1 M Ω impedance (nominal). Damage level is ± 15 V.
Trig 1	SMP male	Accepts a bi-directional trigger signal from the M9343A Ext 2 connector.
Trig 2	SMP male	Accepts a bi-directional trigger signal from the M9314B Trig 2 connector.
Sync Out	SMP male	Accepts a bidirectional signal used for synchronization with other modules.

LO 1 In	SMA female	Accepts an LO signal between 400 MHz and 10 GHz from the M9347A Synth 1 Out connector.
LO 1 Out	SMA female	Outputs either a copy of LO 1 In signal or a doubled copy of LO 1 In signal (selectable) to the M9343A LO 1 In connector.
RF Out	Female (2.4 mm)	Outputs an RF signal between 1 MHz and 20 GHz to the M9323A RF In connector when Aux Out is connected to Aux In. Otherwise, outputs the signal to the Aux Out connector attenuated by the selected attenuation value.
Aux In	SMA female	Accepts an input signal between 1 MHz to 44 GHz from the M9314B Aux Out connector.
Aux Out	SMA female	Provides an output signal to the M9314B Aux In connector.
RF 2 In	SMA female	Inputs an IF signal between 400 MHz and 3.2 GHz from the M9343A RF 2 Out connector.
RF 1 In	SMA female	Inputs an IF signal between 3.2 GHz and 20 GHz from the M9314B RF 1 Out connector.

M9314B

Connectors	Type	Description
Trig 1	SMP male	For options PME/PMR externally provided Pulse modulation signal. 1 M Ω impedance (nominal). Damage level is 10 V peak, 5 V rms.
Trig 2	SMP male	Outputs the trigger signal to the M9312B Trig 2 connector.
Sync	SMP male	Accepts a bidirectional signal used for synchronization with other modules.
AM In	SMP male	Accepts an external amplitude modulated signal with 50%/volt or 20 dB/volt (selectable).
AM Out	SMP male	Reserved for future use. 50 Ω impedance (nominal). Damage level is 10 V peak, 5 V rms.
LO 1 In	Female (2.4 mm)	Inputs an LO signal between 22 GHz and 38 GHz from the M9312B LO 2 Out connector.
RF 1 Out	SMA female	Outputs a copy of the RF 1 In signal to the M9312B RF 1 In connector.
RF 1 In	SMA female	Inputs the IF signal between 400 MHz and 20 GHz from the M9343A RF 1 Out connector.
Aux In	SMA female	Accepts an input signal between 1 MHz and 20 GHz from the M9312B Aux Out connector.
Aux Out	Female (2.4 mm)	Provides a RF output as either the upconverted signal from RF 1 In connector or the Aux In signal to the M9312B Aux In connector.

M9323A

Connectors	Type	Description
Trig 1	SMP male	For options F32/F44 with options PME/PMR, outputs signal following envelope of RF pulse. VOL < 0.4 V, VOH is 2.8 V to 3.3 V into high impedance. 50 Ω impedance (nominal). Damage level is ± 5 V.
Trig 2	SMP male	For options F32/F44 with options PME/PMR, outputs signal (trigger) related to pulse timing. VOL < 0.4 V, VOH is 2.8 V to 3.3 V into high impedance. 50 Ω impedance (nominal). Damage level is ± 5 V.
Sync	SMP male	Accepts a bidirectional signal used for synchronization with other modules.
RF 1 Out	Female (2.4 mm)	RF Output signal, level selected by user interface. 50 Ω impedance (nominal).
RF 1 In	Female (2.4 mm)	Accepts a RF signal from the M9312B RF Out connector.

M9343A

Connectors	Type	Description
Sync	SMB male	Intended for future use.
Ext 1	SMB male	External trigger input. 10 k Ω input impedance (nominal). Damage level is ± 5 V.
Ext 2	SMB male	Outputs the trigger signal to the M9312B Trig 1 connector.
Ext Clk In	SMB male	Inputs a 100 MHz signal from the M9043A Chassis 100 MHz Out 4 connector.
Aux Port		Reserved for future use.
USB Port		Reserved for future use. Not for use with USB devices.
I+ Input	SMP male	For option EXT, externally supplied analog in-phase component of I/Q modulation to internal baseband generator. Frequency range is DC to 1000 MHz (nominal). 50 Ω impedance (nominal). Damage level is 5 V peak, 1 V rms.
I- Input	SMP male	For option EXT, externally supplied analog in-phase component of I/Q modulation to internal baseband generator, 180° out of phase from I+ In. Frequency range is DC to 1000 MHz (nominal). 50 Ω impedance (nominal). Damage level is 5 V peak, 1 V rms."
Q+ Input	SMP male	For option EXT, externally supplied analog quadrature-phase component of I/Q modulation to internal baseband generator. Frequency range is DC to 1000 MHz (nominal). 50 Ω impedance (nominal). Damage level is 5 V peak, 1 V rms.

Q- Input	SMP male	For option EXT, externally supplied analog quadrature-phase component of I/Q modulation to internal baseband generator, 180° out of phase from Q+ In. Frequency range is DC to 1000 MHz (nominal). 50 Ω impedance (nominal). Damage level is 5 V peak, 1 V rms.
I+ Output	SMP male	Analog in-phase component of I/Q modulation from internal baseband generator. Frequency range is DC to 1000 MHz (nominal). 50 Ω impedance (nominal). Damage level is ±2 V.
I- Output	SMP male	Analog in-phase component of I/Q modulation from internal baseband generator, 180° out of phase from +I Out. Frequency range is DC to 1000 MHz (nominal). 50 Ω impedance (nominal). Damage level is ±2 V.
Q+ Output	SMP male	Analog quadrature-phase component of I/Q modulation from internal baseband generator. Frequency range is DC to 1000 MHz (nominal). 50 Ω impedance (nominal). Damage level is ±2 V.
Q- Output	SMP male	Analog quadrature-phase component of I/Q modulation from internal baseband generator, 180° out of phase from +Q Out. Frequency range is DC to 1000 MHz (nominal). 50 Ω impedance (nominal). Damage level is ±2 V.
Trig 1	SMP male	Output of TTL High as assigned to Signal's Marker Setup. VOL < 0.4 V, VOH is 2.8 V to 3.3 V into high impedance. 50 Ω impedance (nominal). Damage level is ±5 V.
Trig 2	SMP male	For options F32/F44, reserved for future use. For options F14/F20 with options PME/PMR Pulse Sync Out outputs signal (trigger) related to pulse timing. VOL < 0.4 V, VOH is 2.8 V to 3.3 V into high impedance. 50 Ω impedance (nominal). Damage level is ±5 V."
Sync	SMP male	Used for option PCH, phase coherency.
LO 2 In	SMA female	Accepts a LO signal between 400 MHz and 3.2 GHz for use by the 400 MHz to 3.2 GHz modulator.
LO 2 Out	APC female (3.5 mm)	Outputs a copy of the LO 1 In signal to the M9343A LO 2 In connector.
RF 2 Out	SMA female	Outputs a modulated RF signal from the 0.4 to 3.2 GHz modulator. This signal is routed to the M9312B RF 2 In connector.
LO 1 In	APC female (3.5 mm)	Accepts a LO signal between 0.4 and 20 GHz that can be used by the 3.2 to 20 GHz modulator. The range from 0.4 to 3.2 GHz is only usable by the LO 2 Out connector.
RF 1 Out	APC female (3.5 mm)	Outputs a modulated RF signal from the 3.2 to 20 GHz modulator to the M9314B RF 1 In connector. Output can be switched on or off.

M9347A

Connectors	Type	Description
Synth 2 Out	SMA female	For Dual Channel configuration, this connector outputs a synthesized signal to the M9312B LO 1 In connector.
Clock In	SMA female	Accepts a 4.8 GHz or 19.2 GHz signal from the M9043A Chassis 19.2 GHz Out 2 connector.
Ref Out	SMA female	Outputs a 100 MHz, 4.8 GHz or 19.2 GHz clock signal.
Ref In	SMP male	Accepts a 100 MHz signal from the M9312B 100 MHz Out connector.
Synth 1 Out	SMA female	Outputs a synthesized signal to the M9312B LO 1 In connector.
Mark 1	SMP male	Output signal to determine when the signal level is settled: logic High while settled and low (approximately 0v) when change is in progress. CMOS +3.3V Logic. Damage level is <-.5V and >6.5V.
Mark 2	SMP male	For instruments with option 002, channel 2's output signal to determine when the signal level is settled: logic High while settled and low (approximately 0v) when change is in progress. CMOS +3.3V Logic. Damage level is <-.5V and >6.5V.
Ctrl M	uHDMI female	Reserved for future use. Damage level is <-.5V and >6.5V.
Ctrl S	uHDMI female	Reserved for future use. Damage level is <-.5V and >6.5V.

M9043A

Connectors	Type	Description
HF Out 1	SMA (f)	Output of 19.2 GHz CW frequency reference, switched from user interface; off by default. High impedance when off, 50 Ω when on, level is 7.3 dBm (nominal).
Trig 1	SMB (m)	For options F32/F44, reserved for future use. For options F14/F20 with options PME/PMR Pulse Video Out outputs signal following envelope of RF pulse.
Trig 2	SMB (m)	For options F32/F44, reserved for future use. For options F14/F20 with options PME/PMR and option 002, channel 2's Pulse Video Out outputs signal following envelope of RF pulse.
Ref In	SMB (m)	Externally supplied 10 MHz CW frequency reference, switched by the user interface; off by default. NOTE: when using an external frequency reference this connector is preferred over the M9043A Rear Panel 10 MHz IN. Input level -3dBm to +20 dBm (nominal), 50 Ω impedance. ESD damage level is 30 V.
EFC/Cal In	SMB (m)	Reserved for future use. ESD damage level is 30 V.

OCXO/Cal Out	SMB (m)	Output of 10 MHz CW frequency reference, this port is always on. NOTE: when using the frequency reference to provide frequency lock with another instrument this connector is preferred over the M9043A Rear Panel 10 MHz OUT.+15 dBm (nominal). 50 Ω impedance (nominal). ESD damage level is 30 V.
100 MHz Out 1	SMB (m)	Output of 100 MHz CW frequency reference, cabled from the factory to M9343A Ext Clk In. This port is always-on level is +15 dBm (nominal). If alternate M9343A Ext Clk In is provided this port should be terminated with 50 Ω load.
100 MHz Out 5	SMB (m)	Output of 100 MHz CW frequency reference, switched from the user interface; off by default. High impedance when off, 50 Ω when on, level is +15 dBm (nominal).
Temp	LED indicator	Green = functioning properly. Red = fault condition.
Fan	LED indicator	Green = functioning properly. Red = fault condition.
Power	Power Switch	Turns the instrument on and off.

Setup and Calibration Services

Assistance	
One day startup assistance	Gain access to a technical expert who will help you get started quickly with the VXG Microwave Signal Generator and its powerful software tools. The flexible instruction format is designed to get you to your first measurements and familiarize you with ways to adapt the equipment to a specific application. Included in base configuration.
Calibration and traceability	
Calibration cycle	A one-year calibration cycle is recommended.

Support and Warranty

Warranty	
Global warranty	Keysight's warranty service provides standard coverage for the country where product is used. <ul style="list-style-type: none">– All parts and labor necessary to return to full specified performance– Recalibration for products supplied originally with a calibration certificate– Return shipment
Support	
Self-test utility	A self-test utility runs a set of internal tests which verifies the health of the modules and reports their status.

Learn more at: www.keysight.com

For more information on Keysight Technologies' products, applications or services, please contact your local Keysight office. The complete list is available at: www.keysight.com/find/contactus

