

# Keysight E5053A Microwave Downconverter

# Notices

© Keysight Technologies  
2005-2019

No part of this manual may be reproduced in any form or by any means (including electronic storage and retrieval or translation into a foreign language) without prior agreement and written consent from Keysight Technologies, Inc. as governed by United States and international copyright laws.

## Trademark Acknowledgments

## Manual Part Number

E5053-90020

## Edition

Edition 4, April 2019

Printed in Malaysia

Published by:

**Keysight Technologies International  
Japan G.K.**  
1-3-3 Higashikawasaki-cho  
Chuo-ku  
Kobe-shi, Hyogo, Japan

## Warranty

THE MATERIAL CONTAINED IN THIS DOCUMENT IS PROVIDED "AS IS," AND IS SUBJECT TO BEING CHANGED, WITHOUT NOTICE, IN FUTURE EDITIONS. FURTHER, TO THE MAXIMUM EXTENT PERMITTED BY APPLICABLE LAW, KEYSIGHT DISCLAIMS ALL WARRANTIES, EITHER EXPRESS OR IMPLIED WITH REGARD TO THIS MANUAL AND ANY INFORMATION CONTAINED HEREIN, INCLUDING BUT NOT LIMITED TO THE IMPLIED WARRANTIES OF MERCHANTABILITY AND FITNESS FOR A PARTICULAR PURPOSE. KEYSIGHT SHALL NOT BE LIABLE FOR ERRORS OR FOR INCIDENTAL OR CONSEQUENTIAL DAMAGES IN CONNECTION WITH THE FURNISHING, USE, OR PERFORMANCE OF THIS DOCUMENT OR ANY INFORMATION CONTAINED HEREIN. SHOULD KEYSIGHT AND THE USER HAVE A SEPARATE WRITTEN AGREEMENT WITH WARRANTY TERMS

COVERING THE MATERIAL IN THIS DOCUMENT THAT CONFLICT WITH THESE TERMS, THE WARRANTY TERMS IN THE SEPARATE AGREEMENT WILL CONTROL.

## Technology Licenses

The hardware and/or software described in this document are furnished under a license and may be used or copied only in accordance with the terms of such license.

## Declaration of Conformity

Declarations of Conformity for this product and for other Keysight products may be downloaded from the Web. Go to <http://www.keysight.com/go/conformity>. You can then search by product number to find the latest Declaration of Conformity.

## U.S. Government Rights

The Software is "commercial computer software," as defined by Federal Acquisition Regulation ("FAR") 2.101. Pursuant to FAR 2.212 and 27.405-3 and Department of Defense FAR Supplement ("DFARS") 227.7202, the U.S. government acquires commercial computer software under the same terms by which the software is customarily provided to the public. Accordingly, Keysight provides the Software to U.S. government customers under its standard commercial license, which is embodied in its End User License Agreement (EULA), a copy of which can be found at

<http://www.keysight.com/find/sweula>The license set forth in the EULA represents the exclusive authority by which the U.S. government may use, modify, distribute, or disclose the Software. The EULA and the license set forth therein, does not require or permit, among other things, that Keysight: (1) Furnish technical information related to commercial computer software or commercial computer software documentation that is not customarily provided to the public; or (2) Relinquish to, or otherwise provide, the government rights in excess of these rights customarily provided to the public to use, modify, reproduce, release,

perform, display, or disclose commercial computer software or commercial computer software documentation. No additional government requirements beyond those set forth in the EULA shall apply, except to the extent that those terms, rights, or licenses are explicitly required from all providers of commercial computer software pursuant to the FAR and the DFARS and are set forth specifically in writing elsewhere in the EULA. Keysight shall be under no obligation to update, revise or otherwise modify the Software. With respect to any technical data as defined by FAR 2.101, pursuant to FAR 12.211 and 27.404.2 and DFARS 227.7102, the U.S. government acquires no greater than Limited Rights as defined in FAR 27.401 or DFARS 227.7103-5 (c), as applicable in any technical data.

## Safety Notices

### CAUTION

A **CAUTION** notice denotes a hazard. It calls attention to an operating procedure, practice, or the like that, if not correctly performed or adhered to, could result in damage to the product or loss of important data. Do not proceed beyond a CAUTION notice until the indicated conditions are fully understood and met.

### WARNING

A **WARNING** notice denotes a hazard. It calls attention to an operating procedure, practice, or the like that, if not correctly performed or adhered to, could result in personal injury or death. Do not proceed beyond a WARNING notice until the indicated conditions are fully understood and met.

## Caution



Do not exceed the operating input power, voltage, and current level and signal type appropriate for the instrument being used, refer to your instrument's Function Reference.



Electrostatic discharge (ESD) can damage the highly sensitive microcircuits in your instrument. ESD damage is most likely to occur as the test fixtures are being connected or disconnected. Protect them from ESD damage by wearing a grounding strap that provides a high resistance path to ground. Alternatively, ground yourself to discharge any static charge built-up by touching the outer shell of any grounded instrument chassis before touching the test port connectors.

## Safety Summary

The following general safety precautions must be observed during all phases of operation, service, and repair of this instrument. Failure to comply with these precautions or with specific WARNINGS elsewhere in this manual may impair the protection provided by the equipment. Such noncompliance would also violate safety standards of design, manufacture, and intended use of the instrument. Keysight Technologies assumes no liability for the customer's failure to comply with these precautions.

### NOTE

The E5053A complies with INSTALLATION CATEGORY II as well as POLLUTION DEGREE 2 in IEC61010-1. The E5053A is an INDOOR USE product.

---

### NOTE

The LEDs in the E5053A are Class 1 in accordance with IEC60825-1, CLASS 1 LED PRODUCT

---

### NOTE

This equipment is MEASUREMENT CATEGORY I (CAT I). Do not use for CAT II, III, or IV.

---

**NOTE**

This equipment is tested with stand-alone condition or with the combination with the accessories supplied by Keysight Technologies against the requirement of the standards described in the Declaration of Conformity. If it is used as a system component, compliance of related regulations and safety requirements are to be confirmed by the builder of the system.

---

- Ground the Instrument  
To avoid electric shock, the instrument chassis and cabinet must be grounded with the supplied power cable's grounding prong.
- Do NOT Operate in an Explosive Atmosphere  
Do not operate the instrument in the presence of inflammable gases or fumes. Operation of any electrical instrument in such an environment clearly constitutes a safety hazard.
- Keep Away from Live Circuits  
Operators must not remove instrument covers. Component replacement and internal adjustments must be made by qualified maintenance personnel. Do not replace components with the power cable connected. Under certain conditions, dangerous voltage levels may remain even after the power cable has been disconnected. To avoid injuries, always disconnect the power and discharge circuits before touching them.
- DO NOT Service or Adjust the Instrument Alone  
Do not attempt internal service or adjustment unless another person, capable of rendering first aid and resuscitation, is present.
- Do NOT Substitute Parts or Modify the Instrument  
To avoid the danger of introducing additional hazards, do not install substitute parts or perform unauthorized modifications to the instrument. Return the instrument to a Keysight Technologies Sales and Service Office for service and repair to ensure that safety features are maintained in operational condition.
- Dangerous Procedure Warnings  
Warnings, such as the example below, precede potentially dangerous procedures throughout this manual. Instructions contained in the warnings must be followed.







**WARNING**

**Dangerous voltage levels, capable of causing death, are present in this instrument. Use extreme caution when handling, testing, and adjusting this instrument.**

---

## Safety Symbols

General definitions of safety symbols used on the instrument or in manuals are listed below.

	Instruction Manual symbol: the product is marked with this symbol when it is necessary for the user to refer to the instrument manual.
	Alternating current.
	Direct current.
	On (Supply).
	Off (Supply).
	A chassis terminal; a connection to the instrument's chassis, which includes all exposed metal structure.
	Standby.

## Certification

Keysight Technologies certifies that this product met its published specifications at the time of shipment from the factory. Keysight Technologies further certifies that its calibration measurements are traceable to the United States National Institute of Standards and Technology, to the extent allowed by the Institution's calibration facility or by the calibration facilities of other International Standards Organization members.

## Exclusive Remedies

The remedies provided herein are Buyer's sole and exclusive remedies. Keysight Technologies shall not be liable for any direct, indirect, special, incidental, or consequential damages, whether based on contract, tort, or any other legal theory.

## Assistance

**Product maintenance agreements and other customer** assistance agreements are available for Keysight Technologies products.

Caution  
Safety Symbols

For any assistance, contact your nearest Keysight Technologies Sales and Service Office. Addresses are **provided at the back of this manual.**

## Table of Contents

Caution . . . . .	3
Safety Summary . . . . .	3
Safety Symbols . . . . .	5
Certification . . . . .	5
Exclusive Remedies . . . . .	5
Assistance. . . . .	5
<b>1. Installation</b>	
Incoming inspection . . . . .	9
Requirements for installation environment . . . . .	12
Operating environment . . . . .	12
Heat dissipation clearance. . . . .	13
Antistatic measures . . . . .	14
Providing space to disconnect the power cable's plug . . . . .	14
Mounting front handles/flanges for rackmount. . . . .	15
Mounting handle kit (Option 1CN). . . . .	16
Mounting rackmount kit (Option 1CM) . . . . .	17
Mounting rackmount/handle kit (Option 1CP) . . . . .	17
Power supply and fuse . . . . .	18
Checking the power supply . . . . .	18
Setting up the fuse. . . . .	18
Checking and connecting the power cable. . . . .	19
Starting up E5053A . . . . .	20
Turning ON/OFF the power . . . . .	20
Cutting power supply . . . . .	20
<b>2. Overview of Product</b>	
About This Product. . . . .	21
Names and Functions of Parts . . . . .	22
Front Panel . . . . .	22
Rear Panel . . . . .	24
<b>3. Connecting Devices to E5052B for Operation</b>	
Connecting E5052B and E5053A. . . . .	28
Required Devices . . . . .	28
Connection on Front Panel. . . . .	28
Connection on Rear Panel . . . . .	29
Turning on Power . . . . .	30
Basic Operation . . . . .	30

## Contents

### 4. Information on Maintenance

Cleaning this Instrument . . . . .	31
Maintenance of Interconnection Ports and Test Ports . . . . .	31
Cleaning a Display Other than Interconnection Ports and Test Ports . . . . .	31
Cautions Applicable to Requesting Repair, Replacement, Regular Calibration, etc. . . . .	32
Devices to be Sent Back for Repair or Regular Calibration . . . . .	32
Recommended Calibration Period . . . . .	32

### A. Manual Changes

Manual Changes . . . . .	33
--------------------------	----



# 1 Installation

This chapter provides information on how to set up the Keysight E5053A microwave downconverter.

## Incoming inspection

When you receive the product, follow the steps below to perform the incoming inspection.

### WARNING

If there are signs of shipping damage to any portion of the outer enclosure when opening the package (for example, the cover, front/rear panel, power switch, and port connectors), do not turn on the power. You may get an electrical shock.

---

**Step 1.** Check the shipping container and cushioning material for damage.

### NOTE

If the shipping container or cushioning material is damaged, it should be kept until all the other inspections have been done.

---

**Step 2.** Check the contents of the package for mechanical damage or defects.

**Step 3.** Check the contents of the shipment using [Table 1-1](#) and [Figure 1-1](#) to see if all your specified options are complete.

**Step 4.** If you detect any of the following in the inspection, contact your nearest Keysight Technologies sales office.

1. If the shipping container or cushioning material is damaged or the cushioning material shows signs of unusual stress.
2. If you find any mechanical damage or defect to the contents.
3. If the contents of the shipment are not complete.
4. If you find any fault with the product during operational checks described below.

In the case of 1, notify the carrier as well as your nearest Keysight Technologies sales office. Keep the shipping container, cushioning material, and the contents of the shipment for the carrier's inspection.

Table 1-1

Contents of the E5053A package

Name	Keysight product/part number	Qty
Standard contents		
o E5053A	E5053A	1
o Power cable <sup>1</sup>	8120-4753	1
o USB cable	8121-0770	1
o RF SMA cable	E5053-61621	2
o RF SMA cable	E5053-61622	2
o BNC(m)-BNC(m) cable, 61 cm	8120-1839	1
o 3.5(f)-3.5(f) adapter <sup>2</sup>	5061-5311	1
o BNC adapter	1250-1859	1
Option		
o Manual (Option ABA) <sup>3</sup>		
• User's Guide	E5053-900x0	1
o Handle kit (Option 1CN) <sup>4</sup>	5063-9227	1
o Rackmount kit (Option 1CM) <sup>5</sup>	5063-9214	1
	E5053-61623	2
	E5053-61624	2
o Rackmount/handle kit (Option 1CP) <sup>5</sup>	5063-9221	1
	E5053-61623	2
	E5053-61624	2

1. This accessory varies from country to country. For the power cable option, see <http://www.keysight.com/find/powercords>.
2. The contents of these accessories are not shown in **Figure 1-1**.
3. The number of "x" in the part number of the manual, 0 for the first edition, is incremented by 1 each time a revision is made. The latest edition comes with the product. The PDF version of user manual is available at <http://www.keysight.com/manuals/e5053a>.
4. The contents of these accessories are not shown in **Figure 1-1**. For more information on them, refer to Antistatic Measurement table.

Figure 1-1

Accessories

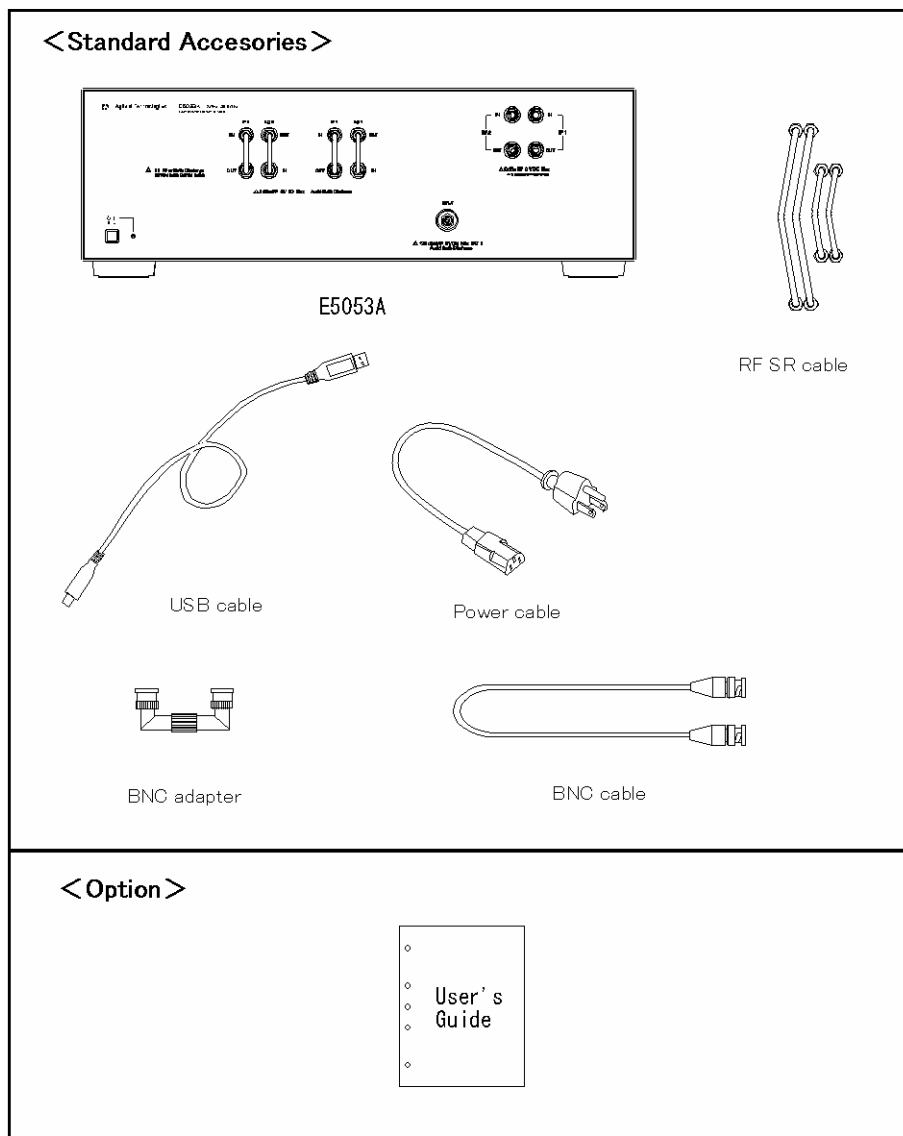

e5053aue1001

## Requirements for installation environment

Install the E5053A under an environment that satisfies the following conditions.

### Operating environment

Use the E5053A under the following environmental conditions.

Temperature	10 °C to 40 °C
Temperature range for error-correction	23 °C ± 5 °C (< 1 °C deviation from the temperature when performing the error-correction)
Humidity	20 % to 80 % at wet bulb temperature < +28 °C (non-condensation)
Altitude	0 m to 2,000 m (0 to 6,561 feet)
Vibration	0.21 G maximum, 5 Hz to 500 Hz

#### CAUTION

The above environmental requirements are not intended for the specifications and measurement accuracy of the analyzer but for the operating environment of the analyzer.

---

### Heat dissipation clearance

To satisfy the safety, specifications, and measurement accuracy of the product, you need to keep the temperature around the product within a specific range by providing proper heat dissipation clearance around the product or by forcefully air-cooling the inside of the rack. For information on ambient temperature to satisfy the specifications and measurement accuracy of the product, refer to the “Specifications and supplemental performance characteristics” Chapter in *the User’s Guide*.

When the temperature around the product is kept within the specified temperature range, the product will comply with the safety standards. Furthermore, the product will also comply with the safety standards when the product is installed with clearance for heat dissipation according to **Figure 1-2** below.

Condition	
Rear	$\geq 180$ mm
Sides	$\geq 60$ mm (both right and left)

Figure 1-2 Providing heat dissipation clearance

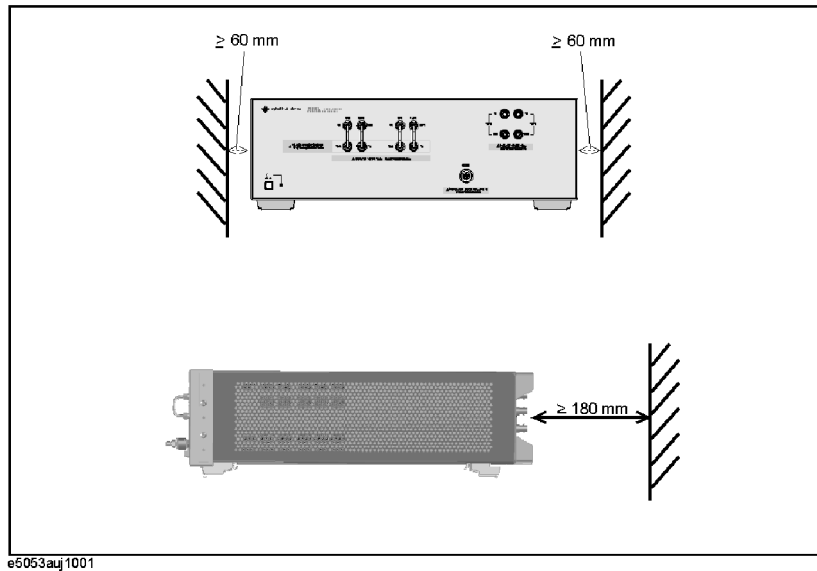

### Antistatic measures

To protect electronic components from static damage, take antistatic measures as shown in **Figure 1-3**. Table below shows antistatic accessories that Keysight Technologies provides.

Name	Keysight part number
Antistatic table mat	9300-0797
Wrist strap code	9300-0980
Wrist strap	9300-1383
Heel strap	9300-1169

Figure 1-3 Example of antistatic measures

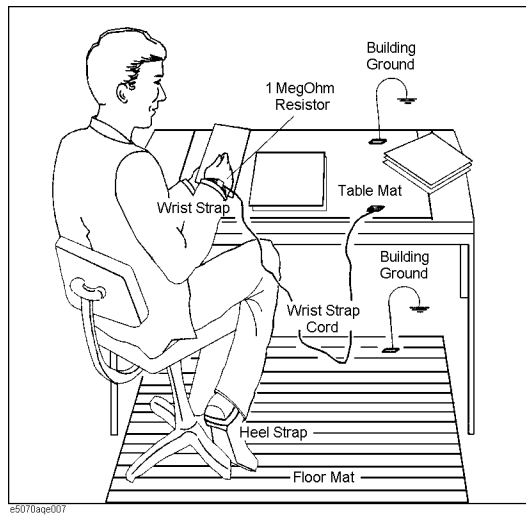

### Providing space to disconnect the power cable's plug

As described in **“Cutting power supply” on page 20**, the disconnecting device (the device to cut the supply of power) of the E5053A is the plug of the power cable. When installing the E5053A, provide sufficient clearance not to hinder the operation of disconnecting the plug of the power cable (on the power outlet side or the E5053A side) in an emergency to cut the supply of power.

Installation  
 Mounting front handles/flanges for rackmount

Mounting front handles/flanges for rackmount

You can use the E5053A on a workbench or mounted in a rack. This section describes how to mount the front handles used to move/transport it (Option 1CN) and how to mount it into a rack as part of a measurement system (Option 1CM: without handles/Option 1CP: with handles).

Option	Name	Keysight part number
1CN	Handle kit	5063-9227
1CM	Rackmount kit	5063-9214
1CP	Rackmount/handle kit	5063-9221

Option	Contents	Quantity
1CN	Front handle	2
	Screw	6
	Trim strip	2
1CM	Flange for rackmount (side plate for securing)	2
	Screw	6
1CP	Flange for rackmount (side plate for securing)	2
	Front handle	2
	Screw	6

Figure 1-4 Mounting the handle/rackmount kit

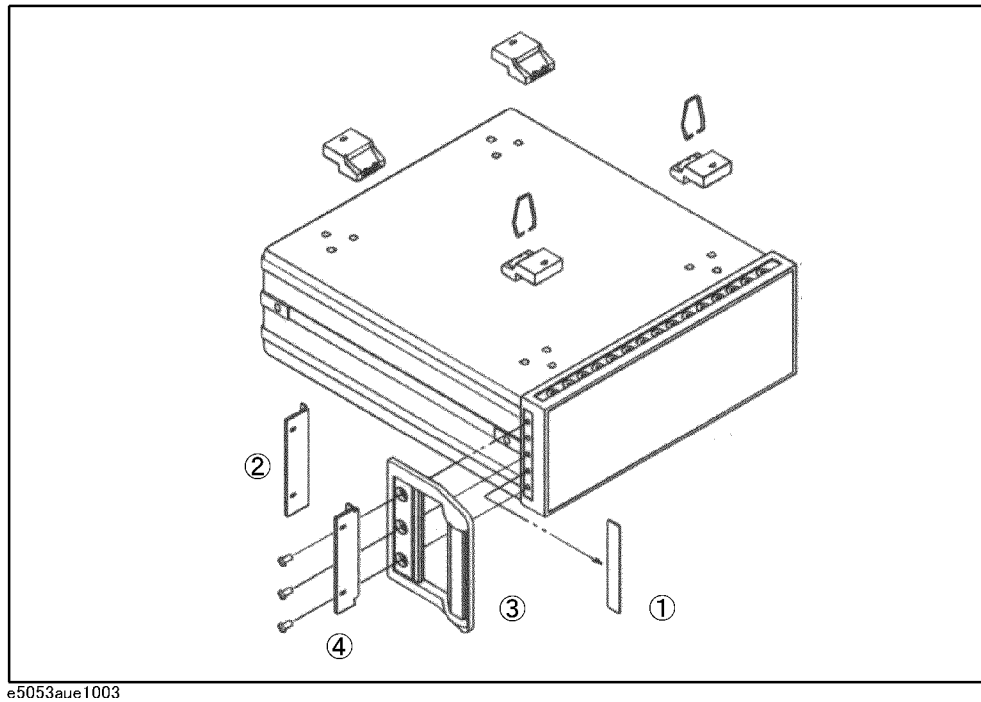

#### Mounting handle kit (Option 1CN)

The handle kit is a kit that contains a pair of front handles used to move/transport the E5053A. Follow these steps to mount it, referring to the [Figure 1-4](#).

- Step 1.** Remove the trim strips (1) stuck to both the sides of the front panel (stuck to the frame).
- Step 2.** Mount the front handles (3) to both the sides of the front panel of the E5053A with the attached screws.

#### **WARNING**

If a front handle you mounted is damaged, replace it with new one immediately. If you use a damaged front handle to move/transport the instrument, the handle may break, which may injure the operator or break the instrument.



### Mounting rackmount kit (Option 1CM)

The rackmount kit is a kit that contains 2 flanges (side plates for securing) to mount the E5053A into the standard rack (width: 482.6 mm) of the EIA standard. Follow these steps to mount it, referring to the [Figure 1-4](#).

- Step 1.** Remove the trim strips (1) stuck to both the sides of the front panel (stuck to the frame).
- Step 2.** Mount the flanges for rackmount (2) to both the sides of the front panel of the E5053A with the attached screws.
- Step 3.** Remove the four legs on the bottom of the E5053A (pull up the part with the **TAB** indication and slide it to the arrow direction).
- Step 4.** Mount the E5053A into the rack.

### Mounting rackmount/handle kit (Option 1CP)

The rackmount/handle kit is a kit that contains both the flanges for rackmount and the front handles for the E5053A. Follow these steps to mount it, referring to the [Figure 1-4](#).

- Step 1.** Remove the trim strips (1) stuck to both the sides of the front panel (stuck to the frame).
- Step 2.** Mount the front handles (3) and the flanges for rackmount (4) to both the sides of the front panel of the E5053A with the attached screws.

#### **WARNING**

Be sure to use both the front handles and the rack-mounting flanges at the same time. Do not attempt to install flanges or handles separately with the hardware provided, since this risks serious electrical damage to the instrument.

---

- Step 3.** Remove the 4 legs on the bottom of the E5053A (pull up the part with the **TAB** indication and slide it to the arrow direction).
- Step 4.** Mount the E5053A into the rack.

## Power supply and fuse

Before turning ON the E5053A, check the following.

### Checking the power supply

Check that the power supplied to the E5053A satisfies the following conditions.

Condition	
Voltage	90 to 132 Vac or 198 to 264 Vac <sup>1</sup>
Frequency	47 to 63 Hz
Power consumption	Max. 250 VA

1. The E5053A automatically switches between them depending on the voltage.

### Setting up the fuse

Use the fuse that meets the following specifications.

*UL/CSA type, Slo-Blo, 5x20 mm miniature fuse, 3A 250V (Keysight part number: 2110-1017)*

Spare fuses are available from Keysight Technologies sales offices. To check or replace the fuse, disconnect the power cable and pull out the fuse holder.

Figure 1-5

Fuse holder and power cable inlet

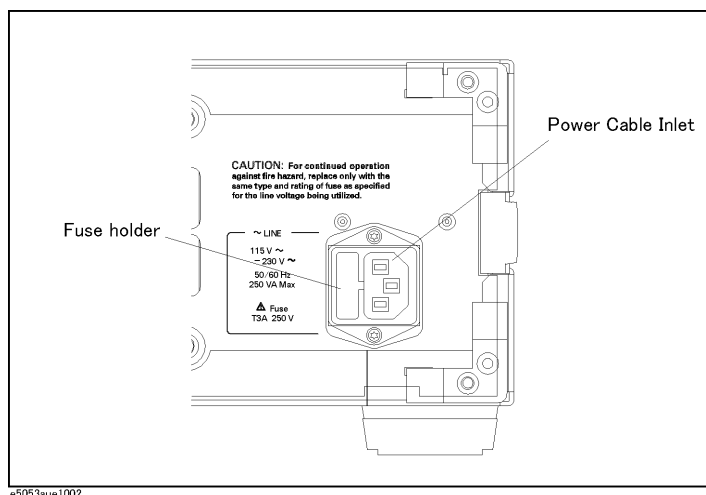

## Checking and connecting the power cable

The power cable that comes with the E5053A has a three-wire structure and one of them is the grounding wire. This power cable grounds the E5053A through an outlet, protecting the operator from shock hazards.

### Step 1. Check the power cable you use for damage.

#### **WARNING**

Never use a power cable that may be damaged. You may get an electrical shock.

---

### Step 2. Connect the attached power cable between the power cable receptacle on the rear panel of the E5053A (see [Figure 1-5 on page 18](#)) and a three-pole outlet whose grounding terminal is grounded securely.

#### **WARNING**

Securely ground the E5053A with the attached 3-wire power cable with the grounding wire.

---





For power cable options, refer to <http://www.keysight.com/find/powercords>.

## Starting up E5053A

This section describes how to turn ON/OFF the E5053A and how to cut the power supply in an emergency.



### Turning ON/OFF the power

#### Turning ON the power

- Step 1.** Check that the line switch in the lower left part of the front panel is pulled up (  ). If it is pushed in (  ), which means the power is OFF, push the standby switch to pull it up (  ).
- Step 2.** Push the line switch to push it in (  ).

#### Turning OFF the power

To turn OFF the E5053A, do the following.

- Push the line switch in the lower left part of the front panel so that the switch pushed in (  ) is pulled up (  ).

#### NOTE

To turn OFF the E5053A under normal conditions, press the line switch. Under normal conditions, never disconnect the power cable to cut the power supply to the power cable receptacle on the rear panel.

---

### Cutting power supply

For the E5053A, the disconnecting device (the device to cut the power supply) is the power cable's plug (on the power outlet side or the E5053A side). If you need to cut the power supply to avoid danger of electric shocks, disconnect the power cable's plug (on the power outlet side or the E5053A side).

#### NOTE

Follow the description in **“Providing space to disconnect the power cable's plug” on page 14** so that you can perform this operation reliably.

To turn OFF the power under normal conditions, be sure to follow the procedure in **“Turning OFF the power”**.

---

## 2 Overview of Product

This chapter presents an overview of the E5053A microwave downconverter.

### About This Product

The Keysight E5053A is a microwave downconverter associated with the E5052B (signal source analyzer). The E5053A expands the maximum frequency of the E5052B to 26.5 GHz.

## Names and Functions of Parts

This section describes the names and functions of the parts on the front panel of the E5053A.

### Front Panel

The names and functions of these parts are described below.

Figure 2-1 Front Panel

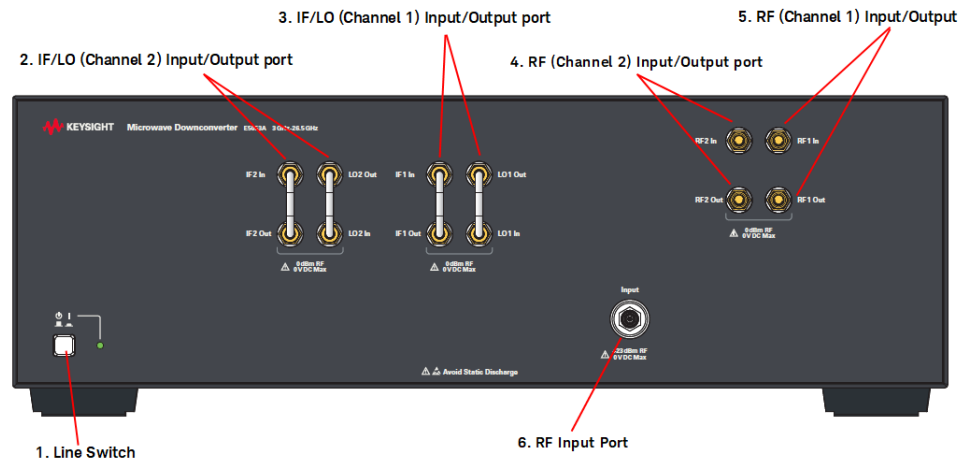

#### 1. Line switch

Turns on (I)/off (O) the E5053A.

#### 2. IF/LO (channel 2) input/output port

When using an external mixer, disconnect this port.

#### 3. IF/LO (channel 1) input/output port

When using an external mixer, disconnect this port.

#### 4. RF (channel 2) input/output port

Connect to the E5052B (signal source analyzer) with the RF cable.

#### 5. RF (channel 1) input/output port

Connect to the E5052B (signal source analyzer) with the RF cable.

### CAUTION

Do not apply a DC current or DC voltage to ports 2 - 5 to avoid device failures. Do not connect the measurement sample (DUT) to the port.

The individual ports comply with Installation Category I of IEC60101-1.

## 6. RF input port

Input the RF output signal (signal to be measured) from the DUT. A 3.5-mm (female) connector is used.

### CAUTION

Do not apply a DC voltage greater than 0 V to the connection port. In particular, there is the risk of the capacitor remaining charged. Connect the measurement sample (DUT) after the analyzer has been completely discharged.

---

### CAUTION

Take antistatic measurements when operating the product.

Because the E5053A includes semiconductor internal parts that may be damaged by static electricity through the input ports, take appropriate antistatic measures when operating it.

---

The port complies with Installation Category I of IEC61010-1.

## Rear Panel

The names and functions of the parts on the rear panel of the E5053A are described below.

Figure 2-2

## Rear Panel

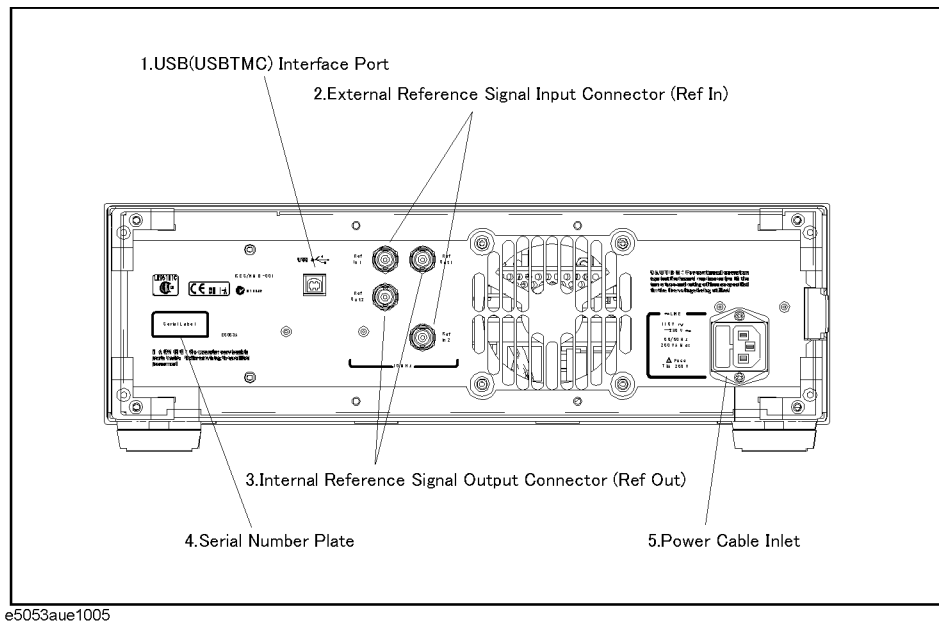

### 1. USB (USBTMC) interface port

Connect to the USB port on the rear panel of the E5052B signal source analyzer with the USB cable.

Connector type: Universal serial bus jack, B type (four contacts); female

#### NOTE

Connection on of devices other than the E5052B signal source analyzer to the USB port is not supported.

### 2. External reference signal input connector channel 1/channel 2 (Ref In)

A reference signal input connector in order to phase-lock the E5053A measurement signal with an external frequency reference signal. Supplying a reference signal to this connector improves the accuracy and stability of the E5053A's measurement signal frequency.

Channel 1: Connect to the 10 MHz Ref Out connector of the E5052B with a BNC cable.

Channel 2: Connect to the Channel 1 Ref Out of the E5053A with a BNC cable.



Connector type: BNC connector, female

Input signal (typical): 10 MHz $\pm$ 10 Hz, 0 dBm $\pm$ 5 dB

### 3. Internal reference signal output connector channel 1/channel 2 (Ref Out)

Channel 1: Connect to the Channel 2 Ref In of the E5053A with a BNC adapter.

Channel 2: A connector for outputting the internal frequency reference signal from the E5053A. By connecting this output connector to the external reference signal input connector of another device, the device can be phase-locked to the internal reference signal of the E5053A and used under this condition.

Connector type: BNC connector, female  
Output signal (typical): 10 MHz  $\pm$  50 Hz, 2.5 dBm  $\pm$  3 dB  
Output impedance (nominal): 50  $\Omega$

### 4. Serial number plate

The seal showing the serial number of the E5053A.

### 5. Power cable receptacle

The receptacle to which the power cable is connected.

#### NOTE

To feed power, use the included three-prong power cable with a ground conductor.

The plug attached to the power cable (on the power outlet side or device side of the cable) serves as the disconnecting device (device that cuts off power supply) of the E5053A. When the power supply must be cut off to avoid danger such as electric shock, pull out the power cable plug (on the power outlet side or device side of the cable). The procedure for turning off the mains in normal use is given in **“1. Line switch” on page 22.**

---

Overview of Product  
Names and Functions of Parts

### 3 Connecting Devices to E5052B for Operation

This chapter describes how to connect the E5052B signal source analyzer and the E5053A microwave downconverter for operation.



Connecting Devices to E5052B for Operation  
Connecting E5052B and E5053A

Connection on Rear Panel

As shown in **Figure 3-2**, connect the E5052B and the rear panel of the E5053A with the USB cable, BNC cable and BNC adapter.

Figure 3-2 Connecting E5052B and E5053A (Rear Panel)

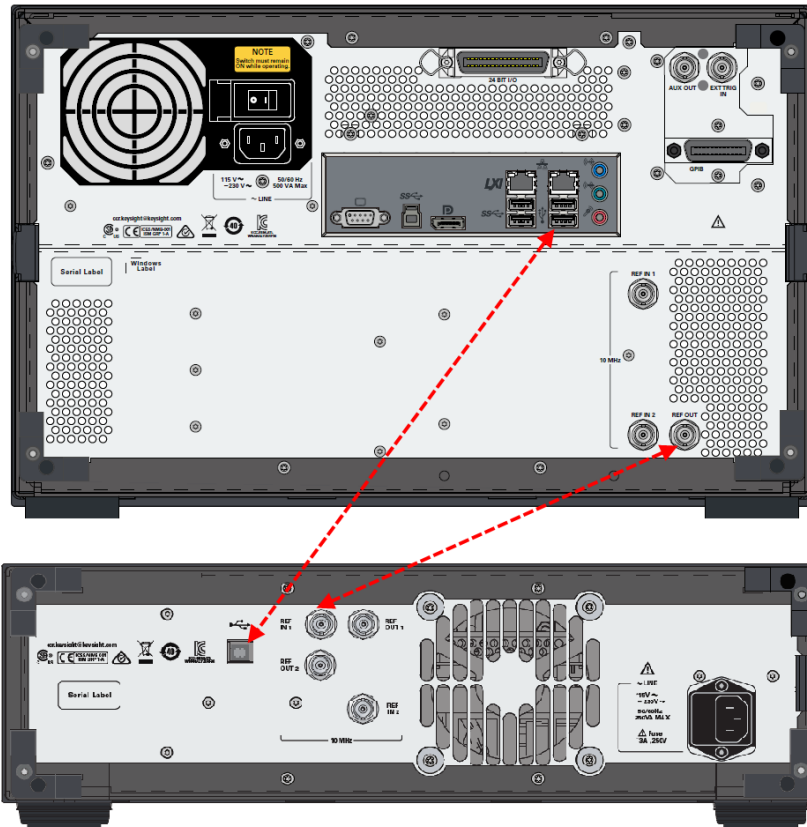

**NOTE**

Do not connect/disconnect the USB cable of the devices (printer and E5053A) connected to the USB host port (both front and rear) or turn them on/off during measurement.

### Turning on Power

After connecting the E5052B and the E5053A, follow these steps to turn on the power.

**Step 1.** Turn on the E5053A.

**Step 2.** Turn on the E5052B.

#### NOTE

If the E5052B is turned on first, the E5053A cannot be recognized, and the downconverter setting of the E5052B is disabled. Note that, if the auto recall function with the function of the E5053A enabled is executed under this condition, recall is performed normally, but the “No Downconverter Unit Connected” error message appears. They become available by enabling the downconverter setting manually.

---

### Basic Operation

For information on operation, see the "Measurement Using the E5053A and a External Mixer" chapter in the "E5052B Signal Source Analyzer User's Guide."

## 4 Information on Maintenance

This chapter explains the measures you should take to maintain the Keysight E5053A.

### Cleaning this Instrument

This section describes how to clean the instrument.

#### **WARNING**

**To protect yourself from electrical shock, be sure to unplug the power cable from the outlet before cleaning the instrument.**

**Never clean the internal components of the instrument.**

---

#### Maintenance of Interconnection Ports and Test Ports

Stains or other damage to these connectors would significantly affect the accuracy in measurements in the RF range. Always pay attention to the following precautions.

- Always keep the connectors free from stains and dust.
- Do not touch the contact surface on the connectors.
- Do not plug damaged or scratched connectors into the test ports.
- Use compressed air for cleaning connectors. Do not use abrasives under any circumstance.

#### Cleaning a Display Other than Interconnection Ports and Test Ports

To remove stains on parts other than Interconnection ports and test ports of the instrument, wipe them gently with a soft cloth that is dry or wetted with a small amount of water and wrung tightly.

## Cautions Applicable to Requesting Repair, Replacement, Regular Calibration, etc.

### Devices to be Sent Back for Repair or Regular Calibration

If it is necessary to send the unit to the Service Center of Keysight Technologies for repair or regular calibration, please follow the instructions below.

#### **Equipment to be Sent**

When requesting repair or regular calibration of the unit by our Service Center, send only the E5053A main unit without any installed option you may have ordered. Unless specifically instructed, it is not necessary to send accessories and calibration kits.

#### **Packing**

Use the original package and shock absorbers, or equivalent antistatic packing materials, when sending the unit.

#### **Shipping Address**

For the location of the nearest Keysight Technologies Service Center, contact the Customer Contact listed at the end of this brochure.

### Recommended Calibration Period

The recommended calibration period for this instrument is one year. The user is recommended to request the Company's Service Center to perform regular calibration every year.



## A Manual Changes

This appendix contains the information required to adapt this manual to versions or configurations of the E5053A manufactured earlier than the current printing date of this manual.

### Manual Changes

To adapt this manual to your E5053A, refer to [Table A-1](#).

**Table A-1**      **Manual Changes by Serial Number**

Serial Prefix or Number	Make Manual Changes
-------------------------	---------------------

Keysight Technologies uses a two-part, ten-character serial number that is stamped on the serial number plate. The first five characters are the serial prefix and the last five digits are the suffix.

Manual Changes  
Manual Changes

## Index

## A

about this product [21](#)  
accessories [11](#)  
assistance [5](#)

## C

Cleaning [31](#)  
Connectors  
Maintenance [31](#)

## E

E5053A  
connection [28](#)  
Exclusive Remedies [5](#)  
External Reference Signal Input Connector [24](#)

## F

flange for rackmount  
mounting [15](#)  
front handle  
mounting [16](#)

## H

handle kit  
mounting [17](#)

## I

inspection  
incoming inspection [9](#)  
Interconnection Ports  
Maintenance [31](#)  
Internal Reference Signal Output Connector [25](#)

## M

manual changes [33](#)

## N

names and functions of parts [22](#)

## O

operating environment [12](#)

## P

power supply  
checking cable [19](#)  
checking the supply [18](#)  
connecting cable [19](#)  
cutting power [20](#)

turning on/off [20](#)

## R

rackmount kit  
mounting [17](#)  
rackmount/handle kit  
mounting [17](#)

## S

safety  
symbols [5](#)  
serial number plate [33](#)  
space to disconnect the plug [14](#)  
starting up E5053A [20](#)

## T

Test Ports  
Maintenance [31](#)

## U

USB (USBTMC) Interface Port [24](#)



This information is subject to change without notice.

© Keysight Technologies 2005-2019

Edition 4, April 2019



E5053-90020  
[www.keysight.com](http://www.keysight.com)