

Keysight Technologies

Infiniium Z-Series Oscilloscopes

Data Sheet

Achieve new extremes

- 63 GHz of real-time bandwidth on 1 or 2 channels
- 33 GHz of real-time bandwidth on 2 or 4 channels

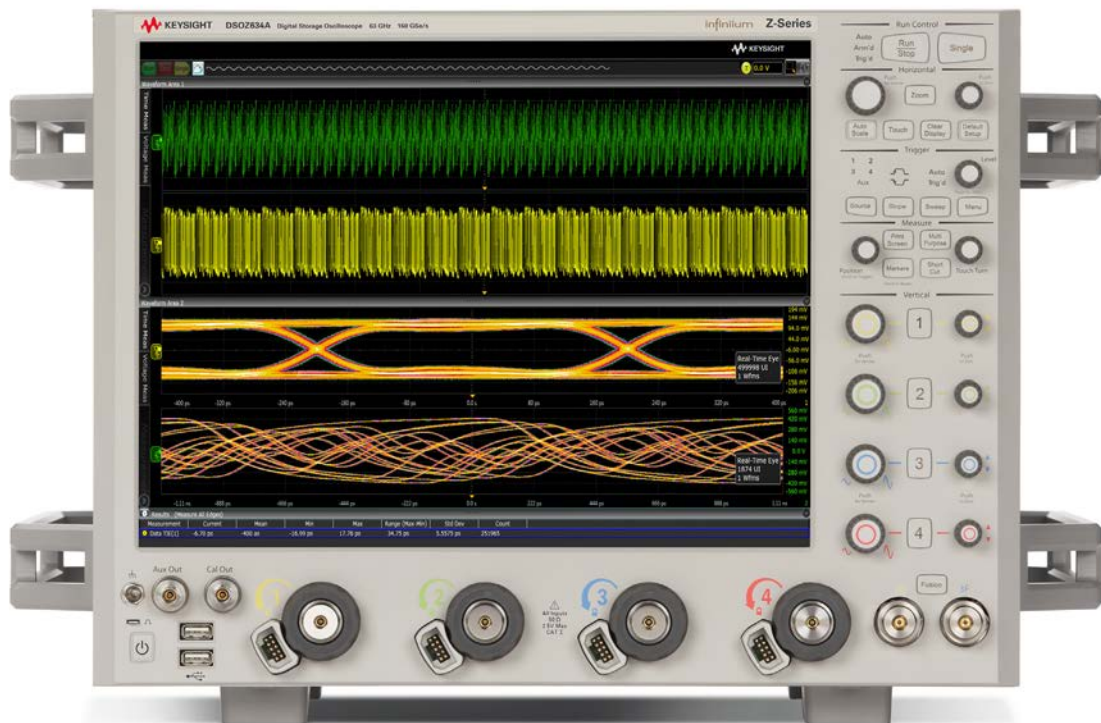

Introduction

Achieve new extremes

With the emergence of technologies pushing hundreds of Gb/s, an oscilloscope must now have high bandwidth, low noise and fast processing. That is the idea behind the Keysight Technologies, Inc. Infiniium Z-Series oscilloscopes. They feature up to 63 GHz of real-time oscilloscope bandwidth and the industry's lowest noise and jitter measurement floors.



The Infiniium Z-Series captures rise times as fast as 5 ps (20/80).

Featuring

- 63 GHz of real-time oscilloscope bandwidth
- The industry's only upgradable channel oscilloscope in a single frame (from 2 to 4 channels)
- The industry's lowest noise and jitter measurement floor
- The industry's highest ENOB at bandwidths up to 63 GHz
- The industry's deepest memory (up to 2 Gpts)

	Bandwidth			Sample rate			Memory depth	
	1 channel	2 channel	4 channel	1 channel	2 channel	4 channel	Standard	Maximum
DSAZ634A	63 GHz	63 GHz	33 GHz	160 GSa/s	160 GSa/s	80 GSa/s	100 Mpts	2 Gpts
DSOZ634A							50 Mpts	2 Gpts
DSAZ632A	63 GHz	33 GHz	-	160 GSa/s	80 GSa/s	-	100 Mpts	2 Gpts
DSOZ632A							50 Mpts	2 Gpts
DSAZ594A	59 GHz	59 GHz	33 GHz	160 GSa/s	160 GSa/s	80 GSa/s	100 Mpts	2 Gpts
DSOZ594A							50 Mpts	2 Gpts
DSAZ592A	59 GHz	33 GHz	-	160 GSa/s	80 GSa/s	-	100 Mpts	2 Gpts
DSOZ592A							50 Mpts	2 Gpts
DSAZ504A	50 GHz	50 GHz	33 GHz	160 GSa/s	160 GSa/s	80 GSa/s	100 Mpts	2 Gpts
DSOZ504A							50 Mpts	2 Gpts
DSAZ334A	33 GHz	33 GHz	33 GHz	80 GSa/s	80 GSa/s	80 GSa/s	100 Mpts	2 Gpts
DSOZ334A							50 Mpts	2 Gpts
DSAZ254A	25 GHz	25 GHz	25 GHz	80 GSa/s	80 GSa/s	80 GSa/s	100 Mpts	2 Gpts
DSOZ254A							50 Mpts	2 Gpts
DSAZ204A	20 GHz	20 GHz	20 GHz	80 GSa/s	80 GSa/s	80 GSa/s	100 Mpts	2 Gpts
DSOZ204A							50 Mpts	2 Gpts



Table of Contents

Introduction.....	2
Advanced IC Design and Technology Help You Solve Your Biggest Problems.....	4
The Oscilloscope – Digital Measurement and Analysis	5
The Spectrum Analyzer – Radar and Satellite Communications Analysis	6
The Optical Modulation Analyzer	7
The Network Analyzer – Time-Domain Transmission (TDT).....	8
The World’s Fastest Probing System For Your Highest Performance Needs.....	9
Achieve Your Real Edge	11
Achieve New Extremes	12
Analysis Tools: PrecisionProbe Basic and Advanced (N2809A and N2807B).....	18
Analysis Tools: EZJIT, EZJIT Plus and SDA (Standard on DSA Models).....	19
Analysis Tools: EZJIT Complete (Standard on DSA Models).....	20
Analysis Tools: InfiniiSim (N5465A)	21
Analysis Tools: Serial Data Equalization (N5461A)	22
Analysis Tools: InfiniiScan (N5414B).....	22
Analysis Tools: N8900A Infiniium Offline Oscilloscope Analysis Software	23
Analysis Tools: User-Defined Function (N5430A).....	24
Analysis Tools: Complete List of Analysis Software	24
Compliance and Automated Testing	25
Compliance and Automation Testing: User-Defined Application (N5467B)	26
Compliance and Automation Testing: Switch Matrix Support	27
Compliance and Automation Testing: Other Options on Z-Series Oscilloscopes.....	28
Protocol Analysis	29
Achieve New Extremes	31
Specifications.....	34
Keysight Oscilloscopes	42
Evolving Since 1939.....	44

Advanced IC Design and Technology Help You Solve Your Biggest Problems

At the extremes of electrical and optical measurements ...

You need to make rise time measurements without being limited by scope bandwidth

The Z-Series is Keysight Technologies' second generation of enabling 63 GHz of oscilloscope bandwidth. RealEdge technology is implemented using a unique combination of time interleaving, frequency interleaving and proprietary signal processing.

You need to see your signal and not oscilloscope noise

The Z-Series leverages technology from the award-winning Infiniium 90000X and 90000Q Series oscilloscopes, which provide leading signal integrity specifications. The Z-Series takes advantage of leading-edge indium phosphide chip technology and custom thin film packaging technology, which ultimately leads to the lowest-noise-, real-time oscilloscope in the world. With industry-leading bandwidths, Z-Series scopes let you see your fastest signals as they really are.

You need fast analysis and hardware acceleration

The Z-Series has a capacitive touch screen, new processor and 16 GB of RAM to ensure faster processing than previous-generation Infiniium oscilloscopes.

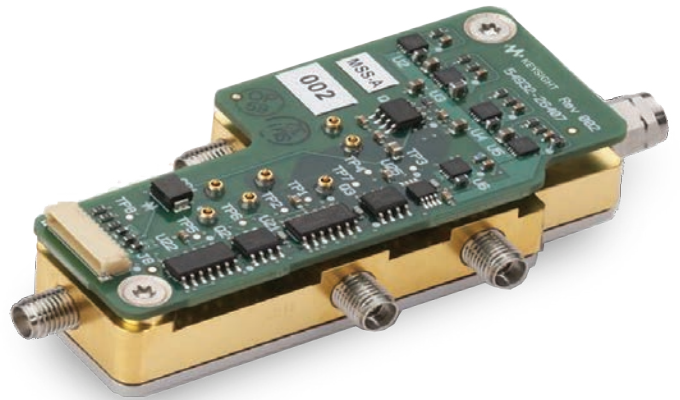

RealEdge technology blocks enable 63-GHz real-time bandwidth.

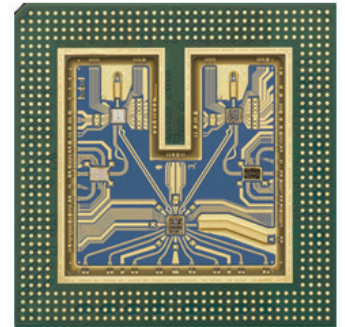
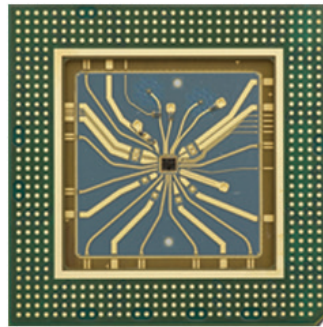

Infiniium's custom multi-chip modules feature indium phosphide chips and Keysight proprietary packaging technology, enabling high bandwidth and low noise.



The Oscilloscope – Digital Measurement and Analysis

With 63 GHz of bandwidth to capture rise times as fast as 5 ps and recover clocks on NRZ data rates as fast as 120 Gbit/s, the Z-Series is the world's fastest real-time oscilloscope. Its four channels at 33 GHz make it ideal for 32 Gb/s and greater SERDES designs. In addition to providing leading-edge bandwidth, the Z-Series helps you to find your real edge, by featuring the industry's lowest noise and jitter measurement floor, which means less scope noise in your measurements and a truer depiction of your signal.

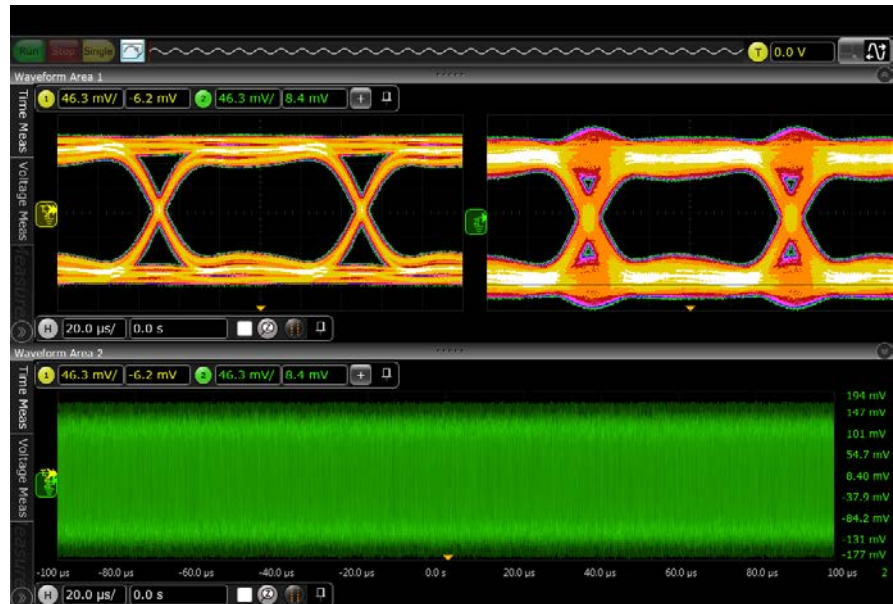

Capture, display and measure multiple real-time eyes simultaneously with the Z-Series.

Z-Series features the following to enable extreme digital analysis

1. Full offline analysis
2. Flexible user interface that supports multiple displays and multi-touch
3. Two unique jitter separation algorithms, including bounded uncorrelated jitter (BUJ) breakdown
4. Clock recovery on NRZ data rates as fast as 120 Gb/s
5. Memory depth that captures milliseconds of data at 160 GSa/s



With its flat frequency response and low noise, the Z-Series is able to accurately measure jitter components such as ISI.

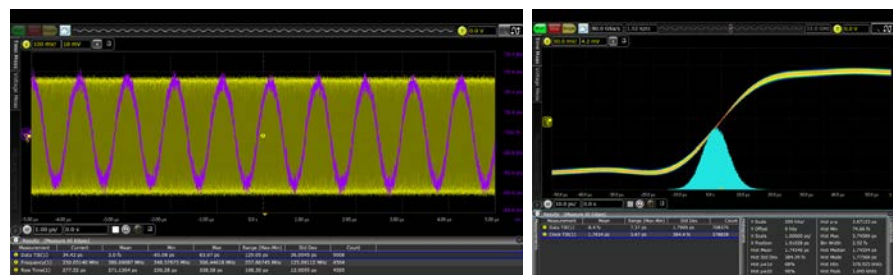

With the 63 GHz bandwidth, the Z-Series is able to effectively characterize the time interval error trend of high speed signals as well as fast rising edges, down to 5 ps.



The Spectrum Analyzer – Radar and Satellite Communications Analysis

You need to easily compute both magnitude and phase

Infiniium Z-Series oscilloscopes include a Fast Fourier Transform (FFT) for frequency domain (spectrum) analysis. The integrated FFT offers an alternative to a dedicated spectrum analyzer. Use the FFT to compute both magnitude and phase and take advantage of several useful features to assist in spectral analysis. The FFT can control span and resolution bandwidth. Automatic measurements and markers measure spectral peak frequencies and magnitudes as well as deltas between peaks. Use the amplitude demodulation (envelope mode) to measure rise and fall times on the entire envelope.

Z-Series features the following to enable extreme RealEdge analysis

- Multiple FFT windows including Hanning, rectangular, Blackman-Harris, flattop, and Hamming
- Peak search and navigation for fast analysis
- Amplitude modulation (envelope mode) – create radar envelopes
- FFT mask trigger
- Gated FFT measurements



The Z-Series FFT quickly identifies peaks and has key controls such as span, start and stop, which make the oscilloscope behave more like a spectrum analyzer.

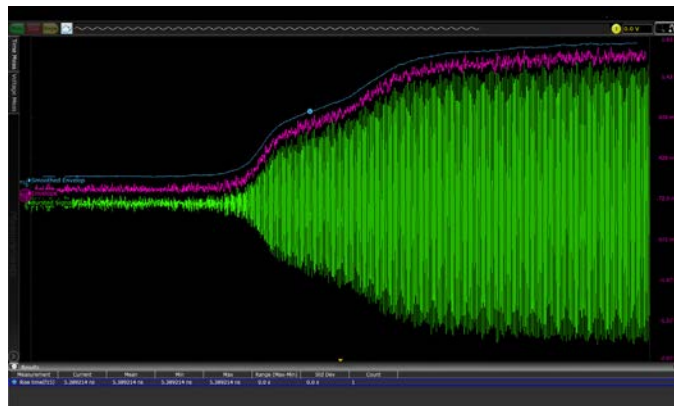

Amplitude demodulation makes it possible to analyze difficult waveforms such as envelopes.

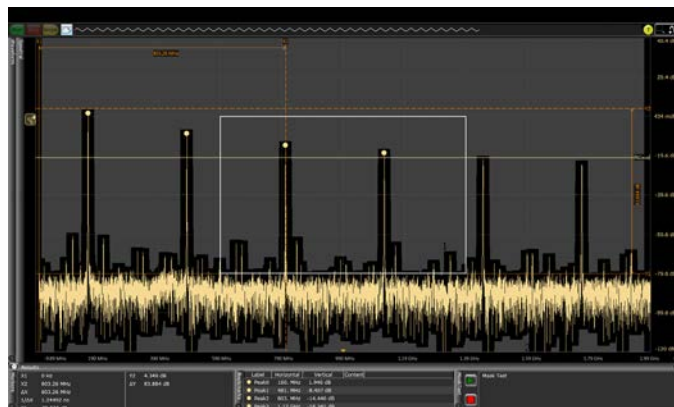

Use the FFT mask to test frequency margins and capture rare events.



The Optical Modulation Analyzer

Z-Series oscilloscopes are also available in combination with the N4391A optical modulation analyzer as a fully specified turn-key instrument. This compact solution offers the highest bandwidth available on the market and is the most advanced test solution for advanced research on 400G and terabit transmission. Even for the lower 20 GHz bandwidth range, this compact and easy-to-use solution is a reference system for 100G transmission required by R&D labs working at 100G and beyond. By providing four channels of up to 63 GHz bandwidth, the Z-Series saves you the expense of a second instrument to analyze dual polarization.

If you prefer to operate with your own optical receivers but want to benefit from the enormous analysis capability, you can get the N4391A's analysis software as a standalone package.

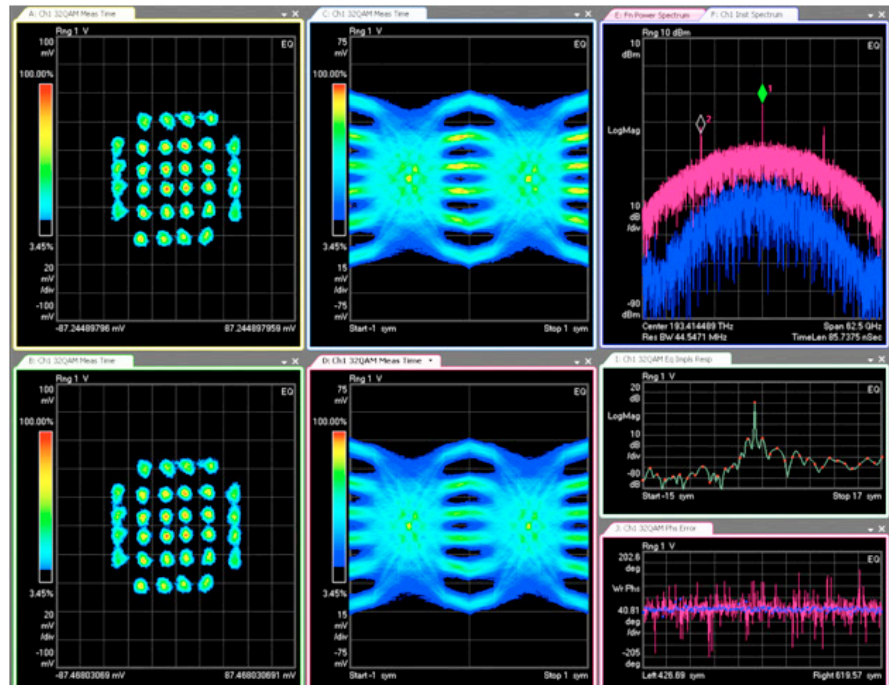

The N4391A offers a powerful toolset to debug the most challenging errors, with tools proven by thousands of RF engineers.

Features and benefits

- Up to 63 GHz true analog bandwidth on four channels by time synchronizing two 2-channel, 63 GHz scopes
- Up to 33 GHz true analog bandwidth on four channels in one scope
- Up to 120 Gbaud symbol rate analysis
- Four times better EVM noise floor than typical QPSK transmitter
- Compact four channels in turn-key solution
- Up to four 160 GSa/s real-time sampling for optimal phase tracking
- Well-defined interface to include your own MATLAB algorithms
- Customer-configurable APSK and OFDM decoders



The Network Analyzer – Time-Domain Transmission (TDT)

You need to be able to maximize your margins by removing the effects of cables and fixtures

As bandwidths continue to increase and cable loss becomes more and more of a problem, the Z-Series has the technology to solve this issue. The Z-Series oscilloscopes offer award-winning PrecisionProbe Advanced technology. You no longer need to ignore cable loss because you are short on time or budget. Using PrecisionProbe Advanced technology, you can characterize cables as fast as 63 GHz and remove the loss they create. PrecisionProbe Advanced technology gives you one of the world's fastest edges at less than 5 ps and uses this edge to perform a TDT on your cable. Based on the loss of your cable, PrecisionProbe Advanced then compensates your measurement system, gaining back valuable margin typically lost in cables.

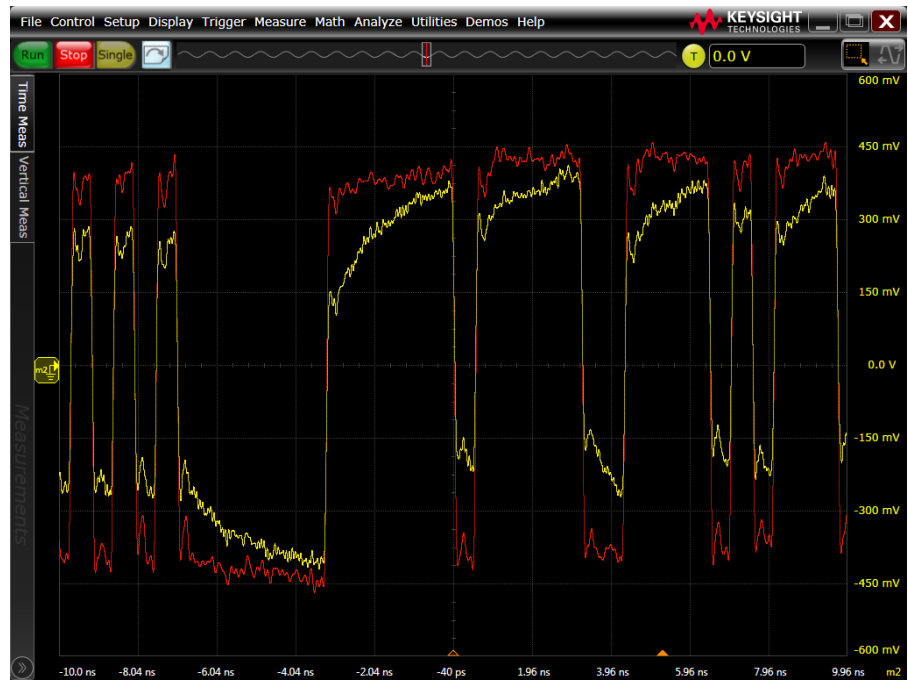

By analyzing cables you can increase your margins by removing insertion loss caused by cables.

You need to test multiple lanes automatically and still maximize margins

The Z-Series features many compliance applications, which provide full automation of any switch connected to your system. The software is fully compatible with PrecisionProbe Advanced compensation, which allows you to characterize every input using only your Z-Series oscilloscope and then seamlessly automate every measurement in your compliance application. Save valuable time and resources in such technologies as DisplayPort and PCI Express® Gen3.



The World's Fastest Probing System For Your Highest Performance Needs

The InfiniiMax III and III+ probing system provides the highest bandwidth and incredibly low loading to allow for a completely new level of signal fidelity and accuracy. Eight different InfiniiMax probe amplifiers ranging from 8 to 30 GHz are available for matching your probing solution to your performance and budget requirements. The InfiniiMax III and III+ probe system is unmatched by any product in the market. It uses a proprietary 200 GHz transistor switching speed indium phosphide IC process with backside ground vias and novel thick-film technology to accommodate your highest-performance needs.

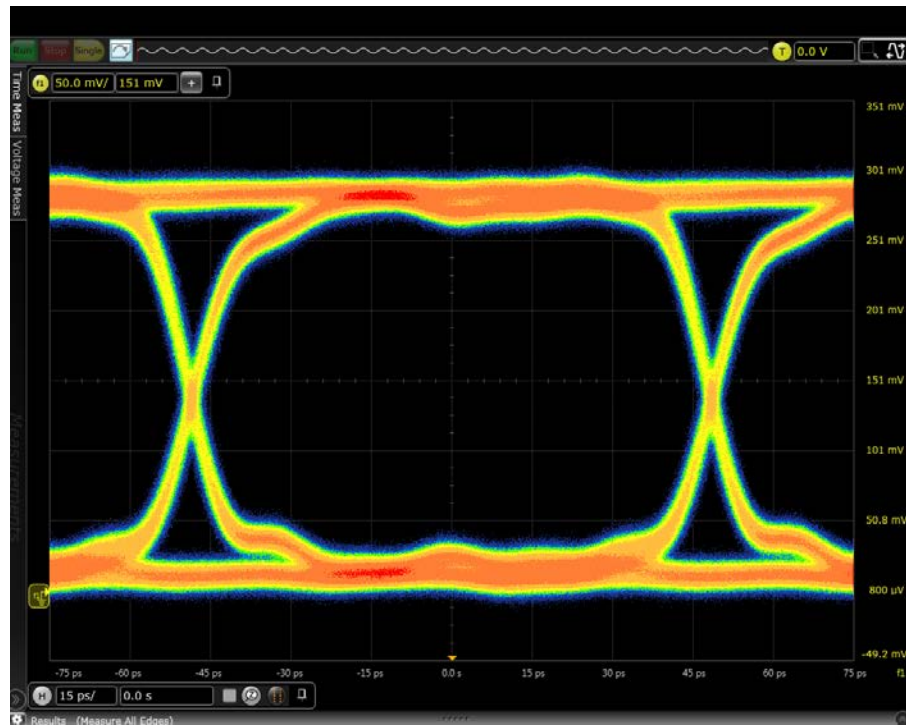

Industry's only upgradable probing system.



The World's Fastest Probing System For Your Highest Performance Needs (Continued)

Description	Probe or accessory	Bandwidth
30-GHz InfiniMax III probe amplifier	N2803A	30 GHz
25-GHz InfiniMax III probe amplifier	N2802A	25 GHz
20-GHz InfiniMax III probe amplifier	N2801A	20 GHz
16-GHz InfiniMax III probe amplifier	N2800A	16 GHz
20-GHz InfiniMax III+ probe amplifier	N7003A	20 GHz
16-GHz InfiniMax III+ probe amplifier	N7002A	16 GHz
13-GHz InfiniMax III+ probe amplifier	N7001A	13 GHz
8-GHz InfiniMax III+ probe amplifier	N7001A	8 GHz
ZIF probe head	N5439A	28 GHz
Browser (handheld) probe head	N5445A	30 GHz
Solder-in probe head	N5441A	16 GHz
PC board ZIF tip	N2838A	25 GHz
3.5/2.92/SMA probe head	N5444A	28 GHz
Performance verification fixture	N5443A	30 GHz
Solder-in probe head	N2836A	26 GHz
450-ohm ZIF tip kit (set of five)	N5440A	28 GHz
200-ohm ZIF tip kit (set of five)	N5447A	28 GHz
Browser tip replacement	N5476A	30 GHz
Precision BNC adaptor	N5442A	13 GHz
Sampling scope adaptor	N5477A	30 GHz
2.92-mm flexible cable	N5448B	30 GHz
High-impedance probe adaptor	N5449A	500 MHz
35-GHz flexible cable	N2812B	35 GHz



Achieve Your Real Edge

Having the right amount of oscilloscope bandwidth ensures accurate measurements. If you have too much bandwidth, oscilloscope noise becomes a contributor in your measurement. With too little bandwidth, rise times are improperly depicted. Use the chart below to find the correct oscilloscope bandwidth for the devices you are measuring.

Recommended scope bandwidth

Technology	Data rate	Fastest rise time	Scope BW
Ethernet 10BASE-T	10 Mbps	30 ns	600 MHz
Ethernet 100BASE-T	100 Mbps	3 ns	600 MHz
Ethernet 1000BASE-T	250 Mbps x 4	1.2 ns	1 GHz
USB 2.0	480 Mbps	300 ps	2.5 GHz
USB 3.1 Gen 1	5 Gbps	50 ps	12 GHz
USB 3.1 Gen 2	10 Gbps	25 ps	25 GHz
DDR1	400 MT/s	500 ps	2 GHz
DDR2	1066 MT/s	250 ps	4 GHz
DDR3	2133 MT/s	100 ps	8 GHz
DDR4	3200 MT/s	75 ps	12 GHz
GDDR5	8 Gbps	30 ps	16 GHz
SATA 3G	3 Gbps	67 ps	12 GHz
SATA 6G	6 Gbps	33 ps	16 GHz
SAS-2	6 Gbps	42 ps	16 GHz
SAS-3	12 Gbps	21 ps	30 GHz
16G FibreChannel	14.025 Gbps	24 ps	30 GHz
HDMI 1.4	3.4 Gbps	50 ps	8 GHz
DisplayPort 1.2	17.28 Gbps	50 ps	13 GHz
10G Ethernet	10 Gbps	60 ps	12 GHz
10Gbase-KR	10.3125 Gbps	24 ps	25 GHz
XAUI	3.75 Gbps	60 ps	12 GHz
MIPI® M-PHY®	5.83 Gbps	17.2 ps	24 GHz
MIPI D-PHY SM	2.5 Gbps	100 ps	6 GHz
PCI Express 2	5 Gbps	30 ps	12.5 GHz
PCI Express 3	8 Gbps	25 ps	20 GHz
28/32G FibreChannel	28 Gbps	18 ps	45 GHz
Thunderbolt 3	20.625 Gbps	10 ps	33 GHz
SFP +	10 Gbps	34 ps	16 GHz
MHL	2.25 Gbps	75 ps	8 GHz
InfiniBand II	2.5 Gbps, 5 Gbps	75 ps	8 GHz

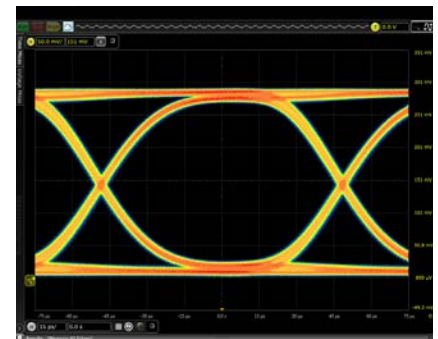

10 Gbps eye captured with 10 GHz of bandwidth.

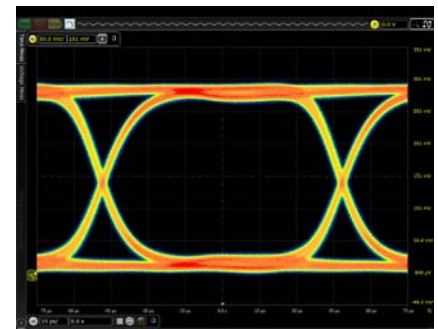

10 Gbps eye captured with 20 GHz of bandwidth.

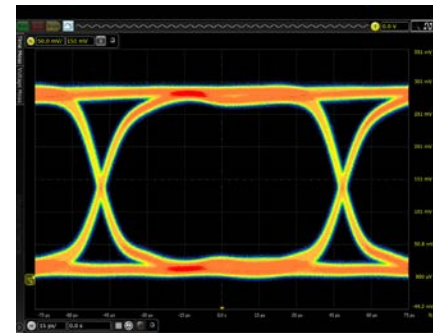

10 Gbps eye captured with 30 GHz of bandwidth.

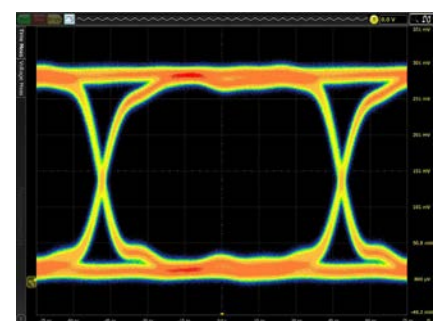

10 Gbps signal captured with 63 GHz of bandwidth. Notice the faster rise time and wider eye measurements.

Achieve New Extremes

Introducing Infiniium Z-Series oscilloscopes

63 GHz of true analog bandwidth and 160 GSa/s on two channels.

See your signal more clearly with a large 15.4-inch capacitive touch-screen display.

16 GB RAM standard, quad core i5 processor and hardware acceleration enable fast processing.

Remote access through Ethernet 10/100/1000BASE-T LAN interface with Web-enabled connectivity uses ultra-responsive UltraVNC.

USB and LAN provide remote measurements. Infiniium application remote program interface (now a standard feature) allows application/compliance software automation.

Calibration edge with a rise time of less than 15 ps enables TDT calibration with PrecisionProbe. Use the Infiniium calibration source as part of PrecisionProbe Advanced to extend calibration to an unmatched 63 GHz.

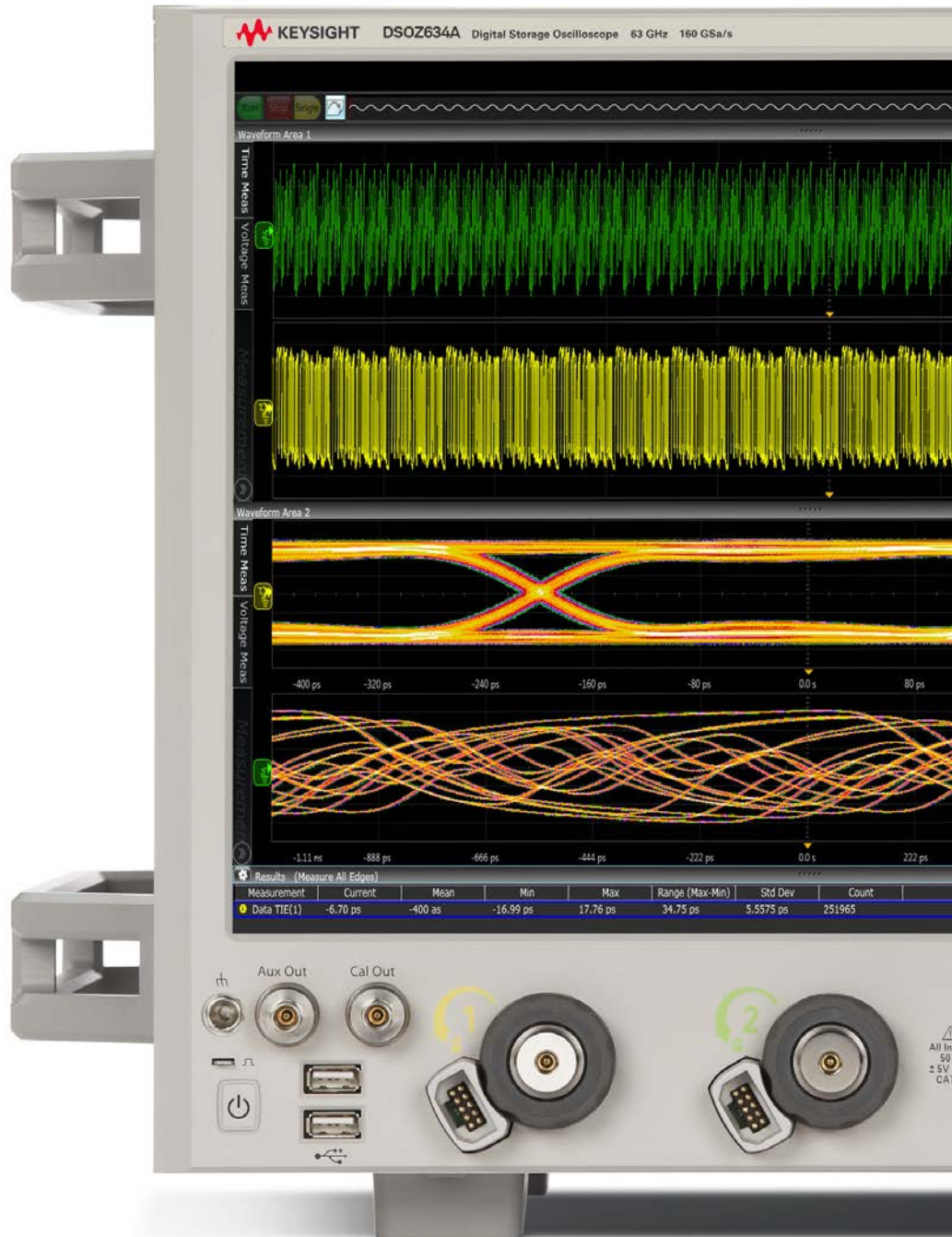

Threaded RF connectors ensure the most reliable signal integrity for high-performance instruments. The AutoProbe II interface combines the tried-and-true 3.5-mm threaded RF connector of Keysight sampling oscilloscopes with a convenient automatic torque mechanism that ensures a consistent 8 in. lbs. connection without the hassles of a torque wrench.



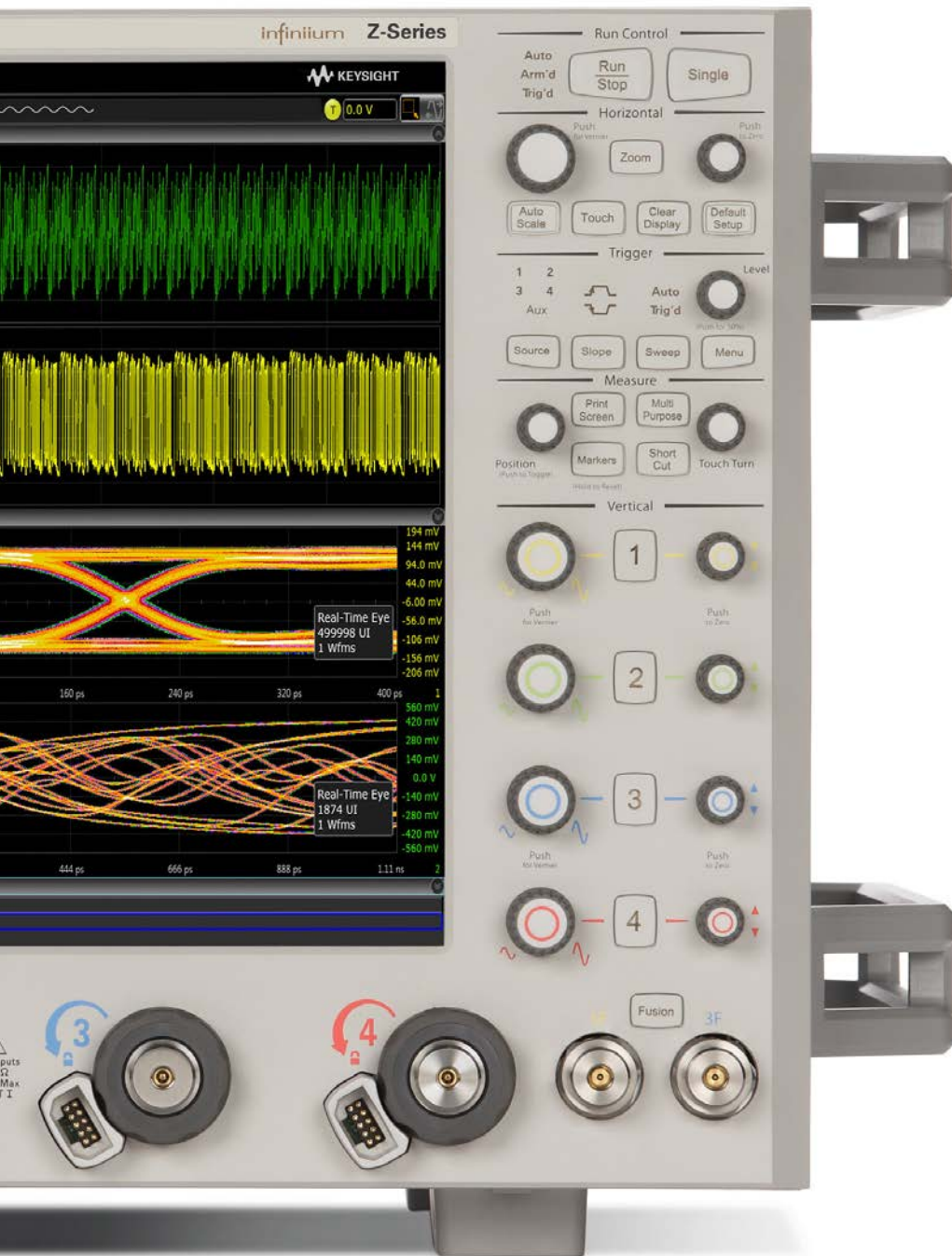

100-MHz reference clock ties up to 10 Z-Series together with 150 fs precision. A 10-MHz clock allows tying multiple instruments together with the Z-Series.

Live indicator shows when the scope is running a long operation.

Measure section, including a toggling marker button and a dedicated marker knob, provides quick access to your marker control.

Individual vertical knobs per channel.

The horizontal and vertical knobs can be changed to control functions and waveform memories. Simply right click the channel control in the GUI to change these controls.

The Z-Series improves upon Keysight's use of custom integrated circuits and multichip module packaging with an exclusive technology called RealEdge. RealEdge comprises a combination of new architectures, next-generation microcircuits and thin-film components, and advanced application of Keysight's indium phosphide semiconductor process. This technology enables high-frequency capability while maintaining the industry's lowest noise and jitter measurement floor (75 fs).



Achieve New Extremes (Continued)

Infiniium User Interface

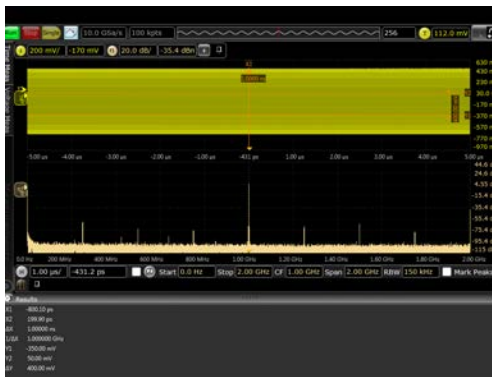

Easy-to-use FFTs.

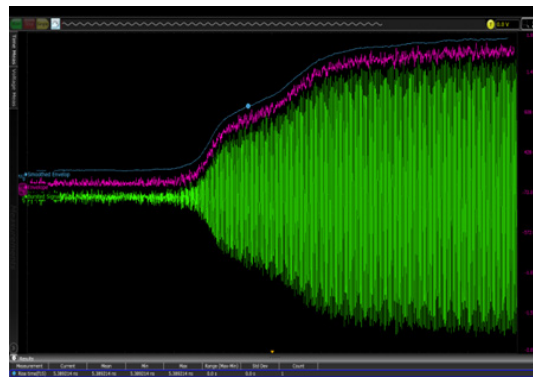

Amplitude demodulation.



Protocol decode.



The Infiniium user interface features:

- Full offline viewer
- Up to 4 grids
- Up to 16 functions
- Up to 16 horizontal gates
- Up to 9 jitter analysis charts
- Up to 9 noise analysis charts
- Up to 4 InfiniiSim charts
- Up to 16 FFTs at once
- Up to 16 grids in each window
- Peak annotation
- Composite files for easy file sharing
- On-screen marker measurements
- Up to 20 measurements displayed at once
- Multiple display support
- Drag and drop measurements
- My Infiniium menu customization
- Up to 16 user-defined functions
- Full spectral window
- Spectral analysis controls
- Quick save
- Multi-touch for touch capacitive screen
- Function overviews/window
- Up to 16 measurement trends
- Up to 16 histograms
- Nearly unlimited real-time eyes
- Tail fit versus spectral analysis chart
- Hardware acceleration
- Plus much more

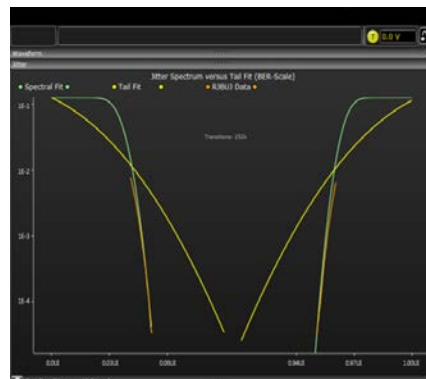
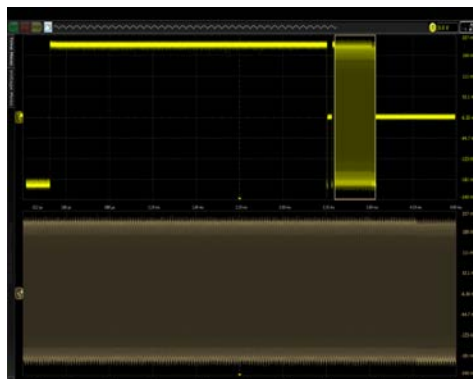
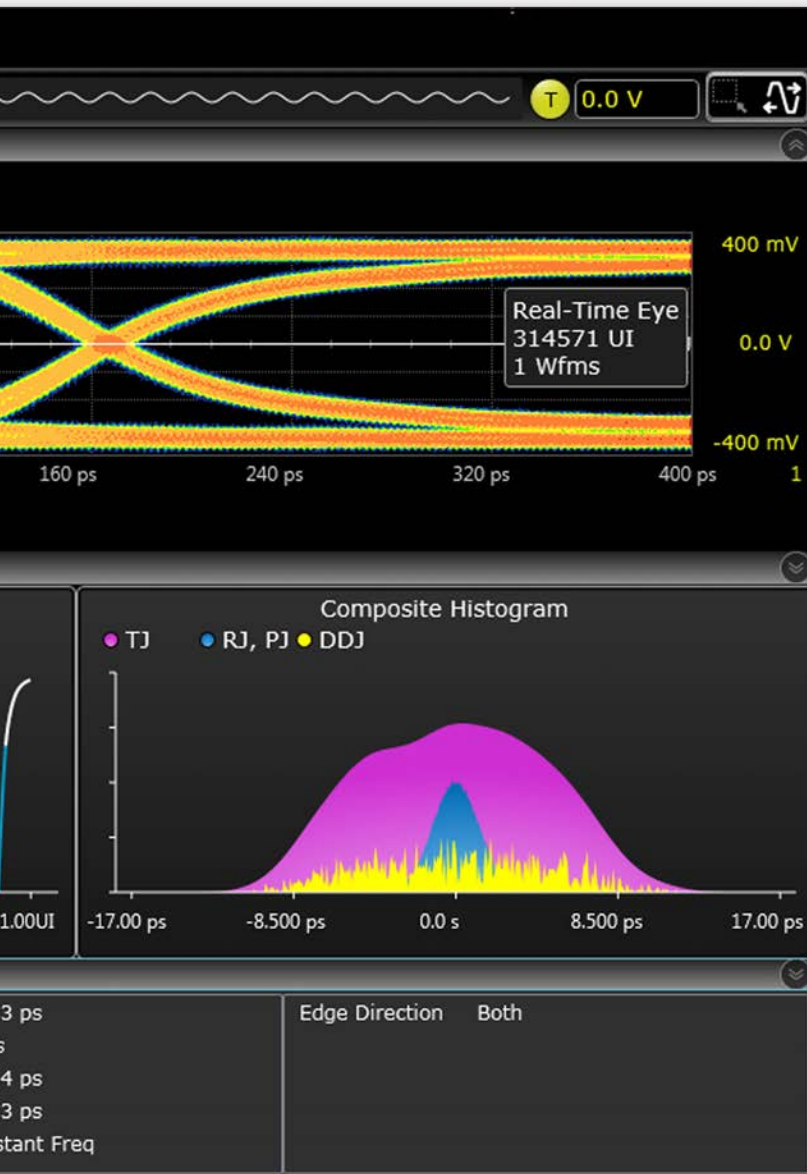

Up to 16 horizontal gates.

Jitter algorithm verifying window.



Achieve New Extremes (Continued)

Low noise and jitter

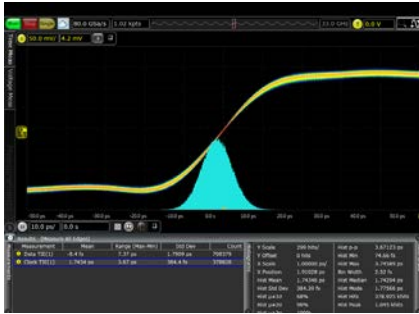

The Z-Series features the industry's lowest noise and jitter measurement floors, allowing you to truly see your signal and get your device to market faster.

PrecisionProbe



By characterizing and compensating for loss in cables, you can gain significant margin. PrecisionProbe makes using switches easy in your test setup.

Waveform transformation

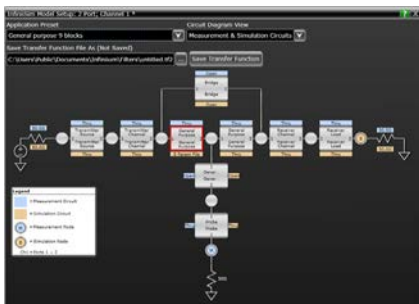

Debugging next-generation buses such as PCI Express and Thunderbolt require advanced analysis tools. Keysight's InfiniiSim software helps you model the most difficult situations.

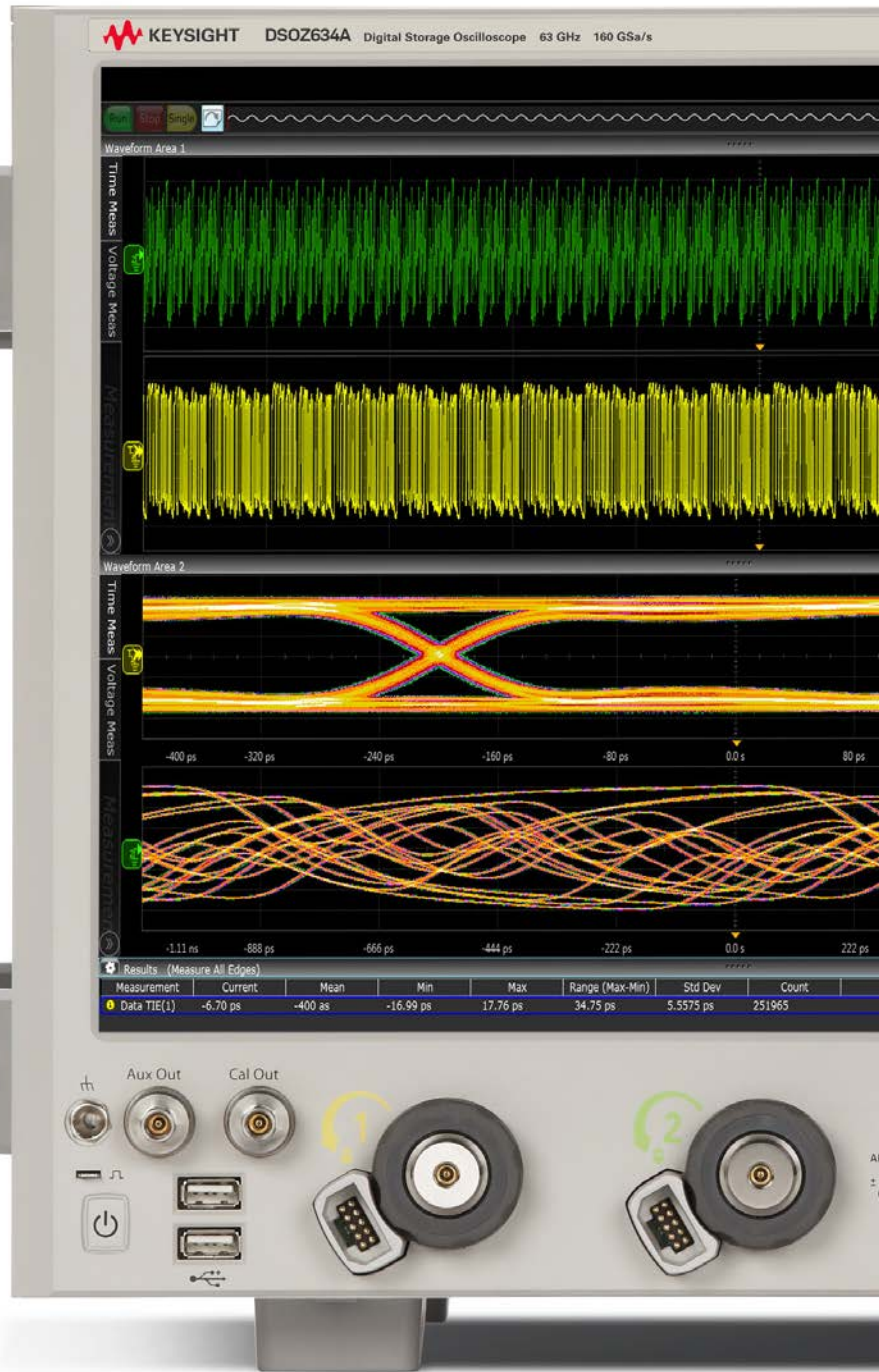

Infiniium Z-Series oscilloscopes are the world's only 4-channel, 33-GHz real-time oscilloscopes. Z-Series scopes are the only oscilloscopes that feature 30-GHz probes, making debugging your system easier and ensuring you aren't missing valuable harmonic content.



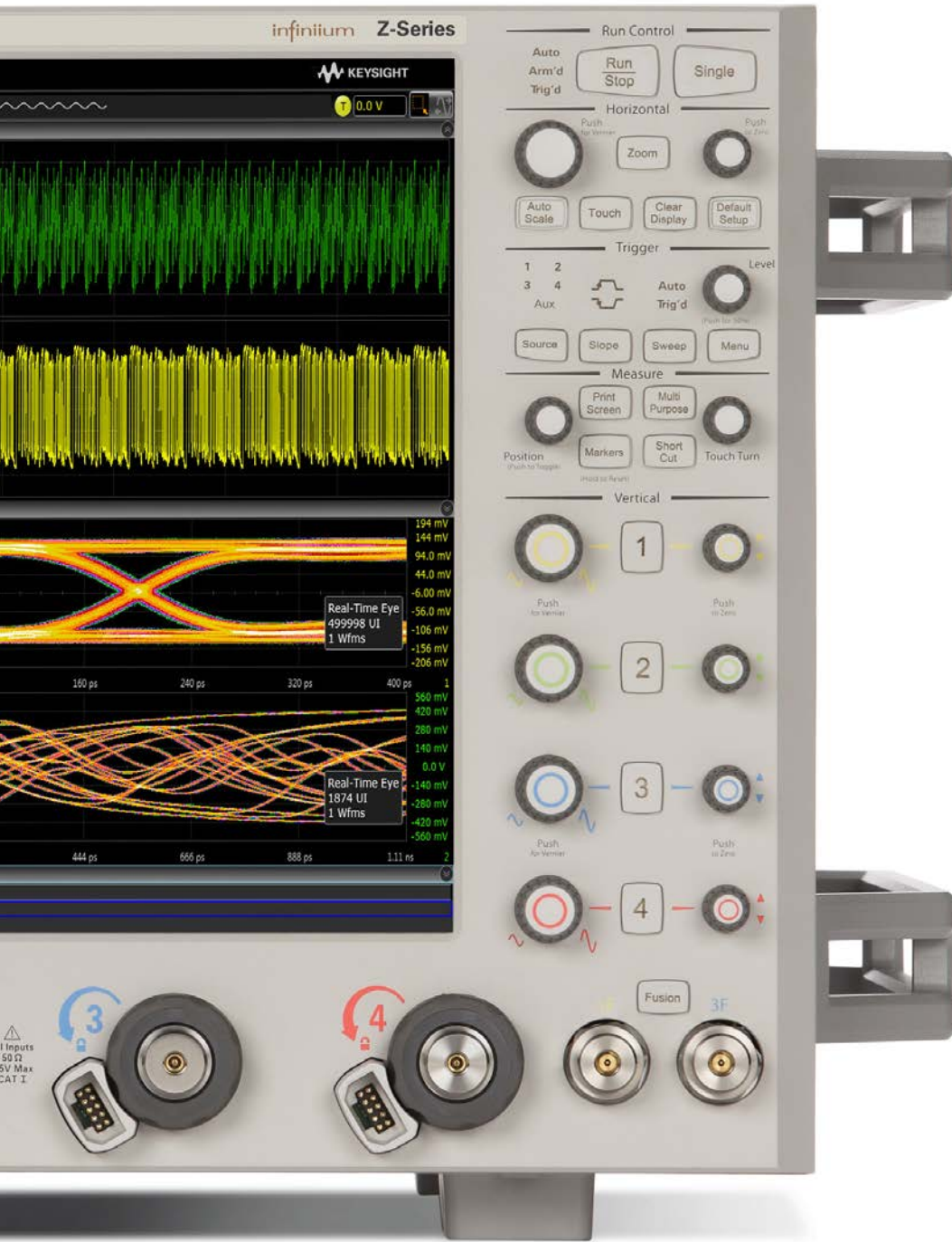

Compliance software

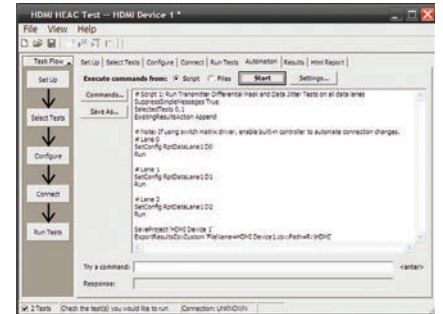

Keysight's compliance software packages are certified by experts and provide assurance that when you pass in-house, you will pass at your customer site as well.

Protocol analysis



Infiniium protocol tools simplify debugging your design. Infiniium scopes offer full protocol analysis for PCI Express Gen 1, 2, and 3. The 128b/130b decoding features a lister that makes alignment between the lister and analog channels simple.

Advanced jitter and noise separation



Infiniium's new noise analysis tools allow you to analyze your data bus completely.

Z-Series oscilloscopes features application-specific software that allows you to gain the insight into your design that you need. Whether you are solving tough jitter or noise problems, removing loss due to cables or probes, or simply looking at protocol, the Z-Series has the tools to help you ensure you realize your best design.



Analysis Tools: PrecisionProbe Basic and Advanced (N2809A and N2807B)

Turn your Z-Series oscilloscope into a time-domain transmissometry (TDT). Quickly characterize and compensate any input into your scope.

PrecisionProbe technology turns your oscilloscope into the ultimate characterization tool. Not only can you do the normal waveform transformations such as de-embedding through InfiniiSim, PrecisionProbe allows quick characterization of your entire probe system (including cables and switches) without the need for extra equipment. PrecisionProbe takes advantage of the fast “cal output” signal built into the Z-Series to characterize and compensate insertion loss on the measurement system.

PrecisionProbe technology:

- Properly creates custom probe transfer function = V_{Out}/V_{In}
- Properly characterizes probed system transfer function such that $V_{Out}/V_{In} = V_{Out}/V_{Src}$
- Removes unwanted S21 cable loss

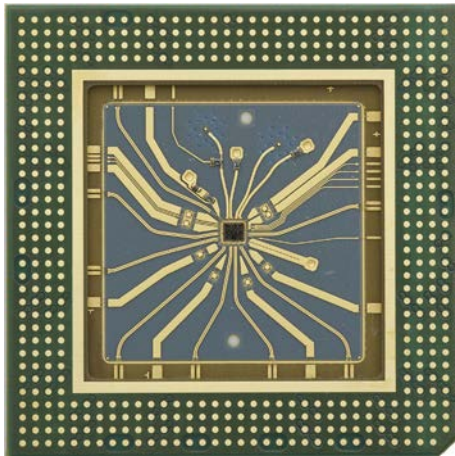

Every Z-Series oscilloscope has Keysight's custom indium phosphide (InP) fast edge.

Now every probe and cable in the system can have the exact same response – probe to probe or cable to cable – without the inaccuracies that using one model can produce. You can properly characterize custom probes and remove unwanted responses. In addition to characterizing the cables, PrecisionProbe allows for immediate use on the same instrument. PrecisionProbe saves you time and money while increasing your measurement accuracy.

When you combine InfiniiMax probes with switches between the amplifier and the probe head, PrecisionProbe allows for full correction and automation of each probe's path. Full automation is then available to allow for quick swapping of the inputs via Infiniium's compliance framework. For increased accuracy, purchase PrecisionProbe Advanced for faster edge speeds and true differential measurements.



PCI Express measurement comparisons

Root complex device	Eye height (mV)	Eye height PrecisionProbe	Gain (%)
2.5 GT/s_12 GHz	517.19	553.94	7.1
5 GT/s_12 GHz_3.5 dB	312.22	348.19	11.5
5 GT/s_12 GHz_6 dB	341.1	376	10.2
5 GT/s_16 GHz_3.5 dB	306.6	348.33	13.6
5 GT/s_16 GHz_6 dB	344.4	374.41	8.7
8 GT/s_12 GHz_P7	96.83	103.09	6.5
8 GT/s_12 GHz_P8	100.16	108.33	8.2
8 GT/s_16 GHz_P7	96.92	106.01	9.4
8 GT/s_16 GHz_P8	100.24	108.24	8.0

By characterizing and compensating for cable loss on the cable connected to the PCI Express test fixture, the designer was able to gain between 6.5 and 13.6% margin that would have been lost otherwise.



Analysis Tools: EZJIT, EZJIT Plus and SDA (Standard on DSA Models)

Gain insight into the causes of signal jitter to ensure high reliability of your design

With faster edge speeds and shrinking margins in today's high-speed digital designs, insight into the causes of jitter has become critical for success. Using EZJIT and EZJIT Plus jitter analysis software the Z-Series oscilloscopes help you identify and quantify jitter margins that affect the reliability of your design. Time correlation of jitter to the real-time signal makes it easy to trace jitter components to their sources. Additional compliance views and a measurement setup wizard simplify and automate RJ/DJ separation for testing against industry standards.

EZJIT Plus automatically detects embedded clock frequencies and repetitive data patterns on the oscilloscope inputs and calculates the level of data-dependent jitter (DDJ) that is contributed to the total jitter (TJ) PDF by each transition in the pattern, a feature not available on any other real-time oscilloscope today.

Measurement trends and jitter spectrum

EZJIT's simple tools help you quickly analyze the causes of jitter. Measurement trends allow you to see deeper views of factors affecting measurements. Jitter spectrum is a fast method to find the causes of jitter.

Two ways to separate jitter

EZJIT Plus comes with two ways to separate jitter: the spectral method and the emerging tail fit method. Both methods allow for simple separation of RJ and DJ, but the tail fit method provides proper jitter separation in the unique case of bounded uncorrelated jitter.

Unique RJ/DJ threshold view

EZJIT Plus also provides a unique threshold view of the jitter spectrum with the threshold drawn on the chart. The spectral view provides insight into the decision point of the separation and works with both narrow and wide spectral separation.

Real-time eye and clock recovery

Serial data analysis (SDA) software provides flexible clock recovery including 1st and 2nd-order PLL and constant algorithms. With a stable clock, you can look at real-time eyes of transition and non-transition bits. Z-Series scopes with SDA software also provide a new unique view of bits preceding an eye.

Flexible charts

EZJIT Plus displays up to 10 graphs with unique information. Use them all to maximize your jitter analysis.

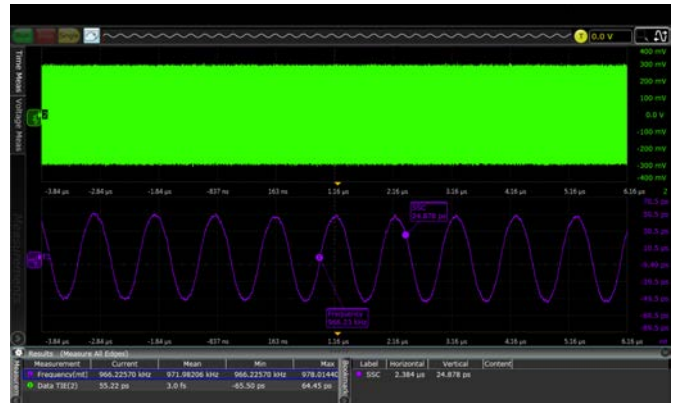

Use EZJIT software to extract spread spectrum clocks.

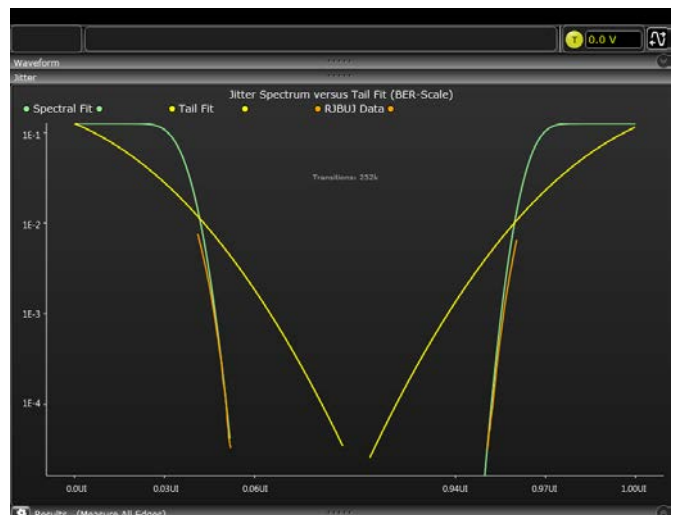

Determine which algorithm fits your data best.



Jitter separation makes debugging your device easy.



Analysis Tools: EZJIT Complete (Standard on DSA Models)

Discover signal anomalies to the noise of the waveform

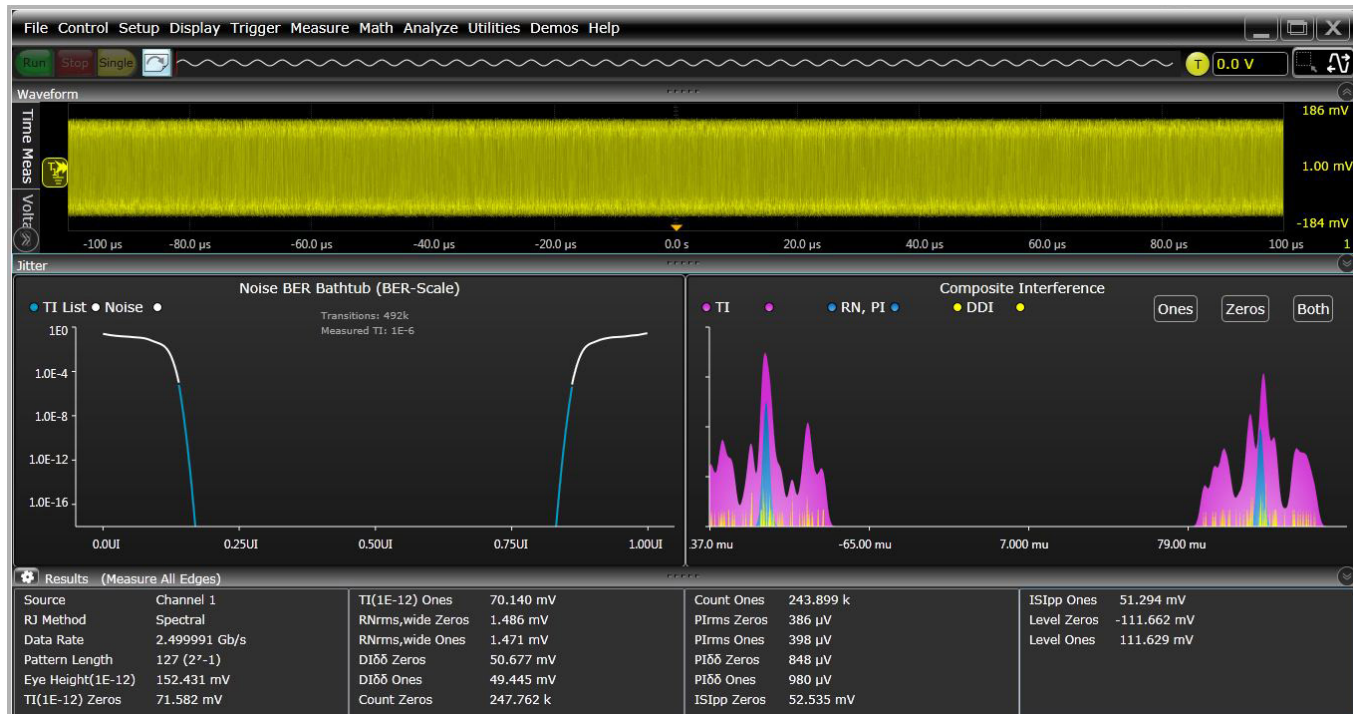

Noise analysis with EZJIT Complete software for insight into the sources of noise in the signal.

More than your standard jitter package

To efficiently determine root cause for any type of signal degradation in the amplitude domain, you must first determine whether the problem is caused by random or deterministic sources. To help you accomplish this task, EZJIT Complete takes analysis techniques used in the time domain (jitter analysis) and extends them into the amplitude domain.

More than just an eye contour

EZJIT Complete is an in-depth view into impairments related to signal levels – either logic ones or logic zeroes – deviating from their ideal positions. Some tools simply provide a view of an eye contour, but provide no real measurement data other than nice graphics.

EZJIT Complete uses separation techniques to allow each bit to be examined to determine correlated effects and to make multiple measurements on individual bits to determine uncorrelated effects. Use FFTs to analyze the frequency domain and extract random components. Dual-Dirac modeling techniques are also carried from the jitter domain and used in the interference domain.

Key measurements

With EZJIT Complete, Z-Series scopes offer the following unique measurements:

- Total interference (TI)
- Deterministic interference (DI)
- Random noise (RN)
- Periodic interference (PI)
- Inter-symbol interference (ISI)
- RIN (dBm or dB/Hz)
- Q-factor



Analysis Tools: InfiniiSim (N5465A)

The most advanced waveform transformation software helps you render waveforms anywhere in a digital serial data link

InfiniiSim waveform transformation toolset provides the most flexible and accurate means to render waveforms anywhere in a digital serial data link. The highly configurable system modeling enables you to remove the deleterious effects of unwanted channel elements, simulate waveforms with channel models inserted, view waveforms in physically improbable locations, compensate for loading of probes and other circuit elements, and do so simply and quickly on your tool of choice, the Z-Series at up to 63 GHz of bandwidth.

Circuit models to define your setup

The InfiniiSim waveform transformation toolset provides a graphical user interface for you to define your system as you understand it and even make it arbitrarily complex. You do this by selecting topologies and defining circuit blocks.

Model reflections

With the InfiniiSim waveform transformation toolset, you can transform signals with confidence, whether you are inserting or removing channel elements or relocating the measurement plane. InfiniiSim's advanced toolset lets you model up to 27 different elements at once and model the interaction between elements. Only toolsets with the ability to model more than one element will properly reflect a model including the oscilloscope's input. The Z-Series scopes provide their own S11 parameter to allow modeling of their own input.

Model your system with as much detail as you need

InfiniiSim features the model setup that best matches your design. Whether it is a simple single-element model or an advanced general-purpose model with up to 27 elements in the link, you can perfectly model your design and simulate the exact probing point you want.



InfiniiSim renders the waveform through hardware acceleration.

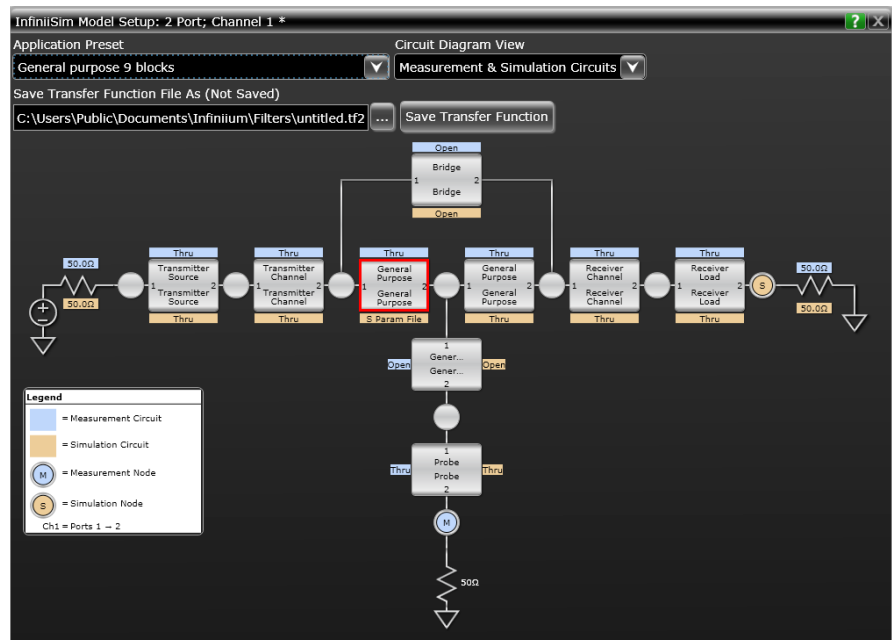

InfiniiSim allows embedding and de-embedding of up to 27 different elements or S-parameter models at once to meet your most demanding requirements.



Analysis Tools: Serial Data Equalization (N5461A)

Significantly reduce receiver errors by opening even tightly shut eyes through equalization emulation

Serial data equalization for the Z-Series provides fast and accurate equalization using decision feedback equalization (DFE), feed-forward equalization (FFE), and continuous-time linear equalization (CTLE) modeling in real-time. Serial data equalization software allows you to input your own self-designated tap values to verify your design. If you prefer, the software will find the optimal tap values for you. CTLE allows DC gain and two-pole modeling.

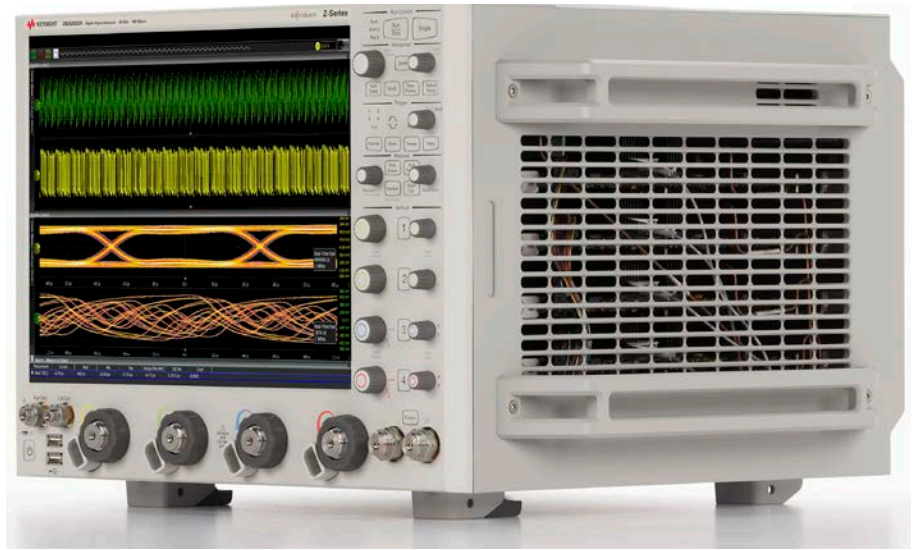

Analysis Tools: InfiniiScan (N5414B)

Trigger on events that hardware triggers can't handle

InfiniiScan software allows you to use an oscilloscope to identify signal integrity issues that hardware triggering is unable to find in your electronic designs. This innovative software scans through thousands of acquired waveforms per second to help you isolate signal anomalies, saving you time and improving designs.

Innovative triggers

The zone qualify finder allows you to draw a "must intersect" or "must not intersect" zone on the oscilloscope screen to visually determine the event identify condition. If you can see the event of interest on the screen, you can create a trigger that will isolate it, saving significant time over some complicated hardware triggers.

Other triggers include non-monotonic edge, measurement limit search, runt and pulse width.

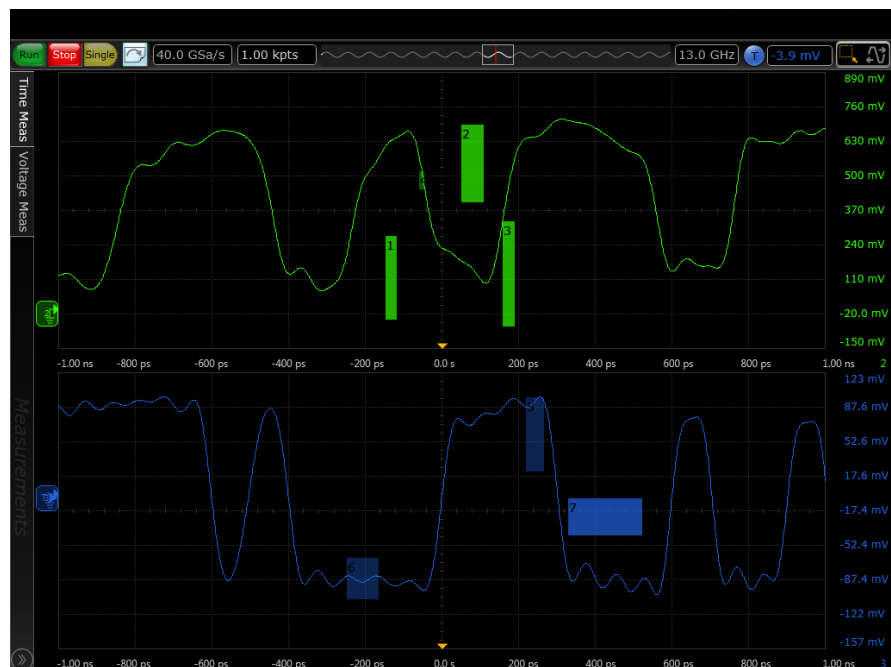

Draw zones on your screen for a unique triggering experience.



Analysis Tools: N8900A Infiniium Offline Oscilloscope Analysis Software

View and analyze away from your oscilloscope and target system

Ever wish you could do additional signal viewing and analysis away from your scope and target system? Now you can. Capture waveforms on your scope, save to a file, and recall into Keysight's Infiniium Offline application.

View and analyze anywhere your PC goes

Take advantage of large high-resolution and multiple displays found in your office. Use familiar scope controls to quickly navigate and zoom in to any event of interest. Use auto measurements and functions for additional insight.

Share scope measurements more easily across your team

You can share entire data records instead of being limited exclusively to static screen shots.

Create more useful documentation

Use features such as right-click cut-and-paste to move screen images between applications, without ever having to save the image to a file. Add up to 100 bookmark annotations and up to 20 simultaneous measurements.

Need advanced analysis capability?

Infiniium Offline includes a variety of upgrade options including serial decode upgrades for a variety of serial buses, jitter analysis, and serial data analysis.



Infiniium Offline software works with all of Infiniium's applications.



Use Infiniium Offline to find signal anomalies, such as power supply coupling.



Peak search capability makes Infiniium Offline a frequency domain tool.



Analysis Tools: User-Defined Function (N5430A)

Combine Infiniium and MATLAB for even more analysis

Enhance the Z-Series with a seamless gateway to powerful MATLAB analysis functionality. User-defined function software adds new analysis capabilities to the Z-Series, beyond traditional math/analysis features. Now you have the freedom to develop your own math functions or filters using MATLAB and its Signal Processing Toolbox. With a seamless integration to MATLAB, Infiniium oscilloscopes allow you to display your math and analysis functions live on the oscilloscope screen, just like any other scope's standard functions.

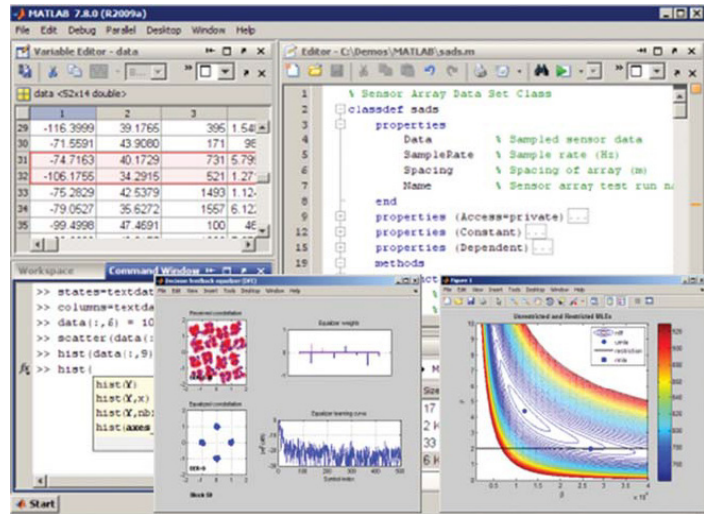

Analysis Tools: Complete List of Analysis Software

Description	License type		
	Fixed Factory-installed on new scope purchase or user-installed on existing scope	Floating User-installed transportable license	Server-based license
EZJIT Complete jitter analysis	N8823A-1FP	N8823A-1TP	N5435A-067
EZJIT Plus jitter analysis	N5400A-1FP	N5400A-1TP	N5435A-001
EZJIT jitter analysis	E2681A-1FP	E2681A-1TP	N5435A-002
Frequency domain analysis	N8832A-001	—	—
High-speed SDA and clock recovery	E2688A-1FP	E2688A-1TP	N5435A-003
InfiniiumScan software triggering	N5414B-1FP	N5414B-1TP	N5435A-004
InfiniiumSim advanced signal de-embedding	N5465A-1FP	N5465A-1TP	N5435A-027
InfiniiumSim basic signal de-embedding	N5465A-3FP	N5465A-3TP	N5435A-026
MATLAB - Basic digital analysis	N8831A-001	—	—
MATLAB - Standard digital analysis	N8831A-002	—	—
MultiScope software - combines two scopes ¹	—	N8834A-ATP	N5435A-085
MultiScope software - combines up to five scopes ¹	—	N8834A-BTP	N5435A-086
MultiScope software - combines up to ten scopes ¹	—	N8834A-CTP	N5435A-090
Pulse Amplitude Modulation (PAM-4) analysis	N8827A-1FP	N8827A-1TP	N5435A-077
PrecisionProbe calibration ²	N2809A-1FP	N2809A-1TP	N5435A-044
Serial data equalization	N5461A-1FP	N5461A-1TP	N5435A-025
User-defined function	N5430A-1FP	N5430A-1TP	N5435A-005

1. Supports any combination of Infiniium oscilloscope models with software 5.50 and above.
 2. Compliance software is not supported on DSAZ632A, DSOZ632A, DSAZ592A and DSOZ592A scope models.



Compliance and Automated Testing

Today's demanding environment means you have much less time to understand the intricacies of the technologies you are testing. You also have less time to develop and test automation software that is designed to increase measurement throughput and decrease time to market. Compliance applications save you time and money with measurement automation built into the compliance application. No longer do valuable resources need to be exclusively tied to writing automation software. Instead they can be deployed to designing the next big project.

Infiniium's compliance applications are fully functional with design tools such as ADS. Imagine running your waveforms at design through the entire suite of compliance tests, giving more insight earlier than was previously possible. As the design moves to silicon and then to validation, the same suite of tests can be run live on your device.

Compliance applications that run on Z-Series oscilloscopes are certified to test to the exact specifications of each technology standard. If a test passes on the Z-Series scope in your lab, you can be assured that it will pass in test labs and at plug fests worldwide. Keysight experts on technology boards and industry standards committees help define compliance requirements. As a result, you can be sure that Z-Series oscilloscope tools deliver to critical specifications. Setup wizards combined with intelligent test filtering give you confidence you're running the right tests. Comprehensive HTML reports with visual documentation and pass/fail results guarantee that critical information is retained on each test.

Quick and easy automated switching

Only Keysight's Z-Series oscilloscopes feature compliance applications with both the user-defined application's add-in capability and integrated PrecisionProbe compensation. Switch paths can vary in their characteristics and have unwanted loss. By enabling PrecisionProbe in its compliance applications, Z-Series scopes allows you to characterize and compensate for every path in the switch, making every path's frequency response identical in both magnitude and phase. These tools makes switch automation quick and painless. The Z-Series and its compliance applications make automation more automated than ever. Your technicians no longer need to spend valuable time physically changing connections.



Compliance applications make testing to today's technologies standards easy.

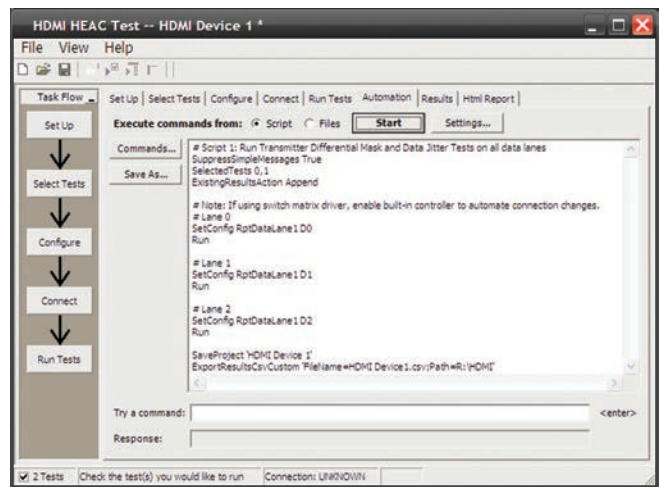

The remote programming interface makes it easy to control automation applications via your PC.



PrecisionProbe is fully integrated in Z-Series automation applications.



Compliance and Automation Testing: User-Defined Application (N5467B)

Custom automation for your Z-Series oscilloscope

The user-defined application is the only fully customizable automated environment made for an oscilloscope by an oscilloscope designer. It provides full automation, including the ability to control other Keysight instruments, external applications such as MATLAB and your DUT software.

Simplify your automation

The user-defined application (UDA) makes automation simple. The application takes the Infiniium compliance application framework and gives you full access to its interface. UDA allows for automation testing in as little as one minute. Use UDA to control other Keysight instruments such as signal generators and network analyzers to create a full suite of measurements.

Full measurement report

No automation would be complete without a simple-to-view and easy-to-understand report. UDA provides a full report of the pass/fail criteria you have provided.

Add-in capability

Ever wanted to add testing to your compliance applications? All Infiniium compliance applications support the industry's most flexible testing mechanism with UDA add-in capability. Create the custom testing you need and then plug it into your compliance application to expand the application to your testing needs. UDA add-in capability is available only on Infiniium oscilloscopes.

PrecisionProbe and switch compatibility

UDA makes automation of switches in your system simple and accurate. Use PrecisionProbe to characterize the path of the switch and then let UDA's unique GUI switch between every input in your switch system. Every input can look identical in its frequency response thanks to this advanced technology.

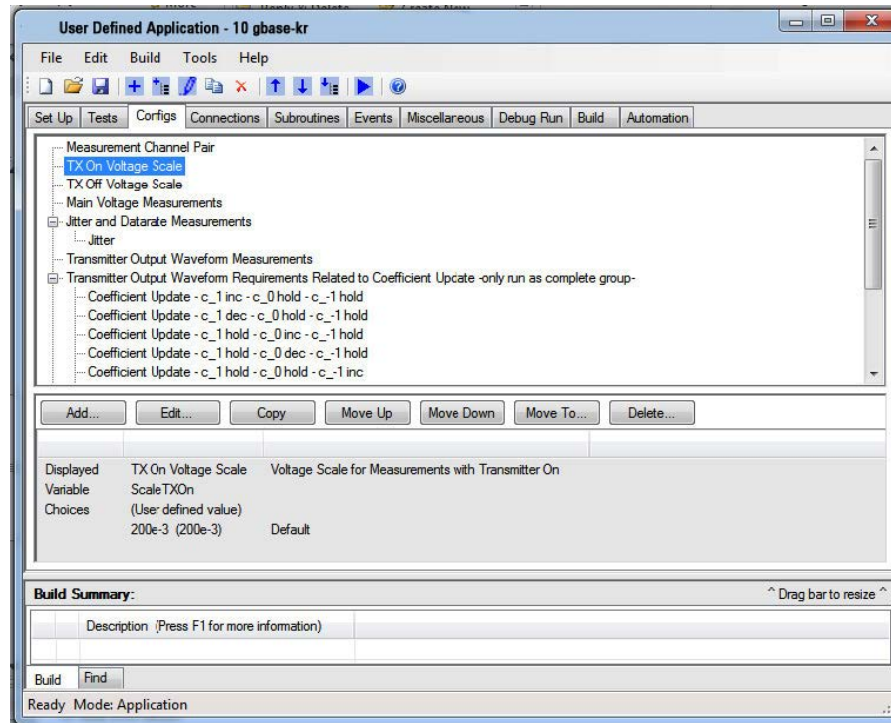

Customize your own tests and requirements with user-defined application in the familiar Keysight framework.

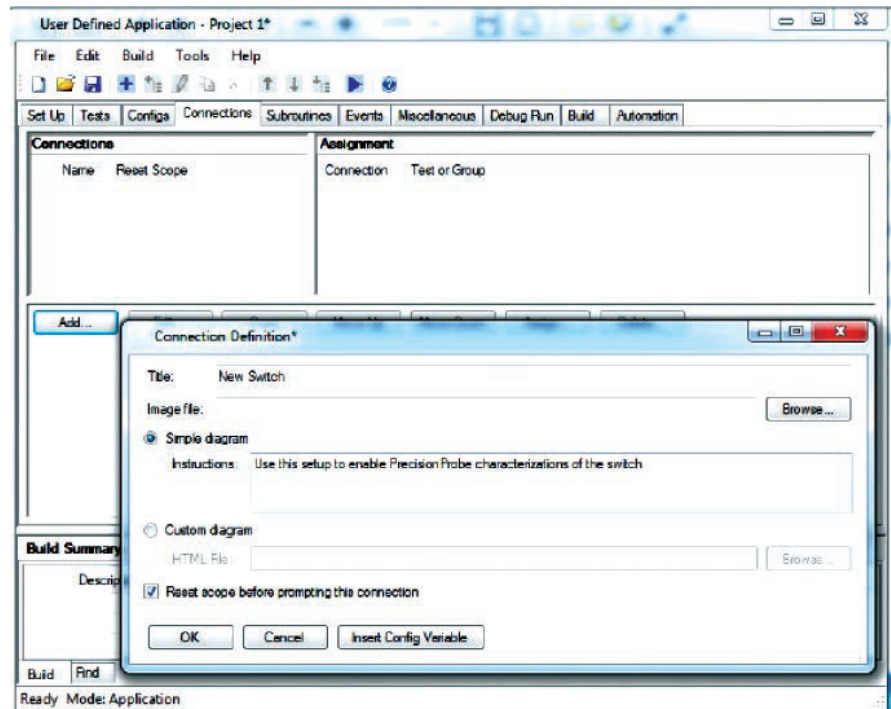

Add a switch when testing your multi-lane signals to automate tedious test requirements.



Compliance and Automation Testing: Switch Matrix Support

Comprehensive testing, easily achieved

Eliminate reconnections (reducing errors)

Compliance applications on the Z-Series support a switch matrix, making testing simple by automating tests for each lane of a multi-lane bus. Typical testing requires reconnecting the oscilloscope each time you switch a lane, which causes wasted time and inaccuracies. The Z-Series solves this problem by supporting switch matrix through its compliance test. Simply connect the switch to the oscilloscope and all the lanes, and then click Run to complete full testing of your entire device.

Maintain accuracy

The framework fully supports Keysight's PrecisionProbe software (N2809A) and InfiniiSim software (N5465A). This gives you the ability to characterize every switch path to the device under test (both magnitude and skew) and ensure that all of them maintain the same level of accuracy.

Customize your testing

Use the remote programming interface (standard feature on the Z-Series) and N5467A user-defined application for device control, instrument control and test customization.

Software description	Model number		
	Fixed ¹ Node locked	Floating ² Transportable	Server based
DisplayPort switch matrix	U7232C-7FP	U7232C-7TP	N5435A-701
HDMI switch matrix	N5399C-7FP	N5399C-7TP	N5435A-702
MIPI D-PHY switch matrix	U7238C-7FP	U7238C-7TP	N5435A-703
MIPI M-PHY switch matrix	U7249C-7FP	U7249C-7TP	N5435A-704
PCIe® switch matrix	N5393F-7FP	N5393F-7TP	N5435A-705
Ethernet KR switch matrix	N8814B-7FP	N8814B-7TP	N5435A-706
QSFP+ switch matrix	N6468A-7FP	N6468A-7TP	N5435A-707
UDA switch matrix	N5467B-7FP	N5467B-7TP	N5435A-708
100GBASE-CR10 switch matrix	N8828A-7FP	N8828A-7TP	N5435A-709
100GBASE-KR4 switch matrix	N8829A-7FP	N5435A-710	N8829A-7TP
100GBASE-CR4 switch matrix	N8830A-7FP	N8830A-7TP	N5430A-711
10GBASE-T switch matrix	N5392A-7FP	N5392A-7TP	N5430A-712

1. Factory-installed on new scope purchase or user-installed on existing scope.
2. Must be user-installed.

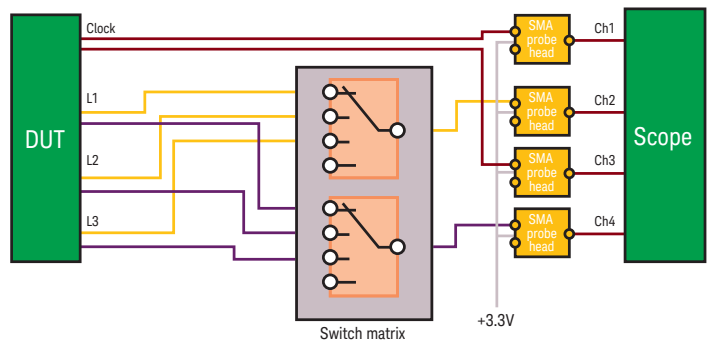

Typical switch configuration for HDMI testing (now supported in the Z-Series).

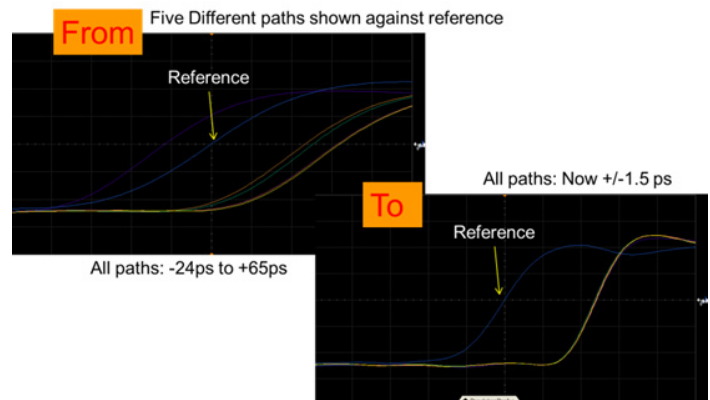

Skews between switch paths are easily maintained with Keysight's unique software.



Compliance and Automation Testing: Other Options on Z-Series Oscilloscopes

In the previous pages we have highlighted a few of the key technologies that benefit from the industry's only four-channel oscilloscope with more than 20 GHz bandwidth. The Z-Series offers over 20 compliance applications and the list continues to grow. All applications are fully compatible with InfiniiSim, PrecisionProbe and UDA's unique add-in capability.

Compliance test and validation software ¹

Description	License type		
	Fixed Factory-installed on new scope purchase or user-installed on existing scope	Floating User-installed transportable license	Server-based license
BroadR-Reach	N6467A-1FP	N6467A-1TP	N5435A-062
DDR1 and LPDDR1	U7233A-1FP	U7233A-1TP	N5435A-021
DDR2 and LPDDR2	N5413B-1FP	N5413B-1TP	N5435A-037
DDR3 and LPDDR3	U7231B-1FP	U7231B-1TP	N5435A-053
DDR4 and LPDDR4	N6462A-1FP	N6462A-1TP	N5435A-056
DisplayPort 1.2	U7232C-1FP	U7232C-1TP	N5435A-041
eDP 1.4	N6469A-1FP	N6469A-1TP	N5435A-083
eMMC	N6465A-1FP	N6465A-1TP	N5435A-061
Ethernet + EEE 10/100/1000BASE-T	N5392B-1FP	N5392B-1TP	N5435A-060
Ethernet 10GBASE-T	U7236A-1FP	U7236A-1TP	N5435A-023
Ethernet 10GBASE-KR	N8814B-1FP	N8814B-1TP	N5435A-059
Ethernet 100GBASE-CR10	N8828A-1FP	N8828A-1TP	N5435A-078
Ethernet 100GBASE-CR4	N8830A-1FP	N8830A-1TP	N5435A-080
Ethernet 100GBASE-KR4	N8829A-1FP	N8829A-1TP	N5435A-079
GDDR5	U7245A-1FP	U7245A-1TP	–
HDMI 2.0	N5399C-1FP	N5399C-1TP	N5435A-070
MHL 3.0	N6460B-1FP	N6460B-1TP	N5435A-078
MIPI D-PHY	U7238C-1FP	U7238C-1TP	N5435A-022
MIPI M-PHY	U7249C-1FP	U7249C-1TP	N5435A-043
MOST	N6466A-1FP	N6466A-1TP	N5435A-068
PCI Express Gen4	N5393F-1FP	N5393F-1TP	N5435A-112
SAS-3	N5412D-1FP	N5412D-1TP	N5435A-073
SATA Gen 3	N5411B-1FP	N5411B-1TP	N5435A-028
SFP+	N6468A-1FP	N6468A-1TP	N5435A-074
USB 2.0	N5416A-1FP	N5416A-1TP	N5435A-017
USB 3.1	U7243B-1FP	U7243B-1TP	N5435A-075
USB HSIC	U7248A-1FP	U7248A-1TP	N5435A-042
UHS-I	U7246A-1FP	U7246A-1TP	–
UHS-II	N6461A-1FP	N6461A-1TP	N5435A-052
User-defined application	N5467B-1FP	N5467B-1TP	N5435A-058
Thunderbolt	N6463B-1FP	N6463B-1TP	N5435A-057
XAUI	N5431A-1FP	N5431A-1TP	N5435A-018

1. Compliance software is not supported on DSAZ632A, DSOZ632A, DSAZ592A and DSOZ592A scope models.



Protocol Analysis

Z-Series oscilloscopes come with more than 15 protocol decoders, including the industry's only 64/66 b decoder. The Z-Series protocol tools feature time-correlated markers that let you easily move between the listing window and the waveform. Protocol tools can be used on up to four lanes simultaneously.

These unique tools feature search and trigger capability that lets you scan through the waveform to find the trigger condition that interests you. Protocol tools are fully compatible with Infiniium's serial data analysis and are available on the Infiniium offline tool.



Z-Series decoding the PCI Express Gen3 packets.



Protocol Analysis (Continued)

Protocol decode software

	License type		
	Fixed	Floating	
Optional application description	Factory-installed on new scope purchase or user-installed on existing scope	User-installed transportable license	Server-based license (N5435A option)
Protocol			
8b/10b (generic)	— ¹	— ¹	— ¹
64b/66b (10GBASE-KR)	N8815A-1FP	N8815A-1TP	N5435A-045
CAN/LIN/FlexRay/CAN-FD	N8803C-1FP	N8803C-1TP	N5435A-103
I ² S protocol triggering and decode	N8811A-1FP	N8811A-1TP	105
I ² C/SPI ²	N5391A-1FP	N5391A-1TP	N5435A-006
JTAG ²	N8817A-1FP	N8817A-1TP	N5435A-038
MIPI CSI-3	N8820A-1FP	N8820A-1TP	N5435A-065
MIPI DigRF [®] v4	N8807A-1FP	N8807A-1TP	N5435A-047
MIPI D-PHY ²	N8802A-1FP	N8802A-1TP	N5435A-036
MIPI LLI	N8809A-1FP	N8809A-1TP	N5435A-049
MIPI RFFE	N8824A-1FP	N8824A-1TP	N5435A-072
MIPI UFS	N8818A-1FP	N8818A-1TP	N5435A-063
MIPI UniPro	N8808A-1FP	N8808A-1TP	N5435A-048
SPMI protocol trigger and decode	N8845A-1FP	N8845A-2FP	N5435A-114
PCIe 1 and 2	N5463A-1FP	N5463A-1TP	N5435A-032
PCIe 3	N8816A-1FP	N8816A-1TP	N5435A-046
Generic Raw – NRZ protocol decode	— ¹	— ¹	— ¹
Generic Raw – PAM-4 protocol decode	— ³	— ³	— ³
RS-232/UART	N5462A-1FP	N5462A-1TP	N5435A-031
SATA	N8801A-1FP	N8801A-1TP	N5435A-035
SSIC	N8819A-1FP	N8819A-1TP	N5435A-064
SVID ²	N8812A-1FP	N8812A-1TP	N5435A-054
USB 2.0	N5464A-1FP	N5464A-1TP	N5435A-034
USB 3.0	N8805A-1FP	N8805A-1TP	N5435A-071

1. Standard on DSA models or with high-speed SDA option.
2. Compliance software is not supported on DSAZ632A, DSOZ632A, DSAZ592A, and DSOZ592A scope models.
3. Requires PAM-4 compliance app and SDA option (firmware 6.0 and up).



Achieve New Extremes

Configure your high-performance real-time oscilloscope solution today

Get the most out of your oscilloscope investment by choosing options and software to speed your most common tasks. Use option numbers when ordering at time of purchase. Use model numbers to add to an existing scope.

1. Choose your oscilloscope

Oscilloscope	Description
DSOZ634A	63-GHz digital storage oscilloscope
DSAZ634A	63-GHz digital signal analyzer ¹
DSOZ632A	63-GHz digital storage oscilloscope
DSAZ632A	63-GHz digital signal analyzer ¹
DSOZ594A	59-GHz digital storage oscilloscope
DSAZ594A	59-GHz digital signal analyzer ¹
DSOZ592A	59-GHz digital storage oscilloscope
DSAZ592A	59-GHz digital signal analyzer ¹
DSOZ504A	50-GHz digital storage oscilloscope
DSAZ504A	50-GHz digital signal analyzer ¹
DSOZ334A	33-GHz digital storage oscilloscope
DSAZ334A	33-GHz digital signal analyzer ¹
DSOZ254A	25-GHz digital storage oscilloscope
DSAZ254A	25-GHz digital signal analyzer ¹
DSOZ204A	20-GHz digital storage oscilloscope
DSAZ204A	20-GHz digital signal analyzer ¹

1. DSA models come standard with 100 Mpts memory, EZJIT Complete and Serial Data Analysis software.

All models come with a front cover, power cord, keyboard, mouse, 3.5 mm male-to-male calibration cable (54916-61626), 3.5 mm (male) to 2.4 mm (male) calibration cable (54932-61630), ESD strap, and (5) 3.5 mm female-to-female coax adapters (5061-5311). 50, 59, and 63 GHz models come with (2) additional 1.85 female-to-female adapters (54932-68712).

All models come standard with removable SSD hard drive.

Memory options

Memory per scope channel	Options (on new oscilloscope)
100 Mpts/ch memory	DSOZ000-100 ²
200 Mpts/ch memory	DSOZ000-200
500 Mpts/ch memory	DSOZ000-500
1 Gpt/ch memory	DSOZ000-01G
2 Gpts/ch memory	DSOZ000-02G

Description	Options	Model number
ANSI Z540 compliant calibration	DSOZ000-A6J	—
ISO17025 calibration	DSOZ000-1A7	—
Performance verification de-skew fixture for InfiniiMax III probe	—	N5443A
Rack mount kit option	—	N2759A
Transit case	—	N2748A
Removable SSD with Windows 7 for Z-Series - 1 TB	DSOZ000-801	N2110A-01T
Removable SSD with Windows 7 for Z-Series - 500 GB ³	—	N2110A-500
Optional synchronization port for 20, 25, 33 GHz models	DSOZ000-601	—

2. Standard on DSA models.

3. 500G SSD standard on all models.



Achieve New Extremes (Continued)

Configure your high-performance real-time oscilloscope solution today

2. Choose your probes and accessories

Probe amplifier

Description	Model number
30 GHz InfiniiMax III probe amplifier	N2803A
25 GHz InfiniiMax III probe amplifier	N2802A
20 GHz InfiniiMax III probe amplifier	N2801A
16 GHz InfiniiMax III probe amplifier	N2800A
20 GHz InfiniiMax III+ probe amplifier ¹	N7003A
16 GHz InfiniiMax III+ probe amplifier ¹	N7002A
13 GHz InfiniiMax III+ probe amplifier ¹	N7001A
8 GHz InfiniiMax III+ probe amplifier ¹	N7001A

Probe head

Description	Model number
16 GHz QuickTip probe head ²	N2848A
QuickTip probe tip (set of 4) ²	N2849A
16 GHz solder-in probe head	N5441A
26 GHz solder-in probe head ²	N2836A
28 GHz Zero Insertion Force (ZIF) probe head	N5439A
200 Ω ZIF tip for high sensitivity ³	N5447A
25 GHz PC board ZIF tip (for normal sensitivity)	N2838A
30 GHz browser probe head	N5445A
Browser tip replacement (set of 4)	N5476A
28 GHz 3.5 mm/2.92 mm/SMA probe head ²	N5444A

Probe adapter

Description	Model number
30 GHz voltage termination adapter (50 Ω – 3.5 mm (f) to (m) connector)	N7010A
Performance verification and deskew fixture	N5443A
Precision BNC adapter (50 Ω – 3.5 mm (f) to precision BNC (f) connector)	N5442A
Sampling scope adapter (50 Ω – 3.5 mm (f) to (m) connector)	N5477A
High-impedance probe adapter (includes one N2873A passive probe)	N5449A

For more information about Infiniium Oscilloscope Probes and Accessories - Data Sheet, view the Keysight publication number 5968-7141EN.

For more information about InfiniiMax III/III+ Probing System - Data Sheet, view the Keysight publication number 5990-5653EN.

1. With InfiniiMode technology, allowing you to switch to differential, single-ended, and common mode without adjusting probe tip connections.
2. Probe head that supports InfiniiMode connections.
3. Compatible only with InfiniiMax III probe amplifier.



Achieve New Extremes (Continued)

3. Upgrade your oscilloscope

Model numbers	Description
	Upgrades within the Z-Series family
N2764BU-025	Bandwidth upgrade from 20 to 25 GHz
N2764BU-033	Bandwidth upgrade from 25 to 33 GHz
N2764BU-050	Bandwidth upgrade from 33 to 50 GHz
N2764BU-059	Bandwidth upgrade from 50 to 59 GHz
N2764BU-062	Bandwidth upgrade from 50 to 63 GHz
N2764BU-162	Bandwidth upgrade from 59 to 63 GHz

Note: All except 50 to 59 GHz and 50 to 63 GHz upgrades require return to Service Center but do not include Service Center costs. Calibration incurs additional charges.

Model number to upgrade	Memory per scope channel existing oscilloscope (post-sale)
N2810A-100	Upgrade from 50 to 100 Mpts/channel
N2810A-200	Upgrade from 100 to 200 Mpts/channel
N2810A-500	Upgrade from 200 to 500 Mpts/channel
N2810A-01G	Upgrade from 500 Mpts to 1 Gpts/channel
N2810A-02G	Upgrade from 1 to 2 Gpts/channel

Number of channels

Model numbers	Description
	Upgrades within the Z-Series family
N2128A	Number of channel upgrade from 1-channel to 2-channel 59 or 63 GHz and 2-channel to 4-channel 33 GHz

Note: Only applies to Infiniium Z-Series models DSAZ632A, DSOZ632A, DSAZ592A, and DSOZ592A. No return to service center is required. Upgrade is software only.

Multi-frame options

Model numbers	Description
	Upgrades within the Z-Series family
N2107A	Infiniium Z-Series multi-frame expansion kit from five to six frames
N2106A	Infiniium Z-Series multi-frame expansion kit for adding one frame
N2105A	Infiniium Z-Series multi-frame base kit for stacking two frames
N2109AU	Infiniium Z-Series sync port upgrade kit for 20 to 33 GHz models (> 33 GHz not needed)



Specifications

Vertical	Z204A	Z254A	Z334A	Z504A	Z592A	Z594A	Z632A	Z634A
Typical analog bandwidth (3 dB)	20 GHz	25 GHz	33 GHz	50 GHz	59 GHz	59 GHz	63 GHz	63 GHz
Analog bandwidth (3 dB) *	20 GHz	25 GHz	32 GHz	50 GHz	59 GHz	59 GHz	62 GHz	62 GHz
1-channel sample rate	80 GSa/s	80 GSa/s	80 GSa/s	160 GSa/s	160 GSa/s	160 GSa/s	160 GSa/s	160 GSa/s
2-channel sample rate	80 GSa/s	80 GSa/s	80 GSa/s	160 GSa/s	80 GSa/s	160 GSa/s	80 GSa/s	160 GSa/s
4-channel sample rate	80 GSa/s	80 GSa/s	80 GSa/s	80 GSa/s	–	80 GSa/s	–	80 GSa/s
Rise time/fall time	Z204A	Z254A	Z334A	Z504A	Z592A	Z594A	Z632A	Z634A
10 to 90% ⁴	22.0 ps	17.6 ps	13.3 ps	8.8 ps	7.5 ps	7.5 ps	7.0 ps	7.0 ps
20 to 80% ⁵	15.6 ps	12.4 ps	9.4 ps	6.2 ps	5.3 ps	5.3 ps	4.9 ps	4.9 ps
Input impedance ³	50 Ω, ± 3%							
Sensitivity ²	1 mV/div to 1 V/div							
Input coupling	DC							
Vertical resolution ¹	8 bits, ≥ 12 bits with averaging							
Channel to channel isolation (any two channels with equal V/div settings)	RealEdge (1.85 mm) channels DC to 40 GHz: 70 dB 40 GHz to BW: 60 dB Standard (3.5 mm) channels DC to BW: 70 dB							
DC gain accuracy *	± 2% of full scale at full resolution channel scale (± 2.5% for 5 mV/div)							
Maximum input voltage	± 5 V for steady state and transient measurements							
Offset range	Vertical sensitivity	Available offset		Available offset (oscilloscope with N7010A voltage termination adapter)				
	1 to 49 mV/div	± 0.4 V		± 4 V				
	50 to 79 mV/div	± 0.7 V		± 4 V				
	80 to 134 mV/div	± 1.2 V		± 4 V				
	135 to 239 mV/div	± 2.2 V		± 4 V				
	240 mV/div to 1 V/div	± 4.0 V		± 4 V				
Offset accuracy *	≤ 3.5 V: ± (2% of channel offset + 1% of full scale) + 1 mV > 3.5 V: ± (2% of channel offset + 1% of full scale)							
Dynamic range	± 4 div from center screen							
DC voltage measurement accuracy	Dual cursor: ± [(DC gain accuracy) + (resolution)] Single cursor: ± [(DC gain accuracy) + (offset accuracy) + (resolution/2)]							
RMS noise floor (scope only)	Z204A	Z254A	Z334A	Z504A	Z594A, Z592A		Z634A, Z632A	
Volts/div								
10 mV	0.41 mV (rms)	0.48 mV (rms)	0.60 mV (rms)	0.90 mV (rms)	0.96 mV (rms)		1.0 mV (rms)	
50 mV	1.46 mV (rms)	1.7 mV (rms)	2.00 mV (rms)	2.90 mV (rms)	3.15 mV (rms)		3.3 mV (rms)	
100 mV	2.90 mV (rms)	3.3 mV (rms)	3.90 mV (rms)	5.70 mV (rms)	6.2 mV (rms)		6.4 mV (rms)	
1 V	28.6 mV (rms)	32.5 mV (rms)	38.1 mV (rms)	56.7 mV (rms)	60 mV (rms)		63 mV (rms)	

* Denotes warranted specifications, all others are typical. Specifications are valid after a 30-minute warm up period, and ± 5 °C from annual calibration temperature.

- Vertical resolution for 8 bits = 0.4% of full scale, for 12 bits = 0.024% of full scale.
- Full scale is defined as 8 vertical divisions. Magnification is used below 7.5 mV/div. Below 7.5 mV/div, full-scale is defined as 60 mV/div. The major scale settings are 5 mV, 10 mV, 20 mV, 50 mV, 100 mV, 200 mV, 500 mV, and 1 V.
- Input impedance is valid when V/div scaling is adjusted to show all waveform vertical values within scope display.
- Rise time calculated by using $0.44/BW$ for (10 to 90%) rise time.
- Rise time calculated by using $0.31/BW$ for (20 to 80%) rise time.



Specifications (Continued)

Horizontal

Horizontal system: Oscilloscope channels			
Main timebase range	2 ps/div to 200 s/div		
Main timebase delay range	0 s ± 200 s real time		
Reference position	Continuously adjustable across horizontal display range		
Zoom timebase range	1 ps/div to current main time scale setting		
Time scale accuracy ^{1,8}	± (0.1 ppm initial + 0.1 ppm/year aging)		
Oscilloscope channel de-skew range	± 1 ms range, 10 fs resolution		
Intrinsic jitter ⁶ (Sample clock jitter)	Acquired time range or delta-time interval	Internal reference	External reference
	< 10 μs (1 μs/div)	50 fs rms 75 fs rms	50 fs rms 75 fs rms (Z502A/Z592A/Z632A) (Z204A/Z254A/Z334A)
	100 μs (10 μs/div)	75 fs rms	75 fs rms
	1 ms (100 μs/div)	100 fs rms	100 fs rms
	10 ms (1 ms/div)	150 fs rms	125 fs rms
	100 ms (10 ms/div)	200 fs rms	150 fs rms
	1 s (100 ms/div)		150 fs rms
Inter-channel intrinsic jitter ³	< 50 fs rms		
Inter-channel skew drift ^{3,7}	< 50 fs rms		
Jitter measurement floor ²			
– Time interval error	$\sqrt{\left(\frac{\text{Noise Floor}}{\text{Slew Rate}}\right)^2 + (\text{Intrinsic Jitter})^2}$		
– Period jitter	$\sqrt{2} \cdot \sqrt{\left(\frac{\text{Noise Floor}}{\text{Slew Rate}}\right)^2 + (\text{Intrinsic Jitter})^2}$		
– Cycle-cycle/N-cycle jitter	$\sqrt{3} \cdot \sqrt{\left(\frac{\text{Noise Floor}}{\text{Slew Rate}}\right)^2 + (\text{Intrinsic Jitter})^2}$		
Inter-channel jitter measurement floor ^{2,3,5}	$\sqrt{\left(\frac{\text{Time Interval}}{\text{Error (Edge1)}}\right)^2 + \left(\frac{\text{Time Interval}}{\text{Error (Edge2)}}\right)^2 + \left(\frac{\text{Inter channel}}{\text{Intrinsic Jitter}}\right)^2}$		

- Denotes warranted specifications, all others are typical. Specifications are valid after a 30-minute warm-up period and ± 5 °C from firmware calibration temperature.
- Sample rate at maximum. Noise and slew rate determined at fixed-voltage measurement threshold, near middle of signal. Displayed signal not vertically clipped. Slew rate of sine wave = (peak signal amplitude) · 2 · π · f, slew rate of fast step ~ (10 to 90% rise time).
- Intra-channel = both edges on the same channel, inter-channel = two edges on different channels. Time Interval Error(Edge1) = time-interval error measurement floor of first edge, Time Interval Error(Edge2) = time-interval error measurement floor of second edge.
- Reading is the displayed Delta Time Measurement Accuracy measurement value. Do not double the listed Time Scale Accuracy value in Delta Time Measurement Accuracy formula.
- Scope channels and signal interconnect de-skewed prior to measurement.
- External timebase reference values measured using a Wenzel 501-04608A 10 MHz reference. Intrinsic jitter value depends on acquisition time range for Time Interval Error formula and depends on delta-time between edges for all two-edge formulas.
- Skew between channels caused by ± 5 °C temperature change.
- Initial = immediately after factory or user calibration.



Specifications (Continued)

Horizontal (Continued)

Horizontal system: Oscilloscope channels (Continued)

Delta time measurement accuracy ^{2,3,4,5}

– Intra-channel

– No averaging

$$\pm \left[5 \cdot \sqrt{\left(\frac{\text{Time Interval}}{\text{Error (Edge1)}} \right)^2 + \left(\frac{\text{Time Interval}}{\text{Error (Edge2)}} \right)^2} + \left(\frac{\text{Time Scale}}{\text{Accuracy}} \right) \cdot (\text{Delta}) \right]$$

– 256 averages

$$\pm \left[\frac{5}{16} \cdot \sqrt{\left(\frac{\text{Time Interval}}{\text{Error (Edge1)}} \right)^2 + \left(\frac{\text{Time Interval}}{\text{Error (Edge2)}} \right)^2} + \left(\frac{\text{Time Scale}}{\text{Accuracy}} \right) \cdot (\text{Delta}) \right]$$

– Inter-channel

– No averaging

$$\pm \left[5 \cdot \sqrt{\left(\frac{\text{Time Interval}}{\text{Error (Edge1)}} \right)^2 + \left(\frac{\text{Time Interval}}{\text{Error (Edge2)}} \right)^2 + \left(\frac{\text{Inter channel}}{\text{Intrinsic Jitter}} \right)^2} + \left(\frac{\text{Time Scale}}{\text{Accuracy}} \right) \cdot (\text{Delta}) + \left(\frac{\text{Inter channel}}{\text{Skew Drift}} \right) \right]$$

– 256 averages

$$\pm \left[\frac{5}{16} \cdot \sqrt{\left(\frac{\text{Time Interval}}{\text{Error (Edge1)}} \right)^2 + \left(\frac{\text{Time Interval}}{\text{Error (Edge2)}} \right)^2 + \left(\frac{\text{Inter channel}}{\text{Intrinsic Jitter}} \right)^2} + \left(\frac{\text{Time Scale}}{\text{Accuracy}} \right) \cdot (\text{Delta}) + \left(\frac{\text{Inter channel}}{\text{Skew Drift}} \right) \right]$$

- Sample rate at maximum. Noise and slew rate determined at fixed-voltage measurement threshold, near middle of signal. Displayed signal not vertically clipped. Slew rate of sine wave = (peak signal amplitude) · 2 · π · f, slew rate of fast step ~ (10 to 90% rise time).
- Intra-channel = both edges on the same channel, inter-channel = two edges on different channels. Time Interval Error(Edge1) = time-interval error measurement floor of first edge, Time Interval Error(Edge2) = time-interval error measurement floor of second edge.
- Reading is the displayed Delta Time Measurement Accuracy measurement value. Do not double the listed Time Scale Accuracy value in Delta Time Measurement Accuracy formula.
- Scope channels and signal interconnect de-skewed prior to measurement.



Specifications (Continued)

Acquisition	Z204A, Z254A, Z334A	Z592A, Z632A	Z504A, Z594A, Z634A					
Maximum real-time sample rate								
1 channels	80 GSa/s	160 GSa/s	160 GSa/s					
2 channels	80 GSa/s	80 GSa/s	160 GSa/s					
4 channels	80 GSa/s	–	80 GSa/s					
Memory depth per channel								
	4 channels (Z204A, Z254A, Z334A, Z504A, Z594A, Z634A) and 2 channels (Z592A, Z632A)		2 channels (Z204A, Z254A, Z334A, Z504A, Z594A, Z634A) and 1 channel (Z592A, Z632A)					
Standard	50 Mpts		100 Mpts					
Option 100	100 Mpts (standard on DSA models)		200 Mpts (standard on DSA models)					
Option 200	200 Mpts		400 Mpts					
Option 500	500 Mpts		1 Gpt					
Option 01G	1 Gpt		1 Gpt					
Option 02G	2 Gpts		2 Gpts					
Maximum acquired time at highest real-time resolution								
Real-time resolution	80 GSa/s		160 GSa/s					
Resolution	12.5 ps		6.25 ps					
Standard (20 M)	0.25 ms		0.125 ms					
Option 50 M	0.625 ms		0.3125 ms					
Option 100	1.25 ms		0.625 ms					
Option 200	2.5 ms		1.25 ms					
Option 500	6.25 ms		3.125 ms					
Option 01G	12.5 ms		6.25 ms					
Option 02G	25 ms		12.5 ms					
Sampling modes								
Real-time	Successive single shot acquisitions							
Real-time with averaging	Selectable from 2 to 65534 (Up to 200,000 with function)							
Real-time with peak detect	80 GSa/s (Unavailable on RealEdge channels)							
Real-time with hi resolution	Real-time boxcar averaging reduces random noise and increases resolution (unavailable on RealEdge channels)							
Equivalent time	Resolution 338 fs							
Gaussian magnitude, linear phase	Slower filter roll off while maintaining linear phase							
Roll mode	Scrolls sequential waveform points across the display in a right-to-left rolling motion. Works at sample rates up to 10 MSa/s with a maximum record length of 40 Mpts							
Segmented memory	Captures bursting signals at max sample rate without consuming memory during periods of inactivity Maximum time between triggers is 562,950 seconds Re-arm time: 2.5 μ s							
	Memory depth:	20 M	50 M	100 M	200 M	500 M	1 G	2 G
	Max # of segments:	4096	8192	16384	32768	65536	131072	131072
Filters								
Sin(x)/x Interpolation	On/off selectable FIR digital filter (2x, 4x, 8x, 16x settings). Digital signal processing adds points between acquired data points to enhance measurement accuracy and waveform display							



Specifications (Continued)

Hardware trigger	
Sensitivity	Internal low: 2.0 div p-p 0 to 22 GHz Internal high: 0.3 div p-p 0 to 18 GHz, 1.0 div p-p 0 to 22 GHz
Edge trigger bandwidth (Ch1 to Ch4)	> 20 GHz
Edge trigger bandwidth (AUX)	400 MHz
Minimum pulse width trigger	
Hardware	250 ps
Software (InfiniiScan)	40 ps
Level range	
Internal	± 4 div from center screen or ± 4 V, whichever is smaller
Auxiliary	± 5 V, also limit input signal to ± 5 V
Sweep modes	Auto, triggered, single
Display jitter ^{2,3,4} (Trigger jitter)	170 fs rms
Trigger sources	Channel 1, Channel 2, Channel 3, Channel 4
Trigger modes	
Edge	Triggers on a specified slope (rising, falling or alternating between rising and falling) and voltage level on any channel or auxiliary trigger. Edge trigger bandwidth is > 20 GHz
Edge transition	Trigger on rising or falling edges that cross two voltage levels in > or < the amount of time specified. Edge transition setting from 250 ps
Edge then edge (Time)	The trigger is qualified by an edge. After a specified time delay between 10 ns to 10 s, a rising or falling edge on any one selected input will generate the trigger
Edge then edge (Event)	The trigger is qualified by an edge. After a specified delay between 1 to 16,000,000 rising or falling edges, another rising or falling edge on any one selected input will generate the trigger
Glitch	Triggers on glitches narrower than the other pulses in your waveform by specifying a width less than your narrowest pulse and a polarity. Triggers on glitches as narrow as 125 ps. Glitch range settings: < 250 ps to < 10 s
Pulse width	Trigger on a pulse that is wider or narrower than the other pulses in your waveform by specifying a pulse width and a polarity. Triggers on pulse widths as narrow as 125 ps. Pulse width range settings 250 ps to 10 s. Trigger point can be "end of pulse" or "time out"
Runt	Triggers on a pulse that crosses one threshold but fails to cross a second threshold before crossing the first again. Can be time qualified with minimum setting of 250 ps

1. Denotes warranted specifications, all others are typical. Specifications are valid after a 30-minute warm-up period and ± 5 °C from firmware calibration temperature.
2. Internal edge trigger mode with JitterFree correction. Value depends on scope settings and trigger signal characteristics, and is equal to Time Interval Error value expressed in the formula above using the minimum Time Scale Accuracy value.
3. Value shown represents typical Display jitter for DSOZ334A at 100 mV/div triggering on 500 mVpp 16 GHz sin wave signal.
4. Sample rate at maximum. Noise and slew rate determined at fixed-voltage trigger threshold, near middle of signal. Displayed signal not vertically clipped.



Specifications (Continued)

Hardware trigger (Continued)	
Timeout	Trigger when a channel stays high, low, or unchanged for too long. Timeout setting: from 250 ps to 10 s
Pattern/pulse range	Triggers when a specified logical combination of the channels is entered, exited, present for a specified period of time or is within a specified time range or times out. Each channel can have a value of High (H), Low (L) or Don't care (X)
State	Pattern trigger clocked by the rising, falling or alternating between rising and falling edge of one channel
Window	Triggers on an event associated with a window defined by two-user adjustable thresholds. Event can be window "entered," "exited," "inside (time qualified)," or "outside (time qualified)" voltage range. Trigger point can be "cross window boundary" or "time out." Time qualify range: from 250 ps to 10 s
Video	Triggers from negative sync composite video, field 1, field 2, or alternating fields for interlaced systems, any field, specific line, or any line for interlaced or non-interlaced systems. Supports NTSC, PAL-M (525/60), PAL, SECAM (625/50), EDTV (480p/60), EDTV (576p/50), HDTV (720p/60), HDTV (720p/50), HDTV (1080i/60), HDTV (1080i/50), HDTV (1080p/60), HDTV (1080p/50), HDTV (1080p/30), HDTV (1080p/25), HDTV (1080p/24), and user-defined formats
Trigger sequences	Three-stage trigger sequences including two-stage hardware (Find event (A) and Trigger event (B)) and one-stage InfiniiScan software trigger. Supports all hardware trigger modes except "edge then edge" and "video," and all InfiniiScan software trigger modes. Supports "delay (by time)" and "reset (by time or event)" between two hardware sequences. The minimum latency between "find event (A)" and "trigger event (B)" is 3 ns
Trigger qualification and qualifier	Single or multiple channels may be logically qualified with any other trigger mode
Trigger holdoff range	100 ns to 10 s
Trigger actions	Specify an action to occur and the frequency of the action when a trigger condition occurs. Actions include email on trigger and execute "multipurpose" user setting
Software trigger (Requires N5414B InfiniiScan event identification software - Option 009)	
Trigger modes	
Zone qualify	Software triggers on the user-defined zones on screen. Zones can be specified as either "must intersect" or "must not intersect." Up to eight zones can be defined across multiple channels
Generic serial	Software triggers on NRZ-encoded data up to 8.0 Gbps, up to 80-bit pattern. Support multiple clock data recovery methods including constant frequency, 1st-order PLL, 2nd-order PLL, explicit clock, explicit 1st-order PLL, explicit 2nd-order PLL, Fibre Channel, FlexRay receiver, FlexRay transmitter (requires E2688A except for the constant frequency clock data recovery mode)
Measurement limit	Software triggers on the results of the measurement values. For example, when the "pulse width" measurement is turned on, InfiniiScan measurement software trigger triggers on a glitch as narrow as 40 ps. When the "time interval error (TIE)" is measured, InfiniiScan can trigger on a specific TIE value
Non-monotonic edge	Software triggers on the non-monotonic edge. The non-monotonic edge is specified by setting a hysteresis value
Runt	Software triggers on a pulse that crosses one threshold but fails to cross a second threshold before crossing the first again. Unlike hardware runt trigger, InfiniiScan runt trigger can be further qualified via a hysteresis value



Specifications (Continued)

Hardware trigger (Continued)	
Maximum measurement update rate	> 50,000 measurement/sec (one measurement turned on) > 250,000 measurement/sec/measurement (ten measurements turned on)
Measurement modes	Standard, Measure all edges mode
Waveform measurements	
Voltage	Peak to peak, minimum, maximum, average, RMS, amplitude, base, top, overshoot, preshoot, upper, middle, lower, Vovershoot, Vtime, Vpreshoot, crossing, pulse base, pulse amplitude, pulse top, PAM level mean ² , PAM level RMS ² , PAM level skew ² , PAM level thickness ²
Time	Rise time, fall time, positive width, negative width, burst width, burst period, burst interval, Tmin, Tmax, Tvolt, + pulse count, - pulse count
Clock	Period, frequency, duty cycle to duty cycle, phase, N-period
Data	Setup time, hold time
Mixed	Area, slew rate
Frequency domain	FFT frequency, FFT magnitude, FFT delta frequency, FFT delta magnitude, peak detect mode
Level qualification	Any channels that are not involved in a measurement can be used to level-qualify all timing measurements
Eye-diagram measurements	
Jitter analysis measurements	Requires Option 002 (or E2681A), 004 (N5400A), or 070 (N8823A). Standard on DSA Series
Clock	Time interval error, N-period, period to period, positive width to positive width, neg width to neg width, and duty cycle to duty cycle
Data	Time interval error, unit interval, N Unit Interval, unit interval to unit interval, data rate, CDR, de-emphasis
Statistics	
	Displays the current, mean, minimum, maximum, range (max-min), standard deviation, number of measurements value for the displayed automatic measurements
Histograms	
Source	Waveform or measurement
Orientation	Vertical (for timing and jitter measurements) or horizontal (noise and amplitude change) modes, regions are defined using waveform markers
Measurements (available as a function)	Mean, standard deviation, mean ± 1 , 2, and 3 sigma, median, mode, peak-to-peak, min, max, total hits, peak (area of most hits), X scale hits, and X offset hits
Mask testing	
	Allows pass/fail testing to user-defined or Keysight-supplied waveform templates. Automask lets you create a mask template from a captured waveform and define a tolerance range in time/voltage or screen divisions. Test modes (run until) include test forever, test to specified time or event limit, and stop on failure. Executes "multipurpose" user setting on failure
	"Unfold real-time eye" feature allows individual bit errors to be observed by unfolding a real-time eye when clock recovery is on
	Communications mask test kit option provides a set of ITU-T G.703, ANSI T1.102, and IEEE 802.3 industry-standard masks for compliance testing
Waveform math	
Number of functions	Sixteen
Hardware accelerated math operations	Differential and Common Mode Absolute value, add, amplitude demodulation (radar envelope), average, Butterworth ¹ , common mode, delay, differentiate, divide, FFT magnitude, FFT, phase, FIR ¹ , high pass filter, histogram, horizontal gating, integrate, invert, LFE ¹ , low pass filter (4th-order Bessel Thompson filter), magnify, max, measurement trend, min, multiply, RT Eye ¹ , smoothing, SqrtSumOfSquare ¹ , square, square root, subtract, versus, and optional user defined function (Option 010)
FFT	
Frequency range	DC to 80 GHz (at 160 GSa/s) or 40 GHz (at 80 GSa/s) or 20 GHz (at 40 GSa/s)
Frequency resolution	Sample rate/memory depth = resolution
Window modes	Hanning, flattop, rectangular, Blackman-Harris, Hamming

1. Requires EZJIT Plus (Option N5400A) or EZJIT Complete (Option N8823A) software.

2. Requires PAM-4 analysis (Option N8827A) software.



Specifications (Continued)

Hardware trigger (Continued)	
Measurement modes	
Automatic measurements	Measure menu access to all measurements, up to 20 measurements can be displayed simultaneously
Multipurpose	Front-panel button activates up to ten pre-selected or up to ten user-defined automatic measurements
Drag-and-drop measurement toolbar	Measurement toolbar with common measurement icons that can be dragged and dropped onto the displayed waveforms
Marker modes	Manual markers, track waveform data, track measurements
Bookmarks and callouts	Supports callouts for measurements and FFT peaks. Supports bookmarks for team collaboration
Display	
Display	15.4-inch color XGA TFT-LCD with capacitive touch screen
Intensity grayscale	256-level intensity-graded display
Resolution XGA	1024 pixels horizontally x 768 pixels vertically
Annotation	Up to 100 bookmarks can be inserted into the waveform window. Each can float or be tied to a specific waveform
Grids	Choose between 1-16 grids per waveform area, 8 bit vertical resolution
Waveform styles	Connected dots, dots, infinite persistence, color graded infinite persistence. Includes up to 256 levels of intensity-graded waveforms., variable persistence
Waveform area	Supports eight waveform areas plus chart mode for EZJIT Plus, InfiniiSim, protocol, and PrecisionProbe
Maximum update rate	> 400,000 waveforms per second (when in the segment memory mode)
Computer system and peripherals, I/O ports	
Computer system and peripherals	
Operating system	Windows 7 64-bit
CPU	Intel i5-3550S quad-core CPU at 3.00 GHz
PC system memory	16 GB DDR3 RAM
Drives (SSD)	500-GB internal hard drive removable hard drive, additional hard drives (N2110A)
Peripherals	Logitech optical USB mouse, compact USB keyboard supplied. All Infiniium models support any Windows-compatible input device with a serial, PS/2 or USB interface.
File types	
Waveforms	Compressed internal format (*.wfm (200 Mpts)), comma-separated values (*.csv (2 Gpts)), tab-separated values (*.tsv (2 Gpts)), public binary format (.bin (500 Mpts)), Y value files (*.txt (2 Gpts)), hierarchal data file (*.h5 (2 Gpts)), composite data file (*.osc (2 Gpts))
Images	BMP, PNG, TIFF, GIF, JPEG or osc file format
I/O ports	RS-232 (serial), parallel, PS/2, USB 2.0 hi-speed (host), USB 2.0 hi-speed (device), VGA, DisplayPort, USB 3.0, dual-monitor video output, auxiliary output, trigger output, time base reference output



Specifications (Continued)

General characteristics	
Temperature	Operating: 5 to +40 °C; Non-operating: -40 to +65 °C
Humidity	Operating: Up to 95% relative humidity (non-condensing) at +40 °C Non-operating: Up to 90% relative humidity at +65 °C
Altitude	Operating: Up to 4,000 meters (12,000 feet); Non-operating: Up to 15,300 meters (50,000 feet)
Vibration	Operating random: 0.021 g (rms) Non-operating random: 2.0 g (rms) Swept sines: (0.50 g)
Power	100 to 240 VAC ± 10% at 50/60 Hz Maximum input power 1350 W Well-regulated power is required for 100 to 120 VAC operation
Weight	32.2 kg (71 lbs)
Dimensions	Height: 33.8 cm (13.3 in); Width: 50.8 cm (20 in); Depth: 49.3 cm (19.4 in)
Safety	CAN/CSA-C22.2 No. 61010-1-04 UL Std. No. 61010-1 (2nd Edition)

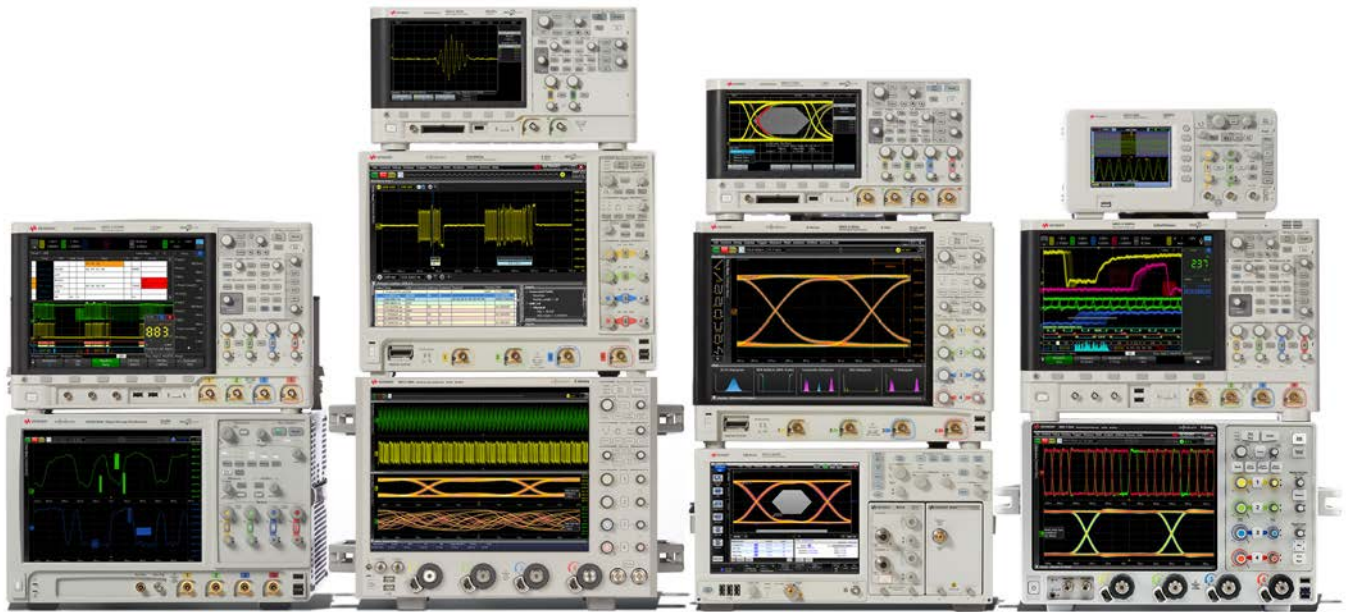

Keysight Oscilloscopes

Multiple form factors from 20 MHz to > 90 GHz | Industry leading specs | Powerful applications





www.axistandard.org

AdvancedTCA® Extensions for Instrumentation and Test (AXIe) is an open standard that extends the AdvancedTCA for general purpose and semiconductor test. The business that became Keysight was a founding member of the AXIe consortium. ATCA®, AdvancedTCA®, and the ATCA logo are registered US trademarks of the PCI Industrial Computer Manufacturers Group.



www.lxistandard.org

LAN eXtensions for Instruments puts the power of Ethernet and the Web inside your test systems. The business that became Keysight was a founding member of the LXI consortium.



www.pxisa.org

PCI eXtensions for Instrumentation (PXI) modular instrumentation delivers a rugged, PC-based high-performance measurement and automation system.

Download your next insight

Keysight software is downloadable expertise. From first simulation through first customer shipment, we deliver the tools your team needs to accelerate from data to information to actionable insight.



- Electronic design automation (EDA) software
- Application software
- Programming environments
- Productivity software

Learn more at

www.keysight.com/find/software

Start with a 30-day free trial.

www.keysight.com/find/free_trials



Evolving Since 1939

Our unique combination of hardware, software, services, and people can help you reach your next breakthrough. We are unlocking the future of technology.
 From Hewlett-Packard to Agilent to Keysight.

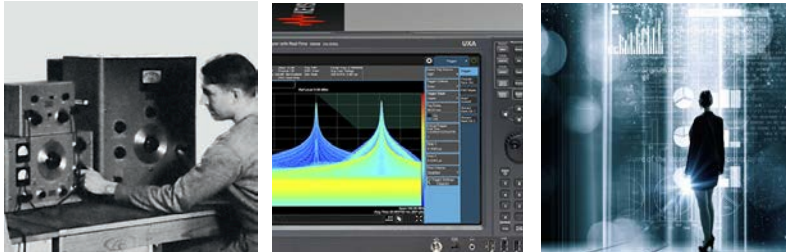

myKeysight

myKeysight
www.keysight.com/find/mykeysight
 A personalized view into the information most relevant to you.

KEYSIGHT SERVICES

*Accelerate Technology Adoption.
 Lower costs.*

Keysight Services
www.keysight.com/find/service
 Keysight Services can help from acquisition to renewal across your instrument's lifecycle. Our comprehensive service offerings—one-stop calibration, repair, asset management, technology refresh, consulting, training and more—helps you improve product quality and lower costs.



Three-Year Warranty
www.keysight.com/find/ThreeYearWarranty
 Keysight's committed to superior product quality and lower total cost of ownership. Keysight is the only test and measurement company with three-year warranty standard on all instruments, worldwide. And, we provide a one-year warranty on many accessories, calibration devices, systems and custom products.



Keysight Assurance Plans
www.keysight.com/find/AssurancePlans
 Up to ten years of protection and no budgetary surprises to ensure your instruments are operating to specification, so you can rely on accurate measurements.

Keysight Channel Partners
www.keysight.com/find/channelpartners
 Get the best of both worlds: Keysight's measurement expertise and product breadth, combined with channel partner convenience.

MIPI® service marks and logo marks are owned by MIPI Alliance, Inc. and any use of such marks by Keysight Technologies is under license. Other service marks and trade names are those of their respective owners.

PCI-SIG®, PCIe® and the PCI Express® are US registered trademarks and/or service marks of PCI-SIG.

www.keysight.com/find/Z-Series

For more information on Keysight Technologies' products, applications or services, please contact your local Keysight office. The complete list is available at: www.keysight.com/find/contactus

Americas

Canada	(877) 894 4414
Brazil	55 11 3351 7010
Mexico	001 800 254 2440
United States	(800) 829 4444

Asia Pacific

Australia	1 800 629 485
China	800 810 0189
Hong Kong	800 938 693
India	1 800 11 2626
Japan	0120 (421) 345
Korea	080 769 0800
Malaysia	1 800 888 848
Singapore	1 800 375 8100
Taiwan	0800 047 866
Other AP Countries	(65) 6375 8100

Europe & Middle East

Austria	0800 001122
Belgium	0800 58580
Finland	0800 523252
France	0805 980333
Germany	0800 6270999
Ireland	1800 832700
Israel	1 809 343051
Italy	800 599100
Luxembourg	+32 800 58580
Netherlands	0800 0233200
Russia	8800 5009286
Spain	800 000154
Sweden	0200 882255
Switzerland	0800 805353
	Opt. 1 (DE)
	Opt. 2 (FR)
	Opt. 3 (IT)
United Kingdom	0800 0260637

For other unlisted countries:
www.keysight.com/find/contactus
 (BP-6-20-17)



www.keysight.com/go/quality
 Keysight Technologies, Inc.
 DEKRA Certified ISO 9001:2015
 Quality Management System

This information is subject to change without notice.
 © Keysight Technologies, 2013 - 2017
 Published in USA, July 17, 2017
 5991-3868EN
www.keysight.com

