

Keysight Infiniium 90000A Series Oscilloscopes

Notices

© Keysight Technologies 2007, 2008, 2015, 2017

No part of this manual may be reproduced in any form or by any means (including electronic storage and retrieval or translation into a foreign language) without prior agreement and written consent from Keysight Technologies, Inc. as governed by United States and international copyright laws.

Manual Part Number

54913-97029

Edition

Fourth edition, February 2017

Available in electronic format only

Published by:

Keysight Technologies, Inc.
1900 Garden of the Gods Road
Colorado Springs, CO 80907 USA

Warranty

The material contained in this document is provided “as is,” and is subject to being changed, without notice, in future editions. Further, to the maximum extent permitted by applicable law, Keysight disclaims all warranties, either express or implied, with regard to this manual and any information contained herein, including but not limited to the implied warranties of merchantability and fitness for a particular purpose. Keysight shall not be liable for errors or for incidental or consequential damages in connection with the furnishing, use, or performance of this document or of any information contained herein. Should Keysight and the user have a separate written agreement with warranty terms covering the material in this document that conflict with these terms, the warranty terms in the separate agreement shall control.

Technology Licenses

The hardware and/or software described in this document are furnished under a license and may be used or copied only in accordance with the terms of such license.

U.S. Government Rights

The Software is “commercial computer software,” as defined by Federal Acquisition Regulation (“FAR”) 2.101. Pursuant to FAR 12.212 and 27.405-3 and Department of Defense FAR Supplement (“DFARS”) 227.7202, the U.S. government acquires commercial computer software under the same terms by which the software is customarily provided to the public. Accordingly, Keysight provides the Software to U.S. government customers under its standard commercial license, which is embodied in its End User License Agreement (EULA), a copy of which can be found at

<http://www.keysight.com/find/sweula>.

The license set forth in the EULA represents the exclusive authority by which the U.S. government may use, modify, distribute, or disclose the Software. The EULA and the license set forth therein, does not require or permit, among other things, that Keysight: (1) Furnish technical information related to commercial computer software or commercial computer software documentation that is not customarily provided to the public; or (2) Relinquish to, or otherwise provide, the government rights in excess of these rights customarily provided to the public to use, modify, reproduce, release, perform, display, or disclose commercial computer software or commercial computer software documentation. No additional government requirements beyond those set forth in the EULA shall apply, except to the extent that those terms, rights, or licenses are explicitly required from all providers of commercial computer software pursuant to the FAR and the DFARS and are set forth specifically in writing elsewhere in the EULA. Keysight shall be under no obligation to update, revise or otherwise modify the Software. With respect to any technical data as defined by FAR 2.101, pursuant to FAR 12.211 and 27.404.2 and DFARS 227.7102, the U.S. government acquires no greater than Limited Rights as defined in FAR 27.401 or DFAR 227.7103-5 (c), as applicable in any technical data.

Safety Notices

CAUTION

A **CAUTION** notice denotes a hazard. It calls attention to an operating procedure, practice, or the like that, if not correctly performed or adhered to, could result in damage to the product or loss of important data. Do not proceed beyond a **CAUTION** notice until the indicated conditions are fully understood and met.

WARNING

A **WARNING** notice denotes a hazard. It calls attention to an operating procedure, practice, or the like that, if not correctly performed or adhered to, could result in personal injury or death. Do not proceed beyond a **WARNING** notice until the indicated conditions are fully understood and met.

Infiniium 90000A Series Oscilloscopes—At a Glance

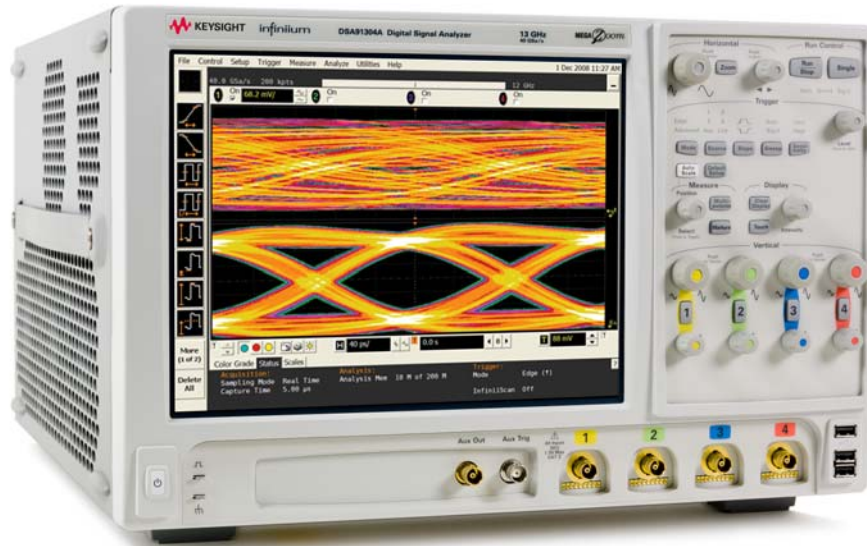

Model	Bandwidth	Maximum sampling rate on 4 ch
DSO/DSA 91304A	13 GHz	40 GSa/s
DSO/DSA 91204A	12 GHz	40 GSa/s
DSO/DSA 90804A	8 GHz	40 GSa/s
DSO/DSA 90604A	6 GHz	20 GSa/s*
DSO/DSA 90404A	4 GHz	20 GSa/s*
DSO/DSA 90254A	2.5 GHz	20 GSa/s*

* DSA models come standard with 50 Mpts of memory on 4 channels

Ease of use with high performance

The Infiniium oscilloscopes combine unprecedented ease-of use with high-performance digitizing oscilloscope functionality to simplify your design and analysis measurement tasks

- Traditional oscilloscope front-panel interface provides direct access to the controls needed for most troubleshooting tasks

- User interface with menus, windows, dialog boxes, toolbars, and wizards provides easy access to dozens of configuration and analysis tools, ensuring you can set up and make the most complex measurements
- Models with bandwidths from 2.5 GHz to 13 GHz

Display shows waveforms and user interface

- User interface allows direct interaction with waveforms, including drag-and-drop positioning and instant waveform zoom
- Touch screen display allows oscilloscope operation without an external pointing device
- Waveforms are displayed in color, making correlation easy
- Current configuration parameters displayed near the waveform display area are color-coded to make identification easy
- Menus and toolbars simplify complex measurement setups

Acquisition and general controls start and stop the oscilloscope and do basic setup

- Run and stop controls for continuous or single acquisitions
- Clear display before one or more acquisitions
- Default setup and Autoscale set initial configuration

Disk drive for saving and restoring setups and measurement results

- Store measurement displays for inclusion in reports and test setup guides
- Store oscilloscope setups to repeat tests another time
- Hard disk stores oscilloscope operating system

Trigger setup controls set mode and basic parameters

- Select Edge, Glitch, or Advanced Modes
- Choose input source and slope
- Use auxiliary trigger to increase triggering flexibility

Vertical controls set attenuation and position

- Color-coded knobs make it easy to find the controls that affect each waveform

Marker and quick measurements help measure waveform parameters

- Waveform markers 1 and 2 to check voltage or Δ -time at any point on the displayed waveform

In This Guide

This user's guide provides the information you need to begin using the Infiniium 90000A Series oscilloscopes.

Chapter 1, "Setting Up the Oscilloscope," starting on page 9 includes power and air flow requirements, plus other setup information.

Chapter 2, "Using the Oscilloscope," starting on page 29 gives an overview of the front and back panel inputs and outputs, front-panel controls, and user interface, and tells you how to perform basic operations with the oscilloscope.

Chapter 3, "Online Help and Other Information," starting on page 49 describes the Infiniium oscilloscope application's online help contents and online demos. The online help describes how to use the Infiniium oscilloscope application in detail.

For More Information and Technical Assistance

- For detailed information on how the oscilloscope makes measurements and how to use the oscilloscope, see the Infiniium oscilloscope application's online help.
- For information on controlling the oscilloscope from a remote computer, see the *Oscilloscopes Programmer's Reference* found in the Infiniium oscilloscope application's online help.
- For information on testing and servicing the oscilloscope, see the *Service Guide* found in the Infiniium oscilloscope application's online help.
- For technical assistance, contact your local Keysight Technologies representative at <http://www.keysight.com/find/contactus>.

Contents

Infiniium 90000A Series Oscilloscopes—At a Glance / 3

In This Guide / 5

1 Setting Up the Oscilloscope / 9

Safety / 10

 Safety Compliance / 10

 Acoustic Statement / 10

 General Safety Notices / 10

Symbols / 12

Inspecting Package Contents / 13

Specifications and Characteristics / 14

Declaration of Conformity / 14

Positioning for Proper Airflow / 15

 Location / 16

Connecting Accessories and Cables / 17

Connecting Power / 18



Use Supplied Power Cord / 18



Properly Ground the Oscilloscope / 18

Connecting Oscilloscope Probes / 20

Connecting SMA Cables / 22

Tilting the Oscilloscope for Easier Viewing / 23

Turning On the Oscilloscope / 24

Verifying Basic Oscilloscope Operation / 25

Installing Application Programs on Infiniium / 26

Changing Windows Operating System Settings / 27

Turning Off the Oscilloscope / 28

Cleaning the Oscilloscope / 28

2 Using the Oscilloscope / 29

Inputs and Outputs / 30

Front Panel Controls (Keys and Knobs) Overview / 31

User Interface Overview / 32

 Menu overview / 34

Using the Setup and Display Controls / 35

Starting and Stopping Waveform Acquisitions / 37

Adjusting the Horizontal Time Scale and Trigger Position / 38

Adjusting the Vertical Settings / 40

Setting Up Triggers / 42

Using Markers and Making a Measurement / 43

Saving and Printing Data / 46

Forcing a Default Setup / 47

3 Online Help and Other Information / 49

Accessing the Online Help / 49

Navigating the Online Help / 51

Using the Demo Wizard / 52

1 Setting Up the Oscilloscope

Safety / 10
Symbols / 12
Inspecting Package Contents / 13
Specifications and Characteristics / 14
Declaration of Conformity / 14
Positioning for Proper Airflow / 15
Connecting Accessories and Cables / 17
Connecting Power / 18
Connecting Oscilloscope Probes / 20
Connecting SMA Cables / 22
Tilting the Oscilloscope for Easier Viewing / 23
Turning On the Oscilloscope / 24
Verifying Basic Oscilloscope Operation / 25
Installing Application Programs on Infiniium / 26
Changing Windows Operating System Settings / 27
Turning Off the Oscilloscope / 28
Cleaning the Oscilloscope / 28

This chapter shows how to set up your Infiniium oscilloscope, connect power and accessories, and verify general operation.

Safety

This product has been designed and tested in accordance with accepted industry standards, and has been supplied in a safe condition. The documentation contains information and warnings that must be followed by the user to ensure safe operation and to maintain the product in a safe condition.

Safety Compliance

This product complies with the current editions of the following standards:

- CAN/CSA-C22.2 No. 61010-1-12
- UL Std. No. 61010-1 (3rd edition)

Acoustic Statement

This is to declare that this instrument is in conformance with the German Regulation on Noise Declaration for Machines (Laermangabe nach der Maschinenlaermrrerordnung -3.GSGV Deutschland).

LpA < 70 dB

Operator position

Normal position per ISO 7779

Acoustic Noise Emission/Geraeuschemission	
LpA <70 dB	LpA <70 dB
Operator position	am Arbeitsplatz
Normal position per ISO 7779	normaler Betrieb nach DIN 45635 t.19

General Safety Notices

WARNING

This is a Safety Protection Class I Product (provided with a protective earthing ground incorporated in the power cord). The mains plug shall only be inserted in a socket outlet provided with a protective earth contact. Any interruption of the protective conductor inside or outside of the product is likely to make the product dangerous. Intentional interruption is prohibited.

WARNING

If this product is not used as specified, the protection provided by the equipment could be impaired. This product must be used in a normal condition (in which all means for protection are intact) only.

WARNING

No operator-serviceable parts inside. Refer servicing to qualified personnel. To prevent electrical shock, do not remove covers.







CAUTION

This product is designed for use in Installation Category II and Pollution Degree 2.

The Rayovac BR2032 lithium battery is to be replaced by Keysight service personnel only.

Symbols

These symbols appear on the Infiniium oscilloscope.

Symbol	Description
	The RCM mark is a registered trademark of the Australian Communications and Media Authority.
	This symbol indicates separate collection for electrical and electronic equipment mandated under EU law as of August 13, 2005. All electric and electronic equipment are required to be separated from normal waste for disposal (Reference WEEE Directive 2002/96/EC).
	This symbol indicates the time period during which no hazardous or toxic substance elements are expected to leak or deteriorate during normal use. Forty years is the expected useful life of the product.
	The symbol on all primary and secondary packaging indicates compliance to China standard GB 18455-2001. To return unwanted products, contact your local Keysight office.
	The CSA mark is a registered trademark of the CSA International.
	The CE mark is a registered trademark of the European Community.
	ICES / NMB-001 Cet appareil ISM est conforme a la norme NMB du Canada. This is a marking to indicate product compliance with the Industry Canadian Interference-Causing Equipment Standard (ICES-001). This is also a symbol of an Industrial Scientific and Medical Group 1 Class A product (CISPR 11, Clause 4).

Inspecting Package Contents

- ✓ Inspect the shipping container for damage.
 - Keep the shipping container or cushioning material until you have inspected the contents of the shipment for completeness and have checked the oscilloscope mechanically and electrically.
 - If the shipping container is damaged, or the cushioning materials show signs of stress, notify the carrier and your Keysight Technologies Sales Office. Keep the shipping materials for the carrier's inspection. The Keysight Technologies Sales Office will arrange for repair or replacement at Keysight's option without waiting for claim settlement.

- ✓ Inspect the oscilloscope.

If there is mechanical damage or a defect, or if the oscilloscope does not operate properly or does not pass performance tests, notify your Keysight Technologies Sales Office.

- ✓ Verify that you received the following items in the Infiniium oscilloscope packaging.

- mouse
- stylus
- keyboard
- accessories pouch
- front panel cover
- calibration cable (not available or required for the DSO90254A)
- precision 3.5 mm adapters (qty 2) (not available or required for the DSO90254A)
- Keysight E2655C probe de-skew and performance verification kit
- power cord

If anything is missing, contact your nearest Keysight Technologies Sales Office.

- ✓ Verify that you received the options and accessories you ordered and that none were damaged.

For a complete list of options and accessories available for the 90000A Series oscilloscopes, see the *Infiniium 90000 Series Oscilloscopes Data Sheet*.

CAUTION

ACCESSORIES POUCH—The accessories pouch is designed to carry less than 45.36 kgs (100 lbs) of weight. Do not exceed this weight. Also, do not try to pick up the oscilloscope using the accessories pouch strap.

Specifications and Characteristics

Environment	Indoor use only
Ambient temperature	Operating: 5 °C to +40 °C Non-operating: -40 °C to +65 °C
Humidity	Operating: up to 95% relative humidity (non-condensing) at +40 °C Non-operating: up to 90% relative humidity at +65 °C
Altitude	Operating: up to 4,000 meters (12,000 feet) Non-operating: up to 15,300 meters (50,000 feet)
Weight	19.7 kg (43.4 lbs)
Dimensions (excluding handle)	Height: 282 mm (11.13 in), Width 432 mm (17.02 in), Depth 506 mm (19.91 in)
Installation Category	II
Power Requirements	100-240 VAC at 50-60 Hz; maximum input power 800 W
Voltage Fluctuations	The mains supply voltage fluctuations are not to exceed $\pm 10\%$ of the nominal supply voltage
Pollution Degree	The Infiniium 90000A Series oscilloscopes may be operated in environments of Pollution Degree 2
Pollution Degree Definitions	<p>Pollution Degree 1: No pollution or only dry, non-conductive pollution occurs. The pollution has no influence. Example: A clean room or climate-controlled office environment.</p> <p>Pollution Degree 2: Normally only dry non-conductive pollution occurs. Occasionally a temporary conductivity caused by condensation may occur. Example: General indoor environment.</p> <p>Pollution Degree 3: Conductive pollution occurs, or dry, non-conductive pollution occurs which becomes conductive due to condensation which is expected. Example: Sheltered outdoor environment.</p>

NOTE

The Infiniium 90000A Series oscilloscopes are heavy and awkward for a single individual to move. It is recommended that two people use the side handles to lift and carry the oscilloscope.

Declaration of Conformity

For Declarations of Conformity for Keysight products, go to www.keysight.com/go/conformity.

Positioning for Proper Airflow

Position the oscilloscope where it will have sufficient clearance for airflow around the back and sides. If you install the oscilloscope into an N5470A rack, refer to the *Keysight N5470A 90000, 90000 X, and V-Series Oscilloscope Rack Mount Kit Installation Guide* at www.keysight.com/find/90000a-manual.

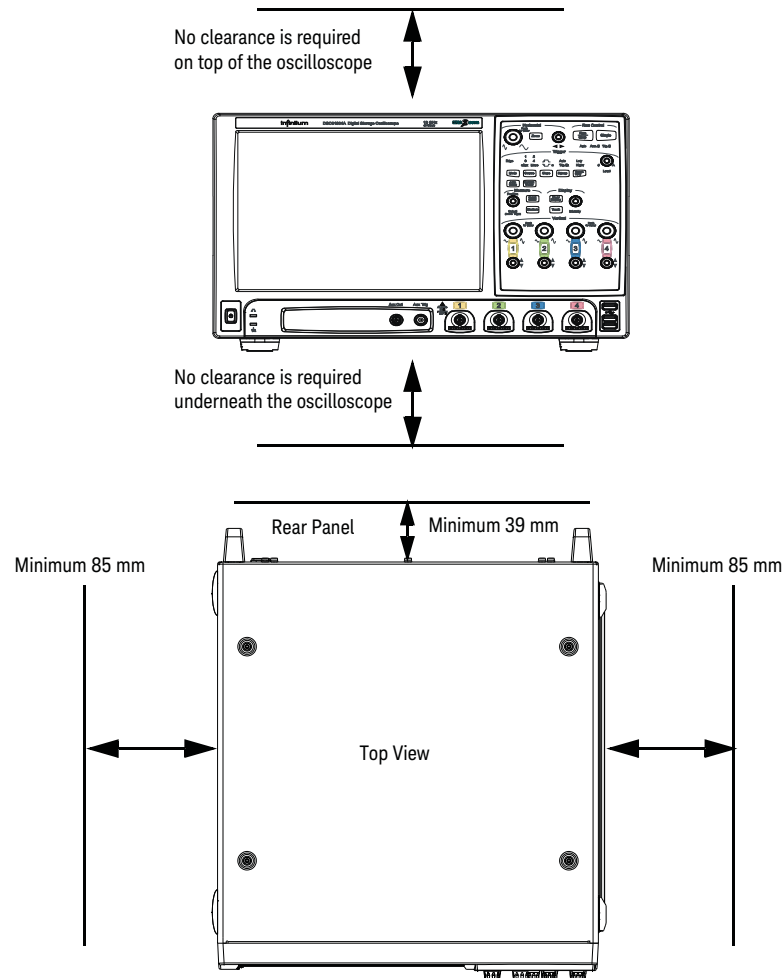

The airflow requirement is 300 cfm

Figure 1 Positioning the 90000A Series oscilloscope with sufficient clearance

CAUTION

VENTILATION REQUIREMENTS: When installing the instrument(s) into a cabinet, consider the convection flow into and out of the cabinet. Also consider the individual instruments, to avoid having the heated discharge of one instrument become the cooling intake air for another instrument.

Location

Install the oscilloscope so that the detachable power cord is readily identifiable and is easily reached by the operator.

The detachable power cord is the oscilloscope disconnecting device. It disconnects the mains circuits from the mains supply before other parts of the oscilloscope. (The front panel switch is only a standby switch and is not a LINE switch.)

Alternatively, an externally installed switch or circuit breaker (which is readily identifiable and is easily reached by the operator) may be used as a disconnecting device.

Connecting Accessories and Cables

Plug the supplied mouse and keyboard into the USB ports. If you choose to use a PS2 mouse or keyboard, you must plug it in to the PS2 port on the rear panel before turning on power to the oscilloscope.

NOTE

Connecting devices to all three USB ports on the front of the oscilloscope may cause the start-up process to stop due to overload. We recommend using the ports on the rear of the oscilloscope, or connecting the devices after the power-up cycle is complete.

Connect your LAN cable to the RJ-45 LAN connector on the back panel of the oscilloscope.

NOTE

After you have connected to the LAN card, you must set up the network. Exit the oscilloscope application before you start setting up your network.

If you do not know how to set up a network in the Windows 7 operating system, see your network administrator or use the Windows 7 operating system's online help.

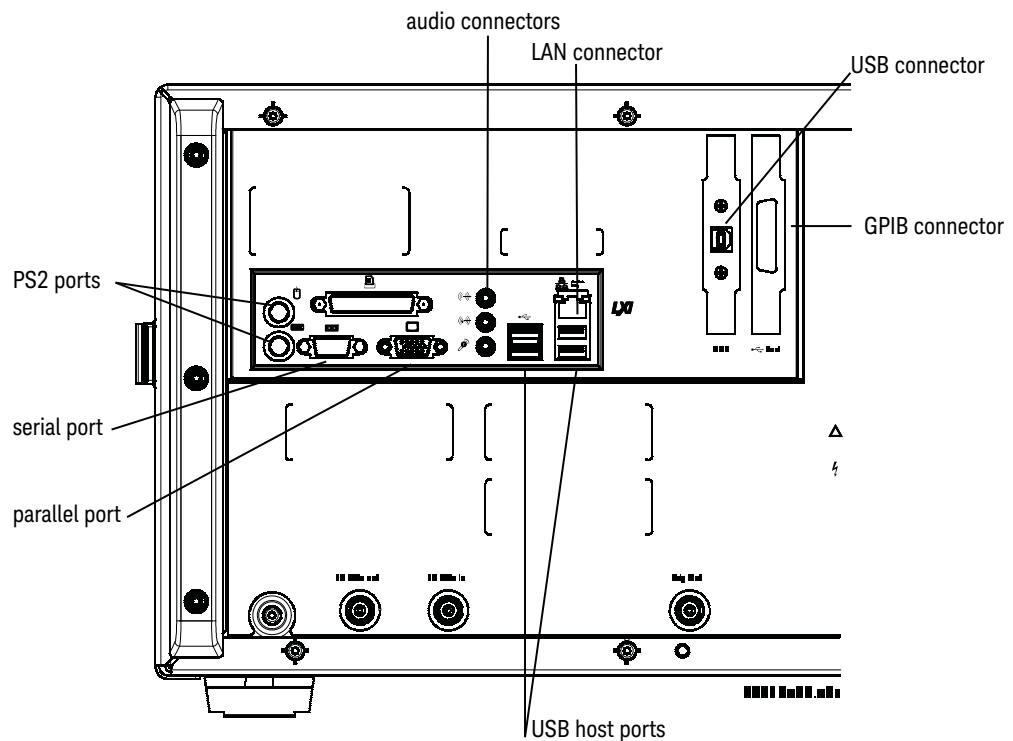

Figure 2 Back panel

Connecting Power

Table 1 Power requirements

Power	100 - 240 VAC at 50/60 Hz Input power not to exceed 800 Watts
-------	--

- Connect the power cord to the rear of the oscilloscope, then to a suitable AC voltage source.

CAUTION

Use Supplied Power Cord

Use only power cords designed for your oscilloscope. The oscilloscope power supply automatically adjusts for line input voltages in the range 100 to 240 VAC. Therefore, you do not need to adjust an input line voltage setting.

The power cord provided is matched to the country of origin of the order.

CAUTION

The Mains wiring and connectors must be compatible with the connector used in the premise electrical system. Failure to ensure adequate earth grounding by not using the correct components may cause product damage and serious injury.

CAUTION

This oscilloscope has autoranging line voltage input. Before switching on the oscilloscope, be sure the supply voltage is within the specified range and voltage fluctuations do not exceed 10% of the nominal supply voltage.

WARNING



Properly Ground the Oscilloscope

To avoid electric shock, be sure the oscilloscope is properly grounded.

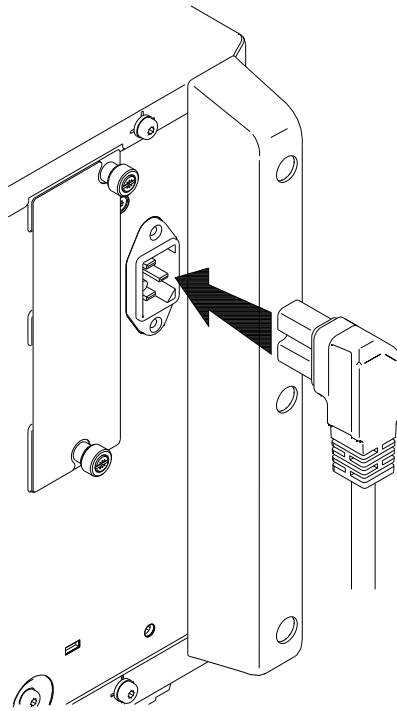

Figure 3 Power cord connection

Connecting Oscilloscope Probes

Some optional Infiniium oscilloscope probes, such as the InfiniiumMax 1130 series probes, connect differently than other probes. Follow these steps to connect these snap-on probes to the oscilloscope:

- 1 Attach the probe connector to the desired oscilloscope channel or trigger input. Push it straight on until it latches into place.

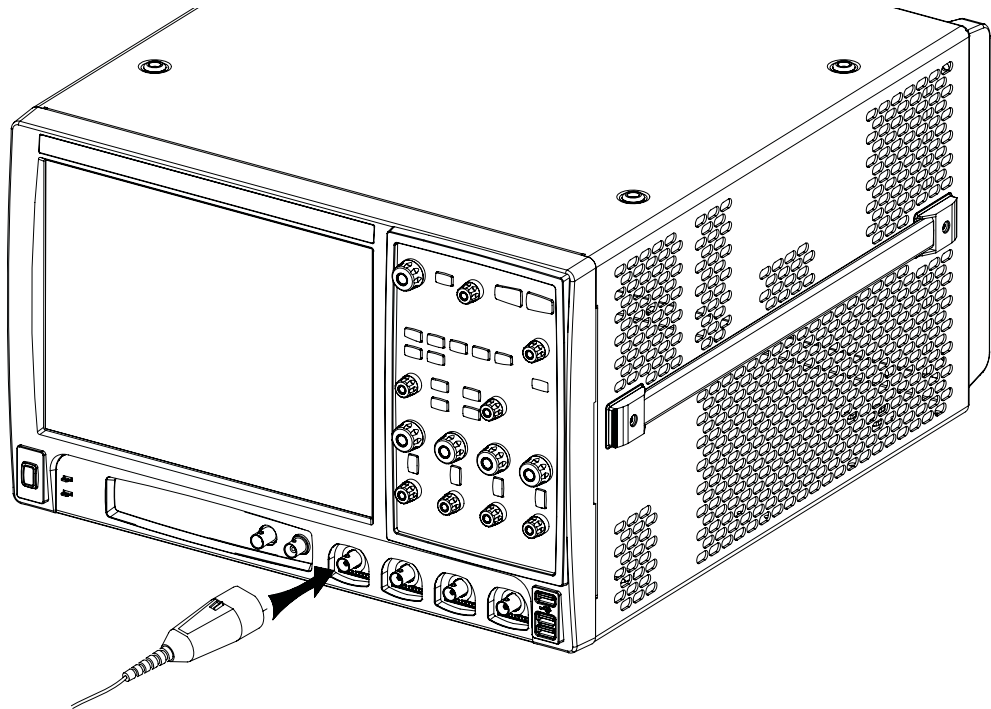

Figure 4 Attaching a probe connector

- 2 Connect the probe head to the circuit of interest using the browser or other probing accessories.

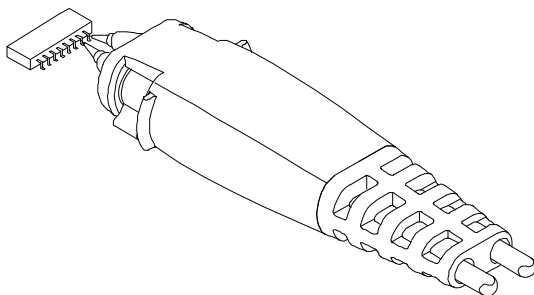

Figure 5 Probe browser

- 3 To disconnect the probe, push the small latch on top of the probe connector to the left, then pull the connector body away from the front panel of the oscilloscope without twisting it.

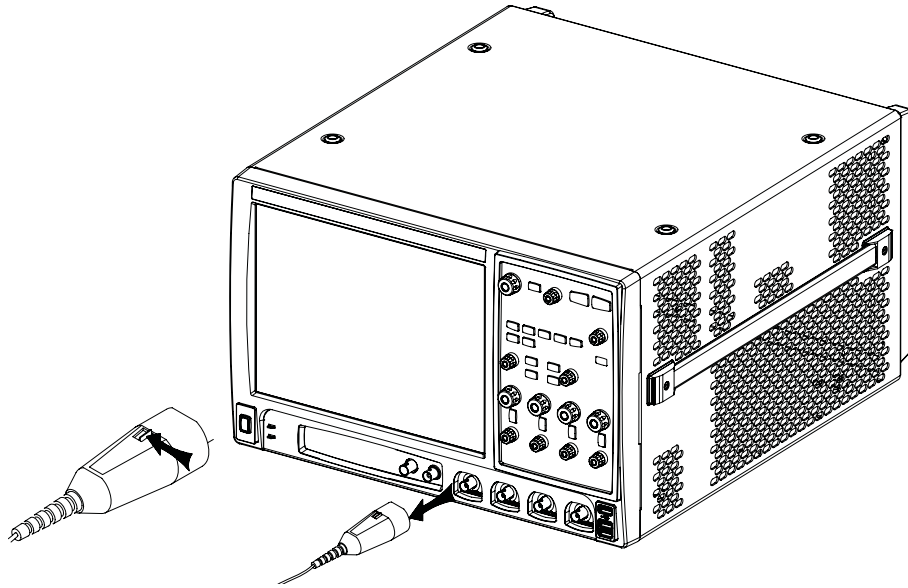

Figure 6 Disconnecting the oscilloscope probe

CAUTION

Do not try to twist the snap-on probes on or off the oscilloscope's BNC connector. Twisting the probe connector body will damage it

CAUTION

Do not exceed the maximum input voltage rating. The maximum input voltage for the 50 Ω inputs is ± 5 V_{peak}.



Before using InfiniiMax I, II, or III probes, review the *InfiniiMax Probe Handling Guide* included with the probes. These probes are ESD-sensitive devices and there is a proper order for connecting probe amplifiers to the oscilloscope, probe heads to the device under test (DUT), and probe heads to the amplifier. You can also find the *InfiniiMax Probe Handling Guide* on the Keysight web site (www.keysight.com) or with other Keysight oscilloscope probes documentation in the Probe Resource Center (www.keysight.com/find/prc).

The Keysight Infiniium 90000A Series oscilloscopes are not rated for Measurement Category II, III, or IV.

CAUTION

Ensure that the rated voltage of any probing accessory is not exceeded by the circuit to be measured.

Connecting SMA Cables

You can connect an SMA cable to the Infiniium 90000A Series oscilloscopes (except for the DSO90254A model) by using the 54855-67604 SMA-to-precision BNC adapter.

- 1 Attach the two SMA-to-precision BNC adapters to the ends of an SMA cable.
- 2 Push the SMA-to-precision BNC adapters onto the oscilloscope BNC connectors.
- 3 Tighten the thumbscrews until they are snug.

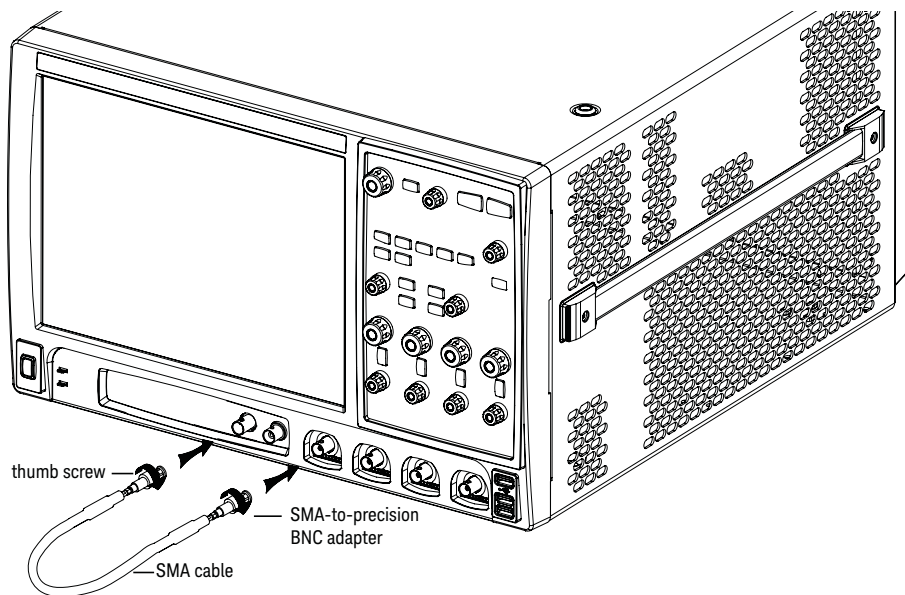
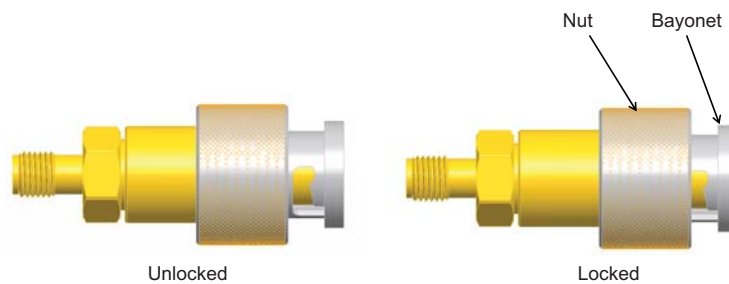

Figure 7 Connecting SMA-to-precision BNC adapters

NOTE

Be sure the 54855-67604 adapters are unlocked before trying to attach them to the BNC connectors. To ensure the adapter is unlocked, hold the bayonet in your left hand and turn the nut counter-clockwise to unlock it.



Tilting the Oscilloscope for Easier Viewing

To angle the oscilloscope upward, lift the front of the oscilloscope and pull out the two wire feet.

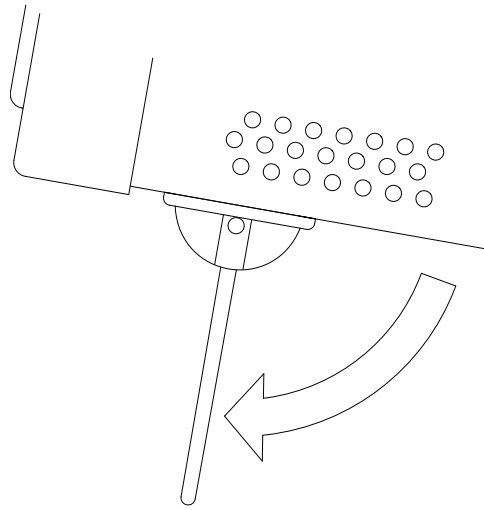

Figure 8 Latching the front feet

Turning On the Oscilloscope

Press the power/standby button in the lower left corner of the oscilloscope front panel.

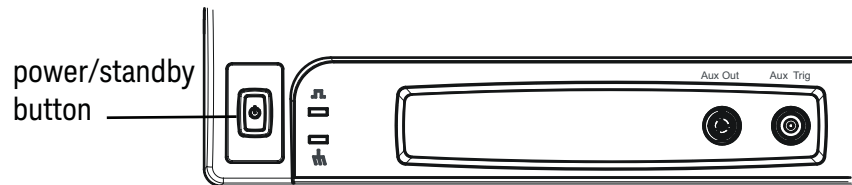

Figure 9 Turning On the oscilloscope

After a short initialization period, the oscilloscope display appears. The oscilloscope is ready to use.

You can connect and disconnect probes and BNC cables while the oscilloscope is turned on.

This oscilloscope does not exceed 80 dBA sound pressure level, which is considered to be below the OSHA permissible exposure level.

Verifying Basic Oscilloscope Operation

- 1 Connect one end of the calibration cable using SMA-to-precision BNC adapters to channel 1.
- 2 Connect the other end of the calibration cable to the **Aux Out** connector on the front panel.

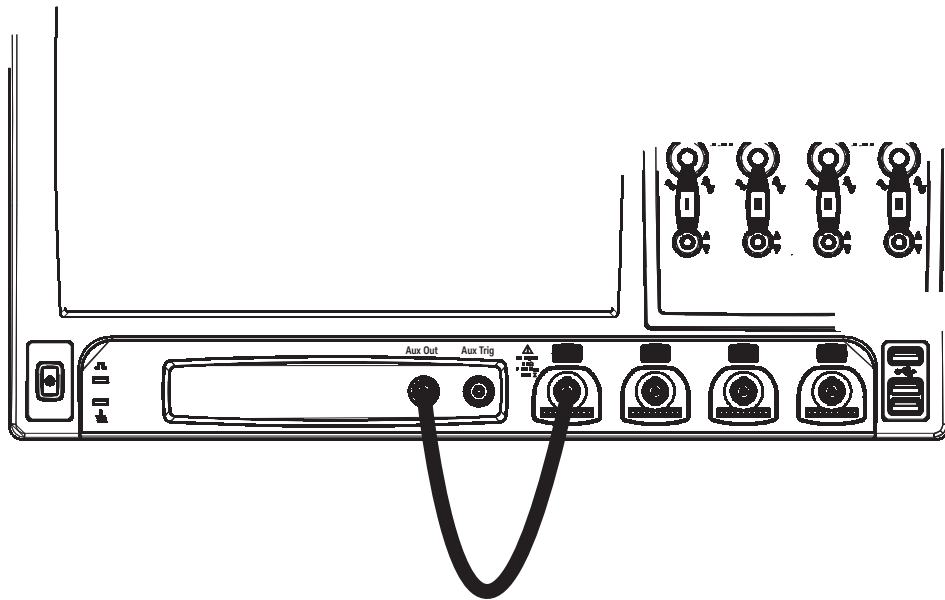

Figure 10 Verifying basic oscilloscope operation

- 3 Press **[Default Setup]** on the front panel.

The display will pause momentarily while the oscilloscope is configured to its default settings.

- 4 Press **[Auto Scale]** on the front panel.

The display will pause momentarily while the oscilloscope adjusts the time/div setting and vertical scale. You should then see a square wave with about four cycles on screen and a peak-to-peak amplitude of approximately five divisions.

If you do not see the waveform, make sure your power source is adequate, the oscilloscope is properly powered on, and the probe is connected securely to the front-panel channel input BNC and to the probe calibration output.

- 5 Move the mouse around the mouse surface and verify that the on-screen pointer follows the mouse movement.
- 6 Touch the pointer of the touch screen stylus to the surface of the screen and move it around while verifying that the pointer follows the movement.

Installing Application Programs on Infiniium

Infiniium has an open Windows operating system, which lets you install your own application software. Any application that runs on Microsoft Windows 7 Embedded and uses 8 GB of RAM or less may be installed on your Infiniium oscilloscope.

NOTE

Exit the oscilloscope application before installing any software.

CAUTION

Installing an application that does not meet these requirements may break the oscilloscope application and require a hard drive recovery.

Changing Windows Operating System Settings

NOTE

Exit the oscilloscope application before changing any Windows operating system settings outside of the oscilloscope application.

Many Windows operating system settings can be changed to suit your own personal preferences. However, some operating system settings should not be changed because doing so would interfere with the proper operation of the oscilloscope.

- Do not change the Power Options.
- Do not change the Language settings.
- Do not remove Fonts.
- Do not change the screen resolution from 1024 by 768 pixels.
- Do not use the Administrative Tools to enable or disable Internet Information Services. Use the Infiniium SCPI Server dialog box (**Utilities > Remote...**) to enable or disable the Web Server.
- Do not delete or modify the Infiniium Administrator user account.

Turning Off the Oscilloscope

Press the power/standby button in the lower left corner of the oscilloscope front panel. The oscilloscope will go through a normal Windows operating system shutdown process.

Cleaning the Oscilloscope

Clean the Infiniium oscilloscope with a soft dry cloth or one slightly dampened with a mild soap and water solution to clean the external case parts. Do not attempt to clean internally.

CAUTION

Do not use too much liquid in cleaning the oscilloscope. Water can enter the Infiniium panels, damaging sensitive electronic components.

WARNING

To prevent electrical shock, disconnect the Infiniium oscilloscope from mains before cleaning.

WARNING

Use alcohol to clean connectors. The power cord must be removed, and the oscilloscope must be in a well-ventilated area. Allow all residual alcohol moisture to evaporate, and the fumes to dissipate prior to powering up the oscilloscope. Dispose of the cleaning materials in a responsible manner.

2 Using the Oscilloscope

Inputs and Outputs /	30
Front Panel Controls (Keys and Knobs) Overview /	31
User Interface Overview /	32
Using the Setup and Display Controls /	35
Starting and Stopping Waveform Acquisitions /	37
Adjusting the Horizontal Time Scale and Trigger Position /	38
Adjusting the Vertical Settings /	40
Setting Up Triggers /	42
Using Markers and Making a Measurement /	43
Saving and Printing Data /	46
Forcing a Default Setup /	47

This chapter describes how to use the Infiniium 90000A Series oscilloscope's front-panel controls and user interface.

- The familiar front-panel oscilloscope interface with knobs and keys is optimized for common tasks and basic measurements.
- The Infiniium oscilloscope application's user interface with menus, windows, dialog boxes, and toolbars provides easy logical access to dozens of configuration and analysis tools, making it easy for you to set up and make complex measurements.
- You have the option of using either the front panel controls or the user interface for many common tasks.

Inputs and Outputs

On the Infiniium 90000A Series oscilloscopes, the Aux Trig input, Aux Out output, and probe compensation terminal are located on the front of the oscilloscope. The Trig Out output and 10 MHz Reference input and output are located on the back of the oscilloscope. Their ratings are shown below:

Aux Trig		-5 V to +5 V, 50 Ω impedance
Aux Out		0 V to 5 V, 50 Ω impedance
Probe compensation terminal		0 V to 5 V, 50 Ω impedance
Trig Out		0 V to 5 V, 50 Ω impedance
10 MHz In		-5 dBm to +10 dBm, 50 Ω impedance
10 MHz Out		-5 dBm to +10 dBm, 50 Ω impedance

Front Panel Controls (Keys and Knobs) Overview

The Infiniium 90000A Series oscilloscope front panel gives you direct access to the functions needed to perform the most common measurements, using a traditional oscilloscope interface. Knobs and keys let you directly set vertical and horizontal parameters. The front panel also has a set of LED indicators; by using these and the display, you see the oscilloscope's configuration at a glance.

The oscilloscope uses color consistently throughout the front panel and user interface. For example, the color of the knob for channel 1 is the same color as the waveform for channel 1. All the configuration items and values related to channel 1 are displayed in the same color.

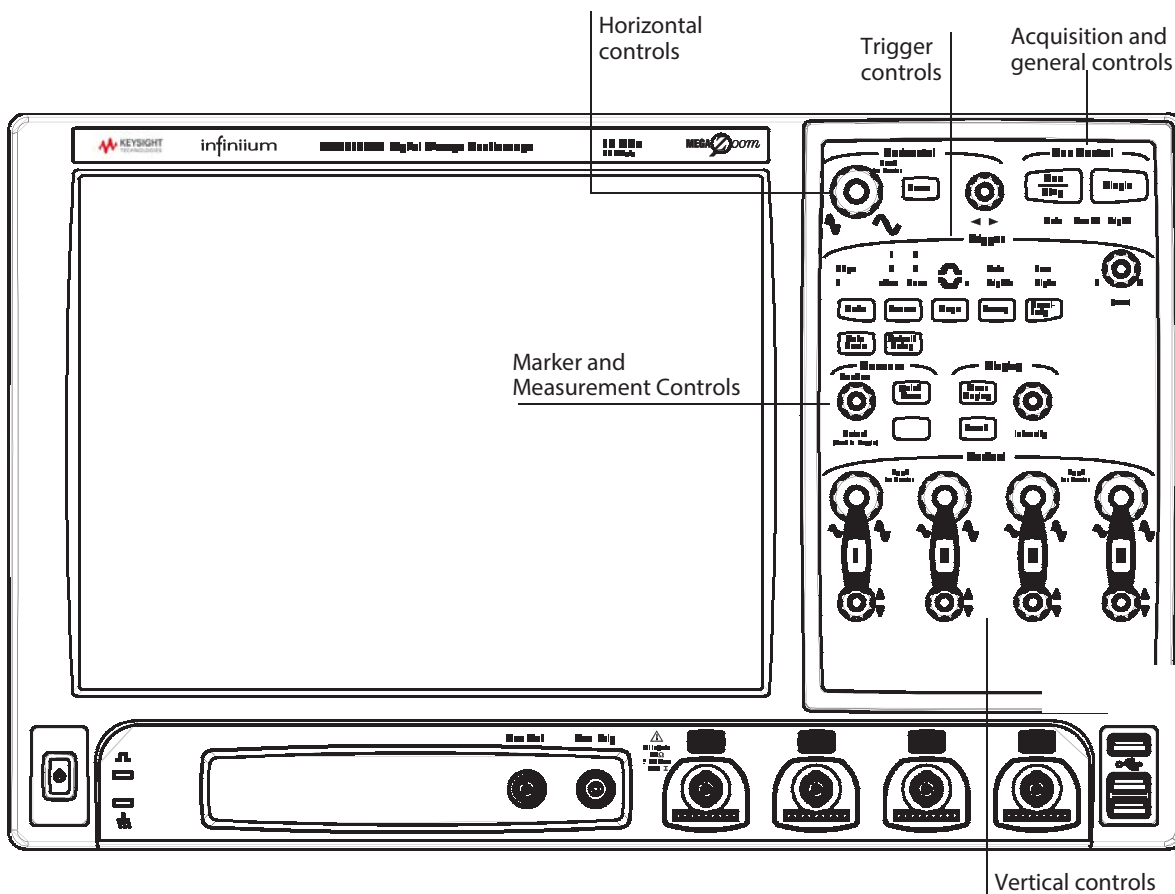

Figure 11 Infiniium 90000A Series oscilloscope front panel

User Interface Overview

With the user interface for the Infiniium oscilloscope, you can access all of the configuration and measurement features of the oscilloscope through an easy-to-use system of windows, menus, toolbars, dialog boxes, icons, wizards, and buttons.

The user interface is arranged so the most common functions affecting the waveform display are located around the edge of the waveform display area.

Context-sensitive menus are available when you right-click something in the waveform display area, such as the grid, a signal, a bookmark, or a measurement. You can mouse over or touch other areas, such as the drag & drop measurements area and horizontal and acquisition control regions, to find more information about those areas or to enter data.

The following figures call out the areas and controls of the user interface.

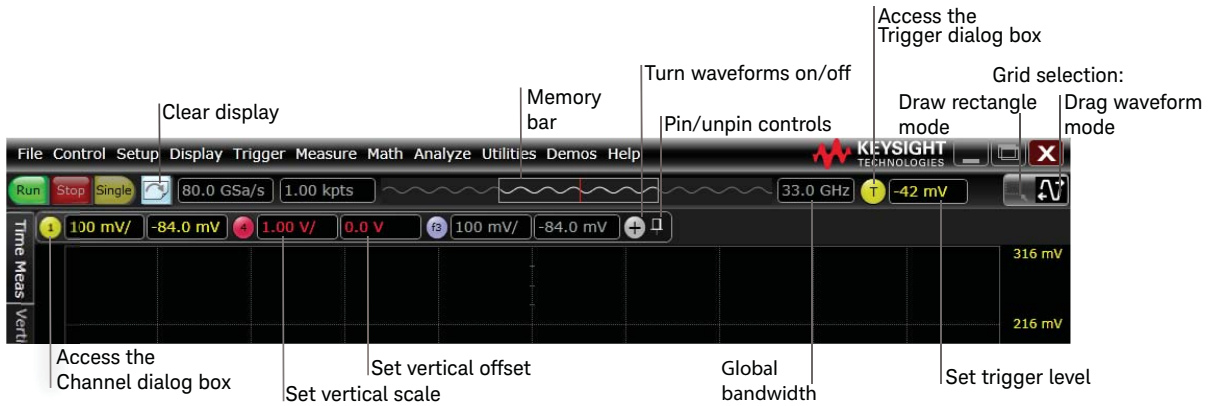

Figure 12 Infiniium oscilloscope top of display

The selected grid mode in the upper right corner determines whether you draw a selection box or manipulate waveforms when you touch the screen.



Figure 13 Infiniium oscilloscope waveform display area

The waveform display area shows up to eight waveform windows. Several display options are available, such as grids or horizontal and vertical scales.

NOTE

Avoid Overdriving Vertical Input Amplifiers

When zooming on a waveform with the oscilloscope running, be careful to keep the signal within the screen vertically to avoid overdriving the vertical input amplifiers. Overdriving causes waveform distortion and erroneous measurement results.

Ground reference indicators appear for each displayed channel, waveform memory, or math function waveform. The symbol represents the ground reference point for each waveform; it moves when you change the vertical offset. You can also drag this symbol up and down to change the vertical offset for that waveform.

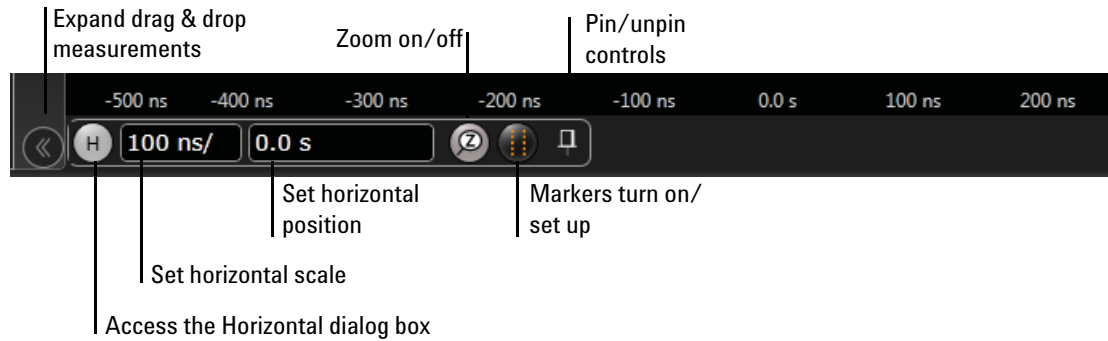

Figure 14 Infiniium oscilloscope bottom of display

A Results pane is visible at the very bottom of the display when you do something that requires it, such as take a measurement. When it is not needed, the Results pane is not visible.

Menu overview

You can use menus to perform defined operations, set up measurement parameters, and access every function the oscilloscope provides.

Take a few minutes to look through the menus to get an overview of the many features and capabilities of your Infiniium oscilloscope.

The sub-menu selections will vary slightly, depending on which licenses are installed.



Figure 15 Menu bar

Using the Setup and Display Controls

With the setup and display controls you can set the oscilloscope to a known starting condition, set the display to suit your preference, and define a key to perform automatic measurements or other quick actions.

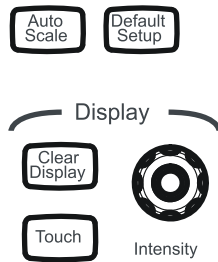

Figure 16 Setup and display control keys

- To automatically configure the oscilloscope for the current input signal(s), press **[Auto Scale]** or choose **Control > Autoscale** from the main menu.
- To reset the oscilloscope to its default setup, press **[Default Setup]** or choose **Control > Default Setup**. Choose **Control > Undo Default Setup** to return the oscilloscope to its original configuration.

NOTE

Save the Current Oscilloscope Configuration

Before using the default setup, you may want to save the current oscilloscope configuration for later use. See the online help (described in chapter 3) for instructions on saving and recalling setups, and for information on the exact configuration that is set when you use the default setup.

Using the touch screen

To enable or disable the touch screen, press the **[Touch]** key. Or, choose **Utilities > User Preferences...** to enable the touch screen from the User Preferences dialog box.

Touch the drag waveform icon near the upper right corner of the display to highlight it.

Saving the screen image

- To save the screen image to a file for use in other programs or documents, press the **[Save Screen]** key or choose **File > Save > Screen Image...**
- The first time you save a screen image you will be prompted to enter a location for the saved file. Subsequent saves automatically place the file in that location.

Clearing the waveform display

Press the **[Clear Display]** key or click the clear display  button.

The oscilloscope clears acquired waveform data from the display in preparation for another acquisition. If the oscilloscope is in Run mode and is receiving triggers, it will update the display as it collects new waveform data.

Clearing the waveform display also resets averaging, infinite persistence, color grade persistence, histograms, measurement statistics, and the mask testing database.

Adjusting waveform brightness

Turn the Intensity knob to set the waveforms to your desired brightness.

Starting and Stopping Waveform Acquisitions

Use the acquisition run controls to run and stop acquisitions or make a single acquisition. The boxed area of the memory bar above the waveform display area shows which portion of the channel's acquisition memory you are viewing.



Figure 17 Acquisition run control keys and buttons

The **[Run/Stop]** key is lit green and the green **Run** button is highlighted when the oscilloscope is running (acquiring data). The **[Run/Stop]** key is red and the **Stop** button is highlighted when the acquisition is stopped.

- To start waveform acquisition, press the **[Run/Stop]** key or click **Run**.
The oscilloscope begins acquiring data. When it receives a trigger signal, it finishes acquiring data, updates the display, and then starts another acquisition cycle if it is in Trig'd or Auto trigger mode.
- To stop waveform acquisition, press the **[Run/Stop]** key or click **Stop**. Whatever data was last acquired remains on the screen.
- To make a single acquisition, press the **[Single]** key or click **Single**.
- You can also click the Run, Stop, and Single commands from the Control menu.
- To set up how you want the signals to be sampled, such as sampling rate and mode, click **Setup > Acquisition....**

Adjusting the Horizontal Time Scale and Trigger Position

Use the horizontal controls to configure the horizontal scale (time per division) and horizontal position of the waveform. You can view a magnified section of the waveform using the zoom window.

Use gestures on the touch screen to adjust the horizontal scale and position. You can also use the horizontal knobs, horizontal controls, or Horizontal dialog box.

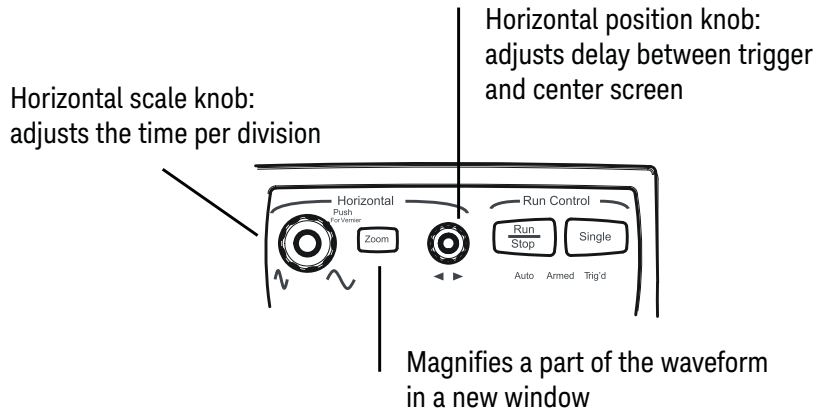

Figure 18 Horizontal scale and position knobs, [Zoom] key

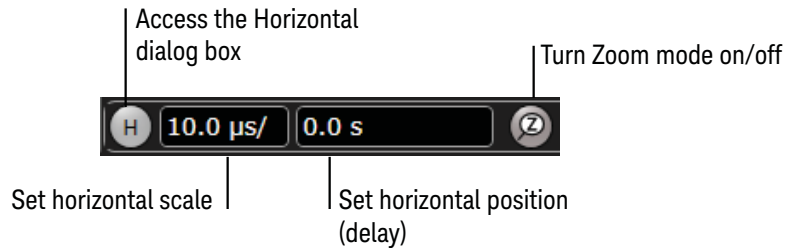

Figure 19 User interface horizontal controls

Adjusting the horizontal scale

- The horizontal scale knob is the larger of the two horizontal control knobs. To stretch the waveform horizontally, turn the horizontal scale knob clockwise. To shrink it horizontally, turn the knob counter-clockwise.

Stretching the waveform means fewer seconds are displayed per division. Shrinking it means more seconds are displayed per division.

- Push and turn the horizontal scale knob to change the scaling in finer (Vernier) increments.

- You can also use the controls in the horizontal toolbar to adjust the horizontal scale. Mouse over or touch the horizontal scale field and use the resulting controls to set a particular horizontal scale. You can click the **Scale** field to enter an exact value, or click the “narrower” or “wider” buttons.

Adjusting the horizontal trigger position (delay)

- The horizontal position knob is the smaller of the two horizontal control knobs. Turn it to move the waveform to the right or left.

Moving the waveform to the right shows more of the pre-trigger data (data acquired before the trigger event). Moving the waveform to the left shows more of the post-trigger data.

When you drag the desired waveform, the horizontal position will change for all channels and functions on the display. Waveform memories will also move if you check the Tie To Timebase box in the Waveform Memories dialog box.

- You can also use the controls in the horizontal toolbar to adjust the horizontal position. Mouse over or touch the horizontal position field and use the resulting controls to set a particular horizontal position (time relative to the trigger at the highlighted horizontal reference point).

Magnifying a part of the waveform using Zoom

- To turn on zoom, press the **[Zoom]** key or click the Zoom button.

The waveform display area splits into two regions. The top one is the main timebase. The bottom is the zoomed timebase, which represents an expansion of the acquired waveform data. A section of the waveform in the main timebase window is highlighted to indicate the part shown in the zoomed timebase window.

The horizontal scale and horizontal position controls now change how the waveform is shown in the zoomed timebase window. The horizontal scale will change the amount of magnification, while the position will change the part of the waveform in the main window that is shown in the zoomed window.

- Press the **[Zoom]** key or click the Zoom button again to turn off Zoom.

Setting the scale, position, and timebase reference point

You can use the Horizontal dialog box to set scale, position, and timebase reference. You can also set up the zoomed timebase window.

- To access the Horizontal dialog box, click the  in the horizontal toolbar, or click **Setup > Horizontal...** from the menu bar.
- The Timebase Reference control is a slider from 0 to 100% of the screen. The center of the screen is at 50%. The slider correlates to the solid orange triangle at the bottom of the display area, showing you where the horizontal offset is on the screen.

Adjusting the Vertical Settings

Use the vertical controls to set the vertical scaling (volts per division) and vertical offset for each analog channel. You can also turn the display on or off for a particular channel.

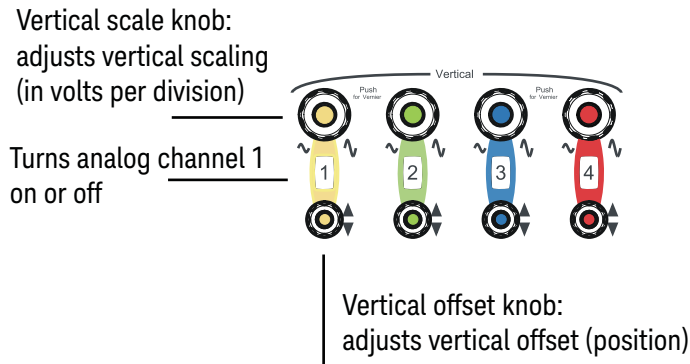

Channel keys and vertical scale and offset knobs

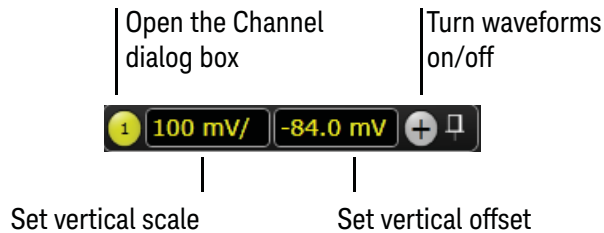

Figure 20 User interface vertical controls

Turning an analog channel on or off

- To turn an analog channel on or off, press the channel number key on the front panel or click the Add Waveforms button . When you turn off a channel, the current vertical scale and offset fields for that channel disappear.

If you are not using a particular analog channel, you can turn it off to simplify the waveform display and increase the display update rate. Functions continue to run on a channel source that is turned off. Data acquisition continues for a channel if a function requires it.

NOTE**Using an Analog Channel as Trigger**

Any analog channel can be used as a trigger source. If you need a trigger but do not need all analog channels, you can use an analog channel as a trigger without displaying it by turning the analog channel display off.

Adjusting the analog channel's vertical scale and offset

You can use the vertical scale and offset knobs, the vertical user interface controls, or the Channel dialog box to adjust the vertical scale and offset.

- The vertical scale knob is the larger of the two knobs for a channel. Turn it to make the waveform bigger (fewer volts per division) or smaller (more volts per division).
- You can also mouse over or touch the vertical scale field and use the resulting controls to set an exact value for the scaling.
- The vertical offset knob is the smaller of the two knobs for a channel. Turn it to move the waveform up or down.
- You can click and drag the waveform or its ground reference indicator to the desired vertical offset if the grid is in drag mode .
- Click **Setup > Channel N...** or click a channel number to open the Channel dialog box, in which you can set the vertical scale, offset, skew, and labels. You can also specify the characteristics of a probe, or perform a probe calibration.

For Keysight Technologies probes that are compatible with AutoProbe I interfaces, the oscilloscope will automatically set these characteristics (except for skew) after identifying the probe when it is connected to the channel input.

Setting Up Triggers

Use the trigger controls to set the conditions on which the oscilloscope will trigger and acquire an input signal. You can set up a variety of trigger conditions. Edge triggers and the parameters for edge triggering can be set up from the front panel.

Trigger configuration settings you make using the user interface are reflected in the front-panel status indicators, and will remain set unless you change them or press the **[Default Setup]** key.

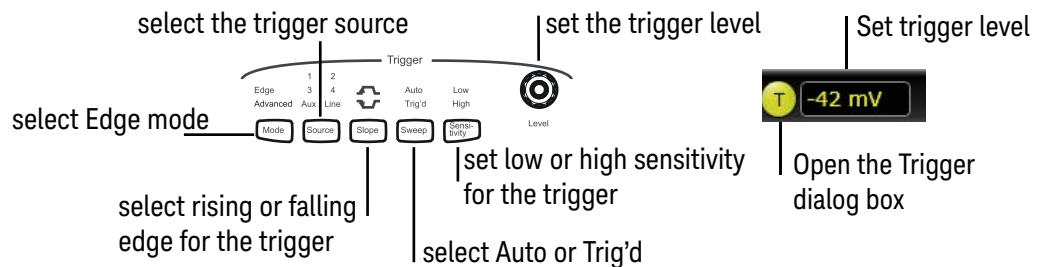

Figure 21 Trigger controls and indicators

Setting the oscilloscope to trigger on an edge

- 1 Press the **[Source]** key until the desired trigger source LED is illuminated.

You can choose any of the channels or the **Aux** or **Line** input as the source for an edge trigger.

- 2 Press the **[Slope]** key until the desired slope LED is lit.

You can have an edge trigger on a rising or falling edge, or both.

- 3 Press the **[Sweep]** key until the desired LED is lit (Trig'd or Auto).

When Auto is selected, if a trigger does not occur within a certain amount of time, an acquisition is automatically saved and displayed. In Auto trigger mode, you are able to see your signals while setting up the desired trigger.

When Trig'd is selected, the oscilloscope must find the trigger before saving and displaying captured data.

- 4 Turn the trigger Level knob to adjust the voltage level at which the oscilloscope will trigger.

Use the Trigger dialog box to select any of the different modes of triggering, the parameters and conditions for each trigger mode, and advanced configuration items.

You can also mouse over the trigger level field and use the resulting controls to set a specific trigger level when the scope is set for edge trigger on a specific channel. You can also drag the trigger reference indicator at the left side of the display, or drag the trigger line itself, which appears when you click or touch the grid.

Using Markers and Making a Measurement

Use the marker and measurement controls to display and adjust markers, define a key to perform automatic measurements or other quick actions, and make measurements.

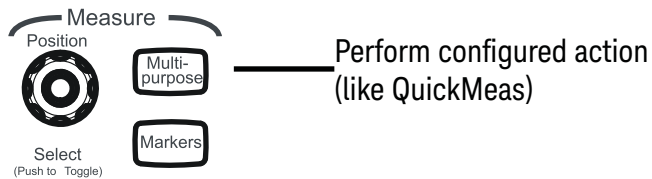

Figure 22 Front panel measure controls

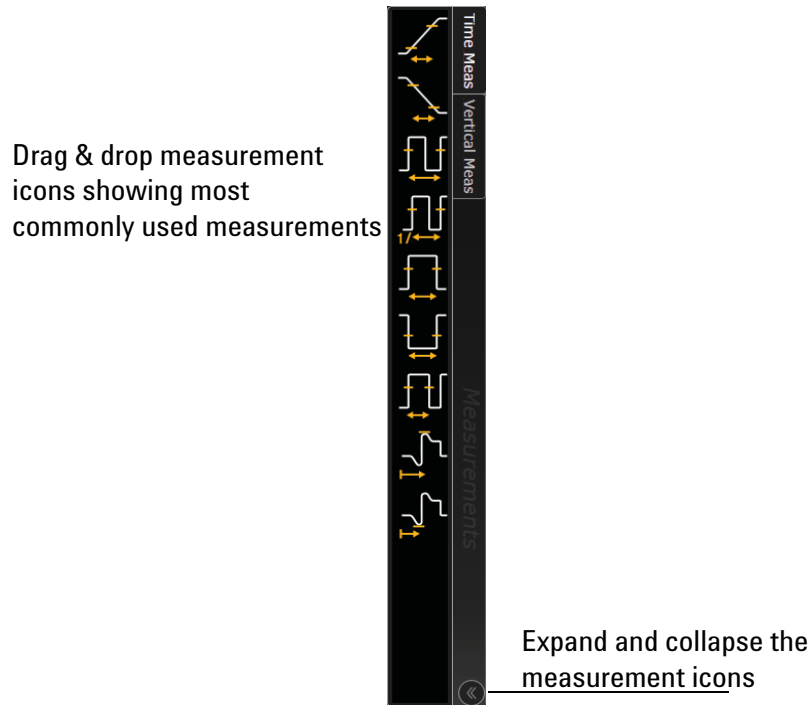

Figure 23 User interface drag & drop measurements

Making a measurement on a waveform

Click and drag a measurement icon to the waveform event you want to measure, or click a measurement icon and specify which source you want to measure in the dialog box that appears.

For measurements on waveform features, such as those that involve waveform edges, if you click a measurement icon and specify a source, the measurement defaults to using the feature closest to the horizontal reference point. When you make the measurement using drag-and-drop, the measurement uses the waveform feature closest to the point where you drop the icon.

The most commonly used measurements are available in the drag and drop area. Others are available from the Add Measurement dialog box.

When you drag and drop a measurement icon on a waveform, the icon outline changes color to match the color of each waveform it touches so you can easily see which waveform will be measured when you release.

For edge-sensitive measurements, when you drop the measurement icon on a waveform, a circled number appears in the waveform marker color. This number shows exactly where the measurement is being made. It is displayed next to the measurement readout in the Results area.

This feature helps you distinguish measurement results from each other when you make multiple measurements on the same waveform, but at different waveform features.

Using quick measurements

- You can define the **[Multi Purpose]** key to perform one of these quick actions:
 - QuickMeas—performs automatic measurements
 - QuickPrint—prints the screen image to the default printer
 - QuickScreen—saves the screen image to a file
 - QuickSetup—loads a setup file
 - QuickWaveform—saves waveform data to a file
 - QuickSave—saves a customized set of screen images or waveforms to a file
 - QuickEmail—sends an email of the current screen image
 - QuickExecute—runs an executable file
 - QuickControl—cycles through the possible front panel control sources
 - QuickComposite—saves composite data to a file

The action taken when the **[Multi Purpose]** key is pressed (or **Utilities > Multipurpose** is chosen) depends on the feature selected in the Customize Multipurpose dialog box (**Utilities > Customize Multipurpose...**). The default feature is QuickMeas.

- To turn on the quick measurement display, press the **[Multi Purpose]** key.

The 10 preset measurements defined in the Quick Measurement configuration are enabled and results appear on the screen for the first waveform source.

- To measure parameters for another waveform, press the **[Multi Purpose]** key until that waveform is the one shown in the measurement readout. Continuing to press the **[Multi Purpose]** key cycles through each of the waveforms available.

- To turn off the quick measurement display, cycle through all channels until the measurements are turned off.

See the Infiniium oscilloscope application's online help for information on how to configure the quick measurement capability.

Using markers

Markers make it easier to make precise measurements because the marker measurement readouts show exact voltage and time positions for the markers. The measurements are based on actual waveform data from the acquisition system, not on approximations based on the display position, so you can be sure the values are highly accurate.

Using the marker and measurement controls, you control two sets of markers within the oscilloscope grid.

Both time and voltage differences between the markers are updated continuously on the screen. By default, the markers track the source waveform. Voltage measurements from the markers are the value of the waveform at the time set with the marker arrow keys.

- To select the type of marker mode you want to use, press the **[Markers]** key and select the mode in the pop-up dialog box.
- Set the parameters in the Markers dialog box.
- Marker 1 has a solid line pattern and Marker 2 has a dashed line pattern on the waveform display. Each is associated with the first available source on the display.
- Push the Position knob to toggle between Marker 1 and Marker 2. Turn the knob to move the marker.
- In Track Measurements mode, the marker position cannot be changed.
- Drag a marker to quickly move it to the desired waveform event. You can use the Marker Position knobs for fine adjustment, or click **Measure > Markers...** or the Markers button  and set the marker position precisely.

Saving and Printing Data

- Click **File > Save >** to save your composite, setup, waveform, screen image, or measurement data. You can also save to a waveform memory.
- Click **File > Print...** to send waveform and setup data to a specified printer.
- Click **File > Copy Screen Image** to easily copy and paste a screen image into a document.
- You can customize the **[Multi Purpose]** key to perform a QuickPrint.

Forcing a Default Setup

If your Infiniium oscilloscope is not working properly when you start it up, follow these steps to perform a default setup and return the oscilloscope to normal operation.

- 1 Click **Control > Default Setup** or press the **[Default Setup]** key.
- 2 If the oscilloscope is still not working properly, click **Control > Factory Default** to return the oscilloscope to the default settings it had when it left the factory.
- 3 If the oscilloscope is still not working properly, turn it off.
- 4 Turn the oscilloscope back on. If it does not successfully restart, try recycling the power again.
- 5 As soon as the Windows 7 load screen disappears, press **[Default Setup]**. If the oscilloscope still does not successfully restart, follow the instructions for recovering the hard drive.

Infiniium hard drive recovery

Follow these steps to recover your Infiniium hard drive.

- 1 Turn off the oscilloscope.
- 2 Connect the keyboard and mouse to the USB host ports on the back of the oscilloscope.
- 3 Turn on the oscilloscope.
- 4 As soon as you see the message **press F2 to boot the Infiniium Recovery System**, press **[F2]** and follow the on-screen instructions.
- 5 Once the recovery process is finished and the oscilloscope is running, check in the About Infiniium dialog box under installed options to see if all of the options you ordered are installed. If the options are not installed, install them using the license keys provided on the oscilloscope option license certificates you received, or refer to the back of the oscilloscope.

2 Using the Oscilloscope

3 Online Help and Other Information

Accessing the Online Help / 49

Navigating the Online Help / 51

Using the Demo Wizard / 52

Most of the information about using the Infiniium oscilloscope effectively is included in the online help.

To access the online help, click **Help > Contents...** from the menu bar or click the question mark in the top right corner of dialog boxes.

Accessing the Online Help

- Click **Help > Contents...**

The Using the Oscilloscope topic appears on the home page. It looks like the following figure.

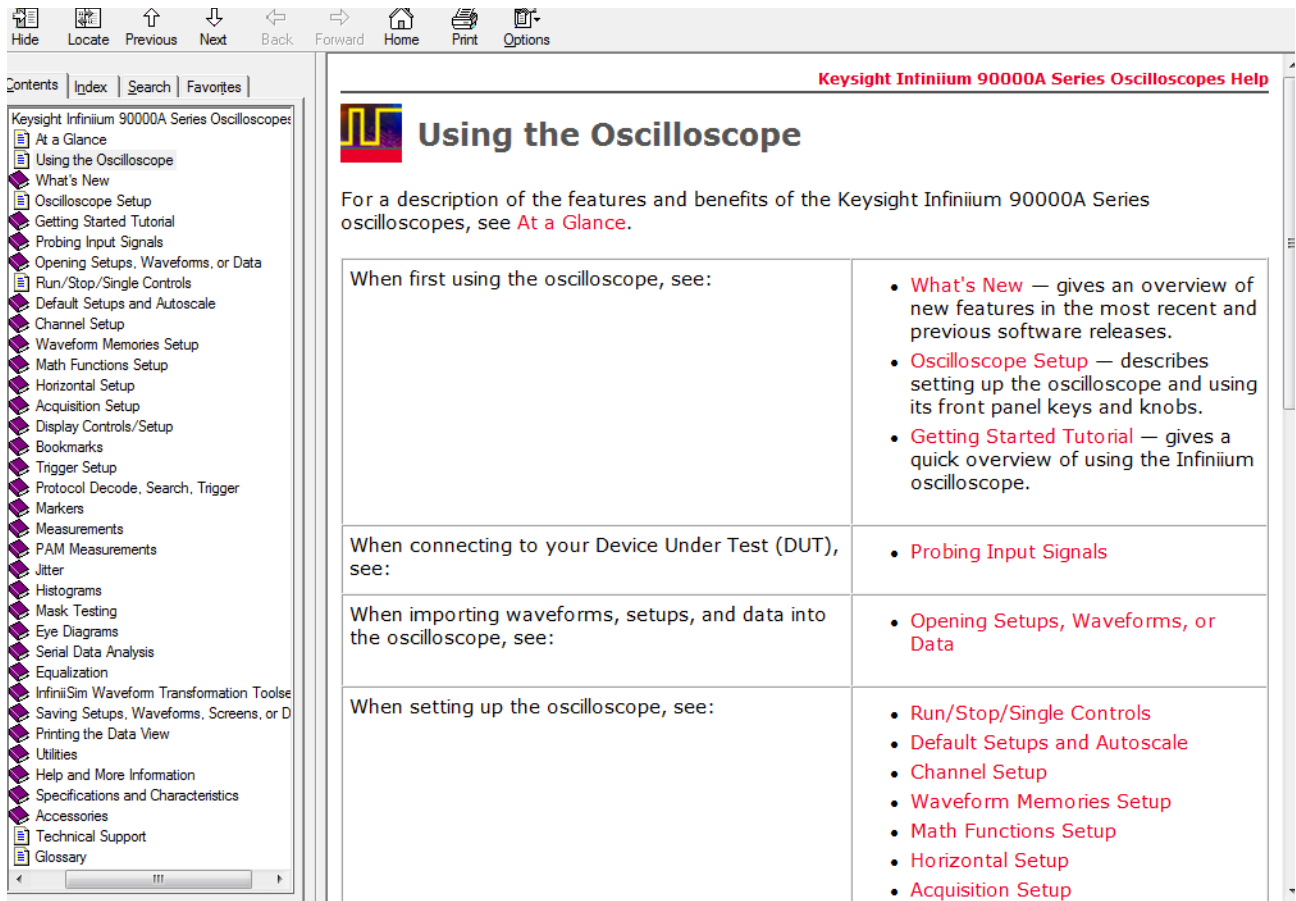



Figure 24 Online Help home page

For information about items in a dialog box, click the Help button  in that dialog box.

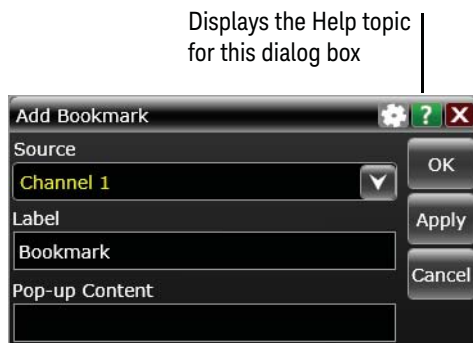

Figure 25 Help button for dialog box Help

Navigating the Online Help

The online help provides several ways to find the information you need.

Use the Contents tab to browse topics in the help system by clicking topics in the left pane.

Use the Index tab to type in a keyword and search the index for that keyword or scroll through the list to find a topic.

Use the Search tab to type in a keyword and if that word exists in the online help, a list of topics containing the keyword appears.

Use the Favorites tab to add preferred help topics to a list for easy reference.

Using the Demo Wizard

Your Infiniium oscilloscope comes with a built-in demo wizard that showcases many of the oscilloscope's capabilities. To see the demos, click **Help > Show Demo Wizard...** You can then select a specific demo, such as a particular protocol or a UI demo showing bookmarks.

For example, the following screen display shows the initial demo page for the FFT function. To experiment with the demo, click **Load Demo...**

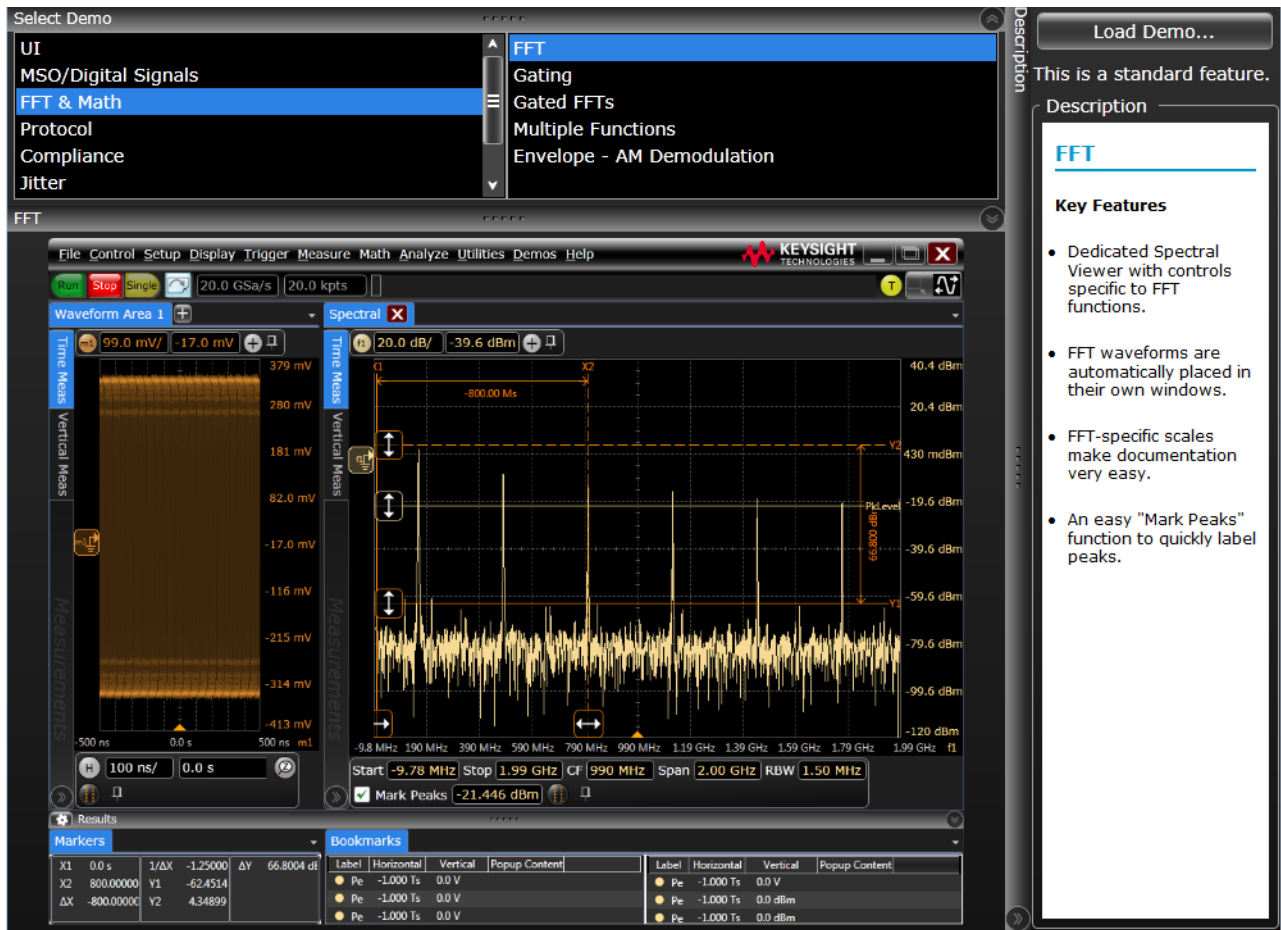

Figure 26 FFT demo



This information is subject to change without notice.

© Keysight Technologies 2007, 2008, 2015, 2017

Fourth edition, February 2017



54913-97029

www.keysight.com