

Keysight 81150A and 81160A Pulse Function Arbitrary Noise Generator

Getting Started
Guide

NOTICE: This document contains references to Agilent Technologies. Agilent's former Test and Measurement business has become Keysight Technologies. For more information, go to www.keysight.com.



Notices

© Keysight Technologies 2011, 2014

No part of this manual may be reproduced in any form or by any means (including electronic storage and retrieval or translation into a foreign language) without prior agreement and written consent from Keysight Technologies as governed by United States and international copyright laws.

Manual Part Number

81160-91010

Edition

Edition 2.0, August 2014

Printed in Germany

Keysight Technologies, Deutschland GmbH

Herrenberger Str. 130

71034 Böblingen, Germany

For Assistance and Support

<http://www.keysight.com/find/assist>

Warranty

This Keysight product has a warranty against defects in material and workmanship for a period of three years from date of shipment. During the warranty period, Keysight Technologies will, at its option, either repair or replace products that prove to be defective. For warranty service or repair, this product must be returned to a service facility designated by Keysight Technologies. The Buyer shall pay Keysight's round-trip travel expenses. For products returned to Keysight Technologies for warranty service, the Buyer shall prepay shipping charges to Keysight and Keysight shall pay shipping charges to return the product to the Buyer. However, the Buyer shall pay all shipping charges, duties and taxes for products returned to Keysight Technologies from another country. Keysight Technologies warrants that its software and firmware designated by Keysight for use with an instrument will execute its programming instructions when properly installed on that instrument. Keysight does not warrant that the operation of the instrument software, or firmware, will be uninterrupted or error free.

Limitation of Warranty

The foregoing warranty shall not apply to defects resulting from improper or inadequate maintenance by the Buyer, Buyer-supplied software or interfacing, unauthorized modification or misuse, operation outside of the environmental specifications for the product, or improper site preparation or maintenance.

No other warranty is expressed or implied. Keysight Technologies specifically disclaims the implied warranties of merchantability and fitness for a particular purpose.

Exclusive Remedies

The remedies supplied are the Buyer's sole and exclusive remedies. Keysight Technologies shall not be liable for any direct, indirect, special, incidental, or consequential damages, whether based on contract, tort or any other legal theory.

Assistance

Product maintenance agreements and other customer assistance agreements are available for Keysight products. For any assistance, contact your nearest Keysight Sales Office.

Certification

Keysight Technologies Company certifies that this product met its published specifications at the time of shipment. Keysight further certifies that its calibration measurements are traceable to the United States Institute of Standards and Technology, to the extent allowed by the Institute's calibrating facility, and to the calibration facilities of other International Standards Organization members.

Safety Summary

General Safety Precautions

The following general safety precautions must be observed during all phases of operation of this instrument. Failure to comply with these precautions or with specific warnings elsewhere in this manual violates safety standards of design, manufacture, and intended use of the instrument.

Keysight Technologies assumes no liability for the customer's failure to comply with these requirements.

Before operation, review the instrument and manual for safety markings and instructions. You must follow these to ensure safe operation and to maintain the instrument in safe condition.

General

This product is a Safety Class 1 instrument (provided with a protective earth terminal). The protective features of this product may be impaired if it is used in a manner not specified in the operation instructions.

All Light Emitting Diodes (LEDs) used in this product are Class 1 LEDs as per IEC 60825-1.

Environment Conditions

This instrument is intended for indoor use in an installation category II, pollution degree 2 environment. It is designed to operate at a maximum relative humidity of 95% and at altitudes of up to 2000 meters.

Refer to the specifications tables for the ac mains voltage requirements and ambient operating temperature range.

Before Applying Power

Verify that all safety precautions are taken. The power cable inlet of the instrument serves as a device to disconnect from the mains in case of hazard. The instrument must be positioned so that the operator can easily access the power cable inlet. When the instrument is rack mounted the rack must be provided with an easily accessible mains switch.

Ground the Instrument

To minimize shock hazard, the instrument chassis and cover must be connected to an electrical protective earth ground. The instrument must be connected to the ac power mains through a grounded power cable, with the ground wire firmly connected to an electrical ground (safety ground) at the power outlet. Any interruption of the protective (grounding) conductor or disconnection of the protective earth terminal will cause a potential shock hazard that could result in personal injury.

Services and Support

Any adjustment, maintenance, or repair of this product must be performed by qualified personnel. Contact your customer engineer through your local Keysight Technologies Service Center. You can find a list of local service representatives on the Web at: <http://www.keysight.com/Service/English/index.html>

Do Not Operate in an Explosive Atmosphere

Do not operate the instrument in the presence of flammable gases or fumes.

Do Not Remove the Instrument Cover

Operating personnel must not remove instrument covers. Component replacement and internal adjustments must be made only by qualified personnel.

Instruments that appear damaged or defective should be made inoperative and secured against unintended operation until they can be repaired by qualified service personnel.

Safety Symbols on Instruments



Indicates warning or caution. If you see this symbol on a product, you must refer to the manuals for specific Warning or Caution information to avoid personal injury or damage to the product.



Notice for European Community: This product complies with the relevant European legal Directives: EMC Directive 89/336/EEC and Low Voltage Directive 73/23/EEC.



General Recycling Mark for plastic parts used in the product.



Safety requirements for electrical equipment for measurement, control, and laboratory use CAN/CSA C22.2 No. 1010.1 (1993) UL 3101, 3111 (First Editions). This equipment has also been evaluated to IEC 61010 edition 1 including amendments 1 and 2.



Conformity Mark of the Australian ACA for EMC compliance.

Environmental Information

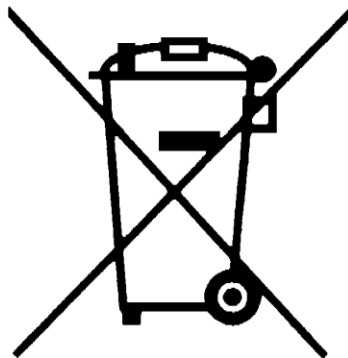

This product complies with the WEEE Directive (2002/96/EC) marketing requirements. The affixed label indicates that you must not discard this electrical/electronic product in domestic household waste.

Product category: With reference to the equipment types in the WEEE Directive Annexure I, this product is classed as a "Monitoring and Control instrumentation" product.

Do not dispose in domestic household waste.

To return unwanted products, contact your local Keysight office, or see

www.keysight.com/environment/product/ for more information.

Contents

Contents	6
1 Introduction	8
2 Installing the 81150A/81160A	10
2.1 The Front Panel.....	11
2.2 The Front-Panel Display at a Glance.....	15
2.2.1 Menu Mode.....	15
2.2.2 Graph Mode.....	16
2.3 The Rear Panel.....	17
3 Getting Started	19
3.1 Setting up a Clock Signal.....	20
3.2 Setting up a Pulse Signal.....	27
3.3 Setting up a Continuous Burst.....	38
3.4 Setting up a Triggered Burst.....	43
3.5 To output a Modulated Waveform.....	50
3.6 To output an FSK Waveform.....	55
3.7 To output a Frequency Sweep.....	61
3.8 Setting up a Triggered Frequency Sweep.....	67
3.9 Coupling between Channels.....	74
3.9.1 Settings for Channel 1.....	74
3.9.2 Settings for Channel 2.....	76
3.10 Adding up Channel 1 and Channel 2.....	84
3.10.1 Settings for Channel 1.....	85
3.10.2 Settings for Channel 2.....	89
4 Installation and Maintenance	96
4.1 Options and Accessories.....	96
4.2 Power Requirements.....	97
4.3 Ventilation Requirements.....	98
4.3.1 Thermal Protection.....	98
4.4 Battery.....	99

4.5	Operating Environment.....	100
4.6	Cleaning Recommendation	101

1 Introduction

Introduction

The Keysight Technologies 81150A and 81160A are Pulse Pattern and Function Arbitrary Noise Generators with built-in arbitrary waveform and pulse capabilities.

The 81150A offers pulse generation up to 120 MHz and sine wave generation up to 240 MHz.

The 81160A offers pulse generation up to 330 MHz and sine wave generation up to 500 MHz.

Standard Deliverables

Check if the Keysight 81150A / 81160A shipping container contains the following standard deliverables:

- The Keysight 81150A / 81160A Pulse Pattern and Function Arbitrary Noise Generator
 - Power Cable
 - USB Cable
 - The Product CDs (contains the User Guide and the Getting Started Guide)
-

General Instructions

- If the contents are incomplete, if there is a mechanical damage, or if the instrument does not work within its specifications, notify the nearest Keysight Office. The Keysight office will arrange for the repair or replacement without awaiting settlement.
 - Once you have plugged in the instrument, you can start using it.
 - Make sure you keep the ventilation holes free whenever you install the instrument.
-

Note

Refer to the User Guide delivered on the Product CD if you need more information about working with the instrument.

2 Installing the 81150A/81160A

Introduction

This section guides you through the first steps when installing/operating the 81150A / 81160A via the user interface.

For information on operating the 81150A / 81160A via the Remote Interface, refer to the Remote Programming Reference chapter in the 81150A and 81160A User Guide.

Switching On the Instrument

The instrument executes the power-on self test during the boot phase. If there are errors, the instrument displays the power-on error messages. These messages can be seen any time later as they are not cleared until the instrument is switched off.

2.1 The Front Panel

Introduction

The instrument is mainly operated from the front panel, when used for bench top testing.

Now that you have unpacked the instrument and plugged it in, let us take a look at the main elements of the Front Panel. These are shown and explained in brief below.

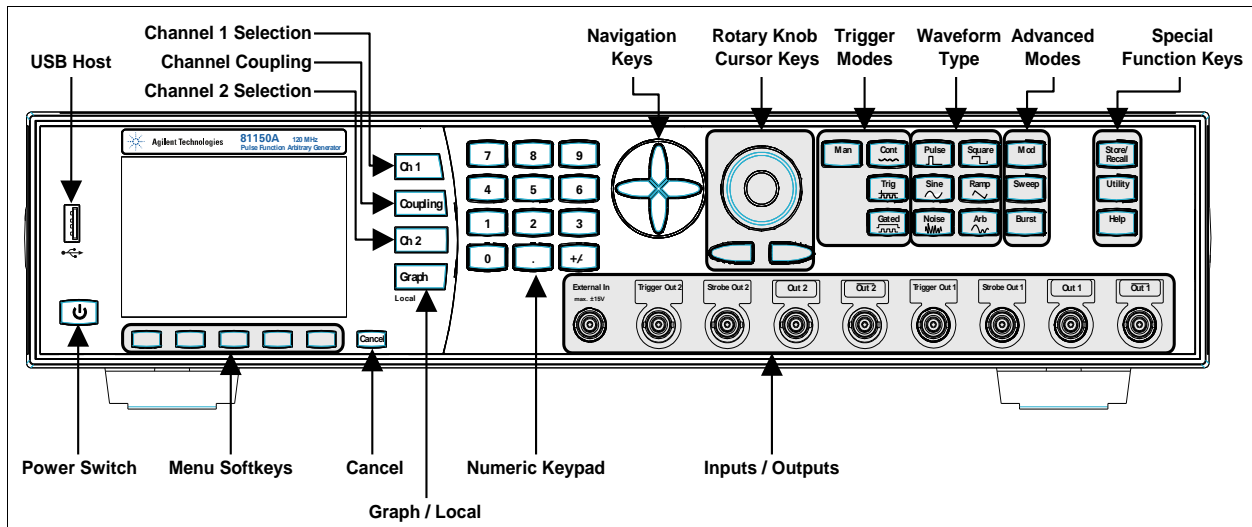

Front-panel of the 81150A

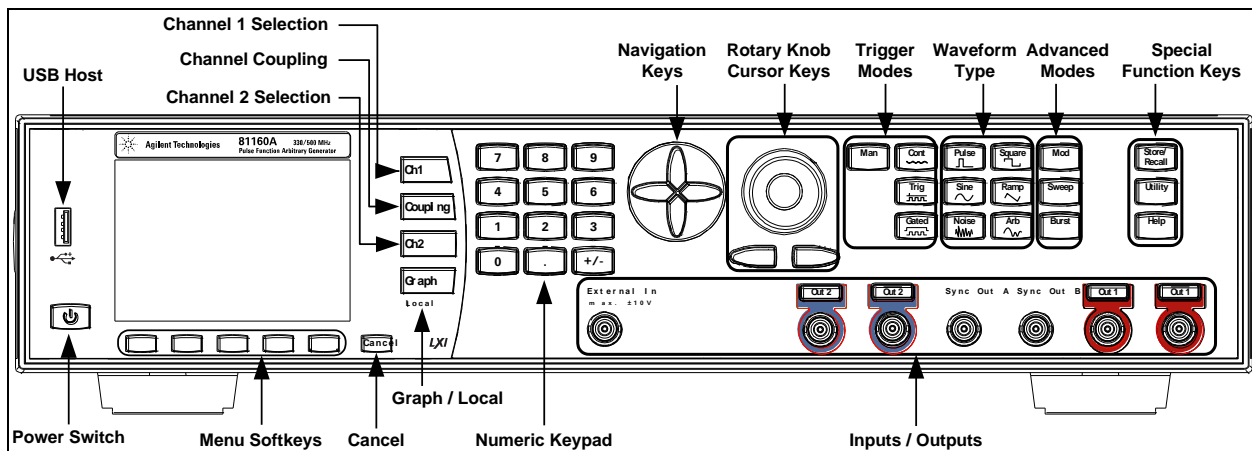

Front-panel of the 81160A

Installing the 81150A/81160A

Keys/Switch	Function
Power Switch	Used to switch on and off the instrument.
USB	The Front Panel contains a USB host connector. It is intended to connect USB drives to store instrument states and waveforms on an external memory.
Menu Softkeys	The five keys below the main display screen are called softkeys (software-controlled keys). The current function of each softkey is indicated in the corresponding box on the display. The More softkey switches to the next layer of softkeys on the current screen.
Cancel	Cancels the selection and helps you exit out of a screen.
Ch 1 Selection	Selects channel 1 as to be controlled from the front panel.
Ch 2 Selection	Selects channel 2 to be controlled from the front panel.
Channel Coupling	<p>Enables/disables the channel coupling. Refer to the 81150A and 81160A User Guide for more information on Channel Coupling.</p> <p> Unlike all the other keys on the Front Panel, the Coupling key is not protruded or alleviated. It is flat and is embedded inside the instrument. This is done intentionally to avoid accidental pressing of the coupling key as pressing it would over-write the settings.</p>
Graph/Local	<p>In Local Mode: Toggles between textual and graphical representation of the waveform.</p> <p>In Remote Mode: Switch back to local operation.</p>
Numeric Keypad, Cursor Keys, Rotary Knob	These keys are used to select and modify parameters when operating the instrument.
Navigation Keys	Used to navigate between the parameters on the screen. These keys provide an alternative method of navigation to the softkey menus.
Inputs/Outputs	<ul style="list-style-type: none"> • The EXTERNAL IN can be used to connect an external arming source (triggered or gated modes). • 81150A only: The TRIGGER OUT marks the start of the pulse period or of parts of a pattern

Keys/Switch	Function
	<ul style="list-style-type: none"> • 81150A only: The STROBE OUT marks beginning and end of a burst, marks the beginning of a sweep and outputs the modulation signal. • 81160A only: The SYNC OUT connector. The Logical TRIGGER Signal or the Logical STROBE Signal can be routed to the SYNC OUT. • The OUTPUT connectors provide the signal output (normal and inverted) and the indicators show the current state of the output (on or off).
Special Function Keys: Store/Recall, Utility; Help	<p>The STORE/RECALL key can be used to store to/recall from 1 to 4 individual settings in the instrument memory.</p> <p>The UTILITY key provides access to system settings, output amplifier and clock reference configuration, self-test and self calibration functionalities.</p> <p>The HELP key provides access to the instrument's built-in help system or in warning or error state, access to Warning/Error Report screen.</p>
Trigger Mode Keys	<p>The following trigger modes are available:</p> <ul style="list-style-type: none"> • Continuous • External Triggered • External Gated • Internal Triggered • Manual <p>The MAN key can be used to manually trigger or gate the instrument.</p> <p>Refer to the 81150A and 81160A User Guide for more information on the Trigger Modes.</p>
Waveform Types	<p>Includes standard waveforms and pre-defined arbitrary waveforms.</p> <p>Refer to the 81150A User Guide for more information on the Waveform Types.</p>
Advanced modes of Operation	<p>There are three advanced modes of operation available:</p> <ul style="list-style-type: none"> • Modulation: Selects the modulation type from AM, FM, PM, FSK, PWM. • Sweep: For frequency sweeps. • Burst: Repeats selected waveform n times. <p>Refer to the 81150A and 81160A User Guide for more information on the Advanced Modes of Modulation.</p>

Installing the 81150A/81160A

Note

To get context-sensitive help on any front-panel key or menu softkey, press and hold down that key.

2.2 The Front-Panel Display at a Glance

Introduction This section explains the Menu and the Graph mode as seen on the Front Panel of the 81150A and 81160A.

2.2.1 Menu Mode

Introduction This section explains the Menu as seen on the Front Panel of the 81150A/81160A.

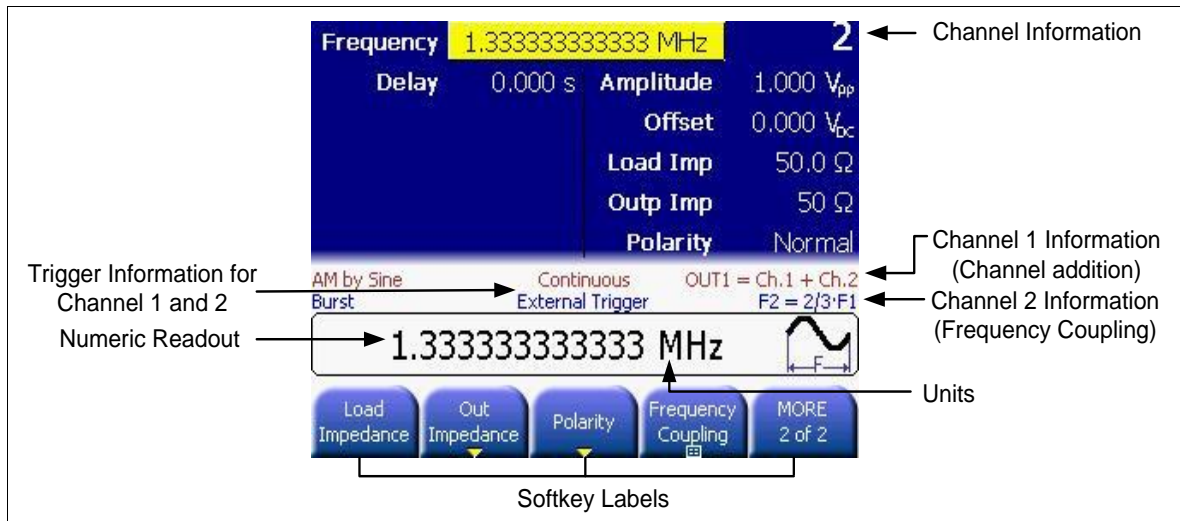

2.2.2 Graph Mode

Introduction

To enter the Graph mode, press the **Graph** key.

To exit, press the **Graph** key again.

Note

Not all screens do have a graphical representation.

The trigger mode screen will always be in textual mode, even if graph mode is enabled.

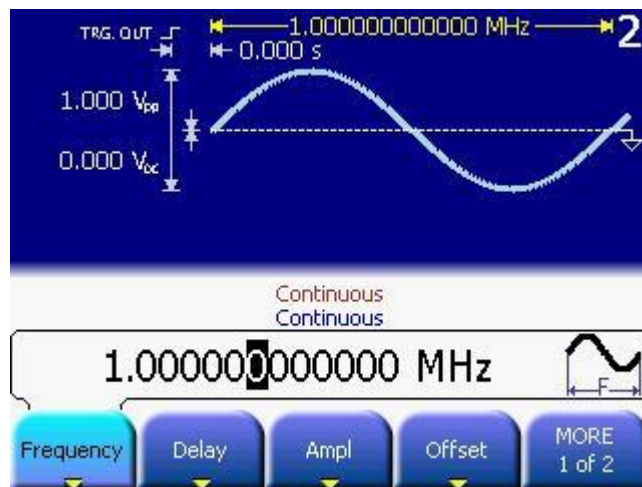

2.3 The Rear Panel

Introduction

The rear panel contains:

- GPIB connector
- USB device connector
- LAN connector

These three are used for remote control of the instrument.

- Channel 1 Modulation In
- Channel 2 Modulation In (2 channel instrument only)
- 10 MHz Clock Ref-In
- 10 MHz Clock Ref-Out

A USB Host Connector is used to connect external USB storage device for storing instrument settings or software updates.

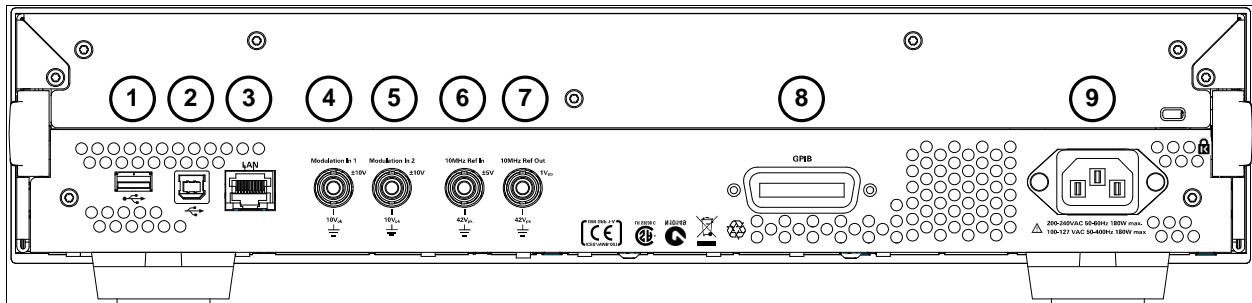

Rear panel of the 81150A

- 1 USB Interface Connector (Host type for external mass memory)
- 2 USB Interface Connector (device type for remote programming)
- 3 LAN Interface Connector
- 4 Channel 1 External Modulation Input Terminal
- 5 Channel 2 External Modulation Input Terminal
- 6 External 10 MHz Reference Input Terminal
- 7 10 MHz Reference output Terminal
- 8 GPIB Interface Connector
- 9 Power

Installing the 81150A/81160A

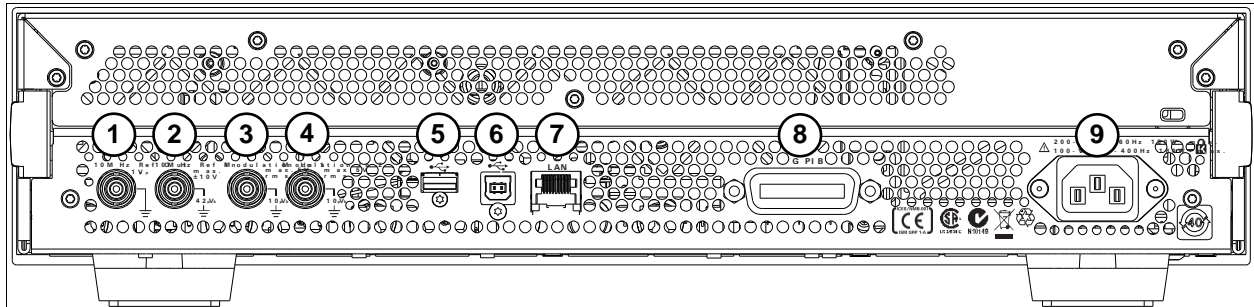

Rear panel of the 81160A

- 1** External 10 MHz Reference Input Terminal
 - 2** External 10 MHz Reference Output Terminal
 - 3** Channel 1 External Modulation Input Terminal
 - 4** Channel 2 External Modulation Input Terminal
 - 5** USB Interface Connector (Host type for external mass memory)
 - 6** USB Interface Connector (device type for remote programming)
 - 7** LAN Interface Connector
 - 8** GPIB Interface Connector
 - 9** Power
-

3 Getting Started

Introduction

The intention of this chapter is to give the necessary steps to set up generic signals for first-time users of the 81150A/81160A.

This chapter provides examples for the following types of signals:

- Setting up a Clock Signal
- Setting up a Pulse Signal
- Setting up a Continuous Burst
- Setting up a Triggered Burst
- To output a Modulated Waveform
- To output an FSK Waveform
- To output a Frequency Sweep
- Setting up a Triggered Frequency Sweep
- Coupling between Channels
- Adding up Channel 1 and Channel 2

Remarks

All screenshots in this chapter have been made using an 81150A. The 81160A default settings in the User Interface will show different default settings at some locations. Also, the measurement results displayed in this chapter have been made with an 81150A. The measurement results from an 81160A will differ as e.g. the 81160A can generate faster transition times.

3.1 Setting up a Clock Signal

Task To set up a continuous clock signal with 50 MHz frequency, a duty cycle of 50%, a high Level of 2.5 V and a low level of 0.0 V.

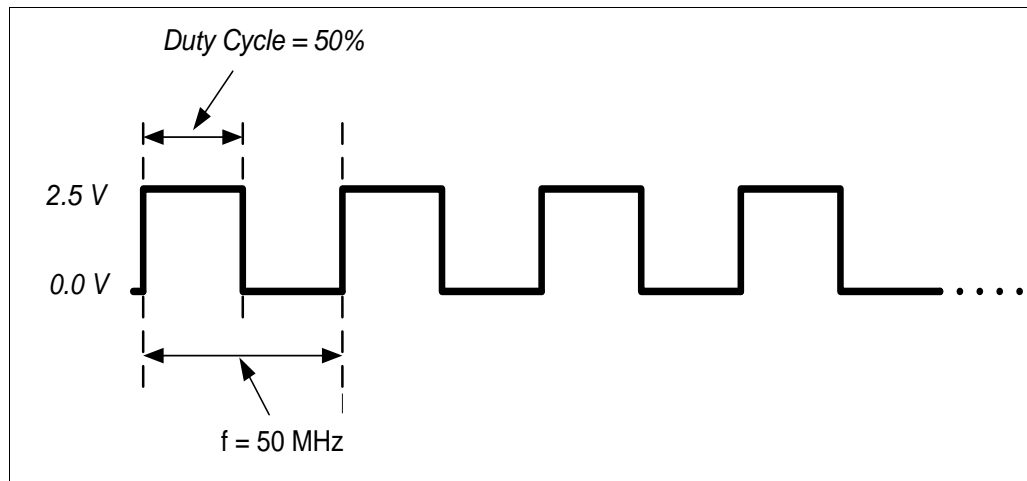

Selecting a Square Waveform

To set the operating mode and trigger mode as required, do the following:

- Before setting any values, press the **Store/Recall** key and press the **Set to Defaults** softkey. Confirm the action by pressing the **Yes** softkey.
- Press the **Ch 1** key to select channel 1.
- Press the normal and inverted output keys to enable both outputs of channel 1.
- The *Continuous* trigger mode is enabled by default. Therefore, we only need to select a square waveform. To select a square waveform, simply press the **Square** key given on the Front Panel. This brings you to the following screen.

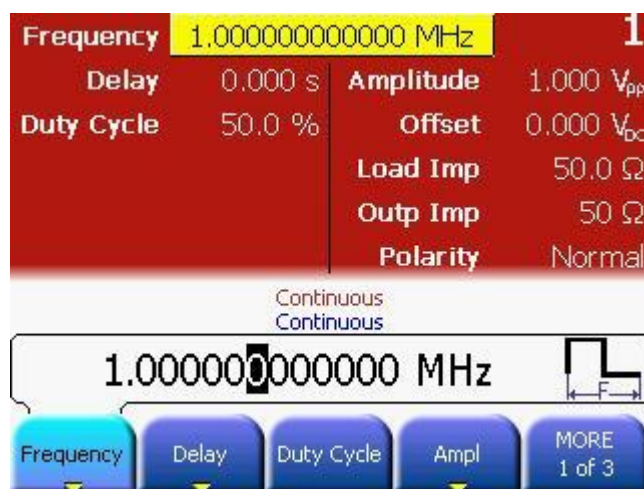

Important Tip

- Pressing the **Period** softkey selects period and pressing it again toggles to **Frequency** softkey.
- If the **Frequency** softkey is already selected, do not press it again as it will toggle to the **Period** softkey.

Getting Started

Selecting Frequency

- Press the **Frequency** softkey and set the frequency to 50 MHz.
- ✎ For setting the value, you can use the Numeric Keypad or the Rotary Knob.
- From the various available options, choose the desired unit by simply pressing it.

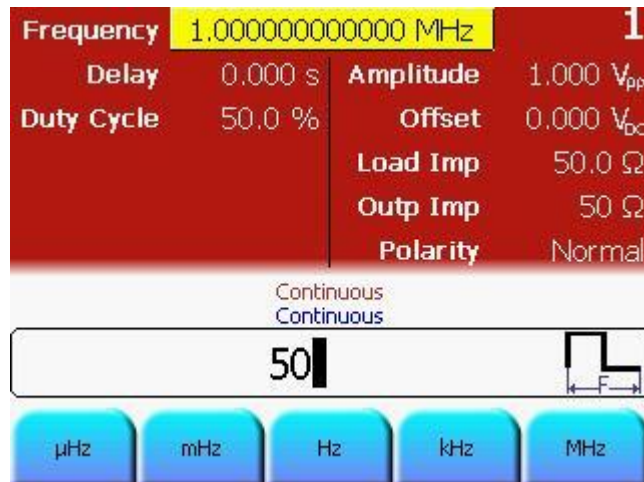

Selecting Duty Cycle

- The value of Duty Cycle is set to 50% by default. Therefore, there is no need to change it.



Selecting the Ampl or Offset voltage

- This can be done by navigating to the field using the navigation keys, or by pressing the **Ampl** or **Offset** softkey.

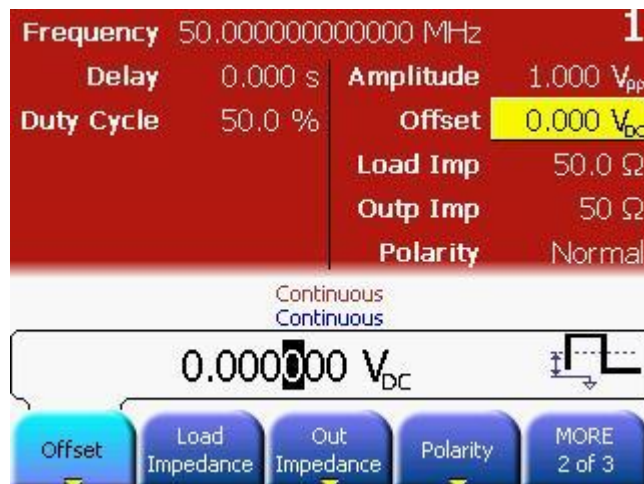

Switch to High/Low Level representation

- Press the **Ampl** or **Offset** softkey again and then select High/Low by pressing the corresponding softkey.

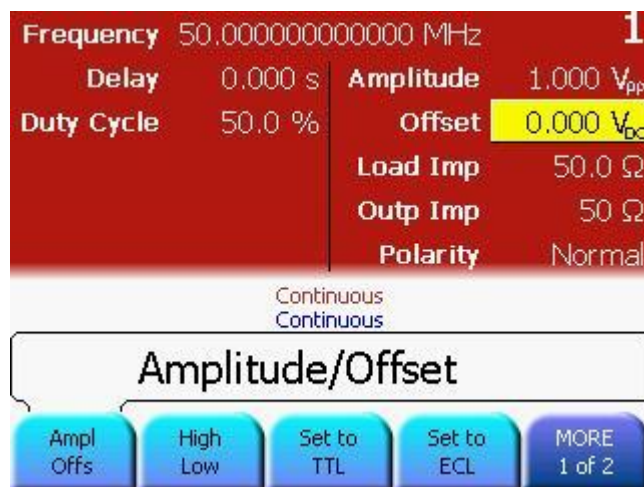

Getting Started

Setting the Low Level

- Select the Low Level by pressing the **Low** softkey, or by using the navigation keys.
- Set the value to 0.0 V. Use the numeric keypad, or the navigation cursor and rotary knob to set the values.
- Select the appropriate unit shown in the following screen.

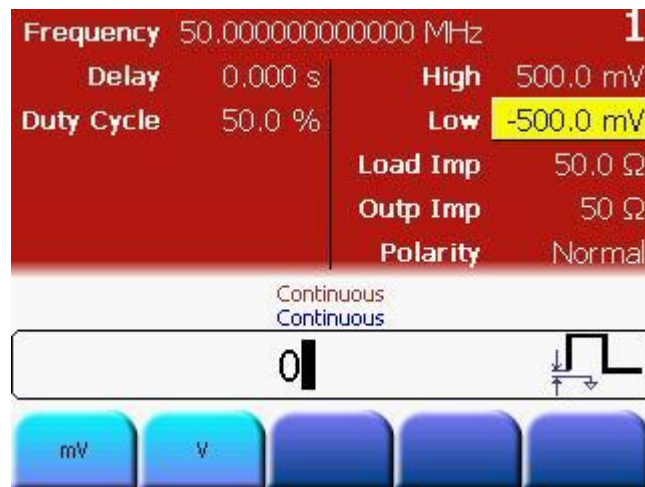

Setting the High Level

- Select the High Level by pressing the **High** softkey, or by using the navigation keys.
- Set the value to 2.5 V. Use the numeric keypad, or the navigation cursor and rotary knob to set the values.
- Select the appropriate unit shown in the following screen.

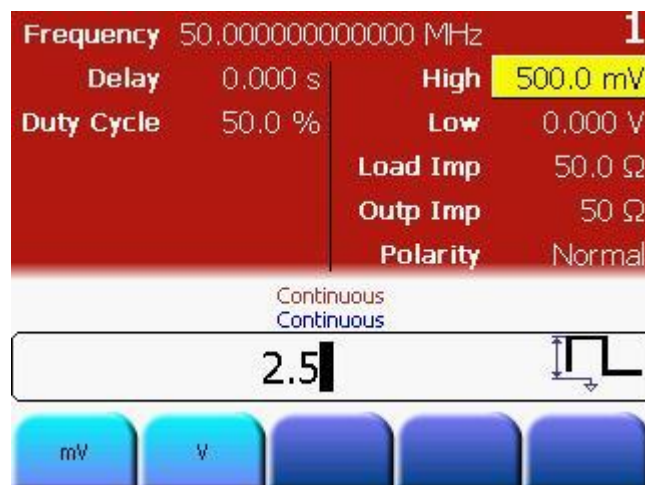

**Programming
Example**

```
# Reset the instrument to start from a defined, default status.
*RST

# Switch off the automatic display update to increase programming
# speed
:DISPlay OFF

# Set the output function of output 1 to square
:FUNcTion1 SQUare

# Set the frequency to 50 MHz, the duty cycle to 50%
# Settings are programmed for output 1.
:FREQuency1 50MHZ
:FUNcTion1:SQUare:DCYClE 50

# For example, the same settings for the optional second channel will
# look like as follows:
#:FUNcTion2 SQUare
#:FREQuency2 50MHZ
#:FUNcTion2:SQUare:DCYClE 50

# Set the high level to 2.5 Volts, the low level to 0.0 Volts.
:VOLTagE1:HIGH 2.5V
:VOLTagE1:LOW 0V

# Enable the output 1 and the complement output 1.
:OUTput1 ON
:OUTput1:COMPlEment ON
```

Getting Started

Oscilloscope screen-shot

The following image shows the signal as displayed on the Keysight 54810A Infiniium Oscilloscope. Use the Trigger Out to trigger the scope.

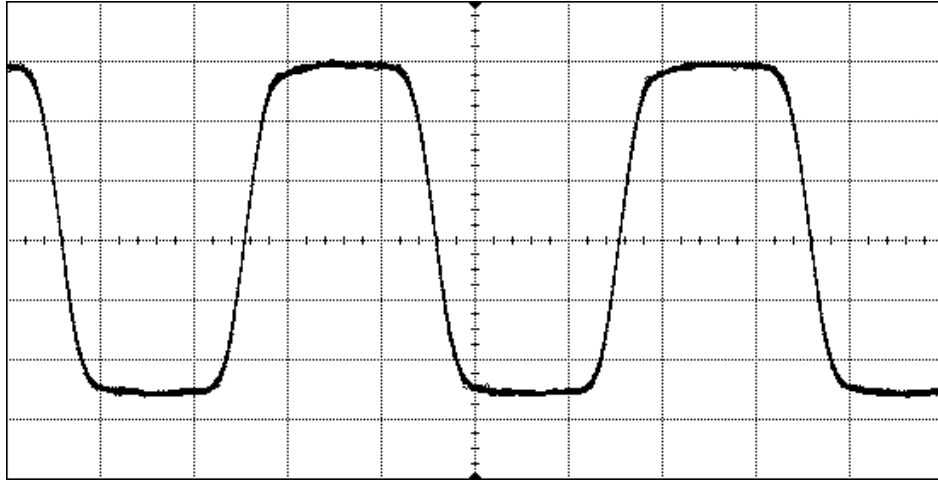

Note

The waveform has been generated with an 81150A.

3.2 Setting up a Pulse Signal

Task

To set up a continuous pulse signal with 20 ns period, a width of 10 ns, a high Level of 3.3 V and a low level of 0.0 V.

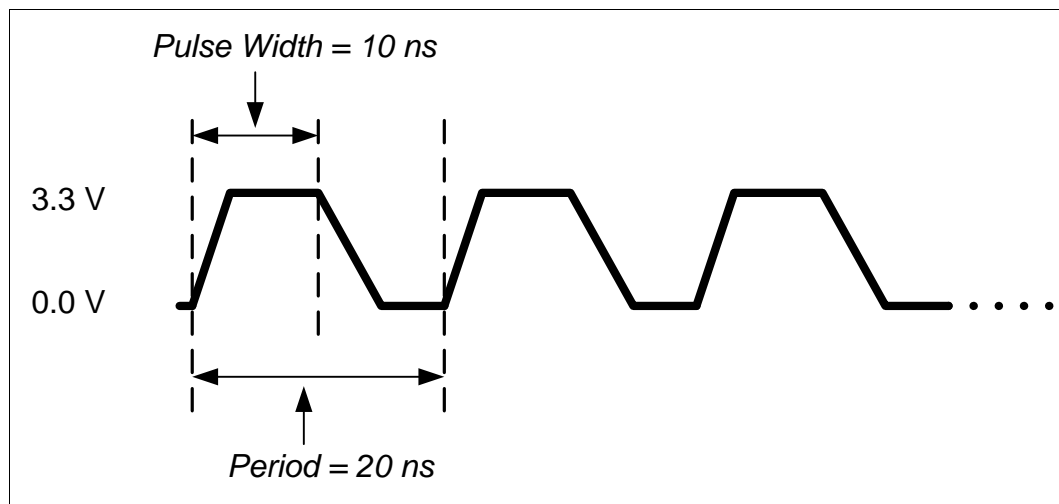

Getting Started

Selecting a Pulse Waveform

To set the operating mode and trigger mode as required, do the following:

- Before setting any values, press the **Store/Recall** key and press the **Set to Defaults** softkey. Confirm the action by pressing the **Yes** softkey.
- Press **Ch 1** key to select channel 1.
- Press the normal and inverted output keys to enable both outputs of channel 1.
- The *Continuous* trigger mode is enabled by default. Therefore, we only need to select a Pulse waveform. To select a Pulse waveform, simply press the **Pulse** key given on the Front Panel. This brings you to the screen shown below.



Selecting Frequency

- Pressing the **Frequency** softkey selects frequency. Press it again to toggle to **Period** softkey. Set the value of the Period to 20 ns.
- ✎ For setting the value, you can use the Numeric Keypad or the Rotary Knob.
- From the various available options, choose the desired unit by simply pressing it.

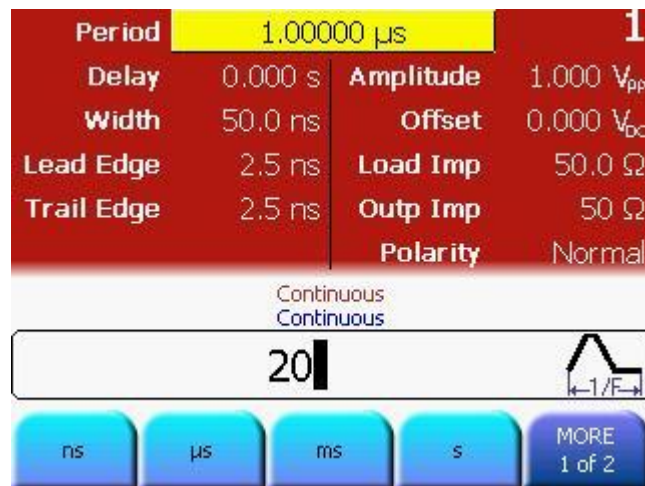

Getting Started

Selecting Width

- Press the **Width** softkey and set the value to 10 ns.
- ✎ The default value is set to Width although the Width softkey contains *Width*, *Duty Cycle*, and *Trail Delay* representations.
- ✎ For setting the value, you can use the Numeric Keypad or the Rotary Knob.
- From the various available options, choose the desired unit by simply pressing it.

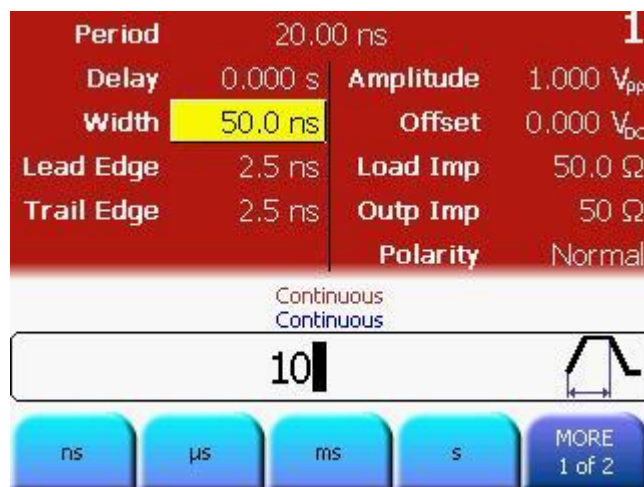

Setting the Lead Edge

- Press the **Lead Edge** softkey to set the Lead Edge value.
- Set the value to 3 ns.
- ✎ For setting the value, you can use the Numeric Keypad or the Rotary Knob.
- ✎ To set the value of Lead Edge in %, press the Lead Edge softkey again.
- From the various available options, choose the desired unit by simply pressing it.

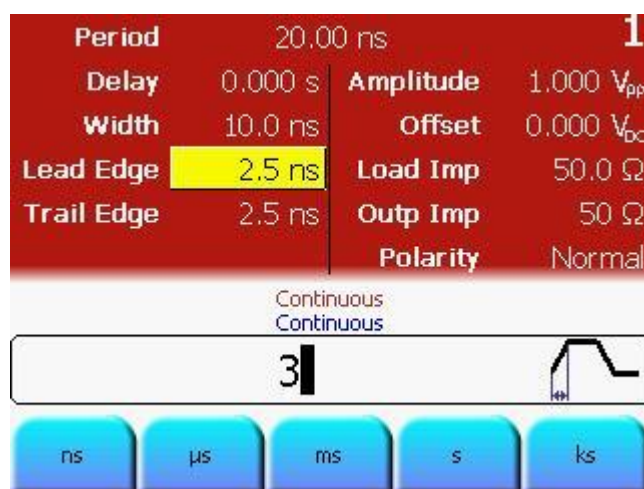
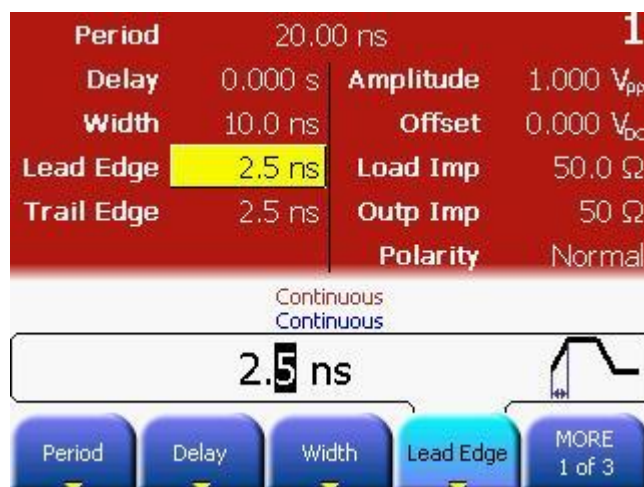

Getting Started

Setting the Trail Edge

- Press the **More** softkey to go to the **Trail Edge** softkey to set the Trail Edge value.
- Set the value to 5 ns.
- ✎ For setting the value, you can use the Numeric Keypad or the Rotary Knob.
- ✎ Press the **Trail Edge** softkey again to choose a different unit as shown in the subsequent screenshot.

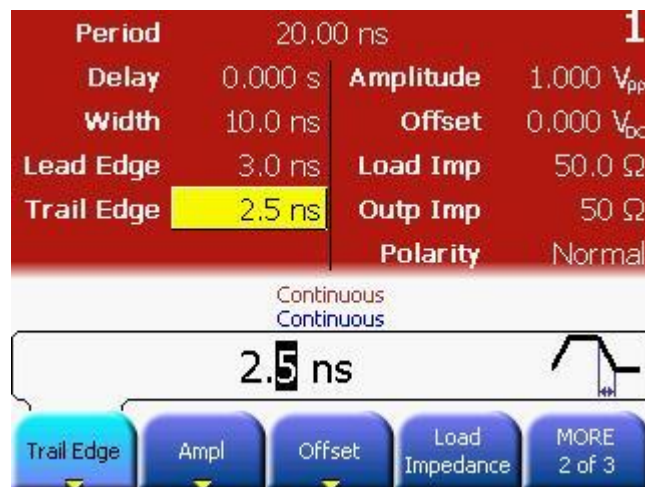

Selecting the unit

- From the various available options, choose the desired unit by simply pressing it.

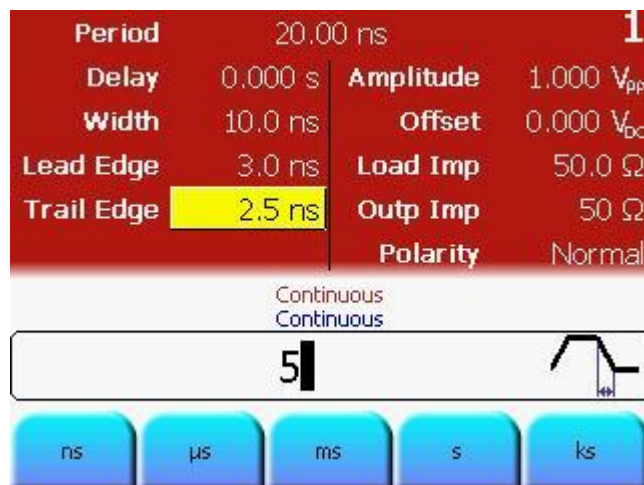
**Selecting the Ampl or Offset**

- Select the amplitude or offset voltage value. This can be done by navigating to the field using the navigation keys, or by pressing the **Ampl** or **Offset** softkey.



Getting Started

Switch to High/Low Level representation

- Press the **Ampl** or **Offset** softkey again and then select High/Low by pressing the corresponding softkey.

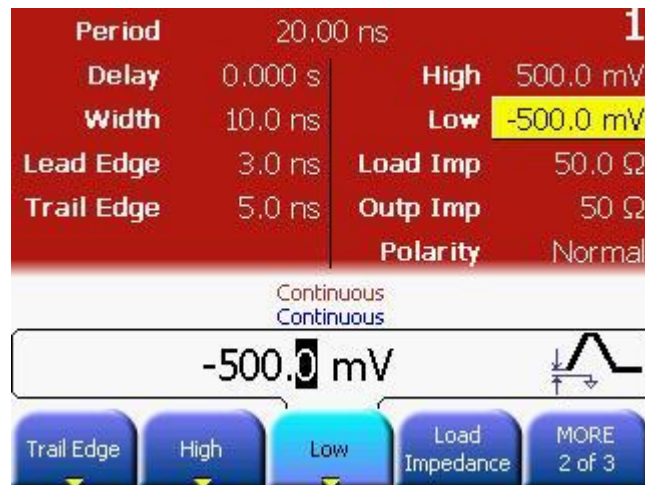

Setting the Low Level

- Select the Low Level by pressing the **Low** softkey, or by using the navigation keys.
- Set the value to 0.0 V. Use the numeric keypad, or the navigation cursor and rotary knob to set the values.
- Select the appropriate unit shown in the following screen.

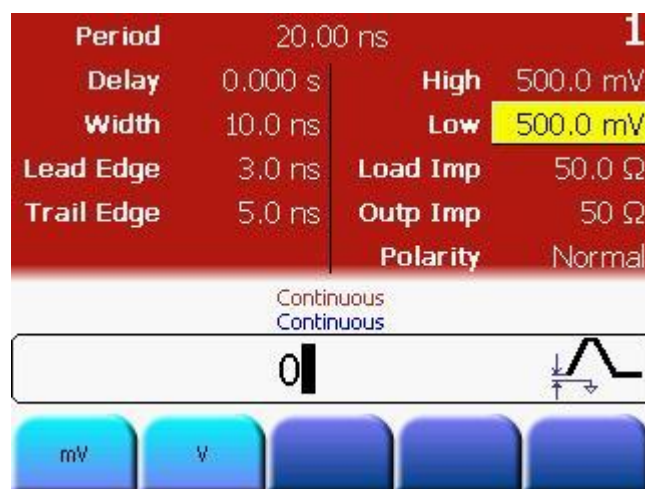

Setting the High Level

- Select the High Level by pressing the **High** softkey, or by using the navigation keys.
- Set the value to 3.3 V. Use the numeric keypad, or the navigation cursor and rotary knob to set the values.
- Select the appropriate unit shown in the following screen.

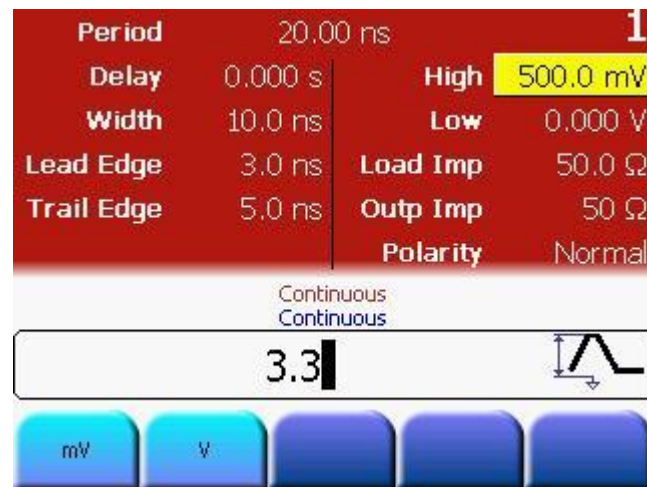

Getting Started

Programming Example

```
# Reset the instrument to start from a defined, default status.
*RST

# Switch off the automatic display update to increase programming
# speed
:DISPlay OFF

# Set the output function of output 1 to pulse.
:FUNction1 PULSe

# Set the period to 20 ns, the pulse width to 10 ns, the leading edge
# to 3 ns and the trailing edge to 5 ns.
# Settings are programmed for output 1.
:PULSe:PERiod1 20NS
:PULSe:WIDTh1 10NS
:PULSe:TRANsition1 3NS
:PULSe:TRANsition1:TRAILing:AUTO OFF
:PULSe:TRANsition1:TRAILing 5NS

# Set the high level to 3.3 Volts, the low level to 0.0 Volts.
:VOLTag1:HIGH 3.3V
:VOLTag1:LOW 0V

# Enable the output 1 and the complement output 1.
:OUTput1 ON
:OUTput1:COMPLement ON
```

**Oscilloscope
screen-shot**

The following image shows the signal as displayed on the Keysight 54810A Infiniium Oscilloscope. Use the Trigger Out to trigger the scope.

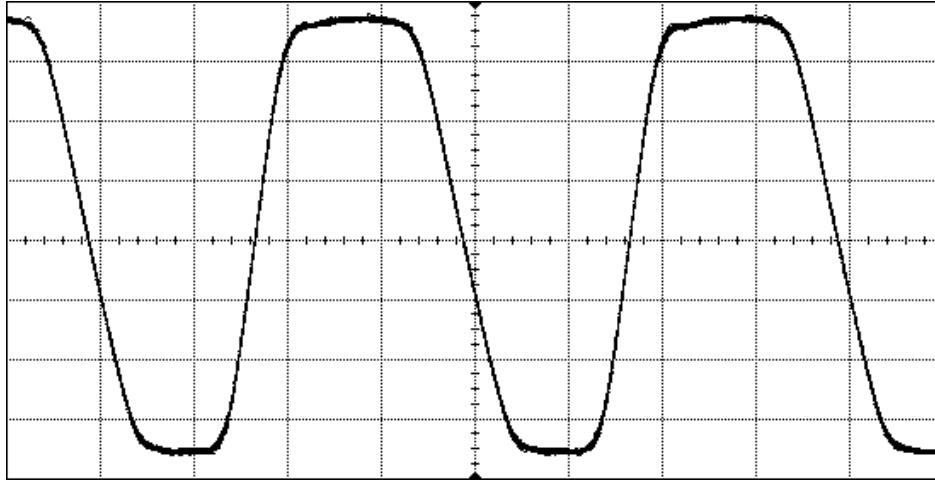

Note:

The waveform has been generated with an 81150A.

3.3 Setting up a Continuous Burst

Task

To set up a continuous burst signal with 500 ns period, Pulse width of 100 ns and a burst length of 4 cycles.

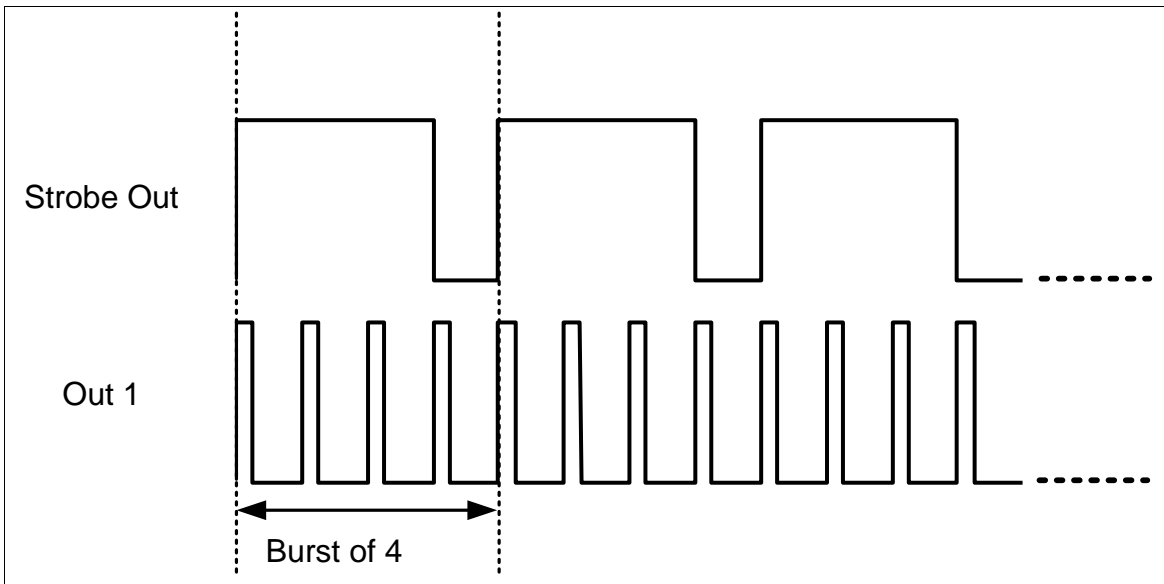



Selecting a Pulse Waveform

To set the operating mode and trigger mode as required, do the following:

- Before setting any values, press the **Store/Recall** softkey and press the **Set to Defaults** softkey. Confirm the action by pressing the **Yes** softkey.
- Press the **Ch 1** key to select channel 1.
- Press the normal and inverted output keys to enable both outputs of channel 1.
- The *Continuous* trigger mode is enabled by default. Therefore, we only need to select a *Pulse* waveform. To select a Pulse waveform, simply press the **Pulse** softkey given on the Front Panel.

Setting the Period

- Pressing the **Frequency** softkey selects frequency. Press it again to toggle to **Period** softkey. Set the value of the Period to 500ns.
-  For setting the value, you can use the Numeric Keypad or the Rotary Knob.
-  From the various available options, choose the desired unit by simply pressing it.

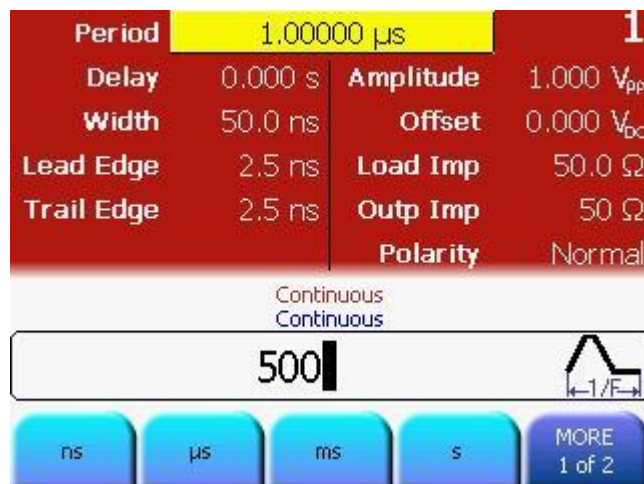

Getting Started

Setting the Width

- Press the **Width** softkey and set the value of Width to 100 ns. Use the navigation cursor and rotary knob, or the cursor keys and rotary knob to set the value.
- ✎ Press the **Width** softkey again to toggle to the different representations of Width: Width, Duty Cycle, and Trail Delay.
- ✎ From the various available options, choose the desired unit by simply pressing it.

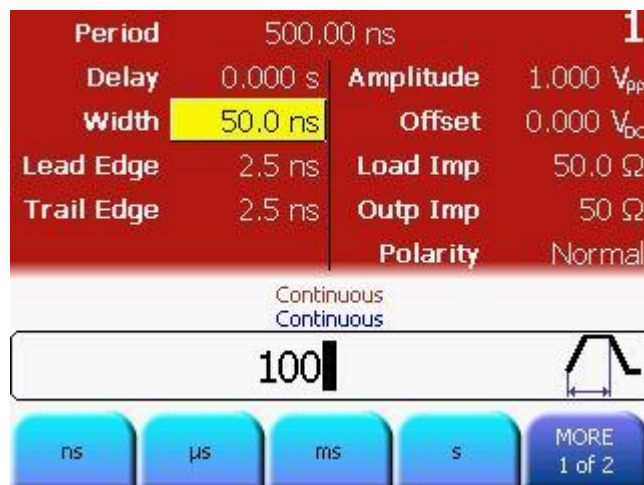

Setting the Burst length

- Press the **Burst** key to select Burst.
- Set the Burst Length to 4 using the numeric keypad or the navigation keys.

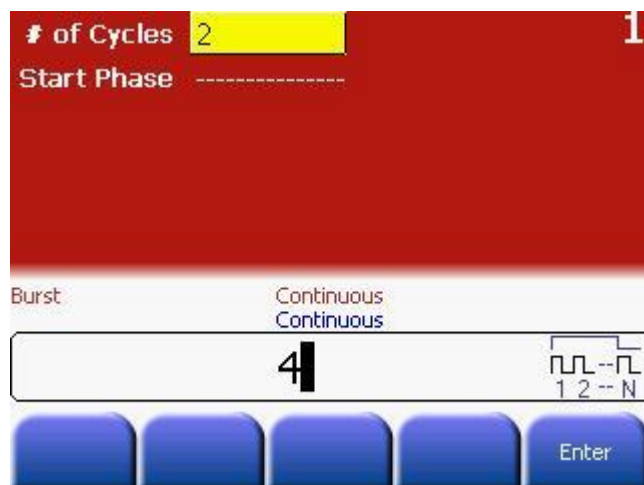

**Programming
Example**

```
# Reset the instrument to start from a defined, default status.
*RST

# Switch off the automatic display update to increase programming
# speed
:DISPlay OFF

# Set the output function of output 1 to pulse.
:FUNCTion1 PULSe

# Set the period to 500 ns, the pulse width to 100 ns
# Settings are programmed for output 1.
:PULSe:PERiod1 500NS
:PULSE:WIDTh1 100NS

# enable burst mode and set the burst length to 4
:TRIGger1:COUNT 4

# Enable the output 1 and the complement output 1.
:OUTput1 ON
:OUTput1:COMPLEMENT ON
```

Getting Started

Oscilloscope screen-shot

The following image shows the signal as displayed on the Keysight 54810A Infiniium Oscilloscope.

81150A: The Strobe Out can be used directly to trigger the scope. The screenshot of the 81150A is shown below.

81160A: The Logical Strobe Signal must be routed to the physical Sync Out A or Sync Out B BNC connector. The instrument default settings route the Logical Trigger Signal of channel 1 to Sync Out A and the Logical Strobe Signal of channel 1 to Sync Out B.

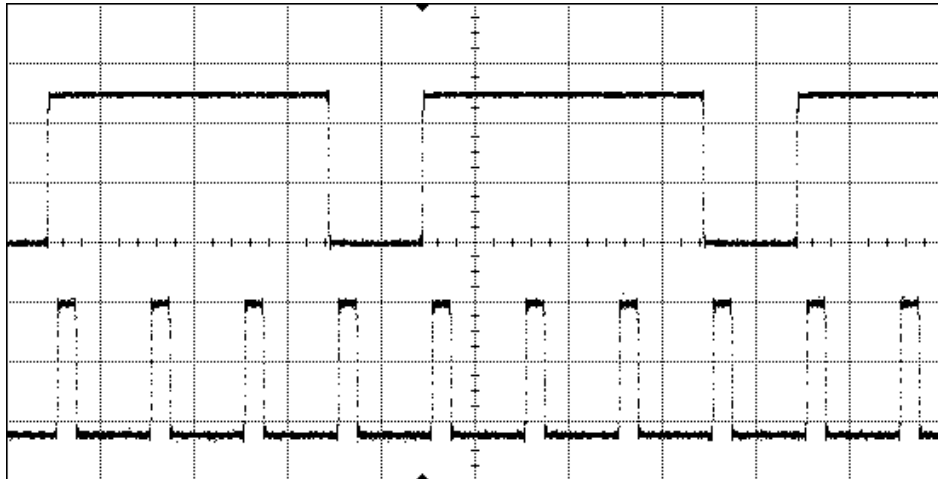

3.4 Setting up a Triggered Burst

Task To set up a burst signal with a burst repetition of $5\ \mu\text{s}$. The burst repetition is generated by using the internal trigger source. The pulses are set to a period of $500\ \text{ns}$ and width of $100\ \text{ns}$. Each burst contains 4 pulses.

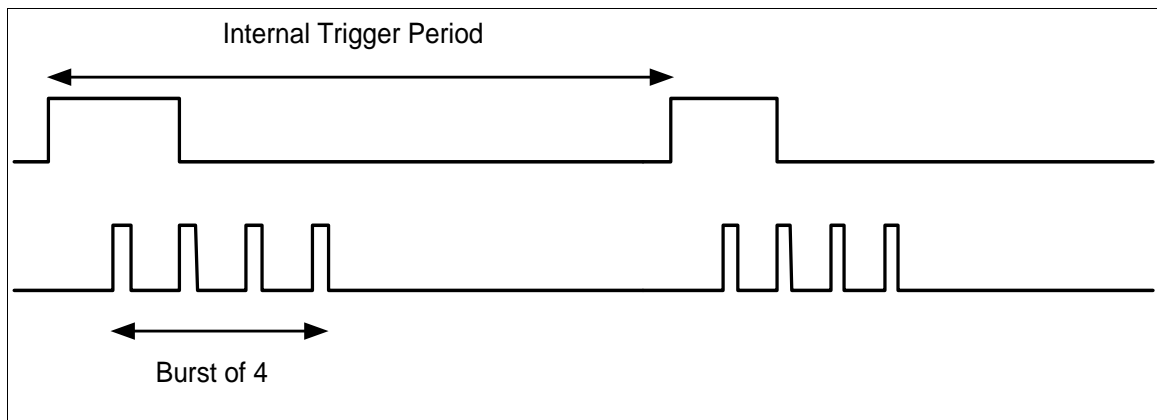

Getting Started

Selecting a Pulse Waveform

To set the operating mode and trigger mode as required, do the following:

- Before setting any values, press the **Store/Recall** key and press the **Set to Defaults** softkey.
- Press the **Ch 1** key to select channel 1.
- Press the normal and inverted output keys to enable both outputs of channel 1.
- Press **Pulse** to select it as the waveform type.

Setting the Period

- Pressing the **Frequency** softkey selects frequency. Press it again to toggle to **Period** softkey. Set the value of the Period to 500ns.
-  For setting the value, you can use the Numeric Keypad or the Rotary Knob.
- From the various available options, choose the desired unit by simply pressing it.

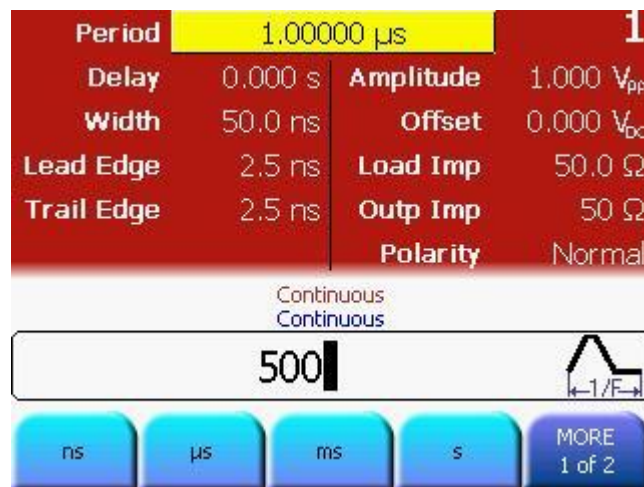

Period	1.00000 μ s	Amplitude	1.000 V _{pp}
Delay	0.000 s	Offset	0.000 V _{DC}
Width	50.0 ns	Load Imp	50.0 Ω
Lead Edge	2.5 ns	Outp Imp	50 Ω
Trail Edge	2.5 ns	Polarity	Normal

Continuous
Continuous

500

ns μ s ms s MORE
1 of 2

Setting the Width

- Press the **Width** softkey and set the value of Width to 100 ns. Use the navigation cursor and rotary knob, or the cursor keys and rotary knob to set the value.
- ✎ Press the Width softkey again to toggle to the different representations of Width: Width, Duty Cycle, and Trail Delay.
- ✎ From the various available options, choose the desired unit by simply pressing it.

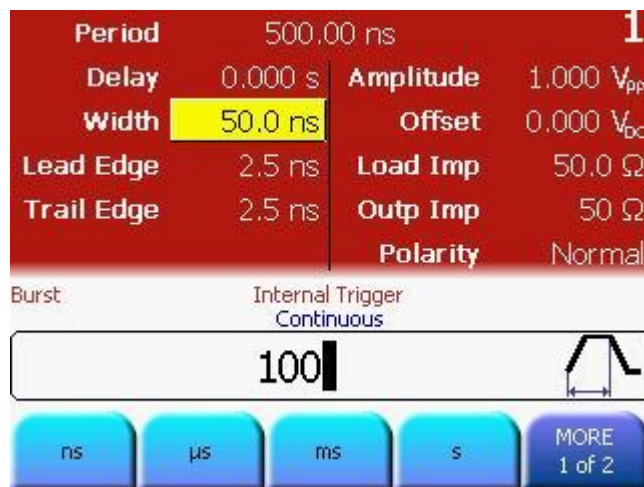

Getting Started

Selecting the Trigger Source

- Now press the **Trig** key to select Triggered as the Trigger mode.
- Press the **Source** softkey (as shown in the following screen) and select *Internal* as the source (The other options are External In and Man).

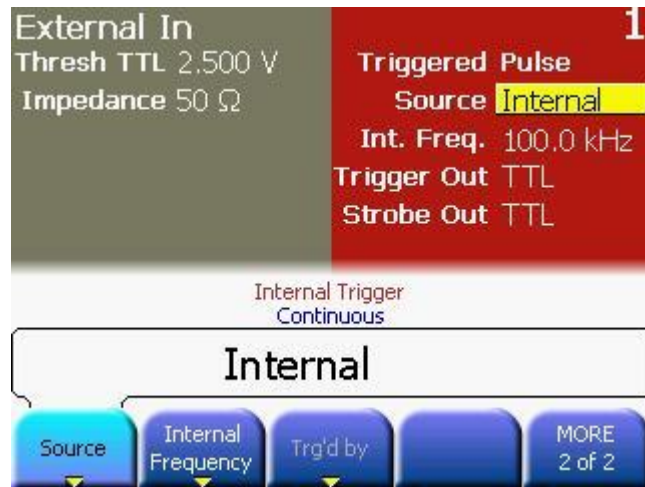

Setting the Internal Period

- Now press the **Internal Frequency** softkey twice to toggle to **Internal Period**. Set the Internal Period to 5 μ s.
- From the various available options, choose the desired unit by simply pressing it.



Setting the Burst length

- Press the **Burst** key to select Burst.
- Set the Burst Length to 4 cycles. Use the navigation cursor and rotary knob, or the cursor keys and rotary knob to set the value.

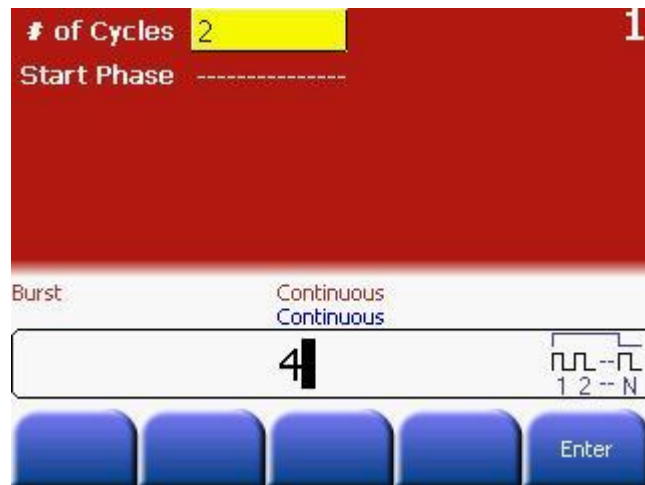

Getting Started

Programming Example

```
# Reset the instrument to start from a defined, default status.
*RST

# Switch off the automatic display update to increase programming
# speed
:DISPlay OFF

# Set the output function of output 1 to pulse.
:FUNction1 PULSe

# Set the period to 500 ns, the pulse width to 100 ns
# Settings are programmed for output 1.
:PULSe:PERiod1 500NS
:PULSe:WIDTh1 100NS

# Set the internal trigger period to 5us
:ARM:PERiod1 5US

# Switch to triggered mode and select the internal
# trigger source
:ARM:SENSe1 EDGE
:ARM:SOURce1 INT2

# enable burst mode and set the burst length to 4
:TRIGger1:COUNT 4

# Enable the output 1 and the complement output 1.
:OUTput1 ON
:OUTput1:COMPLEMENT ON
```

**Oscilloscope
screen-shot**

The following image shows the signal as displayed on the Keysight 54810A Infiniium Oscilloscope.

81150A: The Strobe Out can be used directly to trigger the scope. The screenshot of the 81150A is shown below.

81160A: The Logical Strobe Signal must be routed to the physical Sync Out A or Sync Out B BNC connector. The instrument default settings route the Logical Trigger Signal of channel 1 to Sync Out A and the Logical Strobe Signal of channel 1 to Sync Out B.

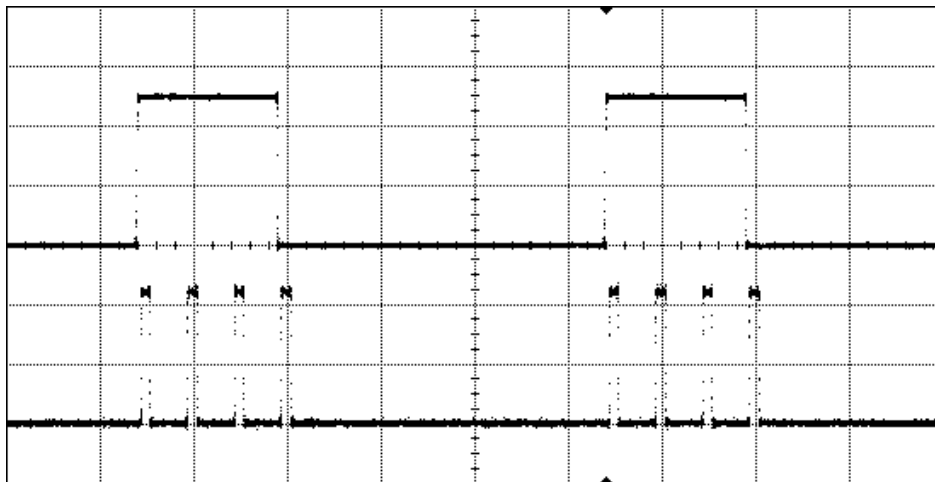

3.5 To output a Modulated Waveform

Task To output a modulated waveform with a continuous sine wave. The carrier frequency is 1.5 KHz. The modulation type is AM, AM source as Internal, AM depth of 100%, AM frequency as 100 Hz, and AM shape as Sine.

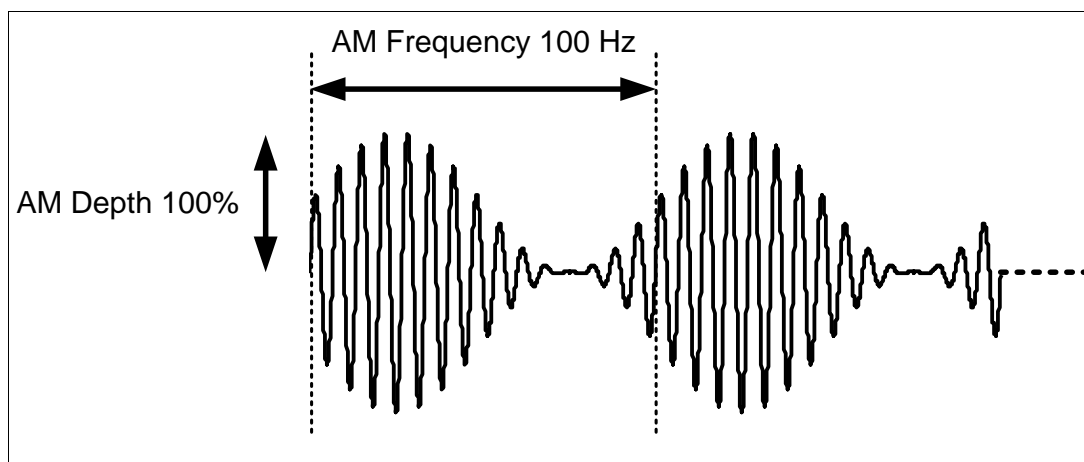

Setting the Frequency

To set the operating mode and trigger mode as required, do the following:

- Before setting any values, press the Store/Recall key and press the **Set to Defaults** softkey.
 - Press the **Ch 1** key to select channel 1.
 - Press the normal and inverted output keys to enable both outputs of channel 1.
 - The Continuous trigger mode and Sine waveform are set by default.
 - Press the Frequency softkey to select frequency. Set the value to 1.5 KHz.
-  For setting the value, you can use the Numeric Keypad or the Rotary Knob.
- From the various available options, choose the desired unit by simply pressing it.

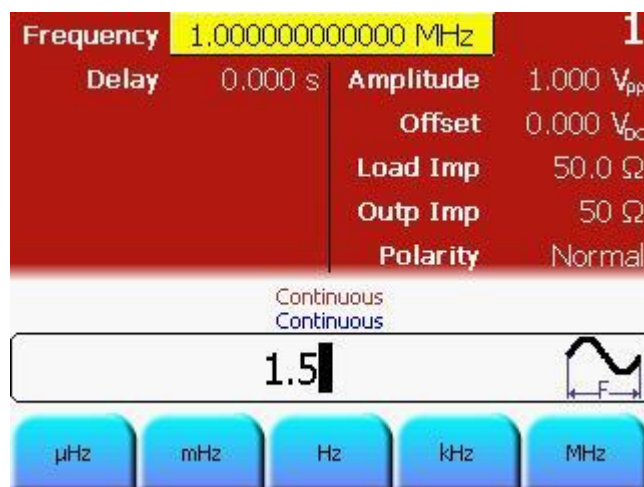

Getting Started

Selecting Modulation, Source and Depth

- Press the **Mod** key to select the modulation type. *AM* is set as the modulating waveform by default.
- The AM source is set to *Internal* by default, the AM depth is set to 100% by default, and the *Frequency* is also set to 100 Hz by default.
- The AM source is set to *Internal*, the AM depth is set to *100%*, and the AM Frequency is set to *100 Hz*. All these settings exist by default. Therefore, we do not make any changes to these settings for this example.
- Let's have a look at our current screen now.

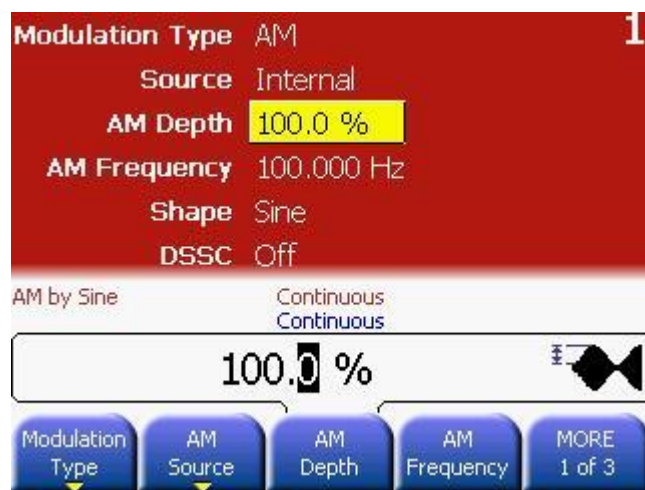

**Programming
Example**

```
# Reset the instrument to start from a defined, default status.
*RST

# Switch off the automatic display update to increase programming
# speed
:DISPlay OFF

# Set the output function to sinewave.
:FUNction1 SIN

# Set the frequency of the carrier to 1.5 kHz.
:FREQuency1 1.5KHZ

# Set the AM parameters to
# - AM depth 100%
# - internal AM source
# - AM frequency 100 Hz
# - internal AM shape is sinewave
# Note: Since all the settings below are equal to the
# defaults, this step could be skipped.
:AM1:DEPTh 100
:AM1:SOURce INT
:AM1:INTernal:FREQuency 100HZ
:AM1:INTernal:FUNction SIN

# Enable AM
:AM1:STATe ON

# Enable the output 1 and the complement output 1.
:OUTput1 ON
:OUTput1:COMPLEMENT ON
```

Getting Started

Oscilloscope screen-shot

The following image shows the signal as displayed on the Keysight 54810A Infiniium Oscilloscope.

81150A: The Strobe Out can be used directly to trigger the scope. The screenshot of the 81150A is shown below.

81160A: The Logical Strobe Signal must be routed to the physical Sync Out A or Sync Out B BNC connector. The instrument default settings route the Logical Trigger Signal of channel 1 to Sync Out A and the Logical Strobe Signal of channel 1 to Sync Out B.

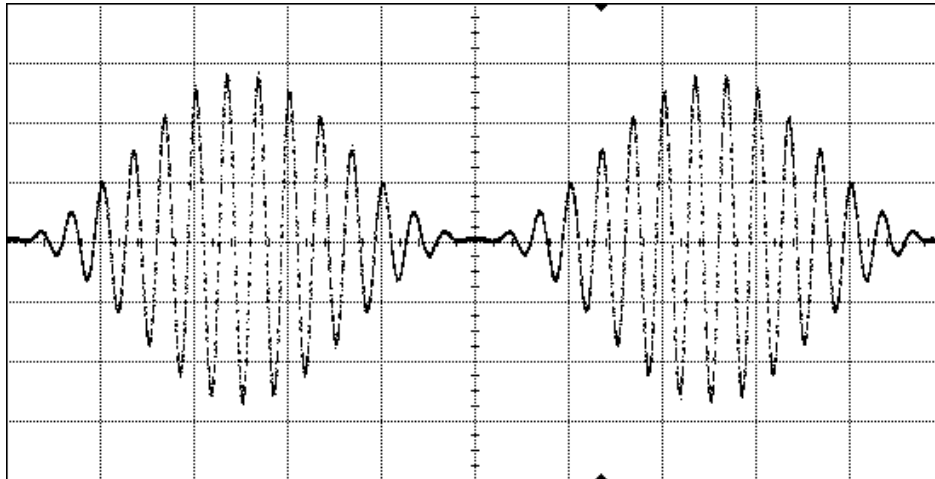

3.6 To output an FSK Waveform

Task To output an FSK waveform with a continuous sine wave, modulation type as FSK, FSK source as Internal, carrier frequency of 1 MHz, Amplitude of 5Vpp, FSK Rate of 450 KHz, FSK Hop Frequency of 5 MHz.

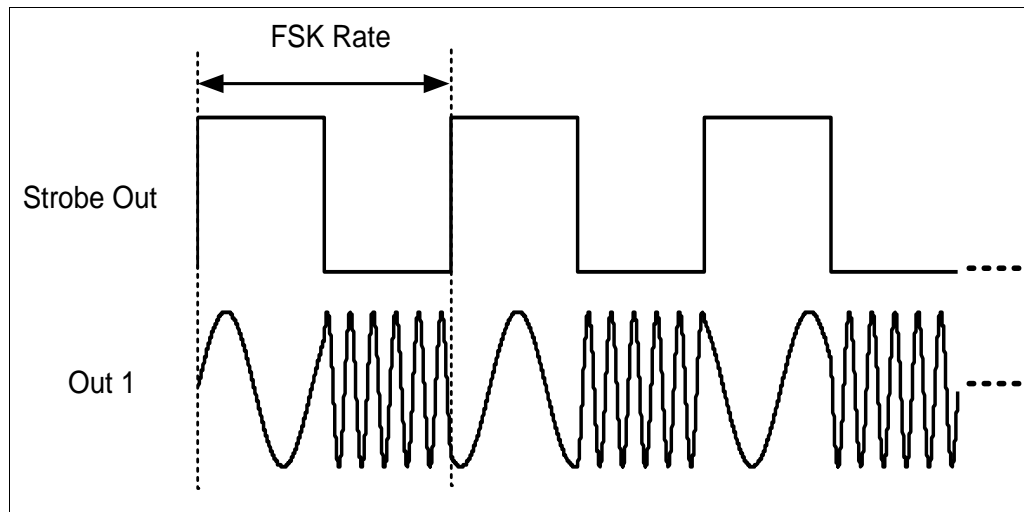

Getting Started

Setting the Amplitude

To set the operating mode and trigger mode as required, do the following:

- Before setting any values, press the **Store/Recall** key and press the **Set to Defaults** softkey.
 - Press the **Ch 1** key to select channel 1.
 - Press the normal and inverted output keys to enable both outputs of channel 1.
 - The *Continuous* trigger mode and Sine waveform are enabled by default.
 - The *Frequency* is also set to 1 MHz by default.
 - Press the **Ampl** softkey to set the Amplitude to 5 Vpp. From the various available options, choose the desired unit by simply pressing it.
-  For setting the value, you can use the Numeric Keypad or the Rotary Knob.

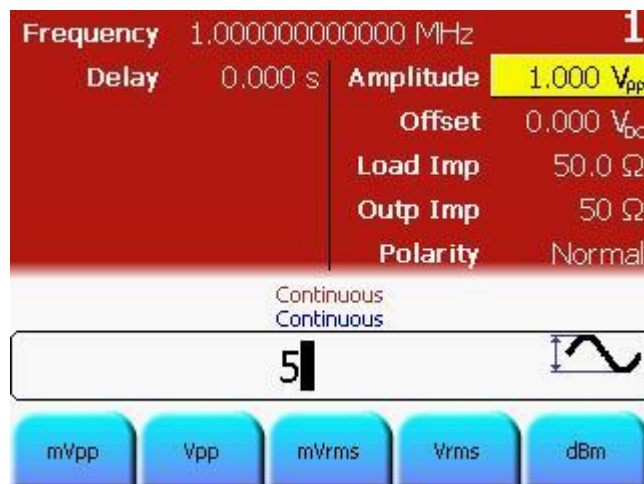

Selecting the Modulation

- After setting the frequency and amplitude, press the **Mod** key to enable modulation.
- Press the **Modulation Type** softkey and select FSK.

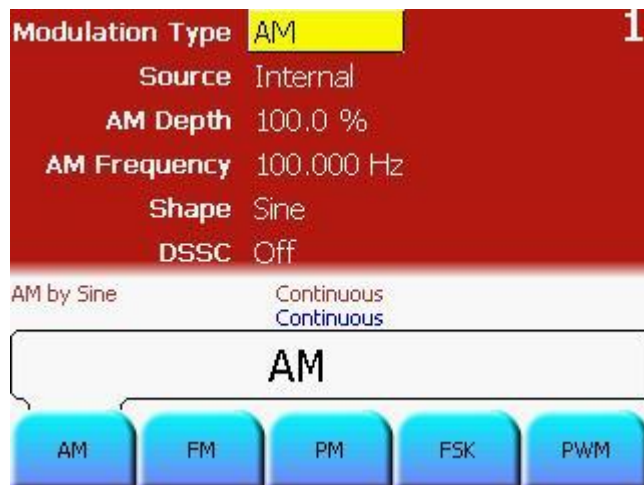

Setting the FSK source

- The FSK Source is set to *Internal* by default. Therefore, do not change it.

Setting the Hop Frequency

- Press the **Hop Frequency** softkey and set the value to 5 MHz.

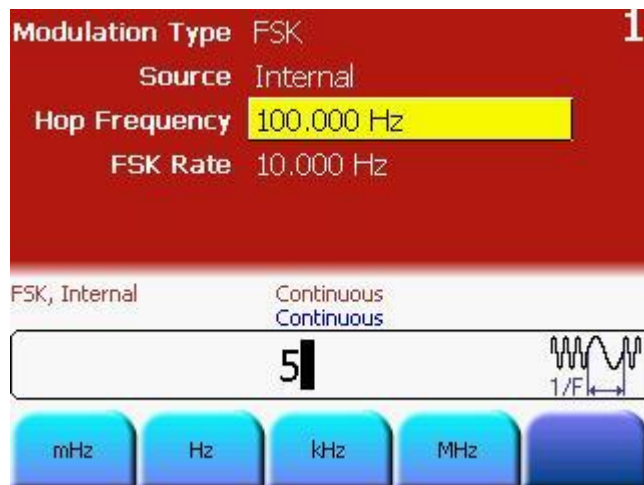

Getting Started

Setting the FSK Rate

- Press the **FSK Rate** softkey and set the value to 450 KHz.

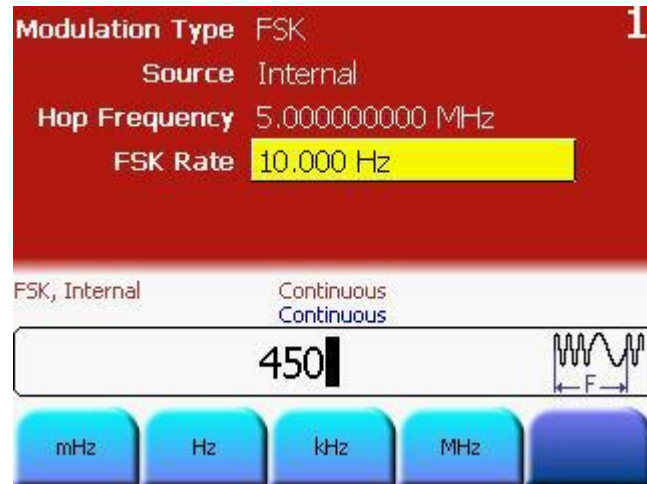

**Programming
Example**

```
# Reset the instrument to start from a defined, default status.
*RST

# Switch off the automatic display update to increase programming
# speed
:DISPlay OFF

# Set the output function to sinewave.
:FUNction1 SIN

# Set the frequency of the carrier to 1 MHz.
:FREQuency1 1MHZ

# Set the FSK parameters to
# - Hop frequency 5 MHz
# - internal FSK source
# - FSK Rate 450 kHz
:FSK1:FREQuency 5MHZ
:FSK1:SOURce INT
:FSK1:INTernal:RATE 450KHZ

# Enable FSK
:FSK1:STATe ON

# Enable the output 1 and the complement output 1.
:OUTput1 ON
:OUTput1:COMPLement ON
```

Getting Started

Oscilloscope screen-shot

The following image shows the signal as displayed on the Keysight 54810A Infiniium Oscilloscope.

81150A: The Strobe Out can be used directly to trigger the scope. The screenshot of the 81150A is shown below.

81160A: The Logical Strobe Signal must be routed to the physical Sync Out A or Sync Out B BNC connector. The instrument default settings route the Logical Trigger Signal of channel 1 to Sync Out A and the Logical Strobe Signal of channel 1 to Sync Out B.

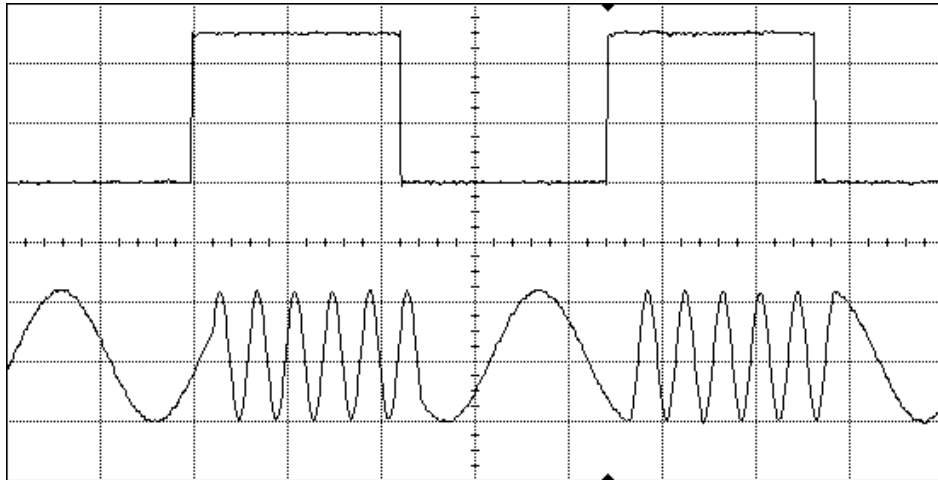

3.7 To output a Frequency Sweep

Task To set up a Frequency Sweep with Start Frequency at 1 kHz and Stop Frequency at 8 kHz, Carrier Sinewave of 5 Vpp, Sweep Time of 2 ms, and sweep type as Linear.

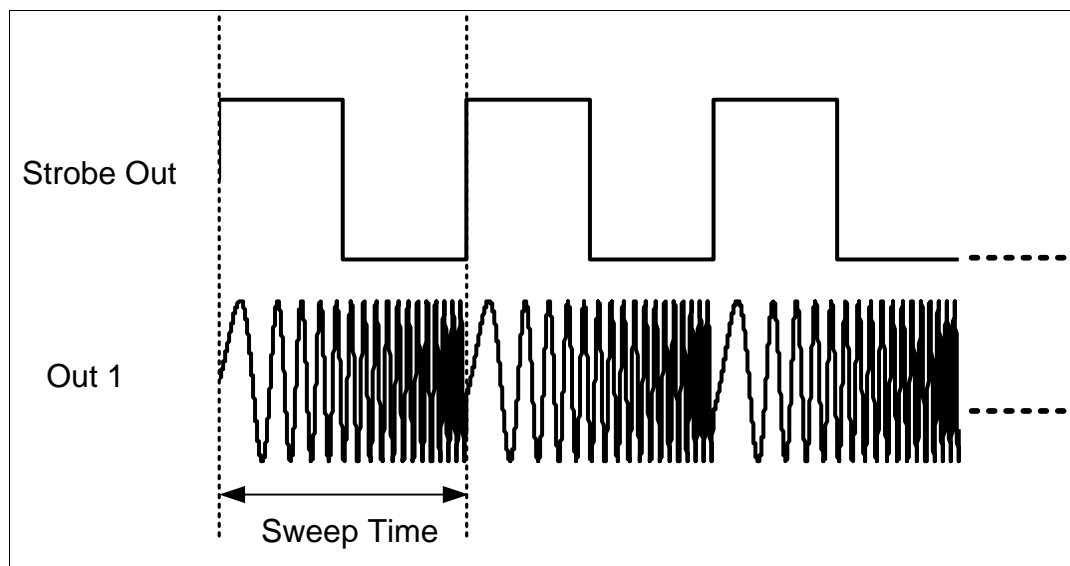

Getting Started

Setting the Operating and Trigger mode

To set the operating mode and trigger mode as required, do the following:

- Before setting any values, press the **Store/Recall** softkey and press the **set to defaults** softkey.
 - Press the **Ch 1** key to select channel 1.
 - Press the normal and inverted output keys to enable both outputs of channel 1.
 - The *Sine* waveform is set by default.
 - Press the **Ampl** softkey to set the Amplitude of the carrier sinewave to 5Vpp.
-  For setting the value, you can use the Numeric Keypad or the Rotary Knob.

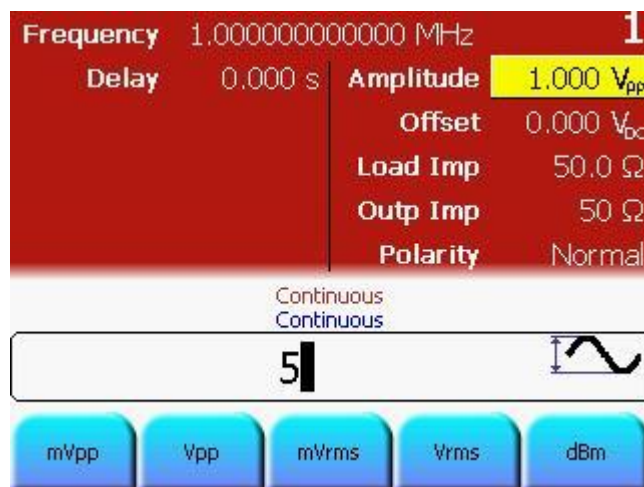

Setting the Sweep Parameters

- Press the **Sweep** key to set the sweep parameters.
 - Since the Sweep Type is set to Linear by default, we do not change it.
-  The Sweep Type can be Linear or Logarithmic. Depending upon your requirements, you can select the appropriate one.



Setting the Start Frequency

- Press the **Start Frequency** softkey to set the start frequency value. Set the value to 1 kHz.



Getting Started

Setting the Stop Frequency

- Press the **Stop Frequency** softkey to set the stop frequency value. Set the value to 8 kHz.

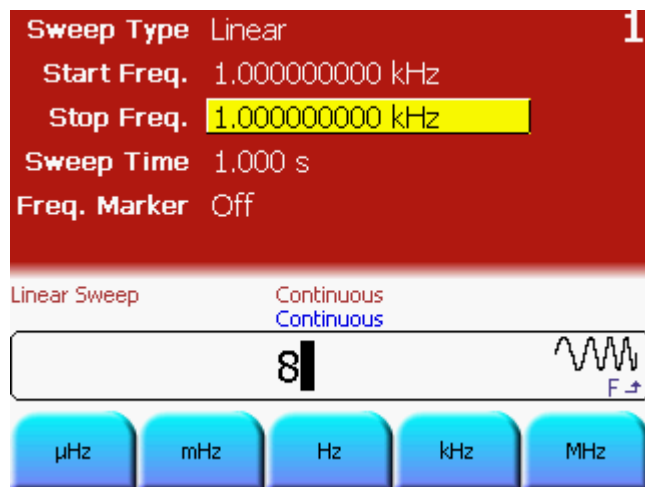

Setting the Sweep Time

- Press the **Sweep Time** softkey to set the sweep duration value. Set the value to 2 ms.



**Programming
Example**

```
# Reset the instrument to start from a defined, default status.
*RST

# Switch off the automatic display update to increase programming
# speed
:DISPlay OFF

# Set the output function to sinewave.
:FUNction1 SIN

# Set the start frequency to 1 kHz
:FREQuency1:STARt 1KHZ

# Set the stop frequency to 8 kHz
:FREQuency1:STOP 8KHZ

# Set the sweep time to 2 ms
:SWEep1:TIME 2e-3

# Select linear sweep spacing
:SWEep1:SPACing LINear

# Enable frequency sweep
:SWEep1:STATe ON

# Set the output amplitude to 5 Vpp
:VOLTagel 5VPP

# Enable the output 1 and the complement output 1.
:OUTput1 ON
:OUTput1:COMPliment ON
```

Getting Started

Oscilloscope screen-shot

The following image shows the signal as displayed on the Keysight 54810A Infiniium Oscilloscope.

81150A: The Strobe Out can be used directly to trigger the scope. The screenshot of the 81150A is shown below.

81160A: The Logical Strobe Signal must be routed to the physical Sync Out A or Sync Out B BNC connector. The instrument default settings route the Logical Trigger Signal of channel 1 to Sync Out A and the Logical Strobe Signal of channel 1 to Sync Out B.

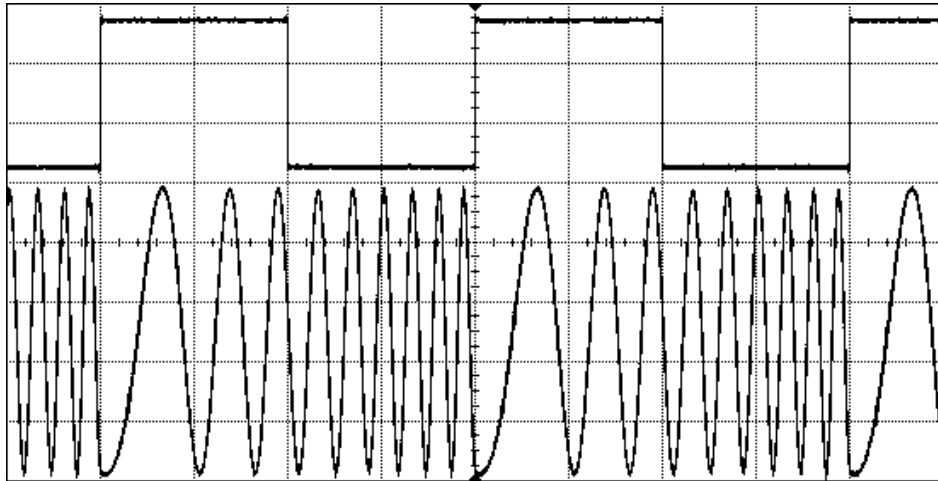

3.8 Setting up a Triggered Frequency Sweep

Task

To set up a triggered linear Sweep with Sinewave of 5 Vpp, Start frequency at 1 kHz, Stop Frequency at 8 kHz, Sweep Time of 2 ms, and Internal Period of 5 ms.

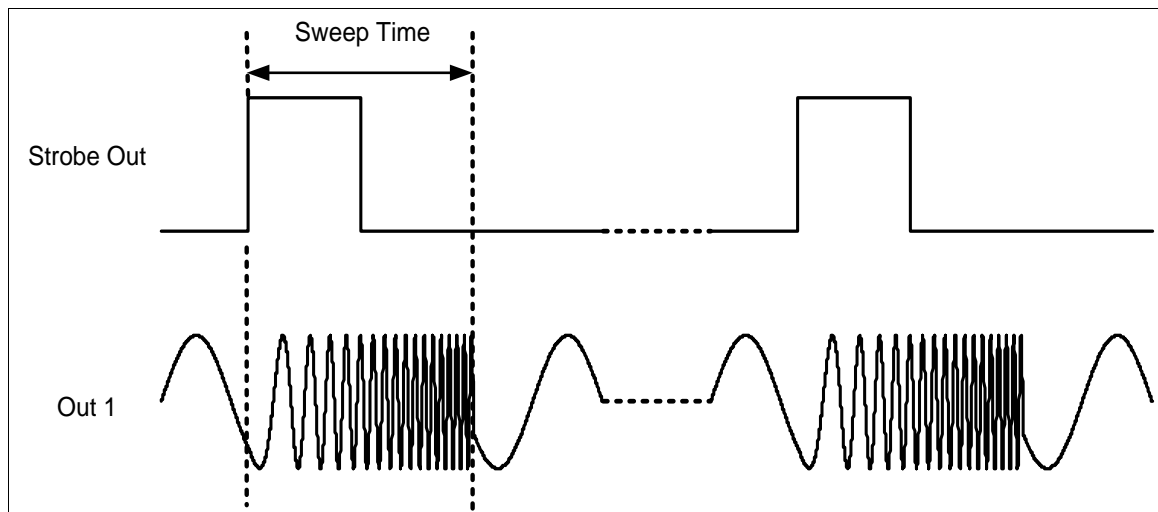

Getting Started

Setting the Operating and Trigger mode

To set the operating mode and trigger mode as required, do the following:

- Before setting any values, press the **Store/Recall** softkey and press the **set to defaults** softkey.
 - Press the **Ch 1** key to select channel 1.
 - Press the normal and inverted output keys to enable both outputs of channel 1.
 - The *Sine* waveform is set by default.
 - Press the **Ampl** softkey to set the Amplitude of the carrier sinewave to 5Vpp.
-  For setting the value, you can use the Numeric Keypad or the Rotary Knob.

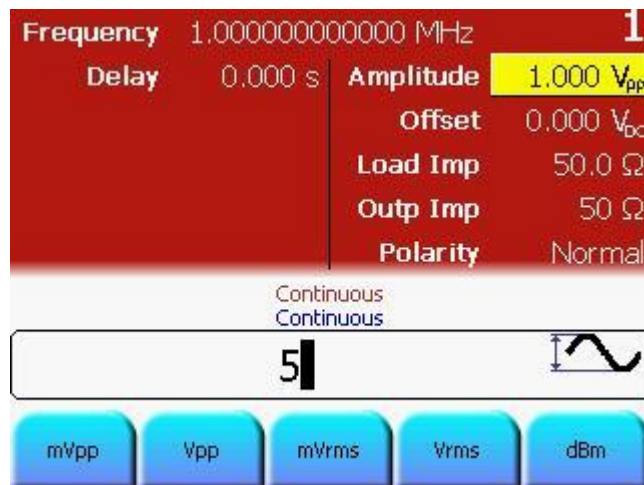

Setting the Sweep Parameters

- Press the **Sweep** key to set the sweep parameters.
 - Since the Sweep Type is set to Linear by default, we do not change it.
-  The Sweep Type can be Linear or Logarithmic. Depending upon your requirements, you can select the appropriate one.



Setting the Start Frequency

- Press the **Start Frequency** softkey to set the start frequency value. Set the value to 1 kHz.



Getting Started

Setting the Stop Frequency

- Press the **Stop Frequency** softkey to set the stop frequency value. Set the value to 8 kHz.

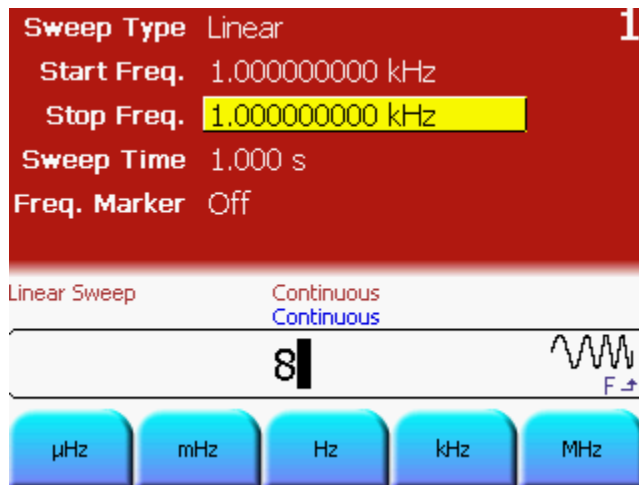

Setting the Sweep Time

- Press the **Sweep Time** softkey to set the sweep duration value. Set the value to 2 ms.



Selecting the Trigger Source

- Press the Trig key to enable the triggered mode.
- Press the **Source** softkey to select *Internal* as the Trigger source.

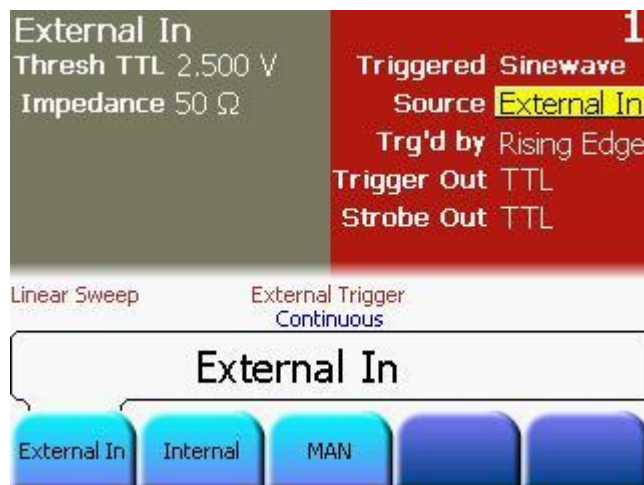

Setting the Internal Period

- Now press the **Internal Frequency** softkey twice to toggle to **Internal Period**. Set the Internal Period to 5 ms.

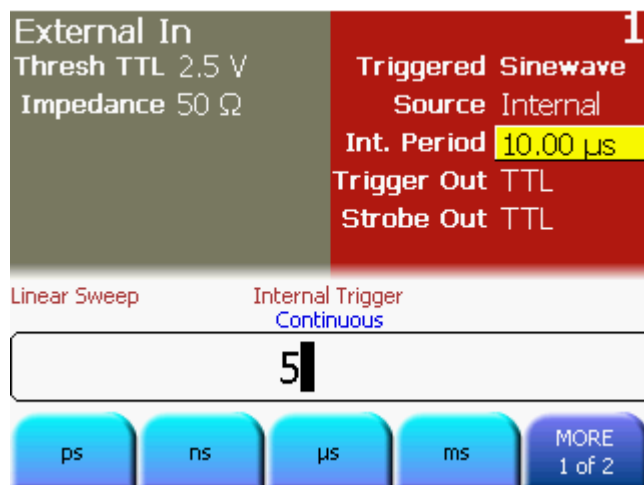

Getting Started

Programming Example

```
# Reset the instrument to start from a defined, default status.
*RST

# Switch off the automatic display update to increase programming
# speed
:DISPlay OFF

# Set the output function to sinewave.
:FUNction1 SIN

# Set the start frequency to 1 kHz
:FREQuency1:STARt 1KHZ

# Set the stop frequency to 8 kHz
:FREQuency1:STOP 8KHZ

# Set the sweep time to 2 ms
:SWEEp1:TIME 2e-3

# Select linear sweep spacing
:SWEEp1:SPACing LINear

# Enable frequency sweep
:SWEEp1:STATe ON

# Set the output amplitude to 5 Vpp
:VOLTagel 5VPP

# Set the internal trigger period to
:ARM:PERiod1 5ms

# Switch to triggered mode and select the internal
# trigger source
:ARM:SENSE1 EDGE
:ARM:SOURce1 INT2

# Enable the output 1 and the complement output 1.
:OUTput1 ON
:OUTput1:COMPLEMENT ON
```

**Oscilloscope
screen-shot**

The following image shows the signal as displayed on the Keysight 54810A Infiniium Oscilloscope.

81150A: The Strobe Out can be used directly to trigger the scope. The screenshot of the 81150A is shown below.

81160A: The Logical Strobe Signal must be routed to the physical Sync Out A or Sync Out B BNC connector. The instrument default settings route the Logical Trigger Signal of channel 1 to Sync Out A and the Logical Strobe Signal of channel 1 to Sync Out B.

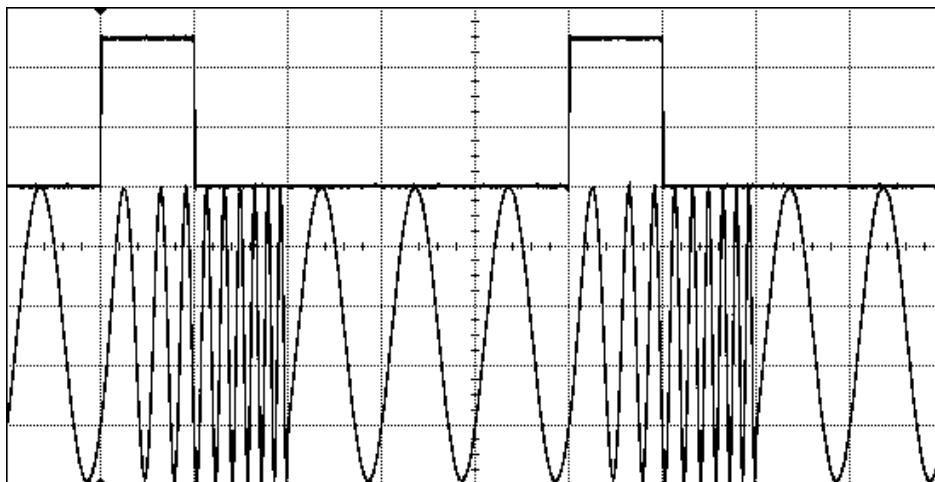

3.9 Coupling between Channels

Introduction

This example shows how the two channels can be coupled, so that the instrument behaves like a 2 channel instrument with only one timebase. In this mode, the frequency and phase of both the channels are locked. Locking the output frequency and phase of both channels does have a noticeable effect on most of the major operations modes. Therefore, as a result of coupling, the output function, and all other parameters like, burst, sweep, and modulation are also kept identical on both channels.

Refer to the 81150A and 81160A User Guide for more information.

Let's set different values for different parameters on both channels one-by-one, and enable coupling.

3.9.1 Settings for Channel 1

Selecting a Pulse waveform

To set the operating mode and trigger mode as required, do the following:

- Ensure that the **Ch 1** key is selected.
 - Before setting any values, press the **Store/Recall** key and press the **Set to Defaults** softkey.
 - The *Continuous* trigger mode is enabled by default. Therefore, we do not change it. Now, we only need to select a *Pulse* waveform.
 - To select a *Pulse* waveform, simply press the **Pulse** key given on the Front Panel.
-

Selecting the Frequency and Delay

- By default, the *Frequency* is already set to 1 MHz, and the *Delay* to 0 seconds, therefore we do not change these values.
-

Setting the Amplitude

- Press the **Ampl** softkey and set the value to 2 Vpp.
- ✎ For setting the value, you can use the Numeric Keypad or the Rotary Knob.

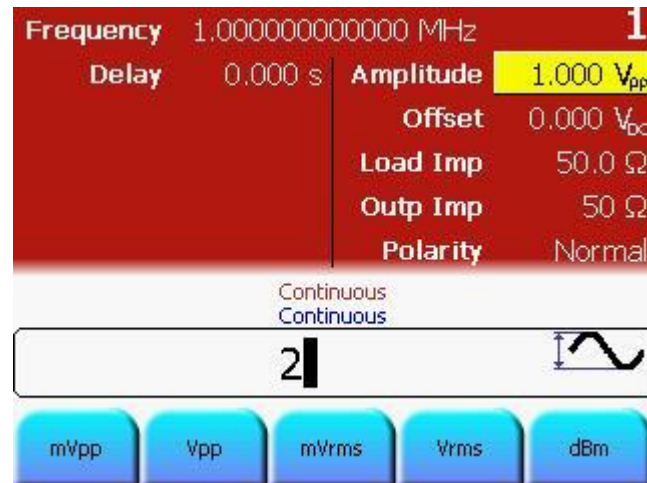

Setting the Offset

- Press the **Offset** softkey or use the navigation key to set the Offset. Set the offset to 1 Vdc.

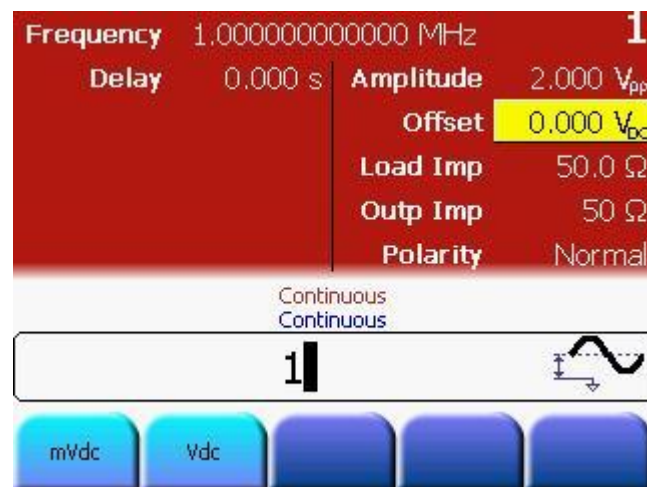

3.9.2 Settings for Channel 2

Setting the Frequency

To set the operating mode and trigger mode as required, do the following:

- Press the **Ch 2** key to select Channel 2.
 - The *Continuous* trigger mode and *Sine* waveform are set by default.
 - Press the **Frequency** softkey to select frequency. Set the value to 2 MHz.
-  For setting the value, you can use the Numeric Keypad or the Rotary Knob.
- From the various available options, choose the desired unit by simply pressing it.

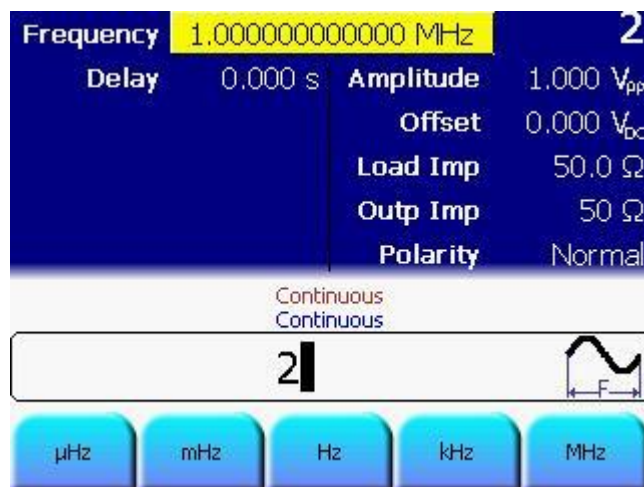

Selecting Delay

- Press the **Delay** softkey to set the value to 10 ns.

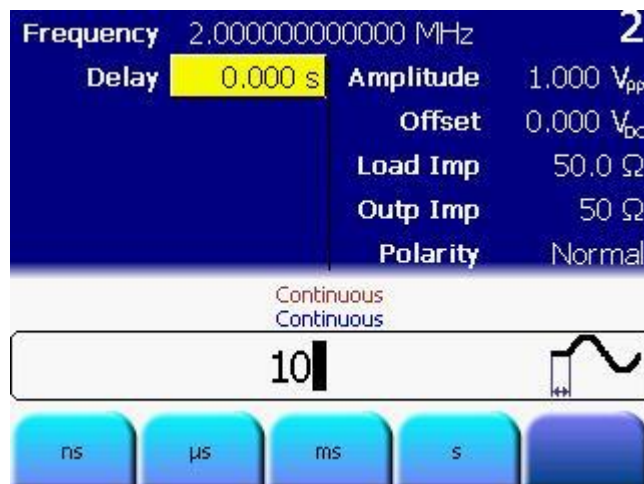
**Setting the Amplitude**

- Press the **Ampl** softkey and set the value to 3 Vpp.
- ✎ For setting the value, you can use the Numeric Keypad or the Rotary Knob.

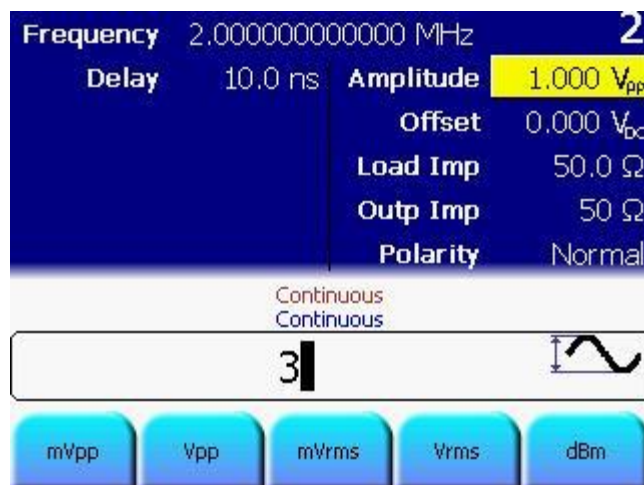
**Setting the Offset**

- The Offset is set to 0 VDC by default; therefore we do not change it.

Getting Started

Enable the Trigger mode

- Press the **Trig** key to enable the trigger mode.

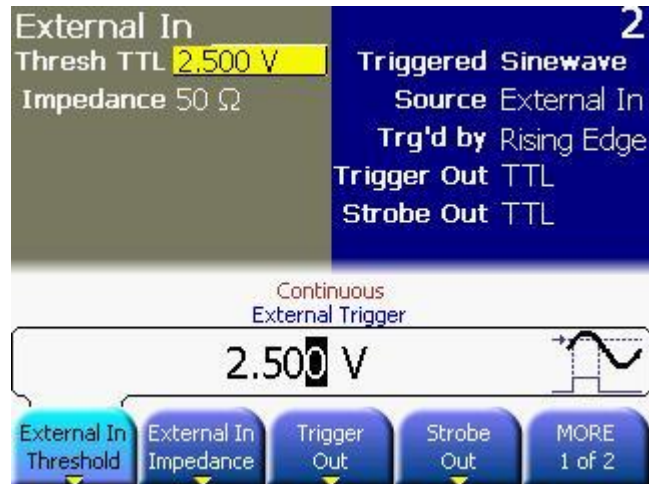

Set the Burst length

- Press the **Burst** key and set the burst length to 5.

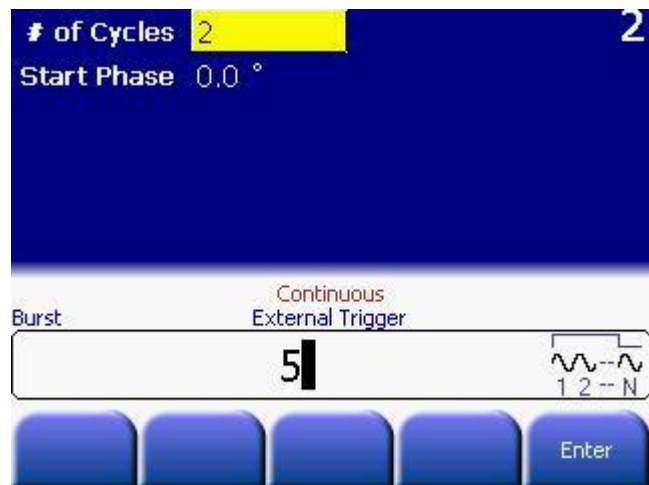

Switch to Channel 1

- Press the **Ch 1** key. This brings you to the screen with channel 1 settings.

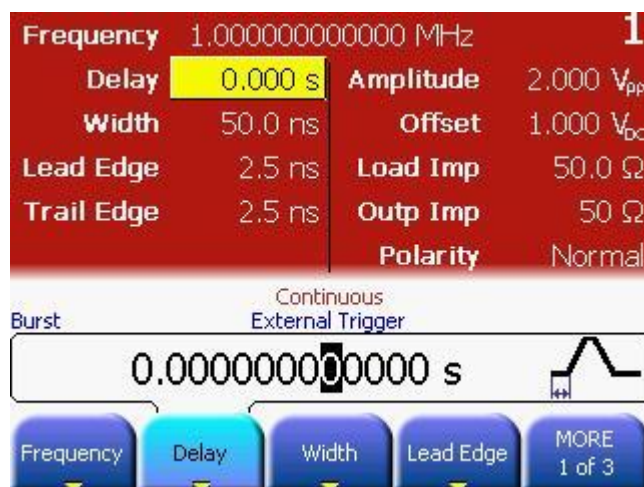

Enable Coupling

- Press the **Coupling** key. This enables coupling of both channels. Since Channel 1 is currently selected, the setting of Channel 2 will be adjusted to match the settings of Channel 1.

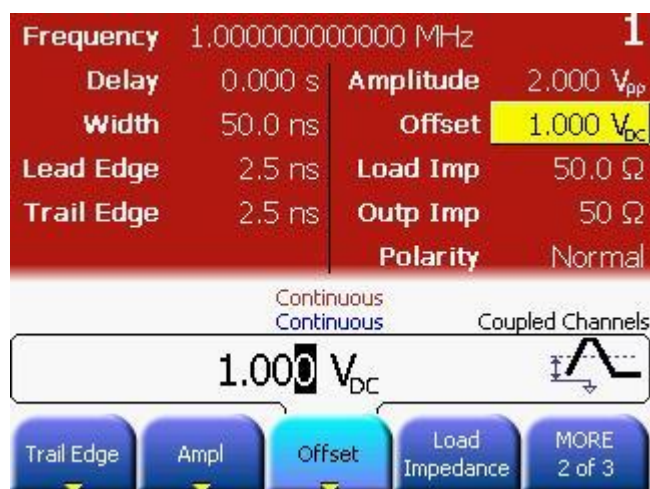

Getting Started

Switch to Channel 2

- Press the **Ch 2** key. This brings you to the following screen.

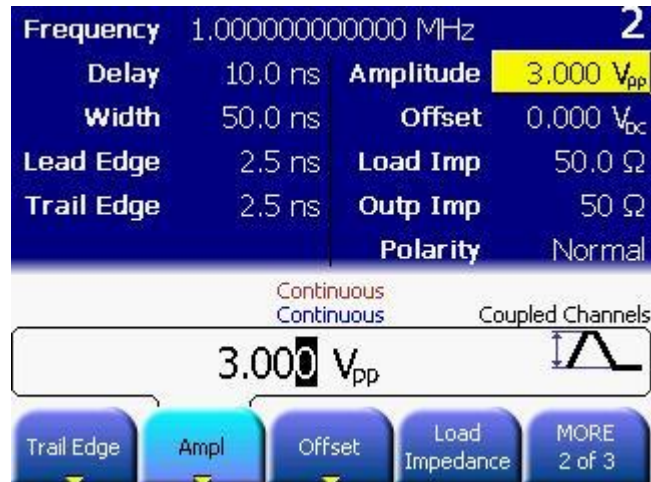

Note

- Channel 2 is now generating continuous pulses at 1 MHz, and the burst has been disabled.

Change Frequency and Delay

- Press the **Frequency** softkey and change the frequency from 1 MHz to 2 MHz. Next, press the **Delay** softkey and change the value of Delay from 10 ns to 20 ns.

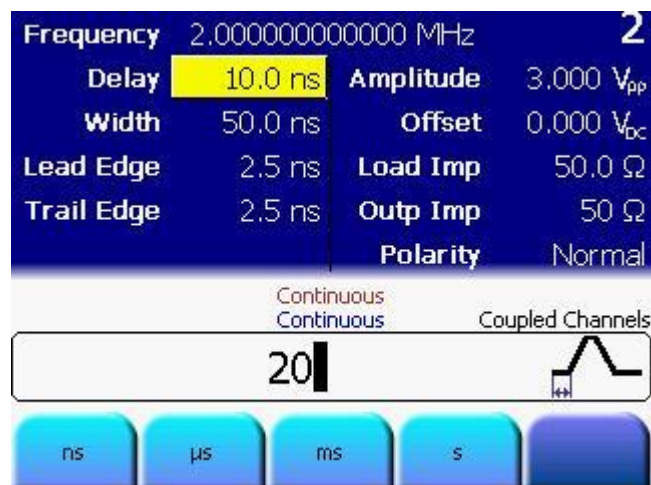

**Switch to
Channel 1 again**

- Press the **Ch 1** key.
- You will notice that the changes done on Channel 2 (in terms of changing the frequency) get reflected on Channel 1 as both channels are coupled. But, the delay on Channel 1 is still at the initial value of 0.0 ns.

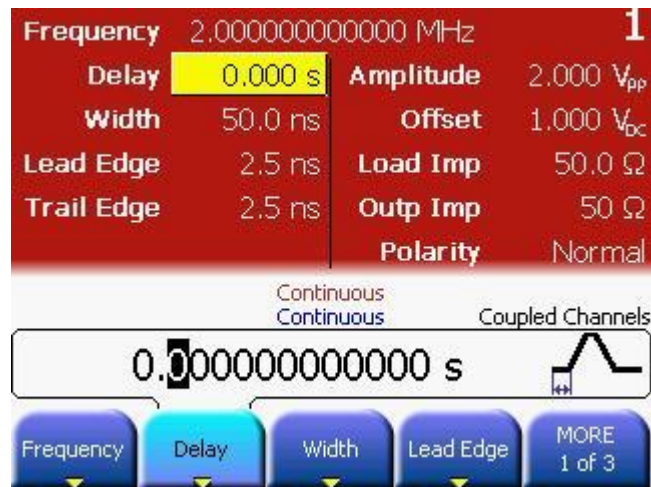

Getting Started

Programming Example

This example requires a 2 channel 81150A or 2 channel 81160A to run without errors.

Reset the instrument to start from a defined, default status.

```
*RST
```

Switch off the automatic display update to increase programming

speed

```
:DISPlay OFF
```

Setup channel 1

- Pulse

- Frequency 1 MHz

- Delay 0s

- Amplitude 2Vpp

- Offset 1V

```
:FUNction1 PULS
```

```
:FREQuency1 1MHZ
```

```
:PULSe:DELay1 0S
```

```
:VOLTagel 2VPP
```

```
:VOLTagel:OFFSet 1V
```

Setup channel 2

- Sine

- Frequency 2 MHz

- Delay 10ns

- Amplitude 3Vpp

- Offset 0V

- triggered burst of 5

```
:FUNction2 SIN
```

```
:FREQuency2 2MHZ
```

```
:PULSe:DELay2 10NS
```

```
:VOLTagel 3VPP
```

```
:VOLTagel:OFFSet 0V
```

```
:ARM:SOURce2 EXT
```

```
:ARM:SENSE2 EDGE
```

```
:TRIGger:COUNt2 5
```

**Programming
Example**

```
# Enable channel coupling.
# Initial coupling is done from channel 1 to channel 2
:TRACk:CHANnel1 ON

# now the setting on channel 2 has changed to
# - Pulse
# - Frequency 1 MHz

# change frequency and delay on channel 2
:FREQuency2 2MHZ
:PULSe:DELay2 20NS

# now the setting on channel 1 has changed to
# - Frequency 2 MHz

# disable channel coupling (can be done on any channel)
:TRACk:CHANnel2 OFF
```

3.10 Adding up Channel 1 and Channel 2

Task

To perform Channel Addition, let us enable the following settings:

For Channel 1: Continuous Pulse with frequency 1 MHz, width 500 ns, delay 0 s, lead edge 75%, trail edge 50%, offset 0 V and amplitude 3 Vpp.

For Channel 2: Continuous Pulse with frequency 1 MHz, width 10 ns, delay 200 ns, lead edge 2.5 ns, trail edge 2.5 ns, offset 0 V and amplitude 2 Vpp.

 This example requires a 2 channel version of the 81150A or 81160A.

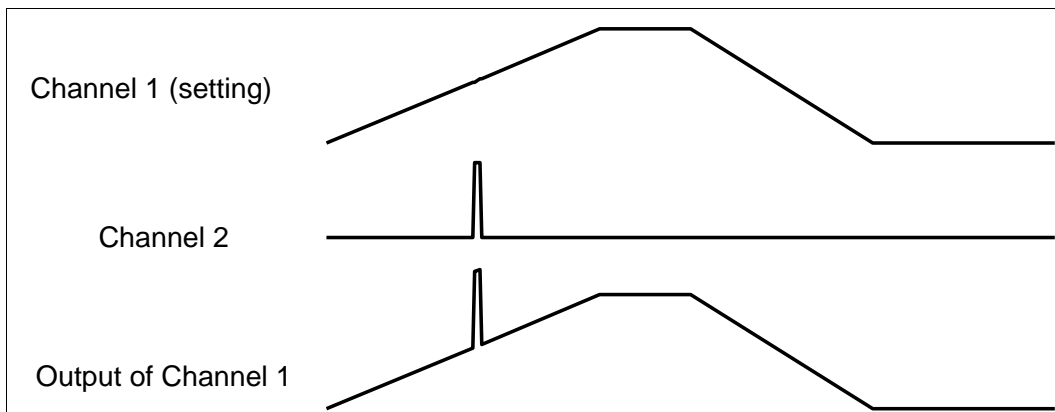

3.10.1 Settings for Channel 1

- Selecting a Pulse waveform** To set the operating mode and trigger mode as required, do the following:
- Before setting any values, press the **Store/Recall** key and press the **Set to Defaults** softkey.
 - Press the **Ch 1** key to select channel 1.
 - Press the normal and inverted output keys to enable both outputs of channel 1.
 - The *Continuous* trigger mode is enabled by default. Therefore, we do not change it. Now, we only need to select a *Pulse* waveform.
 - To select a *Pulse* waveform, simply press the **Pulse** key given on the Front Panel.
-

- Selecting the Frequency and Delay**
- By default, the *Frequency* is already set to 1 MHz, and the *Delay* to 0 seconds, therefore we do not change these values.
-

Getting Started

Setting Width

- Press the **Width** softkey and set the value to 500 ns.
- ✎ For setting the value, you can use the Numeric Keypad or the Rotary Knob.

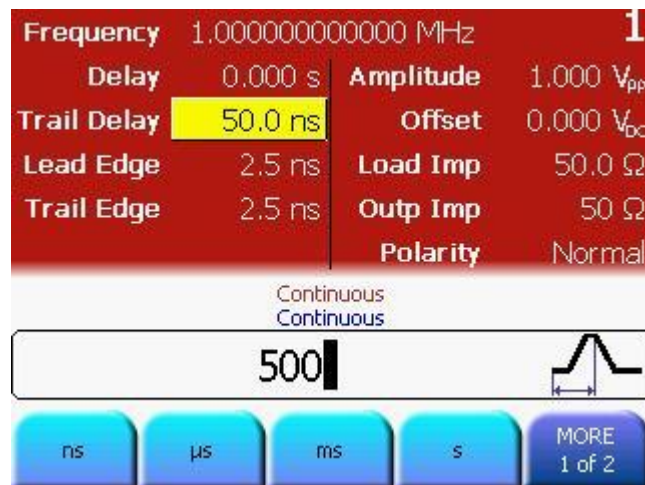

Setting the Lead Edge

- Press the **Lead Edge** softkey to set the Lead Edge value. Press it again to set the value of Lead Edge in %. Set the value to 75%.

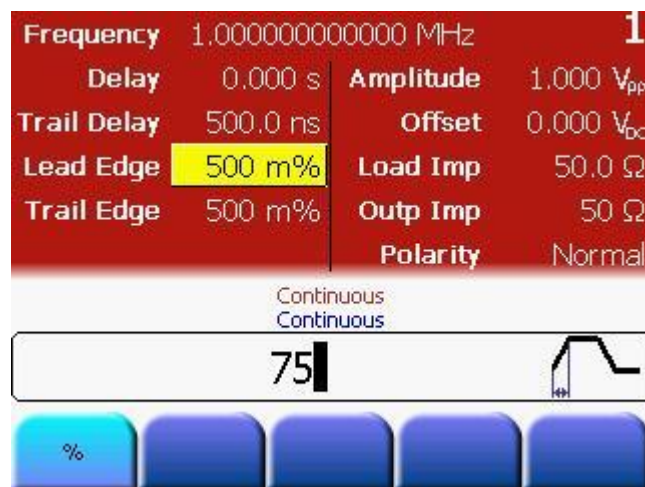

Setting the Trail Edge

- Press the **More** softkey or use the navigation key to set the value of Trail Edge.
- Set the value of Trail Edge to 50%.
- Press the **Trail Edge** softkey again to choose a different unit for different requirements.

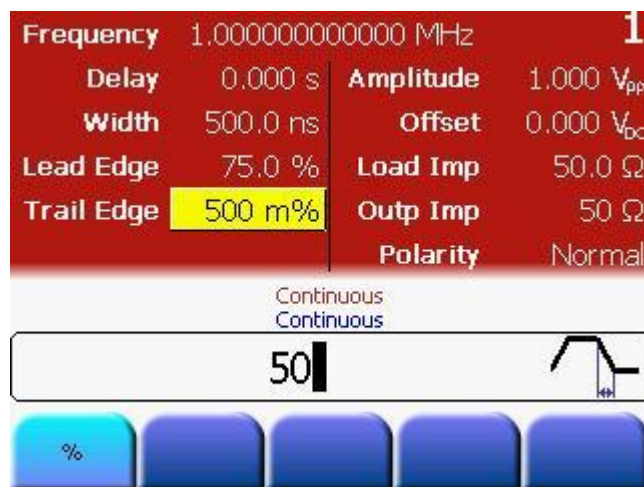

Setting the Amplitude

- Press the **Ampl** softkey or use the navigation key to set the Amplitude. Set the amplitude to 3V_{pp}.

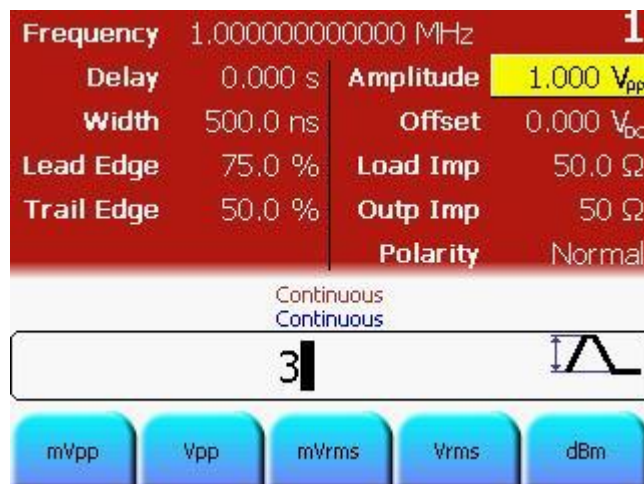

Setting the Offset

- The Offset is set to 0 VDC by default; therefore there is no need to change it.

Getting Started

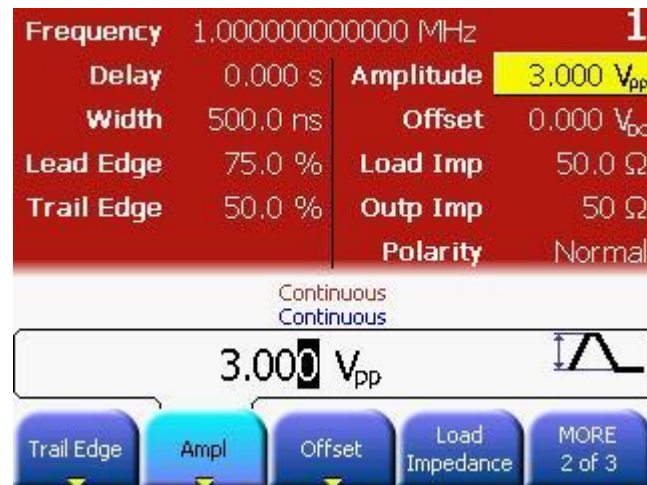

Enable Channel Coupling

- Press the **Coupling** key to enable Channel Coupling. This will set Channel 2 to continuous Pulse mode and ensure that both channels are locked in phase and frequency.

3.10.2 Settings for Channel 2

Selecting a Pulse waveform

To set the operating mode and trigger mode as required, do the following:

- Press the **Ch 2** key to select Channel 2.
- The *Continuous* trigger mode and *Pulse* waveform were copied from Channel 1 when we enabled Coupling. Therefore, we do not change these settings.

Selecting the Frequency

- By default, the *Frequency* is already set to 1 MHz, therefore we do not change it.

Setting Delay

- Press the **Delay** softkey and set the value to 200 ns.
-  For setting the value, you can use the Numeric Keypad or the Rotary Knob.

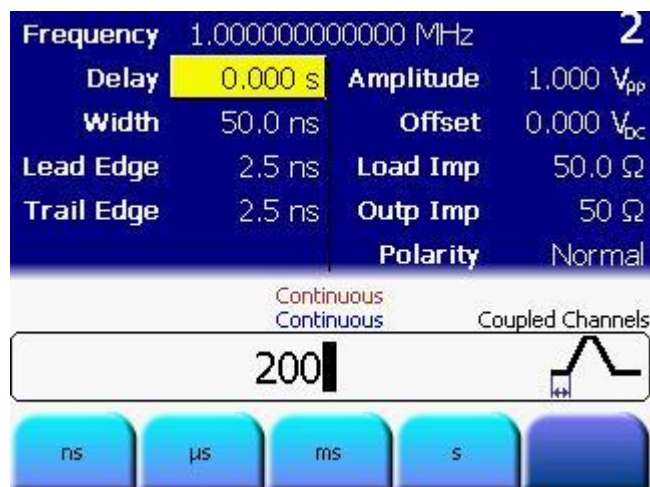

Getting Started

Setting Width

- Press the **Width** softkey and set the value to 10 ns.
✎ For setting the value, you can use the Numeric Keypad or the Rotary Knob.

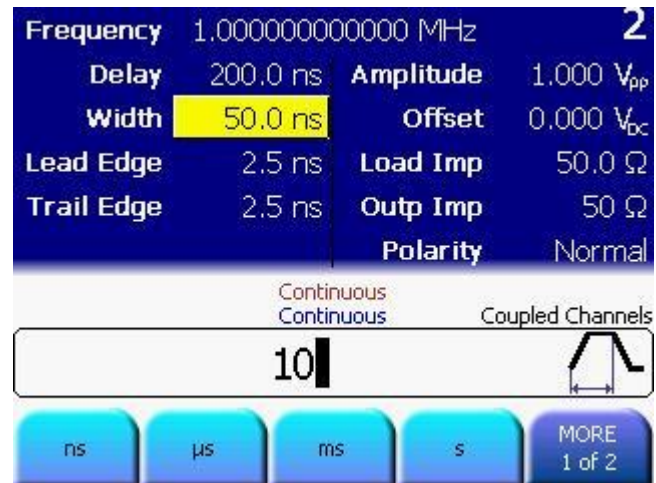

Setting the Lead Edge and Trail Edge

- By default, the *Lead Edge/Trail Edge* values are set to 2.5 ns, therefore we do not change these values.

Setting the Amplitude

- Press the **Ampl** softkey or use the navigation key to set the Amplitude. Set the amplitude to 2Vpp.

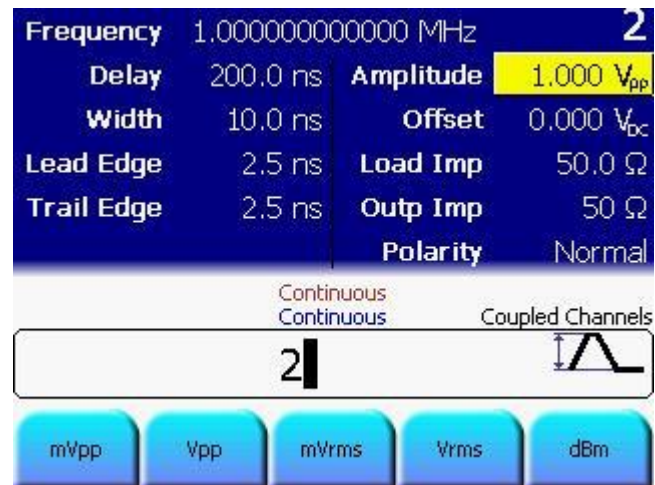

Setting the Offset

- By default, the *Offset* is set to 0 Vdc, therefore we do not change the values.

Getting Started

For Channel Addition

To perform Channel Addition:

- Press the **Ch 1** key.
- Press **Utility** key, **Output Setup** softkey and then **Channel Add** softkey.
- Press the **Channel Add** softkey and enable Added at Output 1.

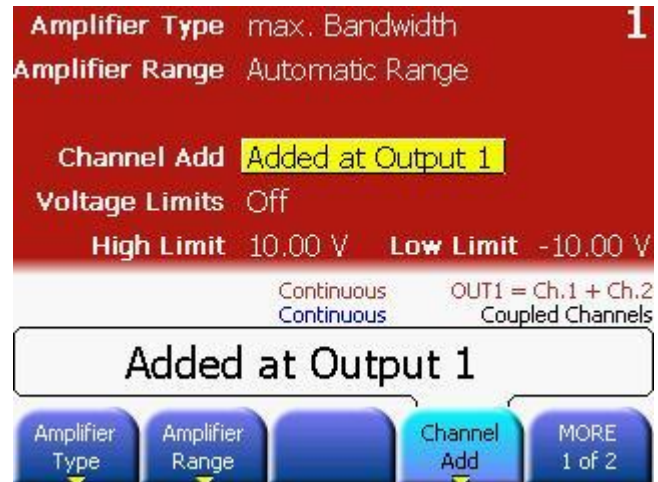

Programming Example

This example requires a 2 channel 81150A or 2 channel 81160A to run without errors.

Reset the instrument to start from a defined, default status.

```
*RST
```

Switch off the automatic display update to increase programming

speed

```
:DISPlay OFF
```

Enable channel coupling.

Initial coupling is done from channel 1 to channel 2

```
:TRACk:CHANnel1 ON
```

Set the output function to pulse on channel 1

Due to the channel coupling, this will also be applied to channel 2

```
:FUNCTion1 PULSe
```

Setup Channel 1

- Frequency 1MHz (will also be applied to channel 2)

- Delay 0s

- Pulse width 500 ns

- Lead edge 75% of pulse width

- Trailing edge 50% of pulse width

- Offset 0V

- Amplitude 3Vpp

```
:FREQuency1 1MHZ
```

```
:PULSe:DELay1 0S
```

```
:PULSe:WIDTh1 500NS
```

```
:PULSe:TRANsition:HOLD WRATio
```

```
:PULSe:TRANsition1 75PCT
```

```
:PULSe:TRANsition1:TRAILing 50PCT
```

```
:VOLT1:OFFSet 0V
```

```
:VOLT1 3VPP
```

Getting Started

Programming Example

```
# Setup Channel 2
# - Delay 200ns
# - Pulse width 10 ns
# - Lead edge 2.5 ns
# - Trailing 2.5 ns
# - Offset 0V
# - Amplitude 2Vpp
:PULSe:DELay2 200nS
:PULSe:WIDTh2 10NS
:PULSe:TRANsition2 2.5NS
:PULSe:TRANsition2:TRAILing 2.5NS
:VOLT2:OFFSet 0V
:VOLT2 2VPP

# Enable channel addition
:CHANnel:MATH PLUS

# Enable the output 1 and the complement output 1.
:OUTput1 ON
:OUTput1:COMPLEMENT ON
```

**Oscilloscope
screen-shot**

The following image shows the signal as displayed on the Keysight 54810A Infiniium Oscilloscope.

81150A: The Trigger Out can be used directly to trigger the scope. The screenshot of the 81150A is shown below.

81160A: The Logical Trigger Signal must be routed to the physical Sync Out A or Sync Out B BNC connector. The instrument default settings route the Logical Trigger Signal of channel 1 to Sync Out A and the Logical Strobe Signal of channel 1 to Sync Out B.

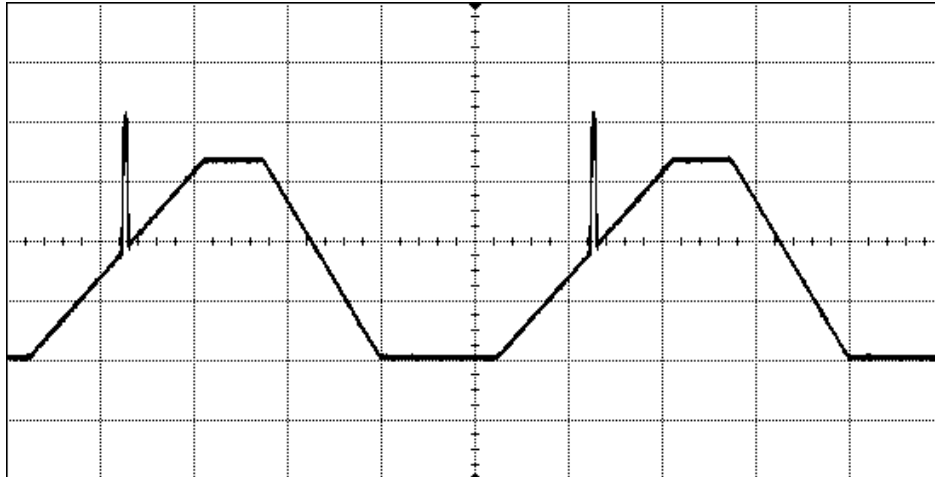

4 Installation and Maintenance

Introduction

This chapter explains how to install and maintain the 81150A / 81160A. It covers the following:

- Options and Accessories
 - Power Requirements
 - Ventilation Requirements
 - Thermal Protection
 - Battery
 - Operating Environment
 - Cleaning Recommendation
-

4.1 Options and Accessories

Rack Mounting Accessories

Keysight Part number 5063-9219.

4.2 Power Requirements

Caution Before applying AC line power to the instrument, ensure that the correct power cable is fitted.

Note When the front panel switch is off, the Mainframe is in “Standby” mode. Disconnection from the AC Line Power is accomplished only by disconnecting the power cord. Please make sure that the power cord is easily identifiable and can quickly be reached by the operator.

The instrument can operate from any single-phase AC power source supplying 100–240 V in the frequency range from 50 to 60 Hz, or 100–120 V at 400 Hz. The maximum power consumption is 180 VA with all options installed. When the instrument is switched on the power supply adapts automatically to the applied AC power (Auto Selection) and monitors the AC power range during operation.

4.3 Ventilation Requirements

Introduction

The instrument is fitted with three cooling fans. Make sure that there is adequate clearance of 80 mm at the rear and 25 mm on both sides to ensure adequate air flow. If the air flow is restricted the internal operating temperature will be higher, reducing the instrument's reliability or causing the instrument's thermal-protection circuits to automatically switch off the instrument.

4.3.1 Thermal Protection

Overheating Detection

The instrument monitors its internal temperature. If the temperature exceeds approximately 80°C the power supply is switched off. The instrument will not turn on automatically if the temperature is decreasing again.

Fan Failure

If a fan is broken or prevented from operating by a blockage the temperature will increase. When the temperature exceeds approximately 80°C the overheating detection switches off the instrument for safety reasons. For reliability it is recommended to send instruments with broken or defective fans immediately to Keysight Service for repair.

4.4 Battery

Introduction

The 81150A / 81160A contains one lithium battery. The typical life time of this battery depends on the environmental temperature.

If the environmental temperature is 25° C, then the battery lasts for about 20 years. If the environmental temperature is 55° C, then the battery lasts for about 3 years.

Note



- Recycle or dispose used batteries according to local regulations. Or contact your Keysight representative for information on battery recycling.
- The battery is replaceable. **Replacement** should only be carried out **by qualified service personnel**.
- There is a danger of explosion if the battery is incorrectly replaced.
- The battery must be replaced with the same or equivalent battery type: A **Lithium CR2477-N** type battery.
- The Keysight replacement part number is: 1420-0557.
- The battery is protected against charging.

CAUTION

Do NOT crush, puncture, or incinerate the batteries. Do NOT short the battery's external contacts.

4.5 Operating Environment

Storage Temperature	-40 °C to +70 °C
Operating Temperature	81150A: 0 °C to 50 °C 81160A: 0 °C to 55 °C
Humidity	95%R.H. (at 40°C)
Altitude	Up to 2000 m
Installation	Category II
Pollution	Degree 2

Warning

The instrument is not designed for outdoor use. Do not expose the instrument to rain or other excessive moisture. Protect the instrument from humidity and temperature changes which could cause condensation within the instrument.

Do not operate the instrument in the presence of flammable gases, fumes or powders. Operation of any electrical instrument in such an environment constitutes a definite safety hazard.

4.6 Cleaning Recommendation

Warning

To prevent electrical shock, disconnect the instrument from mains before cleaning. Use a dry cloth or one slightly dampened with water to clean external case parts. Do not attempt to clean internally.



This information is subject to change without notice.
© Keysight Technologies 2011, 2014
Edition 2.0, August 2014



81160-91010

www.keysight.com