

Agilent 8110A 150 MHz Pulse Generator

User's Guide

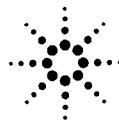

Agilent Technologies

Important Note

Hewlett-Packard's (HP) Test and Measurement Business is now part of Agilent Technologies (AGILENT), a new company created by Hewlett-Packard. Information in this manual may refer to Hewlett-Packard, but applies to your Agilent Technologies product.

Hewlett-Packard, HP, and Agilent branded products with the same model number are interchangeable.

User's Guide

HP 8110A 150 MHz Pulse Generator



**HP Part No. 08110-91012
Printed in Germany January 1995**

**Edition 3.0
E0195**

Notice

Copyright

© 1993 Hewlett-Packard GmbH.
Herrenberger Str. 130
71034 Böblingen
Federal Republic of Germany

All Rights Reserved. Reproduction, adaptation or translation without prior written permission is prohibited, except as allowed under the copyright laws.

Warranty

The information contained in this document is subject to change without notice.

Hewlett-Packard makes no warranty of any kind with regard to this material, including, but not limited to, the implied warranties or merchantability and fitness for a particular purpose.

Hewlett-Packard shall not be liable for errors contained herein or for incidental or consequential damages in connection with the furnishing, performance, or use of this material.

Complete product warranty information is given in the User Guide.

Safety

This is a Safety Class 1 instrument (provided with terminal for protective earthing). Before applying power, verify that the correct safety precautions are taken (see the following warnings). In addition, note the external markings on the instrument that are described under **Safety Symbols**. Do not operate the instrument with its covers removed. Replace fuse only with specified type.

Warning

Before turning on the instrument, you must connect the protective earth terminal of the instrument to the protective earth conductor of the (mains) power cord. The mains plug must only be inserted in a socket outlet with a protective earth contact. Do not negate the protective action by using an extension power cord without a protective grounding conductor. Grounding one conductor of a two-conductor outlet is not sufficient protection.

Service instructions are for trained service personnel. To avoid dangerous electric shock, do not perform any service unless qualified to do so. Do not attempt internal service or adjustment unless another person, capable of rendering first aid and resuscitation, is present.

If you energize this instrument using an auto-transformer (for voltage reduction) make sure that the common terminal is connected to the earth terminal of the power source.

Whenever it is likely that the ground protection is impaired, you must make the instrument inoperative and secure it against any unintended operation.

Do not operate the instrument in the presence of flammable gases or fumes. Operation of any electrical instrument in such an environment constitutes a definite safety hazard.

Do not install substitute parts or perform any unauthorized modification to the instrument.

Capacitors inside the instrument may retain a charge even if the instrument is disconnected from its source of supply.

Safety Symbols



Instruction Manual symbol: The instrument is marked with this symbol when it is necessary for you to refer to the instruction manual in order to protect against damage to the instrument.



Protected conductor symbol

WARNING

The Warning symbol calls attention to a procedure, practice, or the like, which, if not correctly performed or adhered to, could result in personal injury or loss of life. Do not proceed beyond a Warning symbol until the indicated conditions are fully understood and met.

CAUTION

The Caution symbol calls attention to a procedure, practice, or the like, which, if not correctly performed or adhered to, could result in damage to or destruction of part or all of the equipment. Do not proceed beyond a Caution symbol until the indicated conditions are fully understood and met.

Notice

Warranty

This Hewlett-Packard product has a warranty against defects in material and workmanship for a period of one year from date of shipment. During the warranty period, Hewlett-Packard Company will, at its option, either repair or replace products that prove to be defective.

For warranty service or repair, this product must be returned to a service facility designated by Hewlett-Packard. The Buyer shall pay Hewlett-Packard's round-trip travel expenses.

For products returned to Hewlett-Packard for warranty service, the Buyer shall prepay shipping charges to Hewlett-Packard and Hewlett-Packard shall pay shipping charges to return the product to the Buyer. However, the Buyer shall pay all shipping charges, duties and taxes for products returned to Hewlett-Packard from another country.

Hewlett-Packard warrants that its software and firmware designated by Hewlett-Packard for use with an instrument will execute its programming instructions when properly installed on that instrument. Hewlett-Packard does not warrant that the operation of the instrument software, or firmware, will be uninterrupted or error free.

Limitation of Warranty

The foregoing warranty shall not apply to defects resulting from improper or inadequate maintenance by the Buyer, Buyer-supplied software or interfacing, unauthorized modification or misuse, operation outside of the environmental specifications for the product, or improper site preparation or maintenance.

No other warranty is expressed or implied. Hewlett-Packard specifically disclaims the implied warranties of merchantability and fitness for a particular purpose.

Exclusive Remedies

The remedies supplied are the Buyer's sole and exclusive remedies. Hewlett-Packard shall not be liable for any direct, indirect, special, incidental, or consequential damages, whether based on contract, tort or any other legal theory.

Assistance

Product maintenance agreements and other customer assistance agreements are available for Hewlett-Packard products. For any assistance, contact your nearest Hewlett-Packard Sales Office.

Certification

Hewlett-Packard Company certifies that this product met its published specifications at the time of shipment. Hewlett-Packard further certifies that its calibration measurements are traceable to the United States Institute of Standards and Technology, to the extent allowed by the Institute's calibrating facility, and to the calibration facilities of other International Standards Organization members.

About this edition

HP Part Number
08110-91012

Printed in Germany

Edition 3.0 E0195
January 1995

About this book

This book is a guide to operating and programming the HP 8110A with all possible modules installed:

Module	Description	Quantity
HP 81103A	10 V/2 ns Output Channel	2
HP 81106A	PLL/External Clock	1
HP 81107A	Multichannel Deskew	1

If your instrument does not have one or more of these modules installed, some of the described features will not be available.

Installing Line voltage, fuse and other installation information.

Introducing the HP 8110A

An overview of the instrument frontpanel and features, and a Getting Started guide.

Operating Reference A reference guide for using the frontpanel parameter-screens to operate the instrument.

Programming Reference



A SCPI reference guide for programming the instrument via HP-IB.

Testing the HP 8110A

Performance tests for checking the HP 8110A against its specifications.

Specifications The specifications of the HP 8110A and its modules.

Contents

1. Installing the HP 8110A	
Initial Inspection	1-1
Power Requirements	1-2
	1-2
Replacing the Fuse	1-2
Power Cable	1-3
Ventilation Requirements	1-4
Thermal Protection	1-4
Overheating Detection	1-4
Fan Failure	1-4
 Battery	1-5
Operating Environment	1-5
2. Introducing the HP 8110A	
Enhanced Pulse Capability for Digital Design Testing	2-1
Benchtop Testing	2-1
Automated Testing	2-1
Reliable Testing	2-1
Upgradeable Testing	2-1
An Overview of the Frontpanel	2-2
Controls	2-2
Inputs / Outputs	2-3
Functional Overview	2-4
1 TRG-MODE	2-4
2 TRG-LEVEL	2-4
3 TIMING*	2-4
4 LEVELS*	2-5

5 OUTPUT 1/2*	2-5
6 LIMITS	2-5
7 PATTERN	2-5
8 CONFIG	2-5
An Overview of the Rearpanel	2-6
Inputs / Outputs	2-6
General	2-7
Getting started	2-8
Selftest	2-8
Selecting a parameter	2-9
Adjusting the selected parameter value	2-10
Selecting a parameter screen	2-10
Changing a setting	2-11
Toggling between GRAPHICS and TEXT screens	2-12
Parameter Screen summary	2-12
Adjusting a parameter or setting	2-14
Switching the Outputs on and off	2-15
Output 1	2-15
Output 2	2-15
Short-cut for quickly adjusting important parameters	2-15

3. Operating Reference

Introduction	3-1
Using Help	3-2
Parameter Help ON FIELD	3-2
Example - Delay parameter	3-2
Example - Delay Format	3-3
Concept Help CONCEPT	3-3
Serial Numbers and Software Revision	
SERIAL #	3-4
Warning Help WARNINGS	3-4
Error Queue ERROR QU	3-4
Frontpanel Controls	3-5
Softkeys □ and (MORE)	3-5
(SHIFT) /LOCAL	3-5
(HELP) /AUTOSET	3-5
(STORE) /RECALL	3-5

MAN	3-6
DATA ENTRY	3-6
CURSOR/VERNIER	3-6
MODIFY knob	3-6
Connectors	3-7
EXT INPUT	3-7
TRIGGER OUT	3-7
STROBE OUT	3-7
TRG-MODE Screen	3-8
CONTINUOUS PULSES Mode	3-9
CONTINUOUS BURST Mode	3-10
CONTINUOUS PATTERN Mode	3-11
TRIGGERED PULSES Mode	3-13
TRIGGERED BURST Mode	3-15
TRIGGERED PATTERN Mode	3-17
GATED PULSES Mode	3-19
GATED BURST Mode	3-21
GATED PATTERN Mode	3-23
EXT WIDTH Mode	3-24
TIMING screen	3-25
Modifying the value of a parameter	3-26
Modifying the format of a parameter	3-26
ON/OFF Parameter	3-26
Pulse-period Parameter	3-27
Output Delay Parameter	3-27
Delay	3-27
Delay%	3-28
Phase	3-28
Pulse Width Parameter	3-28
Width	3-28
DutyCyc	3-28
TrDel	3-29
Pulse Leading-edge Parameter	3-30
LeadEdg	3-30
LeadEd%	3-30
Pulse Trailing-edge Parameter	3-31
=LeadE	3-31
TrailEd	3-31
TrailE%	3-31
LEVELS screen	3-32
Modifying the value of a parameter	3-33

Modifying the format of a parameter . . .	3-33
ON/OFF Parameter	3-33
Normal/Complmnt Parameter	3-34
Seperate/Added Outputs Parameter . . .	3-34
Seperate Outputs	3-34
Added at Output 1	3-35
Offset, Amplit, High, Low Level	
Parameters	3-36
Set TTL	3-36
High-Low	3-36
Offs-Ampl	3-36
Set ECL	3-37
mV mA A Voltage/Current Mode	3-37
50 Ω into OUTPUT Source Impedance	
Parameter	3-37
50.0 Ω Load Impedance Parameter	3-37
Output Voltage and Power Protection . . .	3-38
OUTPUT screens	3-39
Modifying the value of a parameter . . .	3-40
Modifying the format of a parameter . . .	3-40
Pulse-period Parameter	3-41
Normal/Complmnt Parameter	3-41
ON/OFF Parameter	3-41
Output Delay Parameter	3-42
Delay	3-42
Delay%	3-42
Phase	3-42
Pulse Width Parameter	3-43
Width	3-43
DutyCyc	3-43
TraDel	3-44
Pulse Leading-edge Parameter	3-45
LeadEdg	3-45
LeadEd%	3-45
Pulse Trailing-edge Parameter	3-46
=LeadE	3-46
Trailed	3-46
Traile%	3-46
Seperate/Added Outputs Parameter . . .	3-47
Seperate Out2	3-47
Added to Out1	3-47

Offset, Amplit, High, Low Level	
Parameters	3-49
Set TTL	3-49
High-Low	3-49
Offs-Ampl	3-49
Set ECL	3-49
mV V mA A Voltage/Current Mode	3-50
50 Ω into OUTPUT Source Impedance	
Parameter	3-50
50.0 Ω Load Impedance Parameter	3-50
Output Voltage and Power Protection	3-51
PATTERN screen	3-52
UPDATE Parameter	3-53
UPDATE (Upd Cont)	3-53
NO UPD (Upd Once)	3-53
Addr Parameter	3-53
Last Parameter	3-53
Bit-Editing Window	3-53
OUTPUTS (CH1 CH2)	3-54
STROBE OUT (STRB)	3-55
CH1 CH2 BOTH STRB Block Editing	
Functions	3-55
Fill 0	3-56
Fill 1	3-56
Invert	3-56
First Bit	3-56
Last Bit	3-56
Ins Bit	3-56
Del Bit	3-56
Clock \div N	3-57
PRBS 2^n-1	3-57
Some Hints on Editing Pattern Data	3-57
Example	3-58
LIMITS screen	3-59
TRG-LEV screen	3-60
EXT-IN Parameter	3-60
Set TTL	3-60
Set ECL	3-60
Voltage	3-60
50 Ω 10k Ω EXT INPUT Impedance	
Parameter	3-61

CLK-IN Parameter	3-61
Set TTL	3-61
Set ECL	3-61
Voltage	3-61
50 Ω 10k Ω CLK IN Impedance Parameter	3-61
TRIGGER-OUT TRIGGER OUT Level	
Parameter	3-62
TTL	3-62
ECL	3-62
STROBE-OUT STROBE OUT Level	
Parameter	3-62
TTL	3-62
ECL	3-62
MEMCARD screen	3-63
Dir Path Current Directory Parameter	3-63
Filename Filename Parameter	3-64
Perform Operation Memory Card	
Operations	3-65
ReadCard	3-65
Recall	3-65
Store	3-65
Store All	3-66
Delete	3-67
Format	3-67
CONFIG screen	3-68
HP-IB Address	3-68
Perform Selftest	3-68
Group Params by	3-69
TIMING/LEVELS	3-69
OUTPUT 1/2	3-69
PLL-Ref	3-70
Internal	3-70
CLK-IN	3-70
Deskew	3-70
Warnings and Errors	3-71
Warnings	3-71
Errors	3-72
AUTOSET	3-72
An Example of Warning and Error	
Reporting	3-72



4. HP 8110A Programming Reference	
Common Command Summary IEEE 488.2	4-1
SCPI Command Summary	4-2
Firmware Anomalies of Revision 02.02.00	4-7
Status Model	4-9
Overview	4-9
Condition Register	4-10
Transition Filters	4-10
Event Register	4-10
Enable register	4-10
Status Byte	4-11
Standard Event Status Group	4-12
OPERation Status Group	4-13
QUESTionable Status Group	4-14
Programming the HP 8110A Trigger Modes	4-15
CONTINUOUS	4-16
TRIGGERED	4-16
GATED	4-16
EXT WIDTH	4-16
PULSES	4-17
BURST of	4-17
PATTERN	4-17
Command Dictionary	4-18
Form	4-18
Parameter	4-18
Parameter Suffix	4-18
Functional Coupling	4-18
Value Coupling	4-18
Range Coupling	4-18
*RST value	4-18
Specified Limits	4-18
Absolute Limits	4-19
Example	4-19
:ARM:EWIDTH:STATe	4-20
:ARM:FREQUency	4-21
:ARM:IMPedance	4-22
:ARM:LEVel	4-23
:ARM:PERiod	4-24
:ARM:SENSe	4-25
:ARM:SLOPe	4-26
:ARM:SOURce	4-27

:CHANnel:MATH	4-28
:DIGital[:STIMulus]:PATtern:DATA[1 2 3]	4-29
:DIGital[:STIMulus]:PATtern:PRBS[1 2 3]	4-32
:DIGital[:STIMulus]:PATtern:PRESet[1 2 3]	4-33
:DIGital[:STIMulus]:PATtern[:STATE]	4-34
:DIGital[:STIMulus]:PATtern:UPDate	4-35
:DIGital[:STIMulus]:SIGNal[1 2]:FORMat	4-36
:DISPlay[:WINDow][:STATE]	4-37
:MMEMory:CATalog?	4-38
:MMEMory:CDIRectory	4-39
:MMEMory:COpy	4-40
:MMEMory:DELeTe	4-41
:MMEMory:INITialize	4-42
:MMEMory:LOAD:STATe	4-43
:MMEMory:STORE:STATe	4-44
:OUTPut[1 2][:STATe]	4-45
:OUTPut[1 2]:IMPedance[:INTernal]	4-46
:OUTPut[1 2]:IMPedance:EXTernal	4-47
:OUTPut[1 2]:POLarity	4-48
[:SOURce]:CORRection[1 2]:EDELay[:TIME]	4-49
[:SOUR]:CURRent[1 2][:LEV][:IMM][:AMPL]	4-50
[:SOUR]:CURR[1 2][:LEVeL][:IMM]:OFFS	4-51
[:SOUR]:CURR[1 2][:LEV][:IMM]:HIGH	4-52
[:SOUR]:CURR[1 2][:LEV][:IMMEDIATE]:LOW	4-54
[:SOURce]:CURRent[1 2]:LIMit[:HIGH]	4-56
[:SOURce]:CURRent[1 2]:LIMit:LOW	4-57
[:SOURce]:CURRent[1 2]:LIMit:STATe	4-58
[:SOURce]:FREQUency[:CW]:FIXed]	4-59
[:SOURce]:FREQUency[:CW]:FIXed]:AUTO	4-60
[:SOURce]:HOLD	4-61
[:SOURce]:PHASe[1 2][:ADJust]	4-62
[:SOURce]:PULSe:DCYCLE[1 2]	4-64
[:SOURce]:PULSe:DELay[1 2]	4-65
[:SOURce]:PULSe:DELay[1 2]:HOLD	4-66
[:SOURce]:PULSe:DELay[1 2]:UNIT	4-67
[:SOURce]:PULSe:DOUBle[1 2][:STATe]	4-68
[:SOURce]:PULSe:DOUBle[1 2]:DELay	4-69
[:SOURce]:PULSe:DOUBle[1 2]:DELay:HOLD	4-70
[:SOURce]:PULSe:DOUBle[1 2]:DELay:UNIT	4-71
[:SOURce]:PULSe:HOLD[1 2]	4-72
[:SOURce]:PULSe:PERiod	4-73

[:SOURCE]:PULSe:PERIoD:AUTO	4-74
[:SOURCE]:PULSe:TrailingDELay[1 2]	4-75
[:SOURCE]:PULSe:TRANsition[1 2]:HOLD	4-76
[:SOURCE]:PULSe:TRANsition[1 2]:UNIT	4-77
[:SOURCE]:PULSe:TRANsition[1 2][:LEADing]	4-78
[:SOURCE]:PULSe:TRANsition[1 2]:TRAILing	4-79
[:SOURCE]:PULSe:TRAN[1 2]:TRAILing:AUTO	4-80
[:SOURCE]:PULSe:TRIGger[1 2]:VOLTage	4-81
[:SOURCE]:PULSe:WIDTh[1 2]	4-82
[:SOURCE]:ROSCillator:SOURce	4-83
[:SOURCE]:ROSCillator:EXTeRnal:FREQUency	4-84
[:SOUR]:VOLT[1 2][:LEV][:IMM][:AMPLitude]	4-85
[:SOUR]:VOLTage[1 2][:LEV][:IMM]:OFFSet	4-86
[:SOUR]:VOLT[1 2][:LEV][:IMMediate]:HIGH	4-87
[:SOUR]:VOLT[1 2][:LEV][:IMMediate]:LOW	4-89
[:SOURCE]:VOLTage[1 2]:LIMit[:HIGH]	4-90
[:SOURCE]:VOLTage[1 2]:LIMit:LOW	4-91
[:SOURCE]:VOLTage[1 2]:LIMit:STATe	4-92
:STATus:OPERation	4-93
:STATus:PRESet	4-94
:STATus:QUEStionable	4-95
:SYSTem:CHECK[:ALL][:STATe]	4-97
:SYSTem:ERRor?	4-98
:SYSTem:KEY	4-99
:SYSTem:PRESet	4-101
:SYSTem:SECurity[:STATe]	4-102
:SYSTem:SET	4-103
:SYSTem:VERsion?	4-104
:SYSTem:WARning[:COUNt]?	4-105
:SYSTem:WARning:STRing?	4-106
:SYSTem:WARning:BUFFer?	4-107
:TRIGger:COUNt	4-108
:TRIGger:IMPedance	4-110
:TRIGger:LEVel	4-111
:TRIGger:SLOPe	4-112
:TRIGger:SOURce	4-113
Default Values, standard settings	4-114

5. Testing the HP 8110A	
Introduction	5-1
Conventions Used	5-1
Test Results Tables	5-1
Recommended Test Equipment and Accessories	5-2
50 Ohm, 0.1%, 10 W Feedthrough Termination	5-4
Getting Started	5-5
Typical Examples of Displayed Screens	5-5
Instrument Serial Numbers	5-7
Initial Setup of the HP 8110A	5-7
Test 1: Period	5-9
Test Specifications	5-9
Equipment Needed	5-9
Procedure	5-9
Test 2: PLL Period	5-13
Test Specifications	5-13
Equipment Needed	5-13
Procedure	5-13
Test 3: Width	5-16
Test Specifications	5-16
Equipment Needed	5-16
Procedure	5-16
Test 4: Delay	5-20
Test Specifications	5-20
Equipment Needed	5-20
Procedure	5-20
Test 5: Double Pulse Delay	5-25
Test Specifications	5-25
Equipment Needed	5-25
Procedure	5-25
Test 6: Jitter	5-31
Test 6.1a: Period Jitter, Internal Oscillator	5-31
Test Specifications	5-31
Equipment Needed	5-31
Procedure	5-31
Test 6.1b: Period Jitter, Internal PLL (If HP 81106A is installed)	5-34
Test Specifications	5-34
Equipment Needed	5-34

Procedure	5-34
Test 6.2: Width Jitter	5-38
Test Specifications	5-38
Equipment Needed	5-38
Procedure	5-38
Test 6.3: Delay Jitter	5-42
Test Specifications	5-42
Equipment Needed	5-42
Procedure	5-42
Test 7: High and Low Levels	5-45
Test Specifications	5-45
Equipment Needed	5-45
Procedure	5-46
Test 7.1: High Level, 50 Ohms into 50 Ohms	5-47
Test 7.2: Low Level, 50 Ohms into 50 Ohms	5-49
Test 7.3: High Level, 1K Ohms into 50 Ohms	5-51
Test 7.4: Low Level, 1K Ohms into 50 Ohms	5-53
Test 8: Transition Time	5-55
Test Specifications	5-55
Equipment Needed	5-55
Procedure	5-56
Test 8.1a: Leading Edge Test	5-56
Test 8.1b: Trailing Edge Test	5-59
Test 8.2a: Min. Leading edge for Level Window $>\pm 5V$	5-61
Test 8.2b: Min. Trailing edge for Level Window $>\pm 5v$	5-63
Test 9: Pulse Aberration Test	5-64
Test Specifications	5-64
Equipment Needed	5-64
Procedure	5-64
Overshoot and Ringing	5-65
Preshoot	5-66
HP 8110A Performance Test Records	5-68

6. Specifications	
General	6-1
Environmental	6-1
Safety	6-1
Power requirements	6-1
Maximum Dimensions (H x W x D)	6-2
Weight	6-2
Net	6-2
Shipping	6-2
Recalibration period	6-2
Warranty	6-2
Acoustic Noise Emission	6-2
Declaration of Conformity	6-3
We declare that the product	6-3
Supplementary Information	6-3
HP 8110A 150 MHz Pulse Generator	
Mainframe	6-4
Timing	6-4
Period	6-4
Configuration	6-4
Channel Addition	6-4
Output Modes	6-4
Pulses Mode	6-4
Burst Mode	6-5
Pattern Mode	6-5
Trigger Modes	6-5
Continuous	6-5
Triggered	6-5
Gated	6-6
External Width	6-6
External Input	6-6
	6-6
Strobe Output	6-7
	6-7
Typical Delay from EXT INPUT	6-7
Trigger Output	6-7
	6-7
Typical Delay from EXT INPUT	6-7
Human Interface	6-8

Overprogramming	6-8
Warnings and Errors	6-8
HELP key	6-8
Memory	6-8
Non-volatile memory	6-8
Memory-card	6-8
Remote Control	6-8
Programming times	6-9
HP 81103A 10 V/2 ns Output Channel for the	
HP 8110A	6-10
Timing Parameters	6-10
Common specifications	6-10
Width	6-10
Delay	6-10
Double Pulse Delay	6-11
Transition Times	6-11
Outputs	6-12
	6-12
External Load compensation	6-12
Level Parameters	6-12
Pulse Performance	6-13
Overshoot/Preshoot, Ringing:	6-13
Channel Addition from 48Ω into 50Ω	6-14
HP 81106A PLL/External Clock for the HP	
8110A	6-15
Clock Input/ PLL Reference Input	6-15
Phase Locked Loop	6-15
External Clock	6-16
HP 81107A Multichannel Deskew for the HP	
8110A	6-17

Index

Figures

1-1. Power Cables - Plug Identification	1-3
2-1. TIMING Graphics (Dual Channel, Default settings)	2-8
2-2. TRG-MODE screen (Dual channel)	2-11
2-3. Parameter Screens: Single Channel	2-13
2-4. Parameter Screens: Dual Channel, Group Params by: TIMING/LEVELS	2-14
2-5. Parameter Screens: Dual Channel, Group Params by: OUTPUT 1/2	2-14
3-1. HELP on pulse-delay parameter	3-2
3-2. HELP on pulse-delay format	3-3
3-3. Typical TRG-MODE screen	3-8
3-4. Timing Diagram: CONTINUOUS PULSES	3-9
3-5. Timing Diagram: CONTINUOUS BURST	3-10
3-6. CONTINUOUS PATTERN Mode	3-11
3-7. Timing Diagram: TRIGGERED PULSES	3-13
3-8. Timing Diagram: TRIGGERED PULSES Trg'd by Both	3-14
3-9. Timing Diagram: TRIGGERED BURST Pulse-Period: internal Osc	3-15
3-10. Timing Diagram: TRIGGERED BURST Pulse-Period: internal PLL or CLK-IN	3-16
3-11. Timing Diagram: TRIGGERED PATTERN Pulse-Period: internal Osc	3-17
3-12. Timing Diagram: TRIGGERED PATTERN Pulse-Period: internal PLL or CLK-IN	3-18
3-13. Timing Diagram: GATED PULSES Pulse-Period: internal Osc	3-19
3-14. Timing Diagram: GATED PULSES Pulse-Period: PLL or CLK-IN	3-20

3-15.	Timing Diagram: GATED BURST Pulse-Period: internal Osc	3-21
3-16.	Timing Diagram: GATED BURST Pulse-Period: internal PLL or CLK-IN	3-22
3-17.	TIMING screen, text mode	3-25
3-18.	TIMING screen, graphics mode	3-25
3-19.	TIMING /OUTPUT Timing parameter graphics, Delay	3-27
3-20.	TIMING /OUTPUT Timing parameter graphics, Width	3-28
3-21.	TIMING /OUTPUT Timing parameter graphics, Trailing Delay	3-29
3-22.	TIMING /OUTPUT Timing parameter graphics, Leading-edge	3-30
3-23.	LEVELS screen, text mode	3-32
3-24.	LEVELS screen, graphics mode	3-32
3-25.	TIMING screen, Added Outputs	3-35
3-26.	LEVELS screen, Added Outputs text mode	3-35
3-27.	LEVELS screen, Added Outputs graphics mode	3-36
3-28.	OUTPUT 1 /OUTPUT screen, text mode . .	3-39
3-29.	OUTPUT 2 screen, text mode	3-39
3-30.	TIMING /OUTPUT Timing parameter graphics, Delay	3-42
3-31.	TIMING /OUTPUT Timing parameter graphics, Width	3-43
3-32.	TIMING /OUTPUT Timing parameter graphics, Trailing Delay	3-44
3-33.	TIMING /OUTPUT Timing parameter graphics, Leading-edge	3-45
3-34.	TIMING /OUTPUT Timing parameter graphics, Added Outputs	3-47
3-35.	OUTPUT 2 screen, Added Outputs text mode	3-48

3-36. LEVELS screen, Added Outputs graphics mode	3-48
3-37. PATTERN screen, text mode	3-52
3-38. PATTERN screen, graphics mode	3-52
3-39. PATTERN screen, Bit-editing window	3-53
3-40. PATTERN screen, Bit-editing window BOTH	3-54
3-41. PATTERN screen, Block editing functions	3-55
3-42. PATTERN Clock÷4, CH1=RZ, CH2=NRZ	3-57
3-43. LIMITS screen	3-59
3-44. Level graphics with Limits ON on OUTPUT 1	3-59
3-45. TRG-LEV screen	3-60
3-46. MEMCARD screen, No card present.	3-63
3-47. MEMCARD screen, Dir Path Example	3-63
3-48. MEMCARD screen, Subdirectory Example	3-64
3-49. MEMCARD screen, Filename Example	3-64
3-50. MEMCARD screen, Store Operation	3-65
3-51. CONFIG screen	3-68
3-52. CONFIG screen, External PLL Reference frequency	3-70
4-1. HP 8110A Status Groups	4-9
4-2. Component registers in a Status Group	4-10
4-3. HP 8110A ARM-TRIGGER model	4-15
5-1. 50 Ohm, 0.1%, 10 W Feedthrough Termination	5-4
5-2. The TRG MODE Screen Display in a Fully Fitted HP 8110A	5-5
5-3. The TRG MODE Screen Display in a Standard HP 8110A	5-5
5-4. The TRG MODE Screen With Manual Triggering in a Fully-Fitted HP 8110A	5-6
5-5. The TRG MODE Screen With Manual Triggering in a Standard HP 8110A	5-6
5-6. The Output Screen in a Standard HP 8110A	5-6

5-7. CONFIG Screen, Parameters grouped by
 OUTPUT 5-8
6-1. Leading/Trailing Edge ranges 6-11
6-2. Highest and lowest level combinations . . 6-14



Tables

1-1. Line Voltage and Fuse Selection	1-2
3-1. TRG-MODE Summary of modes	3-8
3-2. Filename suffixes	3-66
4-1. HP 8110A IEEE 488.2 Common Command Summary	4-1
4-2. HP 8110A SCPI Command Summary	4-2
4-3. HP 8110A Status Groups - Registers Used	4-11
4-4. Status Byte bits	4-12
4-5. Standard Event Status Group bits	4-12
4-6. OPERation Status Group bits	4-13
4-7. QUESTionable Status Group bits	4-14
4-8. Pulse-period sources set by :TRIG:SOUR	4-17
4-9. Triggering sources and modes set by :ARM:SOUR	4-27
4-10. *RST PATTERN data	4-29
4-11. :SYSTem:KEY parameter reference	4-100
4-12. Pulse-period sources set by :TRIG:SOUR	4-113
4-13. HP 8110A Default Values	4-114
5-1. Recommended Test Equipment List	5-2
5-2. Recommended Accessories	5-3
5-3. Period Settings and TR Reference	5-11
5-4. Period Settings and TR Reference	5-12
5-5. PLL Period Settings and TR Reference	5-15
5-6. Width Settings and TR Reference	5-18
5-7. Width Settings and TR Reference	5-19
5-8. Delay Settings and TR Reference	5-23
5-9. Delay Settings and TR Reference	5-24
5-10. Double Delay Settings and TR Reference	5-27
5-11. Double Delay Settings and TR Reference	5-30
5-12. High and Low Test Specifications	5-45
5-13. High Level Settings (50 ohms - 50 ohms) and TR Reference	5-48

5-14. Low Level Settings (50 ohms - 50 ohms) and TR Reference	5-50
5-15. High Level Settings (1 Kohms - 50 ohms) and TR Reference	5-52
5-16. Low Level Settings (1 Kohms - 50 ohms) and TR Reference	5-54
5-17. Leading Edge Settings and TR Reference .	5-58
5-18. Trailing Edge Settings and TR Reference .	5-60
6-1. Typical Influence of Source Impedance on Timing and Levels	6-13

Installing the HP 8110A

Initial Inspection

Inspect the shipping container for damage. If the container or cushioning material is damaged, keep it until the contents of the shipment have been checked for completeness and the instrument has been verified both mechanically and electrically.

Warning



To avoid hazardous electric shock, do not perform electrical tests when there are signs of shipping damage to any part of the instrument's outer covers or panels.

If the contents are incomplete, or there is mechanical damage, or if the instrument does not pass the Performance Tests in Chapter 5, notify the nearest Hewlett-Packard office. Keep the shipping materials for inspection by the carrier. The HP office will arrange for repair or replacement without awaiting settlement.

Power Requirements



Caution



BEFORE APPLYING AC LINE POWER TO THE HP 8110A, ensure that the correct line fuse is installed in the fuse holder and the correct power cable is fitted.

The HP 8110A can operate from any single-phase AC power source supplying 100 – 240 V in the frequency range from 50 to 60 Hz , or 100 – 120 V at 400 Hz. The maximum power consumption is 300 VA with all options installed.

Table 1-1. Line Voltage and Fuse Selection

Line Voltage	Fuse Type	HP Part Number
100 – 240 V~	T 3A, 250 V	2110-0029

Replacing the Fuse

1. Remove the power cord.
2. Unscrew the fuse-holder at the rear of the instrument beside the power-inlet socket (See “An Overview of the Rearpanel” in Chapter 2).
3. Replace the fuse with the equivalent part (See Table 1-1).
4. Refit the fuse-holder.

Power Cable

In accordance with international safety standards, this instrument is equipped with a three-wire power cable. When connected to an appropriate AC power receptacle, this cable grounds the instrument cabinet. The type of power cable shipped with each instrument depends on the country of destination. Refer to Figure 1-1 for the part numbers of the power cables available.

Warning



To avoid the possibility of injury or death, the precautionary Warnings given on the inside front-cover of the manual must be followed before the instrument is switched on.

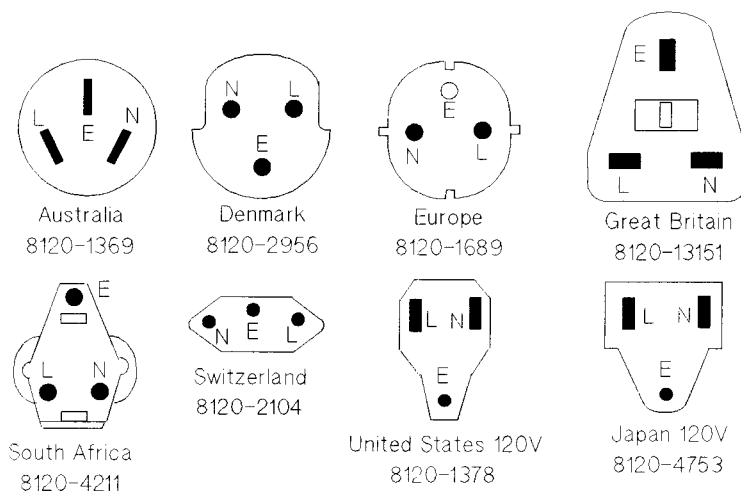

Figure 1-1. Power Cables - Plug Identification

The following work should be carried out by a qualified electrician - all local electrical codes being strictly observed. If the plug on the cable does not fit the power outlet, or the cable is to be attached to a terminal block, cut the cable at the plug end and re-wire it.

The color coding used in the cable will depend on the cable supplied. If a new plug is to be connected, it must

meet local safety requirements and include the following features:

- Adequate load-carrying capacity (see table of specifications).
- Ground connection.
- Cable clamp.

Ventilation Requirements

The HP 8110A is fitted with two cooling fans. Make sure that there is adequate clearance of 3 inches (75 mm) at the rear and 1/2 inch (12 mm) at the top and bottom to ensure adequate airflow. If the airflow is restricted the internal operating temperature will be higher, reducing the instrument's reliability or causing the instrument's thermal-protection circuits to automatically switch off the instrument.

Thermal Protection

Overheating Detection

The HP 8110A monitors its internal temperature in the region of the power supply. If the temperature exceeds approximately 80°C, the power supply is switched off. The instrument will switch on again if the temperature falls below approximately 77°C.

Fan Failure

If either of the fans is prevented from operating by a blockage, or the power supply to the fans is interrupted, the power supply is automatically switched off within 3 to 4 seconds. Note that after the fault condition has been fixed, the instrument must remain switched off for at least 2 minutes to allow the detection circuit to recover.



Battery

Warning



This instrument contains a lithium battery. The battery is not user-replacable and replacement should only be carried out by qualified service personnel.

There is a danger of explosion if the battery is incorrectly replaced.

The battery must be replaced with the same or equivalent type (HP Part No. 1420-0394). Discard used batteries according to local regulations.

Operating Environment

Storage Temperature:	-40°C to +70°C
Operating Temperature:	0°C to 55°C
Humidity:	95% R.H. (0°C to 40°C)

Warning



- **The HP 8110A is not designed for outdoor use. Do not expose the HP 8110A to rain or other excessive moisture. Protect the HP 8110A from humidity and temperature changes which could cause condensation within the instrument.**
- **Do not operate the HP 8110A in the presence of flammable gases, fumes or powders. Operation of any electrical instrument in such an environment constitutes a definite safety hazard.**

Introducing the HP 8110A

Enhanced Pulse Capability for Digital Design Testing

The HP 8110A 150 MHz Pulse Generator generates all standard pulses, digital patterns and multi-level waveforms needed to test CMOS and other digital designs up to 150 MHz.

Benchtop Testing The graphic display showing all pulse parameters at a glance, the Cursor keys and the Modify knob allow fast and simple operation.

Automated Testing The SCPI programming commands, optional rearpanel connectors and 3.5in rack height allow quick and efficient integration into automated test systems.

Reliable Testing The high pulse integrity with 10 ps timing resolution and down to 20 ps RMS-jitter with the optional PLL/External Clock all ensure consistent, reliable timing.

Upgradeable Testing The optional second output channel, PLL/External Clock module, and Multichannel Deskew module can be installed at any time, not just at the time of purchase.

Module	Description
HP 81103A	10 V/2 ns Output Channel
HP 81106A	PLL/External Clock
HP 81107A	Multichannel Deskew

An Overview of the Frontpanel

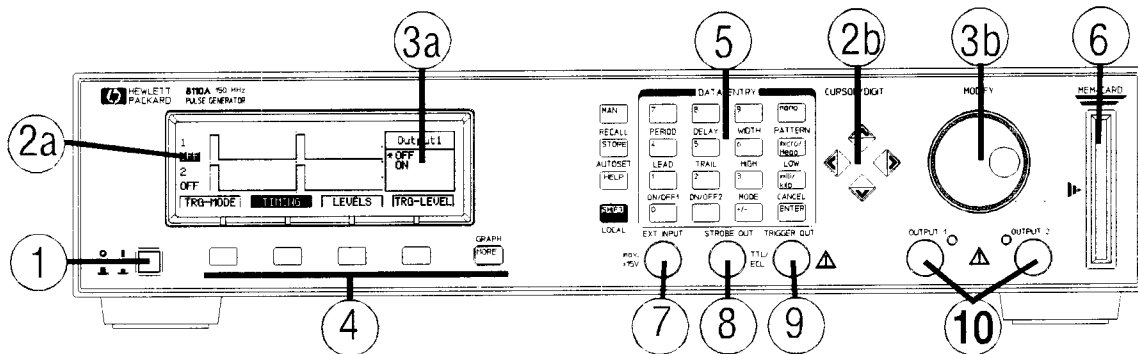

Controls

1. Switch on and off using the Line Switch.
2. Move the parameter cursor (a) using the CURSOR keys (b). The selected parameter is shown in the Modify Window at the right side of the display. Use the (SHIFT) CURSOR to select a DIGIT or increment/decrement a DIGIT in the Modify Window.
3. Modify the parameter/menu selection in the Modify Window (a) using the MODIFY knob (b).
4. Select a parameter screen using the Softkeys and (MORE). Use (SHIFT) (MORE) or press a softkey twice to toggle from the text display to the graphical display, when available.
5. Use the DATA ENTRY keys to type a value directly into the Modify Window or select a commonly used parameter quickly using the (SHIFT) functions above the keys.
6. Use a plug-in MEMORY CARD to store and recall instrument settings or update firmware.

Note



If your HP 8110A has Option UN2 Rear Panel Connectors, these Inputs/Outputs are fitted on the Rear Panel. Refer to “An Overview of the Rearpanel”.

7. **EXT INPUT** Connect an external trigger or gate signal here, or use EXT-WIDTH mode to perform pulse recovery.



Maximum External Voltage ± 15 V

8. **STROBE OUT**

- Signal with rising edge marking start of burst in BURST mode.
- Bitwise programmable in PATTERN mode.
- Not used in PULSES mode.



Maximum External Voltage -2 V/+7 V.

9. **TRIGGER OUT** Signal with rising edge marking start of each pulse-period.



Maximum External Voltage -2 V/+7 V.

10. **OUTPUT 1/2** Pulse outputs, channel 2 optional.



Maximum External Voltage ± 25 V.

Functional Overview

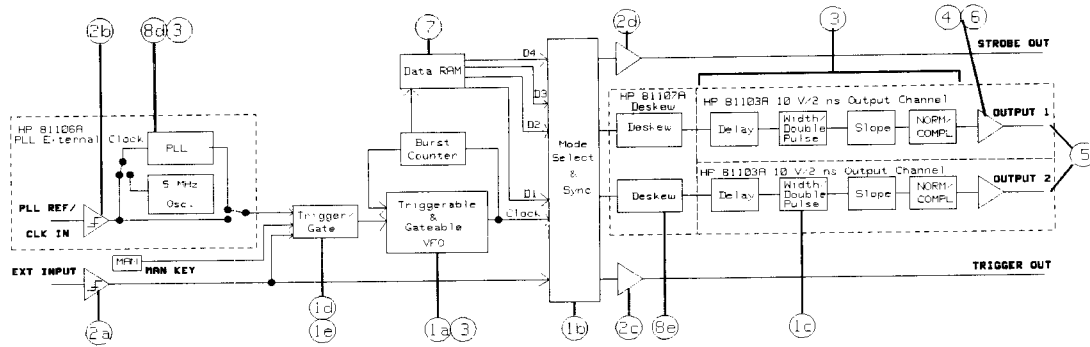

1 TRG-MODE

Use the TRG-MODE screen to:

- Select the Triggering mode.(CONTINUOUS, TRIGGERED, GATED, EXT WIDTH)
- Select the Triggered Event.(PULSES, BURST, PATTERN)
- Select the Pulse type (Single/Double or RZ/NRZ)
- Select the Pulse-period source.
- Select the Trigger/Gate source.

2 TRG-LEVEL

Use the TRG-LEVEL screen to:

- Set the Threshold and Input Impedance of the EXT INPUT and CLK INPUT.
- Set the Output Levels of the STROBE OUTPUT and TRIGGER OUTPUT.

3 TIMING*

Use the TIMING screen to control the pulse timing parameters for both outputs.

- 4 LEVELS *** Use the **LEVELS** screen to control the pulse level parameters for both outputs.
- 5 OUTPUT 1/2 *** Use an **OUTPUT** screen to control the timing *and* level parameters for a single output.
- 6 LIMITS** Use the **LIMITS** screen to set up voltage and current limits for the pulse level parameters to protect the Device Under Test (DUT).
- 7 PATTERN** Use the **PATTERN** screen to set up pattern data for the outputs and the **STROBE OUTPUT**.
- 8 CONFIG** Use the **CONFIG** screen to:
- *Choose between **TIMING /LEVELS** or **OUTPUT 1 /OUTPUT 2** Parameter grouping.
 - Perform selftest.
 - Set the HP-IB address.
 - Select the PLL Reference.
 - Set the output deskew timing.

***Note**



On a 2-channel instrument you can choose between displaying

- all parameters for one channel on a single parameter screen (**OUTPUT1 /OUTPUT2**)
- all the Timing parameters for both channels on one screen and all the Level parameters on another screen (**TIMING /LEVELS**)

using the **CONFIG** screen.

An Overview of the Rearpanel

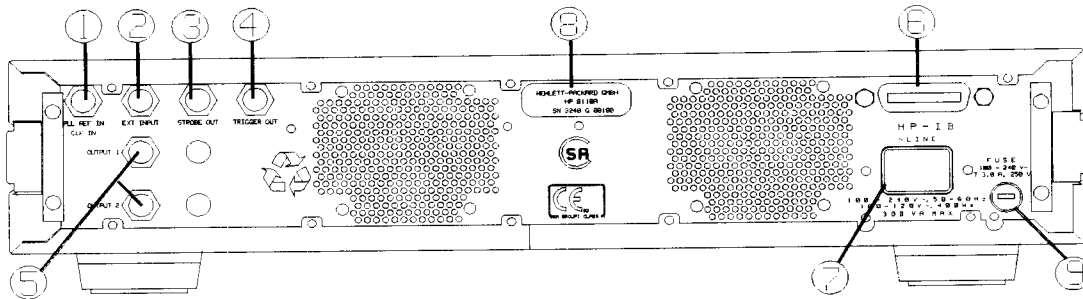

Inputs / Outputs

1. **PLL REF IN/CLK IN** If the HP 81106A PLL/External Clock module is fitted, connect an external frequency reference or clock signal here.

 Maximum External Voltage ± 15 V.

Note



If your HP 8110A doesn't have Option UN2 Rear Panel Connectors, the remaining Inputs/Outputs are fitted on the Frontpanel. Refer to "An Overview of the Frontpanel".

2. **EXT INPUT** Connect an external trigger or gate signal here, or use EXT-WIDTH mode to perform pulse recovery.

 Maximum External Voltage ± 15 V

3. **STROBE OUT**

- Signal with rising edge marking start of burst in BURST mode.
- Bitwise programmable in PATTERN mode.
- Not used in PULSES mode.

 Maximum External Voltage -2 V/ $+7$ V.

4. **TRIGGER OUT** Signal with rising edge marking start of each pulse period.

 Maximum External Voltage -2 V/+7 V.

5. **OUTPUT 1/2** Pulse outputs, channel 2 optional.

 Maximum External Voltage ± 25 V.

General

6. **HP-IB Connector**

7. **Line Voltage Connector**

8. **Serial Number** The HP 8110A mainframe serial number. Note that the Output, PLL/Clock, and Deskew modules have their own serial numbers.

9. **Fuse** 250 V, T 3A, 2110-0029

Getting started

Selftest

A few seconds after switching on the instrument the HP 8110A display switches on and indicates that the instrument selftest is running. This can take several seconds to complete, depending on how many modules are installed.

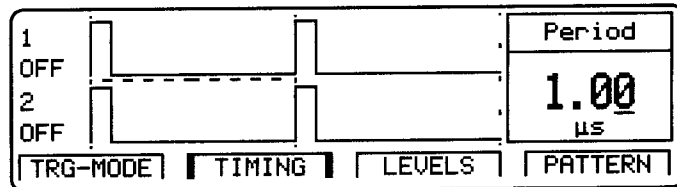

Figure 2-1. TIMING Graphics (Dual Channel, Default settings)

Note that Figure 2-1 is from a dual channel instrument with the default timing settings, no selftest errors and the parameter cursor located on pulse-period.

If the selftest fails

If the selftest fails, you see a flashing E at the bottom of the screen. Press **(HELP)** to see a list of the selftest error messages. Use the knob or CURSOR keys to scroll through the list if necessary. To return to normal operation press **(HELP)** again, or **EXIT HELP**.

Note that the selftest error messages are removed from the error queue after this.

Recalling the default settings

1. Press **(SHIFT)(STORE)** to select the RECALL function.
2. Press **(0)** to recall the default settings which are stored in memory 0.

Selecting a parameter

2

Use the CURSOR keys to move the parameter cursor between the available parameters. The name and value of the selected parameter are displayed in the MODIFY-window at the right of the display.

Select the Width1 (Output 1 pulse-width) parameter:

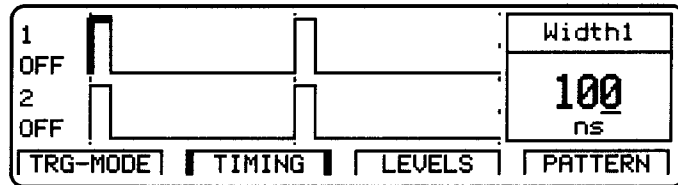

2 Adjusting the selected parameter value

Use the MODIFY knob to adjust the selected parameter.

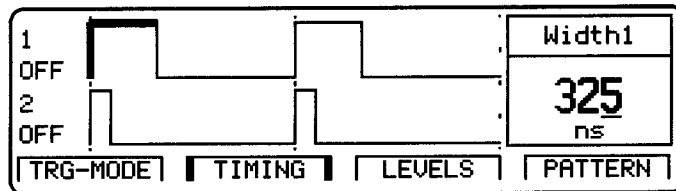

You can also type a value in directly using the DATA ENTRY keys, for example: **3 2 5 nano**

(Use CURSOR-left (←) to backspace during data entry, or (SHIFT) (ENTER) to CANCEL)

You can also use the VERNIER keys to step individual digits:

1. Press (SHIFT) to enter shift mode. The CURSOR keys now function as VERNIER keys.
2. Use (←) and (→) to move the digit cursor.
3. Use (↑) to increment and (↓) to decrement the digit.
4. Press (SHIFT) again to exit shift-mode. The CURSOR keys return to their standard role moving the parameter cursor.

Selecting a parameter screen

- Use the four softkeys directly below the display to move between the parameter screens. (The screen names are displayed above the keys).
- Press (MORE) to display more screen names because there can be up to eight parameter screens available, depending on the channels fitted to your mainframe.

Now press TRG-MODE to select the TRG-MODE screen:

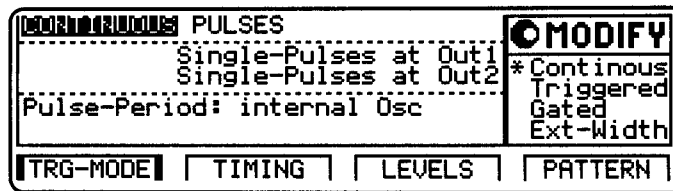
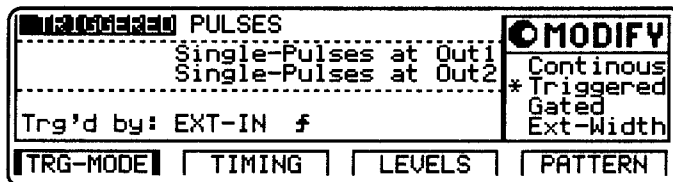

Figure 2-2. TRG-MODE screen (Dual channel)

Note that Figure 2-2 is from a dual channel instrument with the default settings and the parameter cursor located on the triggering mode which is currently set to CONTINUOUS. The available settings are listed in the MODIFY-window at the right of the display. The current setting is also indicated by *.

Changing a setting

Use the MODIFY knob to change the setting of the selected parameter. Set the trigger mode to TRIGGERED:



You can also use the VERNIER keys change the setting:

1. Press **SHIFT** to enter shift mode. The CURSOR keys now function as VERNIER keys.
2. Use **↑** and **↓** to select a setting from the list in the MODIFY-window.
3. Press **SHIFT** again to exit shift-mode. The CURSOR keys return to their standard role moving the parameter cursor.

2 Toggling between GRAPHICS and TEXT screens

The TIMING , LEVELS , and PATTERN screens can be displayed in either a text-based or graphics-based mode. To toggle between text and graphics, do one of the following:

- Press **SHIFT** **MORE** (GRAPH)
- Press the softkey for the current screen a second time.

On an OUTPUT screen, the currently selected parameter determines whether the TIMING graphics or LEVELS graphics are displayed in graphics mode.

Parameter Screen summary

All of the parameters and settings which control the HP 8110A are available on one of up to eight parameter screens. The parameter screens group together parameters which are most likely to be used together.

TRG-MODE	The overall operating modes of the instrument - triggering, pulse types, period and triggering sources.
TIMING	All the pulse timing-parameters for Outputs 1 and 2.
LEVELS	All the pulse voltage or current levels and impedances for Outputs 1 and 2.
TRG-LEVEL	EXT INPUT, STROBE OUT, TRIGGER OUT and CLK IN levels and impedances.
LIMITS	Voltage and current limits (for both outputs if fitted).
PATTERN	4096 bit pattern data (for both outputs, if fitted, and STROBE OUT).
MEM-CARD	Memory card operations.

CONFIG	General instrument configuration - HP-IB address, skew (if fitted) and parameter grouping.
OUTPUT 1	All timing, voltage/current and impedance parameters for Output 1. in dual channel instrument.
OUTPUT 2	All timing voltage/current and impedance parameters for Output 2 in dual channel instrument.
OUTPUT	All timing, voltage/current and impedance parameters for Output 1. in a single channel instrument.

Note 

The TIMING /LEVELS and OUTPUT 1 /OUTPUT 2 screens are *alternative* pairs of screens. You can select which parameter grouping to use on the CONFIG page.

Use the TIMING/LEVELS grouping if you want to see the timing of both outputs on one screen. Use the OUTPUT 1/2 grouping if you want to see all the parameters for one output on one screen.

A more detailed guide to each parameter screen is given in Chapter 3. "Functional Overview" provides a cross-reference between the parameter screens and the block-diagram of the instrument. The available parameter screens depend on the configuration of the instrument:

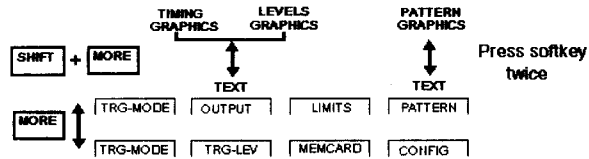

Figure 2-3. Parameter Screens: Single Channel

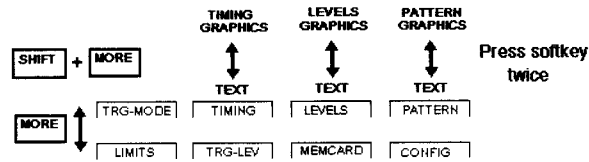

Figure 2-4.
Parameter Screens: Dual Channel, Group Params by:
TIMING/LEVELS

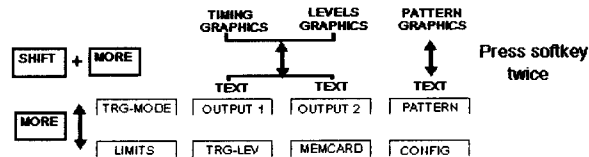

Figure 2-5.
Parameter Screens: Dual Channel, Group Params by:
OUTPUT 1/2

Adjusting a parameter or setting

To adjust a parameter/setting on the current screen:

- Use the CURSOR keys to move the parameter cursor onto the parameter/setting you want to adjust.

The Modify Window at the right hand side of the display shows the value of the selected parameter, or a list of options for the selected setting.

- Use the MODIFY knob to adjust the value of the parameter, or to choose a different setting from the setting-list. The selected setting is indicated by a *.
- Use the DATA ENTRY keys to enter a parameter value directly into the Modify Window without using the knob. Enter the value followed by the appropriate unit and then press **ENTER**.

Press CANCEL (**SHIFT** **ENTER**) to cancel the data entry, or use the cursor-left (**←**) key to backspace the digit-cursor.

- Press **SHIFT** to enter shift-mode and use the VERNIER (CURSOR) keys to move the digit-cursor within the

Modify Window. VERNIER a particular digit with the knob or the VERNIER keys.

2

Switching the Outputs on and off

When you switch the HP 8110A on, the outputs are switched off to protect the device under test. The LEDs next to the Output BNC connectors indicate the Output state.

Output 1

Press ON/OFF1 (**SHIFT** **0**) to quickly switch Output 1 on or off.

Output 2

Press ON/OFF2 (**SHIFT** **1**) to quickly switch Output 2 on or off.

You can also switch either output on or off on the **TIMING**, **LEVELS**, **OUTPUT 1** or **OUTPUT 2** screens by moving the parameter cursor onto the appropriate **ON** (**OFF**) field and turning the knob.

Short-cut for quickly adjusting important parameters

The most commonly used parameters can be accessed quickly using the short-cut (**SHIFT**) functions above the DATA ENTRY keys.

1. Press (**SHIFT**) and the DATA ENTRY key for the parameter you want
2. If necessary, press **1** or **2** to indicate which Output you want.

The appropriate parameter screen is automatically selected and the parameter cursor is placed on the chosen parameter.

3. Use the DATA ENTRY keys or knob to adjust the parameter.

Operating Reference

Introduction

This chapter is a reference guide for operating the HP 8110A using the frontpanel controls. It contains information on using the **HELP** key and the main frontpanel controls, followed by a reference section for each of the parameter screens selected by the softkeys under the display:

- Using Help
- Frontpanel Controls
- **TRG-LEV** Screen
- **TIMING** Screen
- **LEVELS** Screen
- **OUTPUT** Screens
- **PATTERN** Screen
- **LIMITS** Screen
- **TRG-LEV** Screen
- **MEMCARD** Screen
- **CONFIG** Screen

Using Help

Parameter Help ON FIELD

3

If there are no Warnings or Errors (See “Warnings and Errors”), press the **HELP** key at any time to obtain information about the current location of the parameter cursor. The help information gives a short description of the parameter or setting options and the SCPI command(s) syntax for programming the parameter or setting.

Use the **MODIFY** knob or **CURSOR** keys to scroll through the help information if there is more than one screen available.

Press **EXIT HELP** or **HELP** again to return to normal operation.

Example - Delay parameter

Press **HELP** with the parameter cursor on the *value* of the pulse-delay parameter:

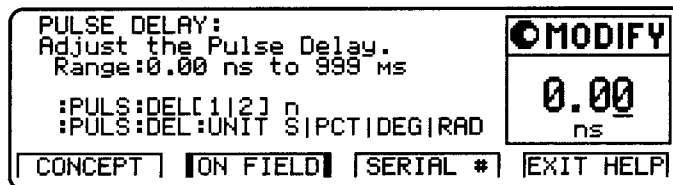
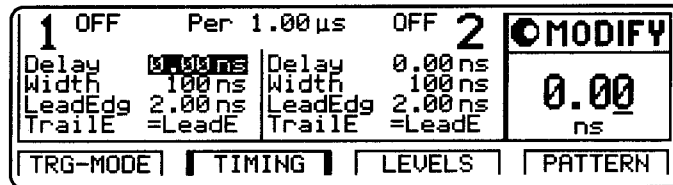

Figure 3-1. **HELP** on pulse-delay parameter

Example - Delay Format

Press **HELP** with the parameter cursor on the *format* of the pulse-delay parameter:

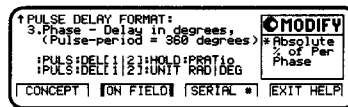
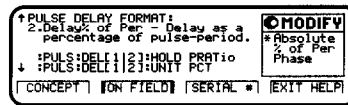
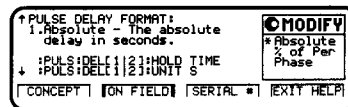
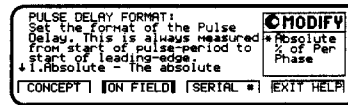
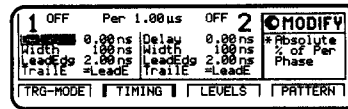

Figure 3-2. **HELP** on pulse-delay format

Concept Help **CONCEPT**

If there are no Warnings or Errors (See “Warnings and Errors”), press the **HELP** key followed by the **CONCEPT** softkey to view a short description of the HP 8110A.

Frontpanel Controls

Serial Numbers and Software Revision SERIAL

If there are no Warnings or Errors (See “Warnings and Errors”), press the **(HELP)** key followed by the SERIAL # softkey to see a list of the installed boards and their serial numbers followed by the software revision code of the instrument’s firmware.

3

Warning Help WARNINGS

If a Warning condition occurs, indicated by a flashing W, press **(HELP)** to see a list of the current warning messages.

Error Queue ERROR QU

If an Error condition occurs, indicated by a flashing E, press **(HELP)** to see a list of the current error messages.



Frontpanel Controls

Softkeys and

Use the softkeys to select the parameter screens. The names of the parameter screens are displayed above the softkeys. Press  to display alternative parameter screens.

3

/LOCAL



Press  to enter SHIFT-mode. A flashing  indicates that you are in SHIFT-mode. The extra functions available in SHIFT-mode are shown in blue *above* the keys.

Note that when using the VERNIER keys (CURSOR keys in SHIFT-mode) you must press  again to exit from SHIFT-mode.

When the instrument is programmed via the HP-IB it enters remote mode and disables the frontpanel controls. Press the  key to return to LOCAL operating mode.



/AUTOSET

Press  to obtain help on the currently selected parameter/setting.

Press AUTOSET ( ) to set the instrument to a valid setting based on the actual period setting.

/RECALL

Press  to store the current instrument setting in one of 9 memories.

Press RECALL ( ) to recall a complete instrument setting from one of the 9 memories, or to recall the default instrument settings from memory 0.

Frontpanel Controls

MAN

Use the **MAN** key to generate a manual trigger or gate signal when the HP 8110A is running in TRIGGERED or GATED trigger mode with the MAN key as the selected trigger/gate source.

3

DATA ENTRY

Use the DATA ENTRY keys to quickly enter a parameter value into the Modify Window. Enter the numeric value followed by the appropriate unit key.

During the data entry you can press CANCEL

(**SHIFT** **ENTER**) to cancel the entry or use the cursor-left **←** to backspace the digit-cursor.

Use the **SHIFT** DATA ENTRY functions indicated in blue above the keys to quickly select a particular parameter.

CURSOR/VERNIER

Use the CURSOR keys to move the parameter-cursor on the parameter screen. The parameter-cursor highlights the currently selected parameter or setting. This parameter or setting is then displayed in the Modify Window at the right hand side of the display.

In SHIFT-mode the CURSOR keys move the digit-cursor within the Modify Window and VERNIER the value of the selected digit.

MODIFY knob

Use the knob to modify the selected parameter in the Modify Window, or to select a setting from the list displayed in the Modify window.

On the PATTERN screen when the cursor is located in the Bit-Edit window you can use the knob to scroll through the pattern data. Modify the data with the DATA ENTRY keys.

Connectors

EXT INPUT

You can use an external signal connected to the EXT INPUT to trigger the HP 8110A by selecting TRIGGERED mode and Triggered by: EXT-IN on the TRG-MODE screen.

You can use an external signal connected to the EXT INPUT to gate (enable/disable) the HP 8110A by selecting GATED mode and Gated by: EXT-IN on the TRG-MODE screen.

You can use an external signal connected to the EXT INPUT to generate leading and trailing edges by selecting EXT_WIDTH mode and Width: EXT-IN on the TRG-MODE screen.

TRIGGER OUT

The TRIGGER OUT signal generates an output pulse for each pulse-period generated by the HP 8110A.

You can set the output levels to TTL or ECL on the TRG-LEV screen.

STROBE OUT

In PULSES mode, the STROBE OUT signal is not used.

In BURST mode, the STROBE OUT signal marks the start and end of each burst of pulses generated. The rising edge of the STROBE signal is synchronized to the start of the first pulse-period in a burst, the falling edge is synchronized to the start of the last pulse-period in the burst. Refer to Figure 3-5 for example.

In PATTERN mode, the STROBE OUT signal is bit-programmable on the PATTERN page. The pulse-width is not programmable, only NRZ pulses are generated. Refer to Figure 3-6 for example.

TRG-MODE Screen

3

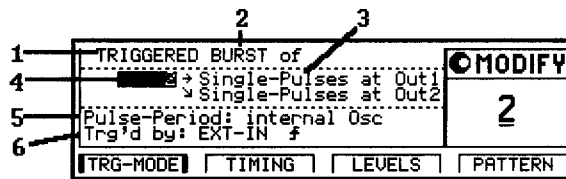

Figure 3-3. Typical TRG-MODE screen

Use the TRG-MODE page to set up the overall operating modes of the HP 8110A. Table 3-1 summarizes the main settings available on this screen.

Table 3-1. TRG-MODE Summary of modes

1 Trigger Mode	CONTINUOUS			TRIGGERED			GATED			EXT WIDTH
2 Pulse Mode	PULSES	BURST	PATTERN	PULSES	BURST	PATTERN	PULSES	BURST	PATTERN	
3 Pulse Type	Single/Double		RZ/NRZ	Single/Double		RZ/NRZ	Single/Double		RZ/NRZ	
4 Length		2-65536	2-4096 ¹		2-65536	2-4096 ¹		2-65536	2-4096 ¹	
5 Period Source	int Osc int PLL CLK-IN			int Osc int PLL ² CLK-IN			int Osc int PLL CLK-IN			
6 Arming Source				MAN Key EXT INPUT	MAN Key EXT INPUT PLL ²		MAN Key EXT INPUT			MAN Key EXT INPUT
TRIGGER OUT	Marks each pulse-period generated									
STROBE OUT	NOT USED	↑ on 1st ↓ on last	Program- -mable	NOT USED	↑ on 1st ↓ on last	Program- -mable	NOT USED	↑ on 1st ↓ on last	Program- -mable	NOT USED

1 Set Last on PATTERN screen

2 PLL cannot be used as Pulse and Arming source at the same time

To change a setting, move the parameter cursor onto the setting using the CURSOR keys and modify the setting with the MODIFY knob.

The following sections explain the mode combinations in more detail.

CONTINUOUS PULSES Mode

3

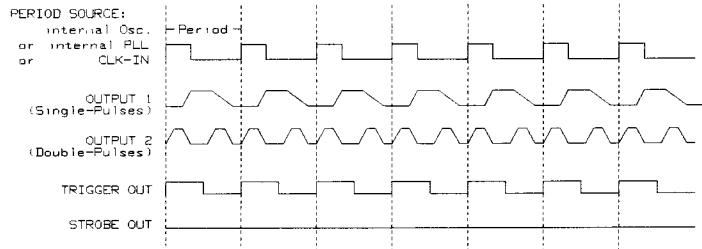

Figure 3-4. Timing Diagram: CONTINUOUS PULSES

Note



Figure 3-4 does not show the intrinsic fixed delays between the CLK IN and the TRIGGER/STROBE OUT signals, and between the TRIGGER OUT and the main OUTPUT 1/2 signals. Refer to Chapter 6 for the typical values of these delays.

- Pulse-periods are generated continuously
- Select between Single and Double-pulses per pulse-period for each OUTPUT (See **3** in Figure 3-3):
 - Single-Pulses Single pulse per period, delay parameter sets delay to leading-edge from start of period.
 - Double-Pulses Double pulse per period, double-delay parameter sets delay between leading-edges of pulses.
- If the HP 81106A PLL/External clock is fitted, select the pulse-period source (See **5** in Figure 3-3):
 - internal Osc
 - internal PLL (Higher accuracy)

TRG-MODE CONTINUOUS BURST

- ext CLK-IN (External signal), synchronize to rising or falling edge.
- TRIGGER OUT marks each pulse period.
- STROBE OUT not used.

3 CONTINUOUS BURST Mode

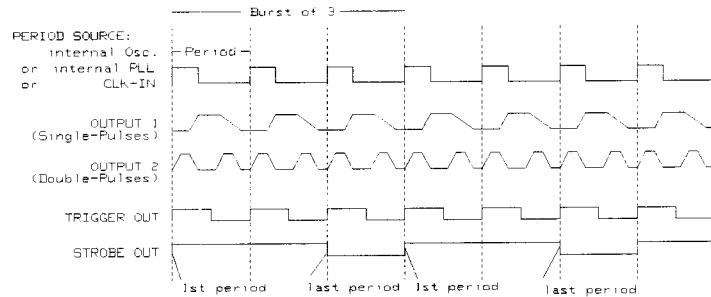

Figure 3-5. Timing Diagram: CONTINUOUS BURST

Note



Figure 3-5 does not show the intrinsic fixed delays between the CLK IN and the TRIGGER/STROBE OUT signals, and between the TRIGGER OUT and the main OUTPUT 1/2 signals. Refer to Chapter 6 for the typical values of these delays.

- A burst of pulse-periods is repeated continuously. The OUTPUT signal is the same as PULSES mode, but the STROBE OUT now marks the beginning and end of each burst.
- Select the number of pulse-periods per burst in the range 2 - 65536 (See 4 in Figure 3-3).
- Select between Single and Double-pulses per pulse-period for each OUTPUT (See 3 in Figure 3-3):
 - Single-Pulses Single pulse per period, delay parameter sets delay to leading-edge from start of period.

TRG-MODE CONTINUOUS PATTERN

Double-Pulses Double pulse per period,
double-delay parameter sets delay
between leading-edges of pulses.

- If the HP 81106A PLL/External clock is fitted, select the pulse-period source (See 5 in Figure 3-3):
 - internal Osc
 - internal PLL (Higher accuracy)
 - ext CLK-IN (External signal), synchronize to rising or falling edge.
- TRIGGER OUT marks each pulse period.
- STROBE OUT rises at the start of the first pulse-period in a burst and falls at the start of the last pulse-period.

3

CONTINUOUS PATTERN Mode

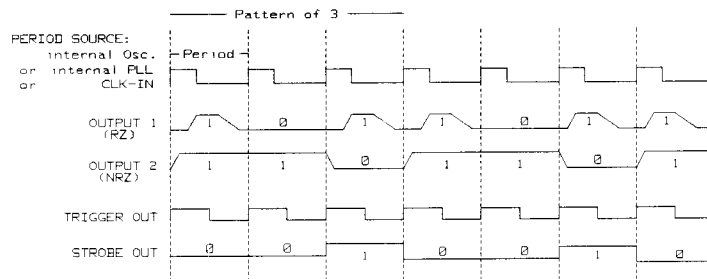

Figure 3-6. CONTINUOUS PATTERN Mode

Note



Figure 3-6 does not show the intrinsic fixed delays between the CLK IN and the TRIGGER/STROBE OUT signals, and between the TRIGGER OUT and the main OUTPUT 1/2 signals. Refer to Chapter 6 for the typical values of these delays.

- A pattern of pulses is repeated continuously.

TRG-MODE CONTINUOUS PATTERN

3

- Select between RZ and NRZ data pulses for each OUTPUT (See **3** in Figure 3-3):
 - RZ A single pulse is generated in each pulse-period with data value 1, no pulse is generated for data value 0.
 - NRZ A leading-edge is generated for a 0→1 data transition, a trailing-edge is generated for a 1→0 data transition.
- If the HP 81106A PLL/External clock is fitted, select the pulse-period source (See **5** in Figure 3-3):
 - internal Osc
 - internal PLL (Higher accuracy)
 - ext CLK-IN (External signal), synchronize to rising or falling edge.
- Select the **PATTERN** screen to set the pattern length in the range 2 - 4096.
- Select the **PATTERN** screen to program the data values for each OUTPUT.
- TRIGGER OUT marks each pulse period.
- STROBE OUT is bit-programmable, like the OUTPUTS, in NRZ format on the **PATTERN** screen.

TRIGGERED PULSES Mode

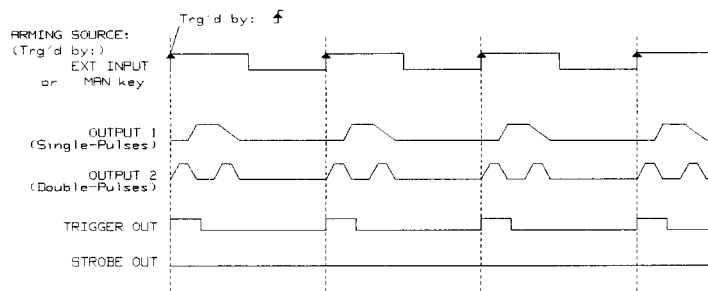

3

Figure 3-7. Timing Diagram: TRIGGERED PULSES

Note

Figure 3-7 does not show the intrinsic fixed delays between the EXT INPUT and the TRIGGER/STROBE OUT signals, and between the TRIGGER OUT and the main OUTPUT 1/2 signals. Refer to Chapter 6 for the typical values of these delays.

- Single pulse-periods are triggered by (Trig'd by) an active edge at the selected arming source (See 6 in Figure 3-3):
 - MAN Key (MAN) on frontpanel, triggered by press or release or both.
 - EXT INPUT (External signal) triggered by rising or falling or both edges (See Figure 3-8).
-

Note

The HP 81106A PLL cannot be selected as the arming source. Select CONTINUOUS PULSES mode with the PLL as Period source to achieve the same result.

TRG-MODE TRIGGERED BURST

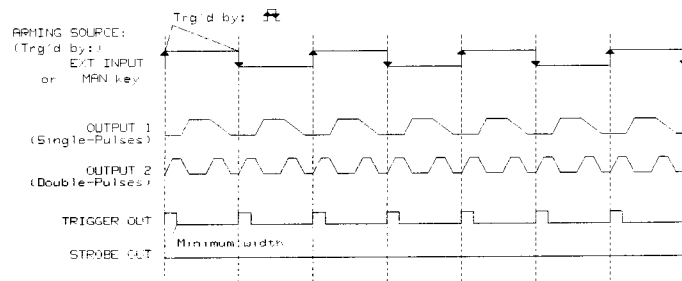
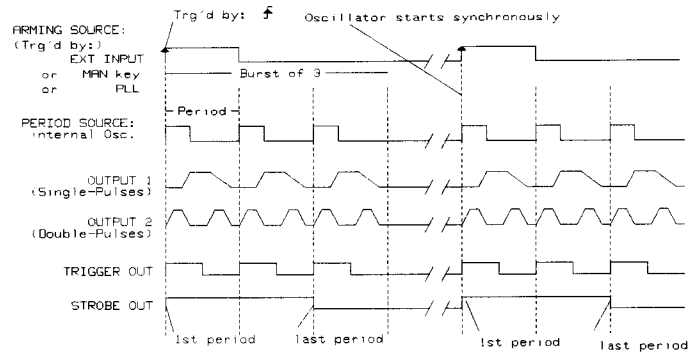

Figure 3-8.

Timing Diagram: TRIGGERED PULSES Trg'd by Both

- Select between Single and Double-pulses per pulse-period for each OUTPUT (See **3** in Figure 3-3):
 - Single-Pulses Single pulse per period, delay parameter sets delay to leading-edge from start of period.
 - Double-Pulses Double pulse per period, double-delay parameter sets delay between leading-edges of pulses.
- TRIGGER OUT marks each pulse period.
- STROBE OUT not used.

TRIGGERED BURST Mode



3

Figure 3-9.

Timing Diagram: TRIGGERED BURST Pulse-Period:
internal Osc

Note

Figure 3-9 does not show the intrinsic fixed delays between the EXT INPUT and the TRIGGER/STROBE OUT signals, and between the TRIGGER OUT and the main OUTPUT 1/2 signals. Refer to Chapter 6 for the typical values of these delays.

- A burst of pulse-periods is triggered by (Trg'd by) an active edge at the selected arming source (See 6 in Figure 3-3):
 - MAN Key (MAN) on frontpanel, triggered by press or release or both.
 - EXT INPUT (External signal) triggered by rising or falling or both edges.
 - PLL (Internally triggered bursts), select the triggering period.
- Select the number of pulse-periods per burst in the range 2 - 65536 (See 4 in Figure 3-3).
- Select between Single and Double-pulses per pulse-period for each OUTPUT (See 3 in Figure 3-3):

TRG-MODE TRIGGERED BURST

Single-Pulses Single pulse per period, delay parameter sets delay to leading-edge from start of period.

Double-Pulses Double pulse per period, double-delay parameter sets delay between leading-edges of pulses.

3

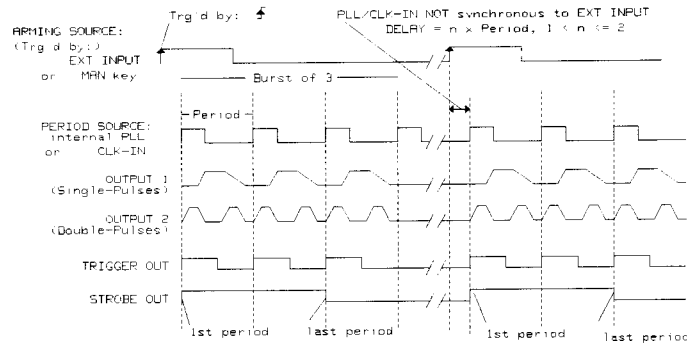

Figure 3-10.

Timing Diagram: TRIGGERED BURST Pulse-Period: internal PLL or CLK-IN

- If the HP 81106A PLL/External clock is fitted, select the pulse-period source (See 5 in Figure 3-3):
 - internal Osc (Start of burst synchronized to trigger, see Figure 3-9)
 - internal PLL (Higher accuracy, start of burst not synchronized to trigger, see Figure 3-10)
 - ext CLK-IN (External signal), pulse-period synchronized to rising or falling edge.

Note



You cannot use the PLL as both Pulse-Period source and Trg'd by (arming) source at the same time.

- TRIGGER OUT marks each pulse period.

- STROBE OUT rises at the start of the first pulse-period in a burst and falls at the start of the last pulse-period.

TRIGGERED PATTERN Mode

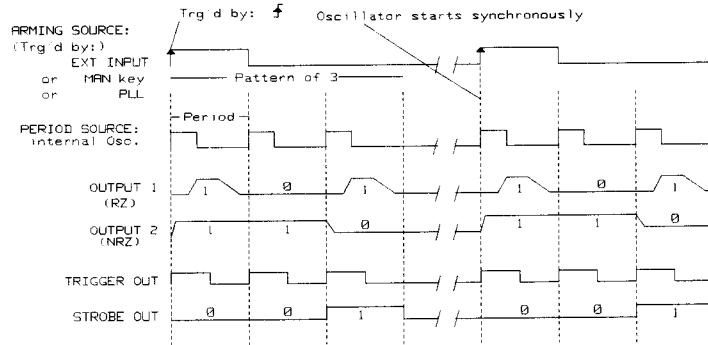

Figure 3-11.

Timing Diagram: TRIGGERED PATTERN Pulse-Period:
internal Osc

Note



Figure 3-11 does not show the intrinsic fixed delays between the EXT INPUT and the TRIGGER/STROBE OUT signals, and between the TRIGGER OUT and the main OUTPUT 1/2 signals. Refer to Chapter 6 for the typical values of these delays.

- A pattern of pulses is triggered by (Trg'd by) an active edge from the selected arming source (See 6 in Figure 3-3):
 - MAN Key **MAN** on frontpanel, triggered by press, release or both.
 - EXT INPUT (External signal) triggered by rising, falling or both edges.
 - PLL (Internally triggered patterns), select the triggering period.

3

- Select between RZ and NRZ data pulses for each OUTPUT (See 3 in Figure 3-3):
 - RZ A single pulse is generated in each pulse-period with data value 1, no pulse is generated for data value 0.
 - NRZ A leading-edge is generated for a 0→1 data transition, a trailing-edge is generated for a 1→0 data transition.

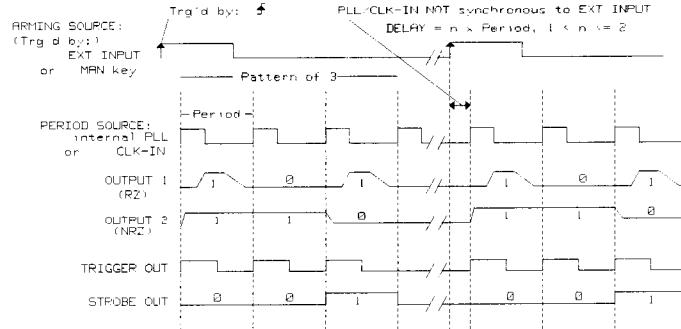

Figure 3-12.
Timing Diagram: TRIGGERED PATTERN
 Pulse-Period: internal PLL or CLK-IN

- If the HP 81106A PLL/External clock is fitted, select the pulse-period source (See 5 in Figure 3-3):
 - internal Osc (Start of pattern synchronized to trigger, see Figure 3-9)
 - internal PLL (Higher accuracy, start of pattern not synchronized to trigger, see Figure 3-10)
 - ext CLK-IN (External signal), pulse-period synchronized to rising or falling edge.

Note



You cannot use the PLL as both Pulse-Period source and Trg'd by (arming) source at the same time.

- Select the **PATTERN** screen to set the pattern length in the range 2 - 4096.
- Select the **PATTERN** screen to program the data values for each OUTPUT.
- TRIGGER OUT marks each pulse period.
- STROBE OUT is bit-programmable, like the OUTPUTS, in NRZ format on the **PATTERN** screen.

3

GATED PULSES Mode

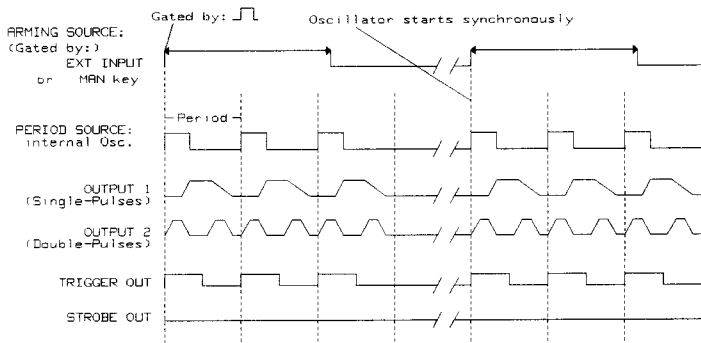

Figure 3-13.
Timing Diagram: GATED PULSES Pulse-Period:
 internal Osc

Note



Figure 3-13 does not show the intrinsic fixed delays between the EXT INPUT and the TRIGGER/STROBE OUT signals, and between the TRIGGER OUT and the main OUTPUT 1/2 signals. Refer to Chapter 6 for the typical values of these delays.

- Pulse-periods are Gated by (enabled by) an active level at the selected arming source (See 6 in Figure 3-3):
 - MAN Key (MAN) on frontpanel, gated while pressed or released or both.
 - EXT INPUT (External signal) gated by high, low or both levels.

- Select between Single and Double-pulses per pulse-period for each OUTPUT (See **3** in Figure 3-3):
 - Single-Pulses Single pulse per period, delay parameter sets delay to leading-edge from start of period.
 - Double-Pulses Double pulse per period, double-delay parameter sets delay between leading-edges of pulses.

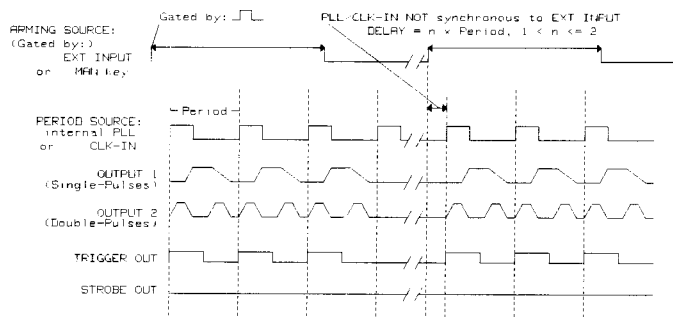

Figure 3-14.
Timing Diagram: GATED PULSES Pulse-Period:
 PLL or CLK-IN

- If the HP 81106A PLL/External clock is fitted, select the pulse-period source (See **5** in Figure 3-3):
 - internal Osc (Start of pulse synchronized to trigger, see Figure 3-13)
 - internal PLL (Higher accuracy, start of pulse not synchronized to trigger, see Figure 3-14)
 - ext CLK-IN (External signal), pulse-period synchronized to rising or falling edge.
- TRIGGER OUT marks each pulse period.
- STROBE OUT not used.

GATED BURST Mode

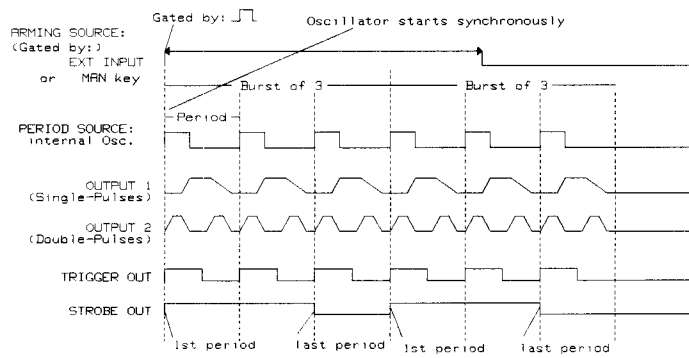

Figure 3-15.

Timing Diagram: GATED BURST Pulse-Period:
internal Osc

Note



Figure 3-15 does not show the intrinsic fixed delays between the EXT INPUT and the TRIGGER/STROBE OUT signals, and between the TRIGGER OUT and the main OUTPUT 1/2 signals. Refer to Chapter 6 for the typical values of these delays.

- Bursts of pulse-periods are Gated by (enabled by) an active level at the selected arming source (See 6 in Figure 3-3):
 - MAN Key (MAN) on frontpanel, gated while pressed or released or both.
 - EXT INPUT (External signal) gated while high or low or both.
- Select the number of pulse-periods per burst in the range 2 - 65536 (See 4 in Figure 3-3).
- Select between Single and Double-pulses per pulse-period for each OUTPUT (See 3 in Figure 3-3):

Single-Pulses	Single pulse per period, delay parameter sets delay to leading-edge from start of period.
---------------	---

TRG-MODE GATED PATTERN

Double-Pulses Double pulse per period,
double-delay parameter sets delay
between leading-edges of pulses.

3

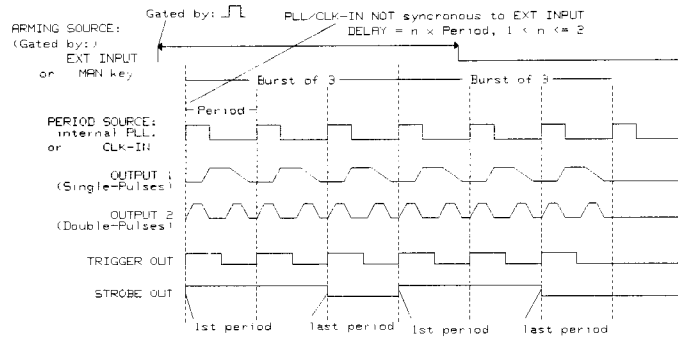

Figure 3-16.

Timing Diagram: GATED BURST Pulse-Period:
internal PLL or CLK-IN

- If the HP 81106A PLL/External clock is fitted, select the pulse-period source (See 5 in Figure 3-3):
 - internal Osc (Start of burst synchronized to trigger, see Figure 3-9)
 - internal PLL (Higher accuracy, start of burst not synchronized to trigger, see Figure 3-10)
 - ext CLK-IN (External signal), pulse-period synchronized to rising or falling edge.
- TRIGGER OUT marks each pulse period.
- STROBE OUT rises at the start of the first pulse-period in a burst and falls at the start of the last pulse-period.

GATED PATTERN **Mode**

- A pattern of pulses is Gated by (enabled by) an active level at the selected arming source (See **6** in Figure 3-3):
 - MAN Key (MAN) on frontpanel, gated while pressed, released or both.
 - EXT INPUT (External signal) gated while high or low or both.
- Select between RZ and NRZ data pulses for each OUTPUT (See **3** in Figure 3-3):
 - RZ A single pulse is generated in each pulse-period with data value 1, no pulse is generated for data value 0.
 - NRZ A leading-edge is generated for a 0→1 data transition, a trailing-edge is generated for a 1→0 data transition.
- If the HP 81106A PLL/External clock is fitted, select the pulse-period source (See **5** in Figure 3-3):
 - internal Osc (Start of pattern synchronized to gate, see Figure 3-9)
 - internal PLL (Higher accuracy, start of pattern not synchronized to gate, see Figure 3-10)
 - ext CLK-IN (External signal), pulse-period synchronized to rising or falling edge.
- Select the PATTERN screen to set the pattern length in the range 2 - 4096.
- Select the PATTERN screen to program the data values for each OUTPUT.
- TRIGGER OUT marks each pulse period.
- STROBE OUT is bit-programmable, like the OUTPUTS, in NRZ format on the PATTERN screen.

TIMING

EXT WIDTH **Mode**

- The pulse-width is determined by an external signal:
 - MANKey Pressing the **(MAN)** key generates a leading-edge, releasing the **(MAN)** key generates a trailing-edge.
 - EXT-IN A rising-edge at the EXT INPUT generates a leading-edge, a falling-edge at the EXT INPUT generates a trailing-edge.
- Set the threshold and impedance of the EXT INPUT on the **TRG-LEV** screen.
- The period, delay, and width of the output pulse are not programmable in this mode as they are determined by the external signal.

3

TIMING screen

The **TIMING** screen is only available if you have two channels fitted to your HP 8110A mainframe *and* you have selected Group Params by: **TIMING/LEVELS** on the **CONFIG** screen.

1 OFF	Per 1.00 μ s	OFF 2	MODIFY
Delay 0.00 ns	Delay 0.00 ns	Width 100 ns	1.00
Width 100 ns	Width 100 ns	LeadEdg 2.00 ns	μ s
LeadEdg 2.00 ns	LeadEdg 2.00 ns	TrailE =LeadE	
TrailE =LeadE	TrailE =LeadE		
TRG-MODE	TIMING	LEVELS	PATTERN

Figure 3-17. **TIMING** screen, text mode

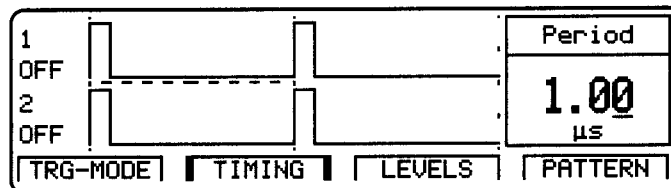

Figure 3-18. **TIMING** screen, graphics mode

Use the **TIMING** screen to view and control the pulse-timing parameters for both channels on one screen. If you have a single channel instrument both the timing and level parameters are on the **OUTPUT** screen.

You can toggle between graphics and text mode by pressing the **TIMING** softkey or **SHIFT MORE**.

Note that in graphics mode you can only adjust the values of each parameter, not the parameter format. If you want to change the format of a parameter, for example Width to DutyCycle, you must be in text mode to select the parameter name with the cursor.

Modifying the value of a parameter

You can adjust a parameter value in graphics or text mode. Example screens are shown in the following subsections for graphics mode only.

1. Move the parameter cursor onto the value you want to modify using the CURSOR keys.
2. Modify the value with the knob.

Note that when you use the knob, the parameter range can be restricted to prevent any warnings or errors occurring (See “Warnings and Errors”). If you want to set a value outside this temporary range, use the DATA ENTRY keys or press **SHIFT** and turn the knob. If you try to set a value outside the absolute maximum or minimum limits, the maximum or minimum limit will be set.

Modifying the format of a parameter

Note



You can only modify the format of a parameter in text mode.

Many parameters can be displayed in different formats, for example the pulse-period can be displayed as a period or a frequency. To modify the format of a parameter:

1. If you are in GRAPHics mode, select TEXT mode with **SHIFT MORE**.
2. Move the cursor onto the parameter name.
3. Use the MODIFY knob to select a parameter format from the list in the MODIFY window.

ON/OFF Parameter

Switch the OUTPUT signal on and off.

Note that you can use the short-cut keys **SHIFT O** or **SHIFT .** to quickly toggle the OUTPUTS on and off.

Pulse-period Parameter

Set the pulse-period as either `Period` or `Frequency`.

You can select the pulse-period source on the `TRG-MODE` screen.

If you select the HP 81106A CLK IN connector as the pulse-period source, the pulse-period/frequency is determined from the signal applied to CLK IN:

- Meas Once The external signal is measured once.
Press `ENTER` to measure again.
- Meas Cont The external signal is continuously measured.

3

Output Delay Parameter

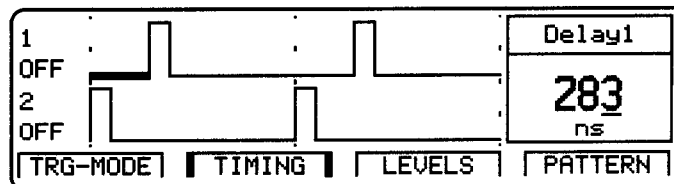

Figure 3-19.

TIMING/OUTPUT Timing parameter graphics, Delay

Delay the leading-edge of the pulse within the pulse-period. There are three delay formats available, selectable in text mode:

Delay

Delay is the absolute delay from the start of a pulse-period to the start of the leading-edge of the pulse. The absolute delay is independent of the pulse-period so the leading-edge does not move relative to the start of the period if you change the period.

TIMING

Delay%

Delay% is the delay from the start of the pulse-period to the start of the leading-edge expressed as a percentage of the pulse-period. In this format if you change the period, the leading-edge moves relative to the start of the period in order to maintain the percentage delay.

Phase

Phase is the phase delay in degrees from the start of the pulse-period to the start of the leading-edge. ($360^\circ = 1$ pulse-period). In this format if you change the period, the leading-edge moves relative to the start of the period in order to maintain the phase delay.

Pulse Width Parameter

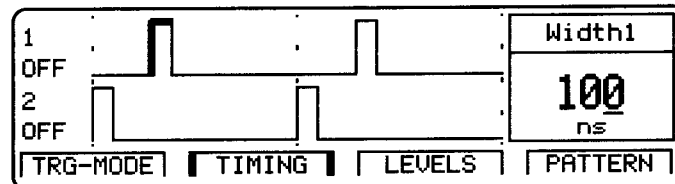

Figure 3-20.

TIMING / OUTPUT Timing parameter graphics, Width

Set the width of the output pulse. There are three width formats available, selectable in text mode:

Width

Width is the absolute pulse-width measured from start of the leading-edge to start of the trailing edge. In this format the pulse-width is independent of changes in pulse-period and delay.

DutyCyc

DutyCycle is the pulse-width measured from start of the leading-edge to start of the trailing edge expressed as a

percentage of the period. In this format if you adjust the period, the absolute width is adjusted to maintain the dutycycle.

Note that you cannot have the width format set to DutyCyc and the leading/trailing-edge format set to percentage of width (LeadEd%/TrailE%) at the same time.

TrailDel

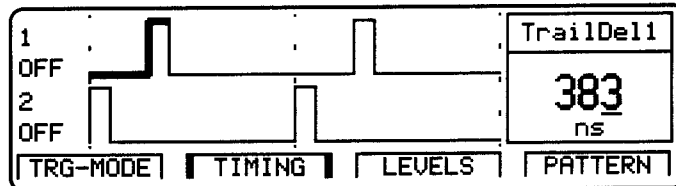

Figure 3-21.

TIMING / OUTPUT Timing parameter graphics, Trailing Delay

TrailingDelay is the absolute delay from the start of the pulse-period to the start of the trailing-edge. In this format the trailing-edge remains fixed relative to the start of the pulse-period if you adjust the pulse-delay (leading-edge delay) or the pulse-period.

Pulse Leading-edge Parameter

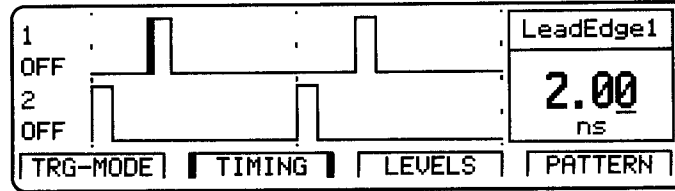

Figure 3-22.

TIMING / OUTPUT Timing parameter graphics,
Leading-edge

Set the leading-edge transition-time of the pulse, measured from 10% to 90% of pulse amplitude. Note that the leading and trailing-edges are independently programmable within certain ranges only, see Figure 6-1. There are two formats available, selectable in text mode:

LeadEdge

The absolute transition-time measured from 10% to 90% of pulse amplitude. In this format the leading-edge is independent of the pulse-width.

LeadEd%

The leading-edge transition-time expressed as a percentage of pulse-width. In this format if you adjust the pulse-width, the transition-time is adjusted to maintain the edge-time as a percentage of the width.

Note that you cannot have the width format set to DutyCyc and the leading/trailing-edge format set to percentage of width (LeadEd%/Traile%) at the same time.

Pulse Trailing-edge Parameter

Set the trailing-edge transition-time of the pulse, measured from 10% to 90% of pulse amplitude. Note that the leading and trailing-edges are independently programmable within certain ranges only, see Figure 6-1. There are three formats available, selectable in text mode:

3

=LeadE

The trailing-edge transition-time is coupled directly to the leading edge to maintain a symmetrical pulse.

TrailEd

The absolute transition-time measured from 10% to 90% of pulse amplitude. In this format the trailing-edge is independent of the pulse-width.

TrailE%

The trailing-edge transition-time expressed as a percentage of pulse-width. In this format if you adjust the pulse-width, the transition-time is adjusted to maintain the edge-time as a percentage of the width.

Note that you cannot have the width format set to DutyCyc and the leading/trailing-edge format set to percentage of width (LeadEd%/TrailE%) at the same time.

LEVELS screen

The LEVELS screen is only available if you have two channels fitted to your HP 8110A mainframe *and* you have selected Group Params by: TIMING/LEVELS on the CONFIG screen.

3

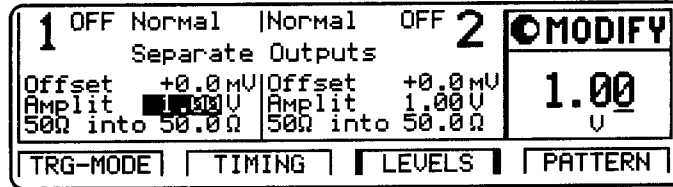

Figure 3-23. LEVELS screen, text mode

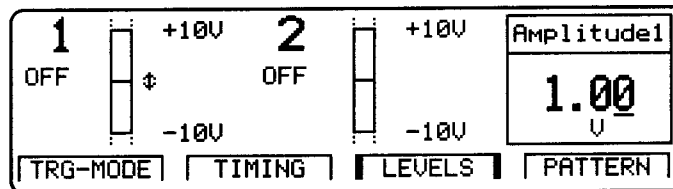

Figure 3-24. LEVELS screen, graphics mode

Use the LEVELS screen to view and control the pulse-level parameters for both channels on one screen. If you have a single channel instrument both the timing and level parameters are on the OUTPUT screen.

You can toggle between graphics and text mode by pressing the LEVELS softkey or (SHIFT) (MORE).

Note that in graphics mode you can only adjust the values of each parameter, not the parameter format. If you want to change the format of a parameter, for example Offset/Amplit to High/Low, you must be in text mode to select the parameter name with the cursor.

Modifying the value of a parameter

You can adjust a parameter value in graphics or text mode. Example screens are shown in the following subsections for graphics mode only.

1. Move the parameter cursor onto the value you want to modify using the CURSOR keys.
2. Modify the value with the knob.

Note that when you use the knob, the parameter range can be restricted to prevent any warnings or errors occurring (See “Warnings and Errors”). If you want to set a value outside this temporary range, use the DATA ENTRY keys or press **SHIFT** and turn the knob. If you try to set a value outside the absolute maximum or minimum limits, the maximum or minimum limit will be set.

3

Modifying the format of a parameter

Note



You can only modify the format of a parameter in text mode.

Many parameters can be displayed in different formats, for example the pulse-period can be displayed as a period or a frequency. To modify the format of a parameter:

1. If you are in GRAPHics mode, select TEXT mode with **SHIFT MORE**.
2. Move the cursor onto the parameter name.
3. Use the MODIFY knob to select a parameter format from the list in the MODIFY window.

ON/OFF Parameter

Switch the OUTPUT signal on and off.

Note that you can use the short-cut keys **SHIFT 0** or **SHIFT .** to quickly toggle the OUTPUTS on and off.

LEVELS

Normal/Complmnt Parameter

Note



This parameter is only available in text mode.

3

Switch the OUTPUT between Normal and Complement modes.

Normal Pulse leading-edge rises from low to high-level, trailing-edge falls from high to low-level.

Complmnt Pulse leading-edge falls from high to low-level, trailing-edge rises from low to high-level.

Seperate/Added Outputs Parameter

Note



This parameter is only available in text mode, and if you have two output channels fitted.

Switch Added output mode on and off.

Seperate Outputs

OUTPUT 1 and OUTPUT 2 operate as entirely seperate output channels.

Added at Output 1

OUTPUT 1 and OUTPUT 2 signals are added together at the OUTPUT 1 connector. The OUTPUT 2 connector is no longer used. You can use this mode to create complex pulse waveforms as shown in Figure 3-25.

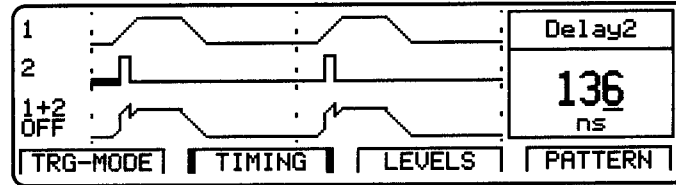

3

Figure 3-25. TIMING screen, Added Outputs

Note that by using PATTERN mode you can code 3 or 4-level codes, or place spike pulses from OUTPUT CH2 on particular data pulses on OUTPUT CH1 for example. Since OUTPUT 2 is no longer used, its Impedance parameters are no longer available (See Figure 3-26).

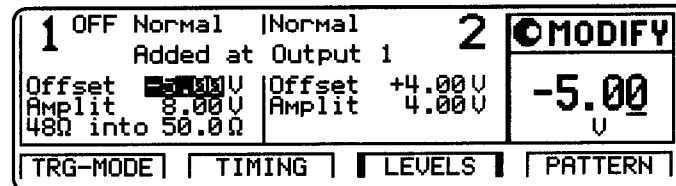

Figure 3-26.

LEVELS screen, Added Outputs text mode

LEVELS

The **LEVELS** graphic page is also modified to indicate the multiple levels formed by OUTPUT 1 + 2:

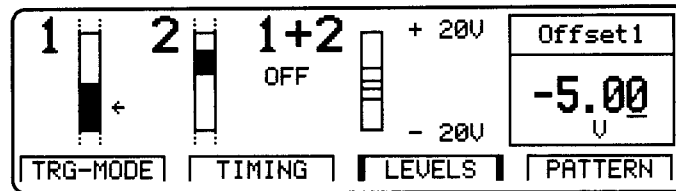

Figure 3-27.

LEVELS screen, Added Outputs graphics mode

Offset, Amplit, High, Low Level Parameters

Set and display the pulse levels in terms of either Offset and Amplitude, or High- and Low-level. You can quickly set TTL or ECL output levels using the Set TTL and Set ECL formats.

Set TTL

Select High and Low-level format and automatically set the levels to the default TTL levels:

```
TTL-HI  +2.50 V
TTL-LOW +0.0 mV
```

The default levels are set once and can be adjusted afterwards by moving the cursor onto the values as normal.

High-Low

Select High and Low-level format for the pulse levels.

Offs-Ampl

Select Offset and Amplitude format for the pulse levels. Offset is measured from 0 V to the middle of the pulse-amplitude. Pulse-amplitude is the difference between the High- and Low-levels of the pulse.

Set ECL

Select High and Low-level format and automatically set the levels to the default ECL levels:

```
ECL-HI  -850 mV
ECL-LOW -1.80 V
```

These default levels are set once and can be adjusted afterwards by moving the cursor onto the value as normal.

3

mV V mA A Voltage/Current Mode

Note



This parameter is only available in text mode.

Move the parameter cursor onto the level Units to select between setting the pulse-levels in Volts or in Amperes.

50Ω into OUTPUT Source Impedance Parameter

Note



This parameter is only available in text mode.

Toggle the OUTPUT impedance between 50Ω and 1kΩ. If you are using Added at Output 1 mode to add OUTPUTS 1 + 2 at OUTPUT 1, the available OUTPUT impedances at OUTPUT 1 are 48Ω and 500Ω.

50.0Ω Load Impedance Parameter

Adjust the load impedance value expected at the OUTPUT to compensate for non-50Ω loads. The displayed level-parameters are then calculated using this value and therefore represent the levels at a non-50Ω static load.

Output Voltage and Power Protection

Note



When an OUTPUT is switched on, the HP 8110A monitors the actual voltage and current levels at the OUTPUT. The OUTPUT is automatically switched off if voltage levels or power dissipation reach levels which could damage the OUTPUT circuits.

The available output levels for an OUTPUT could therefore be limited by external voltages, loads and the level settings of the *other* OUTPUT if you are using a dual channel instrument with Outputs added at OUTPUT 1. Refer to Specifications chapter 6, Outputs Table 6-1 and Fig. 6-2.

3

OUTPUT screens

The **OUTPUT** screen is available if you have only one channel fitted to your HP 8110A mainframe. **OUTPUT 1** and **OUTPUT 2** screens are available on a two channel instrument if you have selected Group Params by: **OUTPUT 1/2** on the **CONFIG** screen. The **OUTPUT** screen on a single channel instrument is identical to the **OUTPUT 1** screen shown in this section.

3

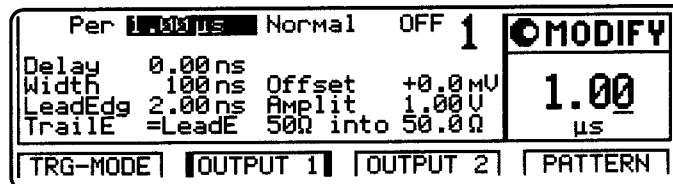

Figure 3-28. **OUTPUT 1/OUTPUT** screen, text mode

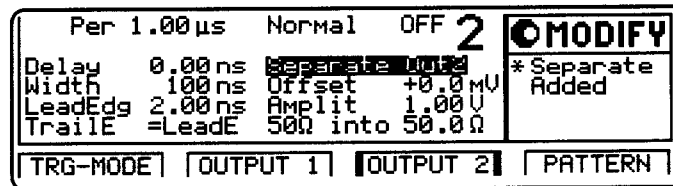

Figure 3-29. **OUTPUT 2** screen, text mode

Use an **OUTPUT** screen to view and control all the pulse parameters for one channel on one screen. If you have a single channel instrument both the timing and level parameters are on the **OUTPUT** screen.

You can toggle between graphics and text mode by pressing the **LEVELS** softkey or **(SHIFT) (MORE)**. You move to the timing graphics if you are currently on a timing parameter, or to the level graphics if you are currently on a level parameter.

Note that in graphics mode you can only adjust the values of each parameter, not the parameter format. If you want to change the format of a parameter, for example Offset/Amplit to High/Low, you must be in text mode to select the parameter name with the cursor.

3 Modifying the value of a parameter

You can adjust a parameter value in graphics or text mode. Example screens are shown in the following subsections for graphics mode only.

1. Move the parameter cursor onto the value you want to modify using the CURSOR keys.
2. Modify the value with the knob.

Note that when you use the knob, the parameter range can be restricted to prevent any warnings or errors occurring (See “Warnings and Errors”). If you want to set a value outside this temporary range, use the DATA ENTRY keys or press **SHIFT** and turn the knob. If you try to set a value outside the absolute maximum or minimum limits, the maximum or minimum limit will be set.

Modifying the format of a parameter

Note



You can only modify the format of a parameter in text mode.

Many parameters can be displayed in different formats, for example the pulse-period can be displayed as a period or a frequency. To modify the format of a parameter:

1. If you are in GRAPHics mode, select TEXT mode with **SHIFT MORE**.
2. Move the cursor onto the parameter name.
3. Use the MODIFY knob to select a parameter format from the list in the MODIFY window.

Pulse-period Parameter

Set the pulse-period as either Period or Frequency.

You can select the pulse-period source on the TRG-MODE screen.

If you select the HP 81106A CLK IN connector as the pulse-period source, the pulse-period/frequency is determined from the signal applied to CLK IN:

Meas Once The external signal is measured once.
Press **(ENTER)** to measure again.

Meas Cont The external signal is continuously measured.

3

Normal/Complmnt Parameter

Note



This parameter is only available in text mode.

Switch the OUTPUT between Normal and Complement modes.

Normal Pulse leading-edge rises from low to high-level, trailing-edge falls from high to low-level.

Complmnt Pulse leading-edge falls from high to low-level, trailing-edge rises from low to high-level.

ON/OFF Parameter

Switch the OUTPUT signal on and off.

Note that you can use the short-cut keys **(SHIFT)O** or **(SHIFT).)** to quickly toggle the OUTPUTS on and off.

Output Delay Parameter

3

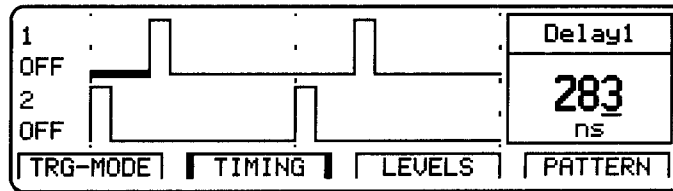

Figure 3-30.

TIMING / OUTPUT Timing parameter graphics, Delay

Delay the leading-edge of the pulse within the pulse-period. There are three delay formats available, selectable in text mode:

Delay

Delay is the absolute delay from the start of a pulse-period to the start of the leading-edge of the pulse. The absolute delay is independent of the pulse-period so the leading-edge does not move relative to the start of the period if you change the period.

Delay%

Delay% is the delay from the start of the pulse-period to the start of the leading-edge expressed as a percentage of the pulse-period. In this format if you change the period, the leading-edge moves relative to the start of the period in order to maintain the percentage delay.

Phase

Phase is the phase delay in degrees from the start of the pulse-period to the start of the leading-edge. ($360^\circ = 1$ pulse-period). In this format if you change the period, the leading-edge moves relative to the start of the period in order to maintain the phase delay.

Pulse Width Parameter

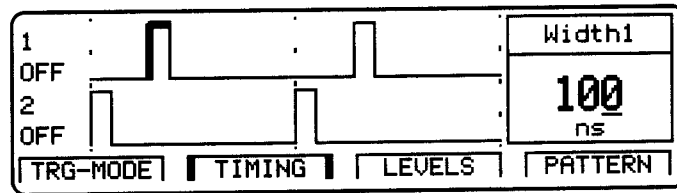

3

Figure 3-31.

TIMING / OUTPUT Timing parameter graphics, Width

Set the width of the output pulse. There are three width formats available, selectable in text mode:

Width

Width is the absolute pulse-width measured from start of the leading-edge to start of the trailing edge. In this format the pulse-width is independent of changes in pulse-period and delay.

DutyCyc

DutyCycle is the pulse-width measured from start of the leading-edge to start of the trailing edge expressed as a percentage of the period. In this format if you adjust the period, the absolute width is adjusted to maintain the dutycycle.

Note that you cannot have the width format set to DutyCyc and the leading/trailing-edge format set to percentage of width (LeadEd%/TrailingE%) at the same time.

TraDel

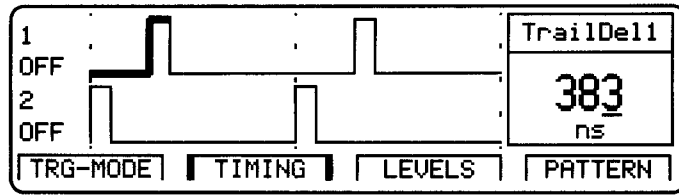

3

Figure 3-32.

TIMING/OUTPUT Timing parameter graphics, Trailing Delay

TrailingDelay is the absolute delay from the start of the pulse-period to the start of the trailing-edge. In this format the trailing-edge remains fixed relative to the start of the pulse-period if you adjust the pulse-delay (leading-edge delay) or the pulse-period.

Pulse Leading-edge Parameter

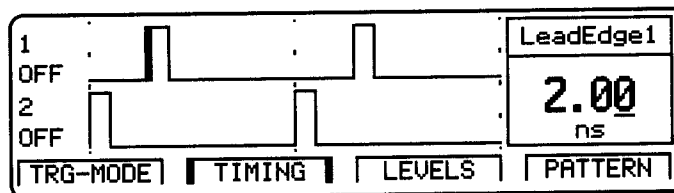

3

Figure 3-33.
TIMING / OUTPUT Timing parameter graphics,
Leading-edge

Set the leading-edge transition-time of the pulse, measured from 10% to 90% of pulse amplitude. Note that the leading and trailing-edges are independently programmable within certain ranges only, see Figure 6-1. There are two formats available, selectable in text mode:

LeadEdg

The absolute transition-time measured from 10% to 90% of pulse amplitude. In this format the leading-edge is independent of the pulse-width.

LeadEd%

The leading-edge transition-time expressed as a percentage of pulse-width. In this format if you adjust the pulse-width, the transition-time is adjusted to maintain the edge-time as a percentage of the width.

Note that you cannot have the width format set to DutyCyc and the leading/trailing-edge format set to percentage of width (LeadEd%/Traile%) at the same time.

Pulse Trailing-edge Parameter

3

Set the trailing-edge transition-time of the pulse, measured from 10% to 90% of pulse amplitude. Note that the leading and trailing-edges are independently programmable within certain ranges only, see Figure 6-1. There are three formats available, selectable in text mode:

=LeadE

The trailing-edge transition-time is coupled directly to the leading edge to maintain a symmetrical pulse.

TrailEd

The absolute transition-time measured from 10% to 90% of pulse amplitude. In this format the trailing-edge is independent of the pulse-width.

TrailE%

The trailing-edge transition-time expressed as a percentage of pulse-width. In this format if you adjust the pulse-width, the transition-time is adjusted to maintain the edge-time as a percentage of the width.

Note that you cannot have the width format set to DutyCyc and the leading/trailing-edge format set to percentage of width (LeadEd%/TrailE%) at the same time.

Seperate/Added **Outputs Parameter**

Note



This parameter is only available in text mode on the **OUTPUT 2** screen (Compare Figure 3-28 and Figure 3-29).

Switch Added output mode on and off.

Seperate Out 2

OUTPUT 1 and OUTPUT 2 operate as entirely seperate output channels.

Added to Out 1

OUTPUT 1 and OUTPUT 2 signals are added together at the OUTPUT 1 connector. The OUTPUT 2 connector is no longer used. You can use this mode to create complex pulse waveforms as shown in Figure 3-34.

3

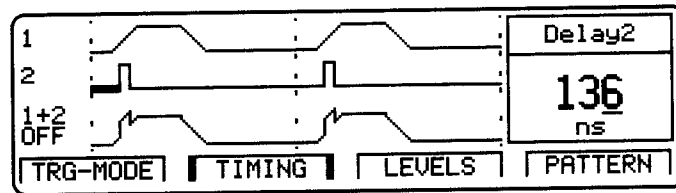

Figure 3-34.

TIMING / OUTPUT Timing parameter graphics, Added Outputs

Note that by using PATTERN mode you can code 3 or 4-level codes, or place spike pulses from OUTPUT CH2 on particular data pulses on OUTPUT CH1 for example. Since OUTPUT 2 is no longer used, its Impedance parameters are no longer available (See ***<xref OUTPUT2A>: undefined***).

3

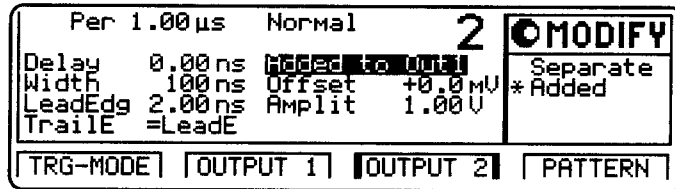

Figure 3-35.

OUTPUT 2 screen, Added Outputs text mode

The LEVELS graphic page is also modified to indicate the multiple levels formed by OUTPUT 1 + 2:

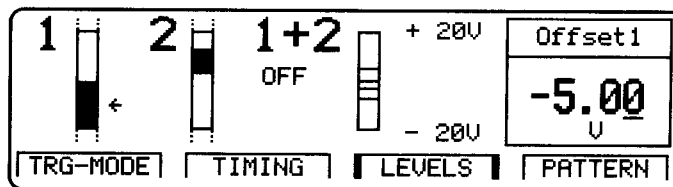

Figure 3-36.

LEVELS screen, Added Outputs graphics mode

Offset, Amplit, High, Low **Level Parameters**

Set and display the pulse levels in terms of either Offset and Amplitude, or High- and Low-level. You can quickly set TTL or ECL output levels using the Set TTL and Set ECL formats.

Set TTL

Select High and Low-level format and automatically set the levels to the default TTL levels:

```
TTL-HI  +2.50 V
TTL-LOW +0.0 mV
```

The default levels are set once and can be adjusted afterwards by moving the cursor onto the values as normal.

High-Low

Select High and Low-level format for the pulse levels.

Offset-Ampl

Select Offset and Amplitude format for the pulse levels. Offset is measured from 0 V to the middle of the pulse-amplitude. Pulse-amplitude is the difference between the High- and Low-levels of the pulse.

Set ECL

Select High and Low-level format and automatically set the levels to the default ECL levels:

```
ECL-HI  -850 mV
ECL-LOW -1.80 V
```

These default levels are set once and can be adjusted afterwards by moving the cursor onto the value as normal.

OUTPUT OUTPUT 1 OUTPUT 2

mV V mA A **Voltage/Current Mode**

Note



This parameter is only available in text mode.

3

Move the parameter cursor onto the level Units to select between setting the pulse-levels in Volts or in Amperes.

50Ω into **OUTPUT Source Impedance Parameter**

Note



This parameter is only available in text mode.

Toggle the OUTPUT impedance between 50Ω and 1kΩ. If you are using Added at Output 1 mode to add OUTPUTS 1 + 2 at OUTPUT 1, the available OUTPUT impedances at OUTPUT 1 are 48Ω and 500Ω.

50.0Ω **Load Impedance Parameter**

Adjust the load impedance value expected at the OUTPUT to compensate for non-50Ω loads. The displayed level-parameters are then calculated using this value and therefore represent the levels at a non-50Ω static load.

Output Voltage and Power Protection

Note



When an OUTPUT is switched on, the HP 8110A monitors the actual voltage and current levels at the OUTPUT. The OUTPUT is automatically switched off if voltage levels or power dissipation reach levels which could damage the OUTPUT circuits.

The available output levels for an OUTPUT could therefore be limited by external voltages, loads and the level settings of the *other* OUTPUT if you are using a dual channel instrument with Outputs added at OUTPUT 1. Refer to Specifications chapter 6, Outputs Table 6-1 and Fig. 6-2.

3 

PATTERN screen

3

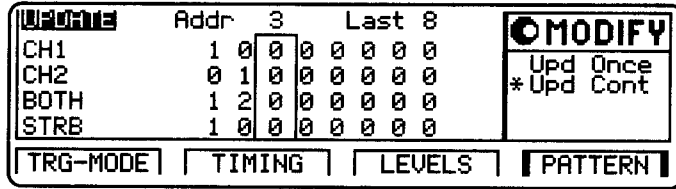

Figure 3-37. PATTERN screen, text mode

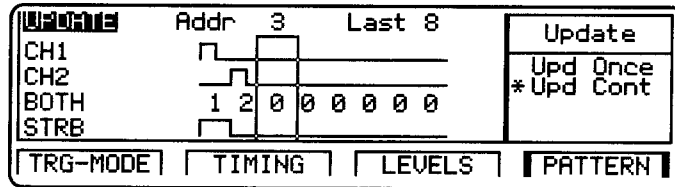

Figure 3-38. PATTERN screen, graphics mode

Use the PATTERN screen to edit the pattern data which is generated when you select a PATTERN mode on the TRG-MODE screen.

You can toggle between graphics and text mode by pressing the PATTERN softkey or **SHIFT MORE**.

Note that in graphics mode you can see if RZ or NRZ data is selected. In Figure 3-38 the output channels have RZ data selected while the STROBE output shows NRZ data as always. The Normal/Complement state of the outputs is *not* shown on the PATTERN screen.

UPDATE Parameter

UPDATE (Upd Cont)

The pattern data at the outputs are updated continuously as you edit the data on the screen.

NO UPD (Upd Once)

The pattern data at the outputs are not updated automatically from the screen. You can therefore modify the data patterns on the screen without affecting the pattern which is currently being generated at the Outputs.

Press **ENTER** to update the pattern once.

3

Addr Parameter

Adjust the address of the bit-editing window to scroll through the data. Figure 3-37 shows the bit-editing window located at the third bit in the pattern.

Last Parameter

Adjust the last bit number to set the length of the pattern in the range 2 to 4096.

Bit-Editing Window

Move the parameter cursor into the bit-editing window to edit individual data bits.

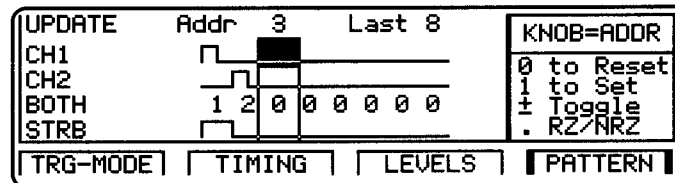

Figure 3-39. PATTERN screen, Bit-editing window

While the parameter cursor is in the bit-edit window you can use the knob to scroll through the data.

OUTPUTS (CH1 CH2)

Use the DATA ENTRY keys to edit the data bit at the cursor:

- ⓪ Set bit to 0, and move the bit-editing window to the next bit.
- ① Set bit to 1, and move the bit-editing window to the next bit.
- +/- Toggle bit without moving the bit-editing window.
- ⓪ Toggle the data format between RZ and NRZ. Note that the change is only visible in graphics mode.

You can edit both output channels together in the BOTH pattern. This makes it easy to enter data for 3 or 4-level codes.

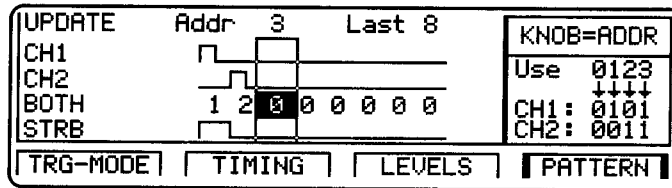

Figure 3-40.
PATTERN screen, Bit-editing window BOTH

BOTH	DATA ENTRY	CH2	CH1
0	⓪	0	0
1	①	0	1
2	②	1	0
3	③	1	1

STROBE OUT (STRB)

Use the DATA ENTRY keys to edit the data bit at the cursor:

- 0 Set bit to 0, and move the bit-editing window to the next bit.
- 1 Set bit to 1, and move the bit-editing window to the next bit.
- +/- Toggle bit without moving the bit-editing window.

3

CH1 CH2 BOTH STRB **Block Editing Functions**

Move the parameter cursor onto the pattern names at the left hand side of the screen to use the block editing functions.

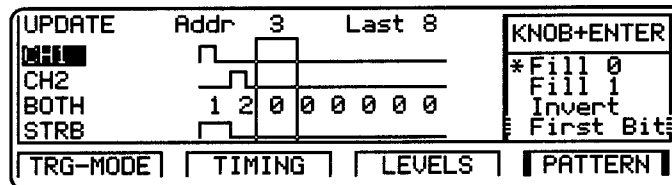

Figure 3-41. PATTERN screen, Block editing functions

Select the function using the MODIFY knob. Press **ENTER** to carry out the edit.

Note



Most of the block editing functions apply from (or at) the current Addr of the bit-editing window to the Last bit in the pattern.

The data memory is 4096 bits long. Bits beyond the Last bit are not affected by the editing functions except when you insert or delete bits.

PATTERN

3

Fill 0

Set all bits from Addr to Last inclusive to 0.

Fill 1

Set all bits from Addr to Last inclusive to 1.

Invert

Invert all bits from Addr to Last inclusive.

First Bit

Set the first bit to 1, and bits 2 to Last to 0.

Last Bit

Set the last bit to 1, and all preceding bits to 0.

Ins Bit

Insert a bit at Addr. The bit value is copied from the current bit at Addr, and bits Addr to 4095 are shifted right. Bit 4096 is lost.

Note



The Last parameter is *not* automatically incremented, so the length of the generated pattern is not increased unless you adjust the Last parameter yourself.

Del Bit

Delete the bit at Addr. Bits (Addr + 1) to 4096 are shifted left and bit 4096 is copied.

Note



The Last parameter is *not* automatically decremented, so the length of the generated pattern is not decreased unless you adjust the Last parameter yourself.

Clock ÷ N

Fill bits Addr to Last with a divided clock pattern. After pressing **(ENTER)** you can adjust the dividing factor (≥ 2) and press **(ENTER)** again to implement.

Note that the output signal is only a squarewave if you are using NRZ data. You can see this best in graphics mode:

3

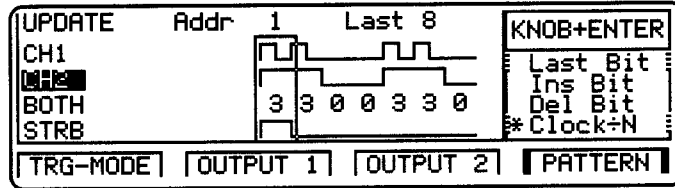

Figure 3-42. PATTERN Clock ÷ 4, CH1 = RZ, CH2 = NRZ

PRBS $2^n - 1$

Fill bits Addr to Last with a $2^n - 1$ Pseudo-random Binary Sequence. After pressing **(ENTER)** you can adjust n in the range 7 to 12 and press **(ENTER)** again to implement.

Some Hints on Editing Pattern Data

The block editing functions, apart from Insert and Delete, do not affect data bits beyond the current Last bit. Therefore you can use the Addr and Last parameters to define the block of bits you want to edit.

Remember, however, that the Last parameter also defines the length of the pattern generated at the outputs.

Example

You are currently generating a 48 bit pattern on OUTPUT 1 and now want to fill bits 10 to 20 with data value 1. On the PATTERN screen:

1. If necessary, move the cursor to UPDATE and select Upd Once to prevent the data edits from affecting the pattern currently being generated at the OUTPUT.

If NO UPD is already shown, or it isn't important if the pattern is disturbed during the editing you can ignore this step.

2. Adjust Addr to 10.

3. Adjust Last to 20

If UPDATE is still active, the pattern at the OUTPUT will now be automatically reduced to 20 bits in length.

4. Move the cursor to CH1 to access the block editing functions for OUTPUT 1.

5. Use the MODIFY knob to select Fill 1 from the list of functions.

6. Press **ENTER** to fill bits 10 to 20 with data value 1.

If UPDATE is still active, the pattern at the OUTPUT will now change automatically.

7. Adjust Last back to 48 to return the pattern length to 48.

If UPDATE is still active, the pattern at the OUTPUT will now return to 48 bits in length.

8. If necessary, move the cursor to NO UPD and press **ENTER** to update the pattern being generated at the OUTPUT (or select Upd Cont)

LIMITS screen

1	LIMITS OFF	Limits OFF	2	MODIFY
High-V	+500 mV	High-V	+500 mV	* OFF
Low-V	-500 mV	Low-V	-500 mV	ON
High-A	+10.0 mA	High-A	+10.0 mA	
Low-A	-10.0 mA	Low-A	-10.0 mA	
LIMITS		TRG-LEV		MEMCARD
				CONFIG

Figure 3-43. LIMITS screen

Use the LIMITS screen to set up voltage and current limits for the pulse level parameters to prevent accidental damage of the device under test.

After you switch on the limits, the pulse level parameters on the LEVELS/OUTPUT screens cannot be adjusted outside the ranges on the LIMITS page if the OUTPUT is switched on. Note that because current and voltage limits apply, the available ranges of the impedance parameters are also affected.

When output limits are on, the limits are indicated on the LEVELS/OUTPUT pages in graphics mode and the level bar is scaled accordingly:

1	+ 1V	2	+10V	Amplitude1
ON	↓	OFF		500
	- 1V		-10V	mV
TRG-MODE		OUTPUT 1		PATTERN

Figure 3-44.

Level graphics with Limits ON on OUTPUT 1

TRG-LEV screen

EXT-IN: Threshold	+1.0V	50Ω	<input checked="" type="radio"/> MODIFY Set TTL Set ECL *Voltage				
CLK-IN: Threshold	+1.0V	50Ω					

TRIGGER-OUT:	TTL						
STROBE-OUT:	TTL						
<table border="1"> <tr> <td>LIMITS</td> <td>TRG-LEV</td> <td>MEMCARD</td> <td>CONFIG</td> </tr> </table>				LIMITS	TRG-LEV	MEMCARD	CONFIG
LIMITS	TRG-LEV	MEMCARD	CONFIG				

Figure 3-45. TRG-LEV screen

Use the **TRG-LEV** screen to:

- Set the triggering threshold and input impedance for the EXT INPUT connector.
- Set the triggering threshold and input impedance for the HP 81106A CLK IN connector, if fitted.
- Set the output levels for the STROBE OUT and TRIGGER OUT connectors.

EXT-IN Parameter

Move the cursor onto **EXT-IN** to quickly set the triggering threshold of the EXT INPUT to a TTL or ECL compatible level.

Set TTL

Set the EXT INPUT threshold to +2.5V.

You can adjust the threshold by moving the cursor onto the value.

Set ECL

Set the EXT INPUT threshold to -1.3V.

You can adjust the threshold by moving the cursor onto the value.

Voltage

Set any threshold level in the range -10.0 V to +10.0 V. Move the cursor onto the value to adjust it.

50Ω 10kΩ EXT INPUT Impedance Parameter

Toggle the input impedance of the EXT INPUT connector between 50Ω and 10 kΩ.

CLK-IN Parameter**Note**

The CLK-IN parameters are only available if you have the HP 81106A PLL/External Clock module installed.

Move the cursor onto CLK-IN to quickly set the triggering threshold of the CLK IN to a TTL or ECL compatible level.

Set TTL

Set the CLK IN threshold to +2.5V.

You can adjust the threshold by moving the cursor onto the value.

Set ECL

Set the CLK IN threshold to -1.3V.

You can adjust the threshold by moving the cursor onto the value.

Voltage

Set any threshold level in the range -10.0 V to +10.0 V. Move the cursor onto the value to adjust it.

50Ω 10kΩ CLK IN Impedance Parameter**Note**

The CLK-IN parameters are only available if you have the HP 81106A PLL/External Clock module installed.

Toggle the input impedance of the EXT INPUT connector between 50Ω and 10 kΩ.

TRG-LEV

TRIGGER-OUT **TRIGGER OUT Level Parameter**

Set the output levels into 50Ω for the TRIGGER OUT connector.

TTL

High-level +2.50 V
Low-level 0 V

ECL

High-level -0.8 V
Low-level -1.8 V

STROBE-OUT **STROBE OUT Level Parameter**

Set the output levels into 50Ω for the STROBE OUT connector.

TTL

High-level +2.50 V
Low-level 0 V

ECL

High-level -0.8 V
Low-level -1.8 V

MEMCARD screen

Dir Path <no_path>	MODIFY
Filename <no_file>	

Perform Operation	* .
LIMITS	TRG-LEV
MEMCARD	CONFIG

Figure 3-46. MEMCARD screen, No card present.

Use the MEMCARD screen to:

- Store instrument settings to the memory-card.
- Recall instrument settings from the memory-card.
- Delete files from the memory-card.
- Format a memory card.

Note that the HP 8110A uses DOS formatted memory-cards and you cannot create or delete directories using the HP 8110A.

Dir Path **Current Directory Parameter**

Move the cursor onto Dir Path to change directory on the memory-card or to view the subdirectories in the current directory (The current directory name is displayed next to Dir Path).

All the sub-directories in the current directory are listed in the MODIFY window.

Dir Path <	MODIFY
Filename TESTUI.TXT	

Perform Operation	* 8133A SPEAK 8110A
LIMITS	TRG-LEV
MEMCARD	CONFIG

Figure 3-47. MEMCARD screen, Dir Path Example

To change directory

1. Use the MODIFY knob to select the directory name from the list of files and directories in the MODIFY window.
2. Press **ENTER**.

3



Figure 3-48.
MEMCARD screen, Subdirectory Example

Note that when you are in a sub-directory you can return to the parent-directory by selecting .. from the directory list in the MODIFY window.

Filename Parameter

Move the cursor onto the Filename parameter to view and select a file from the current directory. Use the MODIFY knob to scroll through the filenames listed in the MODIFY window.



Figure 3-49. MEMCARD screen, Filename Example

Perform Operation **Memory Card Operations**

Move the cursor onto Perform Operation and use the knob to select the operation:

ReadCard

Read the DOS file-system information from the memory-card after inserting a new card. Press **ENTER** to carry out the operation.

Recall

Recall the selected file as the current-instrument setting. Press **ENTER** to carry out the operation.

Store

Store the current instrument-setting to the memory-card.

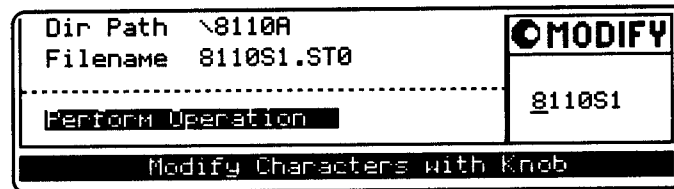

Figure 3-50. MEMCARD screen, Store Operation

Press **ENTER** once to start editing the filename for the setting in the MODIFY window. The currently selected filename is used as default.

Caution



If you do not modify the filename, the existing file will be overwritten when you press **ENTER**.

Press **SHIFT** **ENTER** to CANCEL the store operation at any time..

To modify the filename

1. Move the character cursor with the CURSOR keys.

The filename can be up to 8 characters long.

2. Modify a character using the knob.
3. When you have finished, press **ENTER** to store the setting.

Note that the DOS filename suffix `.ST0` is added automatically to the filename when you store the current settings.

Store All

Store the current instrument-setting and the instrument-setting memories 1 to 9 to the memory-card. Each setting is stored in a separate file with the same name but different suffixes:

Table 3-2. Filename suffixes

Setting	Filename Suffix
Current Setting	<code>.ST0</code>
Memory 1	<code>.ST1</code>
Memory 2	<code>.ST2</code>
.	.
.	.
Memory 9	<code>.ST9</code>

Press **ENTER** once to start editing the filename for the setting in the MODIFY window. The currently selected filename is used as default.

Caution

If you do not modify the filename, the existing file will be overwritten when you press **ENTER**.

Press **SHIFT** **ENTER** to CANCEL the store operation at any time..

To modify the filename

1. Move the character cursor with the CURSOR keys.

The filename can be up to 8 characters long.

2. Modify a character using the knob.
3. When you have finished, press **ENTER** to store the setting.

Note that the DOS filename suffixes `STx` are added automatically to the filenames when you store the settings.

Delete

Delete the selected file from the memory-card. Press **ENTER** to carry out the operation.

Format**Caution**

Formatting a memory-card destroys any existing files on the card.

Format the memory-card. Press **ENTER** to carry out the operation.

CONFIG screen

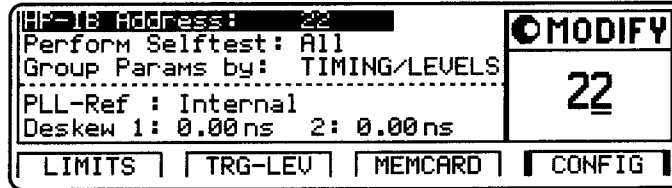

3

Figure 3-51. CONFIG screen

Use the CONFIG screen to:

- Set the HP-IB address of the HP 8110A.
- Perform a selftest.
- Group the pulse parameters by **TIMING /LEVELS** or **OUTPUT 1 /OUTPUT2** on a two channel instrument.
- Select the frequency reference source and frequency for the PLL if you have the HP 81106A PLL module fitted.
- Set the deskey delays for **OUTPUTS 1** and **2** if you have the HP 81107A Multichannel Deskew module fitted.

HP-IB Address Set the HP 8110A HP-IB address in the range 0 to 30.

Perform Selftest Perform a selftest by pressing **(ENTER)**. You can choose between testing the microprocessor board (μ P Board) and the pulse signal generating boards (Signal).

If the selftest fails, a flashing E is displayed. Press **(HELP)** to see the list of error messages.

Group Params by

Note

This option is only available if you have two Output modules fitted to your HP 8110A mainframe.

Configure the grouping of the pulse-parameters on the user interface:

TIMING/LEVELS

The pulse-timing parameters for OUTPUTS 1 and 2 are grouped together on the **TIMING** parameter screen.

The pulse-level parameters for OUTPUTS 1 and 2 are grouped together on the **LEVELS** parameter screen.

OUTPUT 1/2

All timing and level parameters for OUTPUT 1 are grouped together on the **OUTPUT 1** parameter screen.

All timing and level parameters for OUTPUTS 2 are grouped together on the **OUTPUT 2** parameter screen.

3

CONFIG

PLL-Ref

Note



This parameter is only available if you have the HP 81106A PLL/External Clock module fitted.

Set the frequency reference source for the PLL:

Internal

The internal 5 MHz reference.

CLK-IN

An external reference signal at the CLK IN (PLL REF) connector. You can set the expected frequency of the external reference to 5 MHz or 10 MHz:

HP-IB Address: 22	<input type="radio"/> MODIFY
Perform Selftest: μ P Board	* 5 MHz
Group Params by: OUTPUT 1 / 2	10 MHz
PLL-Ref : CLK-IN freq 5 MHz	
Deskew 1: 0.00 ns 2: 0.00 ns	
LIMITS	TRG-LEV
MEMCARD	CONFIG

Figure 3-52.

CONFIG screen, External PLL Reference frequency

Deskew

Note



The deskew parameters are only available if you have the HP 81107A Multichannel Deskew module fitted.

Set the deskew delays for OUTPUTS 1 and 2. The deskew delays are independent of the standard pulse-delay parameters and provide additional delay range for deskewing in multichannel applications or to compensate for systematic cable delays in the test set-up.

Warnings and Errors

The HP 8110A has two levels of error reporting called warnings and errors. On a single channel instrument, or a two channel instrument with outputs Added at Output 1, error and warning checking is always enabled unless you switch it off via the HP-IB using the :SYSTem:CHECK command.

3

Note



On a two channel instrument with Seperate Outputs, error and warning checking is *automatically* disabled for a channel which is switched off. This allows you to ignore the settings of a channel you are not using. You can also switch off error and warning checking via the HP-IB.

Maximum programmable range of selected parameter					
Probably invalid	Probably valid	← ALL signal parameters in specification →		Probably valid	Probably invalid
ERROR	WARNING			WARNING	ERROR
Setting not implemented	Setting implemented in hardware				Setting not implemented

Warnings

A warning is generated when the output signal *could* be invalid due to a combination of worst case uncertainties at the current settings of all relevant parameters. For example, when adjusting the pulse width, the leading edge, trailing edge, and pulse period settings and their uncertainties have to be considered in order to check if the width setting will fit within the pulse period. Refer to "An Example of Warning and Error Reporting". Note that the warning limits are therefore not fixed for a particular parameter, but vary with the settings of the related parameters. It is also possible that the error and warning limits are the same, that is, a warning does not occur before the error limit is reached.

If a warning occurs, the settings are still implemented in the hardware since the worst case conditions used to

Warnings and Errors

evaluate the warning limits are very unlikely to occur in practice.

A blinking **W** indicates that one or more warnings have occurred. Press **(HELP)** to view the warning list. Multiple warnings can exist together.

3

Errors

An error is generated when an invalid mode is chosen, or the required parameter settings cannot be implemented in the output hardware. Multiple errors can occur, but only the first error detected is displayed.

An error is indicated by a blinking error message at the bottom of the screen.

Note



If you are using the knob to adjust parameters it is normally not possible to generate warnings or errors. All parameters are automatically limited to settings which guarantee specified operation.

If you do want to use the knob to adjust a parameter beyond its warning limits:

1. Adjust to the limit with the knob
2. Press **(SHIFT)** and adjust beyond the limit with the knob.

AUTOSET

You can press **(SHIFT)****(HELP)** to carry out an AUTOSET. The instrument resets all parameters, based on the current period setting, to remove all warning and error conditions.

An Example of Warning and Error Reporting

1. Switch on instrument and RECALL standard settings with **(SHIFT)****(STORE)****(0)**. The period is now set to 1 μ s.
2. Switch on OUTPUT 1 with **(SHIFT)****(0)**.
3. On the TIMING or OUTPUT 1 screen, move the parameter cursor onto the value of the Width parameter (100ns).

4. Use the knob to make the `width` as large as possible (approximately 940ns)

This limit is intended to guarantee that the actual output pulse is within specifications, for the actual period.

The limit is calculated taking into account a worst case combination of minimum period from the period setting ($1\ \mu\text{s}$) and maximum width from the width setting ($940\ \text{ns}$) together with leading and trailing edge settings ($2.00\ \text{ns}$).

Note that if you now try and adjust the Leading Edge from its current setting of $2.00\ \text{ns}$ with the knob, it cannot be adjusted. This is because the upper and lower warning limits are currently $2.00\ \text{ns}$. The width is at its maximum value and $\text{width} + \text{leading edge} + \text{trailing edge} \leq \text{period}$.

5. Press `(SHIFT)` and adjust the `width` above its warning limit. A flashing `W` appears to indicate that a warning condition has occurred.

Note that as long as no errors occur, the output hardware is set up and attempts to generate the required output.

6. Press `(HELP)` to see the warning message:

```
Trailing edge 1 may cut next pulse
```

7. Press `(HELP)` again to return to the `width` parameter.

8. Increase the `width` further to approximately $980\ \text{ns}$ and press `(HELP)` to see the current warnings:

```
Width 1 too close to period
```

```
Trailing edge 1 may cut next pulse
```

9. Press `(HELP)` again to return to the `width` parameter.

10. Increase the `width` further until a flashing error message appears (approximately $1.10\ \mu\text{s}$):

```
OUTPUT 1: Width > Period
```

You have reached the current upper error-limit of the `Width` parameter. The setting is not implemented in the output hardware.

11. Press `SHIFT` `HELP` to carry out an AUTOSET.

3

HP 8110A Programming Reference

Common Command Summary IEEE 488.2

Table 4-1.
HP 8110A IEEE 488.2 Common Command Summary

Command	Parameter	Description
*CLS	—	Clear the status structure
*ESE	<0-255>	Set the Event Status Register Mask
*ESR?	—	Read the Event Status Register
*IDN?	—	Read the Instrument's Identification string
*LRN?	—	Read the complete Instrument Setting
*OPC	—	Set the Operation Complete bit when all pending actions are complete
*OPT?	—	Read the installed options
*RCL	<0-9>	Recall a complete Instrument Setting from memory
*RST ¹	—	Reset the instrument to standard settings
*SAV	<1-9>	Save the complete Instrument Setting to memory
*SRE	<0-255>	Set the Service Request Enable Mask
*STB?	—	Read the Status Byte
*TRG	—	Trigger
*TST?	—	Execute instrument's self-test
*WAI	—	Wait until all pending actions are complete

¹ See the default settings in table 4-13, at the end of this section.

SCPI Command Summary

Table 4-2. HP 8110A SCPI Command Summary

Command	Parameter	Description
:ARM [:SEquence [1]]:START [:LAYer [1]] :EWIDth :STATe :FREQuency :IMPedance :LEVel :PERiod :SENSe :SLOPe :SOURce	ON OFF 1 0 <value> <value> <value> EDGE LEVel POS NEG EITH IMM INT2 EXT MAN	(Trigger mode and source) Set/read External Width mode Set/read trigger frequency, when PLL (INT2) used as source Set/read impedance at EXT INPUT ¹ Set/read threshold level at EXT INPUT Set/read trigger period, when PLL (INT2) used as source Set/read trigger on edge or gate on level Set/read trigger slope at EXT INPUT Set/read trigger source (VFO PLL EXT INPUT MAN key)
:CHANnel :MATH	OFF PLUS	Set/read addition of channels 1 & 2 at Output 1
:DIGital [:STIMulus] :PATtern :DATA[1 2 3] :PRBS[1 2 3] :PRESet[1 2 3] [:STATe] :UPDate :SIGNal[1 2] :FORMat	<start>,<data> <n>,<length> <n>,<length> OFF ON 0 1 OFF ON ONCE RZ NRZ	Set/read pattern data [from Bit <start>] Set PRBS 2 ⁿ -1 data Set preset pattern with frequency CLOCK÷n Switch PATTERN pulse-mode on or off Update the hardware with pattern data Set/read data format of Output channel
:DISPlay [:WINDow] [:STATe]	ON OFF 1 0	Set/read frontpanel display state

¹ Value will be rounded to 50 Ω or 1 kΩ

Table 4-2.
HP 8110A SCPI Command Summary (continued)

Command	Parameter	Description
:MMEMory		
:CATalog?	[A:]	Read directory of memory card
:CDIRectory	[<name>]	Change directory on memory card
:COPY	<source>[,A:],<dest>[,A:]	Copy a file on memory card
:DELete	<name>[,A:]	Delete a file from memory card
:INITialize	[A:[,DOS]]	Initialize memory card to DOS format
:LOAD		
:STATe	<n>,<name>	Load file from memory card to memory n
:STORe		
:STATe	<n>,<name>	Store memory n to memory card
:OUTPut[1 2]		
[:STATe]	ON OFF 1 0	Set/read channel output state
:IMPedance		
[:INTernal]	<value>	Set/read internal source impedance of output
:EXTernal	<value>	Set/read expected external load impedance at output
:POLarity	NORM INV	Set/read output polarity
[:SOURce]		
:CORRection[1 2]		(Only if HP 81107A Deskew fitted)
:EDELay		
[:TIME]	<value>	Set/read channel deskew
:CURRent[1 2] ¹		
[:LEVel]		
[:IMMediate]		
[:AMPLitude]	<value>	Set/read channel amplitude current
:OFFSet	<value>	Set/read channel offset current
:HIGH	<value>	Set/read channel high-level current
:LOW	<value>	Set/read channel low-level current
:LIMit		
[:HIGH]		Set/read maximum current limit
:LOW		Set/read minimum current limit
:STATe	ON OFF 1 0	Enable/Disable the current limits.
:FREQuency		
[:CW]:FIXed]	<value>	Set/read frequency of pulses
:AUTO	ONCE	Measure frequency at CLK IN
:HOLD[1 2] ¹	VOLT CURR	Switch between VOLTage and CURRent command subtrees

¹ The CURRent and VOLTage subsystems cannot be used at the same time. Use the :HOLD command to select between them.

Table 4-2.
HP 8110A SCPI Command Summary (continued)

Command	Parameter	Description
[:SOURce]		(Continued from previous page)
:PHASe[1 2]	<value>	Set/read channel phase
[:ADJust]	<value>	
:PULSe		
:DCYCLe[1 2]	<value>	Set/read channel dutycycle
:DELay[1 2]	<value>	Set/read channel delay (to leading edge)
:HOLD	TIME PRATio	Hold absolute delay delay as period ratio fixed with varying frequency
:UNIT	S SEC PCT DEG RAD	Set/read delay units
:DOUBle[1 2]		
[:STATe]	OFF ON	Enable/disable double pulses per pulse-period
:DELay	<value>	Set/read delay between double pulses
:HOLD	TIME PRATio	Hold absolute delay delay as period ratio fixed with varying frequency
:UNIT	S SEC PCT	Set/read delay units
:HOLD[1 2]	WIDTH DCYCLe TDELay	Hold Width Dutycycle Trailing edge delay fixed with varying frequency
:PERiod	<value>	Set/read pulse-period
:AUTO	ONCE	Measure pulse-period at CLK IN
:TrailingDELay[1 2]	<value>	Set/read trailing edge delay
:TRANsition[1 2]		
:HOLD	TIME WRATio	Hold absolute transitions transitions as width ratio fixed with varying width/period
:UNIT	S SEC PCT	Set/read transition-time units
[:LEADing]	<value>	Set/read leading-edge transition
:TRAILing	<value>	Set/read trailing-edge transition
:AUTO	OFF ON ONCE	Couple trailing-edge to leading-edge
:TRIGger[1 2]		
:VOLTagE	TTL ECL	Set/read TRIGGER STROBE OUTput levels
:WIDTh[1 2]	<value>	Set/read channel pulse-width

4

Table 4-2.
HP 8110A SCPI Command Summary (continued)

Command	Parameter	Description
[[:SOURce]		(Continued from previous page)
:ROSCillator		
:SOURce	INTErnal EXTernal	Set/read PLL reference source
:EXTernal		
:FREQuency	< value >	Set/read frequency of external PLL reference ¹
:VOLTage[1 2]		
[[:LEVel]		
[[:IMMediate]		
[[:AMPLitude]	< value >	Set/read channel amplitude voltage
:OFFSet	< value >	Set/read channel offset voltage
:HIGH	< value >	Set/read channel high-level voltage
:LOW	< value >	Set/read channel low-level voltage
:LIMit		
[[:HIGH]		Set/read maximum voltage limit
:LOW		Set/read minimum voltage limit
:STATe	ON OFF 1 0	Enable/Disable the voltage limits.
:STATus		
:OPERation		
[[:EVENT]?]		Read Operation event register
:CONDition?		Read Operation condition register
:ENABle	Numeric	Set/Read Operation enable register
:NTRansition	Numeric	Set/Read Operation negative-transition register
:PTRansition	Numeric	Set/Read Operation positive-transition register
:PRESet		Clear and preset status groups
:QUESTionable		
[[:EVENT]?]		Read Questionable event register
:CONDition?		Read Questionable condition register
:ENABle	Numeric	Set/Read Questionable enable register
:NTRansition	Numeric	Set/Read Questionable negative-transition register
:PTRansition	Numeric	Set/Read Questionable positive-transition register

4

¹ Value will be rounded to 5 MHz or 10 MHz.

SCPI Command Summary

Table 4-2.
HP 8110A SCPI Command Summary (continued)

Command	Parameter	Description
:SYSTem :CHECK [:ALL] [:STATe]	ON OFF	Switch error checking on and off
:ERRor?		Read error queue
:KEY	Numeric	Simulate key press or read last key pressed
:PRESet		no function
:SECurity [:STATe]	Block data ON OFF	Set/read complete instrument Switch security on and off
:SET	Block data	Set/read complete instrument setting
:VERsion?		Read SCPI compliance version
:WARning [:COUNt]?		Read number of active warnings
:STRing?		Read active warnings as concatenated string
:BUFFer?		Read maximum possible length of concatenated string
:TRIGger [:SEQuence [1]]:START]		(Pulse mode and period source)
:COUNt	<value>	Set/read number of triggered periods to be generated per :ARM event ¹
:IMPedance	<value>	Set/read impedance at CLK IN ²
:LEVel	<value>	Set/read threshold level at CLK IN
:SLOPe	POS NEG	Set/read trigger slope at CLK IN
:SOURce	IMM INT1 INT2 EXT	Set/read trigger source (IMM VFO PLL CLK IN)

1 BURST or PATTERN length

2 Value will be rounded to 50 Ω or 1k Ω

Firmware Anomalies of Revision 02.02.00

1. Condition: PLL as period source, period >999 ms
 Anomaly: When period source is switched from PLL to internal oscillator, the frequency is not reset on the display but the frequency changes to 1 Hz. No error signal or warning is generated.
 Solution: Set the required frequency before or after switching away from the PLL

2. Condition: Channel 1 off, Channel 2 on, amplitude = max
 Anomaly: Channel 2 amplitude display can be set above max, e.g.:
 >10.2 Vpp (50 Ω into 50 Ω)
 >19.4 Vpp (1 kΩ into 50 Ω)
 Solution: Switch Channel 1 on, Channel 2 then operates correctly and it is no longer feasible to set excessive voltages in the display.

3. Condition: Remote control, external clock
 Anomaly: Conflict between measurement of ext frequency and HP-IB process.
 Solution: Select "measure once" mode. The command sequence is:

```

":SOUR:FREQ:AUTO ONCE"  !This stops continuous measurement
":DIG:PATT ON"          !Selects mode, in this case, pattern mode
":TRIG:SOUR EXT2"      !Selects external clock as period source
":ARM:SOUR IMM"        !Selects continuous operation

```



SCPI Command Summary

`":SOUR:FREQ:AUTO ONCE"` *!This command initiates a single measurement. It should therefore be repeated whenever it is necessary to measure the ext frequency*

4

4. Condition: Programming trailing delay via HP-IB

Anomaly: No reaction to the command
":SOUR:PULS:TDEL <value>"

Solution: First send the command
":SOUR:PULS:HOLD TDEL"

Status Model

Overview

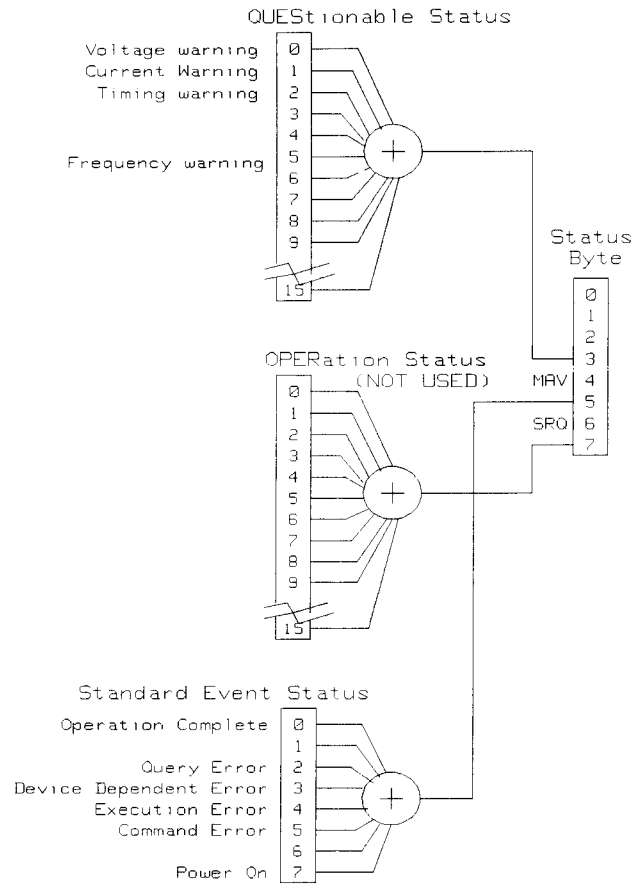

4

Figure 4-1. HP 8110A Status Groups

The HP 8110A has a status reporting system conforming to IEEE 488.2 and SCPI. Figure 4-1 shows the status groups available in the HP 8110A. Each status group is made up of component registers, as shown in Figure 4-2.

Status Model

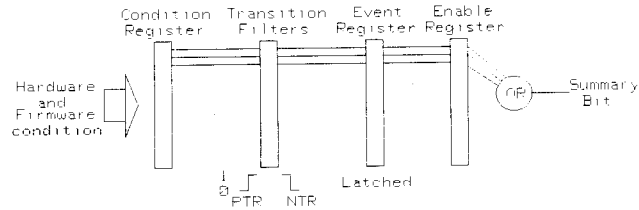

Figure 4-2. Component registers in a Status Group

Condition Register

A condition register contains the current status of the hardware and firmware. It is continuously updated and is not latched or buffered. You can only read condition registers. If there is no command to read the condition register of a particular status group, then it is simply invisible to you.

Transition Filters

Transition filters are used to detect changes of state in the condition register and set the corresponding bit in the event register. You can set transition filter bits to detect positive transitions (PTR), negative transitions (NTR) or both. Transition filters are therefore read-write registers. They are unaffected by *CLS.

Event Register

An event register latches transition events from the condition register as specified by the transition filters or records status events. Querying (reading) the event register clears it, as does the *CLS command. There is no buffering, so while a bit is set, subsequent transition events are not recorded. Event registers are read-only.

Enable register

The enable register defines which bits in an event register are included in the logical OR into the summary bit. The enable register is logically ANDed with the event register and the resulting bits ORed into the summary bit. Enable

registers are read-write, and are not affected by *CLS or querying.

Although all status groups have all of these registers, not all status groups actually use all of the registers. Table 4-3 summarizes the registers used in the HP 8110A status groups.

**Table 4-3.
HP 8110A Status Groups - Registers Used**

Status Group	Registers in Group				
	CONDition	NTR	PTR	EVENT	ENABLE
QUESTionable	✓	✓	✓	✓	✓
OPERation ¹	x	x	x	x	x
Standard Event Status	x	x	x	✓ ²	✓ ³
Status Byte	x	x	x	✓ ⁴	✓ ⁵

4

1 Present, but not used. COND and EVEN always 0.

2 Use *ESR? to query.

3 Use *ESE to set, *ESE? to query

4 Use *STB? to query

5 Use *SRE to set, *SRE? to query

Status Byte

The status byte summarizes the information from all other status groups. The summary bit for the status byte actually appears in bit 6 (RQS) of the status byte. When RQS is set it generates an SRQ interrupt to the controller indicating that at least one instrument on the bus requires attention. You can read the status byte using a serial poll or *STB?.

Status Model

Table 4-4. Status Byte bits

Bit	Description
0	Unused, always 0
1	Unused, always 0
2	Unused, always 0
3	QUESTionable Status Summary Bit
4	MAV - Message AVailable in output buffer
5	Standard Event Status summary bit
6	RQS - ReQuest Service
7	OPERation Status summary Bit, unused

4

Standard Event Status Group

**Table 4-5.
Standard Event Status Group bits**

Bit	Description
0	Operation Complete. set by *OPC
1	Unused, always 0
2	Query Error
3	Device Dependant Error
4	Execution Error
5	Command Error
6	Unused, always 0
7	Power On

OPERation Status Group

This Status Group is not used in the HP 8110A.

Table 4-6. OPERation Status Group bits

Bit	Description
0	Unused, always 0
1	Unused, always 0
2	Unused, always 0
3	Unused, always 0
4	Unused, always 0
5	Unused, always 0
6	Unused, always 0
7	Unused, always 0
8	Unused, always 0
9	Unused, always 0
10	Unused, always 0
11	Unused, always 0
12	Unused, always 0
13	Unused, always 0
14	Unused, always 0
15	Always 0

4



Programming Trigger Modes

QUEStionable Status Group

Table 4-7. QUEStionable Status Group bits

Bit	QUEStionable
0	Voltage warning
1	Current warning
2	Time warning
3	Unused, always 0
4	Unused, always 0
5	Frequency warning
6	Unused, always 0
7	Unused, always 0
8	Unused, always 0
9	Unused, always 0
10	Unused, always 0
11	Unused, always 0
12	Unused, always 0
13	Unused, always 0
14	Unused, always 0
15	Always 0

The QUEStionable Status group is used to report warning conditions amongst the voltage, current, pulse timing and frequency parameters. For more information on warning conditions refer to “Warnings and Errors” in Chapter 3. Warnings occur when a parameter, although not outside its maximum limits, could be causing an invalid signal at the output because of the actual settings and uncertainties of related parameters.

Programming the HP 8110A Trigger Modes

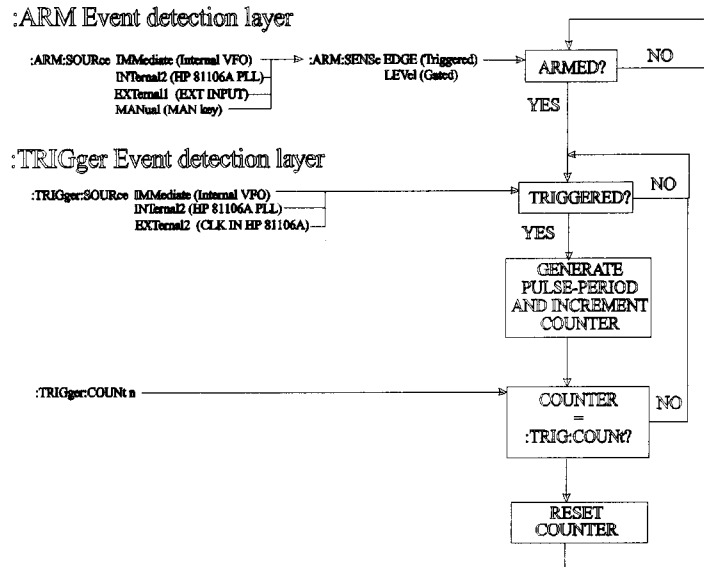

4

Figure 4-3. HP 8110A ARM-TRIGGER model

You program the comprehensive triggering capabilities of the HP 8110A using the SCPI :ARM and :TRIGger subsystems. Using these two command subsystems you can program the operating modes of the instrument which are set up using the TRG-MODE screen on the frontpanel.

Use the :ARM subsystem to select the overall triggering mode of the instrument (CONTINUOUS, TRIGGERED, GATED, EXT WIDTH), and the :TRIGger subsystem to select the pulse-period source, triggering and number of pulse-periods per :ARM event (BURST or PATTERN length).

Programming Trigger Modes

CONTINUOUS Set CONTINUOUS mode by ARming the HP 8110A from its internal oscillator:

:ARM:SOURce IMMEDIATE *Arm from internal osc.*

TRIGGERED Set TRIGGERED mode by ARming the HP 8110A on edges from the EXT INPUT:

:ARM:SOURce EXTernal1 *Arm from EXT INPUT*

:ARM:SENSe EDGE *Arm on edge*

:ARM:SLOPe POSitive *Arm on positive edge*

:ARM:LEVel 1V *Set EXT INPUT threshold*

If you have the HP 81106A PLL/External Clock fitted, you can also ARM the HP 8110A from the PLL and set the frequency (or period) of the PLL to the required triggering rate:

:ARM:SOURce INTernal2 *Arm from HP 81106A PLL*

:ARM:SENSe EDGE *Arm on edge*

:ARM:SLOPe POSitive *Arm on positive edge*

:ARM:FREQuency <value> *Set PLL frequency*

Note



The HP 81106A PLL (INTernal2) *cannot* be used as :ARM:SOURce (triggering rate) if it is already being used as :TRIGger:SOURce (pulse-period source).

GATED Set GATED mode by ARming the HP 8110A on levels from the EXT INPUT:

:ARM:SOURce EXTernal1 *Arm from EXT INPUT*

:ARM:SENSe LEVel *Arm on signal level*

:ARM:SLOPe POSitive *Arm on positive level*

EXT WIDTH Set EXT WIDTH mode using the :EWIDth[:STATe] command:

:ARM:EWIDth ON *Switch on EXT WIDTH mode*

This command disables the ARM-TRIGger system. The ARM-TRIGger system is re-enabled by switching OFF EWIDth mode.

Programming Trigger Modes

PULSES Set **PULSES** mode by setting the **:TRIGger:COUNT** to 1 so that a single triggered pulse-period is generated for every **ARM** event. The trigger source sets the pulse-period:

```

:TRIGger:COUNT 1           Single pulse-period per ARM event
:TRIGger:SOURce INTernal1   Pulse-period from internal osc.
:DIGital:PATtern OFF       Disable pattern data
    
```

Table 4-8.
Pulse-period sources set by :TRIG:SOUR

Pulse-period source	:TRIGger:SOURce
internal osc.	INTernal[1]
HP 81106A PLL	INTernal2
HP 81106A CLK IN	EXTernal2

4

Note



The HP 81106A PLL (INTernal2) *cannot* be used as **:TRIGger:SOURce** (pulse-period source) if it is already being used as **:ARM:SOURce** (triggering rate).

Note that in **TRIGGERED PULSES** mode the pulse-period source is not relevant because a single pulse is generated for each **ARM** event.

BURST of Set **BURST of** mode by setting the **:TRIGger:COUNT** to the burst count required. The trigger source sets the pulse-period for the pulses within the burst (See Table 4-8):

```

:TRIGger:COUNT 16         Burst of 16 pulse-periods
:TRIGger:SOURce INTernal1   Pulse-period from internal osc.
:DIGital:PATtern OFF       Disable pattern data
    
```

PATTERN Set **PATTERN** mode by setting the **:TRIGger:COUNT** to the pattern length required, and switching on digital pattern data. The trigger source sets the pulse-period for the data pulses (See Table 4-8):

```

:TRIGger:COUNT 512        Pattern length 512
:TRIGger:SOURce INTernal1   Pulse-period from internal osc.
:DIGital:PATtern ON        Enable pattern data
:DIGital:SIGNal1:FORMat NRZ Set OUTPUT 1 data to NRZ
    
```

Command Dictionary

The following reference sections list the HP 8110A commands in alphabetical order. In addition to a command description, the attributes of each command are described under the following headings. Not all of these attributes are applicable to all commands.

4	Form	Set	The command can be used to program the instrument
		Query	The command can be used to interrogate the instrument. Add a ? to the command if necessary.
		Event	The command performs a one-off action.
	Parameter	The type of parameter, if any, accepted by the command.	
	Parameter Suffix	The suffixes which may follow the parameter.	
	Functional Coupling	Any other commands which are implicitly executed by the command.	
	Value Coupling	Any other parameter which is also changed by the command.	
	Range Coupling	Any other parameters whose valid ranges may be changed by the command.	
	*RST value	The value/state following a *RST command.	
	Specified Limits	The specified limits of a parameter.	

Absolute Limits Some parameters can be programmed beyond their specified limits.

Example Example programming statements which assume:

- HP BASIC 5.0/5.1/6.1
- HP-IB Interface Select Code = 7
- HP 8110A HP-IB Address = 10

:ARM:EWIDth:STATe

Form Set & Query

Parameter ON|OFF|1|0

***RST value** OFF

Description This command enables the EXT WIDTH trigger mode available on the TRG-MODE screen using the frontpanel. When EXT WIDTH mode is switched on, the rest of the :ARM and :TRIG system is disabled.

In EXT WIDTH mode a signal applied to the EXT INPUT determines the width and period of the output signal(s) from the HP 8110A. You can still control the edge transition-times and levels of the output signal(s).

:ARM:FREQuency

Form	Set & Query
Parameter	Numeric
Parameter Suffix	HZ with engineering prefixes, or MHZ is Megahertz.
*RST value	100 kHz
Specified Limits	See ":ARM:PERiod"
Description	<p>Use this command to program the frequency of the HP 81106A PLL (INTernal2) when it is used as the :ARM:SOURce for internal triggering of pulses, bursts or patterns.</p> <p>If you are using the PLL as :TRIGger:SOURce to set the pulse frequency, use the [:SOURce]:FREQuency[:CW :FIXed] command.</p>

Example To set up bursts of four 100 MHz pulses occurring at a burst-rate of 10 MHz:

```

OUTPUT 710;":TRIG:SOUR INT"   Select internal osc. as pulse-
                               period source
OUTPUT 710;":FREQ 100MHZ"    Set pulse frequency to 100 MHz
OUTPUT 710;":ARM:SOUR INT2"   Select PLL as triggering source
OUTPUT 710;":ARM:SENS EDGE"   Sense edge of PLL signal
OUTPUT 710;":ARM:FREQ 10MHZ"  Set triggering frequency to 10 MHz
OUTPUT 710;":TRIG:COUNT 4"   Set burst length to 4

```

:ARM:IMPedance

Form	Set & Query
Parameter	Numeric
Parameter Suffix	OHM with engineering prefixes, or MOHM is Megaohms.
*RST value	50 Ω
Specified Limits	50 Ω or 10 k Ω
Description	Use this command to program the input impedance of the EXT INPUT connector. Note that only two settings are available. If you try to program any other value, it will be rounded to one of the specified values.
Example	<pre>OUTPUT 710;":ARM:IMP 50OHM" <i>Set EXT INPUT impedance to 50 Ω</i> OUTPUT 710;":ARM:LEV 2.5V" <i>Set EXT INPUT threshold to 2.5 V</i></pre>

:ARM:LEVel

Form	Set & Query
Parameter	Numeric
Parameter Suffix	V with engineering prefixes.
*RST value	+1.0 V
Specified Limits	-10 V to +10 V
Description	Use this command to program the triggering threshold of the EXT INPUT connector.
Example	<pre>OUTPUT 710;":ARM:IMP 500HM" <i>Set EXT INPUT impedance to 50 Ω</i> OUTPUT 710;":ARM:LEV 2.5V" <i>Set EXT INPUT threshold to 2.5 V</i></pre>

:ARM:PERiod

Form	Set & Query
Parameter	Numeric
Parameter Suffix	S with engineering prefixes.
*RST value	10.00 μ s
Specified Limits	6.65 ns to 999 s
Description	<p>Use this command to program the period of the HP 81106A PLL (INTernal2) when it is used as the :ARM:SOURce for internal triggering of pulses, bursts or patterns.</p> <p>If you are using the PLL as :TRIGger:SOURce use the [:SOURce]:PULSe:PERiod command to set the pulse period,</p>
Example	<p>To set up bursts of four 10 ns pulses occurring every 100 ns:</p> <pre>OUTPUT 710;":TRIG:SOUR INT" <i>Select internal osc. as pulse- period source</i> OUTPUT 710;":PER 10NS" <i>Set pulse period to 10 ns</i> OUTPUT 710;":ARM:SOUR INT2" <i>Select PLL as triggering source</i> OUTPUT 710;":ARM:SENS EDGE" <i>Sense edge of PLL signal</i> OUTPUT 710;":ARM:PER 100ns" <i>Set triggering period to 100 ns</i> OUTPUT 710;":TRIG:COUNT 4" <i>Set burst length to 4</i></pre>

:ARM:SENSe

Form	Set & Query
Parameter	EDGE LEVel
*RST value	EDGE
Description	<p>Use this command to select TRIGGERED or GATED mode by choosing whether the HP 8110A arms on the edge(s) or level of the arming signal.</p> <p>When sensing edges, the HP 8110A triggers when the arming signal crosses the selected threshold level (:ARM:LEV) in the selected direction (:ARM:SLOP). This corresponds to the TRIGGERED mode selected on the TRG-MODE screen when using the frontpanel.</p> <p>When sensing levels, the HP 8110A triggers as long as the arming signal is above (:ARM:SLOP POS), or below (:ARM:SLOP NEG) the selected threshold level (:ARM:LEV). This corresponds to the GATED mode selected on the TRG-MODE screen when using the frontpanel.</p>

4

:ARM:SLOPe

Form Set & Query

Parameter POSitive|NEGative|EITHer

***RST value** POS

Description Use this command to select the trigger slope for the arming signal when triggering on edges. Use EITHER to trigger on both the positive and negative edges of the arming signal. This allows you to trigger at twice the frequency of the arming signal.

If you are arming on levels, use this command to select whether the HP 8110A triggers during the positive or negative cycle of the arming signal.

4

:ARM:SOURce**Form** Set & Query**Parameter** IMMEDIATE|INTERNAL[1]|INTERNAL2|EXTERNAL[1]|MANUAL***RST value** IMM**Description** Use this command to select the triggering mode of the HP 8110A by selecting the source of the arming signal:

4

Table 4-9.
Triggering sources and modes set by :ARM:SOUR

Triggering source	:ARM:SOURce	Mode
internal osc.	IMMEDIATE INTERNAL[1]	CONTINUOUS
HP 81106A PLL	INTERNAL2	¹ TRIGGERED GATED by: PLL
EXT INPUT	EXTERNAL1	¹ TRIGGERED GATED by: EXT IN
MAN key	MANUAL	¹ TRIGGERED GATED by: MANKey

¹ Use :ARM:SENSE EDGE|LEVEL to choose between TRIGGERED and GATED

:CHANnel:MATH

Form Set & Query

Parameter OFF|PLUS

***RST value** OFF

Description Use this command to enable or disable channel addition in an instrument with two HP 81103A Output channels installed. With :CHAN:MATH ON the signals from both channels are added at OUTPUT 1. OUTPUT 2 is not used. This allows you to for example

- Generate 3 and 4 level waveforms
- Simulate single or repeated glitches
- Generate pulse transitions with a step-change in slew-rate
- Simulate overshoot and undershoot

For levels and amplitude values which can be added in the channel addition mode, refer to Chapter 6 *Specifications*, Outputs Table 6-1 and Figure 6-2.

:DIGital[:STIMulus]:PATtern:DATA[1|2|3]

Form Set & Query

Parameter [<start>,<data>]

***RST value**

Table 4-10. *RST PATTERN data

[1 2 3]	Channel	Default		
	Description	Bit 1	Bit 2	Bits 3 to 4096
1	CH1 (OUTPUT 1)	1	0	0
2	CH2 (OUTPUT 2)	0	1	0
3	STRB (STROBE OUT)	1	0	0

4

Description Use this command to set or read the pattern data of one or all channels starting from Bit 1. (Note that the optional<start> parameter is ignored by the HP 8110A if you use it). The <data> is an arbitrary block of program data as defined in IEEE 488.2 7.7.6.2, for example:

#1541213

Start of block
 1 Length of the length of the data
 5 Length of the data
 41213 5 bytes of data

#2161000100010001000

Start of block
 2 Length of the length of the data
 16 Length of the data
 10...00 16 bytes of data

:DIGital[:STIMulus]:PATTern:DATA[1|2|3]

Examples

:DIG:PATT:DATA #1541213

The HP 8110A uses each byte of data set one Bit in the pattern memory. If you don't specify a particular channel, the lowest three bits of each byte are used to set all three channels, and the top five bits are ignored. Note that you can therefore use the ASCII characters '0', '1', '2' and '3' to program Outputs 1 and 2 in binary with STROBE=0 (or '4', '5', '6, and '7' for STROBE=1):

ASCII	DATA									STRB STROBE OUT	CH2 OUTPUT 2	CH1 OUTPUT 1
	IGNORED					USED						
	D7	D6	D5	D4	D3	D2	D1	D0				
4	0	1	1	1	0	1	0	0		1	0	0
1	0	1	1	1	0	0	0	1		0	0	1
2	0	1	1	1	0	0	1	0		0	1	0
1	0	1	1	1	0	0	0	1		0	0	1
3	0	1	1	1	0	0	1	1		0	1	1

Programming Example:

OUTPUT 710;":ARM:SOUR IMM"	<i>Set CONTINUOUS mode</i>
OUTPUT 710;":DIG:PATT:DATA #1541213"	<i>Set up pattern data for all channels</i>
OUTPUT 710;":TRIG:COUN 5	<i>Set pattern length (last bit) to 5</i>
OUTPUT 710;":DIG:PATT ON"	<i>Switch on PATTERN mode</i>

:DIGital[:STIMulus]:PATTern:DATA[1|2|3]

:DIG:PATT:DATA2 #1501011

If you specify a particular channel, the least significant bit of each byte is used to set the selected channel, and the top seven bits are ignored. Note that you can therefore use the ASCII characters '1' and '0' to set individual bits to 1 and 0:

ASCII	DATA								STRB STROBE OUT ¹	CH2 OUTPUT 2	CH1 OUTPUT 1 ¹
	IGNORED							LSB			
	D7	D6	D5	D4	D3	D2	D1	D0			
0	0	1	1	1	0	0	0	0	X	0	X
1	0	1	1	1	0	0	0	1	X	1	X
0	0	1	1	1	0	0	0	0	X	0	X
1	0	1	1	1	0	0	0	1	X	1	X
1	0	1	1	1	0	0	0	1	X	1	X

1 X indicates that the bit remains unchanged

Programming Example:

```
OUTPUT 710;":ARM:SOUR IMM"           Set CONTINUOUS mode
OUTPUT 710;":DIG:PATT:DATA3 #1501011" Set up pattern data for STROBE
                                         channel
OUTPUT 710;":TRIG:COUN 5              Set pattern length (last bit) to
                                         5
OUTPUT 710;":DIG:PATT ON"            Switch on PATTERN mode
```



:DIGital[:STIMulus]:PATTern:PRBS[1|2|3]

Form Set

Parameter <n>,<length>

***RST value** Not applicable

Specified Limits <n> 7 to 12 (integer)
<length> 1 to 4096 (integer)

Description Use this command to set up PRBS data starting from bit 1. The parameter <n> is used as the basis to generate a $2^n - 1$ PRBS. The parameter <length> determines how many bits of the PRBS sequence are used. If <length> is longer than the PRBS, the PRBS is repeated as necessary to achieve the required length.

Example To set up a repeating $2^{10} - 1$ PRBS on OUTPUT 1:

OUTPUT 710;":ARM:SOUR IMM"	<i>Set CONTINUOUS mode</i>
OUTPUT 710;":TRIG:COUN 1023	<i>Set pattern length (last bit) to 1023</i>
OUTPUT 710;":DIG:PATT:PRBS1 10,1023"	<i>Set up PRBS on OUTPUT 1</i>
OUTPUT 710;":DIG:PATT ON"	<i>Switch on PATTERN mode</i>

:DIGital[:STIMulus]:PATtern:PRESet[1|2|3]

Form Set

Parameter <n>,<length>

***RST value** Not applicable

Specified Limits <n> 1 to 2048 (integer)
<length> 1 to 4096 (integer)

4

Description Use this command to set up clock data starting from bit 1 with value 1. The parameter <n> is used as the divider to generate a $CLOCK \div n$ sequence (squarewave if NRZ data is selected). The parameter <length> determines the length of the sequence.

n=2 Sequence = 1010101010101....
n=4 Sequence = 110011001100110....
n=6 Sequence = 111000111000111....
n=8 Sequence = 111100001111000....
and so on.

Example To set up a $CLOCK \div 4$ squarewave on STROBE OUT:

OUTPUT 710;":TRIG:COUN 4096 *Set pattern length (last bit) to 4096*
OUTPUT 710;":DIG:PATT:PRES3 4,4096" *Set up $CLOCK \div 4$ on STRB*
OUTPUT 710;":DIG:PATT ON" *Switch on PATTERN mode*

Note 

To produce a CONTINUOUS squarewave the pattern length must be a multiple of twice the selected divider, in this case a multiple of 8.

:DIGital[:STIMulus]:PATtern[:STATE]

Form Set & query

Parameter ON|OFF

***RST** OFF

Description Use this command to enable and disable PATTERN mode.
Use :TRIG:COUN to program the length of the pattern.

4

:DIGital[:STIMulus]:PATtern:UPDate

Form Set & query

Parameter ON|OFF|ONCE

***RST** ON

Description Use this command to enable and disable the automatic updating of the pattern generating hardware following a :DIG:PATT:DATA command. Disable the automatic updating if you want to set up new pattern data in the HP 8110A without affecting the pattern which is currently being generated. You can then update the hardware with the new pattern data by sending a :DIG:PATT:UPD ONCE command.

4

:DIGital[:STIMulus]:SIGNal[1|2]:FORMat

Format Set & Query

Parameter RZ|NRZ

Range Coupling Period, Frequency

***RST value** RZ

Description Use this command to set and read the data format of channels 1 and 2 when using `PATTERN` mode. If you don't specify a channel number in the command, channel 1 is assumed.

RZ Return to Zero. An RZ pulse is generated for each '1' in the data. You can vary the width, edges and levels of the pulse.

NRZ Non Return to Zero. A pulse of 100% dutycycle is generated for each '1' in the data. You can vary the edges and levels of the pulse.

Example

OUTPUT 710;":DIG:SIGN:FORM NRZ" *Set channel 1 data format to NRZ*

:DISPlay[:WINDow][:STATe]

Form Set & Query

Parameter ON|OFF|1|0

***RST value** ON

Description This command is used to turn the frontpanel display on and off. Switching off the display improves the programming speed of the instrument.

Note  *RST switches the display back on. Use :SYSTem:PRESet to perform an *RST without switching the display back on.

Example

OUTPUT 710;":DISP OFF" *Switch off the frontpanel display*

4

:MMEMory:CATalog?

Form Query

Parameter ["A:"]

***RST value** Not applicable

Description Use this command to get a listing of the contents of the currently selected directory on the memory card. As there is only one memory card slot, the parameter A: is optional. The information returned is:

<bytes_used>,<bytes_free>{,<file_entry>}

<bytes_used> The total number of bytes used on the memory card.

<bytes_free> The total number of bytes still available on the memory card.

<file_entry> String containing the name, type and size of one file:

"<file_name>,<file_type>,<file_size>"

Note



- The <file_type> is always blank.
 - A directory name has <file_size> = 0
-

:MMEMory:CDIRectory

Form Event

Parameter ["directory_name"]

***RST value** Not applicable

Description Use this command to change the current directory on the memory card. If you don't specify a directory name parameter, the root directory is selected.

Note that you cannot use DOS pathnames as directory names, you can only select a directory name within the current directory.

Use the directory name "." to move back to the parent directory of the current directory, unless you are already in the root directory "\".

4

Examples

```
OUTPUT 710;":MMEM:CDIR"                    Select root directory
OUTPUT 710;":MMEM:CDIR ""PERFORM""       Select directory "PERFORM"
OUTPUT 710;":MMEM:CDIR ""..""             Select parent directory
```

:MMEMory:COPY

Form Event

Parameter "filename"[,"A:"],"copyname"[,"A:"]

***RST** Not applicable

Description Use this command to copy an existing file *filename* in the current directory to a new file *copyname*. If *copyname* is the name of a sub-directory in the current directory, a copy of the file *filename* is made in the sub-directory. Use ".." as *copyname* to copy a file into the parent directory of the current directory.

Examples

```
OUTPUT 710;":MMEM:COPY ""test1","", ""test2"" Copy test1 to test2
OUTPUT 710;":MMEM:COPY ""test1","", "".."" Copy test1 into par-
ent directory
```

:MMEMory:DElete

Form	Event
Parameter	“filename”
*RST	Not applicable
Description	Use this command to delete file <i>filename</i> from the currently selected directory.

4

:MMEMory:INITialize

Form Event

Parameter ["A:"[, "DOS"]]

***RST** Not applicable

Description

Caution



Initializing a memory card destroys any existing data on the card.

Use this command to initialize a memory card to DOS format.

:MMEMory:LOAD:STATe

Form Event

Parameter <n>,"filename"[,"A:"]

***RST** Not applicable

Specified Limits <n> = 0 to 9 (integer)

Description Use this command to load a complete instrument setting from file *filename* in the current directory into memory <n> in the HP 8110A.

Memories 1 to 9 are the internal memories. Use memory 0 to load a setting as the current instrument setting.

Examples

OUTPUT 710;":MMEM:LOAD:STAT 1,""FREQPERF""	<i>Load FREQPERF into memory 1</i>
OUTPUT 710;":MMEM:LOAD:STAT 0,""AMPTEST""	<i>Load AMPTEST as current setting</i>
OUTPUT 710;":*SAV 2"	<i>Save current setting in memory 2</i>
OUTPUT 710;":*RCL 3"	<i>Recall memory 3 as current setting</i>

:MMEMory:STORe:STATe

Form Event

Parameter <n>,"filename"[,"A:"]

***RST** Not applicable

Specified Limits <n> = 0 to 9 (integer)

Description Use this command to store a complete instrument setting from memory <n> to file *filename* in the current directory on the memory card.

Memories 1 to 9 are the internal memories. Use memory 0 to store the current instrument setting to a file.

Examples

OUTPUT 710;":MMEM:STOR:STAT 1,""FREQPERF""	<i>Store memory 1 to file FREQPERF</i>
OUTPUT 710;":MMEM:STOR:STAT 0,""AMPTEST""	<i>Store current setting to file AMPTEST</i>
OUTPUT 710;":*SAV 2"	<i>Save current setting in memory 2</i>
OUTPUT 710;":*RCL 3"	<i>Recall memory 3 as current setting</i>

:OUTPut[1|2][:STATe]

Form Set & Query

Parameter ON|OFF|1|0

***RST value** OFF

Description Use this command to switch the OUTPUTs on or off

Example

OUTPUT 710;":OUTP1 ON" *Switch on OUTPUT 1*
OUTPUT 710;":OUTP2 OFF" *Switch off OUTPUT 2*

:OUTPut[1|2]:IMPedance[:INTernal]

Form Set & Query

Parameter Numeric

Parameter Suffix OHM with engineering prefixes, or MOHM is Megaohms.

***RST value** 50 Ω

Specified Limits 50 Ω or 1 k Ω

Description Use this command to program the source impedance of the OUTPUT connectors. Note that only two settings are available. If you try to program any other value, it will be rounded to one of the specified values.

Example

```
OUTPUT 710;":OUTP1:IMP 50OHM"      Set OUTPUT 1 impedance  
                                     to 50  $\Omega$   
OUTPUT 710;":OUTP2:IMP 1000OHM"    Set OUTPUT 2 impedance  
                                     to 1 k $\Omega$ 
```

:OUTPut[1|2]:IMPedance:EXTernal

Form	Set & Query
Parameter	Numeric
Parameter Suffix	OHM with engineering prefixes, or MOHM is Megaohms.
*RST value	50.0 Ω
Specified Limits	2.5 Ω to 999 k Ω
Description	Use this command to set the expected load impedance of the device-under-test at the OUTPUT connectors. If you have a non-50 Ω load, the output levels at the device-under-test will not be the levels you program or set via the frontpanel <i>unless</i> you set the expected load using this command.

4

Example

```
OUTPUT 710;":OUTP1:IMP:EXT 47.6OHM" Set load impedance  
at OUTPUT 1 impedance  
to 47.6  $\Omega$   
OUTPUT 710;":OUTP2:IMP:EXT 999KOHM" Set load impedance  
at OUTPUT 2 impedance  
to 999 k $\Omega$ 
```

:OUTPut[1|2]:POLarity

Form Set & Query

Parameter NORMal|INVerted

***RST value** NORM

Description Use this command to invert the signal at the OUTPUTs.

Example

```
OUTPUT 710;":OUTP1:POL INV" Inverted signal at OUTPUT 1  
OUTPUT 710;":OUTP2:POL NORM" Normal signal at OUTPUT 1
```

[:SOURce]:CORRection[1|2]:EDELay[:TIME]

Form	Set & Query
Parameter	Numeric
Parameter Suffix	S with engineering prefixes.
*RST value	0
Specified Limits	0 to 28.0 ns
Description	Use this command to program the OUTPUT Deskew delay of the HP 81107A Multichannel Deskew module (if fitted). This allows you to deskew the OUTPUTS so that the zero-delay points of both OUTPUT signals are the same at the device-under-test.

Example

```
OUTPUT 710;":CORR1:EDEL 0NS"      Set OUTPUT 1 DESKEW to 0
OUTPUT 710;":CORR1:EDEL 5.18NS"   Set OUTPUT 1 DESKEW to
                                   5.18 ns
```

[[:SOURce]:CURRent[1|2][[:LEVel][[:IMMediate][[:AMPLitude]

Form Set & Query

Parameter Numeric

Parameter suffix A with engineering prefixes.

***RST value** 20 mA (50 Ω into 50 Ω)

Specified Limits 4 mA to 400 mA typical

Value coupling $Amplitude = High - Low$
 $Offset = \frac{High - Low}{2}$

Range coupling Offset

Description This command programs the amplitude current of the OUTPUT signal. Note that to set the OUTPUT levels in terms of current, you first have to execute the [:SOURce]:HOLD CURRent command to enable the [:SOURce]:CURRent subsystem.

The available current range is limited by the combination of:

- Specified Voltage limits
- Actual OUTPUT Impedance setting :OUTPut:IMPedance
- Actual Expected Load impedance setting :OUTPut:IMPedance:EXTernal

Example OUTPUT 710;" :HOLD CURR" *Enable CURRENT subsystem*
 OUTPUT 710;" :CURR1 75MA" *Set OUTPUT 1 amplitude to 75 mA*

[:SOURce]:CURRent[1|2][:LEVel][:IMMediate]:OFFSet

Form	Set & Query
Parameter	Numeric
Parameter suffix	A with engineering prefixes.
*RST value	0.0 μ A (50 Ω into 50 Ω)
Value coupling	$\text{Amplitude} = \text{High} - \text{Low}$ $\text{Offset} = \frac{\text{High} - \text{Low}}{2}$
Range coupling	Amplitude
Description	<p>This command programs the offset current of the OUTPUT signal. Note that to set the OUTPUT levels in terms of current, you first have to execute the [:SOURce]:HOLD CURRent command to enable the [:SOURce]:CURRent subsystem.</p> <p>The available current range is limited by the combination of:</p> <ul style="list-style-type: none"> ■ Specified Voltage limits ■ Actual OUTPUT Impedance setting :OUTPut:IMPedance ■ Actual Expected Load impedance setting :OUTPut:IMPedance:EXTernal
Example	<pre>OUTPUT 710;":HOLD CURR" Enable CURRENT subsystem OUTPUT 710;":CURR1:OFF 50mA" Set OUTPUT 1 offset to 50 mA</pre>

[[:SOURce]:CURRent[1|2][:LEVel][:IMMediate]:HIGH

Form Set & Query

Parameter Numeric

Parameter suffix A with engineering prefixes.

Value coupling $Amplitude = High - Low$
 $Offset = \frac{High - Low}{2}$

Range coupling Low-level

***RST value** +10 mA (50 Ω into 50 Ω)

Specified Limits -396 mA to 400 mA typical

Description This command programs the High-level current of the OUTPUT signal. Note that to set the OUTPUT levels in terms of current, you first have to execute the [[:SOURce]:HOLD CURRent command to enable the [[:SOURce]:CURRent subsystem.

The available current range is limited by the combination of:

- Specified Voltage limits
- Actual OUTPUT Impedance setting :OUTPut:IMPedance
- Actual Expected Load impedance setting :OUTPut:IMPedance:EXTernal

[[:SOURce]:CURRent[1|2][[:LEVel][[:IMMediate]:HIGH

Example

```
OUTPUT 710;":HOLD CURR"           Enable CURRENT subsystem  
OUTPUT 710;":CURR1:HIGH 150MA"    Set OUTPUT 1 High-  
                                   level to 150 mA
```

[[:SOURce]:CURRent[1|2][[:LEVel][[:IMMediate]:LOW

Form Set & Query

Parameter Numeric

Parameter suffix A with engineering prefixes.

Value coupling $Amplitude = High - Low$
 $Offset = \frac{High - Low}{2}$

Range coupling High-level

***RST value** -10 mA (50 Ω into 50 Ω)

Specified Limits -400 mA to 396 mA typical

Description This command programs the Low-level current of the OUTPUT signal. Note that to set the OUTPUT levels in terms of current, you first have to execute the [[:SOURce]:HOLD CURRent command to enable the [[:SOURce]:CURRent subsystem.

The available current range is limited by the combination of:

- Specified Voltage limits
- Actual OUTPUT Impedance setting :OUTPut:IMPedance
- Actual Expected Load impedance setting :OUTPut:IMPedance:EXTernal

[:SOURce]:CURRent[1|2][:LEVel][:IMMediate]:LOW

Example

OUTPUT 710;":HOLD CURR"	<i>Enable CURRENT subsystem</i>
OUTPUT 710;":CURR1:LOW 50MA"	<i>Set OUTPUT 1 Low-level to 50 mA</i>



[[:SOURce]:CURRent[1|2]:LIMit[:HIGH]

Form Set & Query

***RST value** +10.0 mA

Description Use this command to set/read the High-level current limit. If you switch on current limiting, the High-level current cannot be set above the programmed limit. Note that the current is *NOT* limited by the OUTPUT hardware, this is a software limit.

Example

OUTPUT 710;":HOLD CURR"	<i>Enable CURRENT subsystem</i>
OUTPUT 710;":CURR1:LIM 50MA"	<i>Set OUTPUT 1 High-level current limit to 50 mA</i>
OUTPUT 710;":CURR1:LIM:STAT ON"	<i>Switch on OUTPUT 1 limits</i>

[:SOURce]:CURRent[1|2]:LIMit:LOW

Form Set & Query

***RST value** -10.0 mA

Description Use this command to set/read the Low-level current limit. If you switch on current limiting, the Low-level current cannot be set below the programmed limit. Note that the current is *NOT* limited by the OUTPUT hardware, this is a software limit.

Example

OUTPUT 710;":HOLD CURR"	<i>Enable CURRENT subsystem</i>
OUTPUT 710;":CURR1:LIM:LOW -50MA"	<i>Set OUTPUT 1 Low-level current limit to -50 mA</i>
OUTPUT 710;":CURR1:LIM:STAT ON"	<i>Switch on OUTPUT 1 limits</i>

[:SOURce]:CURRent[1|2]:LIMit:STATE

Form Set & Query

Parameter ON|OFF|1|0

***RST value** OFF

Description This command switches the output limits on or off. When you switch on the output limits cannot program the output-levels beyond the programmed limits, until you switch off the output-limits. The limits apply whether you program High/Low levels or Amplitude/Offset levels.

Note  You can switch the limits on and off in both the [:SOURce]:CURRent and the [:SOURce]:VOLTage subsystems *but the current and voltage limits are not enabled/disabled independently*. The voltage and current limits are always enabled/disabled together.

Example

OUTPUT 710;":HOLD CURR"	<i>Enable CURRENT subsystem</i>
OUTPUT 710;":CURR1:LIM 50MA"	<i>Set OUTPUT 1 High-level current limit to 50 mA</i>
OUTPUT 710;":CURR1:LIM:LOW -50MA"	<i>Set OUTPUT 1 Low-level current limit to -50 mA</i>
OUTPUT 710;":CURR1:LIM:STAT ON"	<i>Switch on OUTPUT 1 limits</i>

[:SOURce]:FREQuency[:CW|:FIXed]

Form	Set & Query
Parameter	Numeric
Parameter Suffix	Hz with engineering prefixes, or MHZ for Megahertz.
Value coupling	$Period = \frac{1}{Frequency}$
*RST value	1.00 MHz
Specified limits	See [:SOURce]:PULSe:PERiod

Description Use this command to set/read the pulse frequency. Select the frequency source for the pulse frequency using :TRIGger:SOURce. The currently selected source is programmed by this command. Note that the specified limits and available resolution depend on the selected source.

You cannot set the pulse frequency if you have selected the HP 81106A CLK IN connector as the frequency source (:TRIG:SOUR EXT).

Example

```
OUTPUT 710;":TRIG:SOUR INT" Select internal osc. as pulse trigger
OUTPUT 710;":FREQ 75MHz" Set pulse frequency to 75 MHz
```

[[:SOURce]:FREQuency[:CW|:FIXed]:AUTO

Form Event

Parameter ONCE

***RST value** Not applicable

Description Use this command to measure the frequency at the HP 81106A CLK IN connector. If the CLK IN connector is the selected pulse frequency source, you can then read the measured value with :FREQ?

Example

OUTPUT 710;":TRIG:SOUR EXT"	<i>Select ext CLK IN as pulse trigger</i>
OUTPUT 710;":FREQ:AUTO ONCE"	<i>Measure frequency at CLK IN</i>
OUTPUT 710;":FREQ?"	<i>Query pulse frequency</i>
ENTER 710;F\$	

[:SOURce]:HOLD

Form	Set & Query
Parameter	VOLTage CURRent
*RST value	VOLT
Description	Use this command to enable either of the [:SOURce]:VOLTage or [:SOURce]:CURRent subsystems. You can control the signal levels of the HP 8110A OUTPUTs in terms of voltage or current.

4

[:SOURce] : PHASe [1 | 2] [: ADJust]

Form Set & Query

Parameter Numeric

Parameter suffix DEG or RAD. A parameter without a suffix is interpreted as RAD.

Functional coupling Programming the pulse phase also executes [:SOURce] : PULSe : HOLD PHASe so that the pulse phase is held constant when the signal frequency is changed.

Value coupling $Delay = \frac{Phase}{360} \times Period$

***RST value** 0.0

Specified limits 0 to 360°, constrained by delay and period limits.

Description Use this command to set/read the relative phase-delay of the output signal. This is equivalent to setting an absolute or percentage pulse-delay with [:SOURce] : PULSe : DELay.

If you want the phase delay to remain constant when the pulse-period is varied (rather than the absolute pulse delay) use [:SOURce] : PULSe : DELay [1 | 2] : HOLD PRATio.

Example

OUTPUT 710; " :PULS:DEL1 500NS"	<i>Set OUTPUT 1 delay to 500 ns</i>
OUTPUT 710; " :PHAS2 180DEG"	<i>Set OUTPUT 2 phase to 180°</i>
OUTPUT 710; " :PULS:DEL1:HOLD TIM"	<i>Hold OUTPUT 1 delay constant with varying period</i>

[:SOURCE]:PHASe[1|2][:ADJust]

OUTPUT 710;":PULS:DEL2:HOLD PRAT" *Hold OUTPUT 2 phase
constant with vary-
ing period*

4



[:SOURce] :PULSe :DCYCLe [1 | 2]

Form Set & Query

Parameter Numeric

Value coupling $Width = \frac{Dutycycle}{100} \times Period$

***RST value** 10.0% (derived from Width and Period)

Specified limits 0.1 - 99.9%, constrained by Width & Period limits.

Description Use this command to program the dutycycle of the pulse signal. If you want to set an absolute pulse-width use [:SOURce] :PULSe :WIDTh [1 | 2].

If you want the pulse dutycycle to remain constant when the pulse-period is varied (rather than the absolute pulse width) use [:SOURce] :PULSe :HOLD [1 | 2] DCYCLe

Example

```
OUTPUT 710;":PULS:DCYC1 25PCT" Set OUTPUT 1 du-  
                                tycyle to 25%  
OUTPUT 710;":PULS:HOLD1 DCYC"  Hold dutycycle con-  
                                stant with varying  
                                period
```

[:SOURce]:PULSe:DELay[1|2]

Form	Set & Query
Parameter	Numeric
Parameter suffix	S with engineering prefixes. You can change the default unit using [:SOURce]:PULSe:DELay[1 2]:UNIT.
Value coupling	$Phase = \frac{Delay}{Period} \times 360$ $Delay\% = \frac{Delay}{Period} \times 100$
*RST value	0.0
Specified limits	0.00 ns to 999 ms (limited by period—6.6 ns)
Description	<p>Use this command to set/read the pulse-delay. Delay is the time between the start of the pulse-period and the start of the leading-edge of the pulse.</p> <p>If you want the pulse-delay to remain constant when the pulse-period is varied (rather than the phase-delay) use [:SOURce]:PULSe:DELay[1 2]:HOLD TIME.</p>

Example

OUTPUT 710;":PULS:DEL1 500NS"	<i>Set OUTPUT 1 delay to 500 ns</i>
OUTPUT 710;":PHAS2 180DEG"	<i>Set OUTPUT 2 phase to 180°</i>
OUTPUT 710;":PULS:DEL1:HOLD TIM"	<i>Hold OUTPUT 1 delay constant with varying period</i>
OUTPUT 710;":PULS:DEL2:HOLD PRAT"	<i>Hold OUTPUT 2 phase constant with varying period</i>

[:SOURce]:PULSe:DELay[1|2]:HOLD

Form Set & Query

Parameter TIME|PeriodRATio

***RST value** TIM

Description Use this command to set/read the coupling between the pulse-period and the pulse-delay:

TIME The absolute pulse-delay is held fixed when the pulse-period is varied (Pulse phase varies).

PeriodRATio The pulse phase-delay (delay as ratio of period) is held fixed when the pulse-period is varied (Pulse-delay varies).

Example

OUTPUT 710;":PULS:DEL1 500NS"	<i>Set OUTPUT 1 delay to 500 ns</i>
OUTPUT 710;":PHAS2 180DEG"	<i>Set OUTPUT 2 phase to 180°</i>
OUTPUT 710;":PULS:DEL1:HOLD TIM"	<i>Hold OUTPUT 1 delay constant with varying period</i>
OUTPUT 710;":PULS:DEL2:HOLD PRAT"	<i>Hold OUTPUT 2 phase constant with varying period</i>

[:SOURce]:PULSe:DELay[1|2]:UNIT

Form	Set & Query
Parameter	S SEC PCT DEG RAD
*RST value	S
Description	Use this command to set/read the default units for the pulse-delay parameter. The default unit of a parameter is the unit used when the parameter is programmed to a value without a unit suffix.

4

Example

```

OUTPUT 710;":PULS:DEL1:UNIT PCT"  Set OUTPUT 1 de-
                                     lay unit to %
OUTPUT 710;":PULS:DEL1 50"         Set OUTPUT 1 de-
                                     lay to 50% of period

```

[[:SOURce]:PULSe:DOUBle[1|2]][:STATe]

Form Set & Query

Parameter OFF|ON

***RST value** OFF

Description Use this command to switch double-pulse mode on or off. In double-pulse mode two pulses are generated per pulse-period and the delay between the leading edges of the first and second pulse can be adjusted.

4

[:SOURce]:PULSe:DOUBle[1|2]:DELay

Form	Set & Query
Parameter	Numeric
Parameter suffix	S with engineering prefixes. You can change the default unit using [:SOURce]:PULSe:DOUBle:DELay[1 2]:UNIT.
Value coupling	$DblDel\% = \frac{DblDel}{Period} \times 100$
*RST value	0.0
Specified limits	0.00 ns to 999 ms (limited by period–6.6 ns)
Description	<p>Use this command to set/read the delay between the leading edges of the two pulses in double-pulse mode. The first pulse always starts at the start of the pulse-period.</p> <p>If you want the double-delay to remain constant when the pulse-period is varied (rather than the double-delay as percentage of period) use [:SOURce]:PULSe:DOUBle[1 2]:DELay:HOLD TIME.</p>

Example

OUTPUT 710;":PULS:DOUB1 ON"	<i>Switch on Double-pulses on OUTPUT 1</i>
OUTPUT 710;":PULS:DOUB1:DEL 500NS"	<i>Set inter-pulse delay to 500 ns</i>
OUTPUT 710;":PULS:DOUB1:DEL:HOLD TIM"	<i>Hold inter-pulse delay fixed with varying pulse-period</i>

[[:SOURce]:PULSe:DOUBle[1|2]:DELay:HOLD

Form Set & Query

Parameter TIME|PeriodRATio

***RST value** TIM

Description Use this command to set/read the coupling between the pulse-period and the Double-pulse delay:

TIME The absolute double-pulse delay is held fixed when the pulse-period is varied.

PeriodRATio The double-pulse delay as percentage of period is held fixed when the pulse-period is varied.

Example

OUTPUT 710;":PULS:DOUB1 ON"

Switch on Double-pulses on OUTPUT 1

OUTPUT 710;":PULS:DOUB1:DEL 50PCT"

Set inter-pulse delay to 50% of pulse-period

OUTPUT 710;":PULS:DOUB1:DEL:HOLD PRAT"

Hold inter-pulse delay as fixed percentage of pulse-period

[:SOURce]:PULSe:DOUBle[1|2]:DELay:UNIT

Form	Set & Query
Parameter	S SEC PCT
*RST value	S
Description	Use this command to set/read the default units for the double-delay parameter. The default unit of a parameter is the unit used when the parameter is programmed to a value without a unit suffix.

4

Example

```
OUTPUT 710;":PULS:DOUB1:DEL:UNIT PCT"  Set OUTPUT 1 double-
delay unit to %
OUTPUT 710;":PULS:DOUB1:DEL 50"        Set OUTPUT 1 inter-
pulse delay to 50%
of period
```

[[:SOURce]:PULSe:HOLD[1|2]

Form Set & Query

Parameter WIDTH|DCYCLE|TrailingDELAY

***RST value** WIDTH

Description Use this command to set whether the pulse-width, the pulse-duty-cycle or the pulse trailing-edge delay is held constant when the pulse-period is changed.

Example

OUTPUT 710;":PULS:DEL:HOLD1 TIM"	<i>Hold OUTPUT 1 delay fixed when frequency varies</i>
OUTPUT 710;":PULS:DEL 20NS"	<i>Set OUTPUT 1 delay to 20 ns</i>
OUTPUT 710;":PULS:HOLD1 DCYC"	<i>Hold OUTPUT 1 Duty-cycle fixed when frequency varies</i>
OUTPUT 710;":PULS:DCYC 25PCT"	<i>Set OUTPUT 1 Duty-cycle to 25%</i>

[:SOURce]:PULSe:PERiod

Form	Set & Query	
Parameter	Numeric	
Parameter Suffix	S with engineering prefixes.	
Value coupling	$Frequency = \frac{1}{Period}$	
*RST value	1 μ s	
Specified limits	6.65 ns to 999 ms	Internal Oscillator (INT1)
	6.650 ns to 999.0 s	HP 81106A PLL (INT2)

Description Use this command to set/read the pulse-period. Select the pulse-period source using :TRIGger:SOURce. The currently selected source is programmed by this command. Note that the specified limits and available resolution depend on the selected source.

You cannot set the pulse-period if you have selected the HP 81106A CLK IN connector as the frequency source (:TRIG:SOUR EXT).

Example

```
OUTPUT 710;":TRIG:SOUR INT"   Select internal osc. as pulse
                               trigger
OUTPUT 710;":PULS:PER 25NS"  Set pulse frequency to 25 ns
```

[[:SOURce]:PULSe:PERiod:AUTO

Form Event

Parameter ONCE

***RST value** Not applicable

Description Use this command to measure the period at the HP 81106A CLK IN connector. If the CLK IN connector is the selected pulse-period source, you can then read the measured value with :PULS:PER?

Example

OUTPUT 710;":TRIG:SOUR EXT"	<i>Select ext CLK IN as pulse trigger</i>
OUTPUT 710;":PULS:PER:AUTO ONCE"	<i>Measure period at CLK IN</i>
OUTPUT 710;":PULS:PER?"	<i>Query pulse period</i>
ENTER 710;P\$	

[:SOURce]:PULSe:TrailingDELay[1|2]

Form	Set & Query
Parameter	Numeric
Parameter Suffix	S with engineering prefixes.
*RST value	100 ns
Specified Limits	3.30 ns to 999 ms (Maximum = Period - 3.3 ns)
Description	Use this command to program the delay of the trailing-edge of the pulse relative to the start of the pulse-period. This is an alternative method of programming the pulse-width.

Example

OUTPUT 710;":PULS:DEL1 500NS"	<i>Set OUTPUT 1 delay to 500 ns</i>
OUTPUT 710;":PULS:DEL1:HOLD TIM"	<i>Hold OUTPUT 1 delay constant with varying period</i>
OUTPUT 710;":PULS:TDEL1 750NS"	<i>Set OUTPUT 1 trailing delay to 750 ns</i>

[[:SOURce]:PULSe:TRANsition[1|2]:HOLD

Form Set & Query

Parameter TIME|WRATio

***RST value** TIM

Description Use this command to set the coupling between transition-times and the pulse-width:

TIME The absolute transition-times are held when the pulse-width is varied.

WRATio The ratio of transition-time to pulse-width is held when the pulse-width is varied.

Example

```
OUTPUT 710;":PULS:TRAN1:HOLD TIM" Hold OUTPUT 1 tran-  
sitions fixed when  
pulse-width varies  
OUTPUT 710;":PULS:TRAN2:HOLD WRAT" Hold OUTPUT 2 tran-  
sition:width ratio when  
pulse-width varies
```

[[:SOURce]:PULSe:TRANsition[1|2]:UNIT

Form	Set & Query
Parameter	S SEC PCT
*RST value	S
Description	Use this command to set the default units for the pulse transition-times. The default unit is used when the parameter is programmed to a value without a unit suffix.

4

[[:SOURce]:PULSe:TRANsition[1|2][:LEADing]

Form	Set & Query
Parameter	Numeric
Parameter suffix	S with engineering prefixes, or PCT
*RST value	2.00 ns
Specified limits	2.00 ns to 200 ms
Parameter coupling	Trailing-edge = Leading-edge with :PULS:TRAN:TRA:AUTO ON. This is the default condition. Use :PULS:TRAN:TRA:AUTO OFF to enable independent programming of the trailing-edge within a 1:20 ratio for the ranges shown in Figure 6-1.
Description	Use this command to set/read the transition-time of the pulse leading-edge. Note that the leading and trailing edges of the pulse have to fit within the defined pulse-width.

Example

<code>OUTPUT 710;":PULS:TRAN1 3NS"</code>	<i>Set OUTPUT 1 lead- ing edge to 3 ns</i>
<code>OUTPUT 710;":PULS:TRAN1:TRA:AUTO OFF"</code>	<i>Enable independent setting of trailing- edge</i>
<code>OUTPUT 710;":PULS:TRAN1:TRA 15NS"</code>	<i>Set OUTPUT 1 trail- ing edge to 15 ns</i>

[:SOURce]:PULSe:TRANSition[1|2]:TRAILing

Form	Set & Query
Parameter	Numeric
Parameter suffix	S with engineering prefixes, or PCT
*RST value	2.00 ns
Specified limits	2.00 ns to 200 ms
Parameter coupling	Trailing-edge = Leading-edge with :PULS:TRAN:TRA:AUTO ON. This is the default condition. Use :PULS:TRAN:TRA:AUTO OFF to enable independent programming of the trailing-edge within a 1:20 ratio for the ranges shown in Figure 6-1.
Description	Use this command to set/read the transition-time of the pulse trailing-edge. Note that the leading and trailing edges of the pulse have to fit within the defined pulse-width.

Example

OUTPUT 710;":PULS:TRAN1 3NS"	<i>Set OUTPUT 1 lead- ing edge to 3 ns</i>
OUTPUT 710;":PULS:TRAN1:TRA:AUTO OFF"	<i>Enable independent setting of trailing- edge</i>
OUTPUT 710;":PULS:TRAN1:TRA 15NS"	<i>Set OUTPUT 1 trail- ing edge to 15 ns</i>

[[:SOURce]:PULSe:TRANSition[1|2]:TRAILing:AUTO

Form Set & Query

Parameter ON|OFF|ONCE

***RST value** ON

Description Use this command to set/read the automatic coupling of the pulse trailing-edge transition-time to the leading-edge transition-time.

ON The trailing-edge transition time is automatically set to the same value as the leading-edge, and is updated automatically each time the leading-edge transition-time changes.

OFF The trailing-edge transition time is independently programmable.

ONCE The trailing-edge transition time is set ONCE to the same value as the leading-edge.

Example

OUTPUT 710;":PULS:TRAN1 3NS"	<i>Set OUTPUT 1 leading edge to 3 ns</i>
OUTPUT 710;":PULS:TRAN1:TRA:AUTO OFF"	<i>Enable independent setting of trailing-edge</i>
OUTPUT 710;":PULS:TRAN1:TRA 15NS"	<i>Set OUTPUT 1 trailing edge to 15 ns</i>

[:SOURce]:PULSe:TRIGger[1|2]:VOLTage

Form	Set & Query
Parameter	TTL ECL
*RST value	TTL
Description	Use this command to set/read the output levels at the TRIGGER OUT connector.

4

[[:SOURce]:PULSe:WIDTh[1|2]

Form Set & Query

Parameter Numeric

Parameter suffix S with engineering prefixes

***RST value** 100 ns

Specified limits 3.30 ns to 999 ms (Maximum = Period – 3.3 ns)

Description Use this command to program the width of the pulse signal. If you want to set width as dutycycle use [[:SOURce]:PULSe:DCYClE[1|2]].

If you want the pulse-width to remain constant when the pulse-period is varied (rather than the dutycycle) use [[:SOURce]:PULSe:HOLD[1|2] WIDTh

Example

OUTPUT 710;":PULS:WIDT1 50NS" *Set OUTPUT 1 pulse-width to 50 ns*

OUTPUT 710;":PULS:HOLD1 WIDT" *Hold pulse-width constant with varying period*

[:SOURce]:ROSCillator:SOURce

Form	Set & Query
Parameter	INTernal EXTernal
*RST value	INT
Description	Use this command to set/read the reference source for the HP 81106A PLL. If you select the external reference (CLK IN connector) you can choose to use a 5 MHz or 10 MHz reference signal using :ROSC:EXT:FREQ.
	INTernal Lock the PLL to its internal reference
	EXTernal Lock the PLL to a reference signal at the CLK IN connector. The external reference signal can be 5 or 10 MHz.

4

Example

OUTPUT 710;":ROSC:SOUR EXT"	<i>Set external PLL reference (CLK IN)</i>
OUTPUT 710;":ROSC:EXT:FREQ 10MHZ"	<i>Set expected PLL reference frequency to 10 MHz</i>

[:SOURce]:ROSCillator:EXTernal:FREQuency

Form	Set & Query
Parameter	Numeric
*RST value	5 MHz
Specified limits	5 MHz or 10 MHz
Description	Use this command to set/read the expected reference frequency for the HP 81106A PLL at the CLK IN connector. The external reference can be a 5 or 10 MHz signal. Note that if you program any value other than the two specified values, the value will be set to the nearest of the two specified values.

Example

<code>OUTPUT 710;":ROSC:SOUR EXT"</code>	<i>Set external PLL reference (CLK IN)</i>
<code>OUTPUT 710;":ROSC:EXT:FREQ 10MHZ"</code>	<i>Set expected PLL reference frequency to 10 MHz</i>

[:SOURce]:VOLTage[1|2][:LEVel][:IMMediate][:AMPLitude]

Form	Set & Query
Parameter	Numeric
Parameter suffix	V with engineering prefixes.
Value coupling	$High = Offset + \frac{Amplitude}{2}$ $Low = Offset - \frac{Amplitude}{2}$
Range coupling	Offset
*RST value	1.00 V
Specified limits	100 mV to 10.0 V (50Ω into 50Ω)
Description	<p>This command programs the amplitude voltage of the OUTPUT signal. Note that to set the OUTPUT levels in terms of voltage, you first have to execute the [:SOURce]:HOLD VOLTage command to enable the [:SOURce]:VOLTage subsystem.</p> <p>The available voltage range is limited by the combination of:</p> <ul style="list-style-type: none"> ■ Specified Current limits ■ Actual OUTPUT Impedance setting :OUTPut:IMPedance ■ Actual Expected Load impedance setting :OUTPut:IMPedance:EXTernal
Example	<pre>OUTPUT 710;" :HOLD VOLT" Enable VOLTAGE subsystem OUTPUT 710;" :VOLT1 5V" Set OUTPUT 1 amplitude to 5 V</pre>

[[:SOURce]:VOLTage[1|2][[:LEVel][[:IMMediate]:OFFSet

Form Set & Query

Parameter Numeric

Parameter suffix V with engineering prefixes.

Value coupling $High = Offset + \frac{Amplitude}{2}$
 $Low = Offset - \frac{Amplitude}{2}$

Range coupling Amplitude

***RST value** 0.0 mV

Description This command programs the offset voltage of the OUTPUT signal. Note that to set the OUTPUT levels in terms of voltage, you first have to execute the [[:SOURce]:HOLD VOLTage command to enable the [[:SOURce]:VOLTage subsystem.

The available voltage range is limited by the combination of:

- Specified current limits
- Actual OUTPUT Impedance setting :OUTPut:IMPedance
- Actual Expected Load impedance setting :OUTPut:IMPedance:EXTernal

Example

OUTPUT 710;":HOLD VOLT"	<i>Enable VOLTAGE subsystem</i>
OUTPUT 710;":VOLT1:OFF -800MV"	<i>Set OUTPUT 1 offset to -800 mV</i>

[:SOURce]:VOLTage[1|2][:LEVel][:IMMediate]:HIGH

Form	Set & Query
Parameter	Numeric
Parameter suffix	V with engineering prefixes.
Value coupling	$\text{Amplitude} = \text{High} - \text{Low}$ $\text{Offset} = \frac{\text{High} - \text{Low}}{2}$
Range coupling	Low-level
*RST value	500 mV
Specified limits	-9.90 V to 10.0 V (50Ω into 50Ω)
Description	<p>This command programs the High-level voltage of the OUTPUT signal. Note that to set the OUTPUT levels in terms of voltage, you first have to execute the [:SOURce]:HOLD VOLTage command to enable the [:SOURce]:VOLTage subsystem.</p> <p>The available voltage range is limited by the combination of:</p> <ul style="list-style-type: none"> ■ Specified current limits ■ Actual OUTPUT Impedance setting :OUTPut:IMPedance ■ Actual Expected Load impedance setting :OUTPut:IMPedance:EXTErnal

[[:SOURce]:VOLTage[1|2][:LEVel][:IMMediate]:HIGH

Example

OUTPUT 710;":HOLD VOLT"	<i>Enable VOLTAGE subsystem</i>
OUTPUT 710;":VOLT1:HIGH 4.8V"	<i>Set OUTPUT 1 High-level to 4.8 V</i>

4

[:SOURce]:VOLTage[1|2][:LEVel][:IMMEDIATE]:LOW

Form	Set & Query
Parameter	Numeric
Parameter suffix	V with engineering prefixes.
Value coupling	$\text{Amplitude} = \text{High} - \text{Low}$ $\text{Offset} = \frac{\text{High} - \text{Low}}{2}$
Range coupling	High-level
*RST value	-500 mV
Specified limits	-10.0 V to 9.90 V (50Ω into 50Ω)
Description	<p>This command programs the Low-level voltage of the OUTPUT signal. Note that to set the OUTPUT levels in terms of voltage, you first have to execute the [:SOURce]:HOLD VOLTage command to enable the [:SOURce]:VOLTage subsystem.</p> <p>The available voltage range is limited by the combination of:</p> <ul style="list-style-type: none"> ■ Specified current limits ■ Actual OUTPUT Impedance setting :OUTPut:IMPedance ■ Actual Expected Load impedance setting :OUTPut:IMPedance:EXTernal
Example	<pre>OUTPUT 710;" :HOLD VOLT" <i>Enable VOLTAGE subsystem</i> OUTPUT 710;" :VOLT1:LOW 500MV" <i>Set OUTPUT 1 Low-level to 500 mV</i></pre>

[:SOURce]:VOLTage[1|2]:LIMit[:HIGH]

Form Set & Query

***RST value** +500 mV

Description Use this command to set/read the High-level voltage limit. If you switch on voltage limiting, the High-level voltage cannot be set above the programmed limit. Note that the voltage is *NOT* limited by the OUTPUT hardware, this is a software limit.

Example

<code>OUTPUT 710;":HOLD VOLT"</code>	<i>Enable VOLTAGE subsystem</i>
<code>OUTPUT 710;":VOLT1:LIM 3V"</code>	<i>Set OUTPUT 1 High-level voltage limit to 3 V</i>
<code>OUTPUT 710;":VOLT1:LIM:STAT ON"</code>	<i>Switch on OUTPUT 1 limits</i>

[:SOURce]:VOLTage[1|2]:LIMit:LOW**Form** Set & Query***RST value** -500 mV

Description Use this command to set/read the Low-level voltage limit. If you switch on voltage limiting, the Low-level voltage cannot be set below the programmed limit. Note that the voltage is *NOT* limited by the OUTPUT hardware, this is a software limit.

Example

OUTPUT 710;":HOLD VOLT"	<i>Enable VOLTAGE subsystem</i>
OUTPUT 710;":VOLT1:LIM:LOW 0V"	<i>Set OUTPUT 1 Low-level voltage limit to 0 V</i>
OUTPUT 710;":VOLT1:LIM:STAT ON"	<i>Switch on OUTPUT 1 limits</i>

4

[:SOURce]:VOLTage[1|2]:LIMit:STATe

Form Set & Query

Parameter ON|OFF|1|0

***RST value** OFF

Description This command switches the output limits on or off. When you switch on the output limits cannot program the output-levels beyond the programmed limits, until you switch off the voltage-limits. The limits apply whether you program High/Low levels or Amplitude/Offset levels.

Note  You can switch the limits on and off in both the [:SOURce]:CURRent and the [:SOURce]:VOLTage subsystems *but the current and voltage limits are not enabled/disabled independently*. The voltage and current limits are always enabled/disabled together.

Example

OUTPUT 710;":HOLD VOLT"	<i>Enable VOLTAGE subsystem</i>
OUTPUT 710;":VOLT1:LIM 3V"	<i>Set OUTPUT 1 High-level voltage limit to 3 V</i>
OUTPUT 710;":VOLT1:LIM:LOW 0V"	<i>Set OUTPUT 1 Low-level voltage limit to 0 V</i>
OUTPUT 710;":VOLT1:LIM:STAT ON"	<i>Switch on OUTPUT 1 limits</i>

:STATus:OPERation

This command tree accesses the OPERation status group.
*The OPERation status group is not used by the HP 8110A,
therefore this command tree is redundant.*

:STATus:OPERation[:EVENT]?

:STATus:OPERation:CONDition?

:STATus:OPERation:ENABle

:STATus:OPERation:NTRansition

:STATus:OPERation:PTRansition

4

:STATus:PRESet

Form Event

***RST value** Not Applicable

Description This command

- Clears all status group event-registers
- Clears the error queue
- Presets the status group enable-, PTR-, and NTR-registers as follows:

Status Group	Register	Preset value
OPERation	ENABle	0000000000000000
	PTR	0111111111111111
	NTR	0000000000000000
QUESTionable	ENABle	0000000000000000
	PTR	0111111111111111
	NTR	0000000000000000

4

:STATus:QUEStionable

This command tree accesses the QUEStionable status group. The QUEStionable status group contains warning bits for voltage, current, time and frequency parameters. A warning occurs when the output signal *could* be out of specification due to the combined specification uncertainties of many parameters, although all parameters are set within their individually specified limits. If a parameter is set outside its specified limits an error is generated.

The following commands are used to access the registers within the status group:

4
[Redacted]

:STATus:QUEStionable[:EVENT]?

Form	Query
*RST value	Not Applicable
Description	This command reads the event register in the QUEStionable status group.

:STATus:QUEStionable:CONDition?

Form	Query
*RST value	Not Applicable
Description	This command reads the condition register in the QUEStionable status group.

:STATus:QUEStionable:ENABle

Form	Set & Query
Parameter	Numeric
*RST value	Not affected by *RST
Specified limits	0 - 32767

:STATus:QUEStionable

Description	This command sets or queries the enable register in the QUEStionable status group.
--------------------	--

:STATus:QUEStionable:NTRansition

Form	Set & Query
-------------	-------------

Parameter	Numeric
------------------	---------

*RST value	Not Applicable
-------------------	----------------

Specified limits	0-32767
-------------------------	---------

Description	This command sets or queries the negative-transition register in the QUEStionable status group.
--------------------	---

:STATus:QUEStionable:PTRansition

Form	Set & Query
-------------	-------------

Parameter	Numeric
------------------	---------

*RST value	Not Applicable
-------------------	----------------

Specified limits	0-32767
-------------------------	---------

Description	This command sets or queries the positive-transition register in the QUEStionable status group.
--------------------	---

4

:SYSTem:CHECK[:ALL][:STATe]

Form Set & Query

Parameter ON|OFF

***RST value** Not Applicable

Description Use this command to switch the instrument's error checking on or off. Switch off the error checking if you want to improve the programming speed of the instrument, but remember that no invalid parameter or mode settings will be detected and reported.

4

Caution



Error checking cannot be switched on or off from the frontpanel. Error checking is *not* automatically re-enabled if you switch the instrument off and on again. Therefore your test programs should switch error checking on again before ending.

:SYSTEM:ERRor?

Form Query

***RST value** Not Applicable

Description Use this command to read the HP 8110A error queue. The HP 8110A error queue can store up to 30 error codes on a first-in-first-out basis. When you read the error queue, the error number and associated message are put into the instrument's output buffer.

If the queue is empty, the value 0 is returned, meaning **No Error**. If the queue overflows at any time, the last error code is discarded and replaced with -350 meaning **Queue overflow**.

4

:SYSTem:KEY

Form	Set & Query
Parameter	Numeric
Parameter suffix	No suffix allowed
*RST value	-1
Specified limits	See Table 4-11
Description	<p>In query form, this command reads the last key pressed. The buffer is emptied by *RST and returns the value -1 when empty.</p> <p>In set form, the command simulates pressing a key on the frontpanel. Simulated key-press are also recorded as the last key pressed.</p>

Note



1. :SYST:KEY 19 sets the instrument to LOCAL mode.
 2. In remote mode *only* the softkeys under the display and the **SHIFT** (LOCAL) key are active. Since the instrument normally switches to remote mode when any command is received, including :SYSTem:KEY, simulating one of the other disabled keys has no effect.
 3. If you want to simulate full frontpanel operation, you must prevent the instrument from entering remote mode by using the REN line of the HP-IB to maintain local mode (LOCAL 7 in BASIC).
- If you do this, the :SYSTem:KEY command is the only command which works. Any other commands will be buffered in the HP 8110A, blocking any further :SYSTem:KEY commands, until remote mode is enabled.

Table 4-11. :SYSTem:KEY parameter reference

No.	Key Description	No.	Key Description
-1	No key pressed (Query only)	15	CURSOR (⇒)
0	DATA ENTRY (0)	16	(MAN)
1	DATA ENTRY (1)	17	(STORE)
2	DATA ENTRY (2)	18	(HELP)
3	DATA ENTRY (3)	19	(SHIFT)
4	DATA ENTRY (4)	20	(MORE)
5	DATA ENTRY (5)	21	Softkey 1 (LEFT)
6	DATA ENTRY (6)	22	Softkey 2
7	DATA ENTRY (7)	23	Softkey 3
8	DATA ENTRY (8)	24	Softkey 4 (RIGHT)
9	DATA ENTRY (9)	25	DATA ENTRY (nano)
10	DATA ENTRY (.)	26	DATA ENTRY (micro\Mega)
11	DATA ENTRY (±)	27	DATA ENTRY (milli\kilo)
12	CURSOR (↑)	28	DATA ENTRY (ENTER)
13	CURSOR (↓)	29	MODIFY Knob left (anticlockwise)
14	CURSOR (←)	30	MODIFY Knob right (clockwise)

4

:SYSTem:PRESet

No function.

:SYSTEM:SECURITY[:STATE]

Form Set & Query

Parameter ON|OFF

***RST value** OFF

Description

Caution



Do not switch on system security unless you are willing to erase the instrument settings stored in the instrument. All instrument memories, including the current setting, will be overwritten with the default settings if you

- Switch off system security
- Switch the instrument off and on again

If you accidentally switch on system security, and want to rescue the settings stored in the instrument, store the settings on a memory card. You can then recall them from the memory card later.

Use this command to switch on system security mode. Switch on system security if you need to make sure that all instrument settings stored in the instrument are erased automatically when the instrument is switched off, or when security mode is switched off..

The instrument settings are erased by overwriting them with the default settings.

System security mode is not available via the frontpanel. If you want to erase all settings by hand:

1. **SHIFT** **STORE** **0** to RECALL the default settings from memory 0.
2. **STORE** **1**, **STORE** **2**, ... , **STORE** **9** to store the defaults in memories 1 to 9.

:SYSTem:SET

Form Set & Query

Parameter Block data

***RST value** Not applicable

Description In query form, the command reads a block of data containing the instrument's complete set-up. The set-up information includes all parameter and mode settings, but does not include the contents of the instrument setting memories, the status group registers or the :DISPlay[:WINDow] [:STATe] The data is in a binary format, not ASCII, and cannot be edited.

4

In set form, the block data must be a complete instrument set-up read using the query form of the command.

:SYSTem:VERSion?

Form. Query

***RST value** "1992.0"

Description This command reads the SCPI revision to which the instrument complies.

4

:SYSTem:WARNIng[:COUNT]?

Form Query

***RST value** Not applicable

Description Use this command to read the number of warnings which are currently active. Note that the warning status of voltage, current, time and frequency are also summarised by bits in the QUESTionable Status register.

4

:SYSTem:WARNing:STRing?

Form. Query

***RST value** Not applicable

Description Use this command to read all the currently active warning messages. The warning messages are concatenated to form a single string with a ; as separator between the messages.

4

:SYSTem:WARNing:BUFFer?

Form Query

***RST value** Not applicable

Description Use this command to read the maximum possible number of characters which could be returned by :SYST:WARN:STR? if all warnings were active.

4

:TRIGger:COUNT

Form Set & Query

Parameter Numeric

***RST value** 2

Specified limits :DIG:PATT OFF: 1 to 65536
:DIG:PATT ON: 2 to 4096

Description Use this command to set/read the number of trigger events (pulse-periods) to be generated for each arming event. This corresponds to selecting the event mode on the TRG-MODE screen:

PULSES Set a trigger count of 1 so that a single pulse-period is generated for each arming event.

BURST of Set a trigger count of 2 to 65536 so that a burst of 2 to 65536 pulse-periods is generated for each arming event. Switch off pattern mode so that a pulse (or double-pulse) is generated in each pulse-period. (:DIG:PATT OFF)

PATTERN of Set a trigger count of 2 to 4096 so that a burst of 2 to 4096 pulse-periods is generated for each arming event. Switch on pattern mode so that the pattern memory is used to generate the pulses. (:DIG:PATT ON)

Examples

To set CONTINUOUS PATTERN of NRZ--Pulses at Out1, with a 512 bit pattern length:

OUTPUT 710;":ARM:SOUR IMM"	<i>Set CONTINUOUS arming</i>
OUTPUT 710;":TRIG:COUN 512"	<i>Pattern length 512</i>
OUTPUT 710;":TRIG:SOUR INT1	<i>Pulse-period trigger from internal osc.</i>
OUTPUT 710;":DIG:PATT ON	<i>Enable pattern data</i>
OUTPUT 710;":DIG:SIGN1:FORM NRZ	<i>Set OUTPUT 1 data to NRZ</i>

To set TRIGGERED BURST of 16 Single-Pulses at Out1, each burst triggered by a positive edge at the EXT INPUT:

OUTPUT 710;":ARM:SOUR EXT1"	<i>Set arming from EXT INPUT</i>
OUTPUT 710;":ARM:SENS EDGE"	<i>Set arming on edges</i>
OUTPUT 710;":ARM:SLOP POS"	<i>Set arming on positive edges</i>
OUTPUT 710;":TRIG:COUN 16"	<i>Burst length 16</i>
OUTPUT 710;":TRIG:SOUR INT1	<i>Pulse-period trigger from internal osc.</i>
OUTPUT 710;":DIG:PATT OFF	<i>Disable pattern data</i>
OUTPUT 710;":PULS:DOUB1 OFF	<i>Ensure single pulses at OUTPUT 1</i>

To set GATED PULSES Single-Pulses at Out1, gated by a positive level at the EXT INPUT:

OUTPUT 710;":ARM:SOUR EXT1"	<i>Set arming from EXT INPUT</i>
OUTPUT 710;":ARM:SENS LEV"	<i>Set arming on levels</i>
OUTPUT 710;":ARM:SLOP POS"	<i>Set arming on positive level</i>
OUTPUT 710;":TRIG:COUN 1"	<i>1 pulse-period</i>
OUTPUT 710;":TRIG:SOUR INT1	<i>Pulse-period trigger from internal osc.</i>
OUTPUT 710;":DIG:PATT OFF	<i>Disable pattern data</i>
OUTPUT 710;":PULS:DOUB1 OFF	<i>Ensure single pulses at OUTPUT 1</i>

:TRIGger:IMPedance

Form Set & Query

Parameter Numeric

Parameter Suffix OHM with engineering prefixes, or MOHM is Megaohms.

***RST value** 50 Ω

Specified Limits 50 Ω or 1 k Ω

Description Use this command to program the input impedance of the HP 81106A CLK IN connector. Note that only two settings are available. If you try to program any other value, it will be rounded to one of the specified values.

Example

OUTPUT 710;":TRIG:IMP 50OHM" *Set CLK IN impedance to 50 Ω*
OUTPUT 710;":TRIG:LEV 2.5V" *Set CLK IN threshold to 2.5 V*
OUTPUT 710;":TRIG:SOUR EXT2 *Pulse-period trigger from CLK IN*

:TRIGger:LEVel

Form	Set & Query
Parameter	Numeric
Parameter Suffix	V with engineering prefixes.
*RST value	1.0 V
Specified Limits	-10 V to +10 V
Description	Use this command to program the triggering threshold of the CLK IN connector.
Example	<pre>OUTPUT 710;":TRIG:IMP 500HM" <i>Set CLK IN impedance to 50 Ω</i> OUTPUT 710;":TRIG:LEV 2.5V" <i>Set CLK IN threshold to 2.5 V</i></pre>

4

:TRIGger:SLOPe

Form Set & Query

Parameter POSitive|NEGative

***RST value** POS

Description Use this command to select the trigger slope for the pulse-period triggering signal applied to the CLK IN connector.

4

:TRIGger:SOURce

- Form** Set & Query
- Parameter** IMMEDIATE|INTERNAL1|INTERNAL2|EXTERNAL2
- *RST' value** IMM
- Description** Use this command to select the pulse-period source of the HP 8110A by selecting the source of the pulse-period trigger signal:

4

Table 4-12.
Pulse-period sources set by :TRIG:SOUR

Pulse-period source	:TRIG:SOURce
internal osc.	IMMEDIATE INTERNAL1
HP 81106A PLL	INTERNAL2
HP 81106A CLK IN	EXTERNAL2

Default Values

Default Values, standard settings

Table 4-13. HP 8110A Default Values

Parameter	*RST, Default Values
:ARM :EWIDTH :STATE :FREQUENCY :IMPEDANCE :LEVEL :PERIOD :SENSE :SLOPE :SOURCE	OFF 100kHz 50Ω + 1.00V 10.00μs EDGE POS IMMEDIATE
:CHANNEL :MATH	OFF
:DIG [:STIMULUS] :PATTERN :DATA[1 2 3] :PRBS[1 2 3] :PRESET[1 2 3] [:STATE] :UPDATE :SIGNAL[1 2] :FORMAT	Ch1 Bit1 = 1, Bit2 to 4096 = 0 Ch2 Bit1 = 0, Bit2 = 1, Bit3 to 4096 = 0 Strobe Bit1 = 1, Bit2 to 4096 = 0 not applicable not applicable OFF ON EZ
:DISPLAY [:WINDOW] [:STATE]	ON
:MEMORY :CATALOG? :DIRECTORY :COPY :DELETE :INITIALIZE :LOAD :STATE :STORE :STATE	not applicable not applicable not applicable not applicable not applicable not applicable not applicable

Table 4-13. HP 8110A Default Values (continued)

Parameter	*RST, Default Values
:OUTPut[1 2] [:STATe]	OFF
:IMPedance [:INTernal]	50Ω
:EXTernal	50.0Ω
:POLarity	NORMal
[:SOURce] :CORRection[1 2] :EDELay [:TIME]	0
:CURRent[1 2] [:LEVel] [:IMM] [:AMPL]	20.0mA (from 500into 500)
:OFFSet	0.0mA (from 500into 500)
:HIGH	+10.0mA from(50 Ωinto 500)
:LOW	-10.0mA (from 500into 500)
:LIMit [:HIGH]	+10.0mA
:LOW	-10.0mA
:STATe	OFF
:FREQ [:CW :FIXed]	1.00MHz
:AUTO	not applicable
:HOLD	VOLT
:PHASe[1 2] [:ADJust]	0.0
:PULSe :DCYCLe[1 2]	10.0% (derived from Width and Period)
:DELay[1 2]	0.0
:HOLD	TIME
:UNIT	S
:DOUBLE[1 2] [:STATe]	OFF
:DELay	0.0
:HOLD	TIME
:UNIT	S
:HOLD[1 2]	WIDTh

4

Default Values

Table 4-13. HP 8110A Default Values (continued)

Parameter	*RST, Default Values
[:SOURce] :PULSe :PERiod	1 μ s
:AUTO	not applicable
:Trailing DELay[1 2]	100ns
:TRANsition[1 2] :HOLD	TIME
:UNIT	S
[:LEADing]	2.0ns
:TRAILing	2.0ns
:AUTO	ON
:TRIGger[1 2] :VOLTage	TTL
:WIDTh[1 2]	100ns
:ROSCillator :SOURce	INTernal
:EXTernal :FREQ	5MHz
:VOLTage[1 2] [:LEVel] [IMMediate] [:AMPLitude]	1.0V
:OFFset	0.0mV
:HIGH	500mV
:LOW	-500mV
LIMit[:HIGH]	+500mV
:LOW	-500mV
:STATe	OFF

4

Table 4-13.
HP 8110A Default Values (continued)

Parameter	*RST, Default Values
:STATUS :OPERation	not applicable
:PRESet	not applicable
:QUEStionable [:EVENT]?	not applicable
:CONDition?	not applicable
:ENABle	not affected
:NTRansition	not applicable
:PTRansition	not applicable
:SYSTem :CHECK [:ALL] [:STATe]	not applicable
:ERRor?	not applicable
:KEY	-1
:PRESet	not applicable
:SECurity [:STATe]	OFF
:SET	not applicable
:VERSion	"1992.0"
:WARNing [:COUNt]?	not applicable
:STRing?	not applicable
:BUFFer?	not applicable
:TRIGger :COUNt	2
:IMPedance	50Ω
:LEVel	1.0V
:SLOPe	POSitive
:SOURce	IMMediate

4

Testing the HP 8110A

Introduction

Use the tests in this chapter if you want to check that the HP 8110A 150MHz Pulse Generator is working correctly. Before starting any testing allow all test equipment to warm up for at least 30 minutes.

Conventions Used

When referring to actions that you perform during the tests, the following conventions are used:

FUNCTION

This indicates that a labelled button must be pressed

TRG MODE

This shows that a soft-key must be pressed. A soft-key is an unlabelled button whose label is shown on the display, and which can vary according to the job that the button is doing

CONTINUOUS PULSES

This is an option shown on the display, and is selected by use of the vernier keys. It is shown in upper or lower case to match the case displayed.

Test Results Tables

Tables for entering the results of the tests are included at the end of this chapter. The tests are numbered and reference numbers for each Test Result (TR) are given in a small table at the end of each test. The reference number shows you where the actual results should be entered in the Test Results Tables.

The Test Results tables at the end of the chapter should be photocopied, and the Test Results entered on the copies. Then, if the tests need to be repeated, the tables can be copied again.

If Channel 2 has been fitted to your instrument, make an extra copy of the Test Results tables for entry of the results of tests on that channel. In this case, however, it is not necessary to repeat the Period tests, as these are common to both channels.

Recommended Test Equipment and Accessories

The following tables list the recommended test equipment you need to perform all the tests in this chapter. You can use alternative instruments if they meet the critical specifications given. The test set-ups and procedures assume you are using the recommended equipment.

Table 5-1. Recommended Test Equipment List

Test Equipment	Model	Critical Specifications
Oscilloscope	HP 54121T	20 GHz, 10 bit vertical resolution, Histogram capability
Counter	HP 5334B	Period and Time Interval measurements
Counter	HP 5335A	Frequency measurements > 150 MHz
Digital Voltmeter	HP 3458A	DCV up to 20 V
Pulse Generator	HP 8112A	50 MHz
Delay line	HP 54008A	22 ns

5

Table 5-2. Recommended Accessories

Accessories	Model	Critical Specifications
Digitizing Oscilloscopes Accessories		
Attenuators	HP 33340C#020	20 dB
	HP 33340C#006	6 dB
Power Splitter	HP 11667B	
SMA/SMA (m-m) adaptor	1250-1159	
SMA/BNC Adaptor	1250-1700	
SMA Cable	8120-4948	
50 Ω Feedthrough Termination		
	HP 10100C	2 W,1%
	See Figure 5-1	10 W,0.1%
Adapter	1251-2277	BNC to Banana
Cable Assemblies, BNC	8120-1839	
Torque Wrench	8710-1582	5/16 in, 5 lb-in (56 Ncm)

Note



When you connect the test equipment for the first time, and whenever you change the setup during the course of these tests, use the 8710 - 1582 torque wrench to tighten and loosen SMA connectors. This will ensure that the connectors are at the correct tightness and give the best signal transfer.

5

50 Ohm, 0.1%, 10 W Feedthrough Termination

The following figure provides a schematic and a parts list except for the case. The case must provide shielding and maintain grounding integrity.

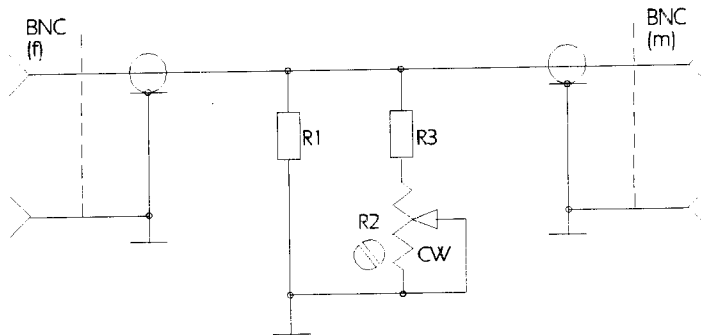

Figure 5-1.

50 Ohm, 0.1%, 10 W Feedthrough Termination

The following parts are required:

1. R1 = 53.6 Ω , 1%, 10 W; HP Part Number: 0699-0146.
2. R2 = 200 Ω , 10%, 0.5 W, Variable trimmer; HP Part Number: 2100-3350.
3. R3 = 681 Ω , 1%, 0.5 W; HP Part Number: 0757-0816.
4. BNC (M): HP Part Number: 1250-0045.
5. BNC (F): HP Part Number: 1250-0083.

Getting Started

The HP 8110A is controlled by selecting options in a series of **pages** that are displayed on the instrument's screen. These options vary with the boards that are fitted in the instrument. When the HP 8110A is being tested, therefore, different situations can arise, depending on whether you have a standard instrument or one that has had additional boards fitted. The following examples illustrate this

Typical Examples of Displayed Screens

Figure 5-2 shows the TRG MODE (Trigger Mode) screen of an instrument that has a full complement of PC boards, including a PLL Board and an Output 2 Board.

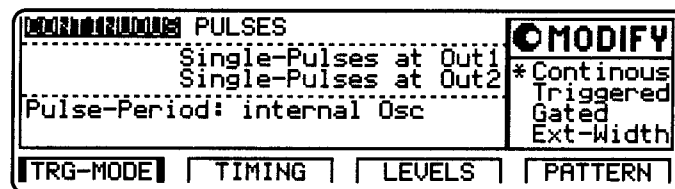

5

Figure 5-2.
The TRG MODE Screen Display in a Fully Fitted HP 8110A

Figure 5-3 shows the TRG MODE screen of a standard instrument.

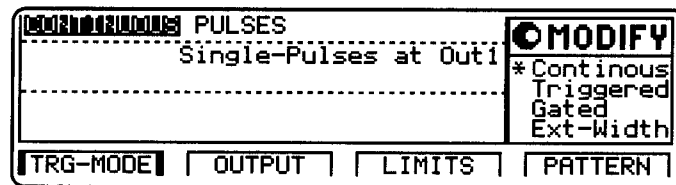

Figure 5-3.
The TRG MODE Screen Display in a Standard HP 8110A

Figure 5-4 shows the TRG MODE screen of a fully-fitted instrument where manual triggering has been selected.

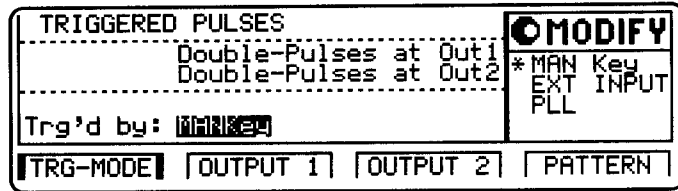

Figure 5-4.
The TRG MODE Screen With Manual Triggering in a Fully-Fitted HP 8110A

Figure 5-5 shows the TRG MODE screen of a standard instrument where manual triggering has been selected.

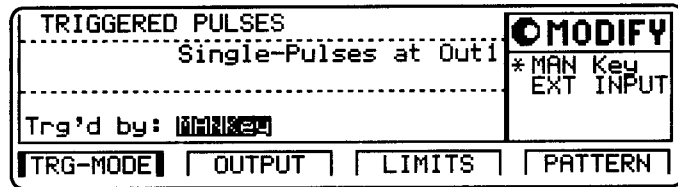

Figure 5-5.
The TRG MODE Screen With Manual Triggering in a Standard HP 8110A

Figure 5-6 shows the OUTPUT screen of a standard instrument.

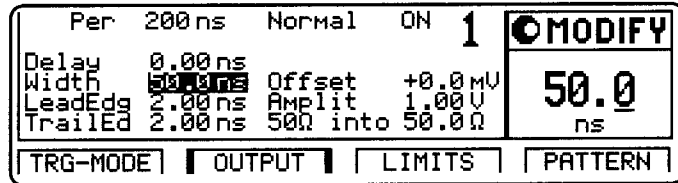

Figure 5-6.
The Output Screen in a Standard HP 8110A

Instrument Serial Numbers

You will need to write the serial numbers of the instrument and its boards at the top of the Test Reports. These can be found as follows:

Press **HELP**, **MORE**, **SERIAL #**

The HP 8110A display lists the instrument's product and serial numbers.

The display on your instrument should look similar to this:

	Prod.Nr.	Serial Nr.
FRAME	8110A	3236G00153
CH1-Bd.	81103A	3233G00135
CH2-Bd.	81103A	3304G00216
PLL-Bd.	81106A	3237G00184
DSK-Bd.	81107A	3308G00173

The number given for the FRAME applies to the Mainframe, the Power Supply, the Microprocessor Board, and the Period Board. The serial number is available on the Period Board.

5

Initial Setup of the HP 8110A

In the majority of these tests the initial setting up of the instrument is identical. Therefore, it is described once here, and then referred-to where appropriate. In cases where the initial setup differs, an illustration of the settings is shown.

Set up the HP 8110A as follows:

1. Select **TRG-MODE**
 - CONTINUOUS PULSES
 - Single-Pulses at Out 1 (plus Single-Pulses at Out 2, if second channel is installed)

If PLL (HP 81106A) is fitted, set:

- Pulse-Period: internal Osc

2. If a second output channel is installed, select **MORE** CONFIG screen and set up as follows:

HP-IB Address: 22	MODIFY
Perform Selftest: All	Tim/Lev
Group Params by: OUTPUT 1 / 2	*Out 1/2
PLL-Ref : Internal	
Deskew 1: 0.00ns 2: 0.00ns	
LIMITS	TRG-LEV
MEMCARD	CONFIG

Figure 5-7.

CONFIG Screen, Parameters grouped by OUTPUT

Note



Set-ups are given in all the tests for OUTPUT 1 and OUTPUT 2. If you are testing a single channel instrument set up the OUTPUT screen with the settings given for OUTPUT 1.

Test 1: Period

Test Specifications	Range	6.65 ns to 999 ms
	Resolution	3 digits, best case 10 ps
	Accuracy	$\pm 5\% \pm 100$ ps
	RMS-Jitter	0.03% + 25 ps (0.05% + 25 ps in the range 50 ns to 100 ns)

Equipment Needed	Digitizing Oscilloscope with Accessories
	Counter
	Cable, 50 Ω , coaxial, BNC

- Procedure**
1. Connect the HP 8110A to the digitizing oscilloscope as shown:

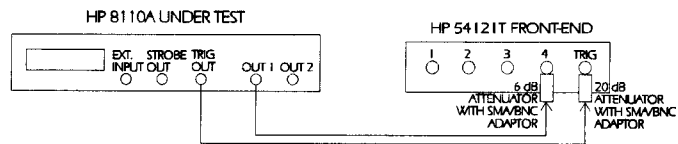

Connecting the HP 8110A to the Scope

2. Set up the HP 8110A as described in "Initial Setup of the HP 8110A"

3. On the HP 8110A press **(MORE)** and set up OUTPUT 1 and OUTPUT 2 pages as shown in the following illustrations:

Per	5.00ns	Normal	ON	1	MODIFY
Delay	0.00ns				6.65 ns
DutyCyc	50.0%	Offset	+0.0mV		
LeadEdg	2.00ns	Amplit	1.00V		
TrailEd	2.00ns	50Ω into	50.0Ω		
TRG-MODE OUTPUT 1 OUTPUT 2 PATTERN					

Configuring Output 1

Per	5.00ns	Normal	OFF	2	MODIFY
Delay	0.00ns	Separate	Out2		6.65 ns
DutyCyc	50.0%	Offset	+0.0mV		
LeadEdg	2.00ns	Amplit	1.00V		
TrailEd	2.00ns	50Ω into	50.0Ω		
TRG-MODE OUTPUT 1 OUTPUT 2 PATTERN					

Configuring Output 2

Note



When you are testing instruments with 2 output channels it is necessary to:

- a. Configure *both* channels.
- b. Switch OFF the channel that is not being tested

If you then test the other channel:

- c. Switch ON the channel you are testing, and switch OFF the other channel.

4. Set the Digitizing Oscilloscope HP 54121T:

- Press **(AUTOSCALE)**
- Select the Display menu and set the Number of Averages to 32
- Press **(MORE)** key
- Press **(MEASURE)**key
- Press **(PERIOD)** key

5. Check the HP 8110A pulse period at the following settings:

**Table 5-3.
Period Settings and TR Reference**

Oscilloscope Timebase	Period	Acceptable Range	TR entry
1 ns/div	6.65 ns	6.2175 ns to 7.0825 ns	1 - 1
2 ns/div	9.99 ns	9.390 ns to 10.589 ns	1 - 2
2 ns/div	10.0 ns	9.4 ns to 10.6 ns	1 - 3
10 ns/div	50.0 ns	47.4 ns to 52.6 ns	1 - 4
20 ns/div	99.9 ns	94.805 ns to 104.995 ns	1 - 5

6. Connect the HP 8110A to the Counter as follows:

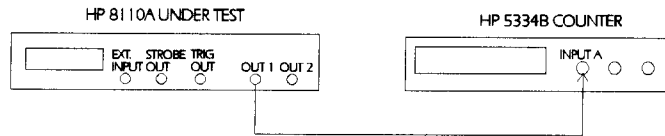

Connecting HP 8110A to the Counter

7. Set the Counter to:

FUNCTION	Period A
INPUT A	50 Ω
SENSE	On

8. Check the HP 8110A period at the following settings:

Table 5-4.
Period Settings and TR Reference

Period	Acceptable Range	TR entry
100 ns	94.9 ns to 105.1 ns	1 - 6
500 ns	474.9 ns to 525.1 ns	1 - 7
1 μ s	949.9 ns to 1050.1 ns	1 - 8
5 μ s	4.75 μ s to 5.25 μ s	1 - 9
50 μ s	47.5 μ s to 52.5 μ s	1 - 10
500 μ s	475 μ s to 525 μ s	1 - 11
5 ms	4.75ms to 5.35 ms	1 - 12
50 ms	47.5 ms to 52.5 ms	1 - 13
500 ms	475 ms to 525 ms	1 - 14

Test 2: PLL Period

Note 

This test is only performed if HP 81106A is installed.

Test Specifications

Range	6.65 ns to 999 second
Resolution	4 digits, best case 10 ps
Accuracy	$\pm 0.1\%$
RMS-Jitter	0.003% + 20 ps

Equipment Needed

Counter HP 5335A
Cable, 50 Ω , coaxial, BNC

Note 

The HP 5335A counter is used in frequency mode to meet the MIL CAL A uncertainty requirements for TAR (Test Accuracy Ratio) > 4:1.

Procedure

1. Connect the HP 8110A to the counter as follows:

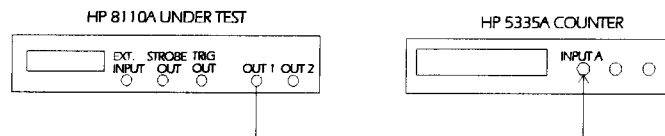

Connecting HP 8110A to the Counter

2. Set up the HP 8110A as described in "Initial Setup of the HP 8110A"

- Select the TRG-MODE screen on the HP 8110A and set up as follows:

CONTINUOUS PULSES		<input checked="" type="radio"/> MODIFY int Osc * int PLL CLK-IN
Single-Pulses at Out1		
Single-Pulses at Out2		
Pulse-Period: internal PLL		
TRG-MODE	OUTPUT 1	OUTPUT 2
PATTERN		

The TRG MODE Screen Setup

- On the HP 8110A set up OUTPUT 1 and OUTPUT 2 pages as shown in the following illustrations:

5

Per 6.650ns	Normal	ON	1	<input checked="" type="radio"/> MODIFY 6.650 ns
Delay 0.00ns				
DutyCyc 50.0%	Offset +0.0mV			
LeadEdg 2.00ns	Amplit 1.00V			
Trailed 2.00ns	50Ω into 50.0Ω			
TRG-MODE	OUTPUT 1	OUTPUT 2	PATTERN	

Configuring Output Screen 1

Per 6.650ns	Normal	OFF	2	<input checked="" type="radio"/> MODIFY 6.650 ns
Delay 0.00ns	Separate Out2			
DutyCyc 50.0%	Offset +0.0mV			
LeadEdg 2.00ns	Amplit 1.00V			
Trailed 2.00ns	50Ω into 50.0Ω			
TRG-MODE	OUTPUT 1	OUTPUT 2	PATTERN	

Configuring Output Screen 2

Note



When you are testing instruments with 2 output channels it is necessary to:

- a. Configure *both* channels.
- b. Switch OFF the channel that is not being tested

If you then test the other channel:

- c. Switch ON the channel you want to test, and switch OFF the other channel.

5. Set the Counter to:

FUNCTION Frequency A
 INPUT A 50 Ω
 SENSE On

6. Check the HP 8110A PLL pulse period at the following settings:

5

**Table 5-5.
 PLL Period Settings and TR Reference**

Period	Frequency	Acceptable Range	TR Entry
6.650 ns	150.3759 MHz	150.2257 MHz to 150.5264 MHz	2 - 1
9.999 ns	100.0100 MHz	99.910 MHz to 100.110 MHz	2 - 2
10.00 ns	100 MHz	99.900 MHz to 100.100 MHz	2 - 3
50.00 ns	20 MHz	19.980 MHz to 20.020 MHz	2 - 4
99.99 ns	10.0010 MHz	9.991 MHz to 10.001 MHz	2 - 5
100 ns	10 MHz	9.990 MHz to 10.010 MHz	2 - 6
500 ns	2 MHz	1.998 MHz to 2.002 MHz	2 - 7
1 μs	1 MHz	999 kHz to 1.001 MHz	2 - 8
5 μs	200 kHz	199.800 kHz to 200.200 kHz	2 - 9
50 μs	20 kHz	19.980 kHz to 20.020 kHz	2 - 10
500 μs	2 kHz	1.998 kHz to 2.002 kHz	2 - 11
5 ms	200 Hz	199.800 Hz to 200.200 Hz	2 - 12
50 ms	20 Hz	19.980 Hz to 20.020 Hz	2 - 13
500 ms	2 Hz	1.998 Hz to 2.002 Hz	2 - 14
5 s	0.2 Hz	0.1998 Hz to 0.2002 Hz	2 - 15

Test 3: Width

Test Specifications	Range	3.30 ns to 999 ms
	Resolution	3 digits, best case 10 ps
	Accuracy	$\pm 5\% \pm 250$ ps
	RMS-Jitter	0.03% + 25 ps (0.05% + 25 ps in the range 50 ns to 100 ns)

Equipment Needed	Digitizing Oscilloscope with Accessories
	Counter
	Cable, 50 Ω , coaxial, BNC

- Procedure**
1. Connect HP 8110A to the Scope as shown:

5

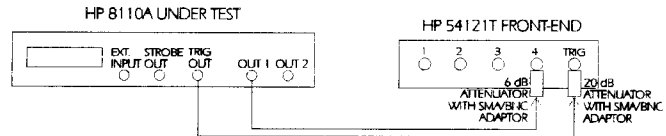

Connecting HP 8110A to the Scope

2. Set up the HP 8110A as described in "Initial Setup of the HP 8110A"

3. On the HP 8110A press **MORE** and set up **OUTPUT 1** and **OUTPUT 2** pages as shown in the following illustrations:

Per	200 ns	Normal	ON	1	MODIFY
Delay	0.00 ns				50.0 ns
Width	50.0 ns	Offset	+0.0 mV		
LeadEdg	2.00 ns	Amplit	1.00 V		
TrailEd	2.00 ns	50Ω into	50.0 Ω		
TRG-MODE OUTPUT 1 OUTPUT 2 PATTERN					

Configuring Output Screen 1

Per	200 ns	Normal	OFF	2	MODIFY
Delay	0.00 ns	Separate	Out2		50.0 ns
Width	50.0 ns	Offset	+0.0 mV		
LeadEdg	2.00 ns	Amplit	1.00 V		
TrailEd	2.00 ns	50Ω into	50.0 Ω		
TRG-MODE OUTPUT 1 OUTPUT 2 PATTERN					

Configuring Output Screen 2

Note



When you are testing instruments with 2 output channels it is necessary to:

- a. Configure *both* channels.
- b. Switch OFF the channel that is not being tested

If you then test the other channel:

- c. Switch ON the channel you are testing, and switch OFF the other channel.

4. Set the Digitizing Oscilloscope HP 54121T:

- Press **AUTOSCALE**
- Select the Display menu and set the Number of Averages to 32
- Select the delta V menu and turn the voltage markers On
- Set the preset levels to 50% -50% and press **AUTO LEVEL SET**

- Select the delta t menu and turn the time markers ON
 - Set START ON EDGE = POS 1 and STOP ON EDGE = NEG1
5. Change the oscilloscope timebase to 1 ns/div
 6. Change the HP 8110A width to 3.3 ns
 7. Center the pulse in the Scope display
 8. Press the **PRECISE EDGE FIND** key for each new Width setting
 9. Check the HP 8110A pulse width at the following settings:

**Table 5-6.
Width Settings and TR Reference**

Oscilloscope Timebase	Period	Width	Acceptable Range	TR Entry
1 ns/div	200 ns	3.30 ns	2.885 ns to 3.715 ns	3 - 1
1 ns/div	200 ns	6.60 ns	6.020 ns to 7.180 ns	3 - 2
2 ns/div	200 ns	9.99 ns	9.240 ns to 10.739 ns	3 - 3
2 ns/div	200 ns	10.0 ns	9.250 ns to 10.750 ns	3 - 4
10 ns/div	200 ns	50.0 ns	47.25 ns to 52.75 ns	3 - 5
20 ns/div	200 ns	99.9 ns	94.655 ns to 105.145 ns	3 - 6
20 ns/div	1 μ s	100 ns	94.75 ns to 105.25 ns	3 - 7
100 ns/div	1 μ s	500 ns	474.75 ns to 525.25 ns	3 - 8

10. Connect the HP 8110A to the Counter as shown:

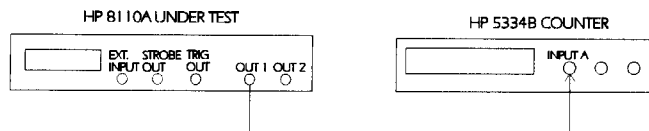

Connecting HP 8110A to the Counter

11. Set the Counter to:

FUNCTION	TI A → B
SENSE	On
INPUT A	50 Ω
COM A	On
INPUT B	50 Ω, negative slope

5

12. Check the HP 8110A width at the following settings:

Table 5-7.
Width Settings and TR Reference

Period	Width	Acceptable Range	TR Entry
100 μs	1 μs	949.75 ns to 1050.25 μs	3 - 9
100 μs	5 μs	4.75 μs to 5.25 μs	3 - 10
100 μs	50 μs	47.5 μs to 52.5 μs	3 - 11
10 ms	500 μs	475 μs to 525 μs	3 - 12
10 ms	5 ms	4.75 ms to 5.25 ms	3 - 13
999 ms	50 ms	47.5 ms to 52.5 ms	3 - 14
999 ms	500ms	475 ms to 525 ms	3 - 15

Note



Repeat the entire test for the second channel, if it is installed

Test 4: Delay

Test Specifications	Range	Fixed: typical 34.0 ns Variable: 0.00 ns to 999 ms
	Resolution	3 digits, best case 10 ps
	Accuracy	$\pm 5\% \pm 1$ ns
	RMS-Jitter	0.03% + 25 ps (0.05% + 25 ps in the range 50 ns to 100 ns)

Equipment Needed	Digitizing Oscilloscope with Accessories
	Pulse Generator
	Counter
	Cable, 50 Ω , coaxial, BNC

- Procedure** 1. Connect HP 8110A to the Scope as shown:

5

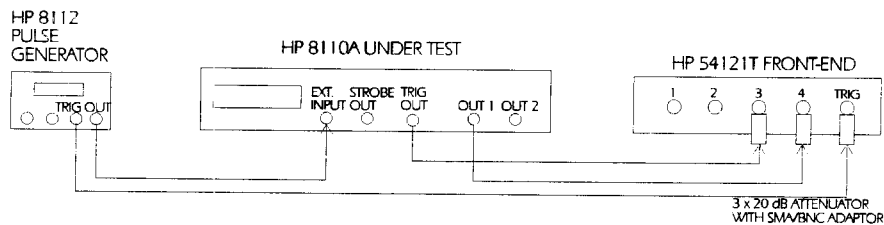

Connecting HP 8110A to the Scope

- Set up the HP 8110A as described in "Initial Setup of the HP 8110A"
- Set the Pulse Generator to:

Period	1 μ s
Width	100 ns
Amplitude	1 V
Offset	0 V
Output	Enable

- Select the **TRG-MODE** screen on the HP 8110A and set up as follows:

PULSES		MODIFY
Single-Pulses at Out1		Continuous
Single-Pulses at Out2		* Triggered
Trg'd by: EXT-IN f		Gated
		Ext-Width
TRG-MODE	OUTPUT 1	OUTPUT 2
PATTERN		

The TRG MODE Screen Setup

- On the HP 8110A set up **OUTPUT 1** and **OUTPUT 2** pages as shown in the following illustrations:

Per -----	Normal	ON	1	MODIFY
Delay	0.00 ns			0.00 ns
Width	100 ns	Offset	+0.0 mV	
LeadEdg	2.00 ns	Amplit	1.00 V	
Trailed	2.00 ns	50Ω into	50.0Ω	
TRG-MODE	OUTPUT 1	OUTPUT 2	PATTERN	

Configuring Output Screen 1

Per -----	Normal	OFF	2	MODIFY
Delay	0.00 ns	Separate	Out2	0.00 ns
Width	100 ns	Offset	+0.0 mV	
LeadEdg	2.00 ns	Amplit	1.00 V	
Trailed	2.00 ns	50Ω into	50.0Ω	
TRG-MODE	OUTPUT 1	OUTPUT 2	PATTERN	

Configuring Output Screen 2

5

Note



When you are testing instruments with 2 output channels it is necessary to:

- a. Configure *both* channels.
- b. Switch OFF the channel that is not being tested

If you then test the other channel:

- c. Switch ON the channel you are testing, and switch OFF the other channel.
-

6. Set the Digitizing Oscilloscope HP 54121T:

- Press **AUTOSCALE**
- Set timebase to TIME/DIV = 10 ns/div
- Center the positive-going edges of the two signals
- Select the Display menu and set the screen function to **single**; set the number of averages to 32
- Select the Delta V menu and turn the voltage markers ON and assign marker 1 to channel 3 and marker 2 to channel 4
- Set Preset levels to 50% - 50% and press **AUTO LEVEL SET**
- Select the Delta t menu and turn the time markers ON
- Set START ON EDGE= POS1 and STOP ON EDGE= POS 1
- Press the **PRECISE EDGE FIND** key

5

7. Check the HP 8110A delay at the following settings:

Note



Record the value of the fixed delay and subtract it from the other readings.

**Table 5-8.
Delay Settings and TR Reference**

Oscilloscope Timebase	Delay	Acceptable Range	TR Entry
10 ns/div	0.00 ns	fixed Delay	4 - 1
10 ns/div	5.00 ns	3.75 ns to 6.25 ns	4 - 2
20 ns/div	9.99 ns	8.49 ns to 11.49 ns	4 - 3
20 ns/div	50.0 ns	46.5 ns to 53.5 ns	4 - 4
50 ns/div	99.9 ns	93.905 ns to 105.895 ns	4 - 5
50 ns/div	100 ns	94 ns to 106 ns	4 - 6
200 ns/div	500 ns	474 ns to 526 ns	4 - 7

8. Connect the HP 8110A to the Counter as follows:

5

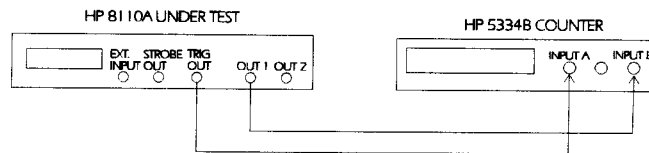

Connecting HP 8110A to the Counter

9. Set HP 8110A to Continuous-Pulses on the TRG MODE screen

10. Set the Counter to:

FUNCTION	TI A → B
SENSE	On
INPUT A	50 Ω
INPUT B	50 Ω

11. Check the HP 8110A delay at the following settings:

Note



Subtract the fixed delay from the other readings

Table 5-9.
Delay Settings and TR Reference

Period	Delay	Acceptable Range	TR Entry
100 μs	1 μs	949 ns to 1051 ns	4 - 8
100 μs	5 μs	4.749 μs to 5.251 μs	4 - 9
100 μs	50 μs	47.5 μs to 52.5 μs	4 - 10
10 ms	500 μs	475 μs to 525 μs	4 - 11
10 ms	5 ms	4.75 ms to 5.25 ms	4 - 12
999 ms	50 ms	47.5 ms to 52.5 ms	4 - 13
999 ms	500ms	475 ms to 525 ms	4 - 14

Note



Repeat the entire test for the second channel, if it is installed.

5

Test 5: Double Pulse Delay

Test Specifications	Range	6.65 ns to 999 ms
	Resolution	3 digits, best case 10 ps
	Accuracy	$\pm 5\% \pm 250$ ps

Equipment Needed	Digitizing Oscilloscope with Accessories
	Counter
	Cable, 50 Ω , coaxial, BNC

- Procedure**
1. Connect HP 8110A to the Scope as shown:

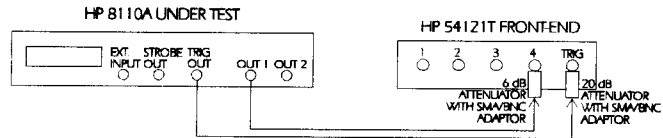

Connecting HP 8110A to the Scope

2. Set up the HP 8110A as described in "Initial Setup of the HP 8110A"

- Select the TRG-MODE screen on the HP 8110A and set up as follows:

CONTINUOUS PULSES		<input type="radio"/> MODIFY Single * Double
Double-Pulses at Out1 Double-Pulses at Out2 Pulse-Period: internal Osc		
TRG-MODE	OUTPUT 1	OUTPUT 2
PATTERN		

The TRG MODE Screen Setup

- On the HP 8110A set up OUTPUT 1 and OUTPUT 2 pages as shown in the following illustrations:

5

Per	200 ns	Normal	ON	1	<input type="radio"/> MODIFY 6.65 ns
Ob1Del	6.65 ns				
Width	3.30 ns	Offset	+0.0 mV		
LeadEdg	2.00 ns	Amplit	1.00 V		
Trailed	2.00 ns	50Ω into	50.0 Ω		
TRG-MODE	OUTPUT 1	OUTPUT 2	PATTERN		

Configuring Output Screen 1

Per	200 ns	Normal	OFF	2	<input type="radio"/> MODIFY 6.65 ns
Ob1Del	6.65 ns	Separate	Out2		
Width	3.30 ns	Offset	+0.0 mV		
LeadEdg	2.00 ns	Amplit	1.00 V		
Trailed	2.00 ns	50Ω into	50.0 Ω		
TRG-MODE	OUTPUT 1	OUTPUT 2	PATTERN		

Configuring Output Screen 2

Note



When you are testing instruments with 2 output channels it is necessary to:

- a. Configure *both* channels.
- b. Switch OFF the channel that is not being tested

If you then test the other channel:

- c. Switch ON the channel you are testing, and switch OFF the other channel.

5. Set the Digitizing Oscilloscope HP 54121T:

- Press **AUTOSCALE**
- Center the double pulse signal
- Select the Display menu and set the Number of Averages to 32
- Select the Delta V menu and turn the Voltage markers On
- Set Preset Levels = 50% -50% and press **AUTO LEVEL SET**
- Select the Delta t menu and turn the Time markers On
- Set START ON EDGE = POS1 and STOP ON EDGE = POS2

5

6. Press the **PRECISE EDGE FIND** key for each new Double Delay setting

7. Check the HP 8110A double delay at the following settings:

**Table 5-10.
Double Delay Settings and TR Reference**

Oscilloscope Timebase	Double Delay	Acceptable Range	TR Entry
2 ns/div	6.65 ns	6.0675 ns to 7.2325 ns	5 - 1
2 ns/div	9.99 ns	9.241 ns to 10.74 ns	5 - 2
10 ns/div	50.0 ns	47.25 ns to 52.75 ns	5 - 3
20 ns/div	99.9 ns	94.655 ns to 105.145 ns	5 - 4

8. Connect the HP 8110A to the Counter as shown:

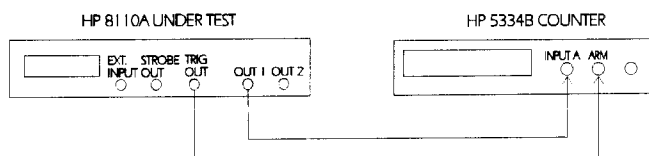

Connecting HP 8110A to the Counter

9. Set the Counter to:

- | | |
|----------------|-----------------------------|
| FUNCTION | Period A |
| INPUT A | 50 Ω |
| SENSE | On |
| EXT ARM SELECT | |
| | a. Start (ST): leading edge |
| | b. Stop (SP): trailing edge |

10. Set up the HP 8110A as described in "Initial Setup of the HP 8110A"

11. Select the TRG-MODE screen on the HP 8110A and set up as follows:

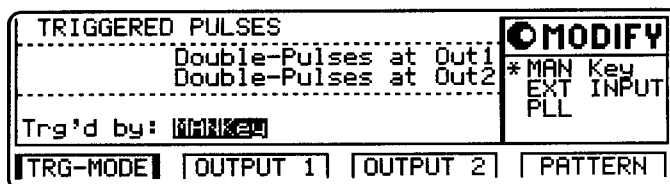

The TRG MODE Screen Setup

12. On the HP 8110A set up OUTPUT 1 and OUTPUT 2 pages as shown in the following illustrations:

Per -----	Normal	ON	1	MODIFY
DblDel	100ns			
Width	20.0ns	Offset	+0.0mV	100
LeadEdg	2.00ns	Amplit	1.00V	ns
TrailEd	2.00ns	50Ω into	50.0Ω	
TRG-MODE		OUTPUT 1		OUTPUT 2
				PATTERN

Configuring Output Screen 1

Per -----	Normal	OFF	2	MODIFY
DblDel	100ns	Separate	Out2	
Width	20.0ns	Offset	+0.0mV	100
LeadEdg	2.00ns	Amplit	1.00V	ns
TrailEd	2.00ns	50Ω into	50.0Ω	
TRG-MODE		OUTPUT 1		OUTPUT 2
				PATTERN

Configuring Output Screen 2

Note



When you are testing instruments with 2 output channels it is necessary to:

- Configure *both* channels.
- Switch OFF the channel that is not being tested

If you then test the other channel:

- Switch ON the channel you are testing, and switch OFF the other channel.

13. Check the HP 8110A double pulse delay at the following settings:

Table 5-11.
Double Delay Settings and TR Reference

Double Delay	Acceptable Range	TR Entry
100 ns	94.75 ns to 105.25 ns	5 - 5
500 ns	474.75 ns to 525.25 ns	5 - 6
1 μ s	949.75 ns to 1050.25 μ s	5 - 7
5 μ s	4.759 μ s to 5.25 μ s	5 - 8
50 μ s	47.5 μ s to 52.5 μ s	5 - 9
500 μ s	475 μ s to 525 μ s	5 - 10
5 ms	4.75 ms to 5.25 ms	5 - 11
50 ms	47.5 ms to 52.5 ms	5 - 12
500 ms	475 ms to 525 ms	5 - 13

5

Note



Repeat the entire test for the second channel, if it is installed.

Test 6: Jitter

The following tests are required:

1. Period Jitter
 - a. Internal Oscillator
 - b. Internal PLL (if HP 81106A is installed)
2. Width Jitter
3. Delay Jitter

Test 6.1a: Period Jitter, Internal Oscillator

Test Specifications RMS-Jitter 0.03% + 25 ps (0.05% + 25 ps in the range 50 ns to 100 ns)

Equipment Needed Digitizing Oscilloscope with Accessories
Delay Line (22 ns)
Power Splitter
Cable, 50 Ω , coaxial, BNC

5

Procedure 1. Connect HP 8110A to the Scope as shown:

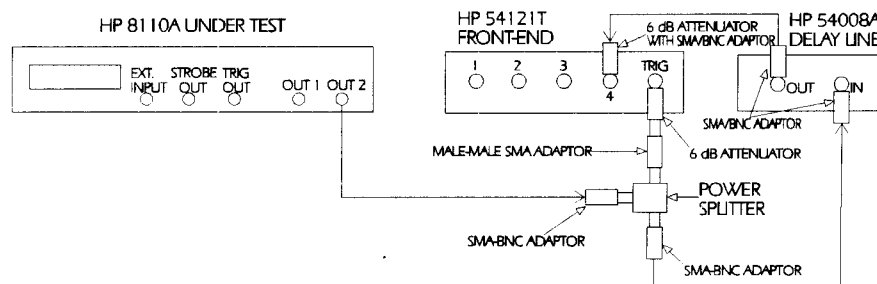

Equipment Set-up for Jitter Test

2. Set up the HP 8110A as described in "Initial Setup of the HP 8110A"

3. On the HP 8110A set up OUTPUT 1 and OUTPUT 2 pages as shown in the following illustrations:

Per	50.0ns	Normal	ON	1	MODIFY
Delay	0.00ns				50.0 ns
Width	25.0ns	Offset	+500mV		
LeadEdg	2.00ns	Amplit	1.00V		
TrailEd	2.00ns	50Ω into	50.0Ω		
TRG-MODE OUTPUT 1 OUTPUT 2 PATTERN					

Configuring Output Screen 1

Per	50.0ns	Normal	OFF	2	MODIFY
Delay	0.00ns	Separate	Out2		50.0 ns
Width	25.0ns	Offset	+500mV		
LeadEdg	2.00ns	Amplit	1.00V		
TrailEd	2.00ns	50Ω into	50.0Ω		
TRG-MODE OUTPUT 1 OUTPUT 2 PATTERN					

Configuring Output Screen 2

Note



When you are testing instruments with 2 output channels it is necessary to:

- Configure *both* channels.
- Switch OFF the channel that is not being tested

If you then test the other channel:

- Switch ON the channel you are testing, and switch OFF the other channel.

4. Set the Digitizing Oscilloscope HP 54121T:

- Press **AUTOSCALE**
- Select the Display menu and set the Number of Averages to 64
- Select the Channel menu and set the Attenuation factor of channel 4 to 2
- Set the VOLTS/DIV of channel 4 to 10 mV/div
- Set OFFSET to 250 mV

- Select the Timebase menu and set the TIME/DIV to 100 ps/div
 - Center the first positive-going edge of the signal (approximate Delay = 32.4 ns)
 - Select the Delta V menu and turn the V markers On
 - Set the Marker 1 Position to 245 mV and the Marker 2 Position to 250 mV
 - Select the Delta t menu and turn the T Markers On
 - Set START ON EDGE = POS1 and STOP ON EDGE = POS1
 - Press the **PRECISE EDGE FIND** key
5. RECORD the delta t reading. This is the rise time of the reference signal within a 1% amplitude window of the signal connected to Input 4. This value is needed later to calculate the correct jitter. (delta.t.up)
 6. Select the Timebase menu and center the second positive-going edge of the signal (approximate Delay = 82.35 ns)
 7. Press **MORE** and **HISTOGRAM**
 - Select the Window submenu and set:
 - Source is channel 4
 - Choose the Time Histogram
 - Press **WINDOW MARKER 1** and set it to 245 mV
 - Press **WINDOW MARKER 2** and set it to 250 mV
 8. Select the Acquire submenu, set the Number of Samples to 1000 and press **START ACQUIRING**
 9. After the data for the time histogram has been acquired (# Samples = 100%), select the Result submenu.
 10. Press **MEAN** and **SIGMA**. RECORD the values of sigma
 11. The RMS-jitter is calculated as follows:

$$RMS - jitter = \frac{6sigma - delta.t.up}{6}$$

12. The RMS-jitter for period of 50 ns is 50 ps. Enter the result in the Test Report as TR entry 6.1a - 1
13. Set the HP 8110A period to 500 ns
14. Repeat steps 6 to 11

Note



TIME/DIV = 200 ps/div; approximate Delay = 532 ns

15. The RMS-jitter for period of 500 ns is 175 ps. Enter the result in the Test Report as TR entry 6.1a - 2

Test 6.1b: Period Jitter, Internal PLL (If HP 81106A is installed)

Test Specifications RMS-Jitter 0.003% + 20 ps

Equipment Needed Digitizing Oscilloscope with Accessories
 Delay Line (22 ns)
 Power Splitter
 Cable, 50 Ω, coaxial, BNC

Procedure 1. Connect HP 8110A to the Scope as shown:

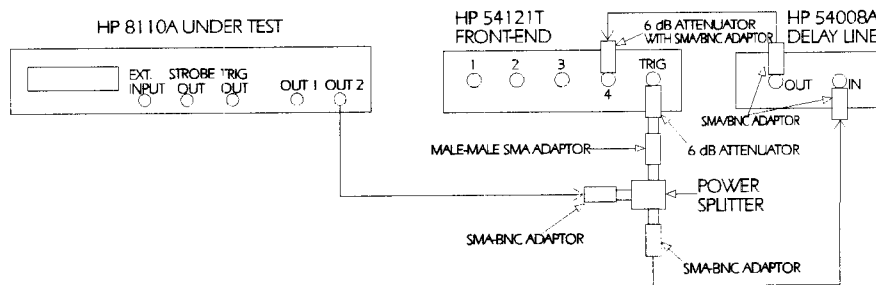

Equipment Set-up for Jitter Test

2. Set up the HP 8110A as described in "Initial Setup of the HP 8110A"

- Select the **TRG-MODE** screen on the HP 8110A and set up as follows:

CONTINUOUS PULSES		MODIFY
Single-Pulses at Out1		int Osc
Single-Pulses at Out2		* int PLL
Pulse-Period: internal PLL		CLK-IN
TRG-MODE	OUTPUT 1	OUTPUT 2
		PATTERN

The TRG MODE Screen Setup

- On the HP 8110A set up **OUTPUT 1** and **OUTPUT 2** pages as shown in the following illustrations:

Per 20.0ns	Normal	ON	1	MODIFY
Delay	0.00 ns			20.0 ns
Width	10.0 ns	Offset	+500 mV	
LeadEdg	2.00 ns	Amplit	1.00 V	
TrailE	=LeadE	50Ω into	50.0 Ω	
TRG-MODE	OUTPUT 1	OUTPUT 2		PATTERN

Configuring Output Screen 1

Per 20.0ns	Normal	ON	2	MODIFY
Delay	0.00 ns	Separate	Out2	20.0 ns
Width	10.0 ns	Offset	+500 mV	
LeadEdg	2.00 ns	Amplit	1.00 V	
TrailE	=LeadE	50Ω into	50.0 Ω	
TRG-MODE	OUTPUT 1	OUTPUT 2		PATTERN

Configuring Output Screen 2

5

Note



When you are testing instruments with 2 output channels it is necessary to:

- a. Configure *both* channels.
- b. Switch OFF the channel that is not being tested

If you then test the other channel:

- c. Switch ON the channel you are testing, and switch OFF the other channel.
-

5. Set the Digitizing Oscilloscope HP 54121T:

- Press **AUTOSCALE**
 - Select the Display menu and set the Number of Averages to 64
 - Select the Channel menu and set the Attenuation factor of channel 4 to 2
 - Set the VOLTS/DIV of channel 4 to 10 mV/div
 - Set OFFSET to 250 mV
 - Select the Timebase menu and set the TIME/DIV to 100 ps/div
 - Center the first positive-going edge of the signal (approximate Delay = 32.4 ns)
 - Select the Delta V menu and turn the V markers On
 - Set the Marker 1 Position to 245 mV and the Marker 2 Position to 250mV
 - Select the Delta t menu and turn the T Markers On
 - Set START ON EDGE = POS1 and STOP ON EDGE = POS1
 - Press the **PRECISE EDGE FIND** key
6. RECORD the delta t reading. This is the rise time of the reference signal within a 1% amplitude window of the signal connected to Input 4. This value is needed later to calculate the correct jitter. (delta.t.up)
7. Select the Timebase menu and center the second positive-going edge of the signal (approximate Delay = 52 ns)

5

8. Press **MORE** and **HISTOGRAM**
 - Select the Window submenu and set:
 - Source is channel 4
 - Choose the Time Histogram
 - Press **WINDOW MARKER 1** and set it to 245 mV
 - Press **WINDOW MARKER 2** and set it to 250 mV
9. Select the Acquire submenu, set the Number of Samples to 1000 and press **START ACQUIRING**
10. After the data for the time histogram has been acquired (# Samples = 100%), select the Result submenu.
11. Press **MEAN** and **SIGMA**. RECORD the values of sigma
12. The RMS-jitter is calculated as follows:

$$RMS - jitter = \frac{6sigma - delta.t.up}{6}$$

13. The RMS-jitter for period of 20 ns is 20.6 ps. Enter the result in the Test Report as TR entry 6.1b - 1

Test 6.2: Width Jitter

Test Specifications RMS-Jitter 0.03% + 25 ps (0.05% + 25 ps in the range 50 ns to 100 ns)

Equipment Needed

- Digitizing Oscilloscope with Accessories
- Delay Line (22 ns)
- Power Splitter
- Cable, 50 Ω , coaxial, BNC

Procedure 1. Connect HP 8110A to the Scope as shown:

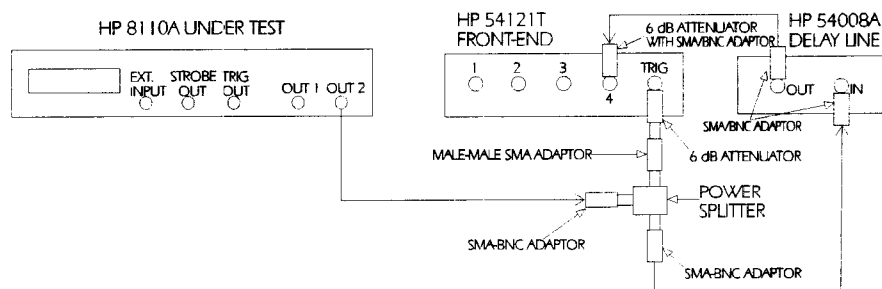

Equipment Set-up for Jitter Test

2. Set up the HP 8110A as described in "Initial Setup of the HP 8110A"

3. On the HP 8110A set up OUTPUT 1 and OUTPUT 2 pages as shown in the following illustrations:

Per 1.00 μ s		Normal	ON	1	MODIFY
Delay	0.00 ns				3.30 ns
Width	2.00 ns	Offset	+500 mV		
LeadEdg	2.00 ns	Amplit	1.00 U		
TrailEd	2.00 ns	50 Ω into	50.0 Ω		
TRG-MODE		OUTPUT 1	OUTPUT 2	PATTERN	

Configuring Output Screen 1

Per 1.00 μ s		Normal	OFF	2	MODIFY
Delay	0.00 ns	Separate	Out2		3.30 ns
Width	2.00 ns	Offset	+500 mV		
LeadEdg	2.00 ns	Amplit	1.00 U		
TrailEd	2.00 ns	50 Ω into	50.0 Ω		
TRG-MODE		OUTPUT 1	OUTPUT 2	PATTERN	

Configuring Output Screen 2

Note



When you are testing instruments with 2 output channels it is necessary to:

- a. Configure *both* channels.
- b. Switch OFF the channel that is not being tested

If you then test the other channel:

- c. Switch ON the channel you are testing, and switch OFF the other channel.

4. Set the Digitizing Oscilloscope HP 54121T:

- Press **AUTOSCALE**
- Select the Display menu and set the Number of Averages to 128
- Select the Channel menu and set the Attenuation factor of channel 4 to 2
- Set the VOLTS/DIV of channel 4 to 10 mV/div
- Set OFFSET to 250 mV

- Select the Timebase menu and set the TIME/DIV to 10 ps/div
 - Center the first negative-going edge of the signal (approximate Delay = 35.5 ns)
 - Select the Delta V menu and turn the V markers On
 - Set the Marker 1 Position to 255 mV and the Marker 2 Position to 250 mV
 - Select the Delta t menu and turn the T Markers On
 - Set START ON EDGE = NEG1 and STOP ON EDGE = NEG1
 - Press the **PRECISE EDGE FIND** key
5. RECORD the delta t reading. This is the fall time of the reference signal within a 1% amplitude window of the signal connected to Input 4. This value is needed later to calculate the correct jitter. (delta.t.dn)
 6. Set the HP 8110A Pulse Width to 50 ns
 7. Select the Timebase menu and center the first negative-going edge of the signal (approximate Delay = 82.5 ns)
 8. Press **MORE** and **HISTOGRAM**
 9. Select the Window submenu and set:
 - Source is channel 4
 - Choose the Time Histogram
 - Press **WINDOW MARKER 1** and set it to 255 mV
 - Press **WINDOW MARKER 2** and set it to 250 mV
 10. Select the Acquire submenu, set the Number of Samples to 1000 and press **START ACQUIRING**
 11. After the data for the time histogram has been acquired (# Samples = 100%), select the Result submenu.
 12. Press **MEAN** and **SIGMA**. RECORD the value of sigma
 13. The RMS-jitter is calculated as follows:

$$RMS - jitter = \frac{6sigma - delta.t.dn}{6}$$

14. The RMS-jitter for pulse width of 50 ns is 50 ps.
Enter the result in the Test Report as TR entry 6.2 - 1
15. Set the HP 8110A for pulse width of 500ns
16. Repeat steps 7 to 13

Note



TIME/DIV = 200ps/div. Approximate delay = 533 ns

17. The RMS-jitter for pulse width of 500 ns is 175 ps.
Enter the result in the Test Report as TR entry 6.2 - 2

5



Test 6.3: Delay Jitter

Test Specifications RMS-Jitter 0.03% + 25 ps (0.05% + 25 ps in the range 50 ns to 100 ns)

Equipment Needed Digitizing Oscilloscope with Accessories

Procedure 1. Connect HP 8110A to the Scope as shown:

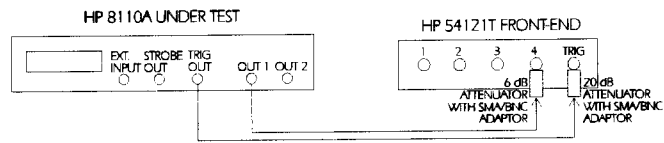

Equipment Set-up for Delay Jitter Test

2. For calculating the RMS-jitter, the rise time of the reference signal within a 1% amplitude window is required. If this value is not already measured in the Period Jitter test, then perform the first 6 steps of the Period Jitter test.
3. Set up the HP 8110A as described in "Initial Setup of the HP 8110A"

4. On the HP 8110A press **MORE** and set up **OUTPUT 1** and **OUTPUT 2** pages as shown in the following illustrations:

Per 1.00 μ s		Normal	ON	1	MODIFY
Delay	50.0 ns				50.0 ns
Width	50.0 ns	Offset	+500 mV		
LeadEdg	2.00 ns	Amplit	1.00 V		
TrailEd	2.00 ns	50 Ω into	50.0 Ω		
TRG-MODE		OUTPUT 1	OUTPUT 2	PATTERN	

Configuring Output Screen 1

Per 1.00 μ s		Normal	OFF	2	MODIFY
Delay	50.0 ns	Separate	Out2		50.0 ns
Width	50.0 ns	Offset	+500 mV		
LeadEdg	2.00 ns	Amplit	1.00 V		
TrailEd	2.00 ns	50 Ω into	50.0 Ω		
TRG-MODE		OUTPUT 1	OUTPUT 2	PATTERN	

Configuring Output Screen 2

Note



When you are testing instruments with 2 output channels it is necessary to:

- a. Configure *both* channels.
- b. Switch OFF the channel that is not being tested

If you then test the other channel:

- c. Switch ON the channel you are testing, and switch OFF the other channel.

5. Set the Digitizing Oscilloscope HP 54121T:

- Press **AUTOSCALE**
- Select the Display menu and set the Number of Averages to 64
- Set the VOLTS/DIV = 10 mV/div
- Set OFFSET to 500 mV
- Select the Timebase menu and set the TIME/DIV to 100 ps/div

- Center the first positive-going edge of the signal (approximate Delay = 78.3 ns)
- 6. Press **MORE** and **HISTOGRAM**
- 7. Select the Window submenu and press **WINDOW MARKER 1** and set it to 490 mV
- 8. Press **WINDOW MARKER 2** and set it to 500 mV
- 9. Select the Acquire submenu, set the Number of Samples to 1000 and press **START ACQUIRING**
- 10. After the delta for the time histogram has been acquired (# Samples = 100%), select the Result submenu.
- 11. Press **MEAN** and **SIGMA**. RECORD the values of sigma!
- 12. The RMS-jitter is calculated as follows:

$$RMS - jitter = \frac{6sigma - delta.t.up}{6}$$

- 13. The RMS-jitter for delay of 50 ns is 50 ps. Enter the result in the Test Report as TR entry 6.3 - 1
- 14. Set HP 8110A for delay of 500 ns
- 15. Repeat steps 9 to 12

Note



TIME/DIV = 200 ps/div. Approximate delay = 528.7 ns

- 16. The RMS jitter for delay of 500 ns is 175 ps. Enter the result in the Test Report as TR entry 6.3 - 2

Test 7: High and Low Levels

The following tests are required:

1. High level from 50Ω into 50Ω
2. Low level from 50Ω into 50Ω
3. High level from $1K\Omega$ into 50Ω
4. Low level from $1K\Omega$ into 50Ω

Test Specifications

Table 5-12.
High and Low Test Specifications

Source Impedance	Load Impedance: 50Ω	
	50Ω	$1K\Omega$
High Level	-9.90 V to +10.0 V	-18.8 V to +19.0 V
Low Level	-10.0 V to +9.9 V	-19.0 V to +18.8 V
Amplitude	0.10 V to 10.0 V	0.20 V to 19.0 V
Level Resolution	10 mV	10 mV
Level Accuracy	$\pm 1\%$ of ampl ± 50 mV	$\pm 1\%$ of ampl ± 100 mV

5

Equipment Needed

1. Digitizing Voltmeter (DVM)
2. 50Ω Feedthrough Termination, 0.1%, 10 W Adapter.
3. BNC to dual banana plug (HP 1251-2277)

Procedure Connect HP 8110A to the DVM as shown:

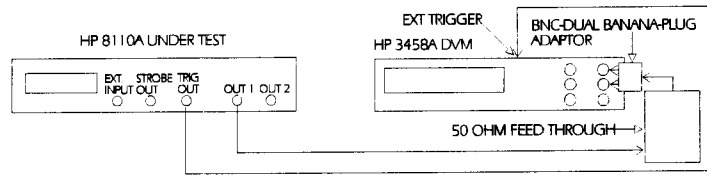

Connecting the DVM for High and Low Levels Tests

5

Test 7.1: High Level, 50 Ohms into 50 Ohms

1. Set up the HP 8110A as described in "Initial Setup of the HP 8110A"
2. On the HP 8110A press **(MORE)** and set up **OUTPUT 1** and **OUTPUT 2** pages as shown in the following illustrations:

Per	100 ms	Normal	ON	1	MODIFY
Delay	25.0 ms				+10.0 V
Width	50.0 ms	High	+10.0 V		
LeadEdg	2.00 ns	Low	+0.0 mV		
TrailEd	2.00 ns	50Ω	into 50.0Ω		
TRG-MODE OUTPUT 1 OUTPUT 2 PATTERN					

Configuring Output Screen 1

Per	100 ms	Normal	OFF	2	MODIFY
Delay	25.0 ms	Separate	Out2		+10.0 V
Width	50.0 ms	High	+10.0 V		
LeadEdg	2.00 ns	Low	+0.0 mV		
TrailEd	2.00 ns	50Ω	into 50.0Ω		
TRG-MODE OUTPUT 1 OUTPUT 2 PATTERN					

Configuring Output Screen 2

Note



When you are testing instruments with 2 output channels it is necessary to:

- a. Configure *both* channels.
- b. Switch OFF the channel that is not being tested

If you then test the other channel:

- c. Switch ON the channel you are testing, and switch OFF the other channel.

5

3. Set the DVM HP 3458A to:

Function: DCV

Trigger: TRIG EXT

AD-Converter integration time NPLC: 0.1

(Number of Power Line Cycles)

4. Check the HP 8110A high level at the following high level settings with the low level set to 0.0 V.

Table 5-13.
High Level Settings (50 ohms - 50 ohms)
and TR Reference

High Level	Acceptable Range	TR Entry
10.0 V	9.85 V to 10.15 V	7.1 - 1
5.0 V	4.90 V to 5.10 V	7.1 - 2
3.0 V	2.92 V to 3.08 V	7.1 - 3
1.0 V	0.94 V to 1.06 V	7.1 - 4
0.5 V	445 mV to 555 mV	7.1 - 5
0.1 V	49 mV to 151 mV	7.1 - 6

The low level may vary within $\pm 1\%$ of amplitude
 ± 50 mV

Test 7.2: Low Level, 50 Ohms into 50 Ohms

1. Set up the HP 8110A as described in "Initial Setup of the HP 8110A"
2. On the HP 8110A press **MORE** and set up **OUTPUT 1** and **OUTPUT 2** pages as shown in the following illustrations:

Per	100 ms	Normal	ON	1	MODIFY
Delay	75.0 ms				-100 mV
Width	50.0 ms	High	+0.0 mV		
LeadEdg	2.00 ns	Low	-100 mV		
TrailEd	2.00 ns	50Ω	into 50.0Ω		
TRG-MODE OUTPUT 1 OUTPUT 2 PATTERN					

Configuring Output Screen 1

Per	100 ms	Normal	OFF	2	MODIFY
Delay	75.0 ms	Separate	Out2		-100 mV
Width	50.0 ms	High	+0.0 mV		
LeadEdg	2.00 ns	Low	-100 mV		
TrailEd	2.00 ns	50Ω	into 50.0Ω		
TRG-MODE OUTPUT 1 OUTPUT 2 PATTERN					

Configuring Output Screen 2

Note



When you are testing instruments with 2 output channels it is necessary to:

- a. Configure *both* channels.
- b. Switch OFF the channel that is not being tested

If you then test the other channel:

- c. Switch ON the channel you are testing, and switch OFF the other channel.

3. Check the HP 8110A low level at the following low level settings with the high level set to 0.0 V

Table 5-14.
Low Level Settings (50 ohms - 50 ohms)
and TR Reference

Low Level	Acceptable Range	TR Entry
-0.1 V	-49 mV to -151 mV	7.2 - 1
-0.5 V	-445 mV to -555 mV	7.2 - 2
-1.0 V	-0.94 V to -1.06 V	7.2 - 3
-3.0 V	-2.92 V to 3.08 V	7.2 - 4
-5.0 V	-4.90 V to -5.10 V	7.2 - 5
-10.0 V	-9.85 V to 10.15 V	7.2 - 6

The high level 0.0 V may vary $\pm 1\%$ of amplitude ± 50 mV.

Test 7.3: High Level, 1K Ohms into 50 Ohms

1. Set up the HP 8110A as described in "Initial Setup of the HP 8110A"
2. On the HP 8110A press **(MORE)** and set up **OUTPUT 1** and **OUTPUT 2** pages as shown in the following illustrations:

Per	100 ms	Normal	ON	1	MODIFY
Delay	25.0 ms				+19.0 U
Width	50.0 ms	High	19.0 V		
LeadEdg	2.00 ns	Low	+0.0 mV		
Trailed	2.00 ns	1kΩ into	50.0 Ω		
<input type="checkbox"/> TRG-MODE <input checked="" type="checkbox"/> OUTPUT 1 <input type="checkbox"/> OUTPUT 2 <input type="checkbox"/> PATTERN					

Configuring Output Screen 1

Per	100 ms	Normal	OFF	2	MODIFY
Delay	25.0 ms	Separate	Out2		+19.0 U
Width	50.0 ms	High	19.0 V		
LeadEdg	2.00 ns	Low	+0.0 mV		
Trailed	2.00 ns	1kΩ into	50.0 Ω		
<input type="checkbox"/> TRG-MODE <input type="checkbox"/> OUTPUT 1 <input checked="" type="checkbox"/> OUTPUT 2 <input type="checkbox"/> PATTERN					

Configuring Output Screen 2

Note



When you are testing instruments with 2 output channels it is necessary to:

- a. Configure *both* channels.
- b. Switch OFF the channel that is not being tested

If you then test the other channel:

- c. Switch ON the channel you are testing, and switch OFF the other channel.

3. Check the HP 8110A high level at the following high level settings with the low level set to 0.0 V.

Table 5-15.
High Level Settings (1 Kohms - 50 ohms)
and TR Reference

High Level	Acceptable Range	TR Entry
19.0 V	18.71 V to 19.29 V	7.3 - 1
10.0 V	9.80 V to 10.20 V	7.3 - 2
5.0 V	4.85 V to 5.15 V	7.3 - 3
1.0 V	0.89 V to 1.11 V	7.3 - 4
0.2 V	98 mV to 302 mV	7.3 - 5

The low level 0.0 V may vary $\pm 1\%$ of amplitude ± 100 mV.

Test 7.4: Low Level, 1K Ohms into 50 Ohms

1. Set up the HP 8110A as described in "Initial Setup of the HP 8110A"
2. On the HP 8110A press **(MORE)** and set up **OUTPUT 1** and **OUTPUT 2** pages as shown in the following illustrations:

Per	100 ms	Normal	ON	1	MODIFY
Delay	75.0 ms				
Width	50.0 ms	High	+0.0 mV		-200
LeadEdg	2.00 ns	Low	-200 mV		mV
Trailed	2.00 ns	1k Ω	into 50.0 Ω		
TRG-MODE OUTPUT 1 OUTPUT 2 PATTERN					

Configuring Output Screen 1

Per	100 ms	Normal	OFF	2	MODIFY
Delay	75.0 ms	Separate	Out2		
Width	50.0 ms	High	+0.0 mV		-200
LeadEdg	2.00 ns	Low	-200 mV		mV
Trailed	2.00 ns	1k Ω	into 50.0 Ω		
TRG-MODE OUTPUT 1 OUTPUT 2 PATTERN					

Configuring Output Screen 2

Note



When you are testing instruments with 2 output channels it is necessary to:

- a. Configure *both* channels.
- b. Switch OFF the channel that is not being tested

If you then test the other channel:

- c. Switch ON the channel you are testing, and switch OFF the other channel.

5

3. Check the HP 8110A low level at the following low level settings with the high level set to 0.0 V.

Table 5-16.
Low Level Settings (1 Kohms - 50 ohms)
and TR Reference

Low Level	Acceptable Range	TR Entry
-0.2 V	-98 mV to -302 mV	7.4 - 1
-1.0 V	-0.89 mV to -1.11 V	7.4 - 2
-5.0 V	-4.85 V to -5.15 V	7.4 - 3
-10.0 V	-9.80 V to 10.20 V	7.4 - 4
-19.0 V	-18.71 V to -19.29 V	7.4 - 5

The high level 0.0 V may vary $\pm 1\%$ of amplitude ± 100 mV

5

Note



Repeat the High and Low Level tests for the second channel, if it is installed.

Test 8: Transition Time

The following tests are required:

1. $\leq \pm 5V$ window:
 - a. Minimum Leading Edge and Leading Edge range
 - b. Minimum Trailing Edge and Trailing Edge range
2. $> \pm 5V$ window:
 - a. Minimum Leading Edge
 - b. Minimum Trailing Edge

Test Specifications	Range	2.0 ns to 200 ms (measured between 10% and 90% of amplitude)
	Minimum Transitions	≤ 2.0 ns for levels within ± 5 V window, <2.5 ns for all levels, (typical 1.4 ns for levels within ± 5 V window measured between 20% and 80% of amplitude)
	Resolution	3 digits, best case 10 ps
	Accuracy	$\pm 10\% \pm 200$ ps
	Linearity	typical 3% for transitions > 100 ns

Equipment Needed Digitizing Oscilloscope with Accessories

Procedure Perform the tests as shown in the following sections:

Test 8.1a: Leading Edge Test

Minimum Leading Edge and Leading Edge ranges within $\leq \pm 5V$ window.

1. Connect HP 8110A to the Scope as shown:

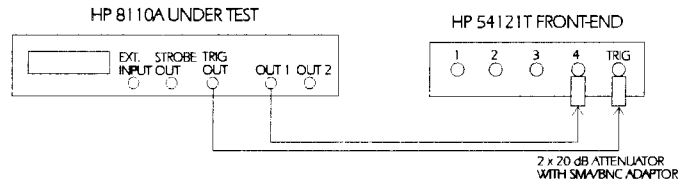

Connecting HP 8110A to the Scope

2. Set up the HP 8110A as described in “Initial Setup of the HP 8110A”

3. On the HP 8110A press **(MORE)** and set up **OUTPUT 1** and **OUTPUT 2** pages as shown in the following illustrations:

Per	500 μ s	Normal	ON	1	MODIFY
Delay	10.0 ns				1.80 ns
DutyCyc	50.0%	Offset	+0.0 mV		
LeadEdg	1.00 ns	Amplit	5.00 V		
Trailed	2.00 ns	50 Ω into	50.0 Ω		
TRG-MODE OUTPUT 1 OUTPUT 2 PATTERN					

Configuring Output Screen 1

Per	500 μ s	Normal	OFF	2	MODIFY
Delay	10.0 ns	Separate	Out2		1.80 ns
DutyCyc	50.0%	Offset	+0.0 mV		
LeadEdg	1.00 ns	Amplit	5.00 V		
Trailed	2.00 ns	50 Ω into	50.0 Ω		
TRG-MODE OUTPUT 1 OUTPUT 2 PATTERN					

Configuring Output Screen 2

Note



When you are testing instruments with 2 output channels it is necessary to:

- a. Configure *both* channels.
- b. Switch OFF the channel that is not being tested

If you then test the other channel:

- c. Switch ON the channel you are testing, and switch OFF the other channel.

4. Set the Digitizing Oscilloscope HP 54121T:

- Press **(AUTOSCALE)**
- Center one pulse on screen, e.g.: TIME/DIV = 50 μ s/div, DELAY = 365 μ s,
- Select the Display menu and set the Number of Averages to 32
- Select the Channel menu and set the Attenuation factor to 10

- Select the Delta V menu and turn the voltage markers On
 - Set the Preset Levels = 10-90% and press **AUTO LEVEL SET**
 - Select the Timebase menu and set TIME/DIV = 2 ns/div, DELAY = 29 ns
 - Select the Delta t menu and turn the markers On
 - Set START ON EDGE = POS1 and STOP ON EDGE = POS1
5. Set period of HP 8110A to: Period = 1 μ s
 6. After the averaging, while the oscilloscope is in the Delta t menu, Press the **PRECISE EDGE FIND** key
 7. Check the HP 8110A rise times at the following leading edge settings:

**Table 5-17.
Leading Edge Settings and TR Reference**

Oscilloscope TIME/DIV	Period	Leading Edge	Trailing Edge	Acceptable Range	TR Entry
2 ns/div	1 μ s	1.8 ns *	2 ns	\leq 2 ns	8.1a - 1
5 ns/div	1 μ s	10 ns	5 ns	8.8 ns to 11.2 ns	8.1a - 2
10 ns/div	1 μ s	50 ns	50 ns	44.8 ns to 55.2ns	8.1a - 3
100 ns/div	5 μ s	500 ns	500 ns	449.8 ns to 550.2 ns	8.1a - 4
1 μ s/div	50 μ s	5 μ s	5 μ s	4.4998 μ s to 5.5002 μ s	8.1a - 5
10 μ s/div	500 μ s	50 μ s	50 μ s	45 μ s to 55 μ s	8.1a - 6
100 μ s/div	5 ms	500 μ s	200 μ s	450 μ s to 550 μ s	8.1a - 7
10 ms/div	500 ms	50 ms	50 ms	45 ms to 55 ms	8.1a - 8

* Programming down to 1.8 ns is allowed, to meet this specification.

Test 8.1b: Trailing Edge Test

Minimum Trailing Edge and Trailing Edge range within $\leq \pm 5V$ window.

1. Set up the HP 8110A as described in "Initial Setup of the HP 8110A"
2. On the HP 8110A press **MORE** and set up **OUTPUT 1** and **OUTPUT 2** pages as shown in the following illustrations:

Per 1.00 μ s	Normal	ON	1	MODIFY
Delay	10.0 ns			1.80 ns
DutyCyc	50.0%	Offset	+0.0 mV	
LeadEdg	2.00 ns	Amplit	5.00 V	
Trailed	1.80 ns	50 Ω into	50.0 Ω	
TRG-MODE	OUTPUT 1	OUTPUT 2	PATTERN	

Configuring Output Screen 1

Per 1.00 μ s	Normal	OFF	2	MODIFY
Delay	10.0 ns	Separate	Out2	1.80 ns
DutyCyc	50.0%	Offset	+0.0 mV	
LeadEdg	2.00 ns	Amplit	5.00 V	
Trailed	1.80 ns	50 Ω into	50.0 Ω	
TRG-MODE	OUTPUT 1	OUTPUT 2	PATTERN	

Configuring Output Screen 2

Note



When you are testing instruments with 2 output channels it is necessary to:

- a. Configure *both* channels.
- b. Switch OFF the channel that is not being tested

If you then test the other channel:

- c. Switch ON the channel you are testing, and switch OFF the other channel.

5

3. Set the digitizing oscilloscope HP 54121T:
 - Select the oscilloscopes Timebase menu and set TIME/DIV to 2 ns/div and DELAY to approximately 529 ns
 - Select the oscilloscopes Delta t menu and set START ON EDGE = NEG1 and STOP ON EDGE = NEG1
4. While the oscilloscope is in the Delta t menu, press the **PRECISE EDGE FIND** key
5. Check the HP 8110A output signal falls at the following trailing edge settings:

**Table 5-18.
Trailing Edge Settings and TR Reference**

Oscilloscope TIME/DIV	Delay	Period	Trailing Edge	Leading Edge	Acceptable Range	TR Entry
2 ns/div	529 ns	1 μ s	1.8 ns *	2 ns	\leq 2 ns	8.1b - 1
5 ns/div	529 ns	1 μ s	10 ns	5 ns	8.8 ns to 11.2 ns	8.1b - 2
10 ns/div	529 ns	1 μ s	50 ns	50 ns	44.8 ns to 55.2 ns	8.1b - 3
100 ns/div	25 μ s	5 μ s	500 ns	50 ns	449.8 ns to 550.2 ns	8.1b - 4
1 μ s/div	25 μ s	50 μ s	5 μ s	5 μ s	4.4998 μ s to 5.5002 μ s	8.1b - 5
10 μ s/div	250 μ s	500 μ s	50 μ s	50 μ s	45 μ s to 55 μ s	8.1b - 6
100 μ s/div	2.5 ms	5 ms	500 μ s	200 μ s	450 μ s to 550 μ s	8.1b - 7
10 ms/div	250 ms	500 ms	50 ms	50 ms	45 ms to 55 ms	8.1b - 8

* Programming down to 1.8 ns is allowed, to meet this specification.

Test 8.2a: Min. Leading edge for Level Window $>\pm 5V$

1. Connect HP 8110A to the Scope as shown:

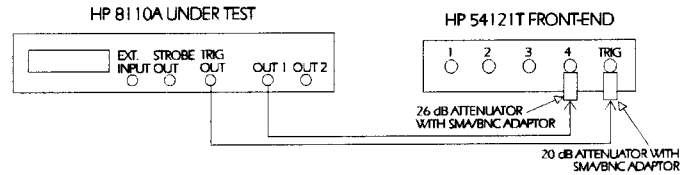

Connecting HP 8110A to the Scope

5

2. Set up the HP 8110A as described in "Initial Setup of the HP 8110A"
3. On the HP 8110A press **MORE** and set up **OUTPUT 1** and **OUTPUT 2** pages as shown in the following illustrations:

Per 1.00 μ s	Normal	ON	1	MODIFY
Delay	10.0ns			
DutyCyc	50.0%	Offset	+5.00V	
LeadEdg	2.00ns	Amplit	10.0V	2.00
TrailEd	2.00ns	50 Ω into	50.0 Ω	ns
TRG-MODE	OUTPUT 1	OUTPUT 2	PATTERN	

Configuring Output Screen 1

Per 1.00 μ s	Normal	OFF	2	MODIFY
Delay	10.0ns	Separate Out2		
DutyCyc	50.0%	Offset	+5.00V	
LeadEdg	2.00ns	Amplit	10.0V	2.00
TrailEd	2.00ns	50 Ω into	50.0 Ω	ns
TRG-MODE	OUTPUT 1	OUTPUT 2	PATTERN	

Configuring Output Screen 2

Note



When you are testing instruments with 2 output channels it is necessary to:

- a. Configure *both* channels.
- b. Switch OFF the channel that is not being tested

If you then test the other channel:

- c. Switch ON the channel you are testing, and switch OFF the other channel.
-

4. Set the Digitizing Oscilloscope HP 54121T:

- Press **AUTOSCALE**
- Select the Display menu and set the Number of Averages to 32
- Select the Channel menu and set the Attenuation factor to 20
- Select the Timebase menu and set TIME/DIV = 50 $\mu\text{s}/\text{div}$, DELAY = 365 μs
- Select the Delta V menu and turn the voltage markers On
- Set the Preset Levels = 10-90% and press **AUTO LEVEL SET**
- Select the Timebase menu and set TIME/DIV = 2 ns/div, DELAY = 29 ns
- Select the Delta t menu and turn the markers On
- Set START ON EDGE = POS1 and STOP ON EDGE = POS1

5. Set HP 8110A Period = 1 μs

6. On the Scope press **PRECISE EDGE FIND** in the Delta t menu

7. Check that the HP 8110A rise time is $< 2.5 \text{ ns}$

8. Enter the result in the Test Report as TR entry 8.2a - 1

Test 8.2b: Min.Trailing edge for Level Window $>\pm 5v$

1. Set the Scope timebase to:
 - TIME/DIV = 2 ns/div
 - DELAY = 529 ns
 - Select the Delta t menu and turn the markers ON
 - Set START ON EDGE = NEG1 and STOP ON EDGE = NEG1
 - Press **Precise Edge Find**
2. Check that the HP 8110A fall time is < 2.5 ns
3. Enter the result in the Test Report as TR entry 8.2b - 1

Note



Repeat the entire test for the second channel, if it is installed

Test 9: Pulse Aberration Test

The following tests are required:

Overshoot and Ringing

Preshoot

Test Specifications Overshoot/Preshoot/Ringing
 $\pm 5\%$ of amplitude ± 20 mV

Equipment Needed Digitizing Oscilloscope with Accessories

Procedure 1. Connect HP 8110A to the Scope as shown:

5

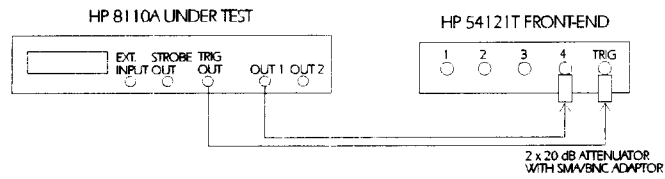

Connecting HP 8110A to the Scope

- Set up the HP 8110A as described in “Initial Setup of the HP 8110A”

3. On the HP 8110A press **MORE** and set up **OUTPUT 1** and **OUTPUT 2** pages as shown in the following illustrations:

Per	500ns	Normal	ON	1	MODIFY
Delay	0.00ns				500 µs
DutyCyc	50.0%	High	+5.00V		
LeadEdg	2.00ns	Low	+0.0mV		
Trailed	2.00ns	50Ω	into 50.0Ω		
TRG-MODE OUTPUT 1 OUTPUT 2 PATTERN					

Configuring Output Screen 1

Per	500ns	Normal	OFF	2	MODIFY
Delay	0.00ns	Separate	Out2		500 µs
DutyCyc	50.0%	High	+5.00V		
LeadEdg	2.00ns	Low	+0.0mV		
Trailed	2.00ns	50Ω	into 50.0Ω		
TRG-MODE OUTPUT 1 OUTPUT 2 PATTERN					

Configuring Output Screen 2

Note



When you are testing instruments with 2 output channels it is necessary to:

- Configure *both* channels.
- Switch OFF the channel that is not being tested

If you then test the other channel:

- Switch ON the channel you are testing, and switch OFF the other channel.

Overshoot and Ringing

- Set the digitizing oscilloscope HP 54121T:
 - Press **AUTOSCALE**
 - Select the Display menu and set the Number of Averages to 32
 - Select the Channel menu and set the Attenuation factor to 10

- Center one pulse horizontally and vertically on screen (e.g. TIME/DIV = $50\mu\text{s}/\text{div}$, DELAY = $365\mu\text{s}$)
 - Select the delta V menu and turn the voltage markers On
 - Set the VARIABLE LEVELS = 95% - 105% and press **AUTO LEVEL SET**
 - Select the channel menu and center vertically the top pulse (offset = 5 V)
 - Set the VOLTS/DIV = $200\text{ mV}/\text{div}$
 - Select the Timebase menu and set TIME/DIV = $5\text{ ns}/\text{div}$, DELAY = 16 ns
5. Set the HP 8110A to period = 500 ns
 6. Check that Overshoot and Ringing are within the $\pm 5\%$ of amplitude $\pm 20\text{ mV}$ window
 7. Enter the result in the Test Report as TR entry 9 - 1

Note

Take the oscilloscope's trace flatness error (GaAs input circuit) into account.

8. Set HP 8110A to: high level = 500 mV
9. Repeat the Overshoot and Ringing test, but this time set the VARIABLE LEVELS = 91% - 109% and press **AUTO LEVEL SET**
10. Enter the result in the Test Report as TR entry 9 - 2

Preshoot

11. Set HP 8110A to:
 - Period = $500\mu\text{s}$
 - High Level = 5 V
 - Low Level = 0 V
 - Delay = 10 ns
12. Set the digitizing oscilloscope, HP 54121T:
 - Press **AUTOSCALE**
 - Select the Display menu and set the Number of Averages to 32

- Select the Channel menu and set the Attenuation factor to 10
 - Center one pulse horizontally and vertically on screen (e.g. TIME/DIV = $50\mu\text{s}/\text{div}$, DELAY = $365\mu\text{s}$)
 - Select the delta V menu and turn the voltage markers On
 - Set the VARIABLE LEVELS = -5% to +5% and press **AUTO LEVEL SET**
 - Select the channel menu and center vertically the bottom of the pulse (offset = 0 V)
 - Set the VOLTS/DIV = 200 mV/div
 - Select the Timebase menu and set TIME/DIV = 5 ns/div, DELAY = 16 ns
13. Set HP 8110A to period = 500 ns
 14. Check that Preshoot is within the $\pm 5\%$ of amplitude ± 20 mV window.
 15. Enter the result in the Test Report as TR entry 9 - 3

HP 8110A Performance Test Records

Test Facility:

Report No. _____
Date _____
Customer _____
Tested By _____

Model HP 8110A 150 MHz Pulse Generator

Serial No. _____

Ambient temperature _____ °C

Options _____

Relative humidity _____ %

Firmware Rev. _____

Line frequency _____ Hz

Special Notes:

Test Equipment Used

Description	Model No.	Trace No.	Cal. Due Date
1. Oscilloscope	HP 54121T	_____	_____
2. Counter	HP 5334B	_____	_____
4. Digital Voltmeter	HP 3458A	_____	_____
3. Pulse Generator	HP 8112A	_____	_____
5. Delay Line	HP 54008A	_____	_____
6. _____	_____	_____	_____
7. _____	_____	_____	_____
8. _____	_____	_____	_____
9. _____	_____	_____	_____
10. _____	_____	_____	_____
11. _____	_____	_____	_____
12. _____	_____	_____	_____
13. _____	_____	_____	_____
14. _____	_____	_____	_____
15. _____	_____	_____	_____
16. _____	_____	_____	_____
17. _____	_____	_____	_____
18. _____	_____	_____	_____

5



Test Results for HP 8110A Mainframe

Serial No. _____ Ambient temperature _____ °C
Customer _____ Relative humidity _____ %
CSO# _____ Line frequency _____ Hz
Tested by _____ Date _____

Comments:

5

Internal Oscillator Period

Scope Uncertainty factor _____

TR Entry	Test	Limit Minimum	Actual Result	Limit Maximum	Pass	Fail
1 - 1	6.65 ns	6.2175 ns	_____	7.0825 ns	___	___
1 - 2	9.99 ns	9.390 ns	_____	10.589 ns	___	___
1 - 3	10.0 ns	9.4 ns	_____	10.6 ns	___	___
1 - 4	50.0 ns	47.4 ns	_____	52.6 ns	___	___
1 - 5	99.9 ns	94.805 ns	_____	104.995 ns	___	___

Counter Uncertainty factor _____

TR Entry	Test	Limit Minimum	Actual Result	Limit Maximum	Pass	Fail
1 - 6	100 ns	94.9 ns	_____	105.1 ns	___	___
1 - 7	500 ns	474.9 ns	_____	525.1 ns	___	___
1 - 8	1 μ s	949.9 ns	_____	1050.1 ns	___	___

5



Internal Oscillator Period (continued)

TR Entry	Test	Limit Minimum	Actual Result	Limit Maximum	Pass	Fail
1 - 9	5 μ s	4.75 μ s	_____	5.25 μ s	___	___
1 - 10	50 μ s	47.5 μ s	_____	52.5 μ s	___	___
1 - 11	500 μ s	475 μ s	_____	525 μ s	___	___
1 - 12	5 ms	4.75ms	_____	5.35 ms	___	___
1 - 13	50 ms	47.5 ms	_____	52.5 ms	___	___
1 - 14	500 ms	475 ms	_____	525 ms	___	___

5

Internal Period Jitter

Scope Uncertainty factor _____

TR Entry	Test	Limit Minimum	Actual Result	Limit Maximum	Pass	Fail
6.2 - 1	50 ns		_____	50 ps	___	___
6.2 - 2	500 ns		_____	175 ps	___	___

Test Results for HP 81103A 2ns/10V Output Board

Serial No. _____ Ambient temperature _____ °C
Customer _____ Relative humidity _____ %
CSO# _____ Line frequency _____ Hz
Tested by _____ Date _____

Comments:

5



Width

Scope Uncertainty factor _____

TR Entry	Test	Limit Minimum	Actual Result	Limit Maximum	Pass	Fail
3 - 1	3.30 ns	2.885 ns	_____	3.715 ns	_____	_____
3 - 2	6.60 ns	6.020 ns	_____	7.180 ns	_____	_____
3 - 3	9.99 ns	9.240 ns	_____	10.739 ns	_____	_____
3 - 4	10.0 ns	9.250 ns	_____	10.750 ns	_____	_____
3 - 5	50.0 ns	47.25 ns	_____	52.75 ns	_____	_____
3 - 6	99.9 ns	94.655 ns	_____	105.145 ns	_____	_____
3 - 7	100 ns	94.75 ns	_____	105.25 ns	_____	_____
3 - 8	500 ns	474.75 ns	_____	525.25 ns	_____	_____

5

Width (continued)

Counter Uncertainty factor _____

TR Entry	Test	Limit Minimum	Actual Result	Limit Maximum	Pass	Fail
3 - 9	1 μ s	949.75 ns	_____	1050.25 μ s	___	___
3 - 10	5 μ s	4.75 μ s	_____	5.25 μ s	___	___
3 - 11	50 μ s	47.5 μ s	_____	52.5 μ s	___	___
3 - 12	500 μ s	475 μ s	_____	525 μ s	___	___
3 - 13	5 ms	4.75 ms	_____	5.25 ms	___	___
3 - 14	50 ms	47.5 ms	_____	52.5 ms	___	___
3 - 15	500ms	475 ms	_____	525 ms	___	___

5

Width Jitter

Scope Uncertainty factor _____

TR Entry	Test	Limit Minimum	Actual Result	Limit Maximum	Pass	Fail
6.2 - 1	50 ns		_____	50 ps	___	___
6.2 - 2	500 ns		_____	175 ps	___	___

Delay

Scope Uncertainty factor _____

TR Entry	Test	Limit Minimum	Actual Result	Limit Maximum	Pass	Fail
4 - 1	0.00 ns		_____	Fixed Delay	___	___
4 - 2	5.00 ns	3.75 ns	_____	6.25 ns	___	___
4 - 3	9.99 ns	8.49 ns	_____	11.49 ns	___	___
4 - 4	50.0 ns	46.5 ns	_____	53.5 ns	___	___
4 - 5	99.9 ns	93.905 ns	_____	105.895 ns	___	___
4 - 6	100 ns	94 ns	_____	106 ns	___	___
4 - 7	500 ns	474 ns	_____	526 ns	___	___

Delay (continued)

Counter Uncertainty factor _____

TR Entry	Test	Limit Minimum	Actual Result	Limit Maximum	Pass	Fail
4 - 8	1 μ s	949 ns	_____	1051 ns	___	___
4 - 9	5 μ s	4.749 μ s	_____	5.251 μ s	___	___
4 - 10	50 μ s	47.5 μ s	_____	52.5 μ s	___	___
4 - 11	500 μ s	475 μ s	_____	525 μ s	___	___
4 - 12	5 ms	4.75 ms	_____	5.25 ms	___	___
4 - 13	50 ms	47.5 ms	_____	52.5 ms	___	___
4 - 14	500ms	475 ms	_____	525 ms	___	___

Delay Jitter

Scope Uncertainty factor _____

TR Entry	Test	Limit Minimum	Actual Result	Limit Maximum	Pass	Fail
6.3 - 1			_____	50 ps	___	___
6.3 - 2			_____	175 ps	___	___



Double Pulse Delay

Scope Uncertainty factor _____

TR Entry	Test	Limit Minimum	Actual Result	Limit Maximum	Pass	Fail
5 - 1	6.65 ns	6.0675 ns	_____	7.2325 ns	_____	_____
5 - 2	9.99 ns	9.241 ns	_____	10.74 ns	_____	_____
5 - 3	50.0 ns	47.25 ns	_____	52.75 ns	_____	_____
5 - 4	99.9 ns	94.655 ns	_____	105.145 ns	_____	_____

Counter Uncertainty factor _____

5

TR Entry	Test	Limit Minimum	Actual Result	Limit Maximum	Pass	Fail
5 - 5	100 ns	94.75 ns	_____	105.25 ns	_____	_____
5 - 6	500 ns	474.75 ns	_____	525.25 ns	_____	_____
5 - 7	1 μ s	949.75 ns	_____	1050.25 μ s	_____	_____
5 - 8	5 μ s	4.759 μ s	_____	5.25 μ s	_____	_____
5 - 9	50 μ s	47.5 μ s	_____	52.5 μ s	_____	_____
5 - 10	500 μ s	475 μ s	_____	525 μ s	_____	_____
5 - 11	5 ms	4.75 ms	_____	5.25 ms	_____	_____
5 - 12	50 ms	47.5 ms	_____	52.5 ms	_____	_____
5 - 13	500 ms	475 ms	_____	525 ms	_____	_____

High Level 500-500

TR Entry	Test	Limit Minimum	Actual Result	Limit Maximum	Pass	Fail
7.1 - 1	10.0 V	9.85 V	_____	10.15 V	___	___
7.1 - 2	5.0 V	4.90 V	_____	5.10 V	___	___
7.1 - 3	3.0 V	2.92 V	_____	3.08 V	___	___
7.1 - 4	1.0 V	0.94 V	_____	1.06 V	___	___
7.1 - 5	0.5 V	445 mV	_____	555 mV	___	___
7.1 - 6	0.1 V	49 mV	_____	151 mV	___	___

High Level 1K0-500

TR Entry	Test	Limit Minimum	Actual Result	Limit Maximum	Pass	Fail
7.3 - 1	19.0 V	18.71 V	_____	19.29 V	___	___
7.3 - 2	10.0 V	9.80 V	_____	10.20 V	___	___
7.3 - 3	5.0 V	4.85 V	_____	5.15 V	___	___
7.3 - 4	1.0 V	0.89 V	_____	1.11 V	___	___
7.3 - 5	0.2 V	98 mV	_____	302 mV	___	___

5

Low Level 50Ω-50Ω

TR Entry	Test	Limit Minimum	Actual Result	Limit Maximum	Pass	Fail
7.2 - 1	-0.1 V	-49 mV	_____	-151 mV	___	___
7.2 - 2	-0.5 V	-445 mV	_____	-555 mV	___	___
7.2 - 3	-1.0 V	-0.94 V	_____	-1.06 V	___	___
7.2 - 4	-3.0 V	-2.92 V	_____	3.08 V	___	___
7.2 - 5	-5.0 V	-4.90 V	_____	-5.10 V	___	___
7.2 - 6	-10.0 V	-9.85 V	_____	10.15 V	___	___

5

Low Level 1KΩ-50Ω

TR Entry	Test	Limit Minimum	Actual Result	Limit Maximum	Pass	Fail
7.4 - 1	-0.2 V	-98 mV	_____	-302 mV	___	___
7.4 - 2	-1.0 V	-0.89 mV	_____	-1.11 V	___	___
7.4 - 3	-5.0 V	-4.85 V	_____	-5.15 V	___	___
7.4 - 4	-10.0 V	-9.80 V	_____	10.20 V	___	___
7.4 - 5	-19.0 V	-18.71 V	_____	-19.29 V	___	___

Leading Edge for $\leq \pm 5V$ Level Window

Scope Uncertainty factor _____

TR Entry	Test	Limit Minimum	Actual Result	Limit Maximum	Pass	Fail
8.1a - 1	1.8 ns		_____	≤ 2 ns	___	___
8.1a - 2	10 ns	8.8 ns	_____	11.2 ns	___	___
8.1a - 3	50 ns	44.8 ns	_____	55.2ns	___	___
8.1a - 4	500 ns	449.8 ns	_____	550.2 ns	___	___
8.1a - 5	5 μ s	4.4998 μ s	_____	5.5002 μ s	___	___
8.1a - 6	50 μ s	45 μ s	_____	55 μ s	___	___
8.1a - 7	500 μ s	450 μ s	_____	550 μ	___	___
8.1a - 8	50 ms	45 ms	_____	55 ms	___	___

5

Trailing Edge for $\leq \pm 5V$ Level Window

TR Entry	Test	Limit Minimum	Actual Result	Limit Maximum	Pass	Fail
8.1b - 1	1.8 ns		_____	≤ 2 ns	___	___
8.1b - 2	10 ns	8.8 ns	_____	11.2 ns	___	___
8.1b - 3	50 ns	44.8 ns	_____	55.2ns	___	___
8.1b - 4	500 ns	449.8 ns	_____	550.2 ns	___	___
8.1b - 5	5 μs	4.4998 μs	_____	5.5002 μs	___	___
8.1b - 6	50 μs	45 μs	_____	55 μs	___	___
8.1b - 7	500 μs	450 μs	_____	550 μ	___	___
8.1b - 8	50 ms	45 ms	_____	55 ms	___	___

5

Leading Edge for $> \pm 5V$ Level Window

TR Entry	Test	Limit Minimum	Actual Result	Limit Maximum	Pass	Fail
8.2a - 1	2 μs		_____	< 2.5 μs	___	___

Trailing Edge for $> \pm 5V$ Level Window

TR Entry	Test	Limit Minimum	Actual Result	Limit Maximum	Pass	Fail
8.2b - 1	$2 \mu s$		_____	$< 2.5 \mu s$	_____	_____

Overshoot and Ringing

Scope Uncertainty factor _____

TR Entry	Test	Limit Minimum	Actual Result	Limit Maximum	Pass	Fail
9 - 1	5V		_____	$\pm 5\%$ of ampl. $\pm 20mV$	_____	_____
9 - 2	500mV		_____	$\pm 5\%$ of ampl. $\pm 20mV$	_____	_____

5

Preshoot

TR Entry	Test	Limit Minimum	Actual Result	Limit Maximum	Pass	Fail
9 - 3	0 V		_____	$\pm 5\%$ of ampl. $\pm 20mV$	_____	_____

Test Results for HP 81106A PLL/External Clock Board

Serial No. _____ Ambient temperature _____ °C

Customer _____ Relative humidity _____ %

CSO# _____ Line frequency _____ Hz

Tested by _____ Date _____

Comments:

5

PLL Period
(Results measured as frequency by counter)

Counter Uncertainty factor _____

TR Entry	Test	Limit Minimum	Actual Result	Limit Maximum	Pass	Fail
2 - 1	6.650 ns	150.3759 MHz	_____	150.5264 MHz	___	___
2 - 2	9.999 ns	99.910 MHz	_____	100.110 MHz	___	___
2 - 3	10.00 ns	99.900 MHz	_____	100.100 MHz	___	___
2 - 4	50.00 ns	19.980 MHz	_____	20.020 MHz	___	___
2 - 5	99.99 ns	9.991 MHz	_____	10.011 MHz	___	___
2 - 6	100 ns	9.990 MHz	_____	10.010 Mhz	___	___
2 - 7	500 ns	1.998 MHz	_____	2.002 MHz	___	___
2 - 8	1 μ s	999 kHz	_____	1.001 MHz	___	___
2 - 9	5 μ s	199.800 kHz	_____	200.200 kHz	___	___
2 - 10	50 μ s	19.980 kHz	_____	20.020 kHz	___	___
2 - 11	500 μ s	1.998 kHz	_____	2.002 kHz	___	___
2 - 12	5 ms	199.800 Hz	_____	200.200 Hz	___	___
2 - 13	50 ms	19.980 Hz	_____	20.020 Hz	___	___
2 - 14	500 ms	1.998 Hz	_____	2.002 Hz	___	___
2 - 15	5 s	0.1998 Hz	_____	0.2002 Hz	___	___

5

PLL Period Jitter

Scope Uncertainty factor _____

TR Entry	Test	Limit Minimum	Actual Result	Limit Maximum	Pass	Fail
6.1b - 1	20 ns		_____	20.6 ps	___	___

5

Specifications

Specifications describe the instrument's warranted performance. Non-warranted values are described as typical. All specifications apply after a 30 minute warm-up phase with 50 Ohm source, a 50 Ohm load resistance and separate channels. They are valid from 0°C to 55°C ambient temperature.

General

Environmental

Operating temperature:	0°C to +55°C
Storage temperature:	-40°C to +70°C
Humidity:	95% r.h. up to 40°C ambient temperature
EMC:	conforms to EN50082-1, EN55011, Class A
Battery:	Lithium (Panasonic CR2477-1HF)

6

Safety IEC1010, CSA1010

Power requirements 100-240 Vac, ±10%, 50-60 Hz;
 100-120 Vac, ±10%, 400 Hz
 Power consumption: 300 VA max.

Maximum Dimensions (H x W x D)

89 mm x 426 mm x 445 mm
(3.5 in x 17.0 in x 17.5 in)

Weight

Net

8.5 kg (18.7 lb) Single Channel

9.2 kg (20.2 lb) Dual Channel

Shipping

13.8 kg (30.3 lb) Dual Channel

Recalibration period 1 year recommended

Warranty 3 years standard

Acoustic Noise Emission

6

Acoustic Noise Emission
For ambient temperature up to 30°C,
under normal operation and at the
typical operator position:

LpA = 46 dB

Measured in accordance with
ISO 7779/EN 27779.

Geräuschemissionswerte
Bei einer Umgebungstemperatur bis 30°C

LpA = 46 dB

am Arbeitsplatz, normaler Betrieb.

Angabe ist das Ergebnis einer
Typprüfung nach ISO 7779/EN 27779.

Declaration of Conformity

Manufacturer: Hewlett-Packard GmbH
Böblingen Instruments Division
Herrenberger Str. 130
71034 Böblingen Germany

We declare that the product

HP 8110A 150 MHz Pulse Generator conforms to the following standards:

Safety: IEC 1010 (1990)

EMC: EN 55011 (1991)/CISPR 11 Group 1, Class A
EN 50082-1 (1991)

IEC 801-2 ESD: 4kV cd, 8kV ad

IEC 801-3 Radiated Immunity: 3V/m

IEC 801-4 Fast Transients: 0.5kV, 1kV

Supplementary Information

During the measurement against EN 55011, the I\O ports were terminated with their normal impedance, the HP-IB connector was terminated with the cable HP 10833B. When the product is connected to other devices, the user must ensure that the connecting cables and the other devices are adequately shielded to prevent radiation.

Böblingen 19th April 1993

Robert Hofgärtner
Quality Assurance Manager

6

HP 8110A 150 MHz Pulse Generator Mainframe

Timing

Period

Period can also be entered as frequency.

	Period
Range:	6.65 ns to 999 ms
Resolution:	3 digits, 10 ps best case ¹
Accuracy:	$\pm 5\% \pm 100 \text{ ps}^1$
RMS-jitter:	$0.03\% + 25 \text{ ps}^2$
Frequency range:	1.00 Hz to 150 MHz

¹ This specification is improved if the HP 81106A PLL/External Clock module is fitted, see "HP 81106A PLL/External Clock for the HP 8110A"

² 0.05% + 25 ps for 50–100 ns

6

Configuration

The HP 8110A mainframe can be configured with the following modules:

Module	Description	Minimum	Maximum
HP 81103A	10 V/2 ns Output Channel	1	2
HP 81106A	PLL/External Clock	0	1
HP 81107A	Multichannel Deskew	0	1

Channel Addition

With two output channels fitted, 2-, 3- and 4-level complex signals can be generated by adding channel 2 to channel 1 at the OUTPUT 1 connector. OUTPUT 2 is disabled.

Output Modes

Pulses Mode

The output signal consists of single or double pulses, controlled by the Trigger mode.

Burst Mode

The output signal consists of bursts of single or double pulses, controlled by the Trigger mode.

Burst count:	2 to 65536
Format:	single or double pulses

Pattern Mode

The output signal consists of patterns of RZ or NRZ pulses, controlled by the Trigger mode.

Pattern length:	4096 bits/channel including STROBE OUT
Format:	RZ (return-to-zero)
	NRZ (non-return-to-zero)
	DNRZ (delayed non-return-to-zero)
Random pattern:	PRBS $2^n - 1$, n = 7,8,9,10,11,12
	CCITT 0.151 standard

Trigger Modes

Continuous

Generate continuous pulses, double pulses, bursts or patterns.

Triggered

Each active input transition (rising, falling or both) triggers a single or double pulse, a burst or a pattern.

The trigger source can be selected from:

- External Input
- (MAN) Manual Trigger key
- PLL, if HP 81106A PLL/External Clock is fitted. The first pulse is undistorted.

Gated

The active input level (high or low) enables pulses, double pulses, bursts or patterns. The last pulse, double pulse, burst or pattern is always completed. The gate source can be selected from:

- External Input
- **MAN** Manual Trigger key

External Width

The period and width of an External Input signal are maintained, levels, delay and transitions can be set.

Maximum Frequency:	100 MHz
--------------------	---------

External Input



Input impedance:	50Ω or 10kΩ selectable
Threshold:	-10 V to +10 V
Maximum input voltage:	±15 V
Input transitions:	< 100 ns
Input frequency:	dc to 150 MHz
Minimum pulse width:	3.3 ns
Input sensitivity:	≤ 300 mV _{pp} typical

6

Strobe Output



Level:	TTL or ECL selectable
Output impedance:	50 Ohm typical
Maximum external voltage:	-2 V/+7 V
Transition times:	2 ns typical
Pattern:	4096 bits NRZ in pattern mode.

Typical Delay from EXT INPUT

Pulse Mode	Period Source	
	Internal Osc	PLL or CLK IN
PULSES	No STROBE OUT signal	
BURST	16.5 ns	16.5 ns + (1 < n ≤ 2) × period
PATTERN	18.5 ns	18.5 ns + (1 < n ≤ 2) × period

Trigger Output



6

Level:	TTL or ECL selectable
Output impedance:	50 Ohm typical
Trigger pulse width:	typically 50% of period
Maximum external voltage:	-2 V/+7 V
Transition times:	2 ns typical

Typical Delay from EXT INPUT

Pulse Mode	Period Source	
	Internal Osc	PLL or CLK IN
PULSES	18.5 ns	18.5 ns + (1 < n ≤ 2) × period
BURST	18.5 ns	18.5 ns + (1 < n ≤ 2) × period
PATTERN	18.5 ns	18.5 ns + (1 < n ≤ 2) × period

Human Interface

Overprogramming

Parameter values can be entered exceeding the specified range.

Warnings and Errors

Warning messages indicate potentially conflicting parameters due to accuracy tolerances.

Error messages indicate conflicting parameters.

HELP key

Displays a context-sensitive message about the selected parameter. Concept help for getting started is also available. If warnings or errors occur, the **HELP** key displays the warning/error list accordingly.

Memory

Non-volatile memory

Actual setting is saved on power-down. 9 user and 1 default setting are also stored in instrument.

Memory-card

40 settings can be stored per 128 kB (MS-DOS, PCMCIA). Also used for convenient firmware updates.

Remote Control

Operates according to IEEE standard 488.2, 1987 and SCPI 1992.0.

Function Code: SH1, AH1, T6, L4, SR1, RL1, PP0, DC1, DT1, C0.

Programming times

(checks off and display off)

Command	Typical execution time
One parameter or mode	5 to 60 ms
Timing	8 to 20 ms
Levels	40 ms
Trigger modes	57 ms
Other modes	4 to 8 ms
Recall Setting	< 250 ms
4096 bit pattern update	< 70 ms
4096 bit pattern transfer	< 1.7 s

HP 81103A 10 V/2 ns Output Channel for the HP 8110A

One or two output channels can be installed in one HP 8110A mainframe. The second output channel can be retrofitted without recalibration. All specifications apply for 50Ω source impedance with a 50Ω load.

Timing Parameters

All timing parameters are measured at 50% of amplitude at fastest transitions in continuous mode with 50Ω source and load impedance.

Common specifications

Repeatability:	4 times better than accuracy
Resolution:	3 digits, best case 10 ps
RMS Jitter:	0.03% + 25 ps ¹

¹ 0.05% + 25 ps for 50–100 ns

Width

Can be entered as absolute width, duty cycle or trailing-edge delay.

Range:	3.30 ns to 999 ms ¹
Accuracy:	±5% ± 250 ps
Duty cycle:	0.01% to 99.9%

¹ Max. value: Period – 3.3 ns

Delay

Measured between trigger output and main output. Can be entered as absolute delay, phase^o or % of period.

Fixed delay from TRIGGER OUT:	34.0 ns typical
Additional variable range:	0.00 ns to 999 ms ¹
Accuracy:	±5% ± 1 ns

¹ Maximum value: Period – 6.6 ns

HP 81103A 10V/2 ns Output Channel

Double Pulse Delay

Double Pulse Delay and delay are mutually exclusive. Double Pulse Delay is the delay between the two pulses in Double Pulse mode.

Double Pulse Delay range:	6.65 ns to 999 ns ¹
Accuracy:	±5% ±250 ps
Min. period:	13.3 ns (75 MHz)

1 Max. value: Period - Width - 3.3 ns

Transition Times

Measured between 10% and 90% of amplitude. Can be entered as leading/trailing edge or % of width.

Range:	2.00 ns to 200 ms
Min. transition:	< 2.0 ns for levels within ±5 V window
	< 2.5 ns for all levels
	1.4 ns typical for ECL levels (20% to 80% of amplitude)
Accuracy:	±10% ±200 ps
Linearity:	3% typical for transitions > 100 ns

Leading and trailing edges can be programmed independently within the following ranges (Maximum ratio 1:20):

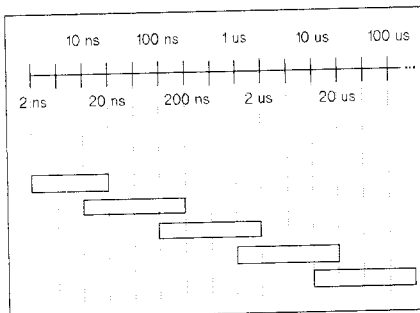

Figure 6-1. Leading/Trailing Edge ranges

6

Outputs



Source impedance:	selectable 50Ω or 1kΩ ± 1% typical (48Ω or 500 Ω with Added Channels)
Maximum external voltage:	±25 V
Short circuit current:	±400 mA max.
Normal/complement:	selectable
ON/OFF:	relays connect/disconnect output (HiZ).
Limits:	high and low levels can be limited to protect the DUT.
Dynamic Crosstalk	< 0.1% typical

External Load compensation

For loads ≠ 50Ω, the actual load impedance can be entered to correct the output values into a static load.

Level Parameters

Level parameters can be entered as voltage or current, as high/low-level or offset/amplitude in terms of voltage or current.

	Voltage(50Ω into 50Ω) ¹	Current (1kΩ into short)
Amplitude:	100 mV to 10.0 V	4mA to 400 mA
High-level	-9.90 V to +10.0 V	-396 mA to +400 mA
Low-level	-10.0 V to +9.90 V	-400 mA to +396 mA
Level Accuracy:	±(1% Amplitude + 50 mV)	-
Resolution:	10 mV	1 mA

¹ Voltages double into open circuit

6

Table 6-1.
Typical Influence of Source Impedance on Timing and Levels

	Source Impedance	Seperate Channels		Channels Added at OUTPUT 1			
		Accuracy	50 Ω	1 k Ω	48 Ω	500 Ω	OUTPUT 1
		$\pm 1\%$ typical		$\pm 1\%$ typical			
Levels	Voltage (50 Ω Load)	(Doubles into open)					
	Amplitude	100 mV to 10.0 V	200 mV to 19.0 V	0 V to 19.5 V ¹	0 V to 20.0 V		
	High-level	-9.90 V to +10.0 V	-18.8 V to +19.0 V	-19.3 V to +19.5 V	-20.0 V to +20.0 V		
	Low-level	-10.0 V to +9.90 V	-19.0 V to +18.8 V	-19.5 V to +19.3 V	-20.0 V to +20.0 V		
	Accuracy	$\pm(1\% \text{ Ampl.} + 50 \text{ mV})$	$\pm(1\% \text{ Ampl.} + 100 \text{ mV})$	-	-		
	Resolution	10 mV	20 mV	10 mV	20 mV		
	Current (into short)						
	Amplitude	-	+4 mA to +400 mA	-	0 mA to +800 mA		
	High-level	-	-396 mA to +400 mA	-	-792 mA to +800 mA		
	Low-level	-	-400 mA to +396 mA	-	-800 mA to +792 mA		
Timing	Min.Transitions	2.0 ns (within ± 5 V)		2.5 ns	7.5 ns	30 ns	30 ns
		2.5 ns	7.5 ns				
	Min.Period	6.65 ns	24 ns	3.5 ns	12 ns	45 ns	45 ns
		12 ns					
	Min.Width	3.3 ns					
	Delay Accuracy	$\pm(5\% + 1 \text{ ns})$	-	-	-	-	-
Add.Fixed delay	0	-	-	+0.6 ns	-	+0.6 ns	

1 Amplitude up to 19.5 V applies to uni-polar signals only. Bipolar signals are restricted as shown in Figure 6-2, Highest and lowest level combinations.

Pulse Performance

Overshoot/Preshoot, Ringing:

Overshoot/Preshoot, Ringing:	$\pm 5\%$ of amplitude $\pm 20\text{mV}$
Settling time:	30 ns typical

6

Channel Addition from 48Ω into 50Ω

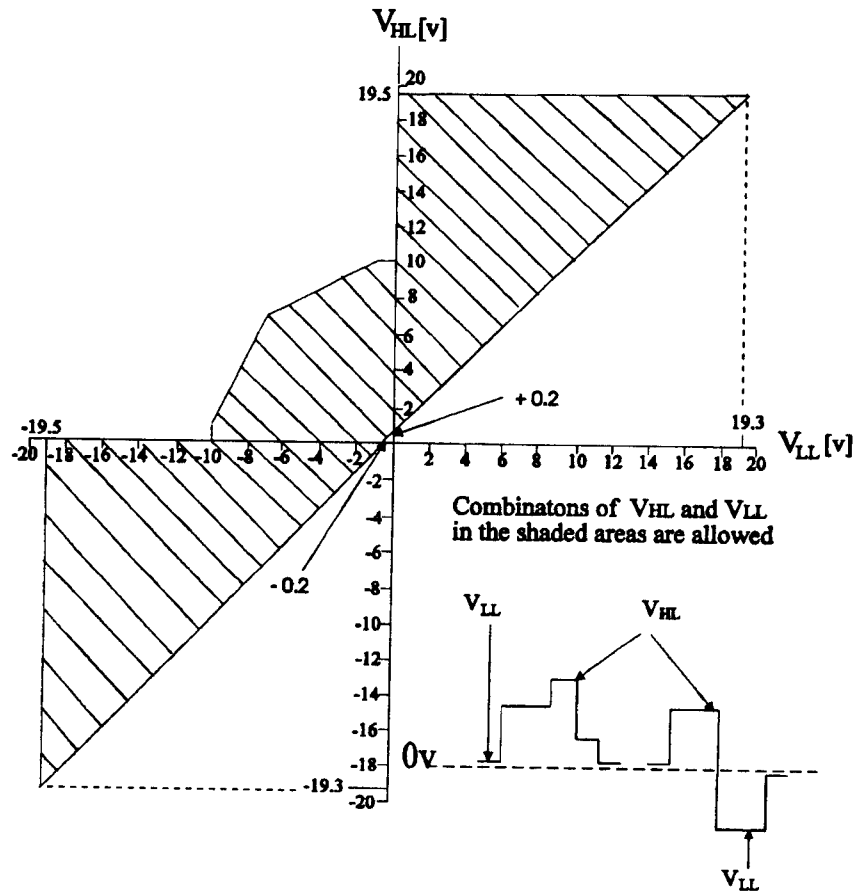

Figure 6-2. Highest and lowest level combinations

V_{HL} = highest level of output signal.

V_{LL} = lowest level of output signal.

$$V_{PP} = V_{HL} - V_{LL}$$

V_{PP} = amplitude of output signal.

Minimum $V_{PP} = -0.2V$.



HP 81106A PLL/External Clock for the HP 8110A

The PLL/External Clock module can be retrofitted without recalibration.

Clock Input/ PLL Reference Input

Input impedance:	50Ω or 10kΩ selectable
Threshold:	-10 V to +10 V
Maximum input voltage:	±15 V
Input transitions:	< 100 ns
Input Frequency:	dc to 150 MHz
Minimum pulse width:	3.3 ns
Input sensitivity:	< 300 mVpp typical
Delay to TRIGGER OUT:	22 ns typical

Rear panel BNC connector used as:

- External system clock input : pulse frequency = input frequency
- or 5 MHz or 10 MHz frequency reference input for internal PLL.

The input frequency can be measured.

Phase Locked Loop

- Locks either to an external frequency reference at the Clock/PLL Ref Input (5 MHz or 10 MHz selectable) or to its internal reference.

6

HP 81106A PLL/External Clock Module

- High accuracy period (frequency) source. When locked to the internal reference, period accuracy, range, resolution, and jitter are improved:

Period Accuracy:	$\pm 0.1\%$
Period Range:	6.65 ns to 999 s
Period Resolution:	4 digits, best case 10 ps
Period RMS-jitter:	0.003% +20 ps
Period Stability:	± 50 ppm/year typical

When locked to an external frequency reference, the external frequency affects these accuracies.

- Internal triggering of bursts and patterns: the internal PLL can replace an external trigger source, while the output period is determined by the normal internal oscillator.

External Clock

- The output period is determined by signal at clock input. Frequency accuracy can be increased by using a precise external clock.
- Trigger synchronously to external clock: the output period is synchronous to the signal at clock input. The signal at the External Input is used for arming.

6

HP 81107A Multichannel Deskew for the HP 8110A

Supports up to two output channels. The multichannel deskew can be used for two applications:

- **Multichannel calibration:** When using up to four HP 8110As synchronously (Maximum 8 channels), compensate for the delay between EXT INPUT and main outputs.
- **Delay calibration:** compensate for measurement system delays e.g. caused by cable delays or pre-trigger delays of oscilloscopes.

Variable range:	0 ns to 28 ns
Resolution:	10 ps
Additional fixed delay:	6.5 ns typical

Index

- 1** 10 W Feedthrough Termination, 5-4
- 5** 50 Ohm Feedthrough Termination, 5-4
- A**
 - Accessories, 5-2
 - AC line voltage, 1-2
 - Added at Output 1, 4-28
 - Added Outputs, 3-34, 3-47
 - Adjusting a parameter value, 2-10
 - Adjusting a setting, 2-11
 - Adjusting parameters, 2-14
 - Adjust parameter, 3-26, 3-33, 3-40
 - Amplitude, 3-36, 3-49
 - Amplitude current, 4-50
 - Amplitude voltage, 4-85
 - AUTOSET, 3-5, 3-72
- B**
 - Battery, 1-5
 - Bit edit, 3-53
 - Block Diagram, 2-4
 - BOTH, 3-54, 3-55
 - BURST length, 4-108
 - BURST mode, 4-108
 - BURST Mode, 3-10, 3-15, 3-21

- C**
 - CD, 3-64
 - CH1, 3-54, 3-55
 - CH2, 3-54, 3-55
 - Change directory, 3-64
 - Changing a setting, 2-11
 - Channel addition, 4-28
 - Clear Error Queue, 4-94
 - Clear Status, 4-94
 - CLK IN, 2-6
 - CLK IN Impedance, 4-110
 - CLK IN slope, 4-112
 - CLK IN Threshold, 4-111
 - Clock÷N, 3-57
 - Command Summary, 4-2
 - Common Commands, 4-1
 - Complement, 3-34, 3-41
 - Complex pulses, 3-34, 3-47
 - Condition Register, 4-10
 - CONFIG, 2-5
 - CONFIG , 3-68
 - CONFIG Deskew, 4-49
 - CONTINUOUS mode, 4-27
 - CONTINUOUS Mode, 3-9, 3-10, 3-11
 - Current levels, 3-37, 3-50
 - Current limits, 3-59
 - Current Limits, 4-58
 - CURSOR, 3-6
 - CURSOR keys, 2-2

- D**
 - DATA ENTRY, 3-6
 - DATA ENTRY keys, 2-2
 - DbIDel, 4-69, 4-70
 - Default settings, 2-8
 - Default units, 4-67, 4-71
 - Delay, 3-27, 3-42, 4-65, 4-66, 4-67
 - Delay%, 3-28, 3-42, 4-65, 4-66, 4-67
 - Delay Test, 5-23
 - Delay Test Results, 5-24
 - Delete, 3-67
 - Delete Bit, 3-56
 - Deskew, 4-49

- DIR, 4-38
- Directory, 3-63
- Display
 - ON/OFF, 4-37
- Double-delay, 4-69, 4-70, 4-71
- Double Delay Test, 5-27
- Double Delay Test Results, 5-30
- Double-pulses, 4-68
- Duty-cycle, 4-64
- DutyCycle, 3-28, 3-43

E

- E, 2-8, 3-4
- Edit Bit, 3-53
- Edit Block, 3-55
- Edit pattern, 3-53, 3-55
- Enable Register, 4-10
- Error checking, 3-71, 4-97
- Error Queue, 4-98
- Errors, 3-4, 3-71
- Event Register, 4-10
- External PLL Reference, 3-70
- EXT INPUT, 2-3, 2-6, 3-7
- EXT INPUT Impedance, 3-61, 4-22
- EXT INPUT Threshold, 3-60, 4-23
- EXT WIDTH, 4-20
- EXT WIDTH mode, 4-20
- EXT WIDTH Mode, 3-24

F

- Filename suffixes, 3-66
- Fill 0, 3-56
- Fill 1, 3-56
- Firmware Revision, 3-4
- First Bit, 3-56
- Format, 3-67
 - Parameter, 3-26, 3-33, 3-40
- Frontpanel Overview, 2-2
- Functional Coupling, 4-18
- Functional Overview, 2-4

- G**
 - Gated by, 4-26, 4-27
 - GATED level, 4-26
 - GATED mode, 4-25, 4-27
 - GATED Mode, 3-19, 3-21, 3-23
 - Getting started, 2-8
 - GRAPHICS, 2-12
 - Group Params by, 3-69

- H**
 - Help, 3-2, 3-5
 - High-level, 3-36, 3-49
 - High-level current, 4-52
 - High-level current limit, 4-56
 - High-level voltage, 4-87
 - High-level voltage limit, 4-90
 - Hints on editing, 3-57
 - HP 81107A, 4-49
 - HP-IB Address, 3-68

- I**
 - Impedance
 - Load, 3-37, 3-50
 - OUTPUT, 3-37, 3-50
 - Source, 3-37, 3-50
 - Input Impedance, 3-61
 - Insert Bit, 3-56
 - Inspection, 1-1
 - Instrument Serial numbers, 5-7
 - Instrument Setting, 4-103

- K**
 - Key-code Reference, 4-100

- L**
 - Last Bit, 3-56
 - Last Key Pressed, 4-99
 - Leading-edge, 3-30, 3-45
 - Leading edge, 4-78
 - LEVELS, 2-5
 - LEVELS , 3-32, 3-69
 - LIMITS, 2-5
 - LIMITS , 3-59
 - Line Switch, 2-2

- Load Compensation, 3-37, 3-50
- Load Impedance, 3-37, 3-50, 4-47
- LOCAL, 3-5
- Low-level, 3-36, 3-49
- Low-level current, 4-54
- Low-level current limit, 4-57
- Low-level voltage, 4-89
- Low-level voltage limit, 4-91

M

- MAN, 3-6, 3-13, 3-15, 3-17, 3-19, 3-21, 3-23
- Manual Trigger, 3-6
- Measure CLK IN frequency, 4-60
- Measure CLK IN period, 4-74
- MEMCARD , 3-63
- Memory card
 - Catalog/DIR, 4-38
 - Change directory, 4-39
 - Copy file, 4-40
 - Delete file, 4-41
 - Format, 4-42
 - Initialize, 4-42
 - Load from, 4-43
 - Store to, 4-44
- Memory Card, 3-63, 3-65
 - Delete, 3-67
 - Format, 3-67
 - Recall, 3-65
 - Store, 3-65
 - Store All, 3-66
- MEMORY CARD, 2-2
- MODIFY, 2-2
- Modify filename, 3-67
- MODIFY knob, 2-2
- MODIFY Knob, 3-6
- Modules, 2-1
- MORE, 3-5
- Moving the parameter cursor, 2-9
- Multilevel codes, 3-35, 3-48
- Multilevel pulses, 3-34, 3-47

- N**
 - Normal, 3-34, 3-41
 - NO UPD, 3-53
 - NRZ/RZ, 4-36

- O**
 - OFF, 3-26, 3-33, 3-41
 - Offset, 3-36, 3-49
 - Offset current, 4-51
 - Offset voltage, 4-86
 - % of Per, 4-65, 4-66, 4-67
 - ON, 3-26, 3-33, 3-41
 - Operating Environment, 1-5
 - Operation Status, 4-13
 - OUTPUT , 3-39
 - OUTPUT 1, 2-5, 3-69
 - OUTPUT 1/2, 3-69
 - OUTPUT 2, 2-5, 3-69
 - OUTPUT complement, 4-48
 - OUTPUT Impedance, 3-37, 3-50, 4-46
 - OUTPUT On/Off, 3-26, 3-33, 3-41
 - OUTPUT ON/OFF, 4-45
 - OUTPUT polarity, 4-48
 - Output Protection, 3-38, 3-51
 - Overheating, 1-4
 - Overview
 - Frontpanel, 2-2
 - Functional, 2-4
 - Rearpanel, 2-6

- P**
 - Parameter cursor, 2-9
 - Parameter format, 3-26, 3-33, 3-40
 - Path, 3-63
 - PATTERN, 2-5
 - PATTERN , 3-52
 - PATTERN Clock÷n, 4-33
 - PATTERN Clock÷N, 3-57
 - PATTERN Data, 4-29
 - PATTERN edit, 3-53
 - PATTERN length, 3-53, 4-108
 - PATTERN mode, 4-34, 4-108
 - PATTERN Mode, 3-11, 3-17, 3-23

PATTERN PRBS, 3-57, 4-32
PATTERN update, 3-53
PATTERN Update, 4-35
Performance Test Records, 5-68
Performance Tests, 5-1
Phase, 3-28, 3-42, 4-62
PLL Frequency, 4-21
PLL Period, 4-24
PLL Pulse Test, 5-15
PLL REF, 2-6, 3-70
PLL reference, 4-83
PLL Reference, 3-70
PLL reference frequency, 4-84
Power
 cable, 1-3
 requirements, 1-2
Power Switch, 2-2
PRBS 2.m1, 3-57
Programming
 BURST mode, 4-17
 CONTINUOUS mode, 4-16
 EXT WIDTH mode, 4-16
 GATED mode, 4-16
 PATTERN mode, 4-17
 PULSES mode, 4-17
 TRIGGERED mode, 4-16
Pulse Frequency, 4-59
Pulse-period, 4-73
Pulse-period source, 4-113
PULSES Mode, 3-9, 3-13, 3-19
Pulse-width, 4-82

Q Questionable Status, 4-14
Questionable Status Group, 4-95

- R**
 - Range Coupling, 4-18
 - ReadCard, 3-65
 - Reading the Error Queue, 4-98
 - Reading the Keyboard, 4-99
 - Rearpanel Overview, 2-6
 - Recall, 3-65
 - RECALL, 3-5
 - Recalling the default settings, 2-8
 - Recommended Test Equipment, 5-2
 - Records, 5-68
 - Registers, 4-11
 - Reset, 4-101
 - RZ/NRZ, 4-36

- S**
 - S, 3-5
 - SCPI
 - Command Dictionary, 4-18
 - Command Summary, 4-2
 - Version, 4-104
 - Screens, 2-10
 - Selecting
 - parameters, 2-14
 - screens, 2-10
 - Selecting a parameter, 2-9
 - Selftest, 2-8, 3-68
 - Seperate Channels, 4-28
 - Seperate Outputs, 3-34, 3-47
 - Serial Numbers, 3-4
 - Set ECL, 3-37, 3-49
 - Set TTL, 3-36, 3-49
 - SHIFT, 3-5
 - Simulating Key-presses, 4-99
 - Single-pulses, 4-68
 - Softkeys, 3-5
 - Software Revision, 3-4
 - Source Impedance, 3-37, 3-50
 - Specifications, 6-1
 - CLK IN, 6-15
 - Delay, 6-10
 - Deskew, 6-17
 - External Input, 6-6

- Levels, 6-12
 - Memory Card, 6-8
 - Output Modes, 6-4
 - Outputs, 6-12
 - Period, 6-4
 - PLL, 6-15
 - PLL REF, 6-15
 - Strobe Output, 6-7
 - Timing, 6-10
 - Timing (PLL), 6-16
 - Transition Times, 6-11
 - Trigger Modes, 6-5
 - Trigger Output, 6-7
 - Width, 6-10
 - Specifications/Pulse Performance, 6-13
 - Standard Event Status, 4-12
 - Status Byte, 4-11
 - Status Group
 - Questionable, 4-95
 - Status Groups, 4-9
 - Status Model, 4-9
 - Status Model Preset, 4-94
 - Store, 3-65
 - STORE, 3-5
 - Store All, 3-66
 - STRB, 3-55
 - STROBE OUT, 2-3, 2-6, 3-7
 - STROBE OUT levels, 3-62
 - System Preset, 4-101
 - System Security, 4-102
- T**
- Test Accessories, 5-2
 - Test Equipment list, 5-2
 - Testing, 5-1
 - Test Records, 5-68
 - Tests
 - Delay, 5-20
 - Delay Jitter, 5-42
 - Double Pulse Delay, 5-25
 - High and Low Levels, 5-45
 - High Level, 1K Ohms into 50 Ohms, 5-51

High Level, 50 Ohms into 50 Ohms, 5-47
Jitter, 5-31
Leading Edge, 5-56
Low Level, 1K Ohms into 50 Ohms, 5-53
Low Level, 50 Ohms into 50 Ohms, 5-49
Min. Leading edge for Level Window $>\pm 5V$, 5-61
Min. Trailing edge for Level Window $>\pm 5V$, 5-63
Overshoot and Ringing, 5-65
Period, 5-9
Period Jitter-Internal Oscillator, 5-31
Period Jitter-Internal PLL (if fitted), 5-34
PLL Period, 5-13
Preshoot, 5-66
Pulse Aberration Test, 5-64
Trailing Edge, 5-59
Transition Time, 5-55
TT, 5-55
Width, 5-16
Width Jitter, 5-38
TEXT, 2-12
Thermal Protection, 1-4
Threshold, 3-60
TIMING, 2-4
TIMING , 3-25, 3-69
Trailing Delay, 3-29, 3-44
Trailing-edge, 3-31, 3-46
Trailing edge, 4-79, 4-80
Trailing edge delay, 4-75
Transition coupling, 4-76
Transition Filters, 4-10
Transition Time leading Edge, 5-58
Transition times, 4-78, 4-79, 4-80
Transition units, 4-77
TRG-LEV , 3-60
TRG-LEVEL, 2-4
TRG-MODE, 2-4
TRG-MODE , 3-8
Triggered by, 4-26, 4-27
TRIGGERED Frequency, 4-21
TRIGGERED mode, 4-25, 4-27
TRIGGERED Mode, 3-13, 3-15, 3-17

TRIGGERED Period, 4-24
TRIGGERED slope, 4-26
Trigger Mode summary, 3-8
TRIGGER OUT, 2-3, 2-6, 3-7
TRIGGER OUT level, 4-81
TRIGGER OUT levels, 3-62

U UPDATE, 3-53
Upgrades, 2-1

V Value Coupling, 4-18
Ventilation, 1-4
Verification Tests, 5-1
VERNIER, 3-6
Voltage levels, 3-37, 3-50
Voltage limits, 3-59
Voltage Limits, 4-92

W W, 3-4
Warnings, 3-4, 3-71, 4-105
Weight, 6-2
Width, 3-28, 3-43
Width Test, 5-18
Width Test Results, 5-19

Copyright Agilent Technologies 1993, 2000
Edition E1095
Printed in Germany



08110-91012

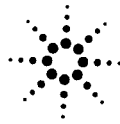

Agilent Technologies