

HP 54750A High-Bandwidth Digitizing Oscilloscope

Product Overview

**The Features and
Speed You Expect in a
High-Bandwidth
Digitizing Oscilloscope**

The HP 54750A is a modular system designed to meet the stringent demands of today's engineers. Up to four high-bandwidth channels and time domain reflectometry (TDR) are supported by the mainframe. The modular design allows for expansion to meet changing needs.

The HP 54750A high-bandwidth digitizing oscilloscope offers the highest throughput and richest feature set in the industry. An engineer's time is maximized by more than 50 built-in parametric measurements. Fast acquisition and processing provides exceptional speed in both front panel operation and in automated test systems controlled by computers.

The 20-GHz or 50-GHz bandwidth and the low-noise specifications allow very precise measurements on low-level, high-speed signals. Timebase stability, accuracy, and resolution allow characterization of jitter in the most demanding applications.

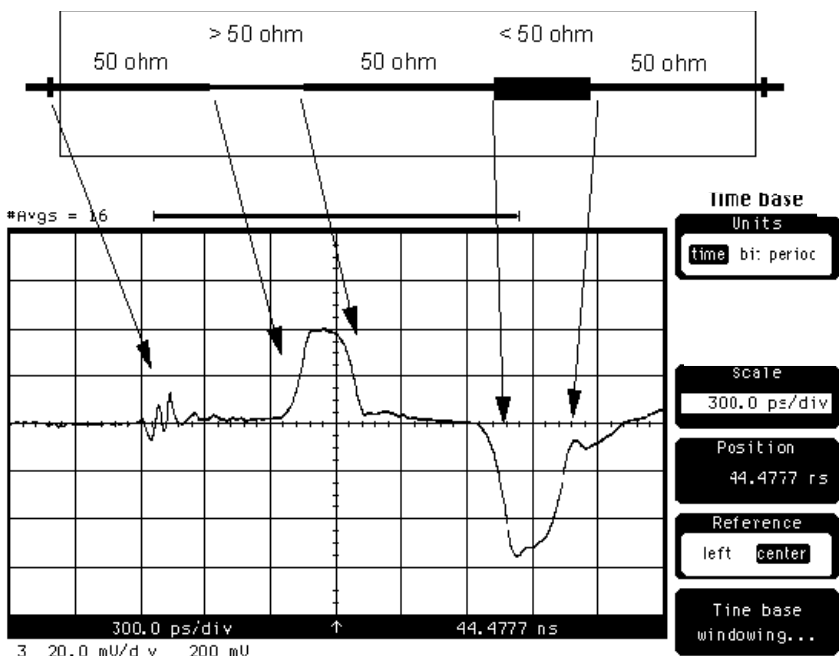
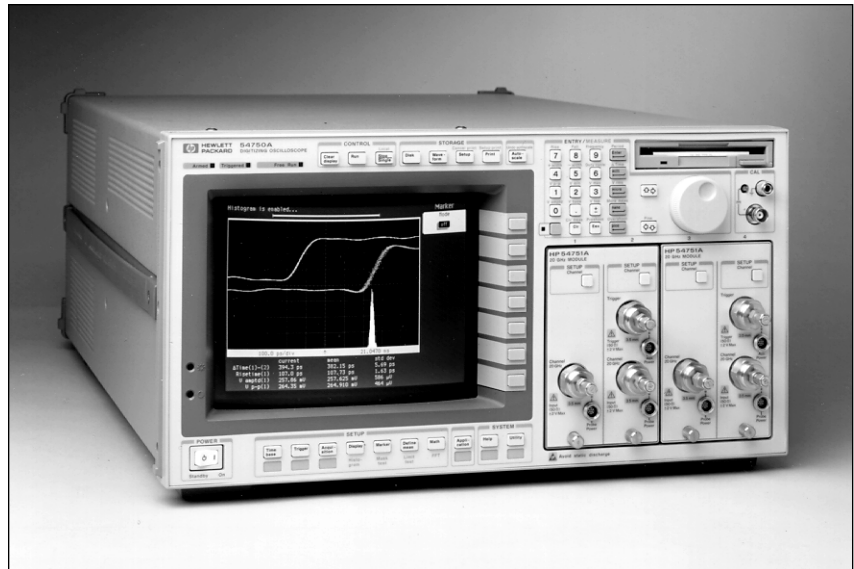

**Time domain reflectometry
(TDR) measurement**

HP 54750A Mainframe Specifications

- 62.5-fs Resolution
- 10-ps Accuracy

Time Base (Horizontal)	
Scale Factor	(Fullscale is 10 divisions)
Minimum	10 ps/division
Maximum	1 s/division
Delay	(Time offset relative to trigger)
Minimum	22 ns
Maximum	1000 screen diameters or 10 seconds, whichever is smaller
Time Interval Accuracy	≤ 10 ps ±0.1% of reading (Dual marker measurement)
Time Interval Resolution	≤ (screen diameter) / (record length) or 62.5 fs, whichever is larger

Trigger-External Input Only

Sensitivity	
dc to 100 MHz	40 mV peak-to-peak
100 MHz to 2.5 GHz	Increasing linearly from 40 mV at 100 MHz to 200 mV at 2.5 GHz
Pulse Width Required	>200 ps
Pulse Amplitude Required	>200 mV
Bandwidth Limit	Trigger bandwidth reduced to approximately 100 MHz
Jitter (trigger and time base combined) (one standard deviation)	≤ 2.5 ps + 5E-5 x delay setting (Tested using a 2.5-GHz synthesized source at 200 mV)
Trigger Input:	
Maximum safe Input Voltage	±2 Vdc
Nominal Impedance	50 Ω
Percent Reflection	≤ 10% for 100-ps rise time [1]
Connector	3.5mm (m)
Calibrator	Adjustable Output range: -2.5 V to +2.5 V when terminated into 50 Ω Output Delta Voltage Accuracy: ±(0.2% of settings)

[1] With non TDR plug-ins, ≤10% for 200 ps rise time with TDR plug-ins (HP 54754A and 54755A).

Plug-In Modules for the HP 54750A

	Electrical Channels		Optical Channels (Available with HP 83480K Firmware Upgrade)					Sensitivity (smallest power for mask test)
	Number	Bandwidth GHz	Unfiltered BW GHz (typical)	Number of Filters	Data Rates Mbit/s	Fiber Input Type	Wavelength	
HP 54751A	2	12 or 20						
HP 54752A	2	26.5 or 50						
HP 54752B	1	26.5 or 50						
HP 54753A	1 TDR/1 Electrical 1 Electrical	12 or 18 12 or 20						
HP 54754A	2 TDR/2 Electrical	12 or 18						
HP 83481A	1	12 or 20	2.5 (>3.0)	2	155 and 622	9/125 μm	1000 to 1600 nm	-17 dBm
HP 83482A	1	18 or 40	30			9/125 μm	1000 to 1600 nm	
HP 83485A	1	12 or 20	20	1	155/622 or 2488	9/125 μm	1000 to 1600 nm	-10 dBm
HP 83485B	1	18 or 40		1	9953	9/125 μm	1000 to 1600 nm	-8 dBm
HP 83486A	1	12 or 20	2.5 (≥2.7)	2	155/622 or 1063/1250	62.5/125 μm	1000 to 1600 nm	-19 dBm
HP 83487A	1	12 or 20	2.5 (>2.7)	2	1063/1250	62.5/125 μm	750 to 870 nm	-17 dBm

HP 54750A System Characteristics

Channels (Vertical)

Scale Factors: Adjustable from 1 mV/div to 100 mV/div in a 1-2-5-10 sequence from the front panel knob or the INC/DEC keys. Also adjustable over the range in 0.1-mV increments from the numeric keypad.

Attenuation Factors: Factors may be entered to scale the oscilloscope for external attenuators connected to the channel inputs. The range is from 0.0001:1 to 1,000,000:1.

Noise: Averaging reduces noise by $1/(n)^{1/2}$, where n is the number of averages, until a system limitation of approximately 25 μV (low BW mode) or 50 μV (high BW mode) is reached.

Channel-to-channel isolation: >60 dB

Bandwidth: You may select between a high (20 GHz/50 GHz) or low (12.4 GHz/26.5 GHz) bandwidth mode. The sampler is biased differently for the two modes. Typically high and low bandwidth noise is ~1/2 the specified maximum noise.

Time Base (Horizontal)

Delay Between Channels: The difference in delay between channels can be nulled out with 1-ps resolution to compensate for differences in input cables or probe length. Up to 100 μs of skew can be nulled out.

Reference Location: The reference point can be located at the left edge or center of the display. The reference point is the point where the time is offset from the trigger by the delay time. The reference point is also the point that the time base sensitivity expands and contracts around as the time base is changed.

Triggered Mode: Causes the scope to trigger synchronously to the trigger input signal.

Freerun: Causes the scope to generate its own triggers.

HP 54750A

System Characteristics (cont'd)

Typical Timing Accuracy: The time base uses a series of 4-ns blocks. Time base linearity and small discontinuities across these blocks contribute to the 8-ps accuracy specification.

When operating within 4 ns blocks, the typical accuracy is shown by the following graph. The graph below is a result of many measurements on multiple instruments.

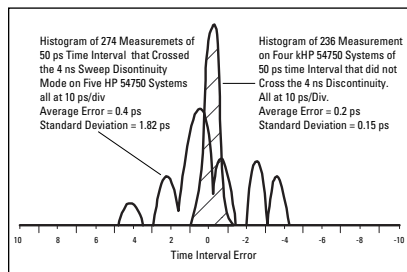

Trigger

Edge Trigger: Triggers on the positive or negative edge of the trigger input.

Hysteresis: The trigger hysteresis can be set to two modes:

Normal— the trigger hysteresis is set so the instrument meets the trigger sensitivity specification.

High Sensitivity — hysteresis is turned off to allow a best sensitivity to high-frequency signals. This mode should not be used for noisy lower frequency signals that may mistigger without hysteresis.

BW Limit: Puts the trigger signal through a low-pass filter of approximately 100 MHz.

Display

Data Display Resolution: 451 points horizontally x 256 points vertically.

Graticules: You may choose full grid, axes with tic marks, frame with tic marks, or no graticule.

Display Modes

Averaging: The number of averages can be specified between 1 and 4096 using the numeric keypad. The INCRement/ DECRe ment keys or the knob will set averaging to 1, 2, 4, 16, 64, 256, 1024, 4096. On each acquisition, 1/n times the new data is added to (n-1)/n of the previous value at each time coordinate.

Best Flatness: The samplers used in the HP 54750A system have a certain amount of passive feedthrough. This feedthrough is corrected by a compensation circuit. A small amount of feedthrough does remain after compensation and this causes slight nonflatness in the step response.

Because averaging implies single-valued waveforms, the Best Flatness control takes advantage of this to further improve flatness. This is done by taking a sample with the samplers turned on and then with samplers turned off. The two results are then subtracted, thereby removing the residual nonflatness.

Display Colors: You may choose a default color selection, or select your own colors from the front panel, or via HP-IB. Different colors are used for display background, channels, functions, background text, highlighted text, advisories, markers, overlapping waveforms, and memories.

Documentation Aids

Waveforms, scaling information, and measurement results can be transferred directly to HP-IB or Centronics graphics printers.

Waveforms may also be stored on the internal MS-DOS® compatible disk in PCX or TIFF format. This allows moving screen data into word processors for documentation.

Programmability

Instrument settings and operating modes, including automatic measurements, may be remotely programmed via HP-IB (IEEE 488.2). HP-IB programming complies with the recommendations of the IEEE 488.2 standards. The HP 54750A can be programmed to take data only at specified time points, or to return only measurement results (such as, tr, tf, and frequency) to speed up data acquisition.

Data Transfer Rate: 550 Kbytes/s typical.

Measurement Times: 25 automatic measurements per second typical.

Data Record Length: 4k points maximum per channel.

Measurement Aids

Markers: Dual voltage or time markers can be used for a variety of time and voltage measurements. Voltage markers can be assigned to channel data, measurements, functions, FFTs, histograms, color-graded displays, and memories.

Automatic Pulse Parameter Measurements

Functions	
magnify	differentiate
invert	min
add	max
subtract	FFTmag
multiply	histograms
divide	measurement limit testing
versus	waveform mask testing
integrate	color-graded display
	bw limit

Measurements

Vamptd	freq
Vbase	Tfall
Vtop	Trise
preshoot	Tmax
overshoot	Tmin
Vp-p	Tvoltage
Vtime	Vavg
Vmin	Vupper
Vmax	Vmiddle
Vrms	Vlower
+width	FFTmag
-width	FFTfreq
duty cycle	FFT delta freq
delta time	FFT delta mag
period	TDR min reflection
	TDR max reflection
	TDT prop delay
	TDT gain

Histograms

p-p
median
mean
std dev
$\mu \pm 1 \text{ sigma}$
$\mu \pm 2 \text{ sigma}$
$\mu \pm 3 \text{ sigma}$
hits
peak

Limit Test

Signals can be tested by up to four automatic parametric measurements and compared to user-defined test boundaries. Failures tolerances can be selected independently for each of the parametric tests.

On failure actions:

- 1) Save channel data to memory, disk or printer
- 2) Save screen to pixel memory, disk or printer
- 3) Save a text log summary of all failures with time tagging to disk or printer.

Limit test can be set to run continuously for a user-selected number of waveforms, or for a defined number of failures.

Mask Test

Acquired signals are tested for fit outside areas defined by up to eight polygons. Any samples that fall within the polygon boundaries result in test failures. Masks can be loaded from disk, HP-IB, or created automatically or manually.

Data collected during test:

- Total number of waveforms examined
- Number of failed waveforms
- Total number of samples taken
- Number of failed samples
- Number of hits within each polygon boundary

Auto Mask Creation

Masks are created automatically for single-valued voltage signals. Both delta X and delta Y tolerances can be specified.

The failure actions are identical to those of Limit Testing. Both mask testing and limit testing may be used independently or simultaneously.

FFT

Up to three fast Fourier transforms can be run simultaneously. The three built-in filters (Hanning, rectangular, and flattop) allow optimization of frequency resolution, transients, and amplitude accuracy. Automatic measurements can be made on frequency, delta frequency, magnitude, and delta magnitude.

Frequency Span = Sample rate / 2 = record length / (2 * time base range)

Frequency Resolution = Time base range / record length

Color Graded Display

Infinite persistence display mode where color differentiates the number of times any individual pixel has been acquired. All points acquired are added to a database and then displayed as one of eight colors depending upon the frequency of acquisition.

Automatic parametric measurements may be taken on the Color-Graded Display allowing parametric evaluation of multivalued (eye diagram) waveforms.

Autoscale: Can find repetitive signals:

- > 50 Hz
- duty cycle > 1%
- amplitude > 10 mV p-p vertical
- 50 mV p-p trigger

Waveform Math: Two functions can be specified and displayed. Functions may be defined as:

- | | |
|----------|---------------|
| magnify | versus |
| invert | integrate |
| add | differentiate |
| subtract | minimum |
| multiply | maximum |
| divide | fft magnitude |

Waveform Save: Four waveforms may be stored in four nonvolatile memories. They may also be stored to the internal MS-DOS compatible 1.44 Mbyte disk.

Setup Aids

Autoscale: Pressing the Autoscale key automatically adjusts the vertical of all channels, the horizontal scale factors, and the trigger level for a display appropriate to the applied signals.

Channel Autoscale: Autoscale can be performed on individual channels. This mode only sets the vertical for the channel selected, therefore saving time and keeping the automatic feature from changing other user-selected settings.

Save/Recall: Up to 10 complete instrument setups may be stored in the internal non-volatile memory. Additionally, many more setups can be stored on the internal MS-DOS compatible disk.

Vertical Software Calibration: Changes in the environmental conditions can be accommodated by performing a software calibration on the plug-ins. The calibration resets the plug-in for the current mainframe and plug-in operating temperature. Software vertical calibration is recommended prior to taking measurements requiring the best possible accuracy.

Digitizer Converter: 12-bit successive approximation A/D converter.

Resolution: Up to 15 bits with averaging. Variable IF gain assures that resolution is ≥ 9 bits on all ranges (11 on most).

Digitizing Rate: The signal is sampled and digitized at a rate dictated by the trigger repetition rate and the time base range. If data acquisition is not trigger rate limited, the maximum sample rate is 40 KHz.

Reflection Measurements

Source: Measurements are made using the Channel step source or a user supplied external source.

Calibration: A reference plane is defined by calibrating the reflection channel with a short placed at the point where the device under test (DUT) will be connected. The short calibration is followed with a 50- Ω calibration. These calibrations derive the normalization filter.

Cursor: Reads out the percent reflection, impedance, time, and distance from the reference plane to the cursor.

Percent Reflection: Automatic measurements provided to calculate the maximum positive and negative percent reflections of the waveform shown onscreen.

Normalization Filter: Applies a firmware digital filter to the measured data. The rise time of the filter may be varied to allow the user to simulate the edge speeds that would be seen by the device under actual operating conditions. Normalization uses the Bracewell transform, which is under license from Stanford University. See TDR output specifications for allowable rise time values.

Variable Bandwidth Limit

Changing the rise time of the normalization filter requires that a short and 50- Ω load be placed at the launch point. When this is not possible or differential TDR is used then a variable bandwidth limit filter can be used. The variable bandwidth limit function is located in the waveform math menu.

Percent Reflection Measurements: Used to quantify reactive peaks and valleys of the TDR display. Impedance measurements are valid only for resistive, horizontal flat-line TDR displays. Because the accuracy depends on the measurement being made, percent reflection and impedance accuracies are not specified. Percent reflection and impedance measurements are ratios of voltage measurements whose accuracies are specified.

$$\text{Percent Reflection } (\rho) = \frac{(V_{\text{cursor}} - V_{\text{top}})}{(V_{\text{top}} - V_{\text{base}})}$$

$$\text{Impedance } (Z) = 50 \Omega \times \frac{(1 + \rho)}{(1 - \rho)}$$

Where V_{cursor} = voltage at the cursor
 V_{top} = high level of incident step
 V_{base} = low level of incident step
and is determined during the reflection calibration

Distance measurements are subject to the accuracy of the velocity factor or dielectric constant that you enter. Because the HP 54753A and 54754A have no control over the accuracy of these numbers, distance accuracy is not specified. Distance is derived from time interval measurements whose accuracies are specified.

Distance (d) = 1/2 x Δt x Velocity Constant,

where Δt = time from the reference plane to the cursor.

$$\text{Dielectric constant} = \frac{(3 \times 10^8 \text{ m/s})^2}{(\text{Velocity Constant})^2}$$

where you enter either a relative Dielectric Constant or a Velocity constant.

The TDR's ability to resolve the distance between two discontinuities is limited to 1/2 the system rise time. Without normalization, this is approximately 1/2 x 45 ps or 7 mm in air. For the distance resolution in your media, divide 7 mm by the square root of ε of your media. With normalization, the system rise time can be 10 ps yielding 1.5 mm of resolution in air.

The maximum length the TDR can measure is subject to media loss. For a lossless vacuum, and using a 50-Hz TDR repetition rate, the system can measure 1500 km. Actual maximum lengths will generally be limited by the losses of the media under test.

Excess L/C

Once a calibration plane is established, the excess L/C feature will compute the series L or shunt C equivalent to the area between cursors. The result is the equivalent L or C that causes a discontinuity with equal area to that measured.

Scaling

The vertical scaling allows scaling in either percent reflection or ohms. Cursors will also read in voltage or ohms. A reference plane calibration must be performed to utilize these scales.

Differential TDR

The differential and common stimulus are generated by staggered rising edges from two independent TDR step generators. Hardware setup remains fixed and therefore the skew for both differential and common measurements. The response to either differential or common mode stimulus may be viewed simultaneously as differential or common mode.

All waveform math functions are automatic. Both the differential and common mode responses are computed without user intervention.

Differential TDR Timing Deskew

For accurate differential TDR measurements it is essential that the TDR steps are coincident at the reference plane and the reflected steps are coincident at the samplers. Ideally, this is accomplished by using electrically matched launch cables. When this is not possible, the TDR channels must be deskewed.

To accomplish this, it is necessary to have both TDR step time skew and channel skew capabilities. Each of the TDR steps may be moved ± 400 ps. When used in conjunction with the channel skew control, then 1.6 ns of timing delta can be removed. Depending upon the cable, this equates to approximately 1 foot of cable length difference that can be electrically removed.

Transmission Measurements

Source: Measurements are made using the channel step source or a user-supplied external source.

Calibration: A calibration with a straight-through path or through your standard device determines reference amplitude levels and reference time and distances of the signal path. These reference levels are used for gain and propagation delay measurements.

Cursor: Reads out time referenced to the calibration edge and gain referenced to the transmission calibration results. (See Note 1)

Propagation Delay and Gain: Automatically calculates the difference in time and distance between the calibration signal path the test signal path. Also calculates the ratio of the test signal amplitude to the calibration signal amplitude. (See Note 1)

Normalization Filter: Applies a firmware digital filter to the measured data. The rise time of the filter may be varied to allow you to simulate the edge speeds which would be seen by the device under actual operation. See TDR output specifications for allowable rise time values.

Note 1:

Δt = Time of the cursor (50%) - Time of reference edge (50%).

$$\text{Gain} = \frac{(V_{\text{top}} - V_{\text{base}})_{\text{signal}}}{(V_{\text{top}} - V_{\text{base}})_{\text{reference}}}$$

Prop Delay = Time of test edge (50%) - Time of reference edge (50%).

Distance (d) = Prop delay x Velocity Constant.

where V_{top} = High level of waveform and
V_{base} = Low level of waveform.

Environmental Conditions

Meets Hewlett-Packard's environmental specification (section 750) for class B-1 products with exceptions as described for temperature and condensation. Contact your local HP field engineer for complete details.

Temperature

Operating +10 °C to +40 °C

Non-operating -40 °C to +70 °C

Humidity

Operating Up to 90% relative humidity (non-condensing) at +35 °C

Nonoperating Up to 90% relative humidity at +65 °C

Altitude

Operating Up to 4,600 meters (15,000 ft)

Nonoperating Up to 15,300 meters (50,000 ft)

Vibration

Operating Random vibration 5 to 500 Hz, 10 minute per axis, 0.3 g(rms).

Nonoperating Random vibration 5 to 500 Hz, 10 minute per axis, 2.41 g(rms); resonant search, 5 to 500 Hz swept sine, 1 Octave/minute sweep rate, 0.75g, 5 minute resonant dwell at 4 resonances/axis.

Power Requirements	Voltage	Power
HP 54750A	90 to 132 or 198 to 264 Vac, 48 to 66 Hz	1200 VA; 650 W
HP 54701A	±17 Vdc	110 mA

Model Number	Approximate Net Weight	Approximate Shipping Weight
HP 54750A	24.5 kg (54 lbs)	31.8 kg (70 lbs)
HP 54751A	1.1 kg (2.4 lbs)	2.0 kg (4.4 lbs)

Dimensions are for general information only. If greater accuracy is required, contact your HP field engineer.

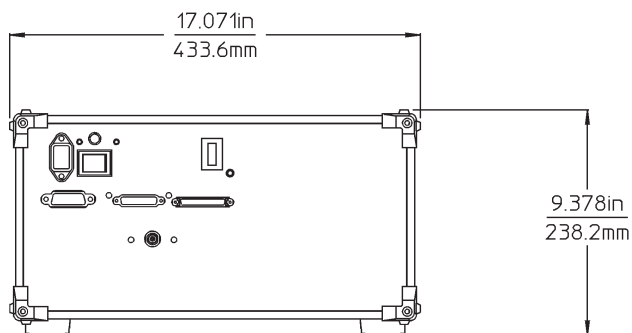
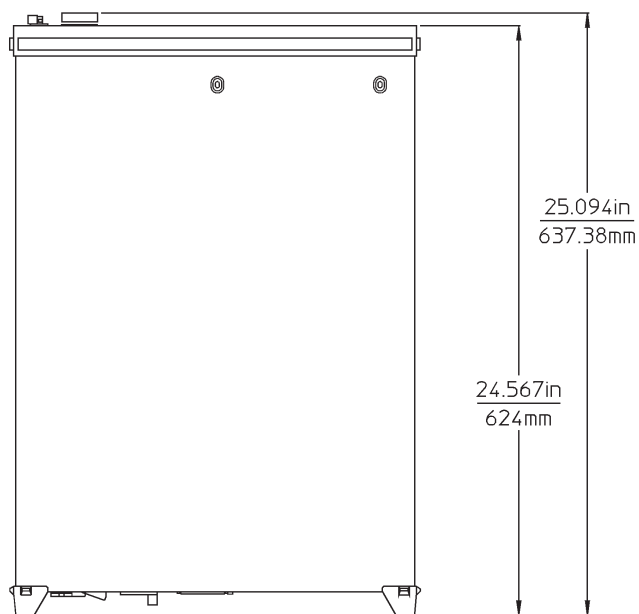

Plug-in Modules for the HP 54750A

• HP 54751A Plug-in

The HP 54751A plug-in offers two 20 GHz bandwidth channels. The two-wide configuration allows up to four channels in the HP 54750A mainframe. The bandwidth of each channel may be selected independently from the channel menu as either 20 GHz or 12.4 GHz. The bandwidth of the channel is altered by changing the bias on the sampling bridge.

The low-noise characteristic of the plug-in gives an RMS noise level of <1.0 mV in the high-bandwidth mode and <0.5 mV in the low-bandwidth mode. With exceptionally low noise and a minimum sensitivity of 1 mV/div, the HP 54751A is ideally suited for evaluation of low-level signals.

The plug-in provides a single external trigger input of 2.5 GHz. Triggering to 18 GHz is possible by using the HP 54118A.

Channels (Vertical)[1]	20-GHz Bandwidth Mode	12.4-GHz Bandwidth Mode
Bandwidth (-3dB)	dc to 20 GHz [2]	dc to 12.4 GHz [2]
Transition Time (10% to 90%) (calculated from $T_r = .35/BW$)	≤ 17.5 ps	≤ 28.2 ps
Maximum Noise (RMS)	≤ 1 mV	≤ 0.5 mV
Scale Factor	(fullscale is 8 divisions)	(fullscale is 8 divisions)
Minimum	1 mV/div	1 mV/div
Maximum	100 mV/div	100 mV/div
dc Accuracy	± 0.4% of fullscale or marker reading (whichever is greater) ± 2 mV ± 1.2% of (reading-channel offset) [5]	± 0.4% of fullscale or marker reading (whichever is greater) ± 2 mV ± 0.6% of (reading-channel offset) [5]
dc Difference	± 0.8% off fullscale or delta marker reading (whichever is greater) ± 1.2% of delta marker reading [5]	± 0.8% off fullscale or delta marker reading (whichever is greater) ± 0.6% of delta marker reading [5]
Programmable dc Offset [4]	Channel offset ± 500mV	Channel offset ± 500mV
Inputs:		
Number	Two	
Dynamic Range	± 400 mV relative to channel offset	
Maximum Safe	± 2 Vdc	
Input Voltage		
Nominal Impedance	50 Ω	
Percent Reflection	≤ 5% for 30-ps rise time	
Connectors	3.5 mm(m) with connector saver (f-f)	

[1] When operated within ± 5 °C(± 9 °F) of the temperature of the last plug-in calibration. See the Operating Characteristics for additional information on vertical software calibration.
 [2] The input samples are biased differently for increased bandwidth in the 20-GHz bandwidth mode.
 [3] When driven from a 0 Ω source.
 [4] An effective offset of ± 900 mV can be achieved using the ± 500 mV of channel offset and adding ± 400 mV of offset using the waveform math offset scaling function.
 [5] When operated within ± 2 °C(± 3.6 °F) of the temperature of the last plug-in calibration. When operated within ± 5 °C(± 9 °F) of the temperature of the last plug-in calibration, the final term in the dc accuracy specification is 2.5 times higher.

• HP 54752A and 54752B Plug-ins

The HP 54752A has two 50 GHz bandwidth channels and the HP 54752B provides a single cost-effective channel. Both plug-ins use 2.4 mm connectors to provide the highest fidelity from the DUT.

These plug-ins also feature a dual bandwidth scheme which can be selected independently from the mainframe. The low-bandwidth mode bandlimits the signal to 26.5 GHz. The high-bandwidth mode RMS noise performance is <1.5 mV and the low-bandwidth mode is <0.75 mV.

Channels (Vertical)[1]	50-GHz Bandwidth Mode	26.5-GHz Bandwidth Mode
Bandwidth [2] (-3db)	dc to 50 GHz	dc to 26.5 GHz
Transition Time (10% to 90%) (calculated from $T_r=0.35/BW$)	≤ 7.0 ps	≤ 13.2 ps
Maximum Noise (RMS)	≤ 1.5 mV	≤ 0.75 mV
Scale Factor	(fullscale is 8 div)	(fullscale is 8 div)
Minimum	1 mV/div	1 mV/div
Maximum	100 mV/div	100 mV/div
dc Accuracy	± 0.4% of fullscale or marker reading (whichever is greater) ± 2 mV ± 2.0% of (reading-channel offset) [5]	± 0.4% of fullscale or marker reading (whichever is greater) ± 2 mV ± 1.2% of (reading-channel offset) [5]
dc Difference	± 0.8% of fullscale or delta marker reading (whichever is greater) ± 2.0% of delta marker reading [5]	± 0.8% of fullscale or delta marker reading (whichever is greater) ± 1.2% of delta marker reading [5]
Programmable dc Offset [4]	Channel offset ± 500 mV	Channel offset ± 500 mV
Inputs:		
Number	One HP 54752B Two HP 54752A	
Dynamic Range	± 400 mV relative to channel offset	
Maximum Safe	± 2 Vdc	
Input Voltage		
Nominal Impedance	50 Ω	
Percent Reflection	≤ 5% for 20-ps rise time	
Connectors	2.4 mm(m)	

[1] When operated within ± 5 °C(± 9 °F) of the temperature of the last plug-in calibration. See the Operating Characteristics for additional information on vertical software calibration.
 [2] The input samplers are biased differently for increased bandwidth in the 50 GHz bandwidth mode.
 [3] When driven from a 0 Ω source.
 [4] An effective offset of ± 900 mV can be achieved using the ± 500 mV of channel offset and adding ± 400 mV of offset using the waveform math offset scaling function.
 [5] When operated within ± 2 °C(± 3.6 °F) of the temperature of the last plug-in calibration. When operated within ± 5 °C(± 9 °F) of the temperature of the last plug-in calibration, the final term in the dc accuracy specification is 2.5 times higher.

• HP 54753A Plug-in

The HP 54753A is a two-channel vertical plug-in with a TDR step generator built into channel one. The bandwidth of the TDR/vertical channel is 18 GHz. The bandwidth of channel two is 20 GHz.

The step generator provides a 200 mV TDR step with a system rise time of <45 ps. The system has the ability to normalize the TDR by applying a digital filter. Normalization removes errors caused by loss or imperfect launchers or cables.

The rise time of the normalization filter may be varied to allow you to simulate the edge speeds found in your system. You may also push the rise time up to 10 ps. Unlike the HP 54120 series, the normalization filter when activated processes every acquisition so you see changes as the DUT is adjusted.

The HP 54753A provides support for external step generators, such as the PicoSecond Pulse Labs 4015C.

Channels (Vertical)[1]	18/20 GHz Bandwidth Mode	12.4 GHz Bandwidth Mode
Bandwidth [2] (-3db)	HP 54753A and HP 54754A dc to 18 GHz TDR channel HP 54753A non-TDR channel dc to 20 GHz	dc to 12.4 GHz dc to 20 GHz
Transition Time (10% to 90%) (calculated from $T_r=0.35/BW$)	≤ 19.4 ps HP 54753A non-TDR channel ≤ 17.5 ps	≤ 28.2 ps
Maximum Noise (RMS)	≤ 1 mV	≤ 0.5 mV
Scale Factor	(fullscale is 8 div)	(fullscale is 8 div)
Minimum	1 mV/div	1 mV/div
Maximum	100 mV/div	100 mV/div
dc Accuracy	± 0.4% of fullscale or marker reading (whichever is greater)	± 0.4% of fullscale or marker reading (whichever is greater)
Single Voltage Marker [3]	± 2 mV ± 1.2% of (reading-channel offset) [5]	± 2 mV ± 0.6% of (reading-channel offset) [5]
dc Difference	± 0.8% of fullscale or delta marker reading (whichever is greater)	± 0.8% of fullscale or delta marker reading (whichever is greater)
Voltage Accuracy Using Two Voltage Markers on The Same Channel [3]	± 1.2% of delta marker reading [5]	± 0.6% of delta marker reading [5]
Programmable dc Offset [4]	Channel offset ± 500 mV	Channel offset ± 500 mV
Inputs:		
Number	Two	
TDR Step Generators	One 54753A Two 54754A	
Dynamic Range	± 400 mV relative to channel offset	
Maximum Safe Input Voltage	± 2 Vdc	
Nominal Impedance	50 Ω	
Percent Reflection	≤ 5% for 30 ps rise time	
Connectors	3.5 mm(m)	

[1] When operated within ± 5 °C (± 9 °F) of the temperature of the last plug-in calibration. See the Operating Characteristics for additional information on vertical software calibration.

[2] The input sampler are biased differently for increased bandwidth in the 18/20 GHz bandwidth mode.

[3] When driven from a 0 Ω source.

[4] An effective offset of ± 900 mV can be achieved using the ± 500 mV of channel offset and adding ± 400 mV of offset using the waveform math offset scaling function.

[5] When operated within ± 2 °C (± 3.6 °F) of the temperature of the last plug-in calibration. When operated within ± 5 °C (± 9 °F) of the temperature of the last plug-in calibration, the final term in the dc accuracy specification is 2.5 times higher.

• HP 54754A Plug-in

The HP 54754A has two independent vertical channels and two step generators. The bandwidth of both channels is 18 GHz.

The step generators may be operated singly, simultaneously but independently, differentially, or as common-mode stimulus. The TDR results may be viewed as common mode or differentially and displayed simultaneously. Once selected, the display mode is computed automatically, freeing the user from setting up mathematical functions.

Each step may be skewed separately in time. Coupled with the ability to skew the vertical channels, it is possible to accurately perform differential TDR when the launch cables are not the same electrical length.

TDR System	Combined Oscilloscope and TDR Performance	Normalized Characteristics [1]
Rise time [1]	< 45 ps [3]	Adjustable: allowable values based on time base setting. Minimum: 10 ps or 0.08 x Time/div, whichever is greater. Maximum: 5 x Time/div
Flatness [2]	< ± 1% after 1 ns from edge; < +5%, -3% to 1 ns from edge	< 0.1%
Levels:		
Low	0.00 V ± 2 mV	0.00 V ± 2 mV
High	+200 mV ± 2 mV	+200 mV ± 2 mV
	[1] Normalized information is a characteristic, not a specification. The information is presented here for comparison only.	
	Normalization characteristics are achieved only with the use of the normalization calibrations and firmware routines.	
	[2] Measured in the Averaged Display mode with best flatness on.	
	[3] The rise time of the generator is less than 35 ps, as calculated by:	
	$T_r System = \sqrt{(T_r Generator)^2 + (T_r Scope)^2}$	

HP 54118A Trigger

- 500 MHz to 18 GHz

Specifications

Input

Frequency Range 500 MHz to 18 GHz
Connector 3.5 mm (male)
Nominal Impedance 50 Ω
Coupling ac Input Sensitivity
 500 MHz to 2.0 GHz ≤ 50 mVp-p (-22 dBm)
 2.0 GHz to 12.4 GHz ≤ 500 mVp-p (-2 dBm)
 12.4 GHz to 18 GHz ≤ 1.0 Vp-p (+4 dBm)
Maximum Safe Input 25 Vdc, 4 Vp-p ac (+16 dBm)
Percent Reflection ≤ 5% for 30 ps risetime
Trigger Level 0 V to 2 Vp-p (+10 dBm)
Arming Level 0 V to 2 Vp-p (+10 dBm)
Holdoff 50 μs to 200 μs

Output

Connector 3.5 mm (male)
Nominal Impedance 50 Ω
Coupling ac
Maximum Safe External Voltage ±25 Vdc
Jitter (1 sigma)
 ≤ 3 % of input signal period
 ≤ 2.5 ps at 12.4 GHz
 ≤ 1.7 ps at 18.0 GHz

Operating Characteristics

Output
Signal (into 50 Ω) 200 mV positive pulse 5 ns wide
Delay From Trigger Edge 4 ns (approximate)
Kickout at Signal Input A single, positive pulse, under 300 mV and 900 ps wide at the beginning of the sweep.
Power Input Connector SMB snap-on coaxial
Voltage +15 Vdc ± 5%
Current 150 mA max, 130 mA Typical
Power 2.4 Watts max

Environmental

Temperature, Operating +15 °C to +35 °C
Temperature, Storage -40 °C to +70 °C
Humidity, Operating 90 % at 35 °C
Humidity, Nonoperating 95 % at 65 °C
Altitude, Operating 4,600 meters
Altitude, Nonoperating 15,300 meters
Vibration, Operating 0.3 g Random 5 to 500 Hz, 10 min/axis
Vibration, Nonoperating 2.41 G (rms) Random 5-500 Hz, 10 min/axis 0.75 G (rms) Sine 5 to 500 Hz, 5 min/resonance Net weight 1.8 kg (4 lb)

The following is a list of standard accessories supplied with the HP 54118A 500-MHz to 18-GHz Trigger. All accessories needed to use the HP 54118A with the HP 54750-series test set alone are included in the RF accessories kit.

Power Cable

1 each HP 54111 - 61609 Coaxial SMB, 25 cm long

Trigger Output Cable

1 each HP 54118-61607 Semirigid U SMA (male-male) External input cable for connecting the HP 54118A trigger output to the trigger input of the HP 54750 - Series test set.

Trigger Input Cable

1 each HP 54118-61608 8 cm Semirigid L, SMA (male-male)

RF Accessories

1 each HP 11667B dc to 26.5 GHz, 6-dB power divider
 1 each HP 33340C opt 006 dc to 26.5 GHz, 6-dB attenuator
 1 each HP 54007-61602 3-cm, Semirigid L, SMA (male-male)
 1 each HP 54007-61601 6-cm, Semirigid L, SMA (male-male)

Adapters

2 each 3.5 mm (female-female)
 HP 5061-5311

Coaxial Shorts

2 each SMA (male) HP 0960-0055

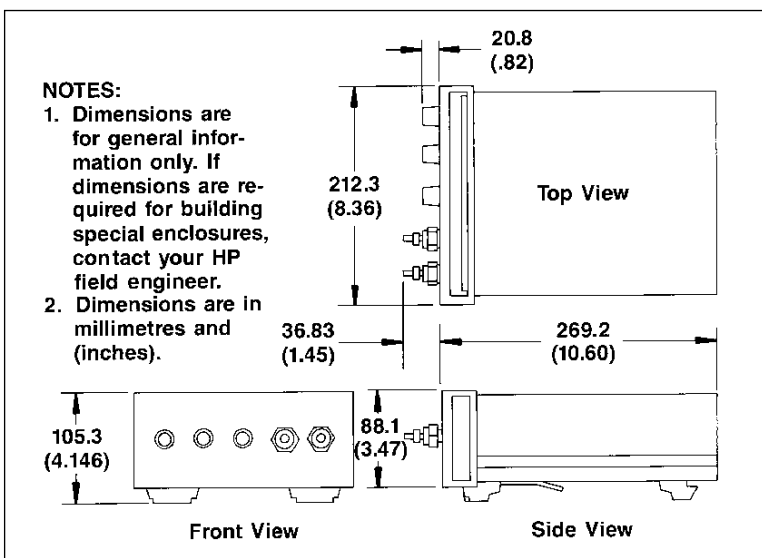
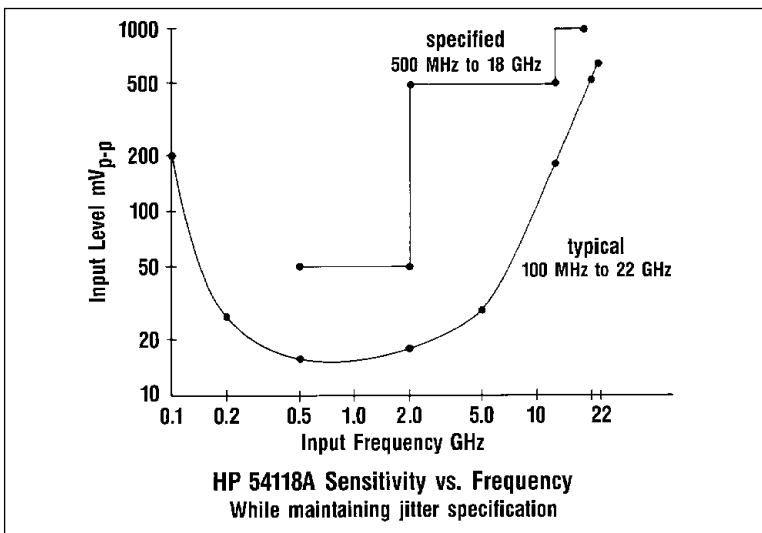

HP 54008A 22-ns Delay Line

• View the Trigger Event

The HP 54008A is a 22-ns delay line whose primary application is to view the trigger event on an HP 54750-series digitizing oscilloscope. The delay line has a frequency range which extends from dc to 20 GHz and has less than 5.70 dB of attenuation at 20 GHz.

Each delay line is shipped from the factory with a VSWR versus frequency plot and an insertion loss versus frequency plot for that particular delay line.

The HP 54750 family of digitizing oscilloscopes are sequential sampling digitizing oscilloscopes and contain about 22 ns of delay between trigger point and the first sampling point. Using the HP 54008, a trigger point can be displayed on the screen of any HP 54750-series oscilloscope.

When using an HP 54750-series oscilloscope with the HP 54118A trigger, the delay between the trigger event and the first sample point is increased by about 4 ns. Because the HP 54008A delay line's electrical timing length is greater than 22 ns long, the HP 54008A will work in this application also.

Specifications

Delay: ≥ 22 ns
Frequency Range: dc to 20 GHz.
VSWR: $\leq 1.45:1$
Insertion Loss: ≤ 5.70 dB at 20 GHz.

Characteristics

Risetime: ≤ 40 ps (20% to 70%)
Overshoot: ≤ 5 mV as displayed with the HP 54754A TDR step generator.
Connectors: SMA (f)

Environmental

Temperature Operating: +15 °C to +35 °C (+59 °F to +95 °F)
Temperature NonOperating: -40 °C to +70 °C (-40 °F to +158 °F)
Humidity Operating: Up to 90 % relative humidity at +35 °C (+95 °F)
Humidity Nonoperating: Up to 95 % relative humidity at +65 °C (+149 °F)
Altitude Operating: 4,600 m (15,000 feet)
Altitude Nonoperating: 15,300 m (50,000 feet)
Vibration Operating: Random Vibrations 5 to 500 Hz, 10 minutes per axis, appx 0.3 g (RMS)
Vibrations Nonoperating: Random vibration 5 to 500 Hz, 10 minutes per axis, appx 2.41 g (RMS); and swept sine resonant search, 5 to 500 Hz, 0.75 g (0-peak), 5 minute resonant dwell at 4 resonances per axis.
Weight: Net Approximately 1.53 kg (3.4 lb)
Dimensions
Width: 212.60 millimeters (8.37 inches)
Height: 68.58 millimeters (2.7 inches)
Depth: 222.25 millimeters (8.75 inches)



HP 54007A Accessory Kit

The HP 54007A accessory Kit contains precision terminations, adapters, and other devices. These devices have been specifically designed for precision, low-loss time domain network analysis (TDNA) calibration and analysis, using the HP 54750-series digitizing oscilloscope.

Contents of HP 54007A Accessory Kit

1 17 inch Coaxial Cable, APC 3.5 mm (f-f)	HP 8120-4941
1 17 inch Coaxial Cable, APC 3.5 mm (m-f)	HP 8120-4942
1 Coaxial Short, APC 3.5 mm (f)	HP 1250-2127
1 Coaxial Short, APC 3.5 mm (m)	HP 1250-2128
1 50 Ω Termination, APC 3.5 mm (m)	HP 909D
1 50 Ω Termination, APC 3.5 mm(f)	HP 909D opt 011
1 7.5 cm Airline, APC 3.5 mm (m-f)	HP 1250-1869
1 Power Splitter, APC 3.5 mm (f)	HP 11667B
1 2.6 cm. Semi-rigid Coax-"L", SMA (m-m)	HP 54007-61601
1 3 cm. Semi-rigid Coax-"L", SMA (m-m)	HP 54001-61602
1 6dB attenuator, APC 3.5 mm (m-f)	HP 33340C Option 006
1 40dB attenuator, APC 3.5 mm (m-f)	HP 33340C Option 040
1 Adapter, APC 3.5 mm (m-m)	HP 1250-1748
1 Foam Box Liner	HP 54007-29301
1 Walnut Box	HP 54007-85501
1 54007A Accessory Operating Note	HP 54007-90901
A 15cm Beadless Airline is available under HP part number 1250-1876	

Hewlett-Packard recommends using the following items to properly care for your precision APC 3.5, 2.4-mm and SMA connectors. (See the HP 54007A Operating note for complete details on precision connector care.)

5 inch-lbs torque wrench	HP P/N 8710-1582
8 inch-lbs torque wrench	HP P/N 8710-1765
Compressed Air Canister	HP 92193Y
Liquid Freon	HP P/N 8500-1914
Plastic Foam Swabs	HP P/N 9300-0468

HP 54701A Active Probe Specifications

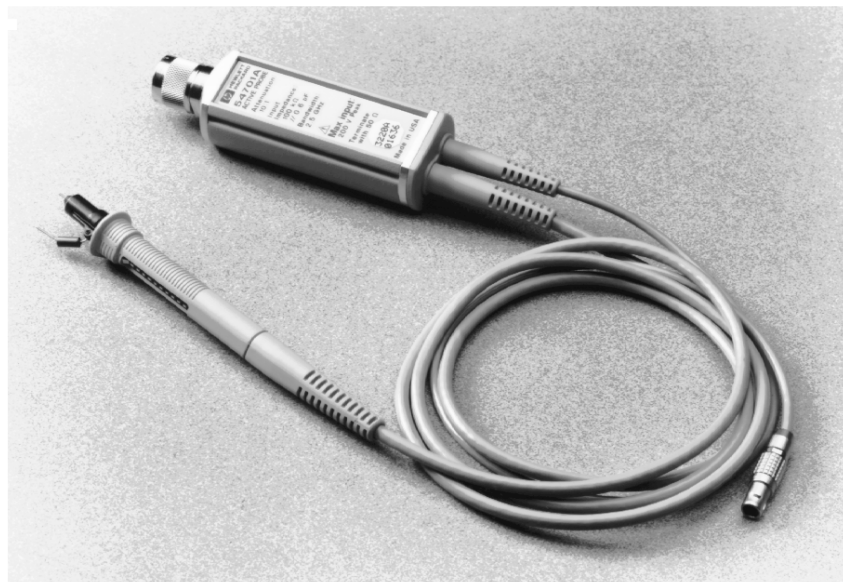

HP 54701A 2.5-GHz Active Probe Specifications

Bandwidth (-3 dB)	>2.5 GHz	Flatness	<3 ns from rising edge: $\pm 6\%$ ≥ 3 ns from rising edge: $\pm 1\%$
Rise Time (calculated from $T_r = 0.35/BW$)	<140 ps	Dynamic Range (<1.5% gain compression)	5 V peak ac ± 50 Vdc
Attenuation Factor	10:1	Offset Adjustment	± 50 V at the probe tip
dc Input Resistance	100 k Ω $\pm 1\%$	RMS Output Noise	(dc to 2.5 GHz with input loaded in 50- Ω Terminator)
dc Gain Accuracy	$\pm 0.5\%$	Maximum Input Voltage	± 200 V[dc + peak ac (<20 MHz)]
Input Capacitance	<0.6 pF (typical)	ESD Tolerance (150 Ω/150 pF)	± 12 kV

Option 001

Type N (f) to 3.5 mm (f) adaptor
External thread 3.5 mm adaptor to securely connect HP 54701A probe to HP 54750 series plug-ins.

HP 33340 Attenuators

Using the Proper Attenuator

HP offers two families of ultra-high bandwidth fixed attenuators. The HP 33340C Series are dc to 26.5-GHz attenuators and use 3.5-mm connectors. The HP 33340D Series are dc to 50-GHz attenuators with 2.4-mm connectors. Use the 26.5-GHz attenuator family to attenuate input signals with rise times as fast as 30 ps for minimum time domain distortion. If the signals being analyzed are faster than this, the HP 33340D Series is recommended. When using the HP 33340D Series attenuators, use 2.4-mm to a 3.5-mm connector adapters.

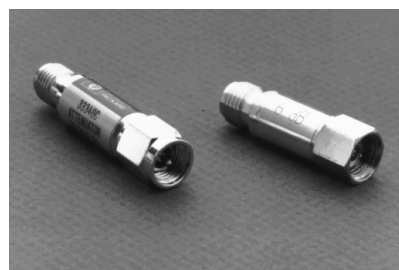

HP 33340C 26.5 GHz APC 3.5 mm attenuators (left)
HP 33340D 50 GHz 2.4 mm attenuators (right)
Includes a SMA(f) to BNC(m) adapter (HP 1250-2015)

HP 10086A ECL Terminator

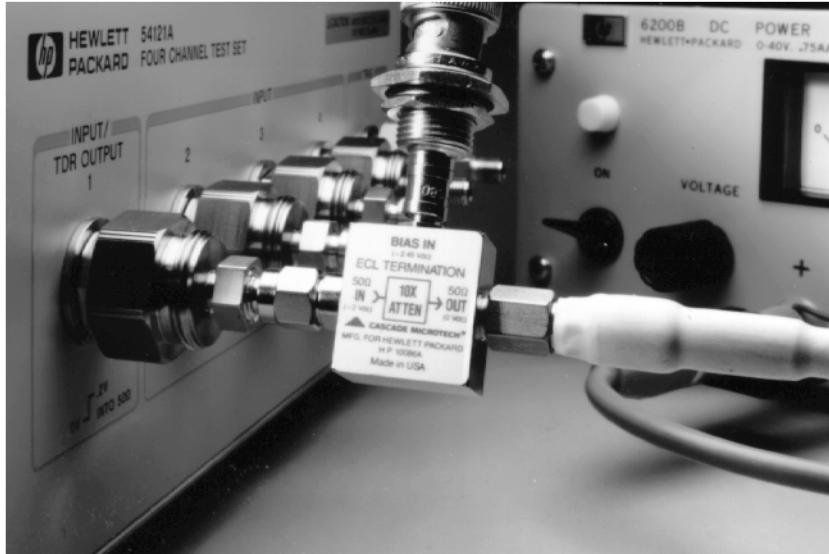

Application Description

ECL signals are normally offset from ground, while high frequency test equipment generally provides 50-Ω termination to ground. Attempting to connect an ECL signal directly to the test equipment could result in either damage to the ECL output or to the test equipment.

The HP 10086A ECL terminator provides an excellent interface between ECL outputs and test and measurement equipment. The terminator offsets and attenuates the signal sufficiently to protect the test equipment, while providing the proper termination voltage between the ECL circuit and the test equipment. The HP 10086A can also be used alone to properly load an ECL output. The ECL terminator is a precision adapter that is dc-coupled to the instrumentation. This allow direct measurement of your ECL signal. Power supply adjustment and capacitive or transformer coupling are no longer necessary with the ECL terminator. In addition, it is no longer necessary to float the instrumentation ground to -2 V, thereby reducing the hazards of power supply shorting and electrical shock or damage to the circuit.

The following is a list of accessories needed to assemble the configuration shown above:

- HP 1250-1857 SMB (f) to BNC (m) adapter
- HP 1250-0080 BNC (f) to BNC (f) adapter
- HP 10503A 48 inch BNC (m) cable
- HP 1251-2277 BNC (f) to dual banana jack
- HP 1250-1236 Panel Mount SMB (f) to BNC (f)

HP 10086A Specifications

Attenuation : 10X ± 1.0 % at dc or 20 db ± 3 db, dc to 10 GHz

Abberations : ± 3 % maximum, with 100 ps rise time

Maximum Input Voltage : ± 5 V on all inputs

Connectors :

- ECL input SMA (m)
- ECL output SMA (f)
- Bias input SMB (m)

The following table indicates the typical bias voltage required to set the proper termination voltage.

Bias Table

Vcc	Vee	Vterm	Vbias
0.00 V	-5.20 V	-2.00 V	-2.45 V
2.00 V	-3.20 V	0.00 V	0.00 V
5.20 V	0.00 V	3.20 V	3.92 V

Dimensions (including connectors) :

1.50 x 1.10 x 0.45 inches or 3.81 x 2.79 x 1.14 cm

HP 54006A 6 GHz Hand-held Probe

HP 54006A 6 GHz Hand-held Probe

The HP 54006A is a high frequency passive probe designed for probing high-speed logic and low impedance circuits. The probe has two tips that allow either 10:1, 500-Ω performance or 20:1, 1000-Ω performance. The capacitive loading at the probe tip is a small 0.25 pF.

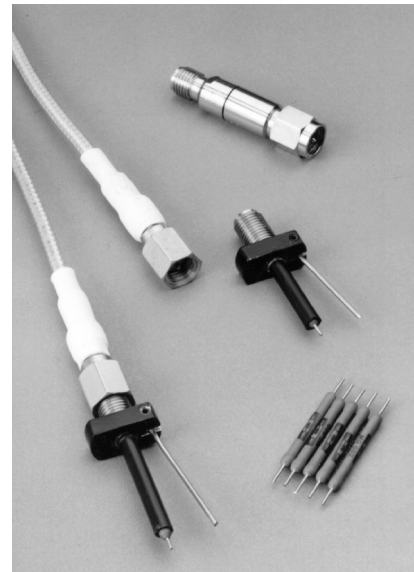

The HP 54006A is shipped with a dc Blocking Capacitor (HP 11742A) which can be used to remove a dc offset from a signal. The HP 54006A also contains an SMA(f) to BNC(m) adapter (HP 1250-2015). The two different tips included with each HP 54006A can be distinguished by their length. The 20:1 probe tip is longer than the 10:1 tip by about 0.2 inches.

The tips of the HP 54006A are replaceable. Kits of each tip can be obtained from HP under the following part numbers :

HP 54006-68701 Pack of 4, 450 Ω resistors probe tips for 10:1 probing and an extra sleeve.

HP 54006-68702 Pack of 4, 950 Ω resistors probe tips for 20:1 probing and an extra sleeve.

HP 11898A Module Extender

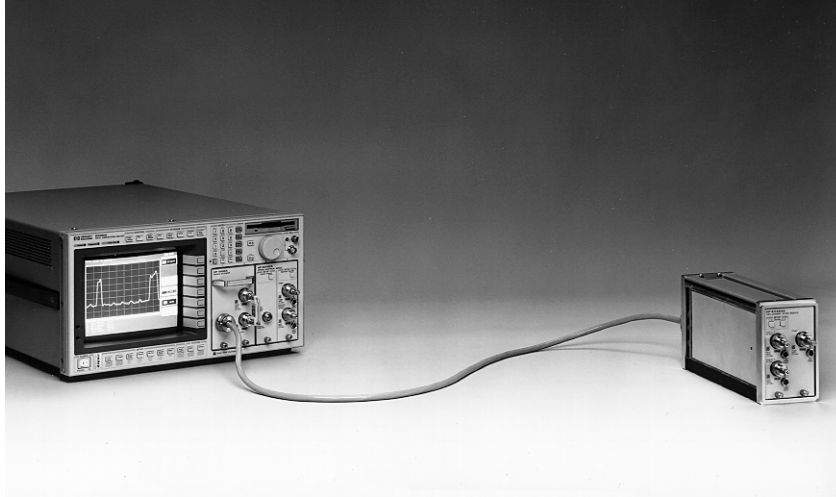

The HP 11898A module extender can be used with plug-in modules compatible with the HP 83480A and 54750A mainframes. The extender allows the plug-in to be placed up to 1.5 meters away from the mainframe. This allows users to make measurements on devices where the test device cannot be physically located close to the instrument mainframe. Examples include testing of very high-frequency electrical circuits where lengths of electrical cabling can degrade signal performance or for measurements where isolation from the mainframe is required to reduce vibration of the test device.

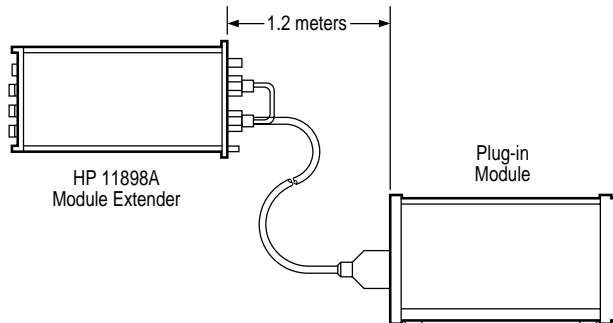

HP 11898A specifications and characteristics: There are no specifications for the HP 11898A extender module. Performance is characterized in terms of how it will affect operation of the mainframe and plug-in.

Operating temperature range: 15°C to 35°C

Warm-up time: 2 Hours

Time Base Delay: Minimum delay will be increased from a 22ns minimum to typically 40 ns when triggering at the remote module, 30 ns when triggering at the mainframe.

Trigger Sensitivity: Trigger sensitivity will be reduced by 4 dB at 2.5 GHz

Picosecond ATE Inc. 1202

Static Protection Unit from Picosecond ATE Inc.

The Picosecond ATE Inc. Static Protection Unit model 1202 offers static damage protection for TDR measurements. A foot switch or TTL signal allows connection of the device under test after static charge is removed. Risettime is <40 ps. In North America, contact Stu McNaughton at Picosecond ATE Inc. (503) 641-3295.

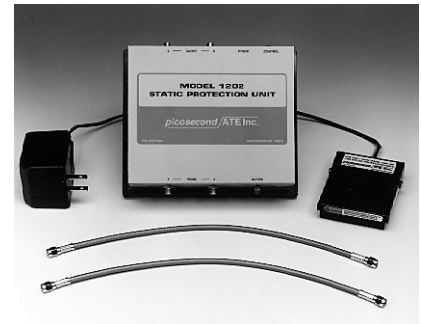

PicoSecond Pulse Labs 4015C

15-ps, 9 V External TDR or TDT Source

The PicoSecond Pulse Labs model 4015C pulse generator extends the TDR/TDT performance of the HP 54750 series oscilloscopes. The pulse generator produces a 15-ps fall time with an amplitude of 9 V, which can be triggered by any HP 54750 series TDR step generator. The HP 11667C power splitter is not included. Contact Dr. Jim Andrews at PSPL, P.O. Box 44, Boulder, CO 80306; (303) 443-1249.

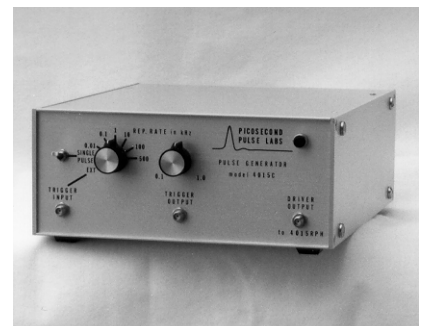

Ordering Information

HP 54750A Sampling Oscilloscope Mainframe

HP 54751A 2 channel 20 GHz plug-in
HP 54752A 2 channel 50-GHz plug-in
HP 54752B 1 channel 50-GHz plug-in
HP 54753A 2 channel plug-in w/ single-ended TDR
HP 54754A 2 channel plug-in w/ differential TDR

Options

0B1 Extra manual set
1CM Rack mount kit w/o handles
1CP Rack mount kit w/ handles

Accessories

HP 54006A 6 GHz divider probe
HP 54008A 22 ns delay line
HP 54118A 500 MHz to 18 GHz trigger
HP 10086A ECL terminator
HP 54007A Accessories Kit
HP 54121-68701 Mini accessories kit

Miscellaneous Connection Devices

HP 1250-1864 APC 3.5 (m-m) adapter
HP 1250-1747 APC 7 to APC 3.5(f) adapter
HP 1250-1468 APC 7 to SMA (f) adapter
HP 1250-1748 APC 3.5(m) to APC 3.5 (m) adapter
HP 1250-1744 N-type (m) to APC 3.5 (f) adapter
HP 1250-1250 N-type to SMA (f) adapter
HP 1250-1158 SMA (f-f) adapter
HP 1250-1159 SMA (m-m) adapter
HP 1250-1857 SMB (f) to BNC (m) adapter
HP 1250-0080 BNC (f) to BNC (f) adapter
HP 10503A 48 inch BNC male cable
HP 1250-2277 BNC (f) to dual banana jack
HP 1250-1236 Panel mount SMB (f) to BNC (f)
HP 1250-1876 15 cm beadless Airline
HP 11901A APC 3.5(m) to 2.4(m) Adapter
HP 11901D APC 3.5(m) to 2.4(f) Adapter
HP 11901C APC 3.5(f) to 2.4(m) Adapter
HP 11901B APC 3.5(f) to 2.4(f) Adapter
HP 909D APC 3.5(f) Precision 50Ω Termination

Miscellaneous 2.4 mm Accessories

HP 84904L 40 GHz Programmable Step Atten., 0-11 dB in 10 dB steps, 2.4 mm (f)
HP 84906L 40 GHz Programmable Step Atten., 0-70 dB in 10 dB steps, 2.4 mm (f)
HP 84907L 40 GHz Programmable Step Atten., 0-70 dB in 10 dB steps, 2.4 mm (f)
HP 11667C 50 GHz power splitter
Gore GD501501-012 40 GHz Cable (SMA connectors)*
Gore GDOAJ0AJ-012 GHz cable (2.4mm connectors)*
See HP publications #11900-90003 and #5953-2346 for additional 2.4-mm accessories
* Contact W.L. Gore and Associates Inc.

Fixed Attenuators

HP 33340C opt 003 3 dB fixed attenuator (APC 3.5)
HP 33340C opt 006 6 dB fixed attenuator (APC 3.5)
HP 33340C opt 010 10 dB fixed attenuator (APC 3.5)
HP 33340C opt 020 20 dB fixed attenuator (APC 3.5)
HP 33340C opt 030 30 dB fixed attenuator (APC 3.5)
HP 33340C opt 040 40 dB fixed attenuator (APC 3.5)
HP 33340D opt 003 3 db 50 GHz fixed attenuator (2.4mm)
HP 33340D opt 006 6 db 50 GHz fixed attenuator (2.4mm)
HP 33340D opt 010 10 db 50 GHz fixed attenuator (2.4mm)
HP 33340D opt 020 20 db 50 GHz fixed attenuator (2.4mm)
HP 33340D opt 030 30 db 50 GHz fixed attenuator (2.4mm)
HP 33340D opt 040 40 db 50 GHz fixed attenuator (2.4mm)

Step Attenuators

HP 8494B opt 002 Manual Step Atten, 0-11 dB 1 dB steps SMA(f)
HP 8495B opt 002 Manual Step Atten, 0-70 dB 10 dB steps SMA(f)
HP 33320H programmable Step Atten, 0-11 dB 1 dB steps SMA(f)
HP 33321H programmable Step Atten, 0-70 dB 10 dB steps SMA(f)

Connector Care

HP 8710-1582 5 in-lbs Torque Wrench
HP 8710-1765 8 in-lbs Torque Wrench
HP 5061-5311 Connector Saver

Power Splitter/Directional Coupler

HP 11667B Power Divider
HP 773D Directional Coupler

Preamp

HP 8447F Preamp - Power Amp (BNC)

Extending Your Oscilloscope's Channel Count

HP 3488A Switch/Control Unit
HP 44476A Microwave Switch Module incl. 3 HP 33311B switches
HP 33311B 2x1 18 GHz Switch, 50 ohms on unswitched inputs
HP 34531R Rack Mount Faceplate for HP 34531B switches
HP 6269B 40V, 50A Power Supply
HP 44471A 10 Channel General Purpose Relay Module
HP 44476B Microwave Switch Module
HP 34531B 6x1 18 GHz Switch, 50 ohms on unswitched inputs



For more information about Hewlett-Packard test and measurement products, applications, services, and for a current sales office listing, visit our web site, <http://www.hp.com/go/tmdir>. You can also contact one of the following centers and ask for a test and measurement sales representative.

United States:
Hewlett-Packard Company
Test and Measurement Call Center
P.O. Box 4026
Englewood, CO 80155-4026
1 800 452 4844

Canada:
Hewlett-Packard Canada Ltd.
5150 Spectrum Way
Mississauga, Ontario
L4W 5G1
(905) 206 4725

Europe:
Hewlett-Packard
European Marketing Centre
P.O. Box 999
1180 AZ Amstelveen
The Netherlands
(31 20) 547 9900

Japan:
Hewlett-Packard Japan Ltd.
Measurement Assistance Center
9-1, Takakura-Cho, Hachioji-Shi,
Tokyo 192-8510, Japan
Tel: (81) 426 56 7832
Fax: (81) 426 56 7840

Latin America:
Hewlett-Packard
Latin American Region Headquarters
5200 Blue Lagoon Drive, 9th Floor
Miami, Florida 33126, U.S.A.
Tel: (305) 267-4245
(305) 267-4220
Fax: (305) 267-4288

Australia/New Zealand:
Hewlett-Packard Australia Ltd.
31-41 Joseph Street
Blackburn, Victoria 3130, Australia
Tel: 1 800 629 485 (Australia)
0800 738 378 (New Zealand)
Fax: (61 3) 9210 5489

Asia Pacific:
Hewlett-Packard Asia Pacific Ltd.
17-21/F Shell Tower, Times Square,
1 Matheson Street, Causeway Bay,
Hong Kong
Tel: (852) 2599 7777
Fax: (852) 2506 9285

MS-DOS® is a U.S. registered trademark of Microsoft Corp.

**Data Subject to Change
Copyright © 1995
Hewlett-Packard Company
Printed in U.S.A. 10/98
5962-0097E**