

## Errata

**Title & Document Type:** 5347A/48A Microwave Counter/Power Meter  
Operating & Programming Manual

**Manual Part Number:** 05348-90025

**Revision Date:** December 1, 1995

---

### HP References in this Manual

This manual may contain references to HP or Hewlett-Packard. Please note that Hewlett-Packard's former test and measurement, semiconductor products and chemical analysis businesses are now part of Agilent Technologies. We have made no changes to this manual copy. The HP XXXX referred to in this document is now the Agilent XXXX. For example, model number HP8648A is now model number Agilent 8648A.

### About this Manual

We've added this manual to the Agilent website in an effort to help you support your product. This manual provides the best information we could find. It may be incomplete or contain dated information, and the scan quality may not be ideal. If we find a better copy in the future, we will add it to the Agilent website.

### Support for Your Product

Agilent no longer sells or supports this product. You will find any other available product information on the Agilent Test & Measurement website:

[www.tm.agilent.com](http://www.tm.agilent.com)

Search for the model number of this product, and the resulting product page will guide you to any available information. Our service centers may be able to perform calibration if no repair parts are needed, but no other support from Agilent is available.



**Operating and  
Programming  
Manual**

HP 5347A/48A  
Microwave Counter/  
Power Meter

---

AUSW

OPERATING AND PROGRAMMING MANUAL

---

# HP 5347A/48A

## Microwave Counter/Power Meter

**SERIAL NUMBER PREFIX: 3009**

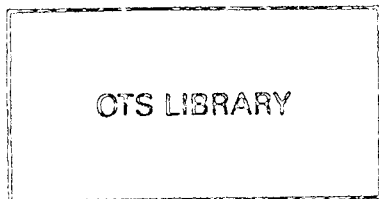

This manual applies to the following instruments:  
HP 5347A, Serial Number Prefix 3009  
HP 5348A, Serial Number Prefix 3009

If your HP 5347A/48A does not have the above serial prefix number, refer to the "Manual Changes" sheet for this manual.

For additional information about serial numbers, refer to INSTRUMENT AND MANUAL IDENTIFICATION in Section 1.

© Copyright HEWLETT-PACKARD COMPANY 1989, 1992, 1993, 1995  
5301 Stevens Creek Boulevard · Santa Clara, California 95052-8059

Printed: DECEMBER 1995



---

MANUAL PART NUMBER 05348-90025

**OTS LIBRARY**



2400011433

# Certification and Warranty

---

## **CERTIFICATION**

*Hewlett-Packard Company certifies that this product met its published specifications at the time of shipment from the factory. Hewlett-Packard further certifies that its calibration measurements are traceable to the United States National Institute of Standards and Technology (formerly National Bureau of Standards), to the extent allowed by that organization's calibration facility, and to the calibration facilities of other International Standards Organization members.*

## **WARRANTY**

This Hewlett-Packard instrument product is warranted against defects in material and workmanship for a period of one year from date of shipment. During the warranty period, Hewlett-Packard Company will, at its option, either repair or replace products which prove to be defective.

For warranty service or repair, this product must be returned to a service facility designated by HP. Buyer shall prepay shipping charges to HP and HP shall pay shipping charges to return the product to Buyer. However, Buyer shall pay all shipping charges, duties, and taxes for products returned to HP from another country.

HP warrants that its software and firmware designated by HP for use with an instrument will execute its programming instructions when properly installed on that instrument. HP does not warrant that the operation of the instrument, or software, or firmware will be uninterrupted or error free.

## **LIMITATION OF WARRANTY**

The foregoing warranty shall not apply to defects resulting from improper or inadequate maintenance by Buyer, Buyer-supplied software or interfacing, unauthorized modification or misuse, operation outside of the environmental specifications for the product, or improper site preparation or maintenance.

**NO OTHER WARRANTY IS EXPRESSED OR IMPLIED. HP SPECIFICALLY DISCLAIMS THE IMPLIED WARRANTIES OF MERCHANTABILITY AND FITNESS FOR A PARTICULAR PURPOSE.**

## **EXCLUSIVE REMEDIES**

**THE REMEDIES PROVIDED HEREIN ARE BUYER'S SOLE AND EXCLUSIVE REMEDIES. HP SHALL NOT BE LIABLE FOR ANY DIRECT, INDIRECT, SPECIAL, INCIDENTAL, OR CONSEQUENTIAL DAMAGES, WHETHER BASED ON CONTRACT, TORT, OR ANY OTHER LEGAL THEORY.**

## **ASSISTANCE**

*Product maintenance agreements and other customer assistance agreements are available for Hewlett-Packard products.*

*For any assistance, contact your nearest Hewlett-Packard Sales and Service Office. Addresses are provided at the back of this manual.*

# SAFETY CONSIDERATIONS

---

- GENERAL** This product and related documentation must be reviewed for familiarization with safety markings and instructions before operation.
- This product is a Safety Class I instrument (provided with a protective earth terminal)
- BEFORE APPLYING POWER** Verify that the product is set to match the available line voltage and the correct fuse is installed. Refer to Section II, Installation.
- SAFETY EARTH GROUND** An uninterruptible safety earth ground must be provided from the mains power source to the product input wiring terminals or supplied power cable.

## Safety Symbols

---



Instruction manual symbol; the product will be marked with this symbol when it is necessary for the user to refer to the instruction manual.



Indicates hazardous voltages.



Indicates earth (ground ) terminal)

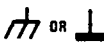

Indicates terminal is connected to chassis when such connection is not apparent.



Alternating current



Direct Current

### WARNING

---

**THIS DENOTES A HAZARD. IT CALLS ATTENTION TO A PROCEDURE, PRACTICE, OR THE LIKE, WHICH, IF NOT CORRECTLY PERFORMED OR ADHERED TO, COULD RESULT IN PERSONAL INJURY. DO NOT PROCEED BEYOND A WARNING SIGN UNTIL THE INDICATED CONDITIONS ARE FULLY UNDERSTOOD AND MET.**

### CAUTION

---

**This denotes a hazard. It calls attention to an operating procedure, practice, or the like, which, if not correctly performed or adhered to, could result in damage to or destruction of part or all of the product. Do not proceed beyond a CAUTION sign until the indicated conditions are fully understood and met.**

---

## Safety Information

---

### WARNING

Any interruption of the protective grounding conductor (inside or outside the instrument) or disconnecting the protective earth terminal will cause a potential shock hazard that could result in personal injury. (Grounding one conductor of a two conductor outlet is not sufficient protection.)

Whenever it is likely that the protection has been impaired, the instrument must be made inoperative and be secured against any unintended operation.

If this instrument is to be energized via an autotransformer (for voltage reduction) make sure the common terminal is connected to the earthed pole terminal (neutral) of the power source.

Instructions for adjustments while covers are removed and for servicing are for use by service-trained personnel only. To avoid dangerous electric shock, do not perform such adjustments or servicing unless qualified to do so.

For continued protection against fire, replace the line fuse(s) only with 250V fuse(s) of the same current rating and type (for example, normal blow, time delay). Do not use repaired fuses or short-circuited fuseholders.

When measuring power line signals, be extremely careful and always use a step-down isolation transformer whose output voltage is compatible with the input measurement capabilities of this product. This product's front and rear panels are typically at earth ground, so **NEVER TRY TO MEASURE AC POWER LINE SIGNALS WITHOUT AN ISOLATION TRANSFORMER.**

## **PRODUCT SAFETY NOTICE**

### **HP COUNTER/POWER METER MODEL 5347A AND 5348A PORTABILITY AND CARRYING STRAPS**

Hewlett-Packard has discovered that the use of carrying straps or other carrying appliances attached to the front handles may cause failure of the front panel casting.

**INJURY TO PERSONNEL AND/OR DAMAGE TO THE PRODUCT MAY OCCUR.**

In order to prevent injury or physical damage, **PLEASE DO NOT USE ANY STRAP OR CARRYING APPARATUS ATTACHED TO THE FRONT PANEL CASTING.**

**ALL USERS SHOULD BE CAUTIONED ABOUT THIS SITUATION.**

The user should carry the instrument **BY HAND**, via the casting handles or with the Option 070 Carrying Case, HP part number 05348-60214.

---

### **HP 5348A/5348A MICROWAVE COUNTER / POWER METER**

#### **ACOUSTIC NOISE EMISSION:**

LpA 47dB at operator position, at normal operation, tested per ISO 7779. All data result from type tests.

#### **GERAeUSCHEMISSION:**

LpA 47dB am Arbeits platz, normaler Betrieb, geprueft nach DIN 45635 Teil 19. Die Angaben beruhen auf Ergebnissen von Typpruefungen.

## DECLARATION OF CONFORMITY

according to ISO/IEC Guide 22 and EN 45014

**Manufacturer's Name:** Hewlett-Packard Company

**Manufacturer's Address:**

Santa Clara Division  
5301 Stevens Creek Boulevard  
Santa Clara, California 95052-8059  
U. S. A.

**declares, that the product**

**Product Name:** Microwave Frequency Counter/Power Meter

**Model Number(s):** HP 5347A

**Product Options:** This declaration covers all options  
of the above product.

**conforms to the following Product Specifications:**

**Safety:** HD 401/IEC 348

**EMC:** EN55011/CISPR 11 (Edition 2,1990) Group 1, Class A  
EN50082-1 / IEC 801-2 (Edition 1, 1984)  
/ IEC 801-3 (Edition 1, 1984)  
/ IEC 801-4 (Edition 1, 1988)

Santa Clara, California

1/6/92



-----  
Location

-----  
Date

-----  
Ian Band / QA Manager

## DECLARATION OF CONFORMITY

according to ISO/IEC Guide 22 and EN 45014

**Manufacturer's Name:** Hewlett-Packard Company

**Manufacturer's Address:**

Santa Clara Division  
5301 Stevens Creek Boulevard  
Santa Clara, California 95052-8059  
U. S. A.

**declares, that the product**

**Product Name:** Microwave Frequency Counter/Power Meter

**Model Number(s):** HP 5348A

**Product Options:** This declaration covers all options  
of the above product.

**conforms to the following Product Specifications:**

**Safety:** HD 401/IEC 348

**EMC:** EN55011/CISPR 11 (Edition 2,1990) Group 1, Class A  
EN50082-1 / IEC 801-2 (Edition 1, 1984)  
/ IEC 801-3 (Edition 1, 1984)  
/ IEC 801-4 (Edition 1, 1988)

Santa Clara, California

1/6/92



-----  
Location

-----  
Date

-----  
Ian Band / QA Manager



# TABLE OF CONTENTS

---

SECTION 1 MEET THE HP 5347A/48A	1-1.	Introduction .....	1-1
	1-2.	Brief description of the HP 5347A/48A.....	1-1
	1-3.	Instrument and manual Identification.....	1-2
	1-4.	How to use this manual.....	1-2
	1-5.	Options.....	1-4
	1-6.	Accessories supplied.....	1-4
	1-7.	Accessories available .....	1-5
SECTION 2 GETTING STARTED	2-1.	Simplified Operation .....	2-1
	2-2.	Power Alternatives.....	2-2
	2-3.	Power-Up Sequence.....	2-5
	2-4.	Making a Frequency Measurement .....	2-7
	2-5.	Making a Power Measurement .....	2-9
	2-6.	In case of trouble (before calling for service) .....	2-14
SECTION 3 OPERATOR'S REFERENCE	3-1.	Operating Characteristics Overview .....	3-1
	3-2.	Initial Power-Up Self Test .....	3-3
		What happens during Power-Up? .....	3-3
		What is Self Tested? .....	3-4
	3-3.	Front Panel Keys.....	3-5
		POWER Key.....	3-5
		Reset/Local Key .....	3-5
	3-4.	Frequency Counter Function Keys .....	3-6
		Input 2 50 $\Omega$ /1 M $\Omega$ Key .....	3-6
		Input 1 50 $\Omega$ Key.....	3-6
	3-5.	Power Meter Function Keys .....	3-7
		Zero Key .....	3-7
		Input dBm/Watt Key .....	3-8
	Calibrate/Store Frequency Key .....	3-8	
3-6.	Front Panel Display/ Connectors .....	3-10	
3-7.	Front Panel Display.....	3-10	
3-8.	Front Panel Annunciators .....	3-11	
3-9.	Front Panel Connectors .....	3-13	
	External Reference Input 10 MHz.....	3-13	
	High Frequency Input (INPUT 1) Connector .....	3-13	
	Low Frequency Input (INPUT 2) Connector .....	3-14	
	Power Ref Connector .....	3-15	
	Power Sensor Connector .....	3-15	
3-10.	Rear Panel Features.....	3-16	
	AC Line Power Module.....	3-17	
	EXT DC Input .....	3-18	

SECTION 3  
OPERATOR'S  
REFERENCE  
(CONTINUED)

	TCXO Adjustment.....	3-19
	HP-IB Connector (Option 011 Only).....	3-19
	HP-IB Address Switch (Option 011 Only) .....	3-19
	Battery Compartment and Option 002 Battery Pack.....	3-19
3-11.	Error Indications.....	3-21
	Overflow Warning.....	3-22
3-12.	Remote Programming Information For HP 5347A/48A With Option 011.....	3-23
3-13.	Diagnostics Mode Keys.....	3-23
	How are the Diagnostic Functions Called?.....	3-23

SECTION 4  
PERFORMANCE TESTS

4-1.	Introduction .....	4-1
4-2.	Operational verification .....	4-1
4-3.	Performance test.....	4-1
4-4.	HP-IB Verification (For Option 011).....	4-1
4-5.	Equipment Required.....	4-1
4-6.	Calibration cycle.....	4-2
4-7.	Test record.....	4-2
4-8.	Operational verification PROCEDURES.....	4-4
4-9.	Preliminary Procedure.....	4-4
4-10.	Power-Up Self Test.....	4-4
4-11.	Frequency Counter Checks.....	4-5
4-12.	Input 2, gating and counting check .....	4-5
4-13.	Input 2, 10 Hz-525 MHz input sensitivity check .....	4-6
4-14.	Input 1, 500 MHz-20 GHz [26.5 GHz for HP 5348A] Input Sensitivity Check.....	4-10
4-15.	Power Meter Checks.....	4-11
4-16.	Performance Test Procedures.....	4-14
4-17.	Frequency Counter Tests.....	4-14
4-18.	Input 2, 10 Hz-525 MHz Input Sensitivity Test .....	4-14
4-19.	Input 1, 500 MHz-20 GHz [26.5 GHz for HP 5348A] Input Sensitivity Test.....	4-16
4-20.	Automatic Amplitude Discrimination Test.....	4-20
4-21.	Fm Tolerance Test .....	4-21
4-22.	Power Meter Tests.....	4-25
4-23.	Power meter accuracy test .....	4-25
4-24.	Power meter reference level test .....	4-28
4-25.	HP-IB Verification (For Option 011).....	4-35

SECTION A  
INSTALLATION

A-1.	Introduction .....	A-1
A-2.	Unpacking And Inspection.....	A-1
A-3.	Preparation For Use .....	A-2
A-4.	Bench and Rack Operation.....	A-2
A-5.	AC Power Requirements.....	A-2

A-6.	AC Line Voltage and Fuse Selection .....	A-3
A-7.	Power Cord .....	A-4
A-8.	External DC Power Requirements .....	A-7
A-9.	Option 002 Battery Pack Power Requirements .....	A-8
A-10.	Operator's Maintenance .....	A-8
A-11.	Replacing INPUT 2 Fuse .....	A-9
A-12.	Replacing External DC Input Fuse .....	A-10
A-13.	Battery Care, Usage, And Disposal .....	A-10
A-14.	Battery Shelf Life and Storage .....	A-10
A-15.	Battery Operating Temperatures .....	A-11
A-16.	Battery Charging .....	A-12
A-17.	Battery Disposal.....	A-13
A-18.	Field Installations Of Options .....	A-13
A-19.	Installing/Replacing Option 002 Battery Pack .....	A-13
A-20.	Installing Option 011 HP-IB Interface Assembly.....	A-15
A-21.	Installing Option 913 Rack Mount.....	A-16
A-22.	Hewlett-Packard Interface Bus (HP-IB) .....	A-18
A-23.	HP-IB Interconnections .....	A-18
A-24.	HP-IB Address Selection .....	A-18
A-25.	HP-IB Descriptions.....	A-19
A-26.	Storage And Shipment.....	A-19
A-27.	Environment .....	A-19
A-28.	Packaging .....	A-19

APPENDIX B  
SPECIFICATIONS

B-1.	Introduction .....	B-1
------	--------------------	-----

APPENDIX C  
REMOTE  
PROGRAMMING VIA  
HP-IB (OPTION 011)

C-1.	Introduction .....	c-1
C-2.	Selecting the HP-IB address.....	C-2
C-3.	HP 5348A/48A Interface Capabilities.....	C-3
C-4.	Interface Commands.....	C-6
C-5.	Device Independent Commands .....	C-6
C-6.	Device Dependent Commands.....	C-6
C-7.	Meta Messages .....	C-8
C-8.	Checking Interface And Instrument Status .....	C-11
C-9.	Front Panel Interface Status Annunciators .....	C-11
C-10.	HP 5347A/48A Dual SRQ and Status Byte .....	C-11
C-11.	Overview of the dual SRQ and status byte .....	c-12
C-12.	Frequency counter srq and status byte .....	C-12
C-13.	Power Meter SRQ And Status Byte .....	C-14
C-14.	Status Bytes Bit Descriptions .....	C-15
C-15.	Service Request Mask for Frequency Counter .....	C-17
C-16.	Service Request Mask for Power Meter .....	C-18

REMOTE  
PROGRAMMING VIA  
HP-IB (OPTION 011)  
(CONTINUED)

C-17.	Data Input.....	C-18
C-18.	HP-IB Command Syntax Overview.....	C-19
C-19.	HP-IB Command Syntax Diagrams.....	C-20
C-20.	Command Headers (Command Mnemonics).....	C-21
C-21.	Command Separators .....	C-22
C-22.	Data Separators.....	C-23
C-23.	Data Formats .....	C-23
C-24.	Numeric Data.....	C-23
C-25.	Character Data .....	C-25
C-26.	String Data.....	C-25
C-27.	Data Output.....	C-26
C-28.	Frequency Measurements .....	C-26
C-29.	Power Measurements .....	C-26
C-30.	Diagnostic Results .....	C-27
C-31.	Other Outputs.....	C-27
C-32.	Numeric Output Format .....	C-28
C-33.	Query Output Formats .....	C-29
C-34.	Error Handling .....	C-29
C-35.	HP-IB Command Descriptions.....	C-30
C-36.	Frequency Counter Mode Command Set .....	C-35
C-37.	AUTO: Automatic Measurement Mode.....	C-35
C-38.	DUMP: Dump Mode.....	C-35
C-39.	ERR?: Send Error Number .....	C-37
C-40.	HIGHZ: Input 2, 1M $\Omega$ Measurement Mode.....	C-37
C-41.	LOWZ: Input 2, 50 $\Omega$ Measurement Mode .....	C-37
C-42.	MANUAL: Manual Measurement Mode.....	C-38
C-43.	REF?: Send Timebase Reference Status .....	C-38
C-44.	RESOL{0,4}: Resolution 1 Hz Or 10 KHZ .....	C-39
C-45.	SAMPLE: Sample Rate.....	C-39
C-46.	SLEEP: Disable Input 1 Circuit.....	C-39
C-47.	SRQMASK: Set Counter Service Request Mask Value .....	C-40
C-48.	STORE: Store Frequency Value .....	C-41
C-50.	TRIGGER AND TRG: Trigger .....	C-41
C-50.	TRIGGER AND TRG: Trigger .....	C-42
C-51.	Power Meter Mode Command Set .....	C-42
C-52.	CL: Calibrate .....	C-42
C-53.	CS: Clear Power Meter Status Byte.....	C-43
C-54.	EN: Enter Number.....	C-43
C-55.	LG: Logarithmic (DBM) Mode .....	C-44
C56.	LN: Linear (Watts) Mode .....	C-44
C57.	MOD?: Send power meter measurement mode (dBm or Watts) .....	C-44
C58.	OC0/OC1: Reference Oscillator Off/On .....	C-44

C-59.	OSC?: Send Oscillator Status .....	C-45
C-60.	PERR?: Send Power Meter Error Number .....	C-46
C-61.	PR: Preset.....	C-46
C-62.	PTRG:: Send Power Meter Trigger Mode .....	C-47
C-63.	RA: Auto Range .....	C-47
C-64.	RM{1-5}: Manual Range.....	C-48
C-65.	RNG?: Send Range Setting.....	C-48
C-66.	SENSOR?: Send Sensor Identification Number .....	C-49
C-67.	SRE: Set Power Meter Service Request Mask Value.....	C-50
C-68.	TR{C-3}: Triggering .....	C-51
C-69.	ZE: Zero .....	C-53
C-70.	Commands Common to Both Measurement Modes.....	C-55
C-71.	CLR: Instrument Clear.....	C-55
C-72.	DIAGENT: Enter Diagnostics Mode.....	C-56
C-73.	DISPLAY: Display Message/Conceal Message.....	C-56
C-74.	ID?: Send Instrument Identification .....	C-57
C-75.	INIT: Complete Instrument Initialization.....	C-57
C-76.	KEY?: Send Number Of Key Pressed .....	C-58
C-77.	RESET .....	C-58
C-78.	SET: Recall/Set Instrument Setup.....	C-59
C-79.	SET?: Send/Save Current Instrument Setup .....	C-59
C-80.	Diagnostics Mode Command Set.....	C-60
C-81.	DIAG: Diagnostics.....	C-60
C-82.	DIAGPARAM: Diagnostic Parameter .....	C-60
C-83.	DIAG?: Send Diagnostic Result.....	C-61
C-83.	MEASENT: Enter Measurement Mode .....	C-61
C-85.	Programming Examples.....	C-62

## MEET THE HP 5347A/48A

---

### 1-1. INTRODUCTION

This manual contains the information necessary to install and operate the Hewlett-Packard Model 5347A/48A Microwave Counter/Power Meter.

### 1-2. BRIEF DESCRIPTION OF THE HP 5347A/48A

The HP 5347A/48A is a portable instrument that provides high performance microwave frequency and power measurements with simple, easy-to-use front panel keyboard operations. Frequency and power measurements made by the HP 5347A/48A are a synergistic combination whereby the frequency measurements are used to enhance the accuracy of the power meter. In addition, both measurements may be used independently if desired.

The HP 5347A measures frequency from 10 Hz to 20 GHz and power from  $-70$  dBm to  $+20$  dBm (or 100 picowatts to 100 milliwatts) over a frequency range of 10 MHz to 20 GHz\* (power and frequency ranges depends on sensor used). The HP 5348A instrument is similar to the HP 5347A, with the HP 5348A having an extended measurement range of 10 Hz to 26.5 GHz.

An optional HP-IB interface assembly is available with the HP 5347A/48A. This assembly provides remote control of measurement functions and data output. All front panel features are available via the HP-IB, except power ON and OFF. An optional battery pack is available with the HP 5347A/48A. The battery pack operation provides true portable operation for field or remote site service, with charging circuitry internal to the instrument.

Operating features, characteristics, functions of controls and indicators, and local operation are described in detail in Section 3, OPERATOR'S REFERENCE. General remote programming information is also described in Section 3; however, the details of remote programming are described in Appendix C.

---

\* Power measurements can be made to frequencies up to 26.5 GHz with the HP 5347A if an HP 8485A sensor is used; however, power accuracy is not specified for frequencies beyond 20 GHz.

**1-3.  
INSTRUMENT AND  
MANUAL  
IDENTIFICATION**

Instrument identification is by a serial number located on the rear panel of the HP 5347A/48A. Hewlett-Packard uses a two-part serial number with the first part (prefix) identifying a series of instruments and the second part (suffix) identifying a particular instrument within a series. An HP assigned alpha character between the prefix and suffix identifies the country in which the HP 5347A/48A was manufactured.

If the serial prefix of your instrument differs from that listed on the title page of this manual, there are differences between this manual and your instrument. Instruments having a higher serial prefix are covered in a "Manual Changes" sheets included with this manual. If the change sheet is missing, contact the nearest Hewlett-Packard Sales and Support Office listed at the back of this manual. Instruments having a lower serial prefix than that listed on the title page are covered in Section 7 of the Service manual.

**1-4.  
HOW TO USE THIS  
MANUAL**

This Operating and Programming Manual is a complete reference document for using the HP 5347A/48A as a solution to your measurement needs. The installation information is placed at the back of the manual in Appendix A. If this is your first time using the HP 5347A/48A, you should read the important information in Appendix A first.

A separate Service Manual that contains the information on operational verification, performance tests, adjustments, replaceable part lists, manual changes, troubleshooting, theory of operation, component locators, and schematic diagrams is available. The Service Manual (HP Part Number 05348-90003) can be ordered by itself or as part of the Service Accessory Kit (05348-67001), which contains the necessary service accessories to test and repair the instrument. The Service Manual and/or Service kit and additional copies of this manual can be ordered through your nearest Hewlett-Packard Sales and Support Office. In addition to the Operating and Programming Manual, a Quick Reference Guide decal is provided with each HP 5347A/48A.

Familiarize yourself with the HP 5347A/48A by looking through this manual. The best way to feel at ease with the instrument is to sit down with this manual and the HP 5347A/48A and review all the sections.

The following paragraphs will serve as a guide to direct you to the sections in this manual. Acquaint yourself with this manual before operating your HP 5347A/48A Microwave Counter/Power Meter.

**SECTION 1 – MEET THE HP 5347A/48A:** describes the instrument documented by this manual, and covers instrument identification, manual content, options, and accessories.

**SECTION 2 – GETTING STARTED:** helps you quickly set up and operate your instrument, referring you to specific installation instructions, and provides two basic measuring examples to help familiarize you with the operation of the HP 5347A/48A. A subsection titled "In Case of Trouble" is included in this section that assists you in solving some operational problems that may occur.

**SECTION 3 – OPERATOR'S REFERENCE:** describes each function and feature of the HP 5347A/48A in detail.

**SECTION 4 – PERFORMANCE TESTS:** provides abbreviated procedures for operational verification, which give the operator a high degree of confidence the instrument is operating properly. Section 4 also provides performance tests, which check the performance of the instrument against the specifications listed in Appendix B.

**APPENDIX A – INSTALLATION:** includes information on initial inspection, preparation for use, instrument connection, fuse replacement, field installation of the Battery and HP-IB options, operator's maintenance, and shipping and storage.

**APPENDIX B – SPECIFICATIONS:** contains the specifications for the HP 5347A/48A Microwave Counter/Power Meter. When testing the instrument or performing calibrations, refer to this appendix for the proper values.

**APPENDIX C – REMOTE PROGRAMMING VIA HP-IB (OPTION 011):** describes in detail the HP-IB programming capabilities of the HP 5347A/48A.



**1-5.  
OPTIONS**

The options available for the HP 5347A/48A Microwave Counter/Power Meter are listed and described following this paragraph. Specifications are given in Appendix B. If the Option 011 (HP-IB) is included in the initial order, it will be installed at the factory and ready for operation upon receipt of the instrument. Option 002 (Battery Pack) must be installed and charged. Refer to Appendix A for battery installation and operation. For field installation of Options 011 and 913, refer to Appendix A.

**Option Description**

002	Battery Pack
006	Limiter
011	HP-IB Interface Assembly (A11), HP Part Number 05350-60011
070	Carrying Case, HP Part Number 05348-60214
913	Rack Mount Kit
915	Service Manual
916	Additional Operating and Programming Manual
W30	Extended Hardware Support (Adds two years of return-to-HP Hardware Service)
W32	Three year return-to-HP for calibration.

**1-6.  
ACCESSORIES  
SUPPLIED**

The HP 5347A/48A is supplied with the following accessories:

- Detachable line power cord\*
- 1.5 metre (5 ft) Power Sensor cable, HP 11730A

---

\* The line power cord supplied will have one of six possible line (mains) connectors, depending on the country of destination. Refer to Table A-1, AC Power Cords Available, for the part number or the appropriate cord.

**1-7.  
ACCESSORIES  
AVAILABLE**

Table 1-1 lists accessories available for the HP 5347A/48A.  
Table 1-2 lists the contents of the Service Accessories Kit.

Table 1-1. Accessories Available

DESCRIPTION		HP PART NUMBER
Power Sensor	-30 to +20 dBm over frequency range of 10 MHz to 18 GHz	HP 8481A
Power Sensor	-30 to +20 dBm over frequency range of 50 MHz to 26.5 GHz	HP 8485A
Power Sensor	-70 to -20 dBm over frequency range of 10 MHz to 18 GHz	HP 8484A*
50 MHz Reference Attenuator (furnished with the HP 8484A)	30 dB Attenuation	HP 11708A
Power Sensor Cable	3.0 metres (10 ft) (longer lengths are available)	HP 11730B
Coaxial Adapter (furnished with the HP 8485A)	N-type male to SMA female, 50Ω	HP 1250-1250
Service Accessories Kit	Contents of this kit are listed in Table 1-2.	05348-67001
SMA Adapter	Female-to-Female	1250-1158

\* The HP 8481D sensor can be substituted for the HP 8484A sensor, and it provides identical frequency and power ranges.

Table 1-2. HP 5347A/48A Service Accessories Kit (05348-67001) Contents

ACCESSORY	HP PART NO.	DESCRIPTION AND USE
Extender Boards (2 each)	5060-0175	50-pin dual connector extender board used for A2, A3, A5, A6, and A7 assemblies.
Extender Boards (2 each)	05361-60050	60-pin dual connector extender board for A4 assembly.
Extender Cable or A5 Assembly	05350-60102	SMB (male) to SMB (female) identical to W2 cable in the instrument, but is not attached to a metal RF shielding cover. Allows connection of A5 Synthesizer Assembly output (W2) to Microwave Module when A5 Assembly is mounted on an extender board, outside of RF shielding can.
IF Test Cable	05350-60121	90° SMB (female) to BNC (male). Allows viewing of Microwave Module IF output (A12J1) with spectrum analyzer or oscilloscope.
LO Test Cable	05350-60120	90° SMB (male) to BNC (male). Allows viewing of LO output (W2) of A5 Synthesizer Assembly with a spectrum analyzer. Also used for viewing the 10 MHz and IF test ports on the motherboard.
HP-IB Interface	05350-60011	HP-IB Interface Assembly (A11) allows testing via a controller. (Used during Troubleshooting with HP 5347A/48As sold without HP-IB option.)
HP-IB Verification Diskettes	05348-13502 (5¼ inch) 05348-13501 (3½ inch)	5 ¼-inch and 3½-inch floppy disc with HP 5347A/48A HP-IB Verification Tests written in BASIC.
Service Manual	05348-90003	This manual contains information that describes how to test and repair the HP 5347A/48A.
Operating and Programming Manual	05348-90022	This manual contains information that describes how to operate and program the HP 5347A/48A.

## GETTING STARTED

### 2-1. SIMPLIFIED OPERATION

The HP 5347A/48A is the synergistic combination of a Frequency Counter and a Power Meter. Measurements made in the Frequency Counter mode can be used by the HP 5347A/48A to calibrate the power sensor, giving greater Power Meter accuracy. In addition, both modes of the HP 5347A/48A may be used independently if desired.

The getting started procedures in Sections 2-4 and 2-5 demonstrate both the independence and synergism of the Frequency Counter and Power Meter modes.

Referring to *Figure 2-1*, the frequency counter may be activated by pressing either the **Input 1 50Ω** or **Input 2 50Ω/1MΩ** keys. The power meter is activated by pressing the **Input dBm/Watt** key. Note that the **Calibrate/Store** key has a different function, depending on the active mode (frequency counter or power meter). The functions of the frequency counter and power meter keys are briefly discussed in the overview of the procedures.

*Figure 2-1.*  
HP 5347A/48A  
Front Panel Keys

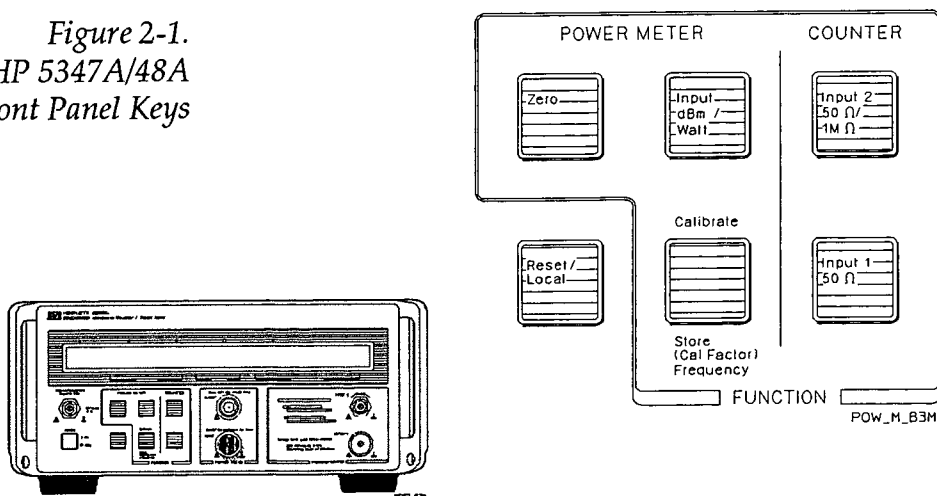

The procedures in this section are organized as follows:

- Power Alternatives, Section 2-2
  - AC Line Operation
  - External DC Operation
  - Battery Operation (Option 002 Only)
- Power-Up Sequence, Section 2-3
- Making a Frequency Measurement, Section 2-4
  - Overview of the Frequency Counter
  - Frequency Measurement Procedure
- Making a Power Measurement, Section 2-5
  - Overview of the Power Meter
  - Precision Power Measurement Procedure
- In Case of Trouble, Section 2-6

## 2-2. Power Alternatives

When necessary, refer to the foldout page 3-25 of Section 3 for illustrations of *all* of the front and rear panels features.

The HP 5347A/48A can be powered from several different sources:

- AC line
- External DC voltage (+12 to +26V dc; +14 to +26V dc for Series 2922 through 2924)
- Internal battery (Option 002)

The HP 5347A/48A can operate with both ac and external dc sources simultaneously connected. If the external dc source becomes weak, the ac source will operate the instrument, but the instrument may reset to power-up state. HP 5347A/48A instruments will operate off the battery **only if the instrument is not connected to either an ac or dc source.**

**AC LINE OPERATION.** *Before applying ac power to the HP 5347A/48A, check the rear panel line voltage selection to be certain the instrument is set for the nominal line voltage in your area. If necessary, refer to the installation information in Appendix A.*

Plug one end of the line power cord into the "AC Input" jack on the rear panel of the HP 5347A/48A, and the opposite end into the appropriate ac outlet (socket) to operate the instrument.

## EXTERNAL DC OPERATION.

### CAUTION

---

***When using the EXT. DC INPUT, always use a fused power supply and 18 AWG (minimum) connecting wires. Be sure that the binding post thumb nuts are tight over the wire connections. Do not use the standard exposed banana plugs. Some dc supplies, such as automotive batteries, are capable of high current, and can be a fire hazard if the terminal wires or the exposed plugs become loose, and short to each other or to a conductive surface.***

***Be careful to strip back the insulation of each connecting wire not more than 0.5 inches on the end of the wires that will be inserted into the hole of the binding posts.***

***The maximum wire size that can fit through the hole in the binding posts is 12 AWG.***

---

Attach connecting wires to the EXT. DC INPUT binding posts located on the rear panel. Observing the correct polarity, attach the other ends of the wires to a dc source (+12 to +26V dc; +14 to +26V dc for Series 2922 through 2924) to operate the instrument. If necessary, refer to Appendix A, INSTALLATION, for more information.

**BATTERY OPERATION (Option 002 Only).** When both the ac line and external dc source are disconnected from the HP 5347A/48A, the instrument will automatically switch to battery operation. The HP 5347A/48A is NOT designed for uninterrupted operation. If the ac and dc sources are disconnected while HP 5347A/48A is operating, the instrument will switch to battery operation, but may reset to its power-up state.

HP 5347A/48A instruments with Option 002 are shipped with the battery pack not installed. To install and charge the battery pack perform the following:

1. Turn off the HP 5347A/48A, and disconnect the ac power line cord.

2. Loosen the two screws that hold the rear panel battery compartment door in place, and remove the door. The screws are retained in the door.
3. Remove protective cap from terminal end of battery and save cap for re-use when battery is removed from instrument.
4. Note that the back wall of the battery compartment has a connector strip mounted to it. There are two contacts on the right side of the connector that must make contact with the two exposed terminals on the battery pack. **Insert the battery pack in such a way that the battery terminals meet the contacts.**
5. Reinstall the battery compartment door, and tighten the holding screws.
6. Apply ac line power to the HP 5347A / 48A, and set **POWER** key to standby mode (OFF). This starts the charging of the battery. To fully charge the battery pack, keep the instrument connected to the ac line with **POWER** key in Standby mode for 12 to 16 hours.

Refer to Appendix A, INSTALLATION, for detailed information on battery care, useage, storage, installation, and charging.

**2-3. Power-Up Sequence**

Check the rear panel 7-position DIP switch, as shown in *Figure 2-2*. Make sure switch "1" is set to the Measurement (Meas.) Mode ("down" position).

*Figure 2-2.*  
HP 5347A/48A  
Rear Panel  
7-position  
DIP Switch

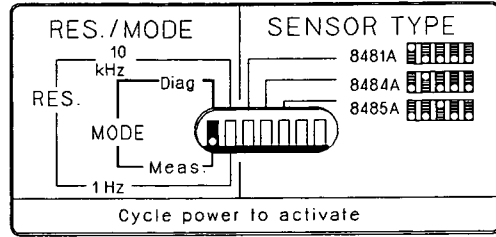
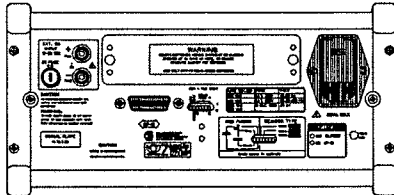

Press the **POWER** key. The HP 5347A/48A will perform a complete internal self test, and all segments and annunciators of the Liquid Crystal Display (LCD) will light for about 3 seconds ...

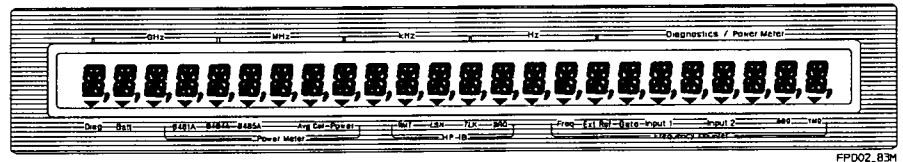

after which the current HP-IB address will be displayed for 5 seconds ...

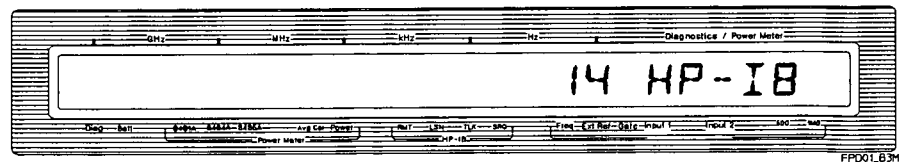



If the Option 011 HP-IB Interface is not installed in the HP 5347A/48A, then the display will be ...

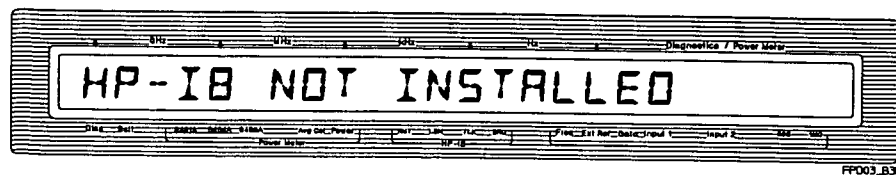

The above message is displayed for 1 second, and the remaining tests are continued.

On successful completion of all tests, the HP 5347A/48A will display ...

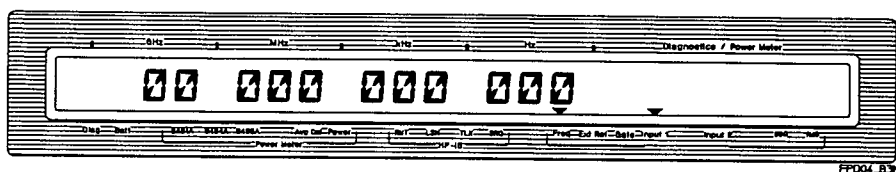

The HP 5347A/48A presets to its frequency COUNTER mode, at **Input 1 50Ω**.

Should any element of the self test fail, a message will be displayed identifying the general circuit area where the failure occurred. This can greatly reduce initial troubleshooting time. In the event of a failure, refer to Section 2-6, IN CASE OF TROUBLE.

The entire power-up self test takes about 10 seconds to complete.

If the power-up self test passed, perform the procedure in Section 2-4, Making a Frequency Measurement.

## 2-4. Making a Frequency Measurement

### CAUTION

*Do not exceed +25 dBm (peak) input power (or  $\pm 4V$  dc) at the INPUT 1 connector. Damage to the internal sampler may occur.*

*An overload indication may appear on the front panel display under high input signal conditions. A power meter that is capable of measuring power greater than +25 dBm must be used to ensure that the input signal level does not exceed INPUT 1 specifications. DO NOT DEPEND ON THE OVERLOAD INDICATION FOR THIS PURPOSE.*

### CAUTION

*The INPUT 2 BNC connector (10 Hz to 525 MHz) is protected by a fuse from input levels which exceed the specified damage level of 5.5V rms (+28 dBm). If fuse is blown, refer to Appendix A, INSTALLATION, for instructions on how to change the front panel fuse.*

**OVERVIEW OF THE FREQUENCY COUNTER.** Measuring frequency with the HP 5347A/48A is simple and automatic. The HP 5347A/48A has two COUNTER function keys and two COUNTER INPUTS.

- Use INPUT 1 to measure signals within the 500 MHz to 20 GHz or 26.5 GHz (depending on instrument) frequency range. Pressing **Input 1 50 $\Omega$**  key enables measurement of a signal connected to INPUT 1. INPUT 1 is the power-up mode (or default state of the Counter). Pressing **Reset/Local** key always returns the HP 5347A/48A to this state.
- Use INPUT 2 to measure signals within the 10 Hz to 525 MHz frequency range. Pressing **Input 2 50 $\Omega$ /1M $\Omega$**  key selects INPUT 2 and toggles between two functions:
  - 1 M $\Omega$  input for frequencies of 10 Hz to 80 MHz
  - 50 $\Omega$  input for frequencies of 10 MHz to 525 MHz
- Use the **Calibrate/Store** key to store frequency measurements for use with precision power measurements. Hence, when the HP 5347A/48A is

in the Frequency Counter mode, only the **Store** function of the **Calibrate/Store** key will operate.

The following procedures show how to measure frequency of an input signal connected to INPUT 1 and INPUT 2.

### FREQUENCY MEASUREMENT PROCEDURE

#### Input 1 50 $\Omega$

1. Connect a signal to INPUT 1 connector.
2. Make sure the HP 5347A/48A is powered on.
3. Observe the measured frequency in the HP 5347A/48A display.

#### Input 2 50 $\Omega$ /1M $\Omega$

1. Connect a signal to INPUT 2 connector.

INPUT 2 has two options: 1M $\Omega$  input impedance (10 Hz to 80 MHz) and 50 $\Omega$  input impedance (10 MHz to 525 MHz).

2. Press **Input 2 50 $\Omega$ /1M $\Omega$**  key. (Note that pressing this key for the first time sets the input impedance to 50 $\Omega$  as indicated by the front panel 50 $\Omega$  annunciator, shown in the figure below; pressing this key again sets the input impedance to 1 M $\Omega$ .) Select the desired input impedance.

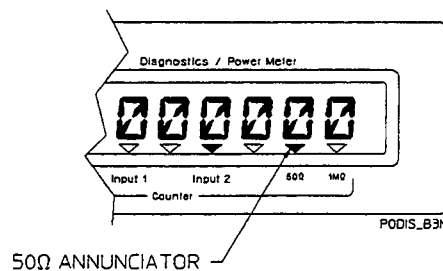

3. Observe the measured frequency in the HP 5347A/48A display.

## 2-5. Making a Power Measurement

**OVERVIEW OF THE POWER METER.** The HP 5347A/48A has automatic calibration routines built into the firmware that free you from the tedious task of number entry for power sensor calibration factor correction.

The **Input dBm/Watt** key puts the instrument into the Power Meter mode and also selects the units (dBm/Watt) in which a power measurement is made.

The **Calibrate/Store** key **Calibrates** the power meter and the power sensor to the front panel power reference.

The **Zero** key zeroes the power meter circuitry when the instrument is in the Power Meter mode.

**POWER SENSOR USE.** For making power measurements, three power sensors are available: HP 8481A, HP 8484A, and HP 8485A. The use of these sensors is described below.

- Use an HP 8481A Power Sensor to measure microwave power levels from  $-30$  to  $+20$  dBm (or 1 microwatt to 100 milliwatts) over the frequency range of 10 MHz to 18 GHz.
- Use an HP 8485A Power Sensor\* to measure microwave power levels from  $-30$  to  $+20$  dBm (or 1 microwatt to 100 milliwatts) over the frequency range of 50 MHz to 20 GHz or 26.5 GHz (depending on instrument). A 50-Ohm Coaxial Adapter (N-type male to SMA female, HP Part Number 1250-1250) is furnished with the HP 8485A to allow precise calibration with the 1 mW reference oscillator in the HP 5347A/48A.
- Use an HP 8484A Power Sensor\*\* to measure microwave power levels down to picowatts over a frequency range of 10 MHz to 18 GHz. Its power range is  $-70$  to  $-20$  dBm (or 100 picowatts to 100 microwatts). An HP 11708A 50 MHz, 30 dB Reference Attenuator is furnished with the HP 8484A for precise calibration with the 1 mW reference oscillator in the HP 5347A/48A.

There are two types of power measurements that can be made: approximate or precision.

\* Power measurements can be made to frequencies up to 26.5 GHz with the HP 5347A if an HP 8485A sensor is used; however, power accuracy is not specified for frequencies beyond 20 GHz.

\*\* The HP 8481D sensor can be substituted for the HP 8484A sensor, and it provides identical frequency and power ranges.

**NOTE**

---

*If the HP 5347A/48A experiences an environmental temperature change greater than 5°C (9°F), power meter accuracy may be affected. To assure power meter accuracy at the new temperature, do the following:*

- 1. With power off, allow the HP 5347A/48A to stabilize at the new temperature for 15 minutes (30 minutes if the power sensor is an HP 8484A or 8484D).*
- 2. Power up the HP 5347A/48A and allow it to stabilize for an additional 5 minutes.*
- 3. Perform power meter zero and calibration procedures.*

---

**For approximate power measurements**, simply connect the input signal to the sensor and press **Input dBm/Watt** key. Note this type of power measurement may not meet the accuracy specifications but can be used for either a close indication or for tuning.

**For precision power measurements**, the following things must be checked:

- Determine if the Power Meter needs to be zeroed by removing any power to the sensor, and then read the display. If the display is not within  $\pm 0.05 \mu\text{W}$ , zeroing is needed.

Any residual nonzero reading, if not corrected, will be added to all subsequent measurements, resulting in an error. This error may be insignificant when measuring moderate to high power values, but it can be unacceptable when measuring low power values.

- Calibrate the power sensor to the internal reference, if needed. Calibration must be performed whenever the sensor is changed, after power-up, when the temperature changes (by more than 5°C), after "INIT" HP-IB command, or at least once per day.

The following procedure shows how to make precision power measurements.

## PRECISION POWER MEASUREMENT PROCEDURE

1. With the instrument OFF, set the power sensor switches of the rear panel DIP switch, shown in figure below, to select the appropriate power sensor.\*

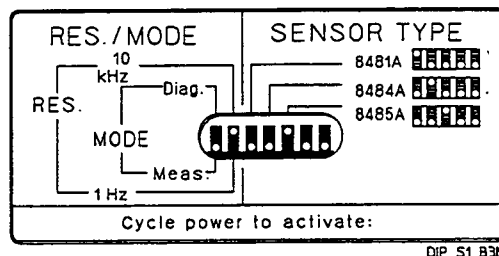

2. Connect the power sensor and cable to the HP 5347A/48A as shown in Figure 2-3. Note that the sensor is connected to the **Power Ref.** connector as shown by the arrow in the Figure 2-3.

Figure 2-3.  
Zeroing and  
Calibration Setup

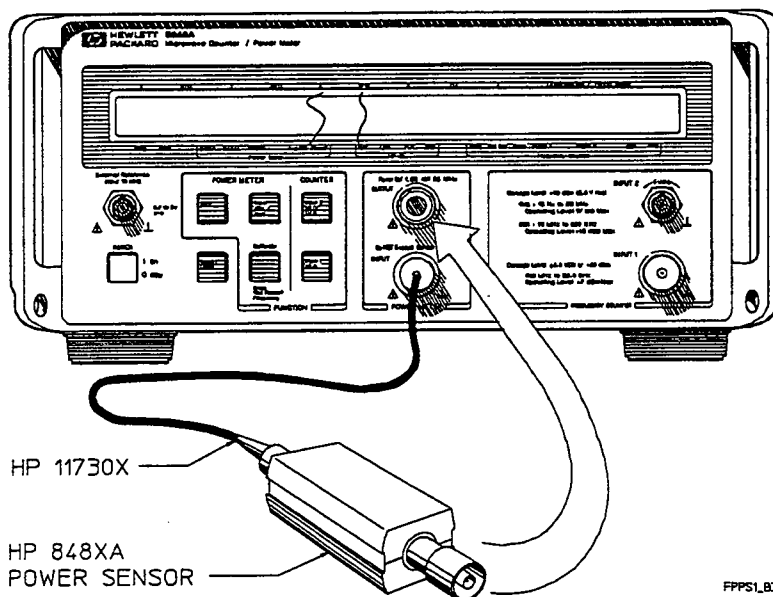

3. Press **POWER** key to turn the instrument ON. Allow the power-up cycle to complete.
4. Perform the steps described in Section 2-4 (Making a Frequency Measurement), and press **Calibrate/Store** key to store the measurement.
5. Press **Input dBm/Watt** key to take the instrument out of the Counter mode and put it into the Power Meter mode.

\* When using an HP 8481D sensor, configure the instrument for HP 8484A sensor operation.

Figure 2-4.  
Example Display With  
Zero Power Reading

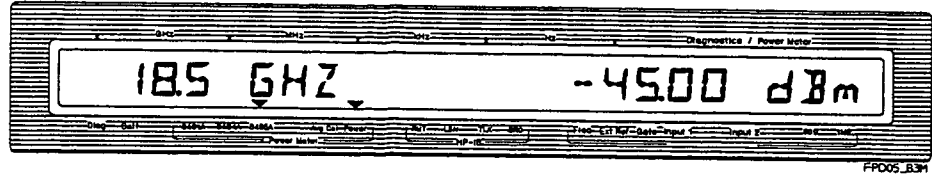

6. Press **Zero** key. Observe the "ZEROING" message in the display during the process, which takes from 10 to 20 seconds. When completed, the instrument will begin making power measurements and should display a residual reading lower than -43 dBm if the HP 8481A or 8485A Power Sensors are used as shown in Figure 2-4. (The "18.5 GHz" in Figure 2-4 is the frequency stored, which is measured in the Frequency Counter mode — the 18.5 GHz is only displayed as an example.) If an HP 8484A Power Sensor is used, a residual reading lower than -75 dBm will be displayed. Note: always use the HP 11708A 30 dB Reference Attenuator with the HP 8484A sensor. If the attenuator is not used, the "CANNOT CALIBRATE" message will be displayed.

Figure 2-5.  
Measuring the  
Power of the Input  
Signal

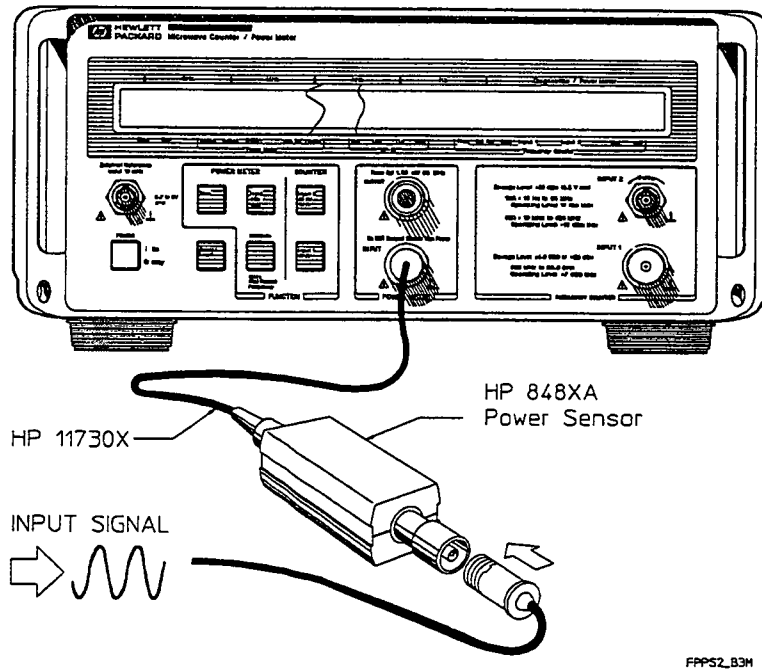

7. Press **Calibrate/Store** key to calibrate the power meter. Observe the "CALIBRATING" message in the display during the process, which takes about 5 seconds.

---

**NOTE**

*The 50-mHz, 1-mw power reference oscillator output is present ONLY during the actual calibration routine. It is off at all other times. It can be turned on manually via HP-IB, or via a diagnostic (see page 4-29 and 4-30 of this manual).*

---

---

**CAUTION**

***BEFORE CONNECTING THE POWER SENSOR TO ANOTHER INSTRUMENT OR RF GENERATOR, ensure that the instrument or RF generator and the Power Meter are properly connected to a protective (earth) ground.***

***To prevent damage to the Power Sensor, no more than 20 Vdc may be applied between the center conductor of the RF connector and ground. (A blocking capacitor in the Power Sensor prevents the flow of dc current.)***

***Do not apply torque to the Power Sensor's body while connecting or disconnecting the Type N, RF connector.***

---

8. Now, disconnect the end of the power sensor that is connected to the **Power Ref.** connector, and connect it to the input signal as shown in *Figure 2-5*.
9. Observe that the HP 5347A/48A displays the power reading in dBm units. To display the power measurement in Watts, simply press the **Input dBm/Watt** key again (this key toggles between the dBm and Watt units).



**2-6.  
IN CASE OF  
TROUBLE  
(BEFORE CALLING  
FOR SERVICE)**

The following paragraphs will assist you in solving some operational problems that may occur with the HP 5347A/48A. Perform the appropriate procedure before calling an HP Office.

**DISPLAY IS BLANK  
DURING POWER-UP**

1. Turn off the instrument, and remove all signal and power cables.
2. Check the line voltage displayed in the Line Power Module on the rear panel of the HP 5347A/48A to ensure that it is set to the correct nominal line voltage in your area (that is, 110, 120, 220, or 240 Vac).
3. Check the line fuse.
4. Check the ac power cord and plug it into the ac receptacle on the HP 5347A/48A.
5. Power up the HP 5347A/48A. Watch the display. At turn-on the instrument should respond as shown in Section 2-3.
6. If the display is still blank, the HP 5347A/48A requires service. Call your local HP Sales and Support Office, or refer to Section 8 of the Service Manual.

**FAILS THE  
POWER-UP TEST**

1. Repeat the power-up test by cycling POWER off then on.
2. Watch the display. The HP 5347A/48A should respond as shown in Section 2-3. (Note that pressing the **Reset/Local** key will cause the instrument to ignore any failures and continue operation as best it can. However, the instrument might not meet specifications.)
3. If the power-up test fails again, the HP 5347A/48A requires service. Call your local HP Sales and Support Office, or refer to Section 8 of the Service Manual.

**DOES NOT OPERATE  
OFF BATTERY**

1. Check battery pack — It could be in backwards, weak, dead, or not making contact. Refer to the paragraph titled "BATTERY OPERATION (Option 002 Only)" in Section 2-2.

2. Make sure ac or dc sources are disconnected from the HP 5347A/48A when trying to operate instrument from the battery.
3. Check the instrument for ac power operation; the instrument could be bad. If this is the case, Call your local HP Sales and Support Office, or refer to Section 8 of the Service Manual.

**"DIAG 01" MESSAGE  
IS DISPLAYED**

If the DIAG 01 message is displayed, the HP 5347A/48A is set to the Diagnostics Mode. The HP 5347A/48A must be in the Measurement Mode to make measurements. To correct this problem perform the following:

1. Turn off the HP 5348A.
2. Set switch "1" of the 7-position DIP switch to the Measurement (Meas.) Mode ("down" position). See *Figure 2-2*.
3. Turn on the HP 5347A/48A. Watch the display. The instrument should respond as shown in Section 2-3.

**AN ERROR MESSAGE IS  
DISPLAYED**

Refer to *Table 3-2*, and perform the needed action to correct the problem.

**FREQUENCY COUNTER  
DISPLAY IS ERRATIC**

1. Check that input signal meets sensitivity specifications.
2. Check input signal for excessive noise; check that only one signal is present. If two or more are present, check that the Amplitude Discrimination specifications are met.
3. If measuring a signal connected to INPUT 1 of an HP 5347A, check that the input cable is firmly tightened to the N-type connector.

**A KNOWN FREQUENCY IS  
MEASURED  
INCORRECTLY**

1. Check the Timebase calibration interval — TCXO may need calibrating.
2. Substitute an external 10 MHz Timebase of known accuracy at the Front Panel **External Reference** input.

**POWER MEASUREMENTS  
ARE ERRATIC**

1. Check that all connections are secured.
2. Check that the RF source is operating properly; check for noisy or multiple signals.
3. Substitute known good cables and/or sensors.

**HP-IB (Opt 011)  
WORKS INCORRECTLY**

1. Check that connections are tight.
2. Substitute another HP-IB cable.
3. Substitute another controller.
4. Review HP-IB Program for timing and/or syntax problems.

**DOES NOT WORK WITH  
EXTERNAL REFERENCE**

1. Check that the external reference signal meets input specification of the HP 5347A/48A.
2. Substitute another input cable.

# OPERATOR'S REFERENCE

*Operating Functions and Features of the HP 5347A/48A*

- Operating Characteristics Overview, Section 3-1.
- Initial Power-Up Self Tests, Section 3-2.
- Front Panel Keys, Section 3-3.
- Front Panel Display/Connectors, Section 3-6.
- Rear Panel Features, Section 3-10.
- **Error Indications**, Section 3-11.
- Remote Programming Information for HP 5347A/48A with HP-IB Option 011, Section 3-12.
- Diagnostics Mode Keys, Section 3-13.

## 3-1. OPERATING CHARACTERISTICS OVERVIEW

The HP 5347A/48A is a portable CW microwave frequency counter and power meter that combines high performance measurements with simple, easy-to-use operating procedures. The HP 5347A is capable of measuring frequency from 10 Hz to 20 GHz and power from -70 to +20 dBm over a frequency range of 10 MHz to 18 GHz or 20 GHz\* (depending on sensor used). The HP 5348A instrument is similar to the HP 5347A, with the HP 5348A having an extended frequency measurement range of 10 Hz to 26.5 GHz and power from -70 to +20 dBm over a frequency range of 10 Hz to 18 GHz or 26.5 GHz (depending on sensor used).

The HP 5347A/48A has a 6-key membrane keyboard on its front panel, shown in *Figure 3-5*, that allows easy selection of the instrument's functions.

Frequency measurements are made through the INPUT 1 and INPUT 2 connectors. Power measurements are made through the power sensor module. Power Meter zeroing is automatic at the press of a button. Calibration of the sensor is easily performed by connection to the Power Ref 1.00 mW 50 MHz connector, or an external 1.00 mW 50 MHz source.

\* Power measurements can be made to frequencies up to 26.5 GHz with the HP 5347A if an HP 8485A sensor is used; however, power accuracy is not specified for frequencies beyond 20 GHz.

Additional capability and convenience are provided by user-callable test and diagnostic functions, described in Section 3-13, that can be used for troubleshooting. All display functions are performed by a Liquid Crystal Display (LCD) which contains 24 alphanumeric characters (including function annunciators) for displaying both messages and measurement data.

The rear panel, shown in *Figure 3-6*, contains a 7-position DIP switch, ac input socket, dc input connection, optional HP-IB connector, and battery housing (for the optional battery pack). The optional HP-IB interface provides remote control of measurement functions and data output. Refer to Appendix C, REMOTE PROGRAMMING VIA HP-IB, for details. The battery option provides for true portable operation and includes an internal charging circuit. Refer to the paragraph, under Section 3-10, titled "Battery Compartment and Option 002 Battery Pack" for details.

**FREQUENCY COUNTER MODE.** The HP 5347A/48A Frequency Counter is a CW microwave counter with an overall measurement range of 10 Hz to 20 GHz or 26.5 GHz (depending on instrument model); the two front panel inputs listed below permit this measurement range.

- INPUT 1 — 500 MHz to 20 GHz or 26.5 GHz (depending on instrument model), input impedance of  $50\Omega$
- INPUT 2 — 10 Hz to 80 MHz, input impedance at 1 M $\Omega$   
10 MHz to 525 MHz, input impedance at  $50\Omega$

Signals in the frequency range of 10 Hz to 80 MHz are measured by the direct count method. Signals in the range of 10 MHz to 525 MHz are measured by a prescaled count method. Signals in the frequency range of 500 MHz to 20 GHz or 26.5 GHz (depending on instrument model) are down-converted to an intermediate frequency (IF) by HP's harmonic heterodyne down-conversion technique. The counted IF is added to, or subtracted from, a multiple of the local oscillator (LO) frequency to determine the input frequency.

The HP 5347A/48A measures frequencies above 500 MHz with automatic amplitude discrimination and FM rate tolerance. Resolution of 1 Hz or 10 kHz is selected via the rear panel DIP switch. Measurements are displayed in a fixed point format on the front panel display, with segments to the right used to display additional, alphanumeric information.

To maximize accuracy and resolution, the instrument's counting circuitry uses a reciprocal counting technique and analog interpolation. In this process the Counter always makes a period measurement. It then computes the frequency using the reciprocal of the period measurement. Additional measurement accuracy is obtained through the use of analog interpolators to reduce the inherent one count uncertainty by compensating for time differences between the time base and input trigger events.

**POWER METER MODE.** The HP 5347A / 48A Power Meter is a single channel meter. The Power Meter measures power in the range of - 70 to +20 dBm or 100 picowatts to 100 milliwatts over a frequency range of 10 MHz to 20 GHz or 26.5 GHz using HP 848XA series power sensors (frequency range depends on sensor used). A 1.00 mW 50 MHz power reference is available on the front panel for calibrating the meter. The Power Meter displays power in dBm or Watts.

The Power Meter has automatic zero and calibration capabilities that can be selected via the front panel keyboard. (The zero and calibration routines are automatic, but some user interaction is required.)

Frequencies measured by the Counter are used by the Power Meter to enhance the accuracy of the Power Meter. Power measurements can also be made without measuring the frequency, but there is a loss of accuracy.

### **3-2. INITIAL POWER-UP SELF TEST**

#### **What happens during Power-Up?**

When power is applied to the HP 5347A / 48A (POWER key toggled ON) the instrument performs an internal self test and displays the status. The rear panel DIP switch positions are read, and if the diagnostics (Diag.) mode is selected, the instrument then goes to the diagnostic mode. If the measurement (Meas.) mode is selected, the instrument configuration is set as follows:

- Mode to Frequency Counter
- Input 1 enabled
- Input 2 to 50Ω
- Power units to dBm
- Power sensor type and frequency resolution set according to the rear panel DIP switch settings.

## **What is Self Tested?**

Several major components, including the microprocessor-related circuits for both the frequency counter and power meter are tested during the self test routine. The tests for each function (counter and power meter), are listed below. For details on each test, refer to Section 8 of the HP 5347A/48A Service Manual.

### **FREQUENCY COUNTER SELF TESTS**

- Power Supply Verification
- Timebase Verification
- MRC CHA Verification: 10 MHz Timebase
- LO Verification: 29.5 MHz, 35.0 MHz
- MRC CHB Verification: 35 MHz
- IF Verification: 35 MHz, Disable INPUT 1 and IF
- Interpolator Check
- Low Frequency 50 $\Omega$  Verification: 35 MHz
- Low Frequency 1 M $\Omega$  Verification: 35 MHz
- Microprocessor ROM
- Interface RAM

### **POWER METER SELF TESTS**

- Interface RAM
- Microprocessor RAM
- Microprocessor ROM
- Interrupt Timer
- Peripheral Interface Adapter
- Analog-to-Digital Converter

### 3-3. FRONT PANEL KEYS

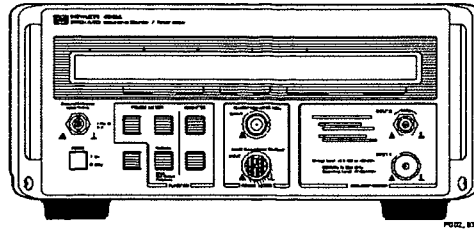

Pressing any of the front panel COUNTER function keys (**Input 1** and **Input 2**) selects the Frequency Counter mode. Pressing the **Input dBm/Watt** key selects the Power Meter mode. When you press a key, you will hear a beep; this beep indicates that the HP 5347A/48A acknowledged the keypress. The HP 5347A/48A operates in only one mode at a time: frequency counter or power meter. For example, when the Power Meter is selected, the instrument will only measure power.

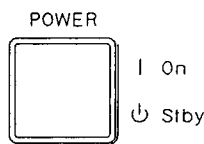

#### POWER Key

When the **POWER** key is toggled ON, power is supplied to the entire instrument. When the **POWER** key is in the OFF (standby mode) position, the instrument will charge the battery (if present) from the ac line.

#### WARNING

**BEFORE APPLYING AC POWER, THE INSTRUMENT AND ALL PROTECTIVE EARTH TERMINALS, EXTENSION CORDS, AUTOTRANSFORMER, AND DEVICES CONNECTED TO THE INSTRUMENT SHOULD BE CONNECTED TO A PROTECTIVE EARTH GROUND SOCKET. ANY INTERRUPTION OF THE PROTECTIVE EARTH GROUNDING WILL CAUSE A POTENTIAL SHOCK HAZARD THAT COULD RESULT IN PERSONAL INJURY.**



#### Reset/Local Key

**RESET.** Whether the HP 5347A/48A is in its Counter or Power Meter mode pressing of the **Reset/Local** key returns the instrument to the Frequency Counter Mode measuring from INPUT 1. Toggled key operations are set to their default conditions. However, stored frequency, zero, and calibrate



values are not lost. For example, you do not have to store a new frequency if it has not changed since **Reset** was pressed. (If measuring on INPUT 2, pressing **Reset** will default the stored calibration value back to the average calibration factor.)

**LOCAL.** If the HP 5347A/48A is in the remote operating mode (for HP-IB Option 011 only), then pressing the **Reset/Local** key returns the instrument to Local operation and resets the instrument. The **Local** and **POWER** keys are the only active keys when the instrument is in the remote mode. The **Local** key may be disabled using the "Local Lockout" HP-IB function.

### 3-4. Frequency Counter Function Keys

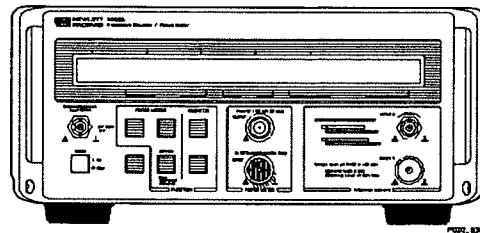

#### Input 2 50Ω/1MΩ Key

Selects INPUT 2 for measuring signals in the 10 Hz to 525 MHz range.

The **Input 2** key selects between two functions: 1 MΩ input for signals with frequencies of 10 Hz to 80 MHz, and 50Ω input for signals with frequencies of 10 MHz to 525 MHz. Pressing the **Input 2** key will toggle between these two functions. The last setting is stored; therefore, when the Input 2 mode is entered again, the instrument returns to the setting last used.

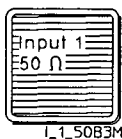

#### Input 1 50Ω Key

Selects INPUT 1 for measuring signals in the 500 MHz to 20 GHz or 26.5 GHz range (depending on instrument model).

### 3-5. Power Meter Function Keys

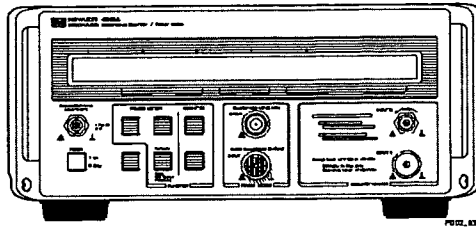

#### Zero Key

Zeroes the power meter circuitry when the instrument is in the power meter mode. A sensor must be connected to the HP 5347A/48A, but the sensor may be zeroed with or without an impedance connected. No power can be connected to the sensor during the zeroing operation. The Power Meter should be zeroed several times per hour, after the "INIT" HP-IB command, and before each use on the lower power ranges. This function corrects for dc drift in the Power Meter gain chain. This key is only valid in Power Meter mode; therefore, pushing the Zero key while the instrument is in the Counter mode, will cause a "NOT IN POWER METER MODE" message to be displayed. Otherwise, "ZEROING" will be displayed. Zeroing will typically take 10 to 20 seconds.

#### NOTE

*If the 10 MHz External Reference input is connected or disconnected after zeroing has been performed, the power meter must be re-zeroed.*

#### NOTE

*If the HP 5347A/48A experiences an environmental temperature change greater than 5°C (9°F), power meter accuracy may be affected. To assure power meter accuracy at the new temperature, do the following:*

1. *With power off, allow the HP 5347A/48A to stabilize at the new temperature for 15 minutes (30 minutes if the power sensor is an HP 8484A or 8484D).*
2. *Power up the HP 5347A/48A and allow it to stabilize for an additional 5 minutes.*
3. *Perform power meter zero and calibration procedures.*

3-5.  
Power Meter  
Function Keys  
(continued)

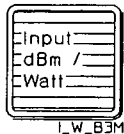
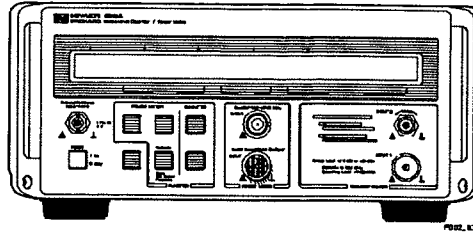

I\_W\_B3M

**Input dBm/Watt Key**

The Power Meter **Input dBm/Watt** key has two functions. The first press of this key (after power-up or Reset) enables power meter measurements in the dBm mode (disabling the frequency counter). Subsequent keypresses toggle between the dBm and Watt units. The last setting is stored. When the Power Meter mode is entered again, the unit returns to the setting last used. If the **Reset** key has been pressed, the instrument always resets to the dBm mode.

Three sensors, the HP 8481A, HP 8484A, and HP 8485A, can be used with the HP 5347A/48A. The selected sensor type must be entered into the instrument via the rear panel DIP switch. Refer to Section 3-10, Rear Panel Features, for switch settings. Also, refer to the paragraph in Section 2-5, Making A Power Measurement, for information on when to use a particular power sensor.

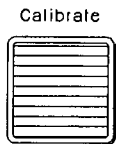

Store  
(Cal Factor)  
Frequency  
C\_S\_B3M

**Calibrate/Store Frequency Key**

This key is used in both the Frequency Counter and Power Meter mode. Both of the uses are related to a Power Meter measurement.

In the Frequency Counter mode, the **Calibrate/Store** key stores the currently displayed frequency. The power-up condition stores 0 Hz. When the **Calibrate/Store** key is pressed and there is no input, 0 Hz is also stored. If 0 Hz is stored, then the average calibration factor is chosen to calibrate the power measurement.

Calibration factors versus frequency values are stored in tables internal to the instrument for the HP 8481A and HP 8485A Power Sensors. The HP 8484A Power Sensor will always use a fixed value of 100%. Therefore, a frequency measurement need not be made to increase the accuracy of the HP 8484A Power Sensor.

Calibration factors are stored in the firmware for every 0.5 GHz increment in frequency. If a frequency is stored, then rounding to the nearest 0.5 GHz is performed to pick the correct value. This value is always used unless a new frequency or 0 Hz is stored. The frequency for the calibration factor storage can be collected from either INPUT 1 or INPUT 2. In INPUT 2, the calibration factor is automatically set to 100% because the frequency always rounds to the nearest 0.5 GHz.

---

**NOTE**

*Measuring power at a frequency other than the one stored reduces measurement accuracy.*

---

In the Power Meter mode, you must connect the power sensor to the **Power Ref** connector (or external precision external 1mW, 50 MHz Source) before using the **Calibrate/Store** key (refer to *Figure 2-3* for calibration setup).

---

**NOTE**

*If the HP 8484A Power Sensor is used to measure power, you need to connect an HP 11708A 30 dB Attenuator to the power sensor during calibration. The 30 dB attenuator is furnished with HP 8484A.*

---

During calibration, the instrument will determine a calibration constant which will be combined with the frequency dependent calibration factor to scale subsequent power measurements. "CALIBRATING" will be displayed while this occurs.

Calibration takes less than 5 seconds. Perform calibration:

- When the sensor is changed.
- After power-up.
- When the ambient temperature changes by more than 5° C.
- At least once per day.
- After "INIT" (Initialization) HP-IB command.
- If the 10 MHz External Reference input is connected or disconnected after the instrument has already been zeroed and calibrated.

---

**NOTE**

*The 50-mHz, 1-mw power reference oscillator output is present ONLY during the actual calibration routine. It is off at all other times. It can be turned on manually via HP-IB, or via a diagnostic (see pages 4-29 and 4-30 of this manual).*

---

3-6.  
FRONT PANEL  
DISPLAY/  
CONNECTORS

3-7.  
Front Panel Display

All the HP 5347A /48A display functions are performed by a Liquid Crystal Display (LCD) Assembly. Annunciation for all operating modes is indicated by arrows (∇) at the bottom of the display. These arrows point to the function names marked on the front panel just beneath the LCD panel as shown in Figure 3-1(a).

The front panel Display consists of 24 LCD characters (including function annunciators) as shown in Figure 3-1(a). The LCD displays digits or word messages. Figure 3-1(b) shows the display format for the Counter mode, and Figure 3-2 shows the display format for the Power Meter mode. The LCD format for the Counter mode has room for 12 digits in its parameter display section, grouped in sets of 3s, with a blank character between each group. The message section has 8 characters available, the first usually being blank to serve as a separator between the message section and the parameter section. The content of the display will be different for each operating mode. The LCD format for the Power Meter mode has room for 9 digits for actual power reading and 3 digits for the power unit (dBm,  $\mu$ Watt, etc.). 10 digits are set aside for displaying the stored frequency. Note that while in the Power Meter mode, the frequency displayed is the "stored" value and is not a live measurement.

Figure 3-1.  
The LCD and  
Display Format  
for Counter

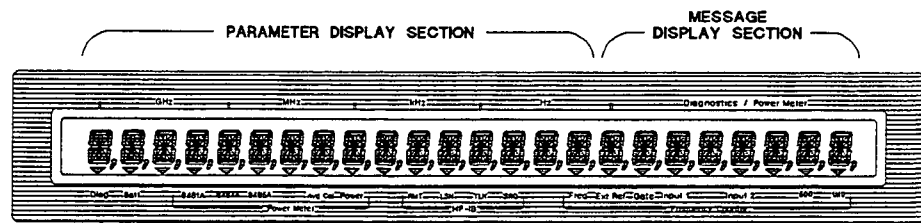

(a)

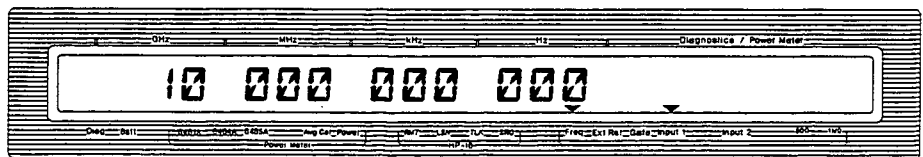

(b)

Figure 3-2.  
Display Format  
for Power Meter

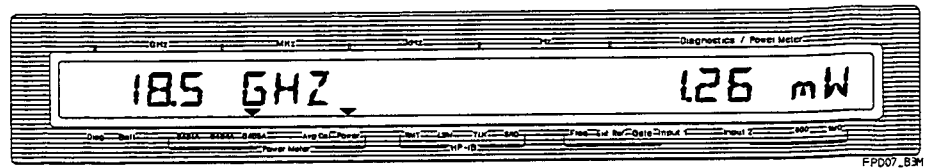

### 3-8. Front Panel Annunciators

The various modes and functions of the HP 5347A /48A are labeled on the front panel just beneath the LCD as shown in *Figure 3-2*. When an operating mode or function is selected, an arrow-shaped annunciator (∇) appears at the lower edge of the display, pointing to the name of the selected mode or function. *Table 3-1* contains a brief description of each of the front panel annunciators.

*Table 3-1. Front Panel Annunciator Descriptions*

**Diag.** The Diag annunciator indicates when the HP 5347A /48A is set to the Diagnostics mode via the rear panel DIP switch. The annunciator goes out when the DIP switch is set to the Measurement mode and the power is cycled OFF then ON.

**Batt.** The Batt annunciator indicates when the HP 5347A /48A is using the Option 002 Battery for its power source. The annunciator goes out when ac power is restored, and flashes when the battery is low. Refer to subsection titled "Battery Compartment and Option 002 Battery Pack" for more information.

**8481A.** The 8481A annunciator indicates when the HP 8481A Power Sensor is selected via the rear panel DIP switch. The annunciator goes out when Counter or Diagnostics mode is selected.

**8484A.** The 8484A annunciator indicates when the HP 8484A Power Sensor is selected via the rear panel DIP switch. The annunciator goes out when Counter or Diagnostics mode is selected.

**8485A.** The 8485A annunciator indicates when the HP 8485A Power Sensor is selected via the rear panel DIP switch. The annunciator goes out when Counter or Diagnostics mode is selected.

**Avg. Cal.** The Avg Cal annunciator indicates when the HP 5347A /48A Power Meter uses the Average Calibration Factor to compute the power measurement (when the stored frequency is zero or no frequency was stored). The annunciator goes out when Counter or Diagnostics mode is selected, or when a frequency is stored.

*Continued...*

Table 3-1. Front Panel Annunciator Descriptions (Continued)

**Power.** The Power annunciator indicates when the HP 5347A/48A is set to the Power Meter measurement mode. The annunciator goes out when the Frequency Counter measurement mode or Diagnostic test mode is selected.

**RMT.** The RMT annunciator indicates when the HP 5347A/48A is under remote control. Refer to Appendix C, Remote Programming via HP-IB (Option 11), at the back of this manual for further information.

**LSN.** The LSN annunciator indicates when the HP 5347A/48A is addressed to listen. Refer to Appendix C, Remote Programming via HP-IB (Option 011), at the back of this manual for further information.

**TLK.** The TLK annunciator indicates when the HP 5347A/48A is addressed to talk, or when it is being used in the TALK ONLY mode. Refer to Appendix C, REMOTE PROGRAMMING VIA HP-IB (OPTION 011), at the back of this manual for further information.

**SRQ.** The SRQ annunciator indicates when a Service Request condition exists in the HP 5347A/48A, requiring attention from the HP-IB controller. Refer to Appendix C, Remote Programming via HP-IB (Option 011), at the back of this manual for further information.

**Freq.** The Freq annunciator indicates when the HP 5347A/48A is set to the Frequency Counter mode. The annunciator goes out when the Power Meter or Diagnostics mode is selected.

**Ext Ref.** The Ext Ref annunciator indicates when a 10 MHz external timebase reference signal is connected to the HP 5347A/48A front panel External Reference input. The annunciator goes out when the external reference is disconnected, and when the Counter is gated. The Ext Ref annunciator operates in the Frequency Counter mode only.

**Gate.** The Gate annunciator shows the status of the HP 5347A/48A gate. The GATE annunciator flashes during Frequency Counter measurements to indicate the closing of the gate. The Gate annunciator operates in the Frequency Counter mode only.

**Input 1.** The Input 1 annunciator indicates when the HP 5347A/48A INPUT 1 is selected to measure the frequency of an input signal. The annunciator goes out when the Input 2, or the Power Meter measurement mode, or the Diagnostic test mode is selected.

**Input 2.** The Input 2 annunciator indicates when the HP 5347A/48A INPUT 2 is selected to measure the frequency of an input signal. The annunciator goes out when the Input 1, or the Power Meter measurement mode, or the Diagnostic test mode is selected.

**50Ω.** The 50Ω annunciator indicates when INPUT 2 is set for 50Ω input impedance. The annunciator goes out when another measurement mode is selected.

**1MΩ.** The 1MΩ annunciator indicates when the INPUT 2 is set for 1MΩ input impedance. The annunciator goes out when another measurement mode is selected.

### 3-9. Front Panel Connectors

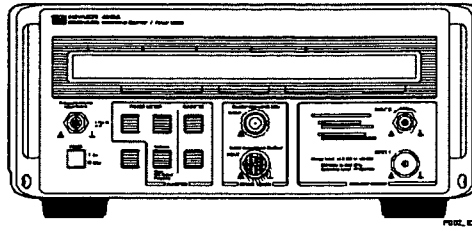

External Reference  
Input 10 MHz

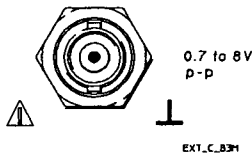

#### External Reference Input 10 MHz

An external reference input connector is provided for a 0.7 to 8V peak-to-peak, 10 MHz source. If an external reference source is applied to this input, the HP 5347A/48A automatically uses the external reference as its timebase, and ignores the internal TCXO timebase.

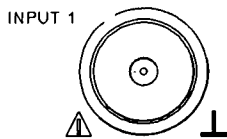

(APC 3.5 FOR HP 5348A)

#### High Frequency Input (INPUT 1) Connector

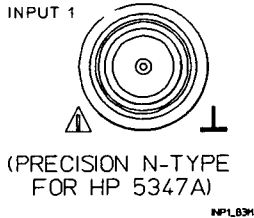

(PRECISION N-TYPE  
FOR HP 5347A)

#### CAUTION

**Do not exceed +25 dBm (peak) input power (or  $\pm 4V$  dc) at the INPUT 1 connector. Damage to the internal sampler may occur.**

**Refer to the Damage Level Specifications for INPUT 1 in Appendix B if Option 006 Option Increased Damage Level is installed.**

At the High Frequency Input, the HP 5347A/48A measures frequencies for signal inputs up to +7 dBm in the 500 MHz to 20 GHz or 26.5 GHz range (depending on instrument model). Under no circumstances should the input level to the HP 5347A/48A exceed +25 dBm, peak. If the input power exceeds +25 dBm, damage to the internal sampler may occur. Do not measure signals between +7 and +25 dBm as false readings may occur. When signal levels exceed +7 dBm, attenuate the signal with an external attenuator.



3-9.  
Front Panel  
Connectors  
(continued)

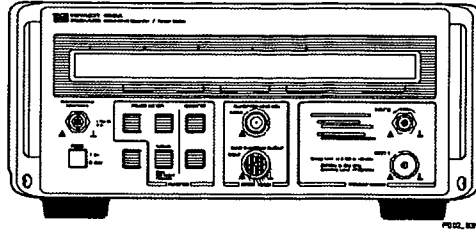

**CAUTION**

*An overload indication may appear on the front panel display under high input signal conditions. A power meter capable of measuring power greater than +25 dBm must be used to ensure that the input signal level does not exceed INPUT 1 specifications.*

*Refer to the Damage Level Specifications for INPUT 1 in Appendix B if Option 006 Option Increased Damage Level is installed.*

**DO NOT DEPEND ON THE OVERLOAD INDICATION FOR THIS PURPOSE.**

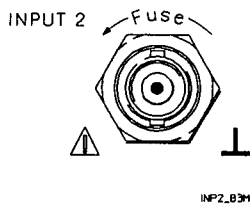

**Low Frequency Input (INPUT 2) Connector**

**CAUTION**

*The INPUT 2 damage level described below is only a simplified form of the complete specification. Refer to Appendix B for the complete Damage Level specification for INPUT 2.*

The 10 Hz – 525 MHz Low Frequency input BNC female connector contains a fuse to provide protection from input levels that exceed the specified damage level for INPUT 2: 5.5V rms (+28 dBm). Refer to Appendix A, INSTALLATION, for instructions on how to change the front panel fuse.

### 3-9. Front Panel Connectors (continued)

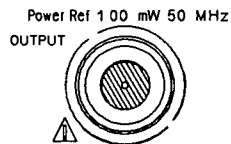
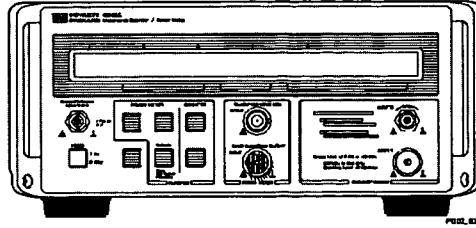

P\_REF\_B3M

#### Power Ref Connector

The power reference output is a 50 ohm, N-type male connector that outputs a 1 mW, 50 MHz signal used to calibrate the power meter.

#### NOTE

*The 50-MHz, 1-mw power reference oscillator output is present ONLY during the actual calibration routine. It is off at their times. It can be turned on manually via HP-IB, or via a diagnostic (see Section 4 of this manual).*

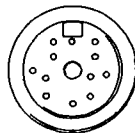

P\_SENSB3M

#### Power Sensor Connector

The sensor input is a female 12-contact audio connector. Connect only the HP Model 8481 A, HP 8484A, or HP 8485A Power Sensors to this input.

#### CAUTIONS

**BEFORE CONNECTING THE POWER SENSOR TO ANOTHER INSTRUMENT OR RF GENERATOR, ensure that the instrument or RF generator and the Power Meter are properly connected to a protective (earth) ground**

*To prevent damage to the Power Sensor, no more than 20 Vdc may be applied between the center conductor of the RF connector and ground. (A blocking capacitor in the Power Sensor prevents the flow of dc current.)*

*Do not apply torque to the Power Sensor's body while connecting or disconnecting the Type N, RF connector.*

3-10.  
REAR PANEL  
FEATURES

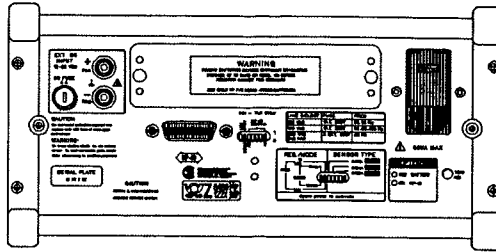
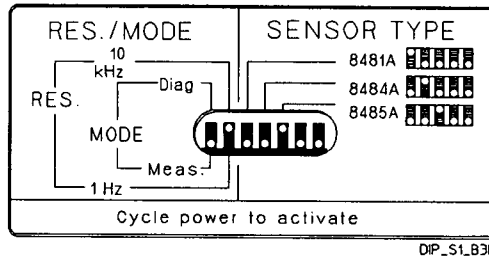

Figure 3-3 shows the 7-position DIP switch configuration.

**DIP Switch.** The DIP switch positions must be set to the desired position before powering on the instrument. If a switch is changed while the instrument is ON, then the power to the instrument must be cycled OFF then ON again in order to activate the function of a new switch setting.

Figure 3-3.  
Rear Panel DIP Switch  
Configuration



**MODE (DIAGNOSTICS/MEASUREMENT).** The up position sets the HP 5347A/48A in Diagnostics mode and the down position sets the HP 5347A/48A in Measurement mode (Frequency Counter and Power Meter).

**RESolution 10 kHz/1 Hz.** (This feature is for the Frequency Counter only.) Best case resolution is the value represented by the least significant digit (LSD) in the display. In the HP 5347A/48A, a maximum resolution of 1 Hz can be selected by setting the resolution switch to its down position as shown in Figure 3-3. The displayed numerals of a measurement are grouped in four sections of three digits each for ease in determining GHz, MHz, KHz, and Hz placement. Asterisks or blanks are used as place holders to improve interpretation of the display, depending on the resolution. For example, a signal measured to 10 kHz resolution is displayed using an asterisk as shown below:

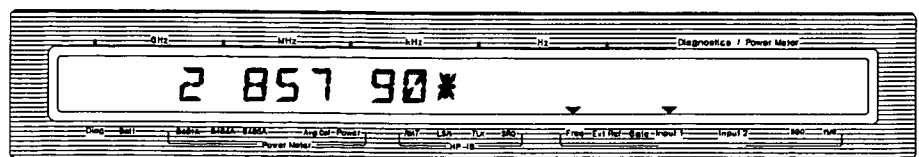

### 3-10. REAR PANEL FEATURES (continued)

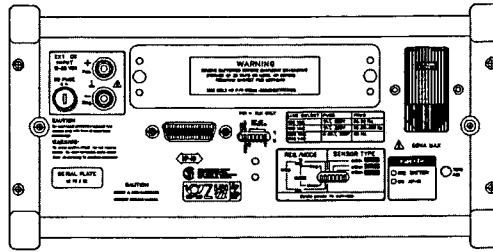

while the same signal measured to 1 Hz resolution will be displayed using blanks as shown below:

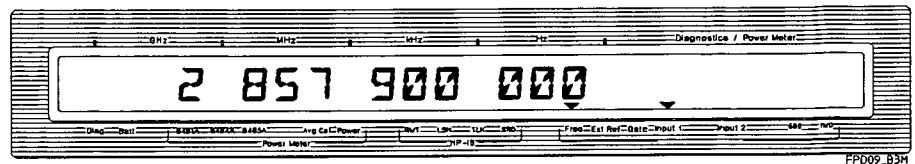

**SENSOR TYPE.** The first three switches adjacent to the **RES.** switch are the Power Meter **SENSOR TYPE** selection switches as shown in *Figure 3-3*. The settings of these switches determine which calibration factors will be used for the particular power sensors.

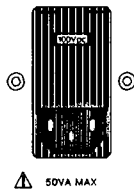

### AC Line Power Module

The Line Power Module accepts the three-wire ac power cable, permitting operation for the following inputs:

- 100 Vac  $\pm$  10% at 45-66 Hz, 360-440 Hz
- 120 Vac +10% - 14% at 45-66 Hz, 360-440 Hz
- 220 Vac  $\pm$  10% at 45-66 Hz
- 240 Vac  $\pm$  10% at 45-66 Hz

These input voltages can be selected by using the 4-position turret wheel in the Line Power Module, refer to Appendix A, **INSTALLATION**, for information on selecting ac input voltages.

### 3-10. REAR PANEL FEATURES (continued)

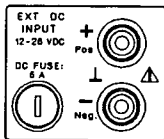
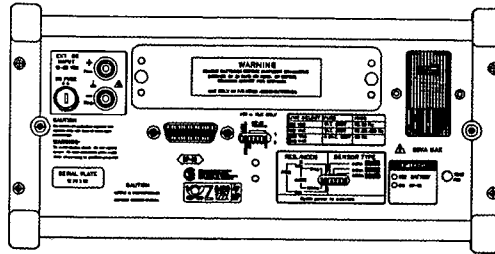

**CAUTION:**  
For continued protection against fire, replace only with fuses of same type and ratings.

**WARNING:**  
To avoid electric shock, do not remove covers. No user-serviceable parts inside. Refer all servicing to qualified personnel.

#### EXT. DC Input

The pair of binding posts provides an alternative method of powering the HP 5347A/48A. A dc voltage between +14V and +26V can be connected to the binding posts to operate the instrument. **Reverse Polarity Protection is provided.**

**CAUTION:** For continued protection against fire, replace only with fuse of same type and ratings.

**WARNING:** To avoid electric shock, do not remove covers. No user-serviceable parts inside. Refer all servicing to qualified personnel.

#### CAUTION

**When using the EXT. DC INPUT, always use a fused power supply and 18 AWG (minimum) connecting wires. Be sure that the binding post thumb nuts are tight over the wire connections. Do not use the standard exposed banana plugs. Some dc supplies, such as automotive batteries, are capable of high current, and can be a fire hazard if the terminal wires or the exposed plugs become loose and short to each other or to a conductive surface.**

**The maximum wire size that can fit through the hole in the binding posts is 12 AWG.**

Refer to Appendix A, INSTALLATION, for important detailed information about the EXT. DC Input.

### 3-10. REAR PANEL FEATURES (continued)

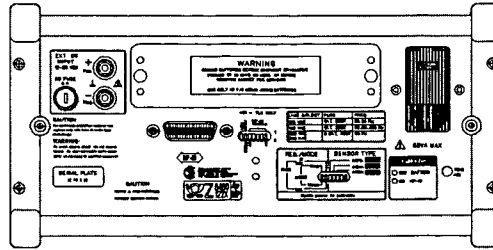

TCXO  
ADJ.

#### TCXO Adjustment

This opening in the rear panel allows adjustment of the Temperature Compensated Crystal Oscillator internal timebase. Refer to Section 5 (Adjustments) in the Service Manual for timebase calibration instructions.

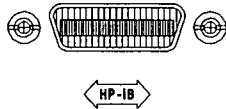

#### HP-IB Connector (Option 011 Only)

This input/output interface connector provides remote control capabilities with the Hewlett-Packard Interface Bus (HP-IB). For a complete description of the HP-IB capabilities, refer to Appendix C, REMOTE PROGRAMMING VIA HP-IB.

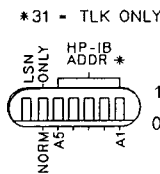

\*31 - TLK ONLY

#### HP-IB Address Switch (Option 011 Only)

The HP-IB Interface Address Switch (ADDR) is a bank of seven switches; six are used to manually set the remote control address of the HP 5347A/48A. The five rightmost switch positions are for setting the address. The leftmost switch is not used, and the switch adjacent to it is for selecting NORMAL (listen and talk) operation. LSN (listen) ONLY operation is not used. For a complete description of address selection, refer to Table C-1, Allowable HP-IB Address Selections, in Appendix C.

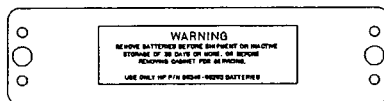

#### Battery Compartment and Option 002 Battery Pack

**COMPARTMENT AND BATTERY.** The battery compartment, which is located between the EXT DC INPUT connectors and the AC Line Power Module, houses the Option 002 Battery Pack. The battery is made of 12 NiCad D cells in series (nominally 14.4V).

3-10.  
**REAR PANEL  
 FEATURES**  
 (continued)

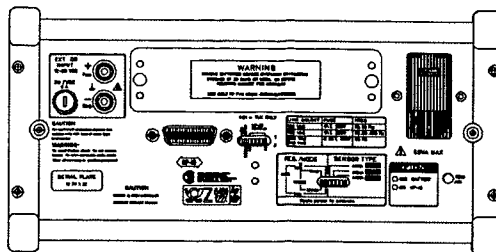

**OPERATING FEATURES.** In typical operation the Option 002 Battery Pack can provide enough power for 1 to 2 hours, typical, of continuous operation. A charging circuit charges the battery when the instrument is plugged into the ac line and the **POWER** key is in Standby (OFF) mode.

HP 5347A/48A will operate off the battery pack only if the instrument is disconnected from both ac and dc sources. When these sources are disconnected from the HP 5347A/48A, the instrument will automatically switch to battery operation. The HP 5347A/48A is NOT designed for uninterrupted operation. If the ac line or external dc source is disconnected while the HP 5347A/48A is operating, the instrument will switch to battery operation, but may reset to its power-up state. There is an annunciator (**Batt**) on the front panel which indicates that the instrument is operating off the battery. When this annunciator begins to flash, the battery voltage level is getting low, and there are approximately 10 to 15 minutes of operation time left. At this time the battery reaches a low voltage cutoff point, and the instrument will automatically switch to its Standby state (OFF) to protect the battery from damage. To return the instrument to operation, the battery pack must be replaced with a charged battery pack, or an external ac or dc source must be applied, and then the **POWER** key must be pressed to turn the instrument back ON. Because of this shut-down feature, the instrument is guaranteed to meet all specifications while operating off the battery — **the instrument will shut down before the specifications degrade.**

Refer to Appendix A, **INSTALLATION**, for details on field installation of the battery pack and battery care, useage, and disposal.

### 3-11. ERROR INDICATIONS

The HP 5347A/48A generates error messages to indicate internal operating problems. All of the Error Messages are listed and described in *Table 3-2*, which describes the action required to correct the problem.

*Table 3-2. HP 5347A/48A Error Messages*

ERROR CODE	ERROR MESSAGE DISPLAYED	MEANING	ACTION REQUIRED
01	HP-IB NOT IN 1 ERROR	Unit does not have optional HP-IB Interface installed.	Press Reset/Local Key.
02	I/O 2 ERROR	Internal HP-IB Interface error.	HP 5347A/48A needs service.
03	OUT OF RANGE 3 ERROR	Input number or value entered by user is out of range. <i>(Note: this error message only occurs in instruments that contain the Option 011 HP-IB Interface.)</i>	Re-enter a value within limits of the HP-IB command.
04	SYNTAX 4 ERROR	HP-IB command syntax error. <i>(Note: this error message only occurs in instruments that contain the Option 011 HP-IB Interface.)</i>	Check program command.
05	CAL ERROR 5 ERROR	Power Meter cannot calibrate sensor.	Make sure power sensor is connected to a 1 mW 50 MHz source, or if HP 8484A sensor needs 30 dB Attenuator.
06	CANNOT ZERO 6 ERROR	Power Meter cannot zero the sensor.	Ensure that no RF power is being applied to the sensor during zeroing.
07	INPUT OVL 7 ERROR	Input overload on sensor.	Reduce input power to sensor.
08	PLEASE ZERO 8 ERROR	Sensor zero reference has drifted.	Zero sensor; If error persists, check input power.
09	UP RANGE 9 ERROR	Input power to sensor is too high for current range. <i>(Note: this error message only occurs in instruments that contain the Option 011 HP-IB Interface.)</i>	Select a higher range, reduce input power to sensor, or use autorange.
10	NO SENSOR 10 ERROR	No sensor connected to the input.	Connect sensor.



### Error Display Examples

ERROR 1: HP-IB NOT IN 1 ERROR

ERROR 2: I/O 2 ERROR

ERROR 4: SYNTAX 4 ERROR

ERROR 5: CAL ERROR 5 ERROR

Numbered errors may be cleared by pressing the front panel **Reset/Local** key, switching the HP 5347A/48A to OFF then back to ON, or over the HP-IB (Option 011) using the device dependent commands "RESET", "CLR", or "INIT", or the device independent commands "DCL" or "SDC".

Errors that occur during power meter operation can be cleared by correcting for the error condition, if necessary (for example, installing a sensor for "NO SENSOR"), and pressing the **Input dBm/Watt** key, which will put the instrument back into the power meter mode. (Pressing the **Reset/Local** key will put the instrument in the frequency counter mode.)

### Overflow Warning

If an input frequency causes an overflow in the microprocessor' calculated results, the HP 5347A/48A will display:

MATH OVERFLOW

An "OVERFLOW" warning is cleared by removing the cause: connecting the input signal to the correct connector, or lowering the input frequency.

### 3-12. REMOTE PROGRAMMING INFORMATION FOR HP 5347A/48A WITH OPTION 011

HP 5347A/48A's that include the Option 011 HP-IB Interface Assembly allow the instrument to respond to remote control instructions and output measurement data via the HP-IB. At the simplest level, the HP 5347A/48A can transmit data in the "talk only" mode to another device, such as a printer. In more sophisticated systems, a computing controller can remotely program the Counter/Power Meter to perform a specific type of measurement, trigger the measurement, and collect the results.

Refer to Appendix C of this manual for details on remote programming.

### 3-13. DIAGNOSTICS MODE KEYS

The Diagnostics mode allows you to verify operation of specific sections of the Counter and Power Meter. The Diagnostic Tests are a special series of programs used to diagnose difficulties with different assemblies in the HP 5347A/48A. The tests aid in service and troubleshooting. Refer to Section 8 of the Service Manual for detailed information on the Diagnostic Tests.

The Diagnostics mode is entered by setting the mode selection switch of the rear panel DIP switch, shown in *Figure 3-3*, to "Diag." before turning on the instrument or by sending the HP-IB command "DIAGENT". After power-up the front panel's Diag annunciator will light, and the display will indicate DIAG 01 to indicate the HP 5347A/48A is operating in Diagnostics mode.

#### How are the Diagnostic Functions Called?

*Figure 3-4* shows the transformation of the power meter and counter front panel keys when the Diagnostics mode is selected. To call a diagnostic, press the COUNTER Input 2 50 $\Omega$ /1M  $\Omega$  key to increment to the desired diagnostic test number, and press the Input 1 50 $\Omega$  key to decrement the desired diagnostic test number. Numbers that contain no diagnostics are skipped, and the next valid diagnostic number is displayed.

Pressing the DECREMENT key while the instrument is in the Diagnostic 1 test mode ("DIAG 01" is displayed) will cause the instrument to automatically decrement to Diagnostic 97 test mode ("DIAG 97" is displayed). Similarly, pressing the INCREMENT key while the instrument is in the Diagnostic 97 test mode will cause the instrument to automatically increase to Diagnostic 1 test mode.

Figure 3-4.  
Keys for Operating  
the Diagnostics  
Mode

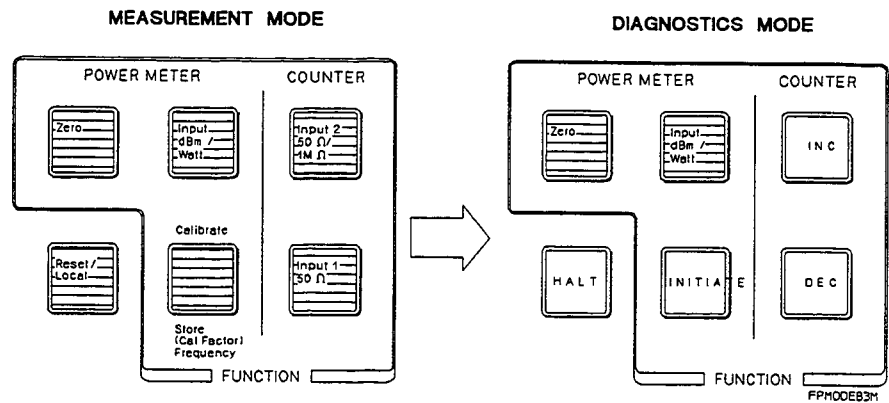

Once you have the desired diagnostic number displayed, press the **Calibrate/Store** (INITIATE) key to initiate the diagnostic execution. The results of the diagnostic are displayed. Pressing the INITIATE key again will re-execute the same diagnostic. Some diagnostics will continually run; press **Reset/Local** (HALT) to stop a test.

Once you have completed the desired testing, the power to the instrument must be turned off, and the selection switch on the rear panel must be returned to the "Meas." (Measurement mode) position.

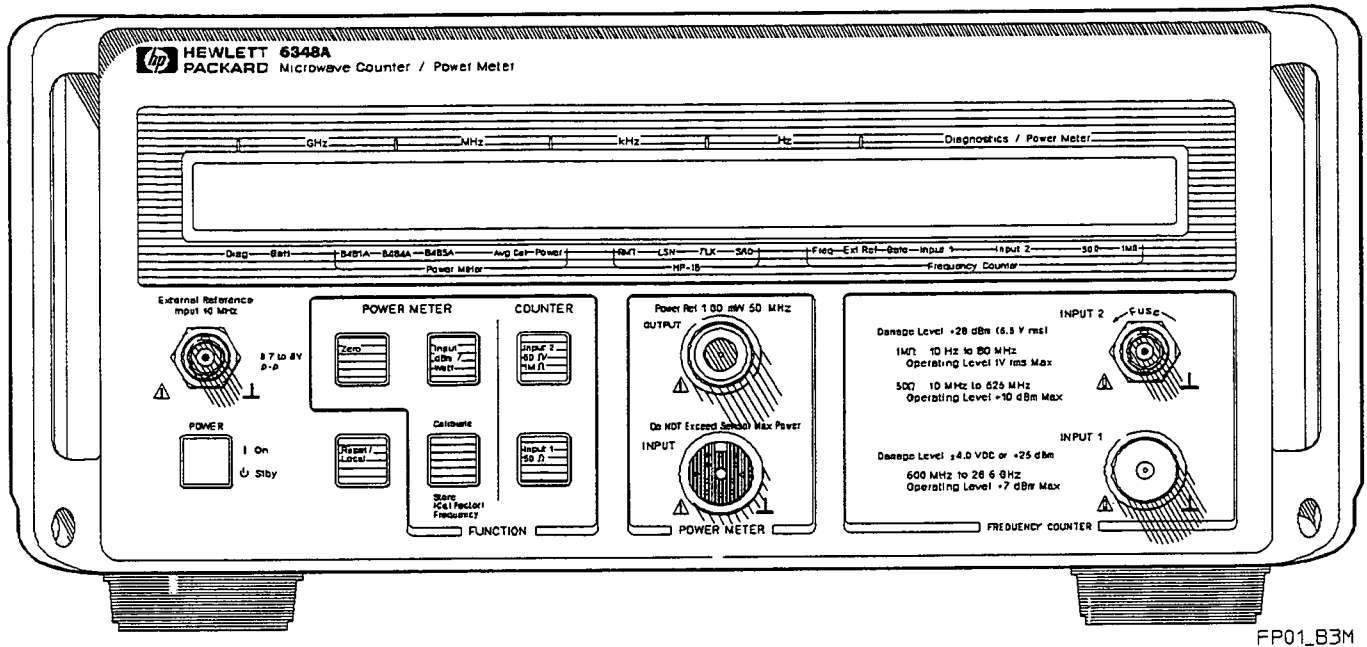

FP01\_B3M

Figure 3-5. Front Panel Connectors and Annunciators (HP 5348A shown)

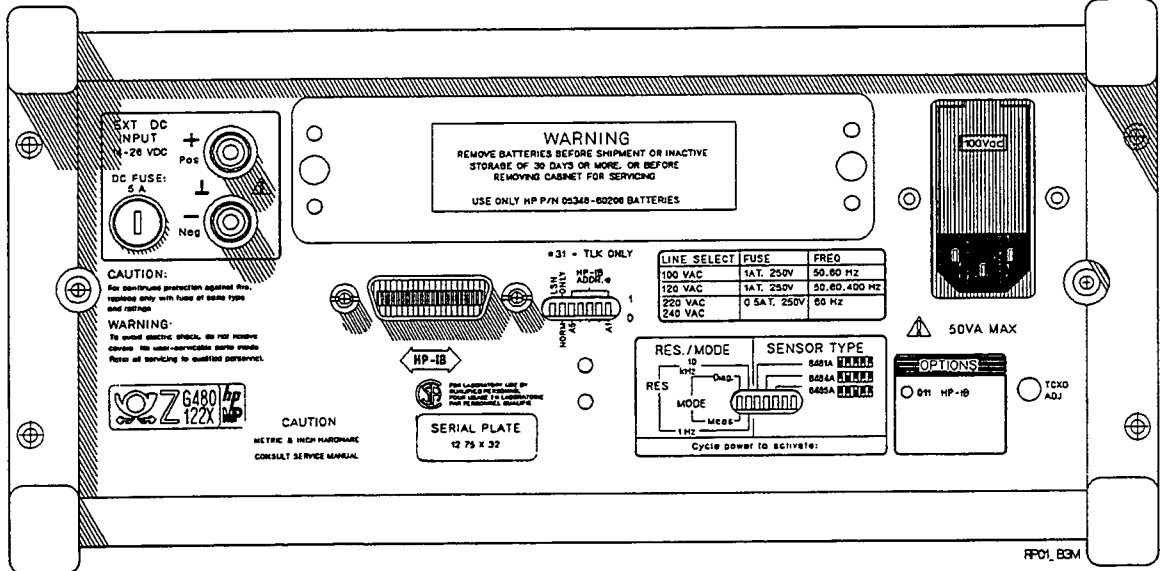

FP01\_B3M

Figure 3-6. Rear Panel Connectors and Switches

Figure 3-5. Front Panel Connectors and Annunciators (HP 5348A shown)  
 Figure 3-6. Rear Panel Connectors and Switches

## PERFORMANCE TESTS

---

- 4-1. INTRODUCTION** This section contains procedures for testing the electrical performance of the HP 5347A/48A Microwave Counter/Power Meter, using the specifications listed in Appendix B, as performance standards.
- 4-2. OPERATIONAL VERIFICATION** The Operational Verification, beginning at Section 4-8, is an abbreviated series of checks that may be performed to give a high degree of confidence that the instrument is operating properly without performing the complete Performance Test. An operational verification should be useful for incoming inspection, routine maintenance, and after instrument repair.
- 4-3. PERFORMANCE TEST** The complete Performance Test procedures begin at Section 4-16. All tests can be performed without access to the inside of the instrument.
- 4-4. HP-IB VERIFICATION (FOR OPTION 011)** An HP-IB Verification program, described in Section 4-25, exercises the instrument through the majority of its command set via the HP-IB Interface. The program is written for an HP 9000 all phases of the verification program, there is a very high probability that the HP-IB Interface is working properly. The HP-IB program is available on floppy discs, HP Part Number 05348-13502 (5-¼ inch LIF disc and HP Part Number 05348-13501 (3-½ inch LIF disc. These discs are included in the HP 5347A/48A Service Accessories Kit (see *Table 1-2*).
- 4-5. EQUIPMENT REQUIRED** The equipment required for all test procedures in this section is listed in *Table 4-1*. Any equipment that satisfies the required characteristics given in the table maybe substituted for the recommended models. (The Appendix, RECOMMENDED TEST EQUIPMENT, in the Service Manual is a complete list of the recommended test equipment for the performance tests, adjustments, and troubleshooting procedures.)

**4-6.**  
**CALIBRATION**  
**CYCLE**

The HP 5347A/48A requires periodic verification of operation. Depending on the use and environmental conditions, the HP 5347A/48A should be checked using the operational verification procedure at least once every year. A full calibration procedure, including adjustments and a full Performance Test, should be performed at least once every 6 months.

**4-7.**  
**TEST RECORD**

Results of the operational verification should be recorded on a copy of the Operational Verification Record, *Table 4-2*, located at the end of the operational verification procedures. Results of the Performance Tests should be recorded on a copy of the Performance Test Record, located at the end of the performance test procedures. Results of the HP-IB verification test should be recorded on a copy of the HP-IB Verification Test Record, *Table 4-3*, located at the end of the HP-IB verification test procedures.

Table 4-1. Equipment Required

Instrument	Required Characteristics	Recommended Model
Sweep Oscillator	.01-20 GHz [26.5 GHz] Frequency Modulation capability 14 MHz p-p	HP 8350B mainframe/ HP 83595A plug-in
Attenuator	dc to 26.5 GHz 0 - 70 dB in 10-dB steps	HP 3325B with Option 001 (10 MHz Oven Output)
Synthesizer	10 Hz to 10 MHz -20 dBm to +5 dBm	HP 3325B with Option 001 (10 MHz Oven Output)
Synthesizer	2 GHz to 26.5 GHz 1 Hz Accuracy +4 dBm output	HP 8673B or HP 8340B
Synthesized Signal Generator	10 MHz - 2.6 GHz 5% AM, 200 kHz FM p-p, -40 dBm to +10 dBm	HP 8660C / HP 86603A / HP 86632B or HP 8642A
Power Meter	50 MHz to 40 GHz	HP 437B
Power Sensor	50 MHz to 26.5 GHz, -30 to +10 dBm	HP 8485A
Power Splitter	dc to 26.5 GHz	HP 11667B
Power Meter	Range: 1 mW Transfer accuracy: 0.2% (input to output)	HP 432A
Thermistor Mount	SWR: 1.05 at 50 MHz Accuracy: $\pm 0.5\%$ at 50 MHz	HP 478A-H75 or HP 478A-H76
Fixed Attenuator	dc to 26.5 GHz, 10 dB	HP 8493C
Feedthrough	50 $\Omega$	HP 10100C
Spectrum Analyzer	RF inputs from 1 MHz	HP 8565A
Digital Voltmeter (Multimeter)	4½ digit AC/DC	HP 3466A
Synthesized Sweeper	10 MHz to 26.5 GHz	HP 8340B
50 $\Omega$ Termination	dc to 26.5 GHz	HP 909D
Vector Signal Generator	1 GHz with Frequency Modulation, 20 MHz p-p, 1 kHz modulating frequency	HP 8780A
Range Calibrator	Calibration functions: 3, 10, 30, 100, and 300 $\mu$ W; 1, 3, 10, 30, and 100 mW	HP 11683A
Sensor Cable	3.0 meters (10 ft)	HP 11730A

**4-8.**  
**OPERATIONAL  
VERIFICATION  
PROCEDURES**

The checks included here are not as thorough and exhaustive as the performance tests. This group of checks is intended only to serve as a method for giving the operator a high degree of confidence that the instrument is performing properly. **No attempt is made to check the specifications of the instrument.**

**4-9.**  
**Preliminary Procedure**

The following operational verification and performance test procedures require measurement of the actual input sensitivity of the HP 5347A/48A. Before measuring actual sensitivity, perform the following:

1. **To perform valid verification and testing of the specifications, allow the instrument to warm up for 30 minutes.**
2. Be sure to calibrate the power meter according to the frequency calibration data provided on the power sensor to be used in the test.
3. Decrease the input level to the HP 5347A/48A until it stops counting, then slowly increase the input level until the HP 5347A/48A measures the input properly (as defined by the particular procedure being performed).

**4-10.**  
**Power-Up Self Test**

1. Turn on the HP 5347A/48A and verify the Power-Up Self Test routine, as follows:
  - a. Immediately after switching the power on, the HP 5347A/48A performs a Display Test in which all segments of the Liquid Crystal Display are turned on. The display should remain in this state for about three seconds. Check that no segments are missing.
  - b. The next portion checks a number of internal circuits. If any of the internal tests fail, the results of the first test that failed will be displayed after the display test. Pressing the **Reset/Local** key will display the next test, if any, that failed. When all tests that failed have been displayed, the HP-IB address is displayed 5 seconds. If the Option 011 HP-IB Interface is not installed in the HP 5347A/48A, then the "HP-IB NOT INSTALLED" message will be displayed. If the tests pass, the HP-IB address or "HP-IB NOT INSTALLED" message is displayed immediately after the Display Test.
  - c. After the HP-IB address is displayed, the HP 5347A/48A should go into the measurement mode



last selected if the instrument had been previously left in the Standby mode.

- d. If a FAIL message is displayed during the Power-Up Self Test, refer to troubleshooting procedures in Section 8, Service, for information about specific diagnostic failures.
2. Mark Pass or Fail on the Operational Verification Record card (Table 4-2), line 1.

## 4-11. Frequency Counter Checks

### 4-12. INPUT 2, GATING AND COUNTING CHECK

**Description:** A 10 MHz input is connected to INPUT 2 to check that the HP 5347A/48A gates and counts with INPUT 2 impedance set at both 1 M $\Omega$  and 50 $\Omega$ .

1. Set up an HP 3325B Synthesizer to output a 1 V<sub>p-p</sub>, 10 MHz, sine-wave signal.
2. Connect the 10 MHz signal to INPUT 2 connector of the HP 5347A/48A.
3. Press **POWER** key to turn ON the HP 5347A/48A.
4. Press **Input 2 50  $\Omega$ /1 M $\Omega$**  key to set the HP 5347A/48A to the INPUT 2, 50  $\Omega$  impedance mode. (This key toggles INPUT 2's impedance between 50  $\Omega$  and 1 M $\Omega$  as indicated by the front panel 50  $\Omega$  and 1 M $\Omega$  annunciators). Observe that the ( $\nabla$ ) annunciator above the 50  $\Omega$  label on the front panel indicates that the INPUT 2 impedance is set to 50  $\Omega$ .
5. Verify the HP 5347A/48A displays 10 MHz.
6. Mark Pass or Fail on the Operational Verification Record card, line 2 (a).
7. Now, press **Input 2 50  $\Omega$ /1 M $\Omega$**  key to set INPUT 2 impedance to 1 M $\Omega$ .
8. Verify the HP 5347A/48A displays 10 MHz.
9. Mark Pass or Fail on the Operational Verification Record card, line 2 (b).

**4-13.**  
**INPUT 2, 10 Hz-525**  
**MHz INPUT**  
**SENSITIVITY CHECK**

**Specification:** 50 $\Omega$ : 10 MHz to 525 MHz, 25 mV rms  
1 M $\Omega$ : 10 Hz to 80 MHz, 25 mVrms

**Description:** This check is in two parts to check both the high frequency measuring capability of the 50  $\Omega$  input impedance and the low frequency measuring capability of the 1 M $\Omega$  input impedance of INPUT 2. In Part I, the HP 5347A/48A is set to the 10 MHz-525 MHz range, 50  $\Omega$  impedance, and a 25 mV rms (-19.3 dBm) signal is applied to INPUT 2. The source is set to selected frequencies and the HP 5347A/48A is checked for proper counting. Next, the HP 5347A/48A's 1 M $\Omega$  impedance for the lower frequency range is checked. Since the same test setup in *Figure 4-1* with the addition of a 50  $\Omega$  feedthrough is used to perform the 80 MHz check, the 80 MHz check is performed before the 10 Hz-50 MHz check. A 25 mV rms (-19.3 dBm) 80 MHz signal is applied to INPUT 2 through a 50  $\Omega$  feedthrough, and the HP 5347A/48A is checked for proper counting. In Part II, the test setup is changed to *Figure 4-2* to test the 10 Hz-50 MHz range.

**Part I: INPUT  
2, 50 MHz-525 MHz  
(50 $\Omega$ ) Check**

1. Connect the equipment as shown in *Figure 4-1*.

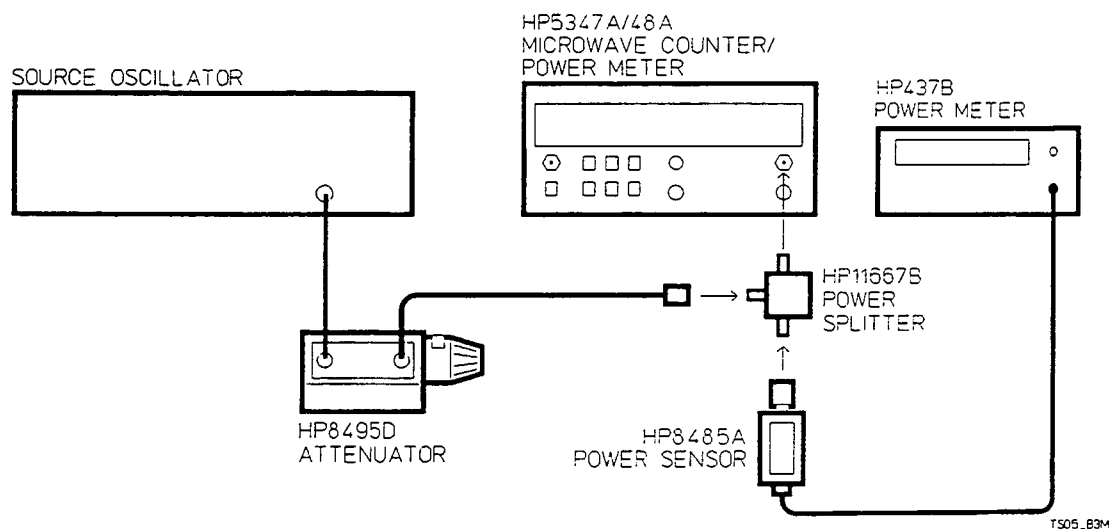

*Figure 4-1. INPUT 2, 50 MHz-525 MHz Verification Test Setup*

2. Press **Input 2 50  $\Omega$ /1 M $\Omega$**  key to set the HP 5347A/48A to the 10 MHz-525 MHz range, 50  $\Omega$  impedance. Observe that the  $\nabla$  annunciator indicates that INPUT 2 impedance is set to 50  $\Omega$ .
3. Set source to 50 MHz, and for an output level of 25 mV rms (-19.3 dBm) as measured on the HP 437B Power Meter. Measure actual sensitivity and verify that the HP 5347A/48A counts properly at 50 MHz, 100 MHz, 250 MHz, and 525 MHz. (Note that exact frequencies may not be achieved due to the frequency stability characteristics of the source.)
4. Mark Pass or Fail on the Operational Verification Record card, lines 3 through 6.

**INPUT 2, 80 MHz (1M $\Omega$ )  
Check (Part of Part I)**

**NOTE**

---

*The 1 M $\Omega$  impedance of INPUT 2 is checked with an 80 MHz input signal before it is checked with signals from 10 Hz through 50 MHz. This is done for convenience since to perform the 80 MHz check you need to use the test setup in Figure 4-1 with the addition of the 50  $\Omega$  feedthrough between the power splitter and INPUT 2 connector.*

---

1. Using the test setup in Figure 4-1, insert a 50  $\Omega$  feedthrough (HP 10100C) between the HP 1667B power splitter and INPUT 2 of the HP 5347A/48A.
2. Press **Input 2 50  $\Omega$ /1 M $\Omega$**  key to select the 1 M $\Omega$  impedance, 10 Hz-80 MHz input. Observe that the 1 M $\Omega$  annunciator ( $\nabla$ ) lights.
3. Set the source to 80 MHz, and for a level of 25 mVrms (-19.3 dBm) as measured on the HP 437B Power Meter.
4. Verify that the HP 5347A/48A counts properly at 80 MHz at 25 mVrms, and mark Pass or Fail on the Operational Verification Record card, line 7.

**Part II: INPUT 2, 10 Hz-50 MHz (1 M $\Omega$ ) Check**

1. Connect the equipment as shown in *Figure 4-2*.

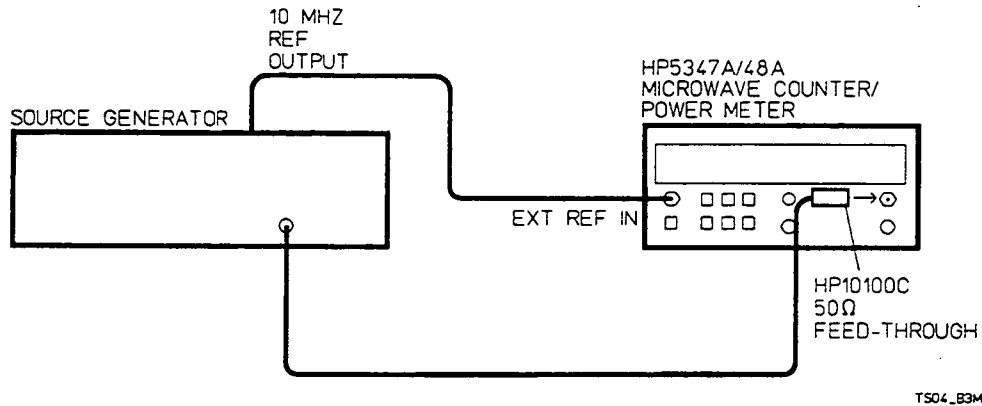

TS04\_B3M

*Figure 4-2. INPUT 2, 10 MHz-50 MHz Verification Test Setup*

2. The HP 5347A/48A settings are the same as in the 80 MHz test (INPUT 2, 1 M $\Omega$ ).
3. Set the source for an output of 25 mV rms (-19.3 dBm) at 10 Hz.
4. Verify that the HP 5347A/48A counts properly at 10 Hz, 50 kHz, 1 MHz, 10 MHz, and 50 MHz. Mark Pass or Fail on the Operation Verification Record card, lines 8 through 12.

<p>4-14. Specifications:</p> <p>INPUT 1, 500 MHz-20 GHz [26.5 GHz for HP 5348A]</p> <p>INPUT SENSITIVITY CHECK</p>	<table border="0"> <tr> <td></td> <td style="text-align: center;"><b>STANDARD INSTRUMENT</b></td> <td style="text-align: center;"><b>OPT 006</b></td> </tr> <tr> <td>HP 5347A/48A =</td> <td>-32 dBm, 500 MHz-12.4 GHz</td> <td>-29 dBm</td> </tr> <tr> <td></td> <td>-27 dBm, 12.4 GHz - 20 GHz</td> <td>-23 dBm</td> </tr> <tr> <td>HP 5348A only =</td> <td>-20 dBm, 20 GHz - 26.5 GHz</td> <td>-15 dBm</td> </tr> </table>		<b>STANDARD INSTRUMENT</b>	<b>OPT 006</b>	HP 5347A/48A =	-32 dBm, 500 MHz-12.4 GHz	-29 dBm		-27 dBm, 12.4 GHz - 20 GHz	-23 dBm	HP 5348A only =	-20 dBm, 20 GHz - 26.5 GHz	-15 dBm
	<b>STANDARD INSTRUMENT</b>	<b>OPT 006</b>											
HP 5347A/48A =	-32 dBm, 500 MHz-12.4 GHz	-29 dBm											
	-27 dBm, 12.4 GHz - 20 GHz	-23 dBm											
HP 5348A only =	-20 dBm, 20 GHz - 26.5 GHz	-15 dBm											

**Description:** The HP 5347A/48A is set to the 500 MHz-20 GHz [26.5 GHz for HP 5348A] range and the appropriate input signal is applied to INPUT 1. The source generator is set to selected frequencies and levels appropriate for the HP 5347A/48A, and the actual sensitivity of the HP 5347A/48A is measured up to 20 GHz [26.5 GHz for HP 5348A].

1. Connect the equipment as shown in *Figure 4-3*.

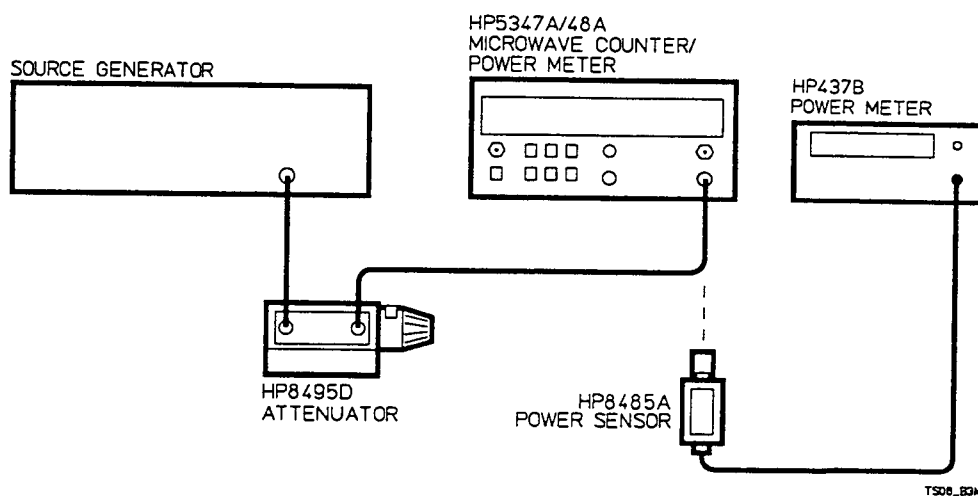

Figure 4-3. INPUT 1, 500 MHz-26.5 GHz Verification Test Setup

2. Press **Input 1 50 Ω** key to set the HP 5347A/48A to INPUT 1.
3. Set the source to 500 MHz, and set the output for -32 dBm as measured on the HP 437B. If Option 006 is installed, set the output to -29 dBm.
4. Measure the actual sensitivity at 500 MHz, 1 GHz, 5 GHz, and 12.4 GHz. (Verify the signal level with the HP 437B Power Meter at each of these frequencies.) Mark Pass or Fail on the Operational Verification Record card, lines 13 through 16.

5. Set the source to 18 GHz, and the output for -27 dBm as measured on the HP 437B. If Option 006 is installed, set the output to -23 dBm.
6. Measure the actual sensitivity at 18 GHz and 20 GHz- (Verify the signal level with the HP 437B Power Meter at each of these frequencies.) Mark Pass or Fail on the Operational Verification Record card, lines 17 and 18.
7. **For the HP 5348A only**, set the source for -20 dBm at 22 GHz. Measure the dBm at 22 GHz. Measure the actual sensitivity at 22 GHz and 26.5 GHz. Mark Pass or Fail on the Operational Verification Record card, lines 19 and 20. If Option 006 is installed, set the output to -15 dBm.

#### 4-15. Power Meter Checks

**Description:** Checks the HP 5347A/48A ability to zero, and to calibrate on the 1 mW, 50 MHz Power Reference Oscillator signal.

#### Equipment

Power Sensor ..... HP 8485A  
Power Sensor Cable ..... HP 11730A

#### Procedure

1. With the HP 5347A/48A OFF, set the **SENSOR TYPE** switches of the rear panel DIP switch to select the 8485A sensor.
2. Connect the equipment as shown in *Figure 4-4*.

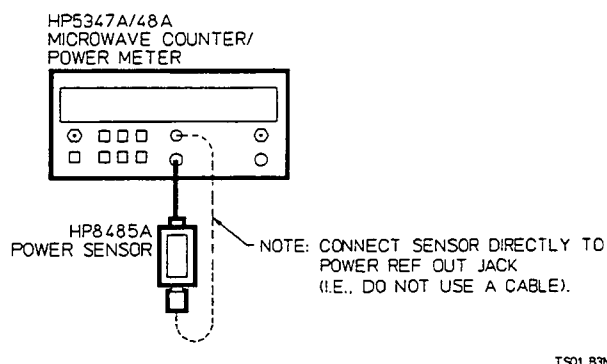

Figure 4-4. Power Meter Mode Verification Test Setup

3. Turn on the HP 5347A/48A
4. Press **Input dBm/Watt** key.
5. Press the **Zero** key, and observe the "ZEROING" message in the display during the process, which takes from 10 to 20 seconds. When completed, the HP 5347A/48A will show random readings, reflecting residual noise in the Power Meter circuits.
6. Press **Input dBm/Watt** key again, and verify that the reading is  $0.00 \pm 0.06 \mu\text{W}$ . Mark Pass or Fail on the Operational Verification Record card, line 21.
7. Press **Calibrate/Store** key, and observe the "CALIBRATING" message in the display during the process, which takes about 5 seconds.
8. Correct operation is signaled by the fact that after "CALIBRATING" message disappears, the display will show random readings, and no error message appears. (Note: the Power Reference Oscillator is ON **only** during the actual calibration process. The Performance Tests [Section 4-24] contain a test procedure to check the Power Reference Oscillator output level.)
9. Verify random readings. Mark Pass or Fail on the Operational Verification Record card, line 22.



Table 4-2. Operational Verification Record

Hewlett-Packard Model 5347/48A Microwave Frequency Counter/Power Meter		Repair/Work Order No. _____	
Serial Number: _____		Temperature _____	
Test Performed By: _____		Relative Humidity: _____	
Date: _____		Post Calibration Test: <input type="checkbox"/>	
Notes: _____		Pre Calibration Test: <input type="checkbox"/>	
PARA. NO.	TEST	TEST RESULTS PASS	FAIL
4-10.	Power-Up Self Test	1. _____	_____
4-12.	INPUT 2, Gating and Counting Check (50Ω/1 MΩ)	2 (a). _____ 2 (b). _____	_____ _____
4-13.	INPUT 2, 10 Hz-525 MHz Input Sensitivity Check (50 Ω/1 MΩ):		
	Part I 50Ω: 50 MHz	3. _____	_____
	100 MHz	4. _____	_____
	250 MHz	5. _____	_____
	525 MHz	6. _____	_____
	1 MΩ: 80 MHz	7. _____	_____
	Part II 1 MΩ: 10 Hz	8. _____	_____
	50 kHz	9. _____	_____
	1 MHz	10. _____	_____
	10 MHz	11. _____	_____
	50 MHz	12. _____	_____
4-14.	INPUT 1, 500 MHz - 20 GHz [26.5 GHz] Input Sensitivity Test:		
	Part I 50Ω: 500 MHz	13. _____	_____
	1 GHz	14. _____	_____
	5 GHz	15. _____	_____
	12.4 GHz	16. _____	_____
	Part II 1 MΩ: 10 Hz	17. _____	_____
	50 kHz	18. _____	_____
	(HP 5348A only) 22 GHz	19. _____	_____
	26.5 GHz	20. _____	_____
4-15.	POWER METER CHECKS		
	0.00 ± 0.06 μW random readings	21. _____	_____
		22. _____	_____

## 4-16. PERFORMANCE TEST PROCEDURES

### 4-17. Frequency Counter Tests

#### 4-18. INPUT 2, 10 Hz-525 MHz INPUT SENSITIVITY TEST

**Specification:** 50 $\Omega$ : 10 MHz to 525 MHz, 25 mV rms  
1 M $\Omega$ : 10 Hz to 80 MHz, 25 mVrms

**Description:** This test is in two parts to check both the high frequency measuring capability of the 50  $\Omega$  input impedance and the low frequency measuring capability of the 1 M  $\Omega$  input impedance of INPUT 2. In Part I, the HP 5347A/48A is set to the 10 MHz-525 MHz range, 500 impedance, and a 25 mV rms (-19.3 dBm) signal is applied to INPUT 2. The source oscillator is set to selected frequencies and the HP 5347A/48A is checked for proper counting. Next, the HP 5347A/48A 1 M $\Omega$  impedance for the lower frequency range is checked. Since the same test setup in Figure 4-5 with the addition of a 50 $\Omega$  feedthrough is used to perform the 80 MHz check, the 80 MHz check is performed before the 10 Hz-50 MHz check. A 25 mVrms (-19.3 dBm) 80 MHz signal is applied to INPUT 2 through a 50  $\Omega$  feedthrough, and the HP 5347A/48A is checked for proper counting. In Part II, the test setup is changed to Figure 4-6 to test the 10 Hz-50 MHz range.

#### Part I: INPUT 2, 50 MHz-525 MHz (50 $\Omega$ ) Test

1. Connect the equipment as shown in Figure 4-5.

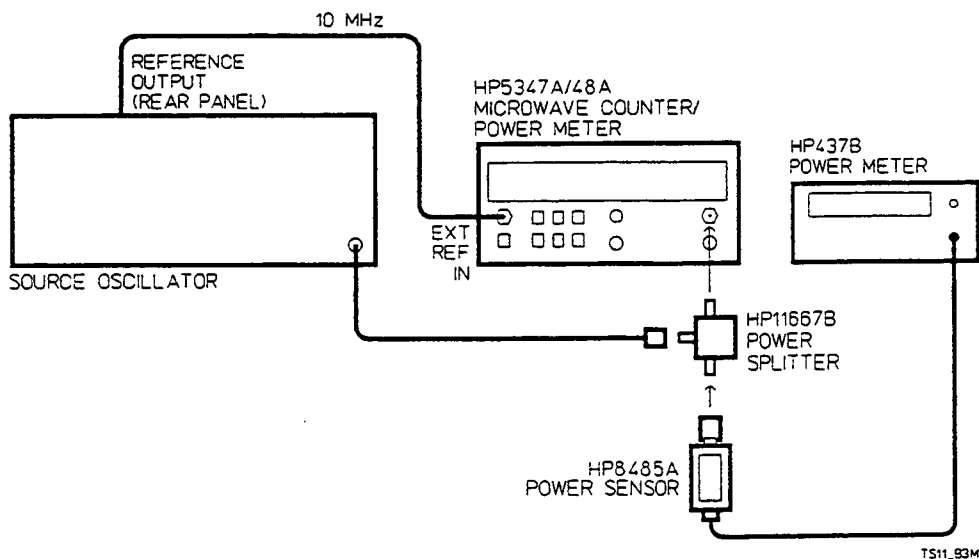

Figure 4-5. INPUT 2, 50 MHz-525 MHz Test Setup

2. Press **Input 2 50  $\Omega$ /1 M $\Omega$**  key to set the HP 5347A/48A to the 10 MHz-525 MHz range, 50  $\Omega$  impedance. Observe that 50 $\Omega$  annunciator lights.
3. Set the source to 50 MHz, and for an output level of 25 mV rms (-19.3 dBm) as measured on the HP 437B Power Meter. Verify that the HP 5347A/48A counts 50 MHz, 100 MHz, 200 MHz, 400 MHz, and 525 MHz,  $\pm 1$  Hz. Record the actual sensitivity at each frequency on the Performance Test Record, located at the end of the performance test procedures.

**INPUT 2,  
80 MHz (1 M $\Omega$ ) Test  
(Part of Part I)**

1. Using the test setup in *Figure 4-5*, connect the HP 11667B to INPUT 2 of the HP 5347A/48A via a 50  $\Omega$  feedthrough (HP 10100C).
2. Press **Input 2 50 $\Omega$ /1 M $\Omega$**  key to select the 1 M $\Omega$  impedance of INPUT 2.
3. Set the source to 80 MHz, and for an output level of 25 mVrms(-19.3 dBm) as measured on the HP 437B Power Meter.
4. Verify that the HP 5347A/48A counts 80 MHz,  $\pm 1$  Hz, at 25 mVrms (-19.3 dBm). Enter the results on the Performance Test Record.

**Part II:  
INPUT 2, 10 Hz-10 MHz  
(1 M $\Omega$ ) Test**

1. Connect the equipment as shown in *Figure 4-6*.

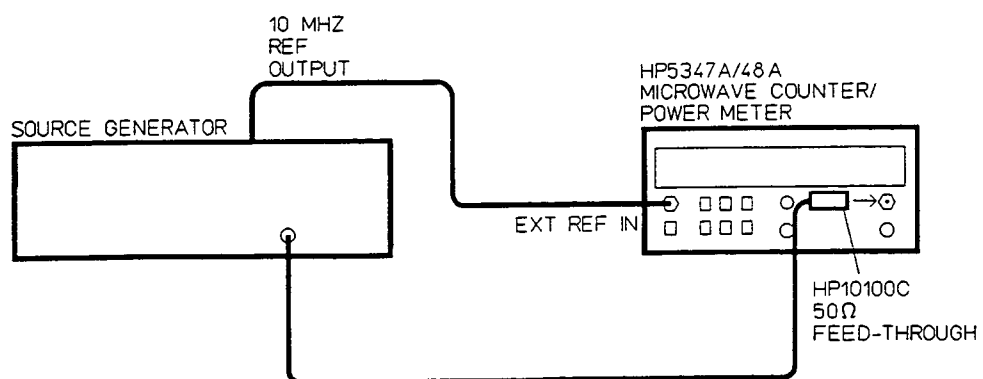

TS04\_B3M

Figure 4-6. INPUT 2, 10 Hz-10 MHz Test Setup

2. The HP 5347A/48A settings are the same as in the 80 MHz test (INPUT 2, 1 MΩ).
3. Set the source for an output of 25 mV rms (-19.3 dBm) at 10 Hz.
4. Verify that the HP 5348A counts properly at 10 Hz, 1 kHz, 500 kHz, 1 MHz, and 10 MHz, +1 Hz. Record the actual sensitivity on the Performance Test Record.

If the HP 5347A/48A fails any of the above sensitivity tests, refer to Section 5 (Adjustments) and verify the INPUT 2 sensitivity adjustment (Peak Detector Adjustment, A2R1). If this adjustment is correct, and the HP 5347A/48A continues to fail the sensitivity tests, refer to Section 8, for troubleshooting procedures for the following assemblies, in the order shown:

A2 Low Frequency Input Assembly  
A3 Counter Assembly

**4-19. INPUT 1,  
500 MHz-20 GHz  
[26.5 GHz for HP  
5348A] INPUT  
SENSITIVITY TEST**

The following test is in two parts, *Figure 4-7* is the test setup for Part I (500 MHz to 1 GHz), and *Figure 4-8* is the test setup for Part II (2.5 GHz to 20 GHz [26.5 GHz for HP 5348A]).

**Specifications:**

	STANDARD INSTRUMENT	OPT 006
HP 5347A/48A =	-32 dBm, 500 MHz-12.4 GHz	-29 dBm
	-27 dBm, 12.4 GHz - 20 GHz	-23 dBm
HP 5348A only =	-20 dBm, 20 GHz - 26.5 GHz	-15 dBm

**Description:** In Part I, the HP 5347A/48A is set to the 500 MHz - 20 GHz [26.5 GHz for HP 5348A] range and the appropriate input signal is applied to INPUT 1. The source generator is set to selected frequencies up to 1 GHz, and the actual sensitivity of the HP 5347A/48A is measured. In Part II, the test setup is changed to *Figure 4-8* to measure sensitivity in the 2.5 GHz-20 GHz [26.5 GHz for HP 5348A] range. The source generator is set to the appropriate test level, and the actual sensitivity is measured at selected frequencies up to 20 GHz [26.5 GHz for HP 5348A].

- Part I:** 1. Connect the equipment as shown in *Figure 4-7*.  
**INPUT 1,**  
**500 MHz - 1 GHz Test**

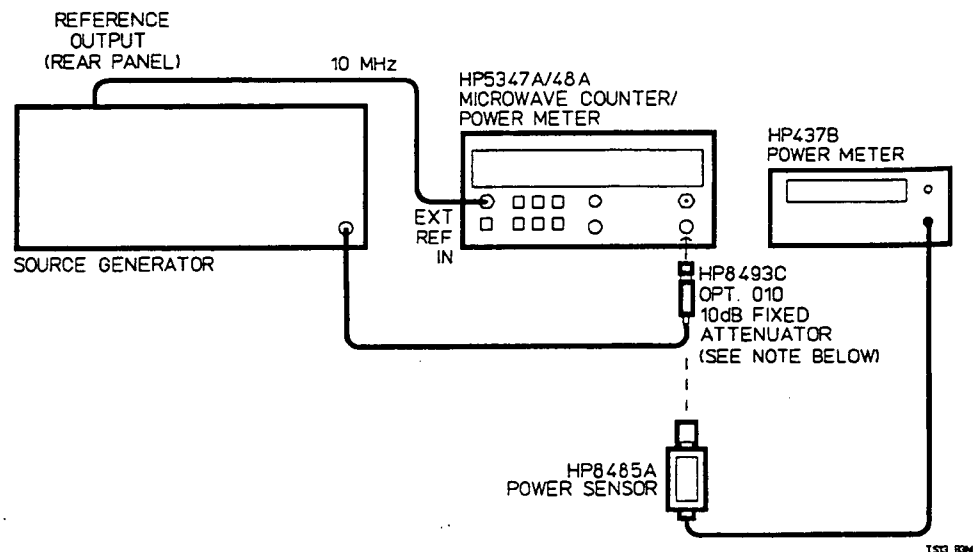

Figure 4-7. INPUT 1, 500 MHz-1 GHz Test Setup

2. Press **Input 1 50  $\Omega$**  key to set the HP 5347A/48A to INPUT 1.
3. Set the source to 500 MHz, and for an output of -22 dBm as measured on the HP 437B, **without** the attenuator in line. If Option 006 is installed, set the output to -29 dBm.

#### **NOTE**

*The HP 8485A Power Sensor measures down to -30 dBm; therefore; it is not possible to set the signal level at -32 dBm. By using the 10 dB Fixed Attenuator and setting the level at -22 dBm, an output of -32 dBm can be attained at the input of the Counter. (If Option 006 is installed, the attenuator is not needed.)*

4. Connect the source to the HP 5347A/48A with the attenuator in line. If Option 006 is installed, do not use the attenuator.
5. Measure the actual sensitivity at 500 MHz and 1 GHz. (The HP 5347A/48A should measure these frequencies to  $\pm 4$  Hz). Verify the signal levels with HP 437B Power Meter at

each frequency. Enter the result on the Performance Test Record.

**Part II:**  
**INPUT 1, 2.5 GHz - 20 GHz**  
**[26.5 GHz for HP 5348A]**  
**Test**

1. Connect the equipment as shown in *Figure 4-8*.

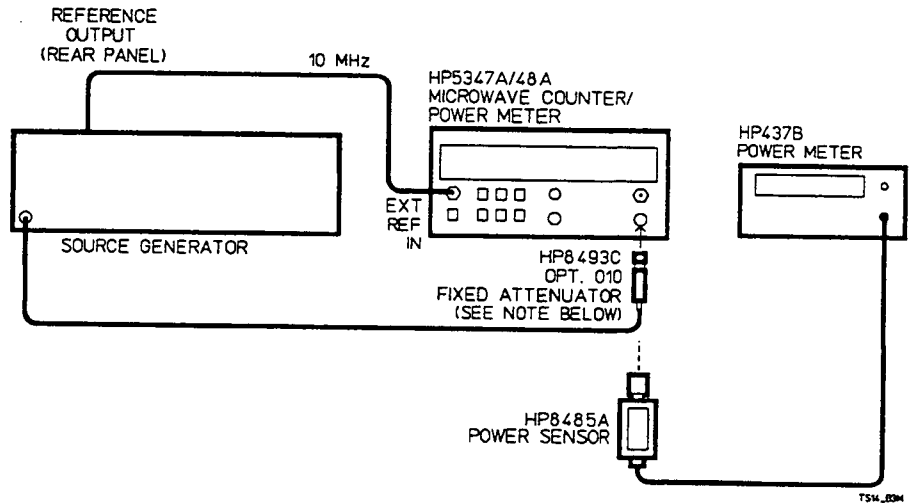

*Figure 4-8. INPUT 1, 2.5 GHz-20 GHz [26.5 GHz] Test Setup*

2. The HP 5347A/48A settings are the same as in Part I (INPUT 1).
3. Set the source to 2.5 GHz at a level of -22 dBm, as measured on the HP 437B, **without** the attenuator in line. If Option 006 is installed, set the output to -29 dBm.

**NOTE**

*The HP 8485A Power Sensor measures down to -30 dBm; therefore; it is not possible to set the signal level at -32 dBm by using the 10 dB Fixed Attenuator and setting the level at -22 dBm, an output of -32 dBm can be attained at the input of the Counter. (If Option 006 is installed, the attenuator is not needed.)*

4. Connect the source to the HP 5347A/48A with attenuator in line. If Option 006 is installed, do not use the attenuator.
5. Measure actual sensitivity at 2.5, 5, 10, and 12.4 GHz, by first verifying the signal level with the 437B/8485A, and

then verifying that each of the frequencies is counted to  $\pm 4$  Hz.

6. Set the source to 18 GHz at a level of -17 dBm, as measured on the HP 437B, with the 10 dB attenuator in place. (Since the -27 dBm signal desired is within the power sensor range, the 10 dB attenuator can be removed, if desired. In this case, adjust the source for -27 dBm signal level.) If Option 006 is installed, do not use the attenuator, and set the output to -23 dBm.
7. Measure actual sensitivity at 18, 19, and 20 GHz, by first verifying the signal level with the HP 437B, and then verifying that each of the frequencies is counted to  $\pm 4$  Hz.
8. **For the HP 5348A only**, repeat the above procedure for 20-26.5 GHz at the appropriate input level (-10 dBm) with the 10 dB attenuator in place. (Since the -16 dBm signal desired is within the power sensor range, the 10 dB attenuator can be removed, if desired. In this case, adjust the source for -20 dBm signal level.) Measure actual sensitivity at 22 GHz, 24 GHz, and 26.5 GHz,  $\pm 4$  Hz. If Option 006 is installed, do not use the attenuator, and set the output to -15 dBm.
9. Enter the results on the Performance Test Record.

If the HP 5347A/48A fails any of the above sensitivity tests, refer to Section 5 (Adjustments) and verify the A6 IF Amplifier/Detector Assembly adjustments. If these adjustments are correct, and the HP 5347A/48A continues to fail the above tests, refer to Section 8 (Service) for troubleshooting procedures for the following assemblies:

Microwave Module (A12 Microwave Assembly, U1  
Sampler)  
A6 IF Amplifier/Detector Assembly  
A3 Counter Assembly  
A5 Synthesizer Assembly

**4-20.  
AUTOMATIC  
AMPLITUDE  
DISCRIMINATION  
TEST**

**Specification:** The HP 5347A/48A measures the largest of all signals present, provided that the signal is 6 dB (typical) above any signal within 500 MHz; 20 dB (typical) above any signal, 500 MHz to 20 GHz [26.5 GHz for HP 5348A].

**Description:** Two microwave source generators are used to provide two signals to the HP 5347A/48A. The relative level of the two signals is adjusted to the specification, and the HP 5347A/48A must count the higher amplitude signal.

1. Connect the Equipment as shown in *Figure 4-9*.

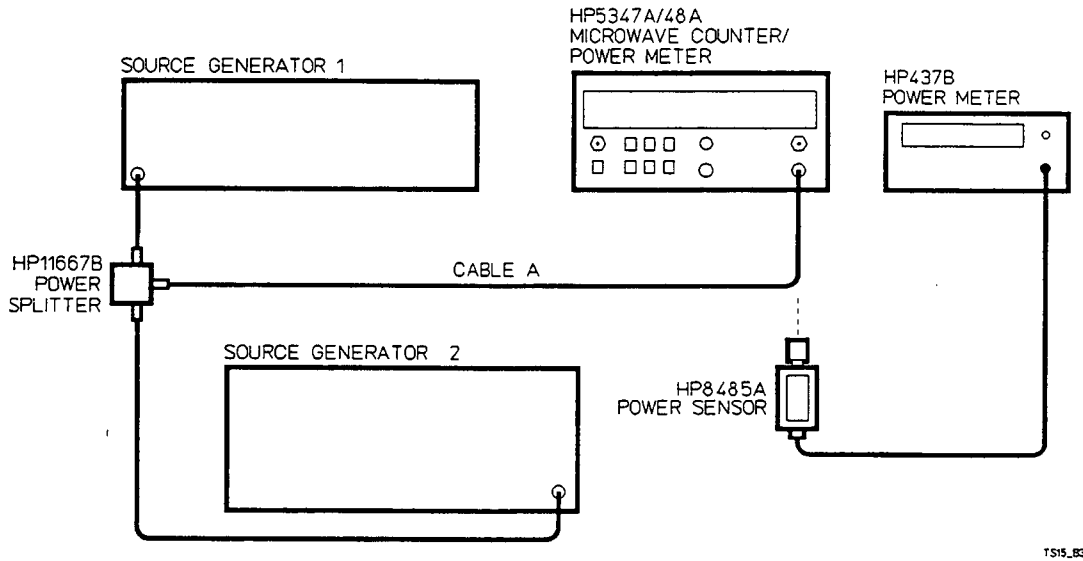

*Figure 4-9. Automatic Amplitude Discrimination Test Setup*

**NOTE**

*The second frequency source is not required to have a wideband capability. The frequency range of source 2 need only be 500 MHz to 2 GHz.*

2. Set source 1 for an 18 GHz output at a level to deliver -5 dBm to the HP 5347A/48A. To set this level, disconnect source 2 from the HP 11667B and terminate that port of the HP 11667B with a 909D 50  $\Omega$  termination. Connect the HP 8485A Power Sensor to the HP 5347A/48A end of cable A and adjust source 1 output for a -5 dBm reading.
3. Set source 2 for a 500 MHz output at a level to deliver -25 dBm to the HP 5347A/48A. To set this level, disconnect source 1 from the HP 11667B input (reconnect source 2 to



the HP 11667B) and terminate source 1 port of the HP 11667B with the 909D 50  $\Omega$  termination. Connect the HP 8485A to the HP 5347A/48A end of cable A and adjust source 2 for a -25 dBm reading.

4. Connect both sources to the HP 11667B inputs. Connect cable A to INPUT 1 of the HP 5347A/48A. Verify that the HP 5347A/48A counts 18 GHz. Increase the level of source 2 until the HP 5347A/48A counts incorrectly; measure that level (using the procedure described above) and enter the result on the Performance Test Record.
5. Set source 1 for a 2.5 GHz output at a level to deliver -5 dBm to the HP 5347A/48A using the technique described above. Set source 2 for a 2.0 GHz output at a level to deliver -11 dBm to the HP 5347A/48A using the same technique. Connect both sources to the HP 11667B, and cable A to the HP 5347A/48A. Verify that the HP 5347A/48A counts 2.5 GHz. Increase source 2 level until the HP 5347A/48A counts incorrectly; measure that level and enter the result on the Performance Test Record.

If the HP 5347A/48A fails the above Automatic Amplitude Discrimination tests, refer to Section 8 (Service) for troubleshooting procedures for the following assemblies:

A6 IF Amplifier/Detector Assembly  
Microwave Module (A12 Microwave Assembly,  
U1 Sampler)

#### 4-21. FM TOLERANCE TEST

**Specification:** 20 MHz maximum peak-to-peak deviation

**Description:** The FM peak-to-peak deviation specification indicates the worst case FM deviation which can be present on a carrier that the HP 5347A/48A can acquire and count. The HP 5347A/48A averages out the deviations and displays a carrier frequency. In addition, the HP 5347A/48A offers a choice of two FM rate modes. This test will verify that the HP 5347A/48A performs properly in these modes.

1. Connect the equipment as shown in Figure 4-10.

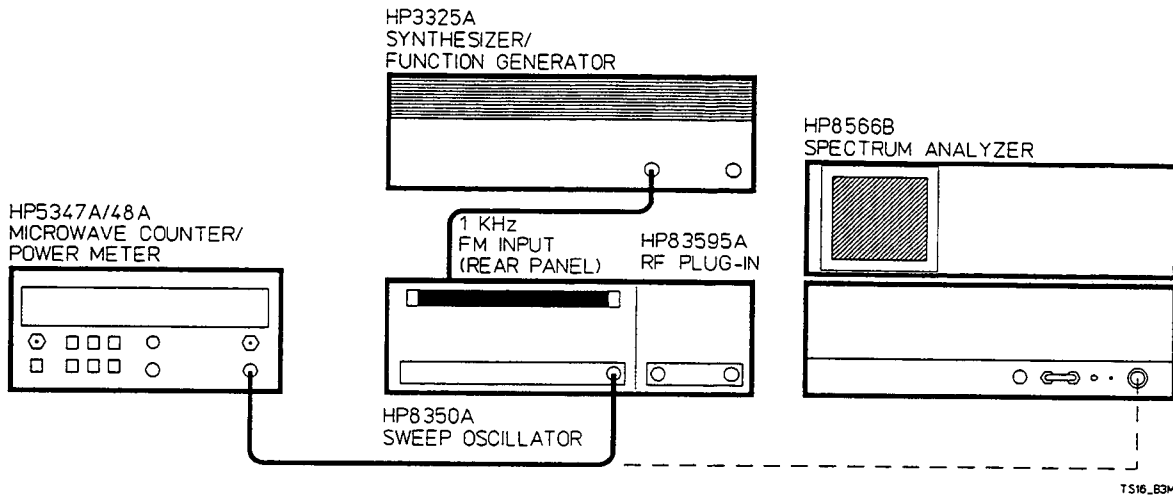

Figure 4-10. FM Tolerance Test Setup

2. Verify that the HP 5347A/48A is set for 1 Hz resolution (In this setting, FM Rate is NORMAL). The "2" switch of the rear panel RES switch on the HP 5347A/48A should be set to the 1 Hz (down) position.
3. Set the source to 1 GHz and the HP 83595A to -5 dBm.
4. Set the HP 3325B to 1 kHz.
5. Using the Spectrum Analyzer to verify the width of the FM deviation at the output of the source, set the amplitude of the HP 3325A output to achieve a peak-to-peak width of 14 MHz. For a full explanation of the FM Tolerance, refer to Section 8-111 in the Service manual.

**NOTE**

The test source shown in Figure 4-10 is commonly available equipment, but is specified to  $\pm 7$  MHz FM deviation, or 14 MHz p-p at a 1 kHz modulating frequency. It may produce a test signal in excess of this, but its performance is not specified beyond 14 MHz p-p. For larger deviations with test equipment specifications, the HP 8780A Vector Signal Generator may be substituted.

Verify that the HP 5347A/48A acquires and counts the modulated input (1 GHz) correctly, as follows.

6. The following steps are used to display the harmonic number, which indicates that the HP 5347A/48A has set its internal Local Oscillator (LO) to correctly measure the input frequency. Since the HP 5347A/48A measures the Average Frequency over the gate time, a FM input will cause a displayed value that will vary. However, the harmonic number will not vary more than 0.3 from its integer value if the HP 5347A/48A is working properly. The Diagnostics mode is used to display this number. Two methods exist to enter this mode:

- Rear panel DIP switch
- HP-IB

For instruments not equipped with the HP-IB or where the use of the HP-IB is not desired, proceed to step 7.

For instruments equipped with the HP-IB, proceed to step 8.

7. To set the HP 5347A/48A to Diagnostic 6 by using the rear panel DIP switch, perform the following:
  - a. Turn off the HP 5347A/48A.
  - b. Set rear panel **MODE** switch to the **Diagnostics** mode ("Up" position).
  - c. Turn on the HP 5347A/48A.
  - d. Press **Input 2 50  $\Omega$ /1 M $\Omega$**  or **Input 1 50  $\Omega$**  key (depending on whether you need to increment or decrement to get to Diagnostic 6).
  - e. Press **Calibrate/Store** key to initiate the Diagnostic 6 test.

The HP 5347A/48A will display the determined harmonic number, including the fractional portion. Verify that the fractional portion of the displayed harmonic number does not deviate more than 0.30 from the integer value. (For example, a harmonic number of 3 should not deviate to less than 2.70, or greater than 3.30.)

8. To set the HP 5347A/48A to Diagnostic 6 via the HP-IB, perform the following:
  - a. Set the HP 5347A/48A HP-IB address to a known value.

- b. Connect a suitable controller (e.g., HP 9836, HP 200/300 Series controller) to the HP 5347A/48A rear panel HP-IB connector.
  - c. Send the command **OUTPUT 7XX; "DIAGENT"** — where XX is the address selected in step a, above.
  - d. Now, send the command **OUTPUT 7XX; "DIAG 6"**.
9. Set the HP 5347A/48A for 10 KHz resolution (In this setting, FM Rate is TRACK):
- a. Turn off the HP 5347A/48A.
  - b. Set rear panel **RES** switch to the **10 KHZ** position.
  - c. Turn on the HP 5347A/48A.  
or  
Use the HP-IB as described in step 8, and send **OUTPUT 7XX; "RESOL 4"** command — where XX is the selected address.
10. Set the HP 3325B to output 300 KHz, and verify the test signal on the Spectrum Analyzer.
11. Set the HP 5347A/48A to DIAG 6 as described previously.
12. Verify the harmonic numbers as described at the end of step 7. The harmonic numbers should not deviate more than 0.3 from its integer value. Mark Pass or Fail on the Performance Test Record card.
13. Press **Reset/Local** key on the HP 5347A/48A. This completes the test.

If the HP 5347A/48A fails the FM Tolerance test, refer to Section 5 (Adjustments), and verify the A6 IF Amplifier/Detector Assembly adjustments. If the adjustments are correct and the HP 5347A/48A continues to fail, refer to Section 8 (Service) for troubleshooting procedures for the following assemblies:

A6 IF Amplifier/Detector Assembly  
Microwave Module (A12 Microwave Assembly,  
U1 Sampler)

**4-22. Power Meter Tests**

**NOTE**

To perform valid testing of the specifications, the instrument must be warmed up for 30 minutes.

**4-23. POWER METER ACCURACY TEST**

**Specifications:**

Electrical Characteristics	Performance Limits	Conditions
Accuracy: Instrumentation, includes sensor linearity.	$\pm 0.5\%$ or $\pm 0.02$ dB	Within same calibration range.

**Description:** After the Power Meter is initially calibrated on the 1 mW range, the readout is monitored as the range calibrator is switched to provide reference inputs corresponding to each of the Power Meter operating ranges.

**Equipment**

- Range Calibrator ..... HP 11683A
- Power Sensor Cable ..... HP 11730A

1. Connect the equipment as shown in *Figure 4-11*.

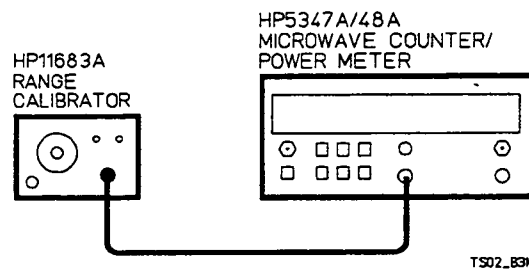

*Figure 4-11. Power Meter Accuracy Test Setup*

2. Turn on the HP 5347A/48A
3. Press **Reset/Local** key.
  - a. Press **Input 2** key.
  - b. Press **Calibrate/Store Frequency** key.
4. Set the Range Calibrator switches as follows:  
FUNCTION..... STANDBY  
POLARITY ..... NORMAL  
RANGE..... 1 mW  
LINE..... ON
5. Press the **Input dBm/Watt** key twice. This will set the HP 5347A/48A to read power in the Watt units.
6. Press the **Zero** key, and wait for the readout to appear. Verify that the reading is  $0.00 \pm 0.06 \mu\text{W}$ .
7. Set the Range Calibrate FUNCTION switch to CALIBRATE.
8. Press **Calibrate/Store** key. Verify that the HP 5347A/48A display reads  $1.000 \pm 0.006 \text{ mW}$ .

**NOTE**

---

*The Range Calibrator output level is adjustable in 5 dB increments. Thus, the 3  $\mu\text{W}$ , 30  $\mu\text{W}$ , 300  $\mu\text{W}$ , 3  $\mu\text{W}$ , and 30 mW legends on the RANGE switch are approximations. The true values for these settings are 3.16, 31.6, and 316  $\mu\text{W}$ , 3.16 mW and 31.6 mW*

---

9. Set the Range Calibrator RANGE switch to the positions shown in the following table. For each setting, verify that the HP 5347A/48A autoranges properly, and that the display is within the limits shown.

RANGE CALIBRATOR		RESULTS	
RANGE	MIN	ACTUAL	MAX
3 $\mu$ W	3.10 $\mu$ W	_____	3.23 $\mu$ W
10 $\mu$ W	9.90 $\mu$ W	_____	10.10 $\mu$ W
30 $\mu$ W	31.4 $\mu$ W	_____	31.8 $\mu$ W
100 $\mu$ W	99.5 $\mu$ W	_____	100.5 $\mu$ W
300 $\mu$ W	0.314 mW	_____	0.318 mW
1 mW	0.995 mW	_____	1.005 mW
3 mW	3.14 mW	_____	3.18 mW
10 mW	9.95 mW	_____	10.05 mW
30 mW	31.4 mW	_____	31.8 mW
100 mW	99.5 mW	_____	100.5 mW

10. Enter the results on the Performance Test Record.
11. Press the **Input dBm/Watt** key again to the dBm position and verify that the display changes to the dBm mode, and that the indication is within  $20.00 \pm 0.04$  dBm with the Range Calibrator in the 100 mW/20 dBm position.

19.98 dBm..... 20.02 dBm

12. Enter the results on the Performance Test Record.
13. Set the Range Calibrator RANGE switch to -10 dBm.
14. Verify that the Power Meter displays  $-10.00 \pm 0.04$  dBm.

-9.98 dBm..... -10.02 dBm

Enter the results on the Performance Test Record.

**4-24.**  
**POWER METER**  
**REFERENCE LEVEL**  
**TEST**

**Specification:**

Electrical Characteristics	Performance Limits	Conditions
Power reference	1.0 mW	Internal 50 MHz oscillator factory set to $\pm 0.7\%$ traceable to the National Institute of Standards and Technology.
Power reference Accuracy	$\pm 1.2\%$ $\pm 0.9\%$	Worst case root-sum square (RSS) for one year.

**Description:** The power reference oscillator output is factory adjusted to  $1 \text{ mW} \pm 0.7\%$ . To achieve this accuracy, Hewlett-Packard employs a special measurement system accurate to 0.5% (traceable to the National Institute of Standards and Technology) and allows for a transfer error of  $\pm 0.2\%$  in making the adjustment. If an equivalent measurement is employed for verification, the power reference oscillator output can be verified to  $1 \text{ mW} \pm 1.9\%$  ( $\pm 1.2\%$  accuracy plus  $\pm 0.5\%$  verification system error plus  $\pm 0.2\%$  transfer error = 1.9% maximum error). The power reference oscillator Output can be set to  $\pm 0.7\%$  using the same equipment and following the adjustment procedure. To ensure maximum accuracy in verifying the power reference oscillator output, the following procedure provides step by step instructions for using specified Hewlett-Packard test instruments of known capability. If equivalent test instruments are used, signal acquisition criteria may vary and reference should be made to the manufacturer's guidelines for operating the instruments.

**Equipment**

- Test Power Meter ..... HP 432A
- Thermistor Mount..... HP 478A-H75 or  
 ..... HP 478A-H76
- Digital Voltmeter (DVM) ..... HP 3466A
- Power Sensor Cable..... HP 8120-1082



## Procedure

1. Make sure the HP 432A is OFF for the following setup tests.
2. Set up the DVM to measure resistance and connect the DVM between the Vrf connector on the rear panel of the HP 432A (test power meter), and pin 1 on the thermistor mount end of the test power meter interconnect cable (HP P/N 8120-1082). See the figure below to locate pin 1:

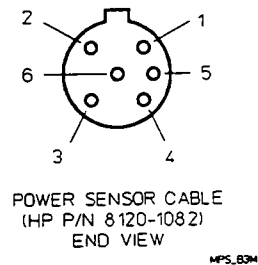

3. Round off the DVM indication to two decimal places and record this value as the internal bridge resistance (R) of the test power meter (approximately 200 ohms).

R \_\_\_\_\_

4. Connect the test power meter to the HP 5347A/48A Power Ref. as shown in *Figure 4-12*.

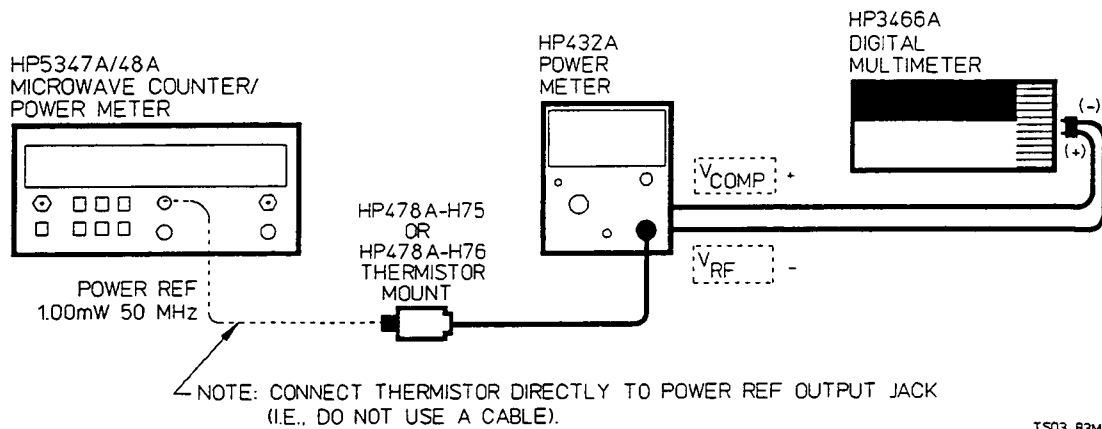

Figure 4-12. Power Meter Reference Level Test Setup

5. Set the HP 432A and HP 5347A/48A POWER to ON state. **Then wait thirty minutes for the test power meter thermistor mount to stabilize before proceeding to the next step.**
6. Set the test power meter Range switch to Coarse Zero and adjust the front panel Coarse Zero control to obtain a zero meter indication.
7. Fine Zero the test power meter on the most sensitive range, than set the test power meter Range switch to 1 mW. On the HP 432, press **FINE ZERO** toggle switch down to actuate the Fine Zero function.

**NOTE**

---

*Ensure that the DVM input leads are isolated from chassis ground when performing the next step.*

---

8. Set up the DVM to measure microvolts and connect the positive and negative input leads, respectively, to the Vcomp and Vrf connectors on the rear panel of the test power meter. Note that Vcomp and Vrf connectors are BNC female. BNC cables and BNC-to-banana jack adapters for DVM connection will make hookup easy.
9. Observe the indication on the DVM. If less than 400 microvolts, proceed to the next step. If 400 microvolts or greater, press and hold the test power meter Fine Zero switch and adjust the Coarse Zero control so that the DVM indicates 200 microvolts or less. Then release the Fine Zero switch and proceed to the next step.
10. Round off the DVM indication to the nearest microvolt and record this value as  $V_0$

$V_0$  \_\_\_\_\_

11. Turn on the 1 mV, 50 MHz Power Reference Oscillator; there are two methods that can be used to turn on the Power Reference Oscillator (The reference oscillator is normally ON when the **Calibrate/ Store** key is pressed, and is turned OFF when the calibration cycle is completed.):
  - Diagnostic 73 via DIP switch
  - HP-IB

For instruments not equipped with the HP-IB or where the use of the HP-IB is not desired, proceed to step 12.

For instruments equipped with the HP-IB, proceed to step 13.

12. To set the HP 5347A/48A to Diagnostic 73 by using the rear panel DIP switch, perform the following:
  - a. Turn off the HP 5347A/48A.
  - b. Set rear panel MODE switch to Diagnostics mode ("up" position).
  - c. Turn on the HP 5347A/48A.
  - d. Press **Input 2 50  $\Omega$ /1 M $\Omega$**  or **Input 1 50  $\Omega$**  key (depending on whether you need to increment or decrement to get to Diagnostic 73).
  - e. Press **Calibrate/Store** key to initiate Diagnostic 73. The Power Reference Oscillator should now be ON. Proceed to step 14.
  
13. To turn on the 1 mV, 50 MHz Power Reference Oscillator via the HP-IB, perform the following:
  - a. Connect a controller to the HP 5347A/48A.
  - b. Check the address setting of HP 5347A/48A rear panel HP-IB switch.
  - c. Send the **OUTPUT 7XX;"LG;OC1"** command. This will cause the HP 5347A/48A to enter the Power Meter mode (dBm readings), and turn on the Power Reference Oscillator.
  
14. Record the indications observed on the DVM as  $V_1$ .

$V_1$  \_\_\_\_\_

15. Disconnect the DVM negative input lead from the  $V_{rf}$  connector on the test power meter. Reconnect it to the test power meter chassis ground. Record the new indication observed on the DVM as  $V_{comp}$ .

$V_{comp}$  \_\_\_\_\_

16. Calculate the Power Reference Oscillator output level (Prf) from the following formula:

$$Prf = \frac{2V_{comp} (V_1 - V_0) + V_0^2 - V_1^2}{4R (\text{Calibration Factor})}$$

Where:

Prf = Power Reference Oscillator output level  
 V<sub>comp</sub> = previously recorded value  
 V<sub>1</sub> = previously recorded value  
 V<sub>0</sub> = previously recorded value  
 R = previously recorded value

Calibration Factor = value for thermistor mount at 50 MHz (traceable to the National Institute of Standards and Technology).

Note: See step 19 for an example of how Prf is calculated, using the above formula.

17. Verify that the Prf is within the following limits:

Min	Actual	Max
0.988 mW	_____	1.012 mW

18. Enter the results on the Performance Test Record.  
 19. The following is an example showing how calculations of the Power Reference Output level are performed:

R = 200Ω  
 V<sub>0</sub> = 170 μV or 170 × 10<sup>-6</sup> V  
 V<sub>1</sub> = 78,107 μV or 78,107 × 10<sup>-6</sup> or .078V  
 V<sub>comp</sub> = 5.1583V  
 Cal Factor = 99.68%

$$Prf = \frac{2V_{comp} (V_1 - V_0) + V_0^2 - V_1^2}{4R(\text{CalibrationFactor})}$$

Note: V<sub>0</sub> is eventually dropped out of the equation in the following steps because its value is very small (basically zero).

$$\begin{aligned} Prf &= \frac{2(5.1583) (0.78 - 0)^2 + (.000170)^2 - (0.78)^2}{4(200) (99.68\%)} \\ &= \frac{.80469 - .00608}{797.44} = \frac{.79861}{797.44} \\ &= 1.00147 \text{ mW} \end{aligned}$$

HP 5347A/48A PERFORMANCE TEST RECORD (Page 1 of 2)

**HEWLETT-PACKARD MODEL 5347A/48A**  
**Microwave Frequency Counter/Power Meter**

Repair/Work Order No. \_\_\_\_\_

Serial Number: \_\_\_\_\_ Temperature: \_\_\_\_\_

Test Performed By: \_\_\_\_\_ Relative Humidity: \_\_\_\_\_

Date: \_\_\_\_\_ Post Calibration Test:

Notes: \_\_\_\_\_ Pre Calibration Test:

PARA. NO.	TEST	CORRECT DISPLAY	RESULTS		
			MINIMUM	ACTUAL	MAXIMUM
4-18	INPUT 2, 10 MHz-25 MHz Input Sensitivity (50Ω) (Part I): Input conditions:				
	25 mV rms (-19.3 dBm) 50 MHz	50 000 000	49 999 999	_____	50 000 0001
	100 MHz	1000 000 000	99 999 999	_____	100 000 001
	200 MHz	200 000 000	199 999 999	_____	200 000 001
	400 MHz	400 000 000	399 999 999	_____	400 000 001
	525 MHz	525 000 000	524 999 999	_____	525 000 001
	80 MHz	80 000 000	79 999 999	_____	80 000 001
	INPUT 2, 10 Hz - 80 MHz Input Sensitivity (1MΩ) (Part II)				
	Input conditions: 10 Hz	10	9	_____	11
	25 mV rms (-19.3 dBm) 1 kHz	1000	999	_____	1001
	500 kHz	500 000	499 999	_____	501 001
	1 MHz	1 000 000	999 999	_____	1 000 001
	10 MHz	10 000 000	9 999 999	_____	10 000 001
	4-19.	INPUT 1, 500 MHz Input Sensitivity (Part I): Input conditions			
-32 dBm 500 MHz		500 000 000	599 999 996	_____	500 000 004
-29 dBm (Opt. 006) 1 GHz		1 000 000 000	999 999 996	_____	1 000 000 004
INPUT 1, 2.5 GHz - 20 GHz [26.5 GHz for HP 5348A] (Part II)					
Input conditions: 2.5 GHz		2 500 000 000	2 499 999 996	_____	2 500 000 004
-32 dBm 5 GHz		5 000 000 000	4 999 999 996	_____	5 000 000 004
-29 dBm (Opt. 006) 10 GHz		10 000 000 000	9 999 999 996	_____	10 000 000 004
12.4 GHz		12 400 000 000	12 399 999 996	_____	12 400 000 004
Input conditions					
-27 dBm 18 GHz		18 000 000 000	17 999 999 996	_____	18 000 000 004
-23 dBm (Opt. 006) 19 GHz		19 000 000 000	18 999 999 996	_____	19 000 000 004
20 GHz		20 000 000 000	19 999 999 996	_____	20 000 000 004
Input conditions: (HP 5348A only): 22 GHz		22 000 000 000	21 999 999 996	_____	22 000 000 004
-20 dBm 26.5 GHz		26 500 000 000	26 499 999 996	_____	26 500 500 04
-15 dBm (Opt. 006)					

HP 5347A/48A PERFORMANCE TEST RECORD (Page 2 of 2)

PARA. NO.	TEST	CORRECT DISPLAY	RESULTS		
			MINIMUM	ACTUAL	MAXIMUM
4-20.	Automatic Amplitude Discrimination Test: Input conditions: 18 GHz, -5 dBm 2.5 GHz, -5 dBm  17.5 GHz separation 500 MHz separation	20 dBm 6 dBm	_____	_____	20 dBm (typical)
			_____	_____	6 dBm (typical)
4-21.	FM Rate Tolerance  Normal Rate (1 kHz) Track Rate (300 kHz)	1000 300 000	_____	_____	
			_____	_____	
4-23.	Power Meter Accuracy Test  Watt Mode  3 μW 10 μW 30 μW 100 μW 300 μW 1 mW 3 mW 10 mW 30 mW 100 mW  dBm Mode  20 dBm -10 dBm		MINIMUM	ACTUAL	MAXIMUM
			3.10 μW	_____	3.23 μW
			9.90 μW	_____	10.10 μW
			31.4 μW	_____	31.8 μW
			99.5 μW	_____	100.5 μW
			.314 mW	_____	.318 mW
			0.995 mW	_____	1.005 mW
			3.14 mW	_____	3.18 mW
			9.95 mW	_____	10.05 mW
			31.4 mW	_____	31.8 mW
			99.5 mW	_____	100.5 mW
			19.98 dBm	_____	20.02 dBm
			-9.98 dBm	_____	-10.02 dBm
4.24.	Power Meter Reference Test (Prf)	1 mW	0.988 mW		1.012 mW

#### 4-25. HP-IB VERIFICATION (FOR OPTION 011)

The HP-IB Verification program listed in *Table 4-5* exercises the HP 5347A/48A through various operating modes via the HP 5347A/48A's HP-IB Interface. If the HP 5347A/48A successfully completes all phases of the verification program, there is a high probability that the A11 HP-IB Interface Assembly is operating correctly. This program is not intended to be an automated test system for operational verification of the entire instrument, but rather an aid to verify that the HP-IB Interface is handshaking properly, sending valid data to the controller, and controlling the HP 5347A/48A properly. If the HP 5347A/48A does not respond as described, refer to A11 HP-IB Interface Assembly troubleshooting in Section 8 of the Service Manual.

To perform the verification, set up the HP 5347A/48A and signal source as in *Figure 4-13*. The program will function with any valid HP-IB address set for the HP 5347A/48A.

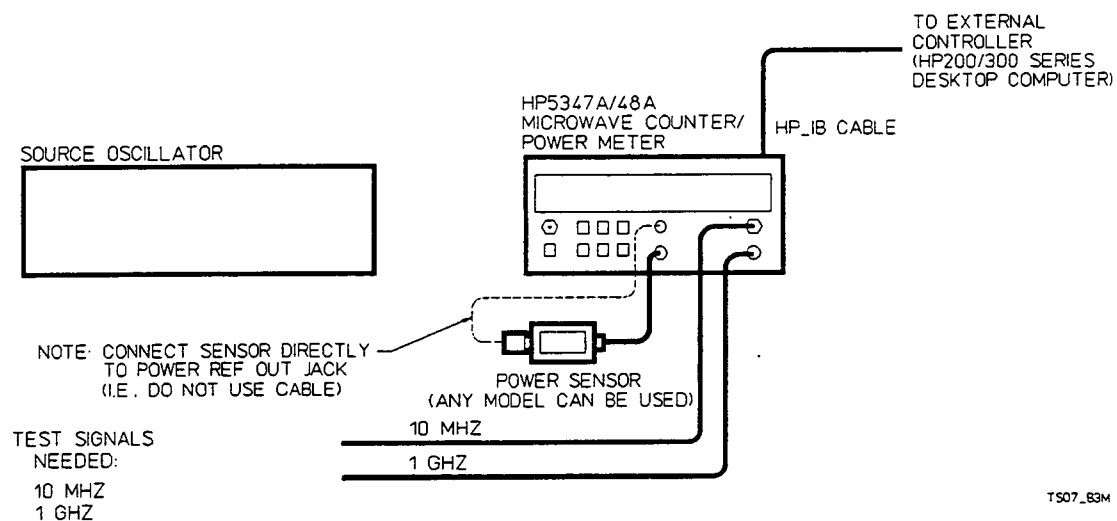

*Figure 4-13. HP-IB Verification Test Setup*

The HP-IB Verification Test program may be loaded into the HP 9000 series 200 or 300 Desktop Computer from the HP-IB Verification disc (HP P/N 05348-13502 for 5-¼ inch disc or HP P/N 05348-13501 for 3-½ inch disc). To run the program on the disc, insert the disc into the Desktop Computer, load the program via Load "HP 5348A", and press RUN key.

The program goes through 20 checkpoints, including a test to verify remote response at all legal addresses. At the conclusion

of each checkpoint, the operator is requested to enter the results of the current checkpoint. These results are stored and can be printed upon completion of the program. *Table 4-4* is a sample printout of the results of the HP-IB Verification program. The printed listing of results should be attached to the HP-IB Verification Record, *Table 4-3*.

Various checkpoints throughout the program ask the operator to verify that the HP 5347A/48A Gate annunciator is ON, as well as other annunciators. Note that if a signal is present at the appropriate input, the Gate annunciator should be flashing at a rate proportional to the sample rate.

<b>HEWLETT-PACKARD MODEL 5347A/48A</b>		Tested by _____	
<b>Microwave Frequency Counter/Power Meter</b>		Date: _____	
Serial Number:			
4-25.	HP-IB Verification	PASS _____	FAIL _____

*Table 4-4. Example HP-IB Verification Program Listing*

```

                    5347/5348A HP-IB CHECKPOINT SUMMARY
1  'REMOTE', 'LOCAL'          ** 11 'AUTO and 'MANUAL'
2  Self Check ('TEST')        ** 12 "SRQMASK"
3  'DISPLAY'                  ** 13 'DUMP'
4  'INIT', 'RESET' and 'CLEAR' ** 14 'WATTS', 'DBM', 'MOD?'
5  'REF' and 'REF?'          ** 15 'ZERO'
6  'ERR?'                     ** 16 'CALIBRATE'
7  'SET' and 'SET?'          ** 17 'REF OSC ON/OFF', 'OSC?'
8  'LOWZ' and 'HIGHZ'        ** 18 'AUTO', 'MANUAL', 'RNG?'
9  'SAMPLE' and 'TRIGGER'     ** 19 'TRIGGER', 'PTRG?'
10 'RESOL 0' & 'RESOL 4'     ** 20 'CHECK ALL ADDRESSES'

'ID? is also checked during HP-IB address search at program startup.
*****
                    CHECKPOINT RESULTS
*****
Instrument:  HP ,5348A at address 703
1  PASS          11  NOT PERFORMED
2  PASS          12  NOT PERFORMED
3  PASS          13  NOT PERFORMED
4  PASS          14  NOT PERFORMED
5  PASS          15  PASS
6  NOT PERFORMED 16  PASS
7  PASS          17  PASS
8  NOT PERFORMED 18  NOT PERFORMED
9  NOT PERFORMED 19  NOT PERFORMED
10 NOT PERFORMED 20  NOT PERFORMED
    
```



# INSTALLATION

---

## A-1. INTRODUCTION

This appendix provides the following information:

- Unpacking and Inspection, A-2.
- Preparation for Use, A-3.
- Operator's Maintenance, A-10.
- Battery Care, Usage, and Disposal (for Option 002), A-13.
- Field Installation of Options, A-18.
- Hewlett-Packard Interface Bus (HP-IB), A-22.
- Storage and Shipment, A-26.

## A-2. UNPACKING AND INSPECTION

### **WARNING**

---

**TO AVOID HAZARDOUS ELECTRIC SHOCK, DO NOT PERFORM ELECTRICAL TESTS WHEN THERE ARE SIGNS OF SHIPPING DAMAGE TO ANY PORTION OF THE OUTER ENCLOSURE (COVERS, PANELS, CONNECTORS, ETC.).**

---

Inspect the shipping container and cushioning material for damage. If damage is evident, keep the packing materials until the contents of the shipment have been checked for completeness and the instrument has been checked mechanically and electrically. Procedures for checking electrical performance are given in Section IV, Performance Tests. If the contents are incomplete, if there is mechanical damage or defect, or if the instrument or some component fails the performance tests, notify the nearest Hewlett-Packard Sales and Service office. If the shipping container is damaged,

or the cushioning material shows signs of stress, notify the carrier as well as the Hewlett-Packard office. Keep the shipping materials for the carrier's inspection. The HP office will arrange for repair or replacement at HP's option without waiting for a claim settlement.

### **A-3. PREPARATION FOR USE**

PREPARATION FOR USE contains the following important information:

- Bench and Rack Operation
- AC Power Requirements
- AC Line Voltage and Fuse Selection
- Power Cable
- External DC Power Requirements
- Option 002 Battery Pack Power Requirements

### **A-4. Bench and Rack Operation**

The HP 5347A / 48A has plastic feet and folding tilt stands for convenience in bench operation.

An optional rack mount (Option 913) is available with the HP 5347A / 48A that will allow operation of the instrument in a standard rack. Refer to Section A-21 for detailed field installation procedures.

### **A-5. AC Power Requirements**

The HP 5347A / 48A can operate from the following ac power sources:

- 100 Vac  $\pm$  10% at 45-66 Hz
- 120 Vac  $\pm$  10%-14% at 45-66, 360-440 Hz
- 220 Vac  $\pm$  10% at 45-66 Hz
- 240 Vac  $\pm$  10% at 45-66 Hz

Maximum power consumption is 50 volt-amperes.

---

**WARNING**

THIS IS A SAFETY CLASS I PRODUCT PROVIDED WITH A PROTECTIVE EARTH TERMINAL. AN UNINTERRUPTIBLE SAFETY EARTH GROUND MUST BE PROVIDED FROM THE MAINS POWER SOURCE TO THE PRODUCT INPUT WIRING TERMINALS, POWER CORD, OR SUPPLIED POWER CORD SET. WHENEVER IT IS LIKELY THAT THE PROTECTION HAS BEEN IMPAIRED, THE INSTRUMENT MUST BE MADE INOPERATIVE AND BE SECURED AGAINST ANY UNINTENDED OPERATION.

IF THIS INSTRUMENT IS TO BE ENERGIZED VIA AN EXTERNAL AUTOTRANSFORMER FOR VOLTAGE REDUCTION, MAKE SURE THAT THE COMMON TERMINAL IS CONNECTED TO THE EARTHED POLE OF THE POWER SOURCE. FAILURE TO GROUND THE INSTRUMENT CAN RESULT IN PERSONAL INJURY. REFER TO SECTION A-7. ALSO, REFER TO TABLE A-2 (SAFETY CONSIDERATIONS).

---

A-6.  
AC Line Voltage and  
Fuse Selection

---

**CAUTION**

*BEFORE PLUGGING THIS INSTRUMENT into the Mains (line) voltage, be sure the correct line voltage and fuse have been selected. You must set the turret-wheel selector correctly to adapt the HP 5347A/48A to the power source as described in the following paragraph.*

---

The HP 5347A/48A is equipped with a power module (on the rear panel) that contains a turret wheel to select 100-, 120-, 220-, or 240-volt ac operations as shown in *Figure A-1*. Before applying power to the HP 5347A/48A, the turret-wheel selector must be set to the correct position and the correct fuse must be installed as described in the next paragraph.

Power line connections are selected by the position of the plug-in turret wheel in the module. The turret wheel must be taken out before turning it.

The correct-value fuse, with a 250-volt rating must be installed. This instrument uses a 1.0A time delay fuse (HP Part Number 2110-0007) for 100/120-volt operation and a 0.5A time-delay fuse (HP Part Number 2110-0202) for 220/240-volt operation.

To change the line voltage and install the fuse, first disconnect the power cord from the module and then follow the instructions in *Figure A-1*.

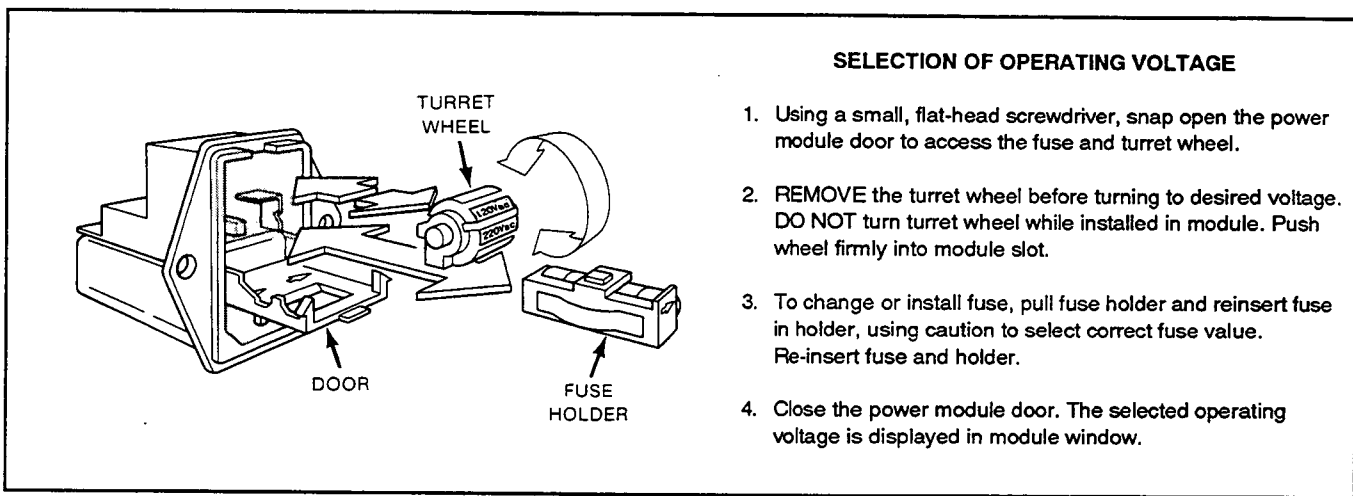

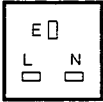

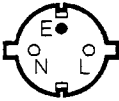



Figure A-1. Line Voltage Selection with Power Module Turret Wheel

### A-7. Power Cord

This instrument is equipped with a three-wire power cord. When connected to an appropriate ac power receptacle, this cord grounds the instrument cabinet. The type of power cord shipped with each instrument depends on the country of destination. Refer to *Table A-1* for the part number of the power cords and mains plugs available.

A 90° connector on the instrument end of the cord is provided to allow the instrument to sit upright on its rear feet without stressing the cord.

Table A-1. AC Power Cords Available

Plug Type	Cable HP Part No.	*C D	Plug Description	Cable Length (Inches)	Cable Color	For Use In Country
<p>250V</p> 	8120-1703	6	**BS1363A/90° connector	90	Mint Gray	United Kingdom, Cyprus, Nigeria, Rhodesia, Singapore
<p>250V</p> 	8120-0696	4	**NZSS198/ASC112/90° connector	87	Gray	Australia, New Zealand
<p>250V</p> 	8120-1692	2	**CEE7-Y11/90° connector	79	Mint Gray	East and West Europe, Egypt, (Unpolarized in many nations)
<p>125V</p> 	8120-1521 8120-4754	6	**NEMA5-15P/90° connector  **NEMA5-15P/90° connector	80 90	Jade Gray Dark Gray	United States, Canada, 100V or 200V, Mexico, Philippines, Taiwan, Saudi Arabia, Japan
<p>250V</p> 	8120-2296	3	**SEV1011/90° connector 1959-24507 Type 12	79	Gray	Switzerland
<p>220V</p> 	8120-2957	3	**DHCK 107/90° connector	79	Gray	Denmark
<p>220V</p> 	8120-4600		90° connector		Gray	South Africa, India

\*CD = Check Digit (refer to Replaceable Parts in Service Manual).







\*\*Part number shown for plug is industry identifier for plug only. Number shown for cable is HP Part Number for complete cable including plug.

E = Earth Ground    L = Line    N = Neutral

Table A-2. Safety Considerations

<b>GENERAL</b>	This product and related documentation must be reviewed for familiarization with safety markings and instructions before operation.  This product is a Safety Class I instrument (provided with a protective earth terminal).
<b>BEFORE APPLYING POWER</b>	Verify that the product is set to match the available line voltage and the correct fuse is installed. Refer to instructions in this appendix.
<b>SAFETY EARTH GROUND</b>	An uninterruptible safety earth ground must be provided from the mains power source to the product input wiring terminals or supplied power cable.

### Safety Symbols

	Instruction manual symbol; the product will be marked with this symbol when it is necessary for the user to refer to the instruction manual.
	Indicates hazardous voltages.
	Indicates earth (ground) terminal.
	Indicates terminal is connected to chassis when such connection is not apparent.
	Alternating current.
	Direct current.

### WARNING

**THIS DENOTES A HAZARD. IT CALLS ATTENTION TO A PROCEDURE, PRACTICE, OR THE LIKE, WHICH, IF NOT CORRECTLY PERFORMED OR ADHERED TO, COULD RESULT IN PERSONAL INJURY. DO NOT PROCEED BEYOND A WARNING SIGN UNTIL THE INDICATED CONDITIONS ARE FULLY UNDERSTOOD AND MET.**

### CAUTION

**This denotes a hazard. It calls attention to an operating procedure, practice, or the like, which, if not correctly performed or adhered to, could result in damage to or destruction of part or all of the product. Do not proceed beyond a CAUTION sign until the indicated conditions are fully understood and met.**

### Safety Information

#### WARNING

Any interruption of the protective grounding conductor (inside or outside the instrument) or disconnecting the protective earth terminal will cause a potential shock hazard that could result in personal injury. (Grounding one conductor of a two conductor outlet is not sufficient protection.)

Whenever it is likely that the protection has been impaired, the instrument must be made inoperative and be secured against any unintended operation.

If this instrument is to be energized via an autotransformer (for voltage reduction) make sure the common terminal is connected to the earthed pole terminal (neutral) of the power source.

Instructions for adjustments while covers are removed and for servicing are for use by service-trained personnel only. To avoid dangerous electric shock, do not perform such adjustments or servicing unless qualified to do so.

For continued protection against fire, replace the line fuse(s) only with 250V fuse(s) of the same current rating and type (for example, normal blow, time delay). Do not use repaired fuses or short circuited fuseholders.

When measuring power line signals, be extremely careful and always use a step-down isolation transformer whose output voltage is compatible with the input measurement capabilities of this product. This product's front and rear panels are typically at earth ground, so **NEVER TRY TO MEASURE AC POWER LINE SIGNALS WITHOUT AN ISOLATION TRANSFORMER.**

## A-8. External DC Power Requirements

To operate the instrument from an external dc supply, the supply must be able to output a dc voltage within the range of +14 to +26V at a maximum of 3.0A. If the applied dc input voltage level exceeds +26V, the 5A External DC fuse opens. Unless the external supply is current limited, the instrument may be damaged (see notes below). Refer to Section A-12 for fuse replacement instructions.

### CAUTION

---

***If the external supply that you are using has a short-circuit current capability of less than 10A, HP recommends that it have foldback current-limiting that can be activated at 4A.***

***If the external supply voltage is too high, but can only supply 6 to 10A, the overvoltage crowbar may be inhibited; therefore, the fuse may not open, potentially causing damage to the instrument.***

---

Use wires which are at least 18 AWG to connect the external power supply (DC source) to the EXT. DC INPUT binding posts. Read the following procedure thoroughly before performing the steps.

To connect the power supply to the EXT. DC INPUT binding posts, perform the following:

### CAUTION

---

***When using the EXT. DC INPUT, always use a fused power supply and 18 AWG (minimum) connecting wires. Be sure that the binding post thumb nuts are tight over the wire connections. Do not use the standard exposed banana plugs. Some dc supplies, such as automotive batteries, are capable of high current, and can be a fire hazard if the terminal wires or the exposed plugs become loose, and short to each other or to a conductive surface.***

***The maximum wire size that can fit through the hole in the binding posts is 12 AWG.***

---

1. Strip back insulation of each connecting wire no more than 0.5 inches on end of wires that will connect to the **EXT. DC INPUT** binding posts.
2. Insert stripped end of connecting wires into hole of the binding posts, and secure wires by tightening thumb nuts of binding posts.
3. Observing correct polarity, attach other end of wires to the DC source.

---

**NOTE**

*If a reversed voltage is accidentally applied to the **EXT. DC INPUT** jacks, no damage will occur to the instrument.*

---

**A-9.**  
**Option 002 Battery**  
**Pack Power**  
**Requirements**

The Option 002 Battery Pack (HP P/N 05348-60206) is made of 12 nickel-cadmium (NiCad) D cells in series (nominally 14.4V). The battery pack must provide a dc input between +12.1 to 14.4 Vdc to properly operate the instrument. In typical operation it can provide enough power for 1 to 2 hours, typical, of continuous operation. The pack is automatically charged by the instrument's internal charging circuitry when the instrument is plugged into the ac line, and **POWER KEY** is in Standby mode. Refer to Section A-19 for detailed information on installing and/or replacing the battery pack. Refer to Section A-13 for information on battery care, usage, and disposal.

**A-10.**  
**OPERATOR'S**  
**MAINTENANCE**

The only operator's maintenance is replacement of the following fuses:

- AC Power Input Module fuse, located on rear panel.
- Low Frequency Input fuse, located in the front panel **INPUT 2** connector.
- Ext. DC Input fuse, located on rear panel.

For instructions on how to change the fuses, refer to Sections A - 6 , A11, A-12, respectively. Also, fuse part numbers and values are listed in these sections.



**CAUTION**

**For continued protection from fire hazards, be sure that only correct type fuses with the required current and voltage ratings are used for replacement. Do not use repaired fuses or short-circuited fuse holders.**

**A-11.  
Replacing INPUT 2  
Fuse**

The Low Frequency Input fuse J2F1 is a 1/8A fuse (HP Part Number 2110-0301) located within the INPUT 2 BNC connector J2 (HP Part Number 1250-1899) as shown in *Figure A-2*. To replace the fuse, perform the following:

1. Unscrew BNC barrel, and with needle-nose pliers, remove and replace fuse.
2. Reinstall BNC barrel, and tighten using a 7/16 inch wrench. Tighten to 20 inch-pounds.

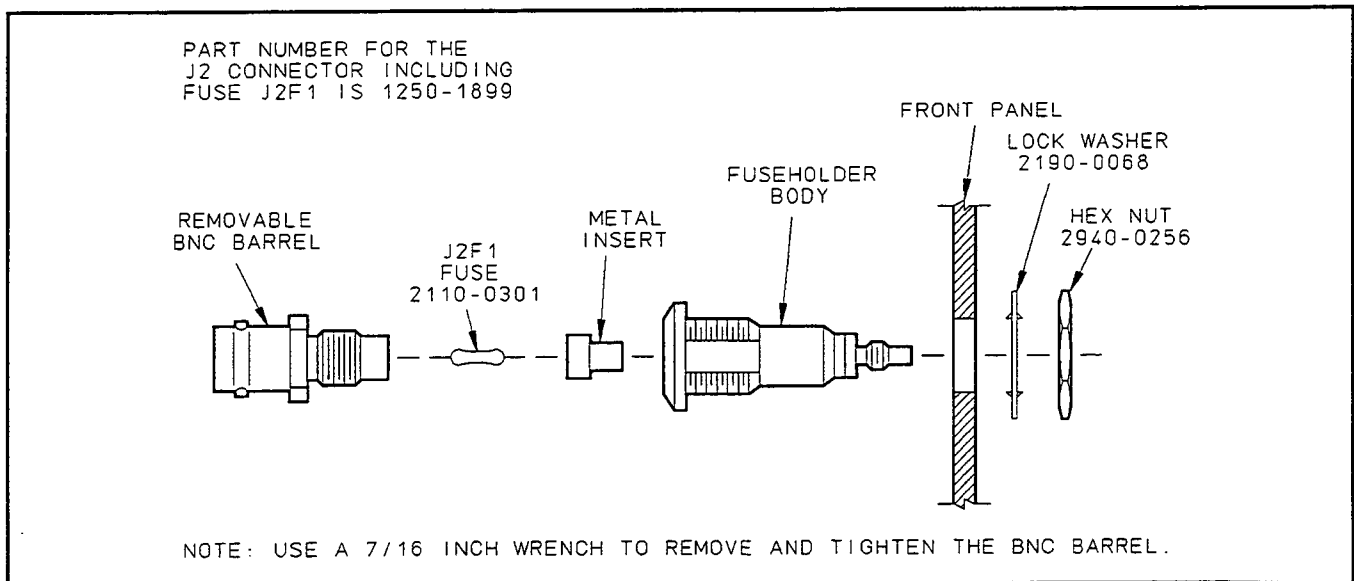

*Figure A-2. Details of INPUT 2 BNC Connector J2 and Fuse J2F1 Mounting*

**A-12.**  
**Replacing External  
DC Input Fuse**

**CAUTION**

---

*For continued protection from fire, replace only with fuse of same type and rating as described in step 3 of the following procedure.*

---

1. Make sure all power is removed from HP 5347A/48A.
2. Insert a medium, flat-blade screwdriver in slot of the DC FUSE cap located on rear panel adjacent to the EXT. DC INPUT jacks. Turn screwdriver counterclockwise to remove cap and fuse.
3. Using caution to select the correct fuse (5A, 250-volt rating; HP P/N 2110-0010) insert replacement fuse in fuseholder.
4. Using the flat-blade screwdriver, press the DC FUSE cap into fuseholder and turn clockwise.

**A-13.**  
**BATTERY CARE,  
USAGE, AND  
DISPOSAL (FOR  
OPTION 002)**

The Option 002 Battery Pack (HP P/N 05348-60206) is designed specifically for use with the HP 5347A/5348A. The battery's operating time and life can be optimized by understanding and following some guidelines for nickel-cadmium (NiCad) battery use.

**A-14.**  
**Battery Shelf Life and  
Storage**

When not being used, the batteries (installed or not installed) have a self-discharge rate of approximately 1 percent of available charge per day. (The batteries discharge more quickly at higher ambient temperatures.) After approximately 90 days a battery pack might not operate the instrument. If your instrument does not turn on, fully charge the battery pack. Refer to Section A-16 for charging instructions.

A non-operating battery pack can be stored in ambient temperatures ranging from -40° C to 70°. However, to ensure the maximum life capability of the battery, avoid long exposure to extremes of the storage temperature range. The recommended storage range is 0° C to 30° C.

**A-15.  
Battery Operating  
Temperatures**

The battery pack is designed for use within the temperature range of 0° C to 55° C. The battery will operate (charge/discharge) over this entire temperature range. However, temperature extremes can temporarily limit the battery's operating time capacity, and over extended periods, can also degrade the battery's life. Therefore, when the battery is installed, protect it from ambient temperatures below 0° C and above 55° C.

**WARNING**

---

**DO NOT OPERATE OR CHARGE THE BATTERY  
WHEN AMBIENT TEMPERATURE IS BELOW 0° C  
OR ABOVE 55° C.**

---

For optimum battery usage, "room temperature" of 20° C to 25° C will extend the capacity and life of the battery. In this typical operating environment (20° to 25°), the battery should last for several years or 500 to 800 charge/discharge cycles. In addition, a fully charged battery will operate the instrument for 1 to 2 hours, typical. In contrast, a worst case scenario of charging in very high temperatures and discharging in very low temperatures could degrade battery operating time.

The battery pack's **optimum temperature range** varies depending on the type of useage or operation. These temperature ranges are as follows:

**Non-operating storage:** 0° C to 30° C

**Charging:** 0° C to 25° C

**Operation (discharge):** 20° C to 40° C

If the battery is operated outside these limits, its operating time capacity will degrade, at least temporarily.

## NOTES

---

**For the longest useful life, it is best to let the battery fully charge and discharge periodically. Leaving the battery charging for extended periods may lead to slight degradation of overall battery life.**

**While the battery pack is charging, it is normal for the the battery to be warm to the touch.**

---

If the battery pack does not last as long as you expect, cycle it through a full charge/discharge cycle two to four times; that is, charge it overnight, and let the HP 5347A/48A operate from the battery until the unit shuts off. If doing this several times does not restore battery life, the battery pack may be damaged, or beyond its useful life.

### **A-16. Battery Charging**

The rechargeable NiCad batteries in the HP 5347A/48A battery pack are charged **only** when the instrument is powered OFF (Standby). Normal charging times between the fully discharged state and fully charged state is 12 to 16 hours. Shorter charging periods will reduce the operating time you can expect from a single battery charge.

To charge a battery pack, perform the following steps:

1. Make sure battery pack is properly installed in battery compartment. If it is not, perform procedure in Section A-19.
2. Connect ac line power to instrument.
3. Turn off instrument (front panel **POWER** key in Standby mode); this starts the charging.
4. To fully charge battery pack, keep instrument connected to the ac line with **POWER** key in Standby mode for about 16 hours. (The battery does not charge when the instrument is turned ON.)

---

**NOTE**

*The HP 5347A/48A is designed to prevent overcharging of the battery pack.*

---

**WARNING**

**DO NOT ATTEMPT TO DISASSEMBLE, INCINERATE, OR MUTILATE THE BATTERY PACK; THE PACK MAY BURST OR RELEASE TOXIC MATERIALS.**

**DO NOT CONNECT TOGETHER OR OTHERWISE SHORT-CIRCUIT THE BATTERY TERMINALS; THE PACK MAY MELT OR CAUSE SERIOUS BURNS.**

---

Details on the HP 5347A / 48A battery-operating features are described in Section 3.

**A-17.  
Battery Disposal**

The spent NiCad battery pack is considered hazardous waste in some countries. **Dispose only in accordance with local environmental regulations. Contact your nearest regional office of environment health service for guidance.**

**A-18.  
FIELD  
INSTALLATION OF  
OPTIONS**

The HP 5347A / 48A has three field-installable options:

- Option 002 Battery Pack
- Option 011 HP-IB Interface Assembly
- Option 913 Rack Mount Kit

The installation procedures for these options are provided in the following paragraphs.

**A-19.  
Installing/Replacing  
Option 002 Battery  
Pack**

If it becomes necessary to replace the battery pack, use only another Hewlett-Packard Option 002 Battery Pack (HP Part Number 05348-60206). **The battery pack is supplied in a fully discharged state and must always be charged upon initial installation.** Refer to Section A-16 for battery charging instructions. Refer to Section A-17 for battery disposal information.

When you are operating the instrument from battery power and the battery output gets low, the front panel **Batt** annunciator will start flashing ON and OFF to warn you that you have 10 to 15 minutes of operating time left.

To continue operation, either connect the ac line or the appropriate dc voltage to the instrument, or substitute another fully charged battery pack for the one in the instrument.

Installation of the battery pack is described in the following procedure.

**CAUTION**

---

***Use of any batteries other than the Hewlett-Packard Option 002 Battery Pack (HP P/N 05348-60206) may result in damage to your instrument.***

---

To install or replace the NiCad battery pack use the following procedures:

1. Turn off HP 5347A / 48A, and remove all power connections.
2. Loosen two screws that hold the rear panel battery compartment door in place, and remove door. The screws are retained in the door. To remove the existing battery, if one is installed, tip front of instrument up slightly. Battery will slide out.
3. The battery pack removed from the instrument should be protected against short circuits by using the supplied battery cap or other protective device. Retain the protective device with rubber band or tape if necessary.
4. The new battery pack is supplied in a shipping carton and should have a plastic cap over the terminal end. **BEFORE** installation, remove this cap and save it for subsequent re-use when the battery is removed from the instrument.

5. Note that the back wall of the battery compartment has a connector strip mounted to it. There are two contacts on the right side of the connector that must make contact with the two exposed terminals on the battery pack. **Insert the battery pack in such a way that the battery terminals meet the contacts.** The pack is correctly installed if the label on the pack is visible from the top as the pack is inserted.

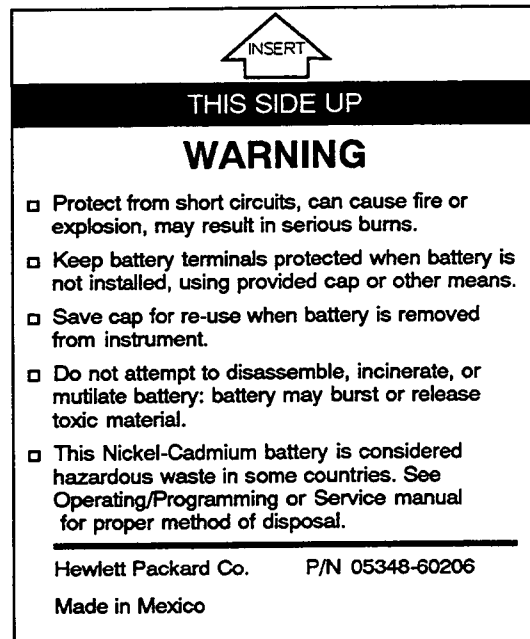

6. Reinstall battery compartment door, and tighten holding screws.
7. Perform the battery charging procedure in Section A-16.

**A-20.**  
**Installing Option 011**  
**HP-IB Interface**  
**Assembly**

**WARNING**

---

**WHEN THE COVER IS REMOVED FROM THE HP 5347A/48A, LINE VOLTAGES ARE EXPOSED WHICH ARE DANGEROUS AND MAY CAUSE SERIOUS INJURY IF TOUCHED. DISCONNECT POWER.**

---

1. Turn off HP 5347A /48A, and remove all power connections.

2. If the Option 002 Battery Pack is present, temporarily remove the pack by performing the following:
  - a. Loosen two screws that hold the rear panel battery compartment door in place, and remove door. The screws are retained in the door.
  - b. Tip front of instrument up to slide out battery pack.
  - c. Retain plastic cap.
3. Remove the instrument cover by performing the following:
  - a. Be sure any cables or adapters are removed from front panel.
  - b. Stand HP 5347A / 48A on its front handles, and loosen recessed Pozidriv screw located in center of each rear foot. The screws are retained in the feet.
  - c. Slide the cover off chassis from the rear. You may have to gently tap, with your hands, the sides of the cover to enable the cover to slide off the chassis.
4. Remove HP-IB connector cover plate. Save the two black standoff studs and lock washers.
5. With Option 011 HP-IB Assembly component-side facing upwards, insert assembly so that its HP-IB connector is placed through rear panel HP-IB opening.
6. Using the two black standoff studs and lock washers, attach interface assembly to rear panel. The screws should be inserted from the outside of the rear panel. Tighten screws, using a 7mm wrench or socket.
7. Insert the other screw through the HP-IB board and into the standoff on the motherboard. Tighten screw.
8. Now, insert interface assembly's cable into connector J5, located on Motherboard.
9. Reinstall battery pack and compartment door if you removed them in step 2.



10. Reinstall cover.
11. To verify proper installation, power up the HP 5347A/48A. The display should indicate "XX HP-IB" for five seconds (where XX is the current address number).
12. Refer to Section 4 for HP-IB Verification Test, and Appendix C for HP-IB Programming information.

### **A-21. Installing Option 913 Rack Mount**

The Option 913 Rack Mount Kit consists of four major parts as listed below:

- Shelf
- Slides
- Filler Panel
- Strap

To install Option 913, perform the following:

1. Install rack mount slides onto the rack.
2. Secure rack mount shelf to the slides, using the screws supplied.
3. Remove the two front feet on the HP 5347A/48A by lifting the tab on each foot and sliding the foot off the cover.
4. Place HP 5347A/48A into rack mount shelf, making sure the rear feet and the two front-frame protrusions (i.e., area where the front feet were formerly located) of the instrument are inserted in the appropriate slots in the shelf.
5. Secure HP 5347A/48A to the shelf by inserting the rack mount strap through the slots in shelf. Wrap the strap around instrument, and buckle securely.
6. Slide shelf back into rack and insert the four 10-32 × .5 sheet metal nuts into the rack rails.
7. Position filler panel over front of instrument, and attach to rack rails with the filler panel screws.

**A-22.**  
**HEWLETT-PACKARD**  
**INTERFACE BUS**  
**(HP-IB)**

**A-23.**  
**HP-IB**  
**Interconnections**

HEWLETT-PACKARD INTERFACE BUS. Interconnection data concerning the rear panel HP-IB connector is provided in *Figure A3*. This connector is compatible with the HP 10833A/B/C/D HP-IB cables. The HP-IB system allows interconnection of up to 15 (including the controller) HP-IB compatible instruments. The HP-IB cables have identical "piggy-back" connectors on both ends so that several cables can be connected to a single source without special adapters or switch boxes. System components and devices may be connected in virtually any configuration desired. There must, of course, be a path from the controller to every device operating on the bus. As a practical matter, avoid tacking more than three or four cables on any one connector. If the stack gets too large, the force on the stack produces great leverage which can damage the connector mounting. Be sure each connector is firmly (finger tight) screwed in place to keep it from working loose during use.

**CABLE LENGTH RESTRICTIONS.** To achieve a design performance with the HP-IB, proper voltage levels and timing relationships must be maintained. If the system cable is too long, the lines cannot be driven properly. Therefore, when interconnecting an HP-IB system, it is important to observe the following rules:

- a. The total cable length of the system must be equal to or less than 2 meters (6.6 feet) times the total number of devices connected to the bus.
- b. The total cable length for the system must be less than or equal to 20 meters (65 feet).
- c. The total number of instruments connected to the bus must not exceed 15.

**A-24.**  
**HP-IB Address**  
**Selection**

The HP-IB device address of the HP 5347A/48A is selected from the rear panel HP-IB switch. The address applies to both the talk and listen functions. The selectable addresses are from 0 to 30. Instructions for selecting the address are provided in Appendix C. Section C-2.

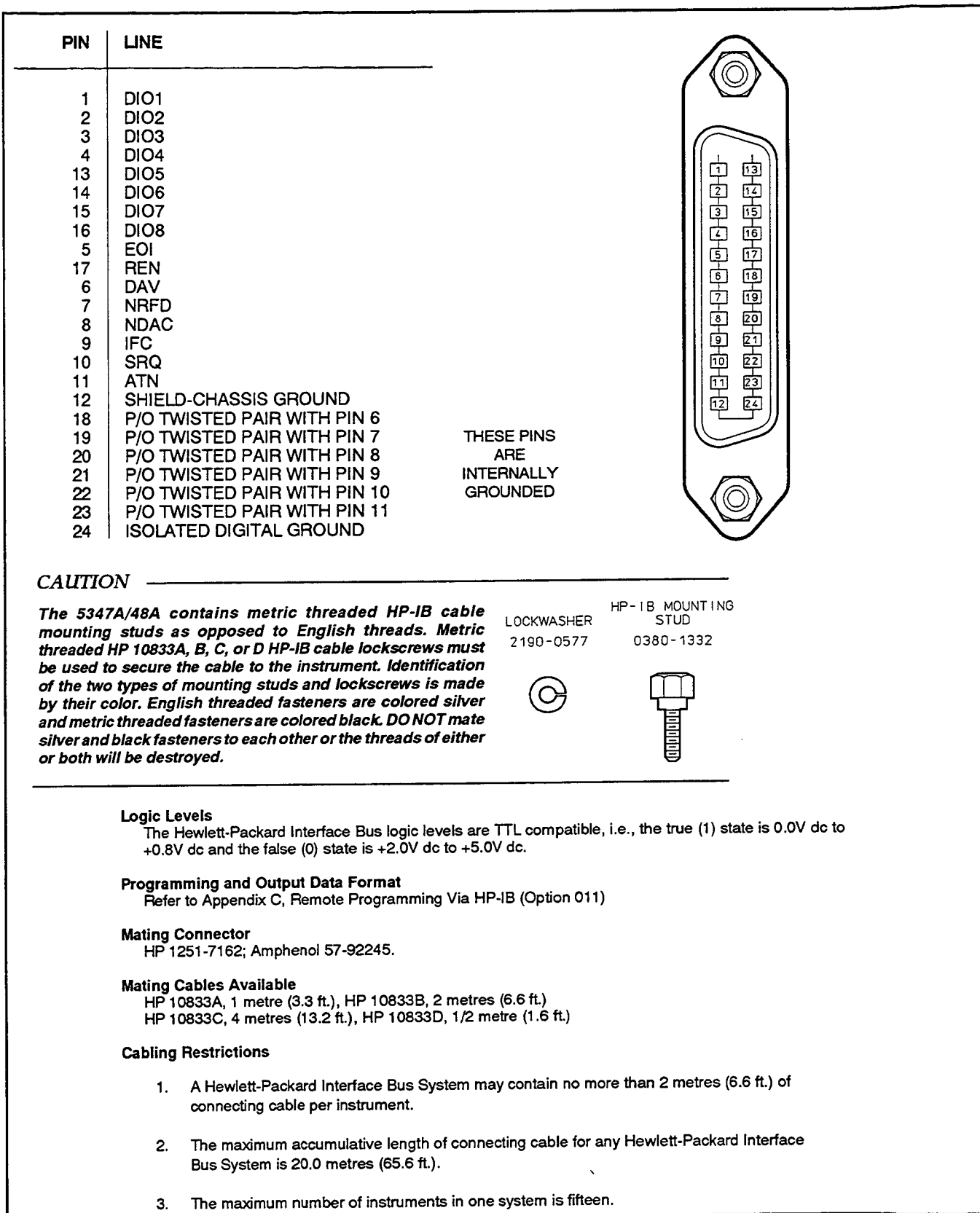

**CAUTION**

*The 5347A/48A contains metric threaded HP-IB cable mounting studs as opposed to English threads. Metric threaded HP 10833A, B, C, or D HP-IB cable lock screws must be used to secure the cable to the instrument. Identification of the two types of mounting studs and lock screws is made by their color. English threaded fasteners are colored silver and metric threaded fasteners are colored black. DO NOT mate silver and black fasteners to each other or the threads of either or both will be destroyed.*

LOCKWASHER  
2190-0577

HP-IB MOUNTING  
STUD  
0380-1332



**Logic Levels**

The Hewlett-Packard Interface Bus logic levels are TTL compatible, i.e., the true (1) state is 0.0V dc to +0.8V dc and the false (0) state is +2.0V dc to +5.0V dc.

**Programming and Output Data Format**

Refer to Appendix C, Remote Programming Via HP-IB (Option 011)

**Mating Connector**

HP 1251-7162; Amphenol 57-92245.

**Mating Cables Available**

HP 10833A, 1 metre (3.3 ft.), HP 10833B, 2 metres (6.6 ft.)  
HP 10833C, 4 metres (13.2 ft.), HP 10833D, 1/2 metre (1.6 ft.)

**Cabling Restrictions**

1. A Hewlett-Packard Interface Bus System may contain no more than 2 metres (6.6 ft.) of connecting cable per instrument.
2. The maximum accumulative length of connecting cable for any Hewlett-Packard Interface Bus System is 20.0 metres (65.6 ft.).
3. The maximum number of instruments in one system is fifteen.

Figure A-3. Hewlett-Packard Interface Bus Connection

The address setting of the rear panel switch is recognized by the HP 5347A/48A if power has been removed and then restored to the instrument, or if the POWER key has been set to Standby and then set to ON again.

**A-25.**  
**HP-IB Descriptions**

A description of the Hewlett-Packard Interface Bus (HP-IB) is provided in the Appendix C. Study of the information in Appendix C is necessary if you are not familiar with HP-IB concepts.

**A-26.**  
**STORAGE AND SHIPMENT**

**A-27.**  
**Environment**

The instrument may be stored or shipped in environments within the following limits:

TEMPERATURE .....-40 to 70° C  
HUMIDITY .....Up to 95% noncondensing  
ALTITUDE .....15,240 metres (50,000 feet)

The instrument must also be protected from temperature extremes which cause condensation within the instrument.

**A-28.**  
**Packaging**

**ORIGINAL PACKAGING.** Container and materials identical to those used in factory packaging are available through Hewlett-Packard for servicing; attach a tag indicating the type of service required, return address, model number, and full serial number. Also, mark the container FRAGILE to ensure careful handling. In any correspondence, refer to the instrument by model number and full serial number.

**OTHER PACKAGING.** The following general instructions should be used for repacking with commercially available materials:

- a. Remove Battery Pack from instrument, and place protective cap on terminal side of battery.
- b. Wrap battery pack in heavy paper or plastic if the battery is going to be shipped with instrument.
- c. Wrap instrument in heavy paper or plastic. If shipping to Hewlett-Packard office or service center,

attach tag indicating type of service required, return address, model number, and full serial number.

- d. Use strong shipping container. A double-wall carton made of 2.4 MPa (350 psi) test material is adequate.
- e. Use a layer of shock-absorbing material 70 to 100 mm (3- to 4-inch) thick around all sides of the instrument to provide firm cushioning and prevent movement inside container. Protect control panel with cardboard.
- f. Seal shipping container securely.
- g. Mark shipping container FRAGILE to ensure careful handling.
- h. In any correspondence, refer to instrument by model number and full serial number.



# SPECIFICATIONS

## B-1 INTRODUCTION

The specifications for the HP 5347A/48A Microwave Counter/Power Meter are shown in *Table B-1*.

*Table B-1. HP 5347A/48A Specifications*

### Counter Specifications

SPECIFICATIONS describe the instrument's warranted performance over the 0° to 55°C temperature range. SUPPLEMENTAL CHARACTERISTICS are intended to provide information useful in applying the instrument by giving typical, but nonwarranted, performance standards.

INPUT 1	HP 5347A	HP 5348A	OPTIONAL INCREASED DAMAGE LEVEL OPTION 006
Frequency Range:	500 MHz – 20.0 GHz	500 MHz – 26.5 GHz	
Sensitivity: 500 MHz – 12.4 GHz 12.4 GHz – 20.0 GHz 20.0 GHz – 26.5 GHz	-32 dBm (-35 dBm typical) -27 dBm (-32 dBm typical) N/A	-32 dBm (-35 dBm typical) -27 dBm (-32 dBm typical) -20 dBm (-27 dBm typical)	Sensitivity is reduced by: 3 dB 4 dB 5 dB
Impedance:	50 Ohms nominal	50 Ohms nominal	
Damage Level:	+25 dBm, peak	+25 dBm peak	500 MHz to 6 GHz +39 dBm (8 Watts) 6 GHz to 18 GHz +36 dBm (4 Watts) 18 GHz to 26.5 GHz +34.8 dBm (3 Watts)
Connector:	N(f)	APC 3.5(m)	
SWR: 500 MHz – 10.0 GHz 10 GHz – 20 GHz 20 GHz – 26.5 GHz	<2:1 typical <3:1 typical N/A	<2:1 typical <3:1 typical <3:1 typical	<2.5:1 typical <3.5:1 typical <3.5:1 typical
Coupling:	ac	ac	
Accuracy: <sup>a</sup>	± 1 LSD rms ± time base error × frequency		
Residual Stability:	When counter and source use common 10 MHz time base or counter uses external higher stability time base, 1 LSD rms typical for 1 Hz resolution at 25°C.		
Resolution:	1 Hz or 10 kHz, selectable		

Note:

a) Accuracy specification applies from 0° to 50°C when using internal time base, 0° to 55°C with external time base.

Table B-1. HP 5347A/48A Specifications (Continued)

**Counter Specifications (Continued):**

INPUT 1	HP 5347A	HP 5348A
Gate Time:	For 1 Hz resolution	
	500 MHz - 5.7 GHz 200 ms 5.7 GHz - 11.3 GHz 400 ms 11.3 GHz - 16.9 GHz 600 ms 16.9 GHz - 22.5 GHz 800 ms >22.5 GHz 1000 ms	
INPUT 2	HP 5347A/5348A	
Frequency Range:	10 Hz - 525 MHz	
Sensitivity:	25 mV rms (15 mV rms typical)	
Impedance:	1 MΩ nominal shunted by <70 pF (10 Hz to 80 MHz) or 50Ω nominal (10 MHz to 525 MHz)	
Maximum Input:	+10 dBm (50Ω input), 1 V rms (1 MΩ input)	
Damage Level:	50Ω or 1 MΩ, dc - 5 kHz: 250V (dc + ac peak); >5 kHz: 5.5V rms (+28 dBm) + 1.25 x 10 <sup>6</sup> V rms/FREQ	
Connector:	BNC (f)	
Coupling:	ac	
Accuracy:	± 1 LSD ± [(1.4 x Trigger Error <sup>b</sup> /Gate Time) ± Time Base Error] x frequency	
Resolution:	1 Hz or 10 kHz, selectable	
Gate Time:	1/Resolution 1 ms minimum	

**Automatic Amplitude Discrimination:**

Automatically measures the largest of all signals present, provided that signal is >6 dB (typical) above any signal within 500 MHz; > 20 dB (typical) above any signal within 500 MHz to 20 GHz (26.5 GHz).

**Maximum Deviation:**

20 MHz p-p, Automatic mode  
60 MHz p-p, Manual mode<sup>c</sup>

**Maximum FM Rate:** 10 MHz

**Tracking Speed:**

Resolution = 1 Hz, Speed = 1 MHz/sec  
Resolution = 10 kHz, Speed = 1 GHz/sec

**AM Tolerance:**

Any modulation index provided the minimum signal level is not less than the sensitivity specification.

**Acquisition Time:**

Resolution = 1 Hz, Time = < 125 ms  
Resolution = 10 kHz, Time = < 60 ms

**Notes:**

b) Trigger Error:

$$\frac{\sqrt{(e_t^2 + e_n^2)}}{\text{Input Slew Rate in V/s at Trigger point}} \text{ s rms}$$

Where e<sub>t</sub> = Effective rms noise of counter's input channel. (100 μV typical)  
e<sub>n</sub> = rms noise of the input signal for a 500 MHz bandwidth.

c) Manual Mode is only accessible via HP-IB.



Table B-1. HP 5347A/48A Specifications (Continued)

**Counter Specifications (Continued):****TCXO Time Base****Crystal Frequency:** 10 MHz**Stability:****Aging Rate:**<  $1 \times 10^{-7}$  per month**Short Term:**<  $1 \times 10^{-9}$  for 1 s averaging time**Temperature:**<  $1 \times 10^{-6}$ , 0 - 50° C, if referenced to +25° C and set to the offset frequency.**Line Variation:**<  $1 \times 10^{-7}$  for 10 % change from nominal**External Time Base:**10 MHz, 0.7 V min. to 8 V max p-p sine wave or square wave into > 1 K $\Omega$  shunted by < 30 pF, via front panel BNC connector.

Table B-1. HP 5347A/48A Specifications (Continued)

**Power Meter Specifications**

**Frequency Range:**  
10 MHz to 26.5 GHz, sensor dependent

**Power Range:**  
-70 to +20 dBm (100 pW to 100 mW),  
sensor dependent

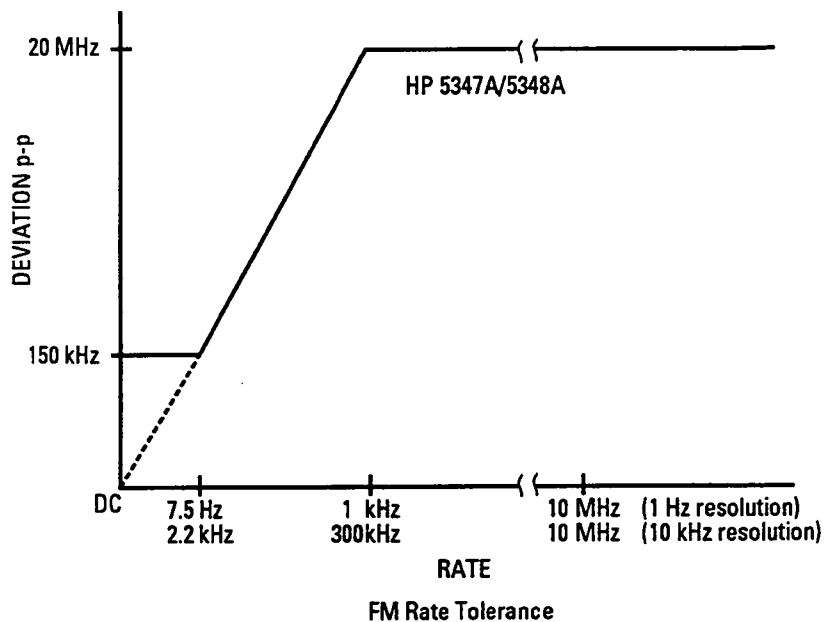
**Power Sensors:**  
HP 8481A, HP 8481D<sup>d</sup>, HP 8484A, HP 8485A

**Dynamic Range:** 50 dB in 10 dB steps

**Display Units:** Watts, dBm

**Resolution:**  
0.01 dB in logarithmic mode,  
0.1% of full scale in linear mode

**Auto Filter:**

The meter automatically selects the required number of averages for the selected range.

Range	5	4	3	2	1
# of Avg	4	4	4	8	128

**Accuracy**

Instrumentation:<sup>e</sup>

±0.02 dB or ±0.5%

Zero Set (digital settability of zero):<sup>f</sup>

±0.5% of full scale on most sensitive range. Decrease percentage by a factor of 10 for each higher range, ±1 display count.

**Power Meter Supplemental Characteristics**

Table 1  
Uncertainties in Power Measurements

Source of Error	Typical Value	Reduce To	Reduce Error by
Mismatch	1.8 %	<±0.1 %	Tuning at each frequency
Calibration Factor Uncertainty	1.5 % - 4.2%		N/A
Power Reference Uncertainty	1.2 %	<0.7 %	Special calibration by standards lab
HP 11708A Calibration Pad (HP 8484A)	1.1 %	<0.5 %	"
Instrumentation Uncertainty *	0.5 %	N/A	N/A
Zero Set	0.2 %	N/A	N/A
Noise	0.2 %	<0.1 %	Average several readings
Power Reference Mismatch Uncertainty	0.2 %	<0.2 %	Tuning

\* Add sensor power linearity error (see sensor specification) on top range only.

**Notes:**

- d) The HP 8481D sensor is a direct replacement for the HP 8484A.
- e) When operating on power measurement Range 4 and 5, add the power linearity percentages found in the Power Sensor Matrix on page 6.
- f) If using the HP 8484A Power Sensor: ±2% of full scale.

Table B-1. HP 5347A/48A Specifications (Continued)

**Power Meter Supplemental Characteristics (Continued):**

**Meter Noise:**

(% of full scale, constant temperature, range 1, measured over one minute interval, two standard deviations).

HP 8481A, HP 8485A Sensors

Range	1	2	3	4	5
Noise (%)	0.3	0.09	0.02	0.002	0.0002

HP 8484A Sensor: multiply noise levels by 4

Range 1 is the lowest power measurement range, range 5 is the highest.

**Zero Drift of sensors:**

(% of full scale, 1 hour, at constant temperature after 24-hour warm-up). Decrease noise by a factor of 10 for each higher range.

HP 8481A, HP 8485A: < 0.1% of full scale on range 1.

HP 8484A: < 2.0% of full scale on range 1.

**Settling Time:**

(0 to 99% settled readings over the bus). 10 dB decreasing power step.

Range	1	2	3-5
Settling Time	< 7.0 s	< 1.0 s	< 250 ms

**Power Reference Specifications**

**Power Output:**

1.00 mW. Factory set to  $\pm 0.7\%$  traceable to U.S. National Institute of Standards.

**Accuracy:**

$\pm 1.2\%$  worst case ( $\pm 0.9\%$  RSS) for one year.

**Power Reference Supplemental Characteristics**

**Frequency:** 50 MHz nominal

**SWR:** 1.05 maximum

**Front Panel Connector:** N (f)

Table B-1. HP 5347A/48A Specifications (Continued)

**Sensor Specifications**

Model	HP 8481A	HP 8484A <sup>g</sup>	HP 8485A
Power Range	1 $\mu$ W to 100 mW -30 dBm to +20 dBm	100 pW to 10 $\mu$ W -70 dBm to -20 dBm	1 $\mu$ W to 100 mW -30 dBm to +20 dBm
Frequency Range	10 MHz - 18 GHz	10 MHz - 18 GHz	50 MHz - 26.5 GHz
Maximum SWR	10 MHz - 30 MHz : 1.40 30 MHz - 50 MHz : 1.18 50 MHz - 2 GHz : 1.10 2 GHz - 12.4 GHz : 1.18 12.4 GHz - 18 GHz : 1.28	10 MHz - 30 MHz : 1.40 30 MHz - 4 GHz : 1.15 4 GHz - 10 GHz : 1.20 10 GHz - 15 GHz : 1.30 15 GHz - 18 GHz : 1.35	50 MHz - 100 MHz : 1.15 100 MHz - 2 GHz : 1.10 2 GHz - 12.4 GHz : 1.15 12.4 GHz - 18 GHz : 1.20 18 GHz - 26.5 GHz : 1.25
Power Linearity <sup>h</sup>	+10 to +20 dBm +2, -4%	-30 dBm to -20 dBm $\pm$ 1%	+10 to +20 dBm +2, -4%
Maximum Power	300 mW avg., 15W peak 30W $\mu$ s per pulse	200 mW average 200 mW peak	300 mW avg., 15W peak 30W $\mu$ s per pulse
Connector	N (m)	N (m)	APC 3.5 (m)

\* The HP 8481D power sensor is a direct replacement for the HP 8484A.

**General**

**Diagnostics:**

Rear panel or HP-IB selectable, service diagnostics and user information.

**Data Output:**

90 meas/sec, counter - varies with frequency (10 kHz resolution, "DUMP MODE")  
18 meas/sec, power meter.

**Overload Indication:**

"OVRLOAD" A user message; External pad or signal attenuation should be used to avoid damage.

**Sleep Mode:**

Counter Input 1 conducted emissions are reduced to < -70 dBm (typical) when sleep mode, input 2, or power meter is selected.

**HP-IB:**

Functions and diagnostics are programmable; Default switches on rear panel; IEEE 488 compatible command structure; Function subset SH1, AH1, T5, L4, SR1, RL1, DC1, DT1, E1.

**Operating Temperature:** 0° C to 55° C

**Power Requirements:** 50 VA maximum

**Line Select:**

100 V (90 - 105 VAC rms; 47.5 - 440 Hz)  
115/120 V (104 - 126 VAC rms; 47.5 - 440 Hz)  
220 V (198 - 231 VAC rms; 47.5 - 66 Hz)  
230/240 V (207 - 252 VAC rms; 47.5 - 66 Hz)

**External DC:**

12 to 26 VDC, 40 W, Binding Post

**Battery (Option 002):**

1 to 2 hours operation (typical),  
12 hours to charge (typical)

**Accessories Supplied:**

Power cord, Operating/Programming manual, power sensor cable (HP 11730)

**Dimensions:**

144 mm H x 325 mm W x 456 mm D  
5.66" H x 12.8" W x 18.0" D

**Weight:**

9.1 kg, 20 lbs  
(10.4 kg, 23 lbs with battery)

**Notes:**

- g) Includes HP 11708A 30 dB attenuator for calibrating against a 0 dBm, 50 MHz power reference. HP 11708A is factor set to 30 dB  $\pm$ 0.5 dB at 50 MHz, traceable to NIS. SWR < 1.05 at 50 MHz.
- h) Negligible deviation except for those power ranges noted.

# REMOTE PROGRAMMING VIA HP-IB (OPTION 011)

---

## C-1. INTRODUCTION

This appendix contains programming information for the optional remote operation of the HP 5347A/48A. The Option 011 HP-IB Interface Assembly enables the remote operation of this instrument. Most of the instrument's front panel functions can be remotely operated via the Hewlett-Packard Interface Bus (HP-IB), as well as additional functions not available from the front panel.

It is assumed that you are familiar with the Hewlett-Packard Interface Bus, the selected controller, the configured interface, and local operation and functional capabilities of the HP 5347A/48A. If you need more information about the HP-IB, refer to one of the following documents:

- ANSI/IEEE Standard 488-1978
- ANSI Standard MC1.1
- *Improving Measurements in Engineering and Manufacturing* (HP Part Number 5952-0058)
- *Tutorial Description of the Hewlett-Packard Interface Bus* (HP Part Number 5952-0156)

This appendix is organized as follows:

- Selecting the HP-IB Address, Section C-2.
- HP 5347A/48A Interface Capabilities, Section C-3.
- Interface Commands, Section C-4.
- Checking Interface and Instrument Status, Section C-8.
- Data Input, Section C-17.
- Data Output, Section C-27.
- Error Handling, Section C-34.
- HP-IB Command Descriptions, Section C-35.
- Programming Examples, Section C-85.

**C-2.  
SELECTING THE  
HP-IB ADDRESS**

To use the HP 5347A/48A in an HP-IB system, you must set the instrument to the desired address, as shown in *Figure C-1* and *Table C-1*. The Addressable mode is used whenever a controller is used with the system and the HP 5347A/48A is functioning as both a talker and a listener. The Talk Only mode is used when the instrument is operating under its own control (no controller on the bus) and sending measurement results to another device on the bus (such as a printer). In the Talk Only mode, the HP 5347A/48A functions as an output-only device, and the receiving device must be set to the Listen Only mode. The Talk Only mode is only available for the Frequency Counter Measurements.

The HP-IB address for the HP 5347A/48A is set manually with the **HP-IB ADDR** switch on the rear panel. The address setting of the rear panel switch is recognized by the HP 5347A/48A if the power has been removed and then restored to the instrument, or if the POWER key has been set to Standby and then set to ON again. *Figure C-1* is an example of how to set the HP-IB switches to Address 14. Refer to *Table C-1* for all possible address settings and the corresponding ASCII codes for Talk and Listen (in the Addressable mode) and in the Talk Only mode.

*Figure C-1.  
Example Setting of  
the HP-IB Address  
Switch*

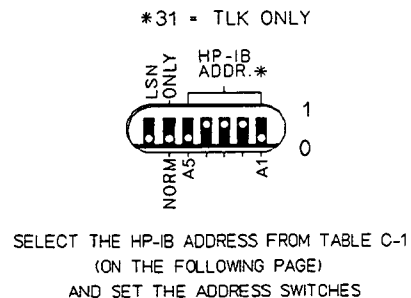

A00C1B3M

Table C-1. Allowable HP-IB Address Selections

SELECTED ADDRESS	ADDRESS SWITCHES					ASCII CHARACTER		ADDRESS USAGE MODE
	A5	A4	A3	A2	A1	LISTEN	TALK	
00	0	0	0	0	0	SP	@	ADDRESSABLE
01	0	0	0	0	1	!	A	ADDRESSABLE
02	0	0	0	1	0	"	B	ADDRESSABLE
03	0	0	0	1	1	#	C	ADDRESSABLE
04	0	0	1	0	0	\$	D	ADDRESSABLE
05	0	0	1	0	1	%	E	ADDRESSABLE
06	0	0	1	1	0	&	F	ADDRESSABLE
07	0	0	1	1	1	'	G	ADDRESSABLE
08	0	1	0	0	0	(	H	ADDRESSABLE
09	0	1	0	0	1	)	I	ADDRESSABLE
10	0	1	0	1	0	*	J	ADDRESSABLE
11	0	1	0	1	1	+	K	ADDRESSABLE
12	0	1	1	0	0	,	L	ADDRESSABLE
13	0	1	1	0	1	-	M	ADDRESSABLE
14	0	1	1	1	0	.	N	ADDRESSABLE
15	0	1	1	1	1	/	O	ADDRESSABLE
16	1	0	0	0	0	0	P	ADDRESSABLE
17	1	0	0	0	1	1	Q	ADDRESSABLE
18	1	0	0	1	0	2	R	ADDRESSABLE
19	1	0	0	1	1	3	S	ADDRESSABLE
20	1	0	1	0	0	4	T	ADDRESSABLE
21	1	0	1	0	1	5	U	ADDRESSABLE
22	1	0	1	1	0	6	V	ADDRESSABLE
23	1	0	1	1	1	7	W	ADDRESSABLE
24	1	1	0	0	0	8	X	ADDRESSABLE
25	1	1	0	0	1	9	Y	ADDRESSABLE
26	1	1	0	1	0	:	Z	ADDRESSABLE
27	1	1	0	1	1	;	[	ADDRESSABLE
28	1	1	1	0	0	<	\	ADDRESSABLE
29	1	1	1	0	1	=	]	ADDRESSABLE
30	1	1	1	1	0	>	~	ADDRESSABLE
31	1	1	1	1	1	N/A	N/A	TALK ONLY*

See →  
Note  
Below

**Note:** Be sure that the instrument address is not set to the same address as the controller. Typical HP controllers use address "21" as a preset address, thus the use of address "21" as the HP 5347A/48A address code should be avoided.

\* This mode is only available for the Frequency Counter measurements.

### C-3. HP 5347A/48A INTERFACE CAPABILITIES

The capabilities of a device connected to the bus are specified by its interface functions. These functions provide the means for a device to receive, process, and send messages or codes over the bus. The HP 5347A/48A HP-IB interface capabilities are listed in Table C-2. The table lists the interface functions defined in the ANSI/IEEE 488-1978 standard by name and specific HP 5347A/48A subset identifier, and contains a brief description of the instrument's capability for each function.

Table C-2. HP 5347A/48A HP-IB Interface Function Capabilities

NAME AND MNEMONIC	GENERAL DESCRIPTION	SUBSET IDENTIFIER*	SPECIFIC HP 5347A/48A CAPABILITIES
Source Handshake (SH)	Capability to properly translate a multiline message.	SH1	The 5347A / 48A can generate messages.
Acceptor Handshake (AH)	Capability to guarantee proper reception of remote multiline messages.	AH1	The 5347A / 48A can interpret received messages.
Talker (T)	Capability to transmit data over the bus when addressed.	T5	The 5347A / 48A can function as a talker. In addition, can operate as a Talk Only instrument and will respond to serial poll. It will unlisten if addressed as a talker.
Extender Talker (TE)	Talker capability with address extension.	TE0	The 5347A / 48A cannot function as an extended talker.
Listener (L)	Capability to receive data over the bus when addressed.	L4	The 5347A / 48A can function as a listener. In addition, it will untalk if addressed as a listener.
Extended Listener (LE)	Listener capability with address extension.	LE0	The 5347A / 48A cannot function as an extended listener.
Service Request (SR)	Capability permitting a device to asynchronously request service from the controller.	SR1	The 5347A / 48A can generate a service request.
Remote / Local (RL)	Capability to select between two sources of input information: local (front panel controls) and remote (input information from the bus).	RL1	The 5347A / 48A can operate both in remote and local modes. In addition, it can respond to local lockout.

\* If you need more information on the Subset Identifiers, refer to ANSI/IEEE Standard 488-1978.



Table C-2. HP 5347A/48A HP-IB Interface Function Capabilities (Continued)

NAME AND MNEMONIC	GENERAL DESCRIPTION	SUBSET IDENTIFIER*	SPECIFIC HP 5347A/48A CAPABILITIES
Parallel Poll (PP)	Provides capability for a device to uniquely identify itself if it requires service and the controller is requesting a response. This capability differs from service request in that it requires a commitment of the controller to periodically conduct a parallel poll.	PP0	The 5347A/48A does not support parallel poll.
Device Clear (DC)	This function allows a device to be initialized to a predefined state.	DC1	The 5347A/48A supports both the Device Clear (DCL) and Selected Device Clear (SDC) commands.
Device Trigger (DT)	This function permits a device to have its basic operation initiated by the talker on the bus.	DT1	The 5347A/48A can be remotely triggered.
Controller (C)	This function permits a device to send addresses, universal commands, and addressed commands to other devices on the HP-IB. It may also include the ability to conduct polling to determine devices requiring service.	C0	The 5347A/48A cannot function as a controller.
Drivers (E)	This code describes type of electrical drivers used in a device.	E1	The 5347A/48A uses open-collector drivers.

\* If you need more information on the Subset Identifiers, refer to ANSI/IEEE Standard 488-1978.

## **C-4. INTERFACE COMMANDS**

The commands recognized by the HP 5347A/48A can be separated into two classes:

- Device independent commands
- Device dependent commands

**Device independent commands** are defined by the interface standard document and are the same for all instruments. Refer to Section C-5 for more information on the device independent commands.

**Device dependent commands** are unique to an instrument. Refer to Section C-6 for more information on the device dependent commands.

## **C-5. Device Independent Commands**

*Table C-3* lists the supported device independent commands by their mnemonics, and includes the full name and a brief description of each command.

## **C-6. Device Dependent Commands**

A device dependent command is a sequence of ASCII-coded bytes sent to the HP 5347A/48A over the HP-IB that causes the instrument to perform a specific function. There are two types of device dependent commands:

- Program codes
- Queries

Program codes change the state of the instrument and/or the instrument function settings. Queries do not change function settings, but causes the instrument to return data (instrument identification, measurement setup data, etc.) to the controller.

The device dependent commands for the HP 5347A/48A are the HP-IB commands described in Sections C-35 through C-84. Refer to these sections for details on all of the device dependent commands that can be used to remotely operate the instrument.

Table C-3. Device Independent Commands

Mnemonic	Command Name	Description
ATN	Attention	Alerts the instrument of each device independent message being sent, so the instrument is ready to accept data and interpret them as commands.
DCL	Device Clear	This command clears all errors, aborts all partially completed commands and pending send data commands, and clears all input and output buffers.
EOI	End Or Identify	If ATN is false and the instrument is a listener, EOI acts as a message delimiter, and indicates the last data byte of a multibyte sequence.
GET	Group Execute Trigger	If the instrument is addressed to listen, GET aborts the current measurement, and triggers the next measurement immediately.
GTL	Go To Local	If the instrument is addressed to listen, GTL returns the instrument to front panel (local) operation. Local Lockout is not cleared.
IFC	Interface Clear	The instrument untalks and unlistens, and the interface initializes to an idle state (no activity on the bus).
LADn	Listen Address n	If n matches the instrument address, the instrument becomes a listener.
LLO	Local Lockout	The front panel Local key is disabled if the instrument is in remote mode.
MLA	My Listen Address	MLA is the listen address (LADn) that matches the instrument address.
MTA	My Talk Address	MTA is the talker address (TADn) that matches the instrument address.
NRE	Not Remote Enable	The instrument returns to front panel (local) operation; Local Lockout is cleared.
NUL	Null	No effect when received by the instrument.
REN	Remote Enable	The instrument enters the remote state, and is enabled to respond to interface commands when addressed as a listener.
SDC	Selected Device Clear	If the instrument is a listener, will cause the same response as DCL.

Table C-3. Device Independent Commands (Continued)

Mnemonic	Command Name	Description
SPD	Serial Poll Disable	Terminates serial polling, and returns the instrument to a normal talker state to output device dependent data rather than status information.
SPE	Serial Poll Enable	Establishes serial polling, and enables the instrument to send the serial poll status byte when addressed to talk.
TADn	Talk Address n	If n matches the instrument address, the instrument becomes a talker.
UNL	Unlisten	The instrument is unaddressed and terminates listening. A single device cannot be unaddressed without unaddressing all listeners.
UNT	Untalk	Unaddresses the instrument, if currently a talker, and terminates talking. Addressing another talker on the interface automatically unaddresses any current talker.

**C-7.  
Meta Messages**

To simplify the use of an HP-IB system, meta messages may be used to send commands to the HP 5347A/48A. Meta messages are a useful sequence of device independent commands which have been integrated into a single command. For example, sending a "CLEAR 714" command is equivalent to sending the sequence "ATN,UNL,MTA,LAD14,SDC". (Note that the meta message "CLEAR 714" doesn't require the user to remember all of the independent commands and their interactions. This greatly simplifies the use of the interface.)

Many of the meta messages can be sent either with addressing or without addressing. The addressed form will normally address a particular device to listen. For example, the command "REMOTE 7" will send the Remote Enable (REN) command without making any device a listener; the command "REMOTE 714" will send Remote Enable and make the device at Address 14 a listener.

Table C-4 lists 12 meta messages by name, and includes a description of the command function, corresponding interface message sequence, and the HP 5347A/48A response for each meta message. The interface message sequences are typical in that different controllers may send different sequences for a given meta message, but will produce the same results.

Table C-4. Meta Message Reference Table

Meta Message	Command Sequence	General Description	Specific HP 5347A/48A Response
DATA	UNL, MTA, LADn, data	Transfers device dependent information from one device to one or more devices on the bus.	The 5347A/48A sends measurement data as defined by the device dependent command received from the controller.
TRIGGER	UNL, MTA, LADn, GET	Causes a group of selected devices to simultaneously initiate a set of device dependent actions.	Starts a new measurement.
CLEAR	UNL, MTA, LADn, SDC	Causes the instrument to be set to a predefined state, such as a certain range or function.	Causes the 5347A/48A to clear any errors present, clears all input and output buffers, and resets the hardware for a new measurement.
REMOTE	REN, UNL, MTA, LADn	Permits selected devices to be set to remote operation, allowing parameters and device characteristics to be controlled by bus messages.	Causes the 5347A/48A to go to remote operation if REN is true, and if instrument is addressed to listen. Locks out all front panel keys except Local; instrument is controlled by bus messages. Until changed via the bus, remote operation is according to state of front panel settings just prior to going to remote.
LOCAL	UNL, MTA, LADn, GTL	Causes selected devices to return to local (front panel) operation.	Returns the 5347A/48A to front panel control. Instrument status is that set just prior to receipt of the Local message.
LOCAL LOCKOUT	LLO	Disables local (front panel) controls of selected devices.	Disables Local key. The 5347A/48A remains in remote operation until a Local message is received on the bus.
LOCAL/ CLEAR LOCAL LOCKOUT	LCLL	Returns all devices to local (front panel) control and simultaneously clears the Local Lockout message.	Returns 5347A/48A to local control and clears Local Lockout message.

Table C-4. Meta Message Reference Table (Continued)

Meta Message	Command Sequence	General Description	Specific HP 5347A/48A Response
SERVICE REQUEST	SRQ	Indicates a device's need for interaction with the controller.	The 5347A /48A will send a Service Request message to the controller under certain conditions, as defined by the settings of the Status Byte registers.  This message is ignored by the 5347A /48A when received.
STATUS BYTE	UNL, MLA, TADn, SPE, data, SPD, UNT	Presents status information of a particular device; one bit indicates whether or not the device currently requires service, the other seven bits (optional) are used to indicate the type of service required.	The 5347A /48A sends status information to the controller. The assignment of the bits in the Status Byte are shown in <i>Tables C-5 and C-6</i> .
STATUS BIT	Not applicable	A single bit of device-dependent status information which may be logically combined with status bit information from other devices on the controller.	The 5347A /48A does not use this message.
PASS CONTROL	Not applicable	Passes bus controller responsibilities from the current controller to a device which can assume the bus supervisory role.	The 5347A /48A does not use this message.
ABORT	IFC	Unconditionally terminates bus communications and returns control to the system controller.	All HP-IB activity terminated and control returns to the system controller. Talk and Listen are cleared for the 5347A /48A and all other devices on the bus, which terminates all bus communications. The 5347A /48A status remains as it was just prior to receipt of the Abort message. Any partially entered HP-IB data message is aborted.

## C-8. CHECKING INTERFACE AND INSTRUMENT STATUS

There are two ways you can check interface and instrument status:

- Observing the front panel HP-IB status annunciators
- Reading the Status Byte

In addition to indicating its interface status, the HP 5347A/48A can **generate a Service Request (SRQ)** to the controller to indicate a need for attention, and can **interrupt the current sequence of events**. The Service Request is indicated by the setting of a bit in the Status Byte and by the front panel SRQ annunciator. You may select the conditions that will generate a SRQ by using the Service Request Mask command. Sections C-9 thru C-13 describe in detail how to check the interface and instrument status of the HP 5347A/48A.

## C-9. Front Panel Interface Status Annunciators

The HP-IB or remote status of the HP 5347A/48A is indicated on the front panel by four HP-IB status annunciators in the Liquid Crystal Display. To indicate an interface status function, an arrow-shaped annunciator (∇) appears at the bottom of the display just above the name of the active function. The four interface functions are as follows:

- REM (remote)
- LSN (Listen)
- TLK (Talk)
- SRQ (Service Request)

The REM annunciator lights when the instrument is under remote control. The LSN annunciator lights to indicate that the instrument is addressed to listen (receive commands). The TLK annunciator lights to indicate that the instrument is addressed to talk (send data). The SRQ annunciator lights when the instrument has sent a service request to the controller.

## C-10. HP 5347A/48A Dual SRQ and Status Byte

The Service Request (SRQ) and Status Byte feature of the HP 5347A/48A enables you to program the HP 5347A/48A to interrupt the controller when certain conditions are met. Of course, the controller must also be programmed to respond to the interrupt; the Request Service (RQS) flag or message from the Frequency Counter Status Byte is used to implement this and is independent of all other HP-IB activity.

The HP 5347A/48A Status Byte Register has two separate bit definitions, one each for the Counter mode and the Power

Meter mode. The RQS from the Status Byte sets the SRQ control line true and interrupts the controller. After the controller receives an SRQ, it executes a Serial Poll (SPOLL) and reads the bits of the Status Byte.

**C-11.  
OVERVIEW OF THE  
DUAL SRQ AND  
STATUS BYTE**

In general, the controller can read the Status Byte for both the Frequency Counter and Power Meter modes at any time to check selected operating conditions.

During the remote operation of the Frequency Counter, the SRQ mask command (SRQMASK,n) may be used to identify the conditions which you feel may require service or data collection by unmasking (enabling) selected bits of the Status Byte.

During remote operation of the Power Meter, the SRQ mask command (SRE,n) may be used to identify the conditions which you feel may require service or data collection by unmasking selected bits of the Status Byte.

Sections C-12 and C-13 describe the SRQ and Status Byte bit definitions of the Frequency Counter and Power Meter, respectively. Section C-14 discusses how to access the Status Byte via the controller, and describes when the individual bits are set and cleared in the Status Byte for both measurement modes (Frequency Counter and Power Meter).

The Service Request Mask commands for the Frequency Counter and the Power Meter are described in detail in Sections C-15 and C-16, respectively.

**C-12.  
FREQUENCY COUNTER  
SRQ AND STATUS  
BYTE**

When the HP 5347A/48A is in the Frequency Counter mode, there are five conditions (bits 0 – 4) that can be enabled or unmasked to cause the Request Service (RQS) message to be sent to the controller. These conditions, which are enabled by the Frequency Counter Service Request Mask command (SRQMASK,n), are listed and described in *Table C-5*.



Table C-5. Frequency Counter Mode Status Byte

Bit #	Binary Weight	Status Bit Condition
7	128	Not Used (always zero).
6	64	RQS (Request Service) Flag - High indicates that the 5347A/48A has a reason for requesting service.
5	32	The 5347A/48A is powered ON, and the power-up test is completed.
4	16	The 5347A/48A is in Local mode.
3	8	Overload condition exists on INPUT 1.
2	4	Instrument error condition exists (02 - 04 [i.e., I/O error, range error, and syntax error]).
1	2	Counter measurement is complete. Data is NOT available until the data ready bit is set. Most useful when the sample rate is set to HOLD.
0	1	Data is ready. The HP 5347A/48A responded to a request for data, and is ready to output data to the controller.

The RQS Flag (bit 6) and Power ON (bit 5) can not be enabled (unmasked). These are "don't care" bits, and they do not cause the RQS to be set.

The instrument can send a SRQ to the controller to indicate the need for attention, and can interrupt the current sequence of events. As shown in *Table C-5*, a SRQ typically indicates that data is ready to transmit and/or that an abnormal condition exists. The instrument sends a SRQ to the controller after a 0 to 1 transition of an enabled condition or bit if the Service Request Mask has been set to enable that condition. Refer to Section C-15 for detailed information on setting the Frequency Counter Service Request Mask value.

Once a SRQ has been sent, the controller identifies which conditions caused the Service Request by conducting a SPOLL of all the devices on the bus, and reading the Status Byte from each device. For example, with the HP 9836A, "A=SPOLL(714)" requests the 8-bit binary Status Byte, and sets the variable "A" equal to the value of the Status Byte. When the HP 5347A/48A Frequency Counter Status Byte is read, conditions that exist will be set to "1", whether or not they were enabled (unmasked) as a condition to generate a SRQ.

When polled, the HP 5347A/48A returns a number that is the decimal equivalent to the sum of the binary-weighted bits that have been set (refer to the column labeled **Binary Weight** in *Table C-5*). For example, a returned value of "98" (equivalent to 64+32+2) signifies: that the **RQS Flag is set**, the **power is ON**, and the **measurement is complete**. All bits of the Status Byte (except bit 6) are set (bit = 1) or cleared (bit = 0) regardless of the Service Request Mask.

The Status Byte can be displayed by executing the "DISP A" statement after the "A=SPOLL (714)" command (if using a HP 9836A). The displayed value will be the decimal equivalent to the sum of the different status bits that have been set.

**C-13.  
POWER METER SRQ  
AND STATUS BYTE**

When the HP 5347A/48A is in the Power Meter mode, there are six conditions that can be enabled to cause the Request Service (RQS) message to be sent to the controller. These conditions, which are enabled by the Service Request Mask command (SRE,n) are listed and described in *Table C-6*.

*Table C-6. Power Meter Mode Status Byte*

Bit #	Binary Weight	Status Bit Condition
7	128	Power Meter measurement error exists (05 - 10).
6	64	RQS (Request Service) Flag - High indicates that the HP 5347A/48A has a reason for requesting service.
5	32	The 5347A/48A is powered ON, and the power-up test is completed.
4	16	The HP 5347A/48A is in Local mode.
3	8	Calibration/Zero is completed.
2	4	Instrument error condition exists (02 - 10).
1	2	Power Meter measurement is complete.
0	1	Data is ready. The HP 5347A/48A responded to a request for data, and is ready to output data to the controller.

In the Power Meter mode, the Status Byte can be cleared by sending the "CS" (clear Power Meter Status Byte) program code. The "CS" command will clear bits 1, 3, and 7 (as described in Section C-14). Bit 1 can also be cleared by performing a serial poll. But bits 3 and 7 can only be cleared with the "CS" command (not by serial poll). Any of the bits in the Power Meter Status Byte can be read by performing a serial poll.

**C-14.  
Status Bytes Bit  
Descriptions**

The Frequency Counter Status Byte is accessible to the controller when the HP 5347A/48A is in the Frequency Counter Measurement mode or the Diagnostics mode. The Power Meter Status Byte is accessible to the controller when the HP 5347A/48A is in the Power Meter Measurement mode. These Status Bytes are actually one status byte with some of the bits redefined for the different modes. There are, however, two separate service request masks: one each for the Frequency Counter mode and Power Meter mode. You can only set SRQMASK (refer to Section C-15) when the HP 5347A/48A is in the Frequency Counter mode, and you can only set the SRE (refer to Section C-16) when the instrument is in the Power Meter mode. However, once each of the masks is set, they do not have to be reset when re-entering modes — they are saved in memory.

The setting and clearing of the bits in the Status byte are described below:

**STATUS BYTE BITS IN FREQUENCY COUNTER MODE**

**BIT 5 (POWER ON):** Bit 5 is set after the power-up self test and HP-IB initialization is completed.

**BIT 4 (LOCAL):** Bit 4 is set when the instrument is in local, and cleared when the instrument is in remote. This bit may be used to detect that the user has returned the Counter to local by pressing the front panel **Reset/Local** key.

**BIT 3 (OVERLOAD):** Bit 3 is set when the INPUT 1 detector signals an overload condition exists. When the input power drops below the overload threshold, the overload bit is cleared.

**BIT 2 (ERROR):** Bit 2 is set whenever an error has been detected. It is cleared only after the error has been cleared by a "RESET", "INIT", "CLR", or Selected Device Clear command (via HP-IB), or by pressing the front panel **Reset/Local** key.

**BIT 1 (MEASUREMENT COMPLETE):** Bit 1 is set at the end of a frequency measurement, and cleared when a new measurement is begun. When the sample rate is set to "FAST", this bit will be set

only briefly. To guarantee that the controller will “catch” this bit, the Counter sample rate should be set to “HOLD”. In this case, the Measurement Complete bit is set at the end of the measurement, and is cleared after a trigger initiates a new measurement. The Measurement Complete bit (bit 1) is also cleared by a serial poll.

BIT 0 (DATA READY):

Bit 0 is set whenever the interface output buffer contains data to be sent over the bus. Note that the Data Ready bit is set for any output, while the previously described Measurement Complete bit (bit 1) applies to measurement only.

#### STATUS BYTE BITS IN POWER METER MODE

BIT 7 (MEASUREMENT ERROR):

Bit 7 is set when the power applied to the sensors is incorrect for the current instrument configuration. Bit 7 is cleared by the “CS” command, which clears the Status Byte bits 1, 3, and 7.

BIT 5 (POWER ON): Same as bit 5 in the Frequency Counter mode.

BIT 4 (LOCAL): Same as bit 4 in the Frequency Counter mode.

BIT 3 (CAL / ZERO COMPLETE):

Bit 3 is set when the power meter has completed a calibration or zeroing cycle. Bit 3 is cleared by the “CS” command, which clears the Status Byte bits 1, 3, and 7.

BIT 2 (ERROR):

Same as bit 2 in the Frequency Counter mode.

BIT 1 (MEASUREMENT COMPLETE):

Bit 1 is set at the end of a measurement. Bit 1 is cleared when a power measurement is begun, after a serial poll, or when a “CS” command is sent.

BIT 0 (DATA READY):

Same as bit 0 in the Frequency Counter mode.

### C-15. Service Request Mask for Frequency Counter

When the HP 5347A / 48A is in the Frequency Counter or Power Meter mode, you can use the SRQMASK (set the Frequency Counter Service Request Mask) program code to select which of the bits in the Frequency Counter Status Byte will generate a SRQ. Any bit in the Status Byte, except RQS Flag (bit 6) and Power ON (bit 5), can be masked to prevent a SRQ from being generated even if the condition exists. To set the Service Request Mask value, send the "SRQMASK,n" command, where "n" is the decimal equivalent to the binary sum of the bits that you want enabled (unmasked). (Refer to the column labeled **Binary Weight** in *Table C-7* to select the equivalent decimal value.) The value of "n" may be any number from 0 to 255. All SRQ conditions can be disabled (masked) by sending "SRQMASK,0". If all SRQ conditions are masked, none of the conditions will generate a SRQ.

*Table C-7. Frequency Counter Service Request Mask*

Bit #	7	6	5	4	3	2	1	0
<b>Service Request Mask</b>	(Don't care)	(Don't care)	(Don't care)	LOCAL	OVER-LOAD	ERROR	MEAS. COMPLETE	DATA READY
<b>Status Byte</b>	Not Used (always zero)	RQS FLAG	POWER ON	LOCAL	OVER-LOAD	ERROR	MEAS. COMPLETE	DATA READY
<b>Binary Weight</b>	128	64	32	16	8	4	2	1

After receiving the "SRQMASK,n" command, the HP 5347A / 48A will load the binary value of "n" into the Service Request Mask register. For example, sending the command "SRQMASK,13" ( $13=8+4+1$ ) will cause the instrument to generate a SRQ and set bit 6 (RQS Flag) if an **overload** or **error** condition exists, or when **data is ready**.

Note that in *Table C-7*, bit 6 (corresponding to the RQS Flag bit in the Status Byte) is a "don't care". This is so because the RQS Flag bit in the Status Byte will only be set if one of the other bits in the Status Byte is set, and the corresponding bit in the service request mask has been set to generate a SRQ. Consequently, the command "SRQMASK,77" is equivalent to the command "SRQMASK,13".

**C-16.**  
**Service Request**  
**Mask for Power Meter**

When the HP 5347A/48A is in the Power Meter mode, you can use the SRE (set the Power Meter Service Request Mask) program code to select which of the bits in the Power Meter Status Byte will generate a SRQ. Any bit in the Status Byte, except RQS Flag (bit 6) and Power ON (bit 5), can be masked to prevent a SRQ from being generated even if the condition exists. To set the Power Meter Service Request Mask value, send the "SRE,n" command, where "n" is the decimal equivalent to the binary sum of the bits that you want enabled (unmasked). (Refer to the column labeled **Binary Weight** in *Table C-8* to select the equivalent decimal value.) The value of "n" may be any number from 0 to 255. All SRQ conditions can be disabled (masked) by sending "SRE,0". If all SRQ conditions (or status bits) are masked, none of the conditions will generate a SRQ.

*Table C-8. Power Meter Service Request Mask*

Bit #	7	6	5	4	3	2	1	0
Service Request Mask	NOT AVAILABLE	(Don't care)	(Don't care)	LOCAL	CAL/ZERO COMPLETE	ERROR	MEAS. COMPLETE	DATA READY
Status Byte	POWER METER ERROR	RQS FLAG	POWER ON	LOCAL	CAL/ZERO COMPLETE	ERROR	MEAS. COMPLETE	DATA READY
Binary Weight	128	64	32	16	8	4	2	1

After receiving the "SRE,n" command, the HP 5347A/48A will load the binary value of "n" into the Service Request Mask register. For example, sending the command "SRE,6" (6=4+2) will cause the instrument to generate a SRQ and set bit 6 (RQS Flag) when a **measurement is complete** or a **Power Meter measurement error** condition exists. A SRQ interrupt will be generated.

**C-17.**  
**DATA INPUT**

Almost all the HP 5347A/48A functions can be programmed via the bus using the specific HP-IB programming codes (device dependent commands) for the instrument. All local functions, except for POWER, are programmable via the HP-IB. The HP-IB commands for the HP 5347A/48A are discussed in detail, beginning at Section C-35, **HP-IB COMMAND DESCRIPTIONS**.

The following paragraphs describe the syntax and format for sending HP-IB commands to the HP 5347A/48A.

## C-18. HP-IB Command Syntax Overview

The HP-IB syntax for the HP 5347A/48A has four possible types of command elements:

- Command Mnemonics (referred to as "headers")
- Data
- Command separators (csep)
- Data separators (ds)

The HP-IB syntax for the HP 5347A/48A is as follows, for both the Frequency Counter and Power Meter command set:

**header [ds data] csep**

In this syntax description,

**header** is a command mnemonic or program code,

**ds** is a data separator (which can be a space or a comma),

**data** is the numeric or ASCII data, if any, which accompanies the command, and

**csep** is a command separator (which can be a carriage return, a line feed, or a semicolon).

There may be 0 to 2 data fields for each command, and there may be more than one command per line, for example:

**header1,data1a,data1b;header2;header3,data3**

A specific example for a string of Frequency Counter commands is as follows:

**SAMPLE HOLD;TRIGGER**

A specific example for a string of Power Meter commands is as follows:

**LG;TR0**

**C-19.**  
**HP-IB Command**  
**Syntax Diagrams**

In the following paragraphs, HP-IB command syntax is represented pictorially, to explain the format in which HP-IB programming commands should be sent to the instrument. In the diagram note that:

- All characters enclosed by a rounded envelope must be entered exactly as shown.
- Words enclosed by a rectangular box are names of items used in the commands, and are described in the text.
- Items contained within circles indicate required literals, which must occur in the command syntax exactly as shown.
- Command elements, connected by lines, can be followed in one direction only, as indicated by the arrowhead at the end of the line. Any combination of command elements that can be generated by following the lines in the proper direction is syntactically correct.

**NOTE**

*Spaces are not shown in all places where they may occur. You may place spaces between command mnemonics and data in the command string to gain greater clarity, but spaces within command mnemonics and within data are not allowed.*

As previously mentioned, there are four possible types of command elements: command mnemonics (referred to as "headers"), data, command separators, and data separators. A command can consist of a header alone or a header followed by zero to two data fields. A separator is required between headers and data, between data fields, and between each command, as shown in *Figure C-2*.

*Figure C-2.*  
*Program Command*  
*Syntax*

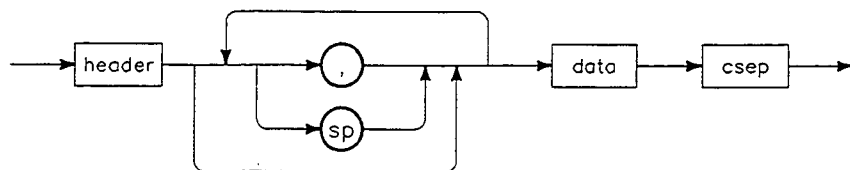



**C-20.**  
**Command Headers**  
**(Command**  
**Mnemonics)**

All HP-IB commands require a command header. Command headers, where possible, consist of the full English word for the corresponding function, up to a maximum of eight characters in length. Function names which require more than eight characters or more than one word are abbreviated.

There are two types of command headers: program codes and queries. Program codes are commands which instruct the HP 5347A/48A to perform a particular action. Queries cause data to be returned to the controller; a query header includes a question mark (?) as the last character of the header. Note that queries do not change the data after the data has been read by the controller.

Table C-9 contains a summary of all the command headers (or Program Code headers) for the HP 5347A/48A. The listing groups the commands functionally. Table C-9 is divided into two parts: program code headers and query headers.

*Table C-9.*  
*HP 5347A/48A*  
*Programming*  
*Command Headers*

Program Code Headers	Function
RESET	Restarts measurement; clear any errors.
CLR	Clears the instrument.
INIT	Completes an instrument initialization.
DIAGENT	Puts the instrument into the Diagnostics mode.
MEASENT	Puts the instrument into the Measurement mode.
AUTO	Puts Input 1 into Automatic mode.
MANUAL	Puts Input 1 into Manual mode.
LOWZ	Sets Input 2 impedance to 50Ω.
HIGHZ	Sets input 2 impedance to 1MΩ.
STORE	Stores the frequency value currently being measured.
TRIGGER	Triggers instrument, starts a new Counter measurement.
TRG	Same as TRIGGER.
RESOL	Modifies frequency measurement Resolution.
SAMPLE	Modifies Sample Rate for frequency measurement.
LG	Puts the instrument into Power Meter, dBm mode.
LN	Puts the instrument into Power Meter, Watts mode.
PR	Presets the Power Meter.
CS	Clears the Power Meter Status Byte.
SRE	Sets the Power Meter Service Request Mask.
OC	Turns Power Reference Oscillator ON or OFF.
CL	Calibrates the Power Meter.
ZE	Zeroes the Power Meter.
RA	Puts Power Meter into Auto Range mode.
RM	Puts Power Meter into Manual Range mode.
TR	Modifies Power Meter Trigger mode.
DIAG	Selects a particular diagnostic test.
DIAGPARM	Enters Diagnostic parameter for Diag 51 test.

Table C-9.  
HP 5347A/48A  
Programming  
Command Headers  
(Continued)

Program Code Headers	Function
DISPLAY	Displays the entered message/Display concealment.
SRQMASK	Sets Frequency Counter Service Request Mask.
DUMP	Configures instrument for fastest measurement: 100 reading per second.
SET	Sets up the instrument.
SLEEP	Disables or Enables INPUT 1 circuit.
Query Headers	Function
DIAG?	Returns diagnostics results.
KEY?	Returns number of last key pressed.
ID?	Returns device model number.
SET?	Returns instrument setup.
ERR?	Returns Frequency Counter or instrument error number.
PERR?	Returns Power Meter error number.
SENSOR?	Returns identification number of the power sensor selected via the rear panel sensor switches.
REF?	Returns timebase reference status.
MOD?	Returns Power Meter measurement mode, linear or log.
PTRG?	Returns Power Meter trigger mode.
RNG?	Returns Power Meter range setting.
OSC?	Returns Power Reference Oscillator status.

The HP 5347A / 48A accepts commands in either upper or lower case. All characters are converted to upper case before interpretation. In addition, parity bits are ignored. For example, the following two strings will produce identical results:

OUTPUT 714;"SAMPLE,FAST"  
OUTPUT 714;"Sample,Fast"

### C-21. Command Separators

Command separators are required. In the detailed syntax diagrams the command separators are not shown. Note that the END command separator is only sent with the last byte of the command as shown in *Figure C-3*.

Figure C-3. Command Separators

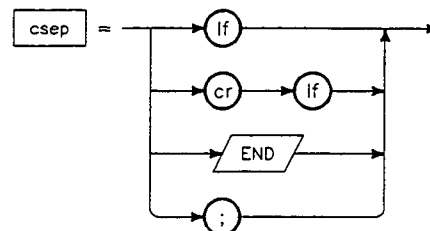

## C-22. Data Separators

Data separators are required between headers and data, and between data fields. A <comma> (,) is the preferred separator, but a <space> (sp) may also be used as a separator. In the detailed command syntax diagrams, both types of separators are represented by "ds", as shown in *Figure C-4* below.

*Figure C-4.*  
*Data Separators*

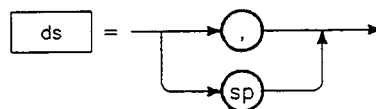

## C-23. Data Formats

Commands may have none, one, or two pieces of data sent as part of the program code. There are three types of data:

- Numeric data – Used for function settings that require the entry of a number.
- Character data – Used for function settings that are not inherently numeric, or that set a binary condition (i.e., ON/OFF settings).
- String data – Used for displaying messages on the 24-character Liquid Crystal Display on the front panel, and for sending setup information (using the "SET" command).

## C-24. Numeric Data

Functions that expect you to input a number, such as a manual center frequency, resolution, range, and others, require numeric data. Numeric data entry is a "free-format" input, i.e., spaces are allowed before and after a numeric character is entered. Spaces are not allowed within a number. A decimal point and an exponent are allowed, but not required. Refer to *Figure C-5* for the preferred syntax for each numeric data type.

If numeric data is required by a program code, it can be entered in integer, real, or floating point form. For example, the following command strings are equivalent:

```
OUTPUT 714;"MANUAL,500000000"
OUTPUT 714;"MANUAL,5E+08"
```

Program codes requiring the integer form of numeric data (such as the "RESOL" or "DIAG" commands) will round any non-integer data to the nearest integer. For example, the following command strings are permitted, and are equivalent:

```
OUTPUT 714;"RESOL,3.9"
OUTPUT 714;"RESOL,4"
```

Figure C-5 shows the preferred syntax for the three numeric data types: nr1 (integer), nr2 (real), and nr3 (floating point).

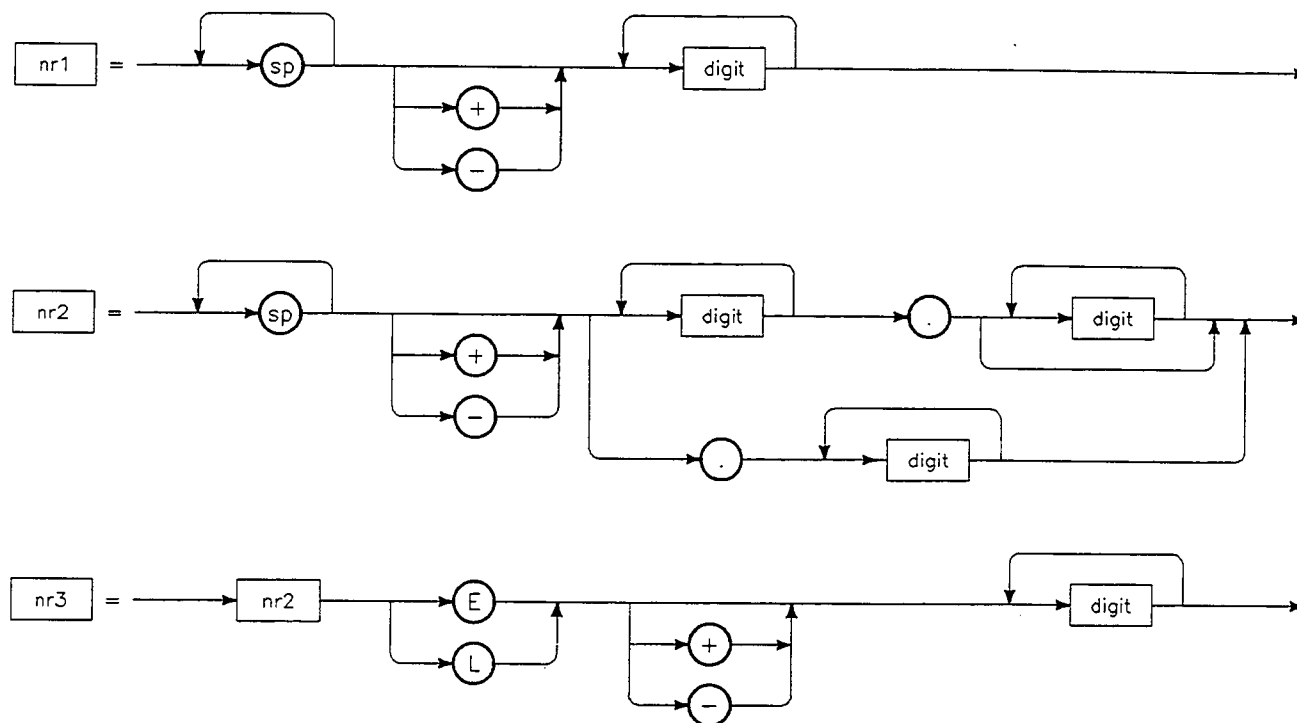

Figure C-5. Numeric Data Types

The "L" in the last syntax diagram in Figure C-5 is the European equivalent of "E" (exponent). The HP 5347A/48A interprets both the E and L as the same.

### C-25. Character Data

Character data is used for those functions that are not inherently numeric, such as the FAST or HOLD setting for the Sample Rate function. Character data is also used for setting binary conditions, such as the ON/OFF setting of the Sleep function. *Table C-10* lists all the allowable character data that can be included in a command to the HP 5347A/48A.

*Table C-10. Character Data*

DATA	DEFINITION
ON	Turn function on.
OFF	Turn function off.
LASTF	Use last measurement as frequency value.
FAST	Repeat measurement as quickly as possible.
HOLD	Hold last measurement until new measurement is triggered.

### C-26. String Data

String data is similar to character data except that the characters are enclosed in single quotes ('). This format allows special characters, such as <comma>, <space>, and <semicolon> to be sent as data. String data is used with the "DISPLAY" command for displaying messages on the front panel Liquid Crystal Display (LCD) assembly, and also with the "SET" command for sending ASCII hexadecimal characters. An example of string data is shown below:

OUTPUT 714;"DISPLAY, 'HELLO WORLD'"

**C-27. DATA OUTPUT** The following paragraphs describe the output format for each type of data returned over the bus by the HP 5347A/48A.

**C-28. Frequency Measurements** The HP 5347A/48A, if not set to HOLD, continuously makes measurements. At the end of each measurement cycle, the HP-IB status is checked and, if the Frequency Counter is addressed to talk, the latest measurement is sent to the interface. After the next measurement cycle, the previously sent measurement will be overwritten if it has not been read by the controller or otherwise handshaken onto the bus. If the Counter is not addressed to talk, no measurements are sent to the interface.

The instrument is addressed to talk whenever measurement data or query data is requested. Measurement data is requested when the "ENTER 7XX" BASIC program command is sent via a controller ("XX" in the ENTER command is the instrument's selected HP-IB address). Query data is requested when a query command is sent via a controller. Additionally, a serial poll will cause the instrument to be addressed to talk.

When the Counter is set to HOLD, no measurement is made until a trigger is received. After the trigger, a single measurement is made. The measurement result is then sent to the interface if the Counter is addressed to talk.

Dump mode measurements use the same output method as normal frequency measurements, except for three differences:

1. The output format is different (7 characters and EOI [End Or Identify] is sent with the last byte).
2. The Counter ignores the HOLD and FAST parameters of the sample rate command.
3. The Status Byte is not updated.

The Frequency Counter trigger and sample rate commands are described in Sections C-50 and C-45, respectively. Dump mode is described in Section C-38.

**C-29. Power Measurements** When the HP 5347A/48A is in the Power Meter mode, the data output to the HP-IB operates in a manner similar to the Frequency Counter mode. If the Power Meter is in free-run mode, the HP 5347A/48A continuously makes power measurements. At the end of each measurement cycle, the Power Meter measurement data is sent to the Frequency

Counter processor to be displayed and/or sent to the HP-IB. The Counter processor will send the power measurement data to the interface if the HP 5347A/48A is addressed to talk. After each measurement cycle, the previous power measurement data is overwritten if it has not been read by the controller.

When the HP 5347A/48A Power Meter is in the trigger-hold mode, measurements are continuously made, but the display and the HP-IB are not updated until a "trigger immediate" or "trigger delay" command is received. After a trigger is received, one power measurement is made, and the power measurement data is transferred to the Counter processor for display and/or transfer to the HP-IB. After measurements are completed, the Power Meter returns to trigger-hold mode waiting for the next trigger.

The Power Meter triggering modes and commands are described in Section C-68.

### **C-30. Diagnostic Results**

Diagnostics behave similarly to measurements in that the diagnostics continuously cycle. At the end of a cycle, the diagnostic result is sent to the HP 5347A/48A's interface in a "wait until addressed" mode. In this mode, the instrument's interface holds the data until it is read by the controller, and will not allow the data to be overwritten by frequency or power measurements. The interface receives the data regardless of whether the instrument is addressed to talk or not. A "DIAG?" query must be sent to the HP 5347A/48A for each diagnostic result desired. Diagnostic failure results are returned in the same way as diagnostic pass results.

### **C-31. Other Outputs**

All other outputs must be requested by the controller through a query command. The data is sent to the HP 5347A/48A's interface immediately in a "wait until addressed" mode, as described in the preceding paragraph. For information about the return format for individual queries, refer to the detailed query descriptions in the HP-IB COMMAND DESCRIPTIONS in this appendix.

### C-32. Numeric Output Format

All measurements (except DUMP mode measurements), and error number query responses (that is, responses to ERR? and PERR?) are returned in scientific notation. The returned data always contains 24 characters which are arranged in the following format:

Variable number of spaces (N spaces, at least 1 space)  
 Sign: "-" if negative or <space> if positive  
 One digit  
 Decimal point  
 Variable number of digits (K digits)  
 Exponent symbol (E+ or E-)  
 Two exponent digits  
 Carriage return  
 Line feed

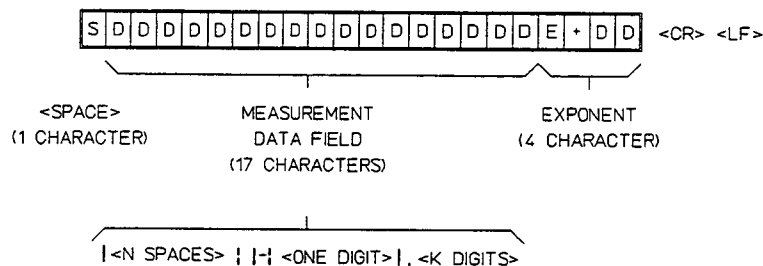

MISC163M

The decimal point is omitted if it is the last character preceding the exponent "E" in the output string. The first digit will be zero only if the output data is zero.

The sign "-" for negative or <space> for implied positive is placed immediately to the left of the first digit of the mantissa. The sign is preceded by blanks, if necessary, to keep the total string length constant. All significant digits of a frequency or power are returned. The number of significant digits in a frequency measurement depends on the resolution to which the measurement is made.

**MEASUREMENT DATA FIELD.** The data field consists of 17 characters. The number begins with the sign, followed by the digits in descending order of significance. The number is right-justified within the data field. Spaces are inserted in front of the sign to keep the number of characters in the string constant.

**EXPONENT.** The exponent is always two digits, and is preceded by the symbol "E" and a "+" or "-" sign. Hertz units are implied for frequency measurements. For power measurements, Watts or dBm units are implied.



**TYPICAL OUTPUT STRINGS.** The following string illustrates the typical output for an AUTO mode measurement of 19.412 530 789 GHz. The output data is always followed by a carriage return <CR> and line feed <LF>. (Note: quotes are not sent over the bus.)

"            1.9412530789E + 10" <CR> <LF>  
          └───┘

(6 spaces)

If there is an overflow (the math result is out of bounds) or the Counter cannot acquire the input signal, the following output is sent over the HP-IB (refer to Section C-38, Dump Mode, for exception):

"                                    1E+38" <CR> <LF>  
                                  └──────────┘

(17 spaces)

Similarly, in the Power Meter mode if a measurement error exists, "1E+38" is sent to the controller.

### C-33. Query Output Formats

The output formats for the HP 5347A/48A query commands vary depending on the particular query. For detailed information about a given query, refer to the individual query descriptions in the HP-IB COMMAND DESCRIPTIONS section of this appendix. Query commands should be entered on a separate line of the controller program.

### C-34. ERROR HANDLING

Certain conditions will cause an error in the HP 5347A/48A. When an error occurs, normal operation is suspended until the error is cleared. In the error state, the instrument processes all HP-IB commands. Errors must be resolved before normal instrument operation can resume.

Errors are cleared by sending a Device Clear, Selected Device Clear, "INIT," "RESET," or "CLR" commands, or by pressing the Reset/Local key. Pressing the Reset/Local key also returns the instrument to local operation and to the Frequency Counter mode measuring from Input 1.

Error numbers can be read via the bus by sending the "ERR?" query command while the HP 5347A/48A is in the Frequency Counter mode, and by sending the "PERR?" query command in the Power Meter mode. (ERR? can return error codes 2E+10 through 4E+10, and PERR? can return error codes 2E+10 through 10E+10.) After receiving the ERR? query, the instrument sends the error message to the controller, and remains in the error state. For example, the following command strings are required to transmit the error number to the controller:

OUTPUT 714;"ERR?"		OUTPUT 714;"PERR?"
ENTER 714;X\$	OR	ENTER 714;X\$
DISP X\$		DISP X\$

The Status Byte contains error bits to flag error conditions. When an error condition occurs, the set flag reflects the message displayed on the instrument's front panel. The error bit in the Status Byte is cleared when the error is cleared, as described previously. Note that there is a slight delay between sending the "INIT" command and the clearing of the status byte flag. If a serial poll is performed during this time, the status byte will still show an error.

**C-35.  
HP-IB COMMAND  
DESCRIPTIONS**

The HP 5347A/48A has three fundamental operating modes:

- Measurement-Frequency Counter
- Measurement-Power Meter
- Diagnostics

*Table C-11* lists the commands available for the Measurement-Frequency Counter operating mode. *Table C-12* lists the commands that are available for the Measurement-Power Meter operating mode. *Table C-13* lists the commands which are valid for both the Power Meter and Frequency Counter measurement modes; these commands have the same meaning in either measurement mode. *Table C-14* lists the commands that are available for the Diagnostics operating mode.

There are ten commands that not only execute a specific function but also execute the switching between the three fundamental operating modes . These command are listed below:

- AUTO
- HIGHZ
- LOWZ
- MANUAL
- LG
- LN
- DIAGENT
- MEASENT
- INIT
- RESET

Figure C-6.  
HP 5347A/48A  
HP-IB Command  
Flow

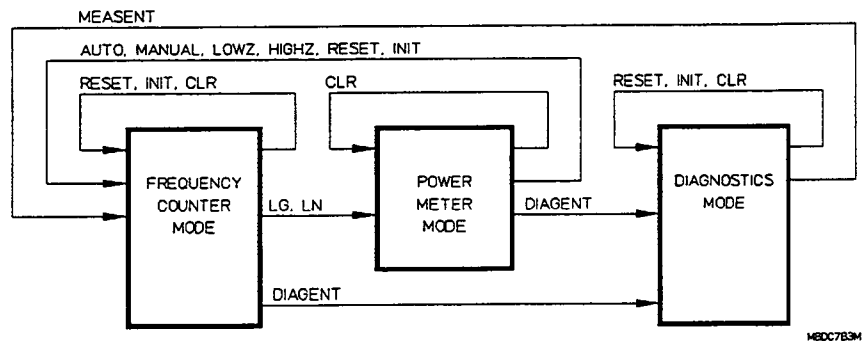

Any measurement mode commands sent to the HP 5347A /48A during diagnostics mode, or diagnostics commands sent to the HP 5347A /48A during the measurement mode, will result in a syntax error. Similarly, any Power Meter commands sent to the HP 5347A /48A during the Counter mode, except "LN" and "LG" will result in a syntax error, and any Counter commands sent to the HP 5347A /48A during Power Meter mode, except "AUTO", "MANUAL", "HIGHZ", and "LOWZ" will result in a syntax error. Figure C-6 illustrates the flow of the HP-IB commands for the HP 5347A /48A.

\* NOTE: Depending on the sequence of commands and the controller execution speed, it may be necessary to delay a new measurement when switching from Power Meter mode to Frequency Counter mode. A delay of 200 ms is recommended.

Table C-11. Measurement-Frequency Counter Mode HP-IB Command Set

HP-IB CODE	BRIEF DESCRIPTION	SECTION NUMBER
AUTO	Selects INPUT 1, automatic measurement mode.	C-37
DUMP	Turns dump mode on when "DUMP ON" is sent to the controller. Turns dump mode off with "DUMP OFF".	C-38
ERR?	Returns the Frequency Counter or instrument error number.	C-39
HIGHZ	Selects INPUT 2, 1 MΩ.	C-40
LOWZ	Selects INPUT 2, 50Ω.	C-41
MANUAL	Selects INPUT 1, manual measurement mode. A Manual Center Frequency parameter must be specified, in Hertz, or LASTF may be sent.	C-42
REF?	Returns the timebase reference status.	C-43
RESOL {0,4}	Sets the resolution to 1 Hz or 10 kHz.	C-44
SAMPLE	Allows user to choose one of two sample rates, FAST or HOLD.	C-45
SLEEP	Turns the microwave assembly ON or OFF, in effect disabling or enabling INPUT 1. (Turns off if user sends "SLEEP ON").	C-46
SRQMASK	Sets the Frequency Counter Service Request Mask value. The value is the decimal (0 to 255) equivalent to the binary sum of the bits that the user wants enabled (unmasked) in the Status Byte.	C-47
STORE	Stores the frequency value currently being measured.	C-48
TRIGGER and TRG	Starts a new measurement if the sample rate is set to HOLD. If not in HOLD, aborts the current measurement.	C-50

Table C-12. Measurement-Power Meter Mode HP-IB Command Set

HP-IB CODE	BRIEF DESCRIPTION	SECTION NUMBER
CL	Calibrates the Power Meter.	C-52
CS	Clears the Power Meter bits 1, 3, and 7 in the Status Byte.	C-53
EN	Enter, used after numeric entry (e.g., RM2EN) to terminate a string of numeric data . (Optional)	C-54
LG	Enters the instrument into Power Meter, dBm mode.	C-55
LN	Enters the instrument into Power Meter, watts mode.	C-56
MOD?	Returns measurement mode, linear or log.	C-57
OC{0,1}	Disables or Enables the 50 MHz Power Reference Oscillator.	C-58
OSC?	Returns Power Reference Oscillator status.	C-59
PERR?	Returns the Power Meter or instrument error number.	C-60
PR	Presets the Power Meter parameters.	C-61
PTRG?	Returns the Power Meter trigger mode.	C-62
RA	Auto Range, automatically selects the correct range for the current power measurement.	C-63
RM{1-5}	Manual Range, enables the range to be selected manually. Valid range numbers are 1 through 5.	C-64
RNG?	Returns range setting.	C-65
SENSOR?	Returns identification number of power sensor selected via rear panel sensor switches.	C-66
SRE	Sets the Power Meter Service Request Mask value. The value is the decimal (0 to 255) equivalent to the binary sum of the bits that the user wants enabled (unmasked) in the Status Byte.	C-67
TR{0-3}	Triggering: TR0 — trigger hold TR1 — trigger immediate TR2 — trigger with delay TR3 — free run	C-68
ZE	Zeroes the Power Meter.	C-69

Table C-13. HP-IB Commands Common to Both Measurement Modes

HP-IB CODE	BRIEF DESCRIPTION	SECTION NUMBER
CLR	Clears the Instrument.	C-71
DIAGENT	Enters the instrument into diagnostics mode.	C-72
DISPLAY	Allows remote display of up to 24-character string.	C-73
ID?	Returns the instrument identification as a 14-character string containing the model number of the instrument.	C-74
INIT	Initializes the instrument.	C-75
KEY?	Returns a number corresponding to the last key pressed.	C-76
RESET	Returns the instrument to the power-up measurement mode.	C-77
SET	Sets up the instrument according to the data passed.	C-78
SET?	Returns the current instrument setup.	C-79

Table C-14. Diagnostics Mode HP-IB Command Set

HP-IB CODE	BRIEF DESCRIPTION	SECTION NUMBER
CLR	Clears the instrument.	C-71
DIAG	Selects the diagnostic.	C-81
DIAGPARM	Enters diagnostic parameter for DIAG 51 test.	C-82
DIAG?	Returns the diagnostic results.	C-83
INIT	Initializes the instrument.	C-75
MEASENT	Enters the instrument into power-up measurement mode.	C-84
RESET	Returns the instrument to power-up diagnostics mode.	C-77

**C-35.**  
**HP-IB COMMAND**  
**DESCRIPTIONS**  
**(Continued)**

The following paragraphs describe each of the HP-IB commands for the HP 5347A /48A. Each group of program codes and queries are listed in alphabetical order and are accompanied by a syntax diagram as described in Section C-19.

All query commands return data to the controller. Each description of a query includes information on the output format resulting from a given query.

**C-36.**  
**Frequency Counter**  
**Mode Command Set**

**C-37.**  
**AUTO: AUTOMATIC**  
**MEASUREMENT MODE**

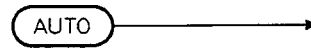

This program code has the same effect as pressing the **Input 1, 50Ω** key on the front panel (i.e., selects INPUT 1, automatic measurement mode). The current measurement cycle is aborted. AUTO may be used to re-enter the Frequency Counter mode from the Power Meter mode. Sleep mode is turned off.

**C-38.**  
**DUMP: DUMP MODE**

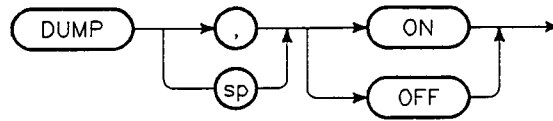

This program code enters the instrument into DUMP mode, which provides **faster reading capability**. Approximately 100 measurements per second, at 10 kHz resolution, may be read. Sending the "DUMP ON" command turns the Dump mode ON. DUMP mode can be exited by sending the "DUMP OFF" command.

When DUMP mode is ON the instrument displays "DUMPING--". The display is not updated. Serial poll status is not updated.

**The DUMP mode feature works in the Frequency Counter, Input 1 mode ONLY.** The format of the frequency returned when in DUMP mode is described in the following paragraphs.

The format is a 7-character numeric ASCII string, with no spaces or decimal points, of the form:

GGMMMkk EOI

where G = gigaHertz digits  
M = megaHertz digits  
k = kiloHertz digits  
EOI = End or Identify (sent with last digit as message terminator)

Leading zeroes are not blanked, and the returned value must be multiplied by 10 kHz to get the frequency value in Hertz.

#### COMMENTS

The DUMP mode works in both Auto and Manual modes. **Before activating the DUMP mode, the Frequency Counter's Resolution MUST be set to "RESOL,4"(10 kHz).**

If DUMP is to be used in Manual (using the "MANUAL" program code), a manual center frequency may be specified or the last measurement may be selected as the center frequency, as described in Section C-42, MANUAL.

When performing a DUMP in either the Auto or Manual mode, the FAST and HOLD parameters of the sample rate command are ignored or overridden.

When DUMP mode is ON, the only commands that should be sent to the instrument are "DUMP OFF" and "INIT". Any other commands will give unpredictable results.



**C-39.**  
**ERR?: SEND ERROR**  
**NUMBER**

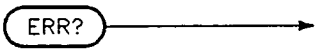

This program query returns the most recent Frequency Counter or instrument error number. If there is no error, the scientific-notated number "0E+00" (zero) is returned. If an error exists, a scientific-notated number from 2E+00 to 4E+00 is returned. The numbers 2E+00 through 4E+00 represent the following error messages:

Error Code	Error Message Displayed	Meaning	Action Required
2E+00	I/O	2 ERROR Internal HP-IB Interface error.	HP 5347A / 48A needs service.
3E+00	OUT OF RANGE	3 ERROR Input number or value entered by the user is out of range.	Re-enter a value within the limit of the HP-IB command.
4E+00	SYNTAX	4 ERROR HP-IB command syntax error.	Check program command.

**C-40.**  
**HIGHZ: INPUT 2, 1M $\Omega$**   
**MEASUREMENT MODE**

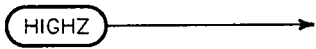

This program code has the same effect as pressing the Input 2 1M $\Omega$  key on the front panel (selects INPUT 2, 1 M $\Omega$  input impedance). The current measurement cycle is aborted. HIGHZ may be used to enter the Frequency Counter mode from the Power Meter mode.

**C-41.**  
**LOWZ: INPUT 2, 50 $\Omega$**   
**MEASUREMENT MODE**

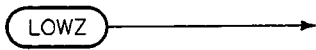

This program code has the same effect as pressing the Input 2 50 $\Omega$  key on the front panel (selects INPUT 2, 50 $\Omega$  input impedance). The current measurement cycle is aborted. LOWZ may be used to enter the Frequency Counter mode from the Power Meter mode.

**C-42.**  
**MANUAL: MANUAL**  
**MEASUREMENT MODE**

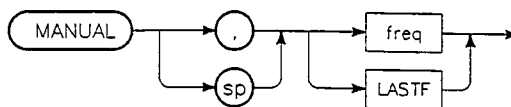

This program code selects INPUT 1, manual measurement mode. A Manual Center Frequency parameter may be specified, in Hertz or "LASTF" may be passed. If "LASTF" is passed, the last measurement is used as the Manual Center Frequency. The current measurement cycle is aborted. MANUAL may be used to enter the Frequency Counter mode from the Power Meter mode.

**NOTE**

*LASTF should NOT be used when switching from Input 2 to Input 1, or when switching from Power Meter mode to Input 1 when the last frequency measured was different from the frequency currently being measured on Input 1.*

A frequency must be specified by an explicit number or "LASTF" (the last measurement). All frequencies entered are in Hertz units.

**COMMENTS**

If a Manual Center Frequency (CF) is entered which is greater than 26.5 GHz or less than 500 MHz, then an error is displayed. After the user clears the error, the Counter returns to counting using the previous value. If a CF containing fractional-mega Hertz values is entered, the fractional portion is truncated. The CF entered should be no more than 20 MHz from the input frequency for inputs in the 1 GHz to 20 GHz (26.5 GHz for HP 5348A) range, and no more than 3 MHz from the input frequency for inputs in the 500 MHz to 1 GHz range. If the CF is too far from the input frequency, the counter may display an incorrect measurement.

**C-43.**  
**REF?: SEND TIMEBASE**  
**REFERENCE STATUS**



This program query causes the instrument to return its reference status: internal or external. The "REF?" query is most useful as a check that the instrument is properly connected. If an external reference is connected, the instrument returns "EXT". If the instrument is using the internal 10 MHz reference, the string returned is "INT".

**C-44.**  
**RESOL{0,4}:**  
**RESOLUTION 1 HZ OR**  
**10 KHZ**

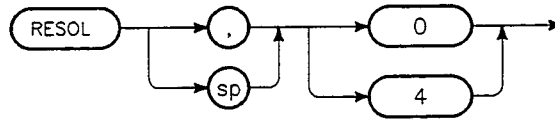

This program code sets the resolution to either 1 Hz or 10 kHz. The resolution is set to 1 Hz by sending a "0" ( $10^0$ ) integer with "RESOL" header. Send a "4" ( $10^4$ ) integer with the "RESOL" header to set the resolution to 10 kHz.

**C-45.**  
**SAMPLE: SAMPLE RATE**

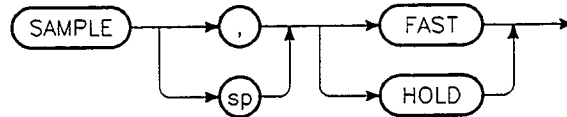

This program code allows the user to choose between two sample rates. "FAST" will allow the instrument to repeat measurements as quickly as possible. When in "HOLD", a new measurement will be started only after a "TRIGGER" or "TRG" program code, or a Group Execute Trigger (GET) is sent.

**C-46.**  
**SLEEP: DISABLE INPUT**  
**1 CIRCUIT**

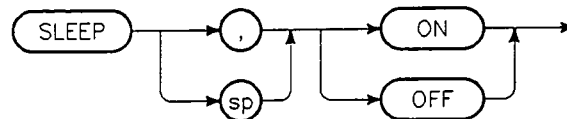

The "SLEEP ON" program code disables the high frequency input (INPUT 1) by turning off the A12 Microwave Assembly, thus minimizing the effect of having an input connected to the instrument. This mode may be useful when several instruments are connected to one signal, and the HP 5347A / 48A is temporarily not being used for signal measurements. INPUT 1 measurements cannot be made when the SLEEP function is ON. Passing the "OFF" parameter turns the A12 Assembly back ON.

**NOTE**

*A12 Microwave Assembly is temporarily turned off when the instrument is in the Power Meter mode, or in Input 2 mode.*

**C-47.  
SRQMASK: SET  
COUNTER SERVICE  
REQUEST MASK  
VALUE**

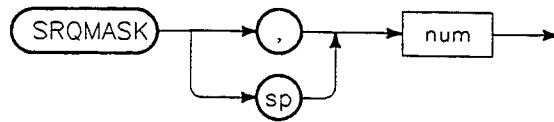

This program code sets the Frequency Counter Service Request Mask value to cause a Service Request (SRQ) whenever an enabled condition changes from 0 to 1 in the Frequency Counter Status Byte. To enable a condition, set the corresponding bit in the Status Byte to "1", and to disable, set the bit to "0", as shown below:

**FREQUENCY COUNTER STATUS BYTE**

Binary	Decimal	Condition
X000 0000	128	Not used (always zero)
0X00 0000	64	RQS Flag
00X0 0000	32	Power ON
0001 0000	16	Local
0000 1000	8	Overload
0000 0100	4	Instrument Error (02 – 04)
0000 0010	2	Measurement Complete
0000 0001	1	Data Ready
0000 0000	0	No SRQ conditions enabled

Conditions may be enabled singly or in any combination desired. For example, setting binary 0000 0110 (decimal 6) will cause a SRQ if either an **instrument error** occurs or a **measurement is completed**.

Sending the "SRQMASK,6" command to the HP 5347A/48A will set the previously mentioned bits (Instrument Error and Measurement Complete) to generate an SRQ. The "6" value in this program code is the decimal equivalent to the binary sum of the bits that you want enabled (unmasked). The value may be any number between 0 and 255. Refer to Sections C-10 through C-16 for detailed information about the Service Request Masks and Status Bytes.

**C-48.**  
**STORE: STORE**  
**FREQUENCY VALUE**

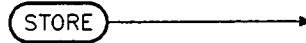

This program code has the same effect as pressing the Calibrate/Store Frequency key on the front panel; that is, the program code stores the currently displayed frequency when the instrument is in the Frequency Counter mode. The power-up condition stores 0 Hz. When the "STORE" program code is sent and there is no input, 0 Hz is also stored. The stored frequency is used by the Power Meter to more precisely calibrate the power sensor, giving more accurate power measurements. Refer to Section 3-5 in this manual for more details.

**C-50.**  
**TRIGGER AND TRG:**  
**TRIGGER**

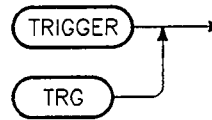

This program code starts a new measurement when the instrument sample rate is set to HOLD. If not in HOLD, the current measurement is aborted.

**C-50.  
TRIGGER AND TRG:  
TRIGGER**

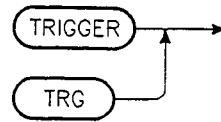

This program code starts a new measurement when the instrument sample rate is set to HOLD. If not in HOLD, the current measurement is aborted.

**C-51.  
Power Meter Mode  
Command Set**

**C-52.  
CL: CALIBRATE**

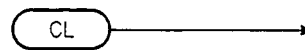

This program code has the same effect as pressing the **Calibrate** / Store Frequency key on the front panel; that is, it calibrates the Power Meter and any compatible power sensor to a 1 mW, 50 MHz reference.

**COMMENTS**

Zero the Power Meter before calibration.

A calibration takes less than 5 seconds. Perform calibration:

- when the power sensor is changed,
- after power-up,
- when the ambient temperature changes by more than 5°C, and
- after the INIT program code has been executed.

Any command (front panel or HP-IB) that is received during the calibration routine aborts the calibration and executes the function or the command received. If the calibration is interrupted by a command, the calibration must be done again in order to ensure calibrated readings.

If an HP 8484A Power Sensor with its associated HP 11708A Reference Attenuator is used, the front panel display reads 1.000  $\mu$ W instead of 1.000 mW.

When the Calibration function is used, the 50 MHz Power Reference Oscillator is automatically enabled for the duration of the calibration routine. After calibration is finished, the Power Reference Oscillator is returned to its previous state (either ON or OFF).

If the Status Byte is used to monitor the end of the calibration routine, the program string that initiated the calibration routine should start with the program code "CS". This will clear any previous setting of bit 3 (Cal/Zero Complete) to avoid an incorrect indication.

A Calibration Factor of 100% (true for HP 8481A, 8484A, and 8485A) is used during calibration routine.

C-53.  
CS: CLEAR POWER  
METER STATUS BYTE

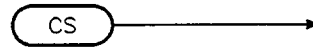

This program code clears the Power Meter bits 1, 3, and 7 in the Status Byte.

C-54.  
EN: ENTER NUMBER

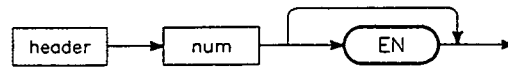

**NOTE**

*The use of the ENter program code is optional in the HP 5347A/48A.*

This program code is used to terminate a string of numeric data in the Data message part of the Manual Range functions.

To set parameters of the Manual Range functions, send the function code or command, followed by the numeric data, and terminate by the EN command code.

The example below is typical of the use of the EN command.

To enter the Power Meter's least sensitive fullscale power range (Range 5):

RM5EN

**C-55.  
LG: LOGARITHMIC  
(DBM) MODE**

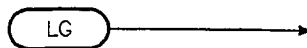

This program code has the same effect as pressing the **Input dBm/Watt** key on the front panel. It enters the instrument into the Power Meter mode, and sets the power measurement to be displayed or sent to the HP-IB, in dBm. LG can be used to enter the Power Meter mode from the Frequency Counter mode.

**C-56.  
LN: LINEAR (WATTS)  
MODE**

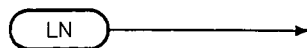

This program code has the same effect as pressing the **Input dBm/Watt** key on the front panel. It enters the instrument into the Power Meter mode, and sets the power measurement to be displayed or sent to the HP-IB, in Watts. LN can be used to enter the Power Meter mode from the Frequency Counter mode.

**C-57.  
MOD?: SEND POWER  
METER  
MEASUREMENT MODE  
(dBm or Watts)**

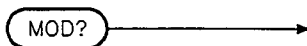

This program query returns the Power Meter measurement mode, dBm or Watts. The value returned is 0 or 1, where 0 is returned for Watts mode and 1 is returned for dBm mode.

**C-58.  
OC0/OC1: REFERENCE  
OSCILLATOR OFF/ON**

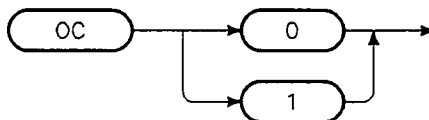

Switching the Oscillator OFF and ON is a feature that is only available via remote programming (HP-IB) of the HP 5347A/48A.

To disable the 1 mW, 50 MHz Power Reference Oscillator, send program code OC0. To enable the 1 mW, 50 MHz Power Reference Oscillator, send program code OC1.

Sending the "PR", "RESET", or "INIT" program codes, pressing the **Reset/Local** key, or powering OFF then On again also disables the 1mW, 50 MHz Power Reference Oscillator.

If the 50 MHz oscillator is enabled, the ZERO (ZE) function will automatically disable it for the duration of the zeroing routine. When zeroing is finished, the 50 MHz oscillator is re-enabled.



When the CALIBRATION (CL) function is used, the 50 MHz oscillator is automatically enabled for the duration of the calibration routine. If the oscillator is disabled when the CL function is activated, the oscillator will be enabled for the duration of the calibration routine. The oscillator will then be disabled.

**NOTE**

*The Power Reference Oscillator is temporarily turned off when the instrument is in the Frequency Counter mode.*

**C-59.  
OSC?: SEND  
OSCILLATOR STATUS**

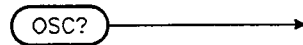

This program query returns the status of the 1 mW, 50 MHz Power Reference Oscillator. The value returned is 0 or 1, where 0 is returned when the oscillator is OFF and 1 is returned when the oscillator is ON.

**C-60.**  
**PERR?: SEND POWER**  
**METER ERROR**  
**NUMBER**

PERR? →

This program query returns the most recent Power Meter error number. If there is no error, the scientific-notated number "0E+00" is returned. If an error exists, a scientific-notated number from 2E+00 to 1E+01 is returned. The numbers 2E+00 through 1E+01 represent the following error messages:

Error Code	Error Message Displayed	Meaning	Action Required
2E+00	I/O 2 ERROR	Internal HP-IB Interface error.	HP 5347A/48A needs service.
3E+00	OUT OF RANGE 3 ERROR	Input number or value entered by the user is out of range.	Re-enter a value within the limit of the HP-IB command.
4E+00	SYNTAX 4 ERROR	HP-IB command syntax error.	Check program command.
5E+00	CAL ERROR 5 ERROR	Power Meter cannot calibrate the sensor.	Make sure power sensor is connected to a 1 mW 50 MHz source.
6E+00	CANNOT ZERO 6 ERROR	Power Meter cannot zero the sensor.	Ensure that no RF power is being applied to the sensor during zeroing.
7E+00	INPUT OVL 7 ERROR	Input overload on sensor.	Reduce input power to sensor.
8E+00	PLEASE ZERO 8 ERROR	Sensor zero reference has drifted.	Zero sensor; If error persists, check input power.
9E+00	UP RANGE 9 ERROR	Input power to sensor is too high for current range.	Select a higher range, reduce input power to sensor, or use autorange.
1E+01	NO SENSOR 10 ERROR	No sensor connected to the input.	Connect sensor.

**C-61.**  
**PR: PRESET**

PR →

Presetting the Power Meter is a feature that is only available via remote programming (HP-IB) of the HP 5347A/48A.

instrument remains in Power Meter mode after Preset. Preset conditions are shown in the following table:

PRESET Conditions	
Parameter	Condition
Power Reference Oscillator	Off
Range	Auto
dBm/Watt	dBm
Trigger Mode	Free Run

Calibration Factors remain unchanged after Preset.

**C-62.**  
**PTRG?: SEND POWER**  
**METER TRIGGER**  
**MODE**

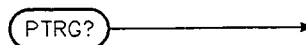

This program query returns the Power Meter trigger mode. The value returned is 0 or 1, where 0 is returned for free-run mode and 1 is returned for trigger-hold mode.

**C-63.**  
**RA: AUTO RANGE**

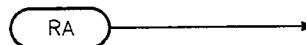

This program code switches the instrument's Power Meter from the Manual Range mode (described in Section C-63) to the Auto Range mode. In the Auto Range mode, the Power Meter automatically sets the number of readings averaged together to satisfy the filtering requirements for most power measurements. The Preset (PR), Initialization (INIT), and RESET program codes also set the Power Meter to Auto Range. When switching from remote to local operation, the Power Meter switches to Auto Range mode. Power OFF then ON will set instrument to Auto Range as well.

There is no front panel indication when the Power Meter is in Auto Range mode since this is the instrument's only mode of operation during local or front panel operation.

**C-64.**  
**RM{1-5}: MANUAL**  
**RANGE**

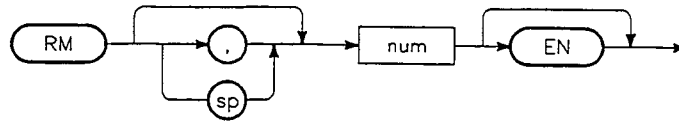

The Manual Range (RM) program code is a feature that is only available via remote programming (HP-IB) of the HP 5347A/48A.

This program code enables the sensor's power range to be selected manually. There are 5 ranges of 10 dB each that may be selected. Range 1 is the most sensitive (lowest power levels), and Range 5 is the least sensitive (highest power levels). Range 5 may be less than 10 dB if the sensor's power range is less than 50 dB.

The Power Meter uses a variable digital filter to average power readings. The number of readings averaged can range from 1 to 128 in binary progression. To change the number of readings averaged, send the RMn program code. The "n" value may be 1, 2, 3, 4, or 5. The integers 1 through 5 enable you to manually select the sensitivity level with which a power sensor will measure an input signal. The Manual Range command can be entered using any of the following syntaxes:

- RM2
- RM 2
- RM,2
- RM2EN

For most applications the Auto Range mode is the best mode of operation. Manual Range mode in the HP 5347A/48A is useful mainly for troubleshooting the Power Meter mode. RM is used often in the Power Meter troubleshooting procedures in Section 8 of the Service Manual.

**C-65.**  
**RNG?: SEND RANGE**  
**SETTING**

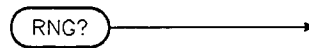

This program query returns the range setting. The value returned is between 01 and 05 for Manual Range settings, and between 11 and 15 for Auto Range settings. For example, 01 indicates Range 1 in the Manual Range mode, and 11 indicates Range 1 in the Auto Range mode.

C-66.  
SENSOR?: SEND  
SENSOR  
IDENTIFICATION  
NUMBER

SENSOR? →

This program query returns the rear panel power sensor switch setting. The value returned is "1" for the HP 8481A sensor, "4" for the HP 8484A sensor, and "5" for the HP 8485A sensor.

**C-67.  
SRE: SET POWER  
METER SERVICE  
REQUEST MASK  
VALUE**

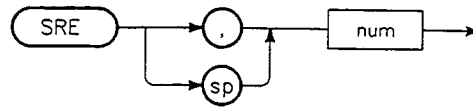

This program code sets the Power Meter Service Request Mask value to cause a Service Request (SRQ) whenever an enabled condition changes from 0 to 1 in the Power Meter Status Byte. To enable a condition, set the corresponding bit in the Service Request Mask to "1", and to disable, set the bit to "0", as shown below:

**POWER METER STATUS BYTE**

Binary	Decimal	Condition
1000 0000	128	Power Meter Measurement Error (05 - 10)
0X00 0000	64	RQS Flag
00X0 0000	32	Power ON
0001 0000	16	Local
0000 1000	8	Calibrate/Zero Complete
0000 0100	4	Instrument Error (02 - 04)
0000 0010	2	Power Meter Measurement Complete
0000 0001	1	Data Ready
0000 0000	0	No SRQ conditions enabled

Conditions may be enabled singly or in any combination desired. For example, setting binary 0000 1100 (decimal 12) will cause a SRQ if either a **Calibrate/Zero is completed** or an **instrument error** occurs.

Sending the "SRE,12" command to the HP 5347A/48A will cause the previously mentioned conditions (Cal/Zero Complete and Instrument Error) to generate a SRQ. The "12" value is the decimal equivalent to the binary sum of the bits that you want enabled (unmasked). The value may be any number between 0 and 255. Refer to Sections C-10 through C-16 for detailed information about the Service Request Masks and Status Bytes.

C-68.  
TR{0-3}: TRIGGERING

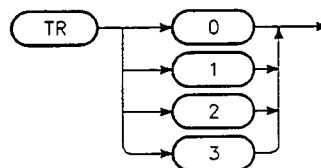

Triggering is a feature that is only available via remote programming (HP-IB) of the HP 5347A / 48A. The Power Meter has two main modes of triggered operation; trigger-hold mode and free-run mode. The trigger-hold mode means the Power Meter is making measurements, but the display and HP-IB are not updated until a trigger command is received. Free-run mode means that the Power Meter takes measurements and updates the display and HP-IB continuously. During the local operation the Power Meter is always in free-run mode. During remote operation the Power Meter can operate in either free-run mode or trigger-hold mode, and can be switched between modes at any time.

To obtain accurate measurements, ensure that the input power to the power sensor is settled before making a measurement. Four triggering program codes are available in remote mode: TR0, TR1, TR2, and TR3. TR3 puts the Power Meter into free-run mode. TR0, TR1, and TR2 put the Power Meter into the trigger-hold mode. These program codes or commands are detailed below:

**Trigger Hold (TR0).** Trigger Hold (TR0) is one of the three program codes available when the Power Meter is in trigger-hold mode. The TR0 program code is used to set up triggered measurements (initiated by program codes TR1, TR2, and the device independent Group Execute Trigger command). When in the trigger-hold mode the Power Meter continues to measure the input signal, but the display and HP-IB are not updated. When the Power Meter receives the Trigger Immediate (TR1) or Trigger with Delay (TR2) command, a measurement is taken and the display and HP-IB data is updated. Upon completion of the measurement the Power Meter remains in the trigger-hold mode.

When the Power Meter receives the Free Run (TR3) command, the trigger-hold mode is exited. The Power Meter will then make continuous measurements and update the display until placed back in the trigger-hold mode. The trigger-hold mode is also exited by returning the Power Meter to local operation using the Reset / Local key on the front panel, or by sending the "RESET", "PR", or "INIT" HP-IB commands. Upon leaving the trigger-hold mode, the front panel display is updated as the new measurement cycle begins.

When in the trigger-hold mode, the internal Power Meter settings can be altered by the user via the HP-IB. The instrument will issue the Status Byte if serial polled.

**Trigger Immediate (TR1).** When the Power Meter receives the Trigger Immediate (TR1) program code, it inputs one more data point into the digital filter, measures the reading from the filter, and then updates the display and HP-IB. (When the TR1 program code is executed, the internal digital filter is not cleared.) The Power Meter then waits for the measurement results to be read by the controller. While waiting, the Power Meter can process most bus commands without losing the measurement results.

When a Group Execute Trigger (GET) command is received, the Power Meter will execute the last type of trigger command sent (either a TR1 or TR2). If the last type of trigger command sent was TR0, then TR2 will be executed.

If the Power Meter receives a Trigger Immediate command and then receives the GET (Group Execute Trigger) command, the TR1 command will be aborted and a new measurement cycle will be executed. Once the measurement results are read onto the bus, the Power Meter always reverts to the trigger-hold mode. Measurement results obtained via the trigger-immediate function are normally valid only when the Power Meter is in a steady, settled state.

**Trigger with Delay (TR2).** Triggering with Delay is identical to Trigger Immediate except the Power Meter inserts a settling-time delay before taking the requested measurement. This settling time allows the internal digital filter to be updated with new values to produce valid, accurate measurement results. The Trigger with Delay (TR2) program code allows time for settling of the internal amplifiers and filters. It does not allow time for power sensor delay. (Note: the time delays vary with the range setting.)

In cases of large power changes, the delay may not be sufficient for complete settling. Accurate readings can be assured by taking two successive measurements for comparison.

Once the measurement results are displayed and read onto the bus, the Power Meter reverts to the trigger-hold mode.

**Free Run (TR3).** The Free Run (TR3) program code puts the instrument in the free-run mode during remote operation. Free-run mode is the default mode of operation and is identical to local operation. The measurement result data



available to the HP-IB and display is continuously updated as rapidly as the Power Meter can make measurements. Entry into local mode via the Reset/Local key sets the Power Meter to the free-run mode. The instrument returns to the Frequency Counter mode.

If the Trigger Immediate (TR1) or Trigger with Delay (TR2) program code is received while the Power Meter is in the free-run mode, the trigger function will be executed immediately. Upon completion of the trigger function, the Power Meter will enter the trigger-hold mode.

### COMMENTS

When either of the trigger program codes TR1 or TR2 is received by the Power Meter, a measurement is immediately initiated. Once the measurement is completed, some bus commands can be processed without aborting the measurement. However, any HP-IB program code sent to the Power Meter before the triggered measurement results have been completed will abort the trigger. Thus, trigger program codes should always appear at the end of a program string, and the triggered measurement results must be completed before any additional program codes that affect measurement are sent.

After receiving a trigger command, the response time to display a measurement depends on the range, the power sensor, and the trigger mode (TR2 versus TR1).

C-69.  
ZE: ZERO

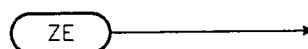

This program code has the same effect as pressing the Zero key on the front panel. It adjusts the Power Meter's internal circuitry for a "0" power indication when no power is applied to the sensor. Sending this command via the HP-IB, automatically zeroes all five of the Power Meter's ranges.

### COMMENTS

Ensure that no signal is applied to the sensor while the Power Meter is zeroing. Any applied RF input power will cause an erroneous reading or "CANNOT ZERO" will be displayed.

HP recommends that the Power Meter be zeroed before calibration.

The Power Meter's internal reference oscillator automatically turns OFF during zeroing. If the reference oscillator was ON

before zeroing was initiated it will be returned to the ON state when zeroing is completed.

To determine whether or not the Power Meter needs to be zeroed, remove any power to the sensor and read the front panel display. If the display is not within  $\pm 0.05 \mu\text{W}$ , zeroing is needed.

Any residual nonzero reading, if not corrected, will degrade the accuracy of subsequent measurements, resulting in an error. This error may be insignificant when measuring moderate to high power values, but it can be unacceptable when measuring low power values.

For remote (HP-IB) applications that require fast execution, the Cal/Zero Complete bit (bit 3) of the Power Meter Status Byte can be used. When the zeroing routine is initiated through the ZE command, bit 3 of the Status Byte should be monitored until it is set true. When bit 3 is set true, the zeroing routine is finished and the program can continue. If the Status Byte is to be used to monitor the end of the zeroing routine, the program string that initiated the zeroing routine should start with the program code "CS". This will clear any previous setting of bit 3 (Cal/Zero Complete) to avoid an incorrect indication. (Note: Any HP-IB command received during the zeroing process will abort the zeroing, leaving unpredictable results.)

For best accuracy, HP 8484A Power Sensors should be connected to a device with the RF power OFF before zeroing.

Zeroing data is remembered after the "RESET" and "PR" program codes are sent or after the Reset/Local key is pressed, but will default to power-up values after the "INIT" program code is sent.

#### **NOTE**

---

*If the 10 MHz External Reference input is connected or disconnected after zeroing has been performed, the Power Meter must be re-zeroed.*

---

PLEASE ZERO (Error 08) is displayed when the zero reference drifts below 0.0V.

**C-70.**  
**Commands Common**  
**to Both Measurement**  
**Modes**

**NOTE**

Since the "RESET", "CLR", and "INIT" program codes clear the input buffers, they should be sent so that no new input will be handshaken in until the last program code is processed. Typically, this means the program code should be sent by itself as a separate command, shown in the following examples:

```
OUTPUT 714; "RESET"  
OUTPUT 714; "CLR"  
OUTPUT 714; "INIT"
```

Placing the program code at the end of a string of commands, as shown below, would have the same effect:

```
OUTPUT 714; "AUTO; RESET"  
OUTPUT 714; "AUTO; CLR"  
OUTPUT 714; "AUTO; INIT"
```

**C-71.**  
**CLR: INSTRUMENT**  
**CLEAR**

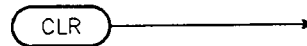

This program code performs some similar functions as the Reset/Local key when the instrument is in local mode. The current measurement cycle is aborted, errors are cleared, input and output buffers are cleared, and any partially entered sequence of HP-IB commands is aborted. The CLR program code is different from the RESET program code in that it doesn't reset the Measurement mode, the Power Reference Oscillator state, the Power Meter trigger mode, the Power Meter range, Sample Rate, Dump mode, or Sleep mode.

**NOTE**

After a CLR program code is sent the instrument does not change from the Frequency Counter mode to the Power Meter mode, or vice versa.

**C-72.**  
**DIAGENT: ENTER**  
**DIAGNOSTICS MODE**

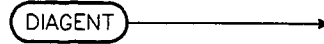

This program code switches the HP 5347A/48A from the normal (Measurement) mode to the Diagnostics mode. While the instrument is in the Diagnostics mode, only diagnostics commands (listed in *Table C-14*) are recognized by the HP 5347A/48A. To exit Diagnostics mode and return to the Measurement mode, the program code "MEASENT" should be sent (see description of the MEASENT command in Section C-84).

The DIAGENT command puts the instrument in the same operating mode as powering up the instrument with the rear panel DIP switch set for diagnostics. "DIAG 01" is displayed.

A syntax error will be indicated when the diagnostics commands are sent while the HP 5347A/48A is in the Measurement mode.

**C-73.**  
**DISPLAY: DISPLAY**  
**MESSAGE/CONCEAL**  
**MESSAGE**

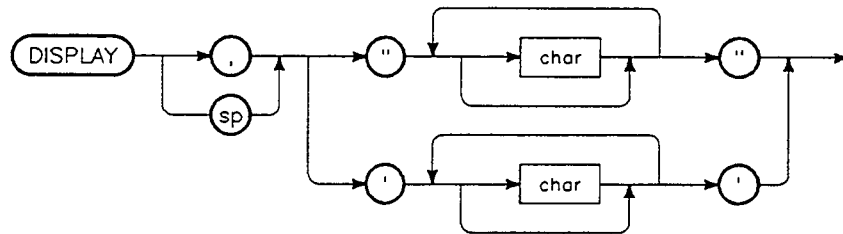

This program code allows an arbitrary string of up to 24 uppercase letters, numbers, or punctuation marks to be displayed on the front panel Liquid Crystal Display (LCD). The string follows the command, and should be enclosed in quotes. Embedded string delimiters are not allowed.

Thus, to display a single quote, the string must be surrounded by double quotes. To display a double quote, the string must be delimited by single quotes. Embedded spaces, commas, and semicolons are allowed. Periods are combined with the characters to the left, when displayed, so they are not counted in the 24-character limit. Up to 48 characters, including periods, will be accepted without error, but only the first 24 characters are displayed. The remainder of the string is ignored. The string is left-justified in the display area. Extra places are filled with blanks.

To turn off the message and return to normal display, a null (empty) string is sent. The "INIT" program code also turns off the remote display. To blank the display, a single blank, " ", may be sent.

The "DISPLAY" program code supersedes all others while it is enabled, providing "display concealment". No measurements or error messages will be displayed while the remotely provided string is active. If the user goes to Local by pressing the Reset/Local key, the remote message remains displayed.

**C-74.  
ID?: SEND  
INSTRUMENT  
IDENTIFICATION**

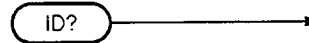

This program query returns the instrument identification as a 14-character string containing the company name acronym (HP), the model number (5348A), and the revision code (year since 1960, and week). For example, "HP,5348A,,2907".

**C-75.  
INIT: COMPLETE  
INSTRUMENT  
INITIALIZATION**

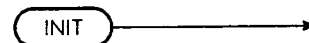

This program code sets the instrument to the same state as the power-up state; except, the HP-IB Interface and MODE (Diagnostics or Measurement) are not initialized. The resolution will be reset based on the rear panel RES switch setting. The INIT program code resets the calibration variables and the stored frequency, and returns the instrument to the Frequency INPUT 1, Auto mode. The sensor will be reset based on the rear panel SENSOR TYPE switch setting.

**NOTE**

*After Initialization, since all calibration variables are reset, the user needs to perform the zero and calibration functions to ensure the correct reading.*

\* NOTE: Sending a null string causes the instrument to internally execute a "RESET" command.

**C-76.**  
**KEY?: SEND NUMBER**  
**OF KEY PRESSED**

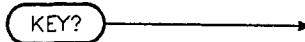

This program query returns a number corresponding to the last key pressed, as shown below:

KEY CODE	KEY NAME
0	No key pressed
1	Input 1
2	Calibrate/Store
3	Input 2
4	Input dBm/Watts
7	Reset
8	Zero

**C-77.**  
**RESET**

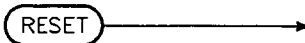

This program code performs the same function as the **Reset/Local** key on the front panel. It returns the instrument to the power-up measurement mode, clears errors, clears I/O buffers, aborts current measurement, aborts partially entered key sequence or HP-IB command. Does not exit diagnostics mode. Does not affect resolution and sensor settings. Exits Sample Hold mode, Sleep mode and Dump mode. The RESET conditions for both the Counter and Power Meter modes are shown in the following table:

**RESET Conditions**

Parameter	Condition
<b>Frequency Counter mode</b>	
Input 1	Auto mode
Input 2	Off
<b>Power Meter mode</b>	
Power Reference Oscillator	Off
Range	Auto
dBm/Watt	dBm
Trigger Mode	Free Run
Calibration variables and stored frequency	Remain unchanged*
* NOTE: Input 2 stored frequencies are cleared and power measurements return to using average calibration factors.	

**C-78.**  
**SET: RECALL/SET**  
**INSTRUMENT SETUP**

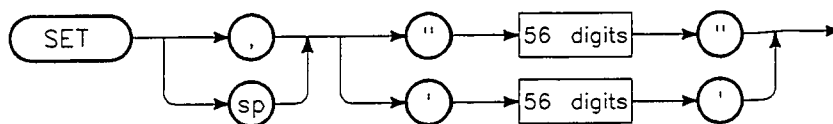

This program code sets up the instrument according to the data passed. The data is determined by a previous instrument setup saved using the "SET?" query command. By using the SET? (send/save) and SET (recall) commands together different configurations may be saved, then recalled with a single command.

Measurement results are not saved.

Refer to the description of the "SET?" query in Section C-78, below for more information concerning the "SET" data string.

**C-79.**  
**SET?: SEND/SAVE**  
**CURRENT**  
**INSTRUMENT SETUP**

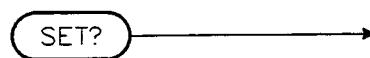

This program query returns the current instrument setup data in a 56-digit format. The 56-digit string contains data that will be used by the SET command to reconfigure the measurement mode, such as Input 1 auto or manual, Input 2 high input impedance or low input impedance, or Power Meter linear or logarithmic. The string of data also contains data for the SET command to reconfigure the Power Meter; for example, oscillator status, trigger, and range. The data can be fetched, saved, then recalled by the combined use of the SET? and SET commands as demonstrated in the Programming Example #13 in Section C-85 (Programming Examples).

**C-80.**  
**Diagnostics Mode**  
**Command Set**

**NOTE**

*“RESET”, “CLR”, and “INIT” program codes are additional commands that can be sent when the HP 5347A/48A is in the Diagnostics mode. Refer Sections C-77, C-71, and C-75 for the descriptions of these program codes.*

**C-81.**  
**DIAG: DIAGNOSTICS**

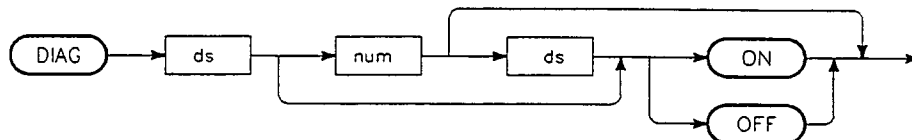

This program code can be used to set up most of the diagnostics over the HP-IB. All diagnostics except Diagnostics 1, 41, 42, 43, 44, 80 and 97 are available over the bus. Some diagnostics return data over the bus; other diagnostics require an oscilloscope or additional equipment. To get a diagnostic result from the HP 5347A /48A, you must send the “DIAG?” query.

Example DIAG command: DIAG,32,ON – This command string runs Diagnostic 32, which checks the Interpolator circuit on the A3 Counter Assembly. DIAG,OFF causes the HP 5347A /48A to exit or stop a Diagnostic test.

**NOTE**

*Diagnostic failures are not treated as errors (i.e., the error bit in the serial poll is not set by a failed diagnostic).*

**C-82.**  
**DIAGPARM: Diagnostic**  
**Parameter**

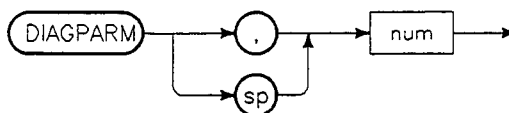

This program code is used to send the parameter required by Diagnostic 51 (LO Synthesizer Verification – User-Entered Frequency) after the “DIAG” program code is sent. As many “DIAGPARM” program codes as necessary can be entered immediately after Diagnostic 51 is enabled (by sending “DIAG,51” command). Example of DIAGPARM command: “DIAGPARM, 3105” — where 3105 is a frequency of 310.5 MHz.



**NOTE**

Do NOT enter a decimal point with a frequency value (i.e., enter "3105" not "310.5" for 310.5 MHz).

**C-83.  
DIAG?: SEND  
DIAGNOSTIC RESULT**

DIAG? →

This program query returns the current diagnostic result to the controller. The data returned consists of 24 ASCII characters arranged in a format similar to the front panel display that would appear for that diagnostic in local mode (except that no decimals are sent over the bus). Some of the results include measurements, such as the IF result in Diagnostic 2. These measurements can be extracted from the pass/fail result by controller software.

**C-84.  
MEASENT: ENTER  
MEASUREMENT MODE**

MEASENT →

This program code switches the HP 5347A/48A from the Diagnostics mode to the power-up Measurement mode; that is, Measurement-Frequency Counter, INPUT 1 mode. While the instrument is in the Measurement mode it recognizes only the appropriate measurement commands and HP-IB status commands.

A syntax error will be indicated when measurement commands are sent while the HP 5347A/48A is in the Diagnostics mode.

**C-85.  
PROGRAMMING  
EXAMPLES**

The following pages contain programming examples for the HP 5347A/48A. The examples shown are written in BASIC 4.0 for HP 9000 Series 200/300 Computers.

**FREQUENCY COUNTER EXAMPLES**

**Example Program #1 (CW Measurement):**

```

10 DIM F$(24)
20 REMOTE 714
30 OUTPUT 714;"SAMPLE,FAST"
40 FOR K=1 TO 10
50     ENTER 714;F$
60     PRINT K;F$
70 NEXT K
80 LOCAL 714
90 END
    
```

**Example #1 Description:**

This program configures the HP 5347A/48A for remote operation, and sets the sample rate to take measurements as fast as possible. Ten measurements are taken; after each measurement, the measurement data is entered into a string and the string content is printed out by the controller. After the 10 measurements have been taken, the instrument is returned to local operation.

**Example Program #2 (CW Measurement with Trigger):**

```

10 DIM F$(24)
20 REMOTE 714
30 OUTPUT 714;"SAMPLE,HOLD"
40 FOR K=1 TO 10
50     OUTPUT 714;"TRIGGER"
60     ENTER 714;F$
70     PRINT K;F$
80 NEXT K
90 LOCAL 714
100 END
    
```

**Example #2 Description:**

This program configures the HP 5347A/48A for remote operation, and sets the sample rate to wait indefinitely until triggered. The instrument is triggered 10 times; at each measurement, the measurement data is entered into a string, and the string content is printed out by the controller. After 10 triggered measurements, the instrument is returned to local operation.

**Example Program #3 (Timebase Verification):**

```

10 DIM D$[24]
20 REMOTE 714
30 OUTPUT 714;"DIAGENT"
40 OUTPUT 714;"DIAG,10"
50 OUTPUT 714;"DIAG?"
60 ENTER 714;D$
70 PRINT D$
80 OUTPUT 714;"DIAG,OFF"
90 OUTPUT 714;"MEASENT"
100 LOCAL 714
110 END

```

**Example #3 Description:**

This program configures the HP 5347A/48A for remote operation, and turns on Diagnostic 10 (Timebase Verification). The controller sends a query to the instrument, and the diagnostic result is entered into a string. The controller prints the string content, turns the diagnostic off, and then returns the instrument to local operation.

**Example Program #4 (Display Message):**

```

10 DIM D$[24]
20 REMOTE 714
30 D$="REMOTE MESSAGE"
40 OUTPUT 714;"DISPLAY,'"";D$;"'"
50 WAIT 2
60 OUTPUT 714;"DISPLAY,'" "
70 LOCAL 714
80 END

```

**Example # 4 Description:**

This program configures the HP 5347A/48A for remote operation, and sets up a string containing a 14-character message. The controller sends the DISPLAY command to the instrument, with the message to be displayed. The "REMOTE MESSAGE" is displayed on the instrument's front panel Liquid Crystal Display for two seconds, after which a blank is sent to the instrument to clear the display. The instrument is then returned to local. Note the use of double and single quotes in the message to be displayed. The instrument requires that the data sent with the DISPLAY command be delimited by quotes. In this case, the data (D\$) is delimited by single quotes. In line 40 of the program three strings are joined (using semicolons) to form the command to the instrument: "DISPLAY,'REMOTE MESSAGE'".

### Example Program #5 (Set/Return Status Byte for Counter)

```
10  Mask=4+2
20  REMOTE 714
30  OUTPUT 714;"SRQMASK,"&VAL$(Mask)
40  P=SPOLL(714)
50  PRINT P
60  LOCAL 714
70  END
```

#### Example #5 Description:

This program assigns a decimal value of 6 (4+2) to the variable "Mask". The HP 5347A /48A is then set to remote, and the SRQMASK command is sent, along with the decimal value. The value of 6 enables the Error bit and the Measurement Complete bit in the status byte as conditions to generate a SRQ, if one or both of the conditions occurs. The controller next takes a serial poll of the instrument, and assigns the value of the received status byte to the variable "P". The controller prints the status byte contents, and then returns the instrument to local.

**Example Program #6 (Dump Mode Measurement):**

```
10 DIM F(100)
20 REMOTE 714
30 OUTPUT 714;"AUTO"
40 OUTPUT 714;"RESOL,4"
50 OUTPUT 714;"DUMP, ON"
60 !
70 FOR K=1 TO 100
80 Meas_again: !
90 ENTER 714;F(K)
100 IF F(K)=0 THEN GOTO Meas_again
110 NEXT K
120 !
130 OUTPUT 714;"DUMP, OFF"
140 FOR K=1 TO 100
150     Freq=F(K)*10000
160     PRINT K,Freq;"HZ"
170 NEXT K
180 !
190 LOCAL 714
200 END
```

**Example #6 Description:**

This program configures the HP 5347A /48A for remote operation, Auto measurement mode is selected, and resolution is set to 10 kHz. The DUMP mode is then turned on. The controller triggers a series of 100 measurements and the results are entered into an array. The content of each element in the array is multiplied by 10,000, and printed out by the controller (in Hz units). Finally, the instrument is returned to local operation.

**Example Program #7 (Manual Dump Mode Measurement):**

```
10 DIM F(100)
20 REMOTE 714
30 OUTPUT 714;"MANUAL,4E+9"
40 OUTPUT 714;"RESOL,4"
50 OUTPUT 714;"DUMP, ON"
60 !
70 FOR K=1 TO 100
80 Meas_again: !
90 ENTER 714;F(K)
100 IF F(K)=0 THEN GOTO Meas_again
110 NEXT K
120 !
130 OUTPUT 714;"DUMP, OFF"
140 FOR K=1 TO 100
150 G=F(K)*10000
160 PRINT K,G;"Hz"
170 NEXT K
180 !
190 LOCAL 714
200 END
```

**Example #7 Description:**

This program configures the HP 5347A / 48A for remote operation, followed by commands to enable the DUMP mode with the instrument set for a Manual measurement: Manual measurement mode is selected (with a chosen frequency of 4 GHz), sample rate for the fastest possible measurements, and resolution for 10 kHz. The DUMP mode is then turned on. The controller enters the data from a series of measurements into 100 strings, after which the DUMP mode is turned off. The controller triggers a series of 100 measurements and the results are entered into an array. The content of each element in the array is multiplied by 10,000, and printed out by the controller (in Hz units). Finally, the instrument is returned to local operation.

**Example Program #8 (Set Measurement Complete to cause SRQ Interrupt):**

```
10 DIM F$(24)
20 REMOTE 714
30 OUTPUT 714;"SAMPLE,HOLD"
40 OUTPUT 714;"SRQMASK,6"
50 ON INTR 7 CALL Display
60 ENABLE INTR 7;2
70 !
80 OUTPUT 714;"TRIGGER"
90 FOR K=1 TO 20
100   WAIT .10
110 NEXT K
120 LOCAL 714
130 END
140 !
150 SUB Display
160 S=SPOLL(714)
170 PRINT "STATUS = ";S
180 ENTER 714;F$
190 PRINT "MEASURED;";F$;" Hz"
200 ENABLE INTR 7;2
210 SUBEXIT
220 SUBEND
```

**Example #8 Description:**

This program illustrates the use of interrupts to detect the end of a measurement. The HP 5347A/48A sample rate is set to HOLD so that a triggered measurement may be made. The Measurement Complete bit and Instrument Error bit of the Frequency Counter Service Request Masks are enabled as conditions to cause a service request (SRQ). The controller is set up to call a subroutine ("Display") to handle the SRQ interrupt when it occurs. The instrument is triggered and begins a measurement. A two second wait loop is executed during which the instrument completes the measurement and causes a SRQ interrupt. The Display subroutine is called; this subroutine proceeds to read and print the serial poll status byte and the just completed measurement. (If error condition exists, "1E+38" will be printed as the last measurement.) The Measurement Complete bit in the status byte is automatically cleared after the serial poll. The subroutine sets up the controller to accept interrupts, and then returns to the main program. When the wait loop is finished, the instrument is returned to local.

## POWER METER EXAMPLES

### Example Program #9 (Free-Run Power Measurement):

```
10 DIM F$(24)
20 REMOTE 714
30 OUTPUT 714;"LN"
40 OUTPUT 714;"TR3"
50 FOR K=1 TO 10
60 ENTER 714;F$
70 PRINT K;F$
80 NEXT K
90 LOCAL 714
100 END
```

### Example #9 Description:

This program configures the HP 5347A/48A for remote operation, puts the instrument into Power Meter mode, and sets the triggering to free-run mode. Ten measurements are taken. The measurement data is entered into a string and the string content is printed. After ten measurements have been taken, the instrument is returned to local operation.



**Example Program #10 (Trigger-Hold Power Measurement):**

```

10 DIM F$(24)
20 REMOTE 714
30 OUTPUT 714;"LN"
40 OUTPUT 714;"TR0"
50 FOR K=1 TO 10
60   OUTPUT 714;"TR2"
70   Meas_comp_wait:WHILE BIT (SPOLL(714),1)=0
80     GOTO meas_comp_wait
90   END WHILE
100  Data_ready_wait:WHILE BIT(SPOLL(714),0)=0
110    GOTO Data_ready_wait
120  END WHILE
130  ENTER 714;F$
140  PRINT K;F$
150 NEXT K
160 LOCAL 714
170 END

```

**Example #10 Description:**

This program configures the HP 5347A / 48A for remote, puts the instrument into Power Meter mode, and sets the Power Meter trigger-hold mode (TR0) before trigger delay (TR2) command. (Measurement time can vary from 1 to 10 seconds depending on range. The program must wait for Measurement Complete bit, then Data Ready bit before reading new data.) Ten measurements are taken; after each measurement, the measurement data is entered into a string and the string content is printed. After ten measurements have been taken, the instrument is returned to local operation.

**Example Program #11 (Set/Return Status Byte for Power Meter):**

```

10 Pmask=2+8
20 REMOTE 714
30 OUTPUT 714;"LG"
40 OUTPUT 714;"SRE," &VAL$(Pmask)
50 P=SPOLL(714)
60 PRINT P
70 LOCAL 714
80 END

```

**Example #11 Description:**

This program configures the HP 5347A / 48A for remote operation, puts the instrument into Power Meter mode, enables (unmasks) the Measurement Complete and Cal/Zero Complete bits in the Status Byte by sending the SRQ mask (SRE) command, reads the Status Byte with a serial poll (SPOLL), and prints the Status Byte value. Finally, the instrument is returned to local operation.

**Example Program #12 (Zeroing):**

```
10  REMOTE 714
20  OUTPUT 714;"LG"
30  !PROGRAM 'ZERO_5348A'
40  !
50  CALL Zero_5348a(714,Err)
60  IF Err=0 THEN
70  PRINT "ZERO SUCCESSFUL"
80  ELSE
90  PRINT "ZERO UNSUCCESSFUL"
100 END IF
110 END
120 SUB Zero_5348a(Hpib_address,Err)
130 !
140 !3/2/89:SIMPLE SUBROUTINE TO ZERO THE 5348A POWER METER.
150 !IF ERR=0, THEN ZEROING WAS SUCCESSFUL.
160 !IF ERR=1, THEN ZEROING WAS UNSUCCESSFUL.
170 !
180 OUTPUT Hpib_address;"CS"
190 Time_zero=TIMEDATE
200 OUTPUT Hpib_address;"ZE"
210 I=1
220 WHILE I
230 Deltat=TIMEDATE-Time_zero
240 P=SPOLL(Hpib_address)
250 IF Deltat >=30 OR BIT (P,7) THEN
260 Err=1
270 I=0
280 END IF
290 IF BIT (P,3) THEN
300 Err=0
310 I=0
320 END IF
330 END WHILE
340 SUBEND
350 !
```

**Example #12 Description:**

This program configures the HP 5347A/48A for remote mode, puts the instrument into Power Meter (dBm) mode, and initiates the Zero routine and prints whether the zeroing was successful or unsuccessful. Lines 120 through 350 comprise a subroutine that contains the zeroing routine. Lines 30 through 110 run the subroutine and print the result.

**Example Program #13 (Set/Return Instrument Setup for Power Meter):**

```
10 DIM S$(60)
20 REMOTE 714
21 OUTPUT 714;"LG"
30 OUTPUT 714;"RM,5;TR1"
31 OUTPUT 714;"SET?"
40 ENTER 714;S$
50 DISP S$
60 OUTPUT 714;"INIT"
70 OUTPUT 714;"SET,'"';S$;"'"
80 END
```

**Example #13 Description:**

This program configures the HP 5347A/48A for remote mode, puts the instrument into Power Meter mode. The Power Meter input amplifier is set to its highest range, trigger is set to trigger immediate. The status of the Power Reference Oscillator, Measurement mode, and the range and trigger for the Power Meter are sent to the controller via the "SET?" query command, saved to string S\$ by the "ENTER" command, and displayed on the controller screen by the "DISP" command. After the instrument is initialized, the previous instrument setup (Range 5, immediate triggering) is recalled by the "SET" command.



# Index

## A

accessories ..... 1-4  
Address switch ..... C-2  
Annunciators ..... 3-11

## B

Battery disposal ..... A-13  
battery pack ..... 1-1

## C

**Calibrate/Store key** ..... 2-9  
Calibrating ..... 2-10, 2-12  
Calibration cycle ..... 4-2  
Clearing errors ..... C-29  
Command headers ..... C-21  
Command separators ..... C-20, C-22  
Connectors  
    External reference input ..... 3-13  
    HP-IB ..... 3-19  
    Input 1 ..... 3-14  
    Input 2 ..... 3-14  
    Power Reference ..... 3-15  
    Power Sensor ..... 3-15

## D

Data ..... C-19  
Data separators ..... C-19, C-23  
Diagnostics mode ..... 3-23  
Diagnostics operating mode ..... C-30  
DIP switch ..... 3-8, 3-16  
ds ..... C-19, C-23

## E

Equipment required  
    performance tests ..... 4-1  
Error handling via HP-IB ..... C-29  
Error Messages ..... 3-21, 3-22

## F

Frequency Counter keys ..... 3-6  
Frequency Counter mode ..... 3-2  
    SRQ mask ..... C-17  
    status byte ..... C-13  
Frequency Counter mode checks ..... 4-5  
Frequency Counter mode tests ..... 4-14  
Frequency Counter self tests ..... 3-4  
**Frequency measurements** ..... 2-8, 3-1  
Frequency Range ..... 1-1, 3-1  
Front Panel display ..... 3-10

## H

Headers ..... C-19  
HP-IB address ..... C-2  
HP-IB annunciators ..... C-11  
HP-IB command  
    DIAG? ..... C-27  
    PERR? ..... C-30  
    RNG? ..... C-48  
    SRE ..... C-18  
HP-IB command flow ..... C-31  
HP-IB command syntax ..... C-19  
HP-IB commands  
    AUTO ..... C-35  
    CL ..... C-42  
    CLR ..... C-55  
    CS ..... C-43  
    device dependent ..... C-6

device independent.....	C-6
DIAG.....	C-60
DIAG?.....	C-61
DIAGENT.....	C-56
DIAGPARM.....	C-60
DISPLAY.....	C-56
DUMP.....	C-35
EN.....	C-43
ERR?.....	C-30, C-37
HIGHZ.....	C-37
ID?.....	C-57
INIT.....	C-57
KEY?.....	C-58
LG.....	C-44
LN.....	C-44
LOWZ.....	C-37
MANUAL.....	C-38
MEASENT.....	C-61
meta message.....	C-8
MOD?.....	C-44
OC.....	C-44
OSC?.....	C-45
PERR?.....	C-46
PRESET.....	C-46
PRTG?.....	C-47
RA.....	C-47
REF?.....	C-38
RESET.....	C-55
RESOL.....	C-39
RM.....	C-48
SAMPLE.....	C-39
SENSOR?.....	C-49
SET.....	C-59
SET?.....	C-59
SLEEP.....	C-39
SRE.....	C-50
SRQMASK.....	C-17, C-40
STORE.....	C-41
TR.....	C-51
TRG.....	C-42
TRIGGER.....	C-42
ZE.....	C-53
HP-IB data input format.....	C-18
HP-IB data output format.....	C-26
HP-IB option.....	3-23
HP-IB query output formats.....	C-29
HP-IB verification program.....	4-1, 4-35

**I**

Input 1	
connector.....	2-7
key.....	2-7
Input 1 key.....	3-5
Input 2	
connector.....	2-7
key.....	2-7
Input dBm/Watt key.....	2-9, 3-5
Interface capabilities.....	C-3

**K**

Keyboard.....	2-1, 3-1
---------------	----------

**M**

Manual organization.....	1-1
Measurement power meter operating mode.....	C-30
Measurement-counter operating mode.....	C-30

**O**

Operational verification.....	4-1, 4-4
Optional battery pack.....	1-1
Optional HP-IB Interface Assembly.....	1-1
options.....	1-4

**P**

Performance tests.....	4-1, 4-4
Power	
AC line.....	2-2, 3-17
battery.....	3-18
Battery (option).....	2-2
External DC.....	3-18
<b>Power Measurement.....</b>	2-2
Power Meter keys.....	3-5
Power Meter mode.....	3-3
SRQ mask.....	C-18
status byte.....	C-14
Power Meter mode checks.....	4-11
Power Meter mode tests.....	4-25

Power Meter self tests.....	3-4
Power meter trigger modes	
free-run mode .....	C-51
trigger-hold.....	C-51
Power Range .....	1-1, 3-1, 3-3, 3-7
Power reference connector.....	3-3
Power sensors .....	2-9, 3-7
Power-up self test.....	3-1
Power-up sequence .....	2-5
Program codes .....	C-6, C-21
Programming examples .....	C-62

**Q**

Queries.....	C-6
--------------	-----

**R**

Rear Panel	
DIP switch .....	3-2
HP-IB Address switch .....	3-19
TCXO adjustment .....	3-19
Reference 50 MHz .....	3-3
Reset/Local key .....	3-5

**S**

Selecting HP-IB address .....	C-2
Self test.....	2-5
Self tests .....	3-3
Serial poll.....	C-12
Service Accessories Kit.....	1-5
Service Manual .....	1-2
Service Request.....	C-11
Setting and clearing status byte bits .....	C-15
sp .....	C-23
Specifications .....	B-1
Status byte.....	C-11

**V**

Verification program .....	4-1
----------------------------	-----

**Z**

Zero key.....	2-9, 3-7
Zeroing .....	2-10



HEWLETT®  
PACKARD



Manual Part Number: 05348-90025



Printed on recycled paper.

Printed in U.S.A.  
December 1995

