Caution

Use the following procedure when turning off the 42841A:

1. Turn off the DC bias current output.
2. Disconnect a DTU (Device Under Test) from the test fixture.
3. Turn off the 42841A LINE ON/OFF switch.

If turning off the 42841A power with a DUT connected, the 42841A internal circuit may be damaged.

Herstellerbescheinigung

GERÄUSCHEMISSION

LpA < 70 dB
am Arbeitsplatz
normaler Betrieb
nach DIN 45635 T. 19

Manufacturer's Declaration

ACOUSTIC NOISE EMISSION

LpA < 70 dB
operator position
normal operation
per ISO 7779



Agilent Technologies
Innovating the HP Way

DECLARATION OF CONFORMITY

According to ISO/IEC Guide 22 and CEN/CENELEC EN 45014

Manufacturer's Name: Agilent Technologies Japan, Ltd.
Manufacturer's Address: Component Test PGU-Kobe
1-3-2, Murotani, Nishi-ku, Kobe-shi,
Hyogo, 651-2241 Japan

Declares, that the product

Product Name: Bias Current Source
Model Number: 42841A
Product Options: All options and customized products based on the above

Is in conformity with:

EMC European Council Directive 89/336/EEC and carries the CE-marking accordingly
EMC Standards required by the Australia Radio Communications Act
IEC 61326-1:1997+A1 / EN 61326-1:1997+A1
CISPR 11:1990 / EN 55011:1991 / AS/NZS 2064.1- Group 1 Class A ^[1]
IEC 61000-4-2:1995 / EN 61000-4-2:1995 (4 kV CD, 8 kV AD)
IEC 61000-4-3:1995 / EN 61000-4-3:1996 (3 V/m 80% AM 27 - 1000 MHz)
IEC 61000-4-4:1995 / EN 61000-4-4:1995 (1 kV power line, 0.5 kV Signal line)
IEC 61000-4-5:1995 / EN 61000-4-5:1995 (0.5 kV line-line, 1 kV line-earth)
IEC 61000-4-6:1996 / EN 61000-4-6:1996 (3 V 80% AM, power line)
IEC 61000-4-11:1994 / EN 61000-4-11:1994 (100% 1cycle)

Safety European Council Directive 73/23/EEC and carries the CE-marking accordingly
IEC 61010-1:1990+A1+A2 / EN 61010-1:1993+A2

Additional Information:

LEDs in this product are Class 1 in accordance with EN 60825-1:1994.

^[1] The product was tested in a typical configuration.

Dec. 15, 1999

Date

Name Yukihiro Ota / Quality Engineering Manager

For further information, please contact your local Agilent Technologies sales office, agent or distributor.

Safety Summary

When you notice any of the unusual conditions listed below, immediately terminate operation and disconnect the power cable.

Contact your local Agilent Technologies sales representative or authorized service company for repair of the instrument. If you continue to operate without repairing the instrument, there is a potential fire or shock hazard for the operator.

- Instrument operates abnormally.
- Instrument emits abnormal noise, smell, smoke or a spark-like light during the operation.
- Instrument generates high temperature or electrical shock during operation.
- Power cable, plug, or receptacle on instrument is damaged.
- Foreign substance or liquid has fallen into the instrument.

Agilent 42841A BIAS CURRENT SOURCE OPERATION MANUAL

SERIAL NUMBERS

This manual applies directly to instruments with serial number prefix 2915J

For additional important information about serial numbers, read “Serial Number” in Chapter 4 of this Manual.

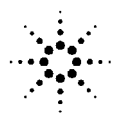

Agilent Technologies

**Agilent Part No. 42841-90010
Printed in JAPAN March 2000**

Fifth Edition

Notice

The information contained in this document is subject to change without notice.

This document contains proprietary information that is protected by copyright. All rights are reserved. No part of this document may be photocopied, reproduced, or translated to another language without the prior written consent of the Agilent Technologies.

Agilent Technologies Japan, Ltd.
Component Test PGU-Kobe
1-3-2, Murotani, Nishi-ku, Kobe-shi,
Hyogo, 651-2241 Japan

Manual Printing History

The manual printing date and part number indicate its current edition. The printing date changes when a new edition is printed. (Minor corrections and updates that are incorporated at reprint do not cause the date to change.) The manual part number changes when extensive technical changes are incorporated.

April 1989First Edition (part number: 42841-90000)

April 1991Second Edition (part number: 42841-90000)

December 1991Third Edition (part number: 42841-90000)

December 1996Fourth Edition (part number: 42841-90000)

March 2000Fifth Edition (part number: 42841-90010)

Certification

Agilent Technologies certifies that this product met its published specifications at the time of shipment from the factory. Agilent Technologies further certifies that its calibration measurements are traceable to the United States National Institute of Standards and Technology, to the extent allowed by the Institution's calibration facility, or to the calibration facilities of other International Standards Organization members.

Warranty

This Agilent Technologies instrument product is warranted against defects in material and workmanship for a period of one year from the date of shipment, except that in the case of certain components listed in *General Information* of this manual, the warranty shall be for the specified period. During the warranty period, Agilent Technologies will, at its option, either repair or replace products that prove to be defective.

For warranty service or repair, this product must be returned to a service facility designated by Agilent Technologies. Buyer shall prepay shipping charges to Agilent Technologies and Agilent Technologies shall pay shipping charges to return the product to Buyer. However, Buyer shall pay all shipping charges, duties, and taxes for products returned to Agilent Technologies from another country.

Agilent Technologies warrants that its software and firmware designated by Agilent Technologies for use with an instrument will execute its programming instruction when properly installed on that instrument. Agilent Technologies does not warrant that the operation of the instrument, or software, or firmware will be uninterrupted or error free.

Limitation Of Warranty

The foregoing warranty shall not apply to defects resulting from improper or inadequate maintenance by Buyer, Buyer-supplied software or interfacing, unauthorized modification or misuse, operation outside the environmental specifications for the product, or improper site preparation or maintenance.

No other warranty is expressed or implied. Agilent Technologies specifically disclaims the implied warranties of merchantability and fitness for a particular purpose.

Exclusive Remedies

The remedies provided herein are buyer's sole and exclusive remedies. Agilent Technologies shall not be liable for any direct, indirect, special, incidental, or consequential damages, whether based on contract, tort, or any other legal theory.

Assistance

Product maintenance agreements and other customer assistance agreements are available for Agilent Technologies products.

For any assistance, contact your nearest Agilent Technologies Sales and Service Office. Addresses are provided at the back of this manual.

Safety Summary

The following general safety precautions must be observed during all phases of operation, service, and repair of this instrument. Failure to comply with these precautions or with specific *WARNINGS* elsewhere in this manual may impair the protection provided by the equipment. In addition it violates safety standards of design, manufacture, and intended use of the instrument.

The Agilent Technologies assumes no liability for the customer's failure to comply with these requirements.

Note



42841A comply with INSTALLATION CATEGORY II and POLLUTION DEGREE 2 in IEC1010-1. 42841A are INDOOR USE product.

Note



LEDs in this product are Class 1 in accordance with IEC825-1.
CLASS 1 LED PRODUCT

Ground The Instrument

To avoid electric shock hazard, the instrument chassis and cabinet must be connected to a safety earth ground by the supplied power cable with earth blade.

DO NOT Operate In An Explosive Atmosphere

Do not operate the instrument in the presence of flammable gasses or fumes. Operation of any electrical instrument in such an environment constitutes a definite safety hazard.

Keep Away From Live Circuits

Operating personnel must not remove instrument covers. Component replacement and internal adjustments must be made by qualified maintenance personnel. Do not replace components with the power cable connected. Under certain conditions, dangerous voltages may exist even with the power cable removed. To avoid injuries, always disconnect power and discharge circuits before touching them.

DO NOT Service Or Adjust Alone

Do not attempt internal service or adjustment unless another person, capable of rendering first aid and resuscitation, is present.

DO NOT Substitute Parts Or Modify Instrument

Because of the danger of introducing additional hazards, do not install substitute parts or perform unauthorized modifications to the instrument. Return the instrument to a Agilent Technologies Sales and Service Office for service and repair to ensure that safety features are maintained.

**Dangerous Procedure
Warnings**

Warnings , such as the example below, precede potentially dangerous procedures throughout this manual. Instructions contained in the warnings must be followed.

Warning



Dangerous voltages, capable of causing death, are present in this instrument. Use extreme caution when handling, testing, and adjusting this instrument.

Safety Symbols

General definitions of safety symbols used on equipment or in manuals are listed below.



Instruction manual symbol: the product is marked with this symbol when it is necessary for the user to refer to the instruction manual.



Alternating current.



Direct current.



On (Supply).



Off (Supply).



In position of push-button switch.



Out position of push-button switch.



Frame (or chassis) terminal. A connection to the frame (chassis) of the equipment which normally include all exposed metal structures.

Warning



This **Warning** sign denotes a hazard. It calls attention to a procedure, practice, condition or the like, which, if not correctly performed or adhered to, could result in injury or death to personnel.

Caution



This **Caution** sign denotes a hazard. It calls attention to a procedure, practice, condition or the like, which, if not correctly performed or adhered to, could result in damage to or destruction of part or all of the product.

Note



This **Note** sign denotes important information. It calls attention to a procedure, practice, condition or the like, which is essential to highlight.



Affixed to product containing static sensitive devices use anti-static handling procedures to prevent electrostatic discharge damage to component.

How to Use This Manual

This is the Operation Manual for the 42841A Bias Current Source including system operation combining with the 4284A, 42842A/B, and 42843A. This manual contains installation, configuration, operation, and performance test in the procedure following six chapters. After you receive your 42841A, begin with chapter 1.

The 42841A is designed to compose a high DC current biased impedance measurement system, combining with the 4284A. Refer to the 4284A Operation Manual (Agilent Part Number 04284-90000) for operation 4284A, before reading this Operation Manual.

For error messages of the 42841A, 42842A/B, and 42843A in use with the 4284A, refer to the *4284A Operation Manual Appendix B Error Message And System Message*.

Chapter 1 Installation

This chapter provides unpacking, initial inspection, and preparation information necessary for you to know before applying AC power.

Chapter 2 Product Overview

This chapter provides information including a product overview.

Chapter 3 Operation Procedure and Examples

This chapter provides the basic operation procedures measurement techniques, practical measurement examples, and remote control capability information.

Chapter 4 General Information

This chapter provides specifications, supplemental performance characteristics, and other general information on the 42841A.

Chapter 5 Performance Test

This chapter provides the performance tests for the 42841A used for incoming inspection and verification that your instrument is completely calibrated.

Appendix A Manual Changes

Appendix A contains Manual Changes and provides information for using this manual with an 42841As manufactured before the printing date of the manual.

Typeface Conventions

Bold

Boldface type is used when a term is defined. For example: **icons** are symbols.

Italics

Italic type is used for emphasis and for titles of manuals and other publications.

Italic type is also used for keyboard entries when a name or a variable must be typed in place of the words in italics. For example: **copy** *filename* means to type the word **copy**, to type a space, and then to type the name of a file such as **file1**.

Computer

Computer font is used for on-screen prompts and messages.

HARDKEYS



Labeled keys on the instrument front panel are enclosed in .

SOFTKEYS

Softkeys located to the right of the LCD are enclosed in .

Contents

1. Installation and Set Up Guide	
Incoming Inspection	1-1
Power Requirements	1-2
Power Cable	1-2
Line Voltage and Fuse Selection	1-4
Line Voltage Selection	1-4
 Fuse Selection	1-4
Operation Environment	1-5
Electromagnetic Compatibility	1-5
Ventilation Requirements	1-5
Instruction for Cleaning	1-6
Rack/Handle Installation	1-6
Option 907 Handle Kit	1-7
Installing the Handle	1-7
Option 908 Rack Flange Kit	1-7
Mounting the Rack	1-7
Option 909 Rack Flange & Handle Kit	1-7
Mounting the Handle and Rack	1-7
2. Product Overview	
Introduction	2-1
Product Introduction	2-1
A Tour of the Front Panel	2-2
(1) LINE On/Off	2-2
(2) Operation Indicator	2-2
(3) DC Bias Indicator	2-3
(4) DC Bias Current Output	2-3
(5) Fixture Connection Detector	2-3
(6) Fixture Guide Holes and Threaded Studs	2-3
A Tour of Rear Panel	2-4
(1) Bias Current Interface Connectors	2-4
(2) Line Voltage Selector	2-4
(3) Line Fuse Holder	2-4
(4) Line Input Receptacle	2-4

3. Operation Procedure and Examples	
Introduction	3-1
Operation Limitations	3-1
4284A Systems	3-1
20A System	3-1
40A System	3-1
Operation Limitations	3-2
4285A System	3-2
Operation Limitations	3-2
 Instrument Connections	3-3
4284A(20A) System	3-3
4284A(40A) System	3-5
4285A System	3-7
 Interconnecting Units	3-9
Basic Measurement Procedure	3-11
Measurement Procedure	3-11
Confirm the System Condition	3-12
Set Up the Measurement Conditions	3-12
Performing Error Correction	3-12
Cable Length Correction	3-12
Open Correction	3-12
Short Correction	3-13
Performing Short Correction	3-13
Load Correction	3-13
Connect DUT to the Test Fixture	3-13
Enable the DC Bias Output	3-14
Performing the Measurement	3-14
Disable the DC Bias Output.	3-16
Measurement Terminals Extension	3-17
Inductance Measurements	3-18
DC Bias Current List Sweep	3-27
Remote Control	3-28
Remote Control Capability	3-28
Sample Program	3-29
4. General Information	
Introduction	4-1
Serial Number	4-1
Specifications	4-2
DC Bias Current Output	4-2
Output Voltage	4-3
Applicable Test Signal	4-3
Interface	4-3
Other Options	4-3
Furnished Accessories	4-3
Test Fixtures	4-4
Other Accessories	4-4
Line Voltage	4-4
Line Frequency	4-4

Power Consumption	4-4
Operating Temperature	4-4
Operating Humidity	4-4
Operating Altitude	4-4
Dimensions	4-4
Weight	4-4
Supplemental Performance Characteristics	4-4
42841A Measurement Accuracy (used for 4284A)	4-4
L and Z Accuracy : A_e (for L accuracy; $D_x \leq 0.1$)	4-4
D Accuracy : D_e ($D_x \leq 0.1$)	4-6
θ Accuracy : θ_e	4-6
R_s (Equivalent Series Resistance) Accuracy : R_{se} ($D_x \leq 0.1$)	4-6
Additional Error Caused by 42842A/B	4-7
L and Z Additional Error (for L accuracy; $D_x < 0.1$)	4-7
D Additional Error : D_1 ($D_x < 0.1$)	4-8
θ Additional Error : θ_1	4-8
R_s (Equivalent Series Resistance) Additional Error : R_{s1} ($D_x < 0.1$)	4-8
Measurement Accuracy (used for 4285A)	4-13
L and Z Accuracy : A_e (for L accuracy; $D_x \leq 0.1$ or $Q_x \geq 10$)	4-13
D Accuracy : D_e ($D_x \leq 0.1$)	4-13
Accuracy :	4-14
R_s (Equivalent Series Resistance) Accuracy : R_e	4-14
42842C Additional Error	4-14
L and Z Additional Error: A_1	4-17
D Additional Error	4-17
Additional Error :	4-17
R_s (Equivalent Series Resistance) Additional Error : R_1	4-17
Bias Current Settling Time	4-18
Signal Voltage ALC Operation Area	4-18
Measurement Error Calculation Example	4-18
Storage and Repacking	4-21
Environment	4-21
Original Packaging	4-21
Other Packaging	4-21

5. Performance Test

Introduction	5-1
Test Equipment	5-1
Performance Test Record	5-2
Calculation Sheet	5-2
Calibration Cycle	5-2
DC Bias Current Accuracy Test	5-3
Test Equipment	5-3
Procedure	5-4
Resistor Box Calibration	5-7
Test Equipment	5-7

Procedure	5-7
Calicuation Sheet	5-9
Performance Test Record	5-11

A. Manual Changes

Introduction	A-1
Manual Changes	A-1

Index

Figures

1-1. Power Cable Supplied	1-3
1-2. Line Voltage Selector	1-4
1-3. Rack Mount Kits Installation	1-6
2-1. Front Panel Overview	2-2
2-2. Rear Panel Overview	2-4
3-1. Cable connection for the 4284A (20A) system	3-4
3-2. Cable connection for an 4284A(40A) system	3-6
3-3. Cable connections for an 4285A system	3-7
3-4. Cable connections for an 4285A system(adding the 42851A)	3-8
3-5. 42842A/B/C Bias Current Test Fixture Connection	3-10
3-6. Shorting the Measurement Terminals	3-13
3-7. Moving Cursor to the <i>FUNC</i> Field	3-18
3-8. Softkey Path To The LS-RS softkey	3-19
3-9. Moving Cursor to the <i>FREQ</i> Field	3-19
3-10. Measurement Frequency Value Entry	3-20
3-11. Moving Cursor to the <i>BIAS</i> Field	3-20
3-12. Bias Current Value Entry (before pressing the A softkey)	3-21
3-13. Moving Cursor to the <i>INTEG</i> Field	3-21
3-14. Select Measurement Setup Page	3-22
3-15. Move Cursor to the <i>ALC</i> field.	3-22
3-16. To Enable the Automatic Level Control Function	3-23
3-17. Set Cable Length	3-24
3-18. Connecting the Furnished Shorting Bar	3-24
3-19. Move the Cursor to the <i>SHORT</i> Field	3-25
3-20. System Message When the Short Measurement is Completed	3-25
3-21. Ferrite-Cored Inductor Measurement Results	3-26
3-22. DC Bias Current List Sweep Result	3-27
4-1. Serial Number Plate	4-1
4-2. Temperature Induced Setting Error	4-2
4-3. DC Bias Output Range	4-3
4-4. 4284A Accuracy	4-5
4-5. 4284A Basic Accuracy Line Selection Chart	4-5
4-6. Inductance measurement accuracy of 42841A (20A Configuration)	4-9
4-7. Impedance measurement accuracy of 42841A (20A Configuration)	4-10
4-8. Temperature additional error of 42841A (20A Configuration)	4-10

4-9. Inductance measurement error of 42841A (40A Configuration)	4-11
4-10. Impedance measurement accuracy of 42841A (40A Configuration)	4-12
4-11. Temperature additional error of 42841A (40A Configuration)	4-12
4-12. Additional Inductance Error of the 42842C	4-15
4-13. Additional Impedance Error of the 42842C	4-16
5-1. Bias Current Accuracy Test Setup	5-4
5-2. Resistor Box Calibration Setup	5-7

Tables

1-1. 42841A Contents	1-2
1-2. Line Voltage Selection	1-4
1-3. Fuse Selection	1-4
1-4. Rack Mount Kits	1-6
3-1. Allowable Current Capacity Of The Wire	3-17
3-2. Current Capacity Reducing Rate	3-17
4-1. DC Bias Current Accuracy	4-2
4-2. Accuracy Chart Selection Table	4-7
5-1. Recommended Test Equipment	5-2
5-2. Bias Current Accuracy Specification	5-3
5-3. Recommended Test Equipment	5-3
5-4. 1A Range Bias Current Accuracy Test Limit	5-5
5-5. 5A Range Bias Current Accuracy Test Limit	5-6
5-6. 20A Range Bias Current Accuracy Test Limit	5-6
5-7. Recommended Test Equipment	5-7
A-1. Manual Changes by Serial Number	A-1

Installation and Set Up Guide

This chapter provides the information necessary for performing an incoming inspection and setting up the 42841A. The main topics in this chapter are:

- Incoming Inspection
- Power requirements
- Line Voltage and Fuse Selection
- Operation Environment
- Electromagnetic Compatibility
- Ventilation Requirements
- Instruction for Cleaning
- Rack/Handle Installation

Incoming Inspection

Warning



To avoid hazardous electrical shock, do not turn on the 42841A when there are signs of shipping damage to any portion of the outer enclosure (for example, covers, panel, or display)

Inspect the shipping container for damage. If the shipping container or cushioning material is damaged, it should be kept until the contents of the shipment have been checked for completeness and the 42841A has been checked mechanically and electrically. The contents of the shipment should be as listed in Table 1-1. If the contents are incomplete, if there is mechanical damage or defect, or if the analyzer does not pass the power-on selftests, notify the nearest Agilent Technologies office. If the shipping container is damaged, or the cushioning material shows signs of unusual stress, notify the carrier as well as the Agilent Technologies office. Keep the shipping materials for the carrier's inspection.

Table 1-1. 42841A Contents

Description	Qty.	Agilent Part Number
42841A		
Bias Current Interface Cable	1	42841-61640
Power cable ¹	1	—
Operation Manual	1	42841-90010
Option 907 Handle Kit		
Handle kit	1	5061-9690
Option 908 Rack Flange Kit		
Rack Flange Kit	1	5061-9678
Option 909 Rack Flange & Handle Kit		
Rack Flange & Handle Kit	1	5061-9684

¹ Power Cable depends on where the instrument is used, see “Power Cable”.

Power Requirements

The 42841A requires the following power source:

Voltage : 90 to 132 Vac, 198 to 252 Vac

Frequency : 47 to 66 Hz

Power : 600 VA maximum

Power Cable

In accordance with international safety standards, this instrument is equipped with a three-wire power cable. When connected to an appropriate ac power outlet, this cable grounds the instrument frame.

The type of power cable shipped with each instrument depends on the country of destination. Refer to Figure 1-1 for the part numbers of the power cables available.

Warning



For protection from electrical shock, the power cable ground must not be defeated.

The power plug must be plugged into an outlet that provides a protective earth ground connection.

Line Voltage and Fuse Selection

Figure 1-2 illustrates the line voltage selection switch and fuseholder on the instrument's rear panel.

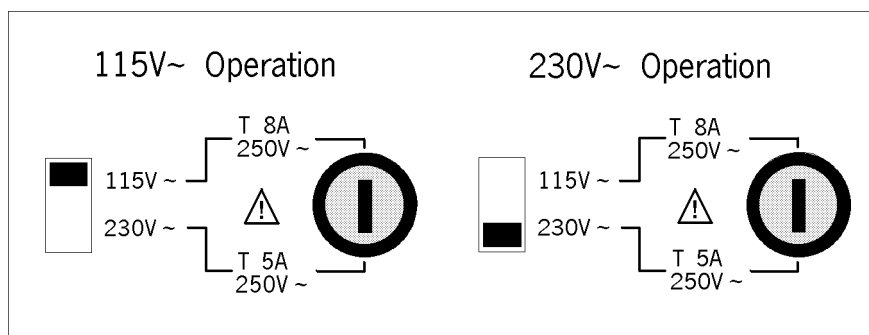

Figure 1-2. Line Voltage Selector

Caution



Before connecting the instrument to the power source, make sure that the correct fuse has been installed and the Line Voltage Selection Switch is correctly set.

Line Voltage Selection

Select the proper voltage selector according to the Table 1-2.

Table 1-2. Line Voltage Selection

Voltage Selector	Line Voltage
115 V~	90–132 V, 47–66 Hz
230 V~	198–252 V, 47–66 Hz



Fuse Selection

Select proper fuse according to the Table 1-3. Current ratings for the fuse are printed under the fuseholder on the rear panel, and are listed, along with the fuse's Agilent Part number, in Table 1-3.

Table 1-3. Fuse Selection

Operating Voltage	Fuse Rating/Type	Fuse Part Number
115 V~	8A 250Vac UL/CSA type Time Delay	2110-0383
230 V~	5A 250Vac UL/CSA type Time Delay	2110-0030

If you need this fuse, contact your nearest Agilent Technologies Sales and Service Office.

To remove the fuse, turn the fuse holder counterclockwise until the fuse pops out.

Caution



Use the proper fuse for the line voltage selected. Use only fuses with the required current rating and of the specified type as replacements. DO NOT use a mended fuse or short-circuit the fuse-holder in order to by-pass a blown fuse. Find out what caused the fuse to blow!

**Operation
Environment**

The 42841A must be operated under within the following environment conditions, and sufficient space must be kept behind the 42841A to avoid obstructing the air flow of the cooling fans.

Temperature: 0°C to 55°C

Humidity: less than 95% RH at 40°C

Note



The 42841A must be protected from temperature extremes which could cause condensation within the instrument.

**Electromagnetic
Compatibility**

This product has been designed and tested to the requirements of the Electromagnetic Compatibility (EMC) Directive 89/336/EEC. To use a properly shielded cable or shielded coaxial cable (such as those recommended in the General Information and the Performance Test) to connect each of the ports to their respective controllers, peripherals, equipments or devices may ensure to meet the requirements.

**Ventilation
Requirements**

To ensure adequate ventilation, make sure that there is adequate clearance around the 42841A.

Instruction for Cleaning

To prevent electrical shock, disconnect the 42841A power cable from the receptacle before cleaning. Use a dry cloth or a cloth slightly dipped in water to clean the casing. Do not attempt to clean the 42841A internally.

Rack/Handle Installation

The analyzer can be rack mounted and used as a component in a measurement system. Figure 1-3 shows how to rack mount the 42841A.

Table 1-4. Rack Mount Kits

Option	Description	Agilent Part Number
907	Handle Kit	5061-9690
908	Rack Flange Kit	5061-9678
909	Rack Flange & Handle Kit	5061-9684

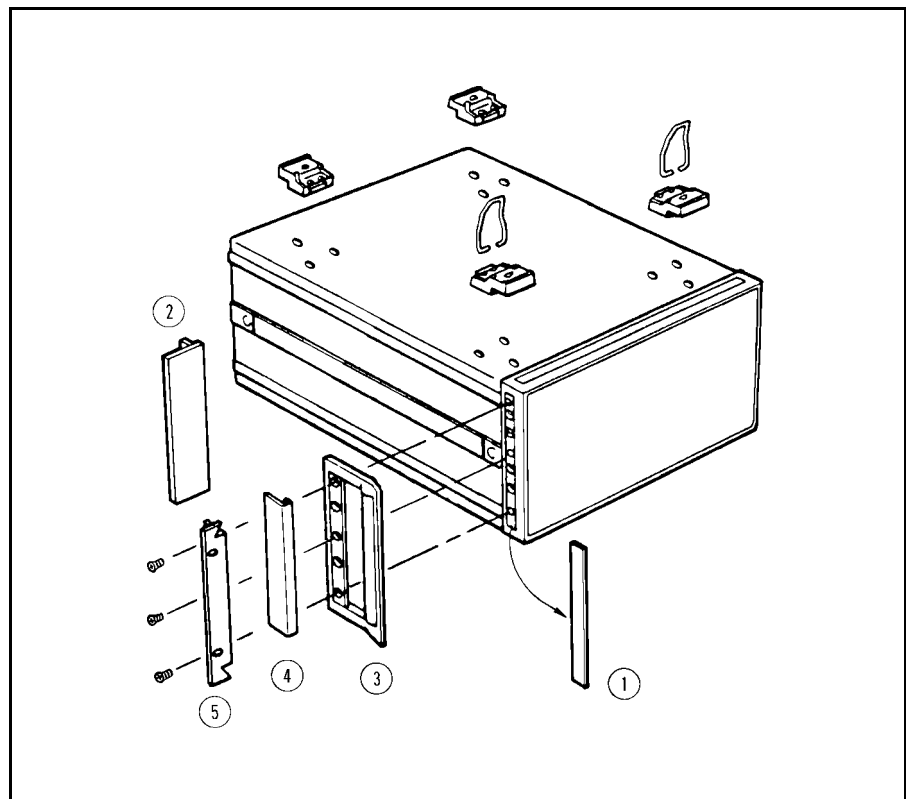

Figure 1-3. Rack Mount Kits Installation

Option 907 Handle Kit

Option 907 is a handle kit containing a pair of handles and the necessary hardware to attach them to the instrument.

Installing the Handle

1. Remove the adhesive-backed trim strips ① from the left and right front sides of the 42841A. (Refer to Figure 1-3.)
2. Attach the front handles ② to the sides using the screws provided.
3. Attach the trim strips ③ to the handles.

Option 908 Rack Flange Kit

Option 908 is a rack flange kit containing a pair of flanges and the necessary hardware to mount them to the instrument in an equipment rack with 482.6 mm (19 inches) horizontal spacing.

Mounting the Rack

1. Remove the adhesive-backed trim strips ① from the left and right front sides of the 42841A. (Refer to Figure 1-3.)
2. Attach the rack mount flange ④ to the left and right front sides of the 42841A using the screws provided.
3. Remove all four feet ⑤ (lift bar on the inner side of the foot, and slide the foot toward the bar.)

Option 909 Rack Flange & Handle Kit

Option 909 is a rack mount kit containing a pair of flanges and the necessary hardware to mount them to an instrument which has handles attached, in an equipment rack with 482.6 mm (19 inches) spacing.

Mounting the Handle and Rack

1. Remove the adhesive-backed trim strips 1 from the left and right front sides of the 42841A.
2. Attach the front handle 3 and the rack mount flange 5 together on the left and right front sides of the 42841A using the screws provided.
3. Remove all four feet (lift bar on the inner side of the foot, and slide the foot toward the bar).

Product Overview

Introduction

This chapter contains the information you will need to know before operating the Agilent Model 42841A Bias Current Source, such as the relation between the 4284A/4285A Precision LCR meter and 42841A, and each name of the 42841A's parts and their function.

Product Introduction

The 42841A is a bias current source for use with the 4284A (with an Option 002 Bias Current Interface) or with the 4285A (with an Option 002 Accessory Control Interface). So all measurement setups including the DC current bias can be set using the 4284A/4285A front panel keys.

The 42841A using with 4284A (20Hz - 1MHz) covers DC current bias from 0.01A to 20A in three ranges. Two 42841As can be paralleled to supply the maximum of 40A DC current bias combining the 42842B Bias Current Test Fixture and by the 42843A Bias

Current Cable. For system configuration, refer to “ Instrument Connections” in Chapter 3.

The 42841A can also be used with the 4285A (75kHz - 30MHz) and the 42842C test fixture for biased measurements. When the 42841A is used with the 42841A, the DC current bias range of 0.01A to 10A is covered.

The 4284A when used with the 42841A, 42842A/B, and 42843A offers an additional error of 1% (supplemental performance characteristics), over frequency range from 1kHz to 1MHz. The 4284A's some measurement functions are limited such as measurement range and Option 001 Power Amplifier/ DC Bias option. For details, refer to “Operation Limitations” in Chapter 3.

A Tour of the Front Panel

Figure 2-1 shows the 42841A's components on the front panel. A description is given in the following paragraphs.

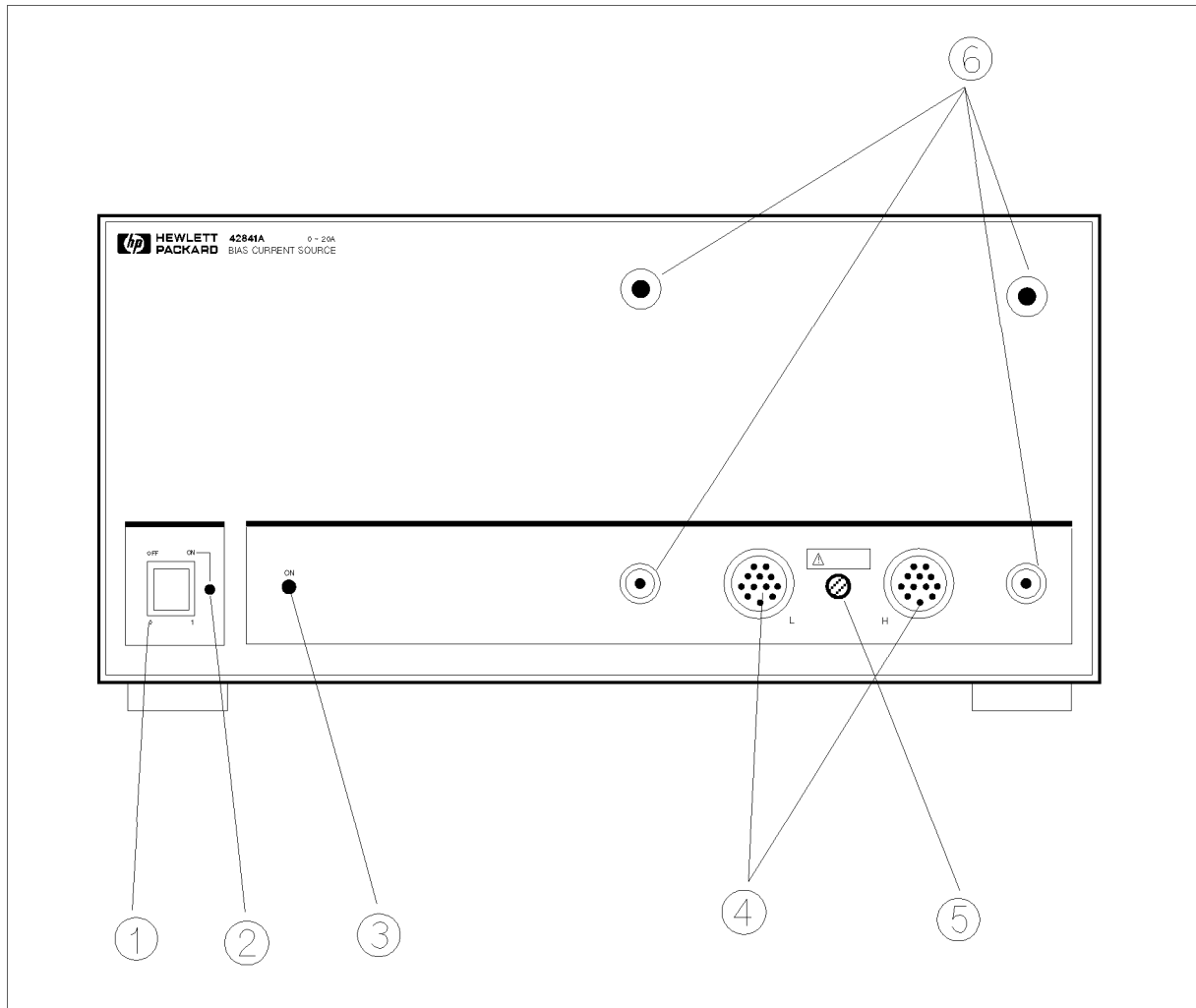

a40mr201

Figure 2-1. Front Panel Overview

(1) LINE On/Off

Power on/off switch. In the “ON” position all operating voltages are applied to the instrument. In the “OFF” position NO operating voltages are applied to the instrument.

(2) Operation Indicator

This Light Emitting Diode (LED) shows the 42841A's operation status. This LED is ON while the 42841A is operated normally. If the 42842A/B or 42843A are accidentally disconnected from the 42841A, the power will be automatically shut down and this LED will go off. In this case, turn the line switch off, and wait for a few seconds before turning it on again.

(3) DC Bias Indicator

This LED shows the 42841A's DC current bias status. When this LED is lit, DC current bias is applied. When this LED is OFF, the DC current bias is not applied.

(4) DC Bias Current Output

These connectors output the DC bias current, detects the fixture connection, detects over temperature of the fixture, and checks status of the fixture cover.

(5) Fixture Connection Detector

This switch senses connection of 42842A/B or 42843A. If this switch is asserted, the 42841A will shut down by itself for the operator's safety.

(6) Fixture Guide Holes and Threaded Studs

These parts are used to mount the 42842A/B in front of the 42841A.

A Tour of Rear Panel

Figure 2-2 shows the 42841A's components on the rear panel. A description is given in the following paragraphs.

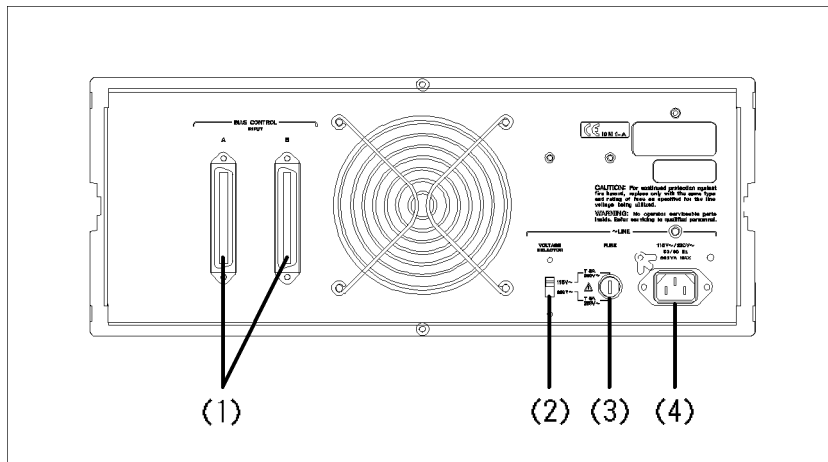

Figure 2-2. Rear Panel Overview

(1) Bias Current Interface Connectors

These are the Bias Current Interface connectors. Use either the connector A or B to interconnect the 42841A with the 4284A Option 002 Bias Current Interface or with the 4285A Option 002 Accessory Control Interface using the furnished bias current interface cable. The other connector is used to connect one more 42841A unit when a 40A maximum bias current system is configured.

(2) Line Voltage Selector

The switch used to match the 42841A to the AC operating voltage being used. Refer to SECTION 1 to determine the correct operating voltage.

(3) Line Fuse Holder

Fuse holder for the 42841A's line fuse. Refer to SECTION 1 to determine the correct line fuse rating.

(4) Line Input Receptacle

AC power cord receptacle.

Operation Procedure and Examples

Introduction

This chapter discusses the following topics:

- Operation limitations
- Basic measurement procedures
- Measurement hints
- Practical measurement examples
- Remote control function

Operation Limitations

When using the 42841A, the measurement configuration is selected based on use. Each configuration has the following limitations.

4284A Systems

This system configuration uses the 4284A (measurement frequency: 20Hz - 1MHz) with the 42841A and the 42842A/B. There are two configurations for two bias current ranges. One is a 20A bias current system and the other is a 40A bias current system.

20A System

The following equipment is necessary for the basic 20A system.

4284A Precision LCR Meter (with Option 002)	: 1
42841A Bias Current Source	: 1
42842A Bias Current Test Fixture	: 1
16048A Test Lead	: 1
Interface Cable(furnished with 42841A)	: 1

40A System

The following equipment is necessary for the basic 40A system.

4284A Precision LCR Meter (with Option 002)	: 1
42841A Bias Current Source	: 2
42842B Bias Current Test Fixture	: 1
42843A Bias Current Cable	: 1
16048A Test Lead	: 1
Interface Cable(furnished with 42841A)	: 2

Operation Limitations

Some 4284A functions have limitations when used with the 42841A and the 42842A/B. These limitations are:

- Standard spot bias (1.5V or 2V) is disabled.
- Option 001, Power Amplifier/DC-bias, is disabled. So High Power mode and DC current Isolation are turned OFF. The maximum oscillator level is limited to $2V_{\text{rms}}$, and the $\pm 40\text{V}$ DC-bias is disabled.
- Measurement range is limited to 10Ω and 100Ω ranges only.
- Open compensation can not be used when the 42841A is used.
- The cable length setting applies for the 1 m setting only.

For each of the above mentioned functions, refer to the *4284A Operation Manual, Section 3, Display Format, and Section 4, Measurement Setup.*

4285A System

This system uses the 4285A (measurement frequency: 75kHz - 30MHz) with the 42841A and 42842C. This is 10A bias current system.

The following equipment is necessary for a basic 4285A bias current system.

4285A Precision LCR Meter	: 1
42841A Bias Current Source	: 1
42842C Bias Current Test Fixture (Order the Option 001, SMD Test Fixture.)	: 1
16048A Test Lead	: 1
Interface Cable (furnished with 42841A)	: 1

Operation Limitations

Some 4285A functions have limitations when used with 42841A and 42842C. These limitations are:

- Option 001, Internal DC Bias is disabled.
- Cable length setting applies for the 1 m setting only.

Refer to the *4285A Precision LCR Meter Operation Manual* for details.

Instrument Connections

Corresponding to each system configuration, use the following procedures to connect the instruments.

Note



DO NOT use these configurations other than as described in this section.

Caution



Use the furnished 42841A Interface Cable when connecting to the 4284A/4285A. DO NOT extend the Interface Cable.

4284A(20A) System

Connect the 4284A to the 42841A and the 42842A as shown in Figure 3-1 using the following procedure.

1. Connect the Bias Current Interface connector of the 4284A to the Bias Current Control Input A connector of the 42841A using the furnished Bias Current Interface Cable.
2. Connect the 42842A directly to front panel of the 42841A as shown in “ Interconnecting Units”.
3. Connect the UNKNOWN connector of the 4284A to the TO UNKNOWN Connector of the 42842A using the 16048A Test Lead.

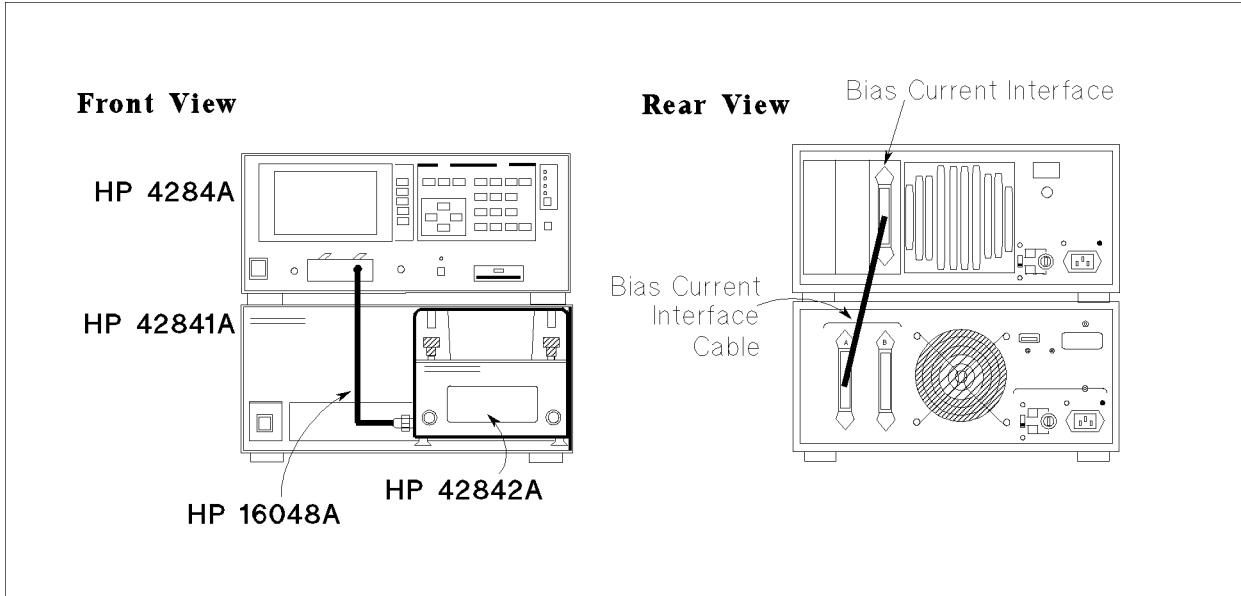

a40mr301

Figure 3-1. Cable connection for the 4284A (20A) system

4284A(40A) System

Connect the 4284A to the 42841A and the 42842A as shown in Figure 3-2 using the following procedure.

1. Connect the 4284A Bias Current Interface Connector to the Bias Current Input A Connector of the 42841A using the furnished Bias Current Interface Cable(1).
2. Connect the 42841A Bias Current Control Input B Connector connected to the 4284A in step 1 to the Bias Current Control Input A Connector of the other 42841A using the furnished Bias Current Interface Cable(2).
3. Connect the 42842B directly to front panel of the 42841A as shown in “ Interconnecting Units”.
4. Connect the 4284A UNKNOWN Connector to the TO UNKNOWN Connector of 42842B using the 16048A Test Leads.
5. Connect the DC Bias Current Output Connector of the 42841A which is not connected with the 42842B and DC Bias Current Input Connector of the 42842B side panel using an 42843A Bias Current Cable.

Caution



When in the 40A configuration shown in Figure 3-2 DO NOT turn off a single 42841A or DO NOT disconnect the Bias Current Interface Cable. When you change the configuration from 40A to 20A, you must completely disconnect one of the 42841As, its Bias Current Interface Cable, and the 42843A Bias Current Cable.

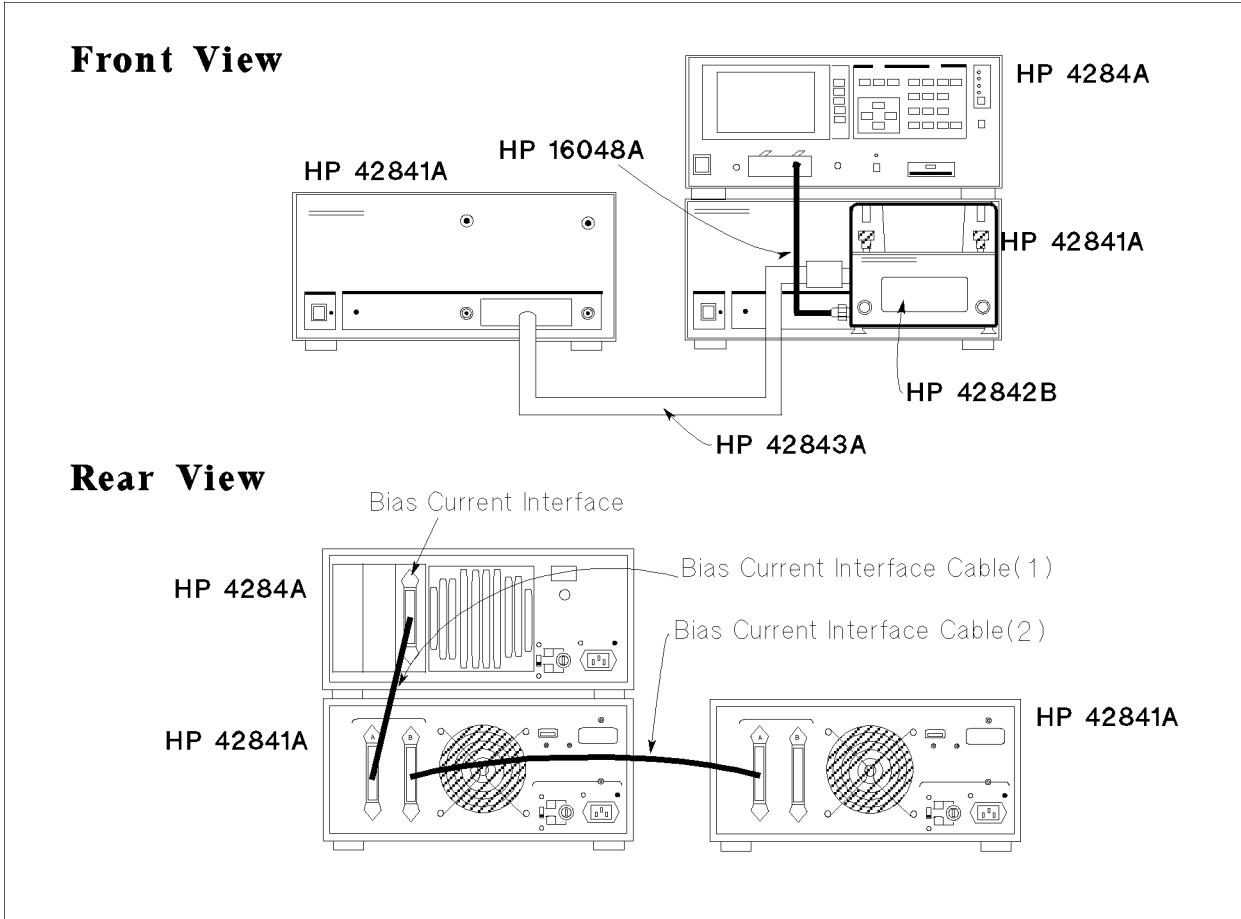

a40mr302

Figure 3-2. Cable connection for an 4284A(40A) system

4285A System

Connect the 4285A to the 42841A and the 42842C as shown in Figure 3-3 using the following procedure.

1. Connect the 4285A Bias Current Interface connector to the 42841A Bias Current Control Input A connector using the furnished Bias Current Interface Cable.
2. Connect the 42842C directly to the front panel of the 42841A as shown in “⚠ Interconnecting Units”.
3. Connect 4285A UNKNOWN connector to the TO UNKNOWN Connector of the 42842C using the 16048A Test Leads.

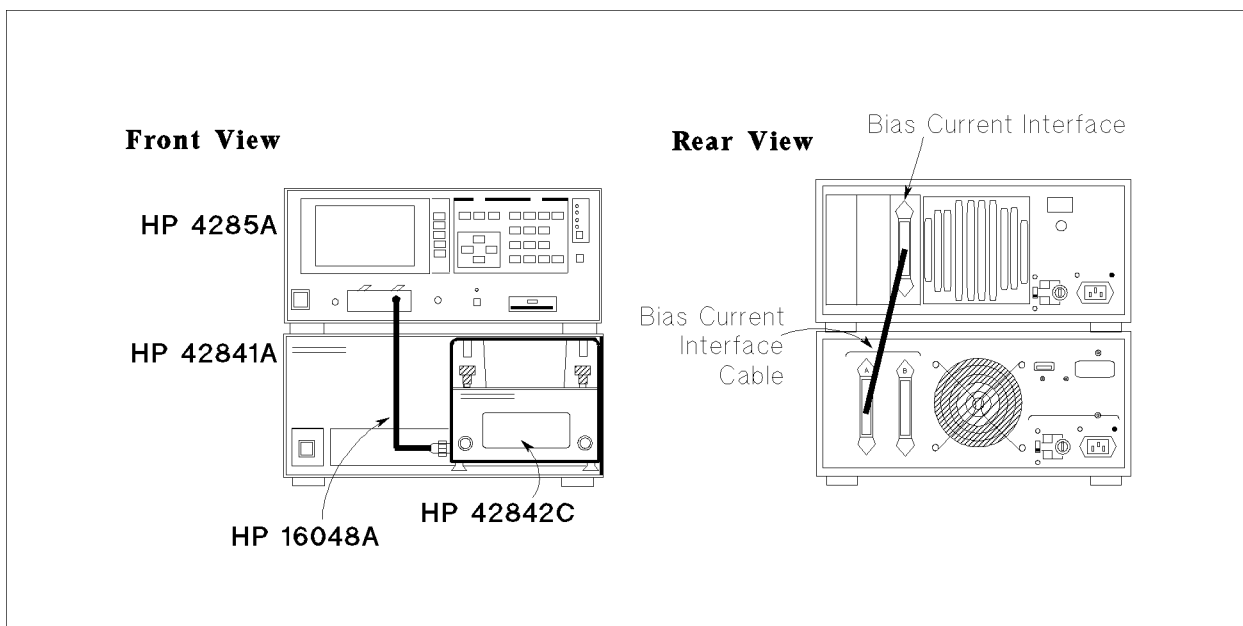

A40MR303

Figure 3-3. Cable connections for an 4285A system

When switching between DC current bias measurement and Q measurement when using an 4285A system with an 42851A precision Q adapter, setup as shown in Figure 3-4.

You can not simultaneously use an 42841A and an 42851A, but you can use them alternately by using the following procedure when connecting the rear panel control cable. For information on using the 42851A refer to the *4285A OPERATION MANUAL, Getting Started Guide* and the *42851A OPERAION MANUAL*.

1. Reconnect the measurement connector of the 4285A to the 42851A by BNC cables.
2. Change the status to 42851A mode using the **Q ADAPTER** softkey in the Accessory I/F(#002) field in the 4285A system configuration page.

Note



If serial number of the 42851A is lower than “2946J00187” in the configuration shown in Figure 3-4, you must reconnect the 42851A’s accessory control interface cable directly to the 4285As interface when changing to the Q measurement mode using the 42851A. If you want to use the 42851A in the configuration shown in Figure 3-4, contact your nearest Agilent Technologies office.

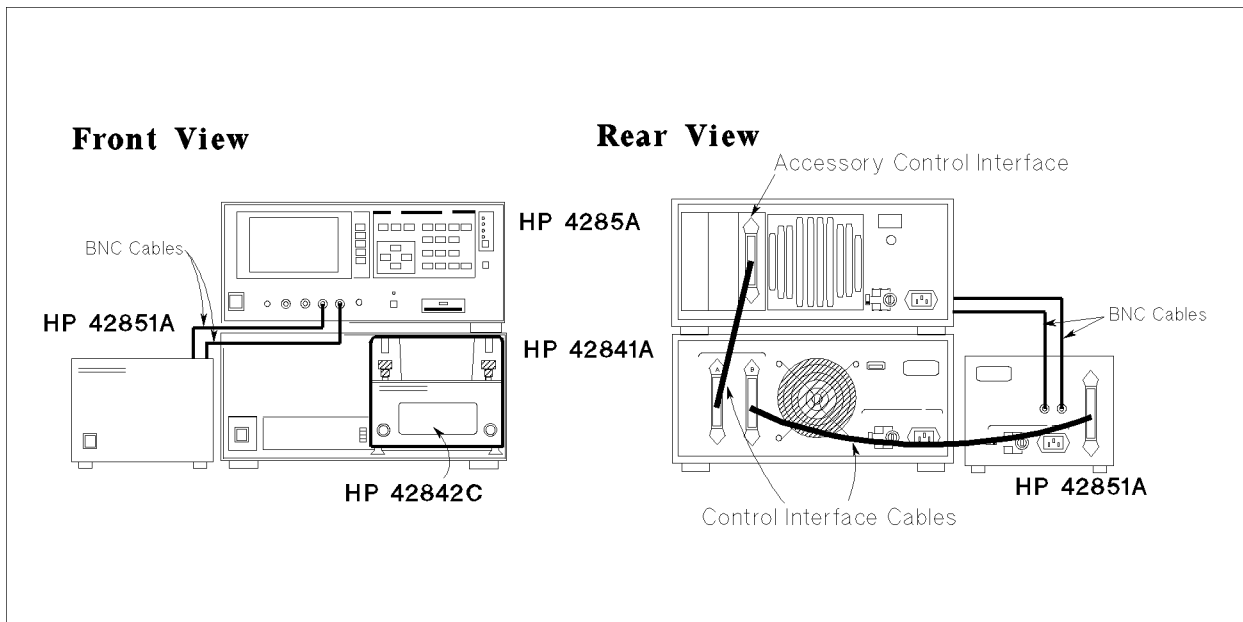

A40MR304

Figure 3-4. Cable connections for an 4285A system(adding the 42851A)

 **Interconnecting
Units**

When you use the 42841A with the 42842A/B/C Bias Current Test Fixture, mount the 42842A/B/C directly to the 42841A Bias Current Source. The connection procedure is listed below. Figure 3-5 shows how to connect the 42842A/B/C to the 42841A.

1. Put the guide rods of the 42842A/B/C into the guide holes in the front of the 42841A.
2. Connect the Bias Current output terminal of the 42841A to the DC Bias input terminal of the 42842A/B/C.
3. Rotate the retaining screws in front of the 42842A/B/C clockwise until they lock.

Warning



The 42842A/B/C mounted on the 42841A must be placed so that it can be supported by the workbench. **DO NOT** stack three boxes (two 42841As and a 4284A) on top of each other, **DO NOT** put anything on the 42842A/B/C test fixture, and **DO NOT** lean on the test fixture. Doing this may cause the instrument to tumble over.

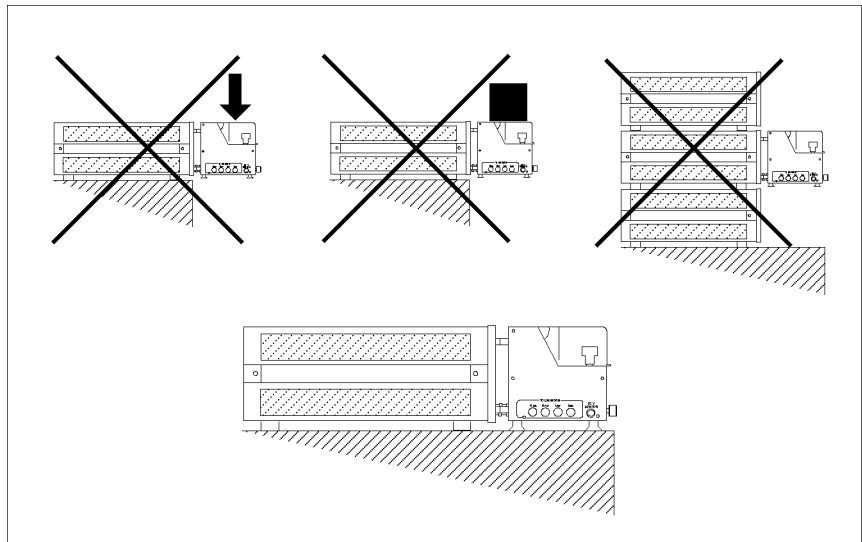

a40warn3

Recommended Physical Setup

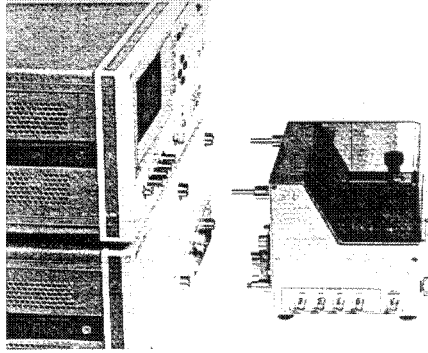

Figure 3-5. 42842A/B/C Bias Current Test Fixture Connection

Warning



The 42842B can be used in a 20A current bias system. But in this case, hazardous voltage will exist at the unused bias current input connector of the 42842B. Put the red protective connector caps on unused input connectors of the 42842B. **DO NOT** try to put a conductive object into the unused 42842B input connector.

Basic Measurement Procedure

The measurement procedure for applying a high current DC bias is the same as for standard 4284A/4285A operation. All measurement conditions can be set using the front panel keys of the 4284A/4285A.

When the 4284A is combined with the (two) 42841A(s), a current bias of 0.01A to 20A (40A) can be set on the *BIAS* field on the *MEASUREMENT DISPLAY* page or the *MEASUREMENT SETUP* page. Option 002 installation can be monitored on the *I BIAS I/F (#002)* field on the *CONFIGURATION* page.

For details on the 4284A's operation, refer to the *4284A Operation Manual, Section 6, Measurement Procedure And Examples*. For the 42841A's error messages when combined with an 4284A, refer to *4284A Operation Manual, Appendix B, Error Message And System Message*.

For details on the 4285A's operation, refer to the *4285A Operation Manual, Getting Started Guide*.

Note



The 42841A will automatically shut down the output when it detects disconnection of the 42842A/B/C or the 42843A. Connect the 42842A/B/C or the 42843A to the 42841A before turning it on.

Measurement Procedure

A typical high DC current biased measurement procedure is as follows.

1. Make sure that Option 002 is installed at the system config page. When using the 4285A, set to the I BIAS configuration at this step.
2. Set up the measurement conditions.
3. Perform error correction.

Note



When using the 4285A, CABLE CORRECTION for a 1 m cable must have already been accomplished.

4. Connect the device under test (DUT) to the measurement terminals.
5. Press the **DC BIAS** key, to enable the DC bias output.
6. Perform the measurement.
7. Press the **DC BIAS** key, to disable the DC bias output.

Confirm the System Condition

Make sure that I BIAS I/F(#002) in case of the 4284A, ACCESSORY I/F(#002) in case of the 4285A, is already installed in SYSTEM/CONFIG page which is displayed when the **CATALOG/SYSTEM** and **SYSTEM CONFIG** is pressed. In a case of the 4285A, it must set to DC Current Bias Measurement Mode by pressing **I BIAS**.

Set Up the Measurement Conditions

First, set up the measurement conditions such as measurement function, test frequency, test signal level, DC current bias, and integration time. These measurement parameters can be set from 4284A/4285A's front panel keys. For details, refer to the *4284A Operation Manual, Section 6, Measurement Procedure And Examples*, or the *4285A Operation Manual, Getting Started Guide*.

Note



Close the 42842A/B/C Bias Current Test Fixture cover, before setting up the measurement conditions.

Performing Error Correction

Cable Length Correction. As described in “Operation Limitations”, set CABLE LENGTH correction to 1 m when the 42841A is used with an 4284A. Use the 16048A test leads to interconnect the 4284A to an 42842A/B or 4285A and the 42842C.

Note



When using the 4285A, the 1 m CABLE CORRECTION must have already been accomplished. DO the 1 m cable correction at the CABLE CORRECTION page which is displayed by pressing **CATALOG/SYSTEM** and **CABLE CORREC**. This correction data will remain after the power is turned off once the correction is executed.

Note



You must extend the measurement connector using leads before you execute the OPEN/SHORT correction in following cases; When a DUT's leads are too short to connect the measurement connector, or the DUT's impedance is less than $50\mu\text{H}$. For details on how to extend the measurement connector, refer to “Measurement Terminals Extension”.

Open Correction. As described in “Operation Limitations”, OPEN correction is not applied while the 42841As are used with an 4284A. Turn the OPEN correction OFF. In the case of an 4285A, you must perform an OPEN correction. When you use extension leads, physically arrange the extension leads as they will be for the actual measurement and perform an OPEN correction.

Short Correction. Using the furnished shorting bar (Agilent Part Number 42842-00607), a short correction cuts measurement error due to the test fixture's residual impedance. This is important when measuring low inductance devices. When you use extension leads to connect the DUT as described in "Measurement Terminals Extension", the leads should be laid out as they will be for the actual measurement.

Performing Short Correction. To perform a short correction data measurement, set up a short condition using the furnished shorting bar.

1. Loosen the knobs of the 42842A/B/C measurement terminals.
2. Connect the furnished shorting bar between high and low terminal as shown in Figure 3-6.
3. Tighten the knobs of the measurement terminals.
4. Close the 42842A/B/C fixture protection cover.
5. Perform the short correction data measurement.

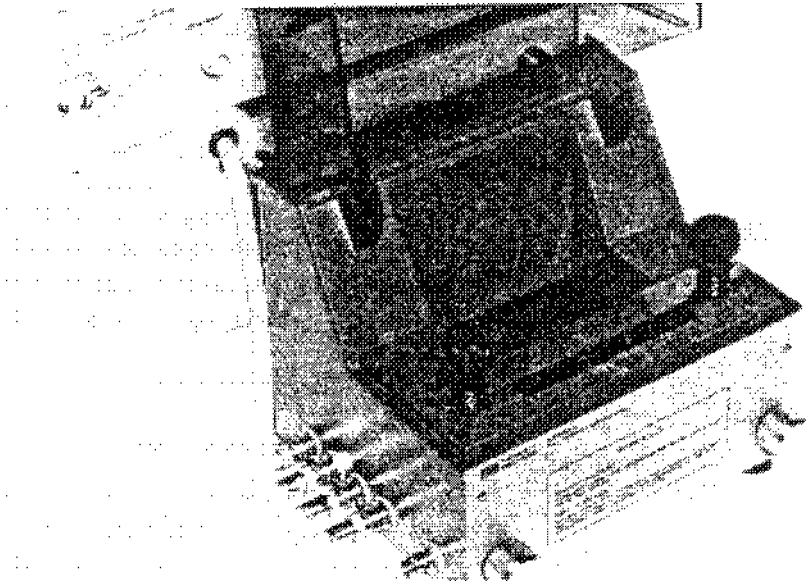

Figure 3-6. Shorting the Measurement Terminals

Load Correction. Load correction is as same as for standard 4284A/4285A operation. Refer to the *4284A Operation Manual, Section 6, Measurement Procedure And Examples, Performing LOAD correction* or to the *4285A Operation Manual*.

Connect DUT to the Test Fixture

Connect the DUT to the measurement terminals of the 42842A/B/C and close the test fixture cover.

Note

The 42842A/B/C is carefully designed using aluminum and plastic to prevent the effects of magnetic permeability. However, when you measure a device which has an open magnetic path, there may be a slight difference in the measured impedance value depending on the connection direction.

Note

If the DUT's leads can't reach the measurement terminals of the 42842A/B/C, extend the measurement terminals as necessary. Refer to "Measurement Terminals Extension" described in next section.

Caution

DO NOT place the DUT too close to the side panel of the 42842A/B/C DUT box. The side panel of the DUT box will be damaged by heat from the DUT.

Warning

The device under test, terminals and adjacent area may become hot due to high power dissipation of the DUT. Be careful in exchanging the device.

Enable the DC Bias Output

Turn the DC bias on using the **DC BIAS** key on the 4284A/4285A's front panel. The DC bias on/off LED indicators of the 4284A/4285A and the 42841A will light simultaneously.

Warning

Hazardous voltages may be present on the unused bias current input connectors of the 42842B connected to the 42841A. Put the red protective caps on the unused bias current input connectors of the 42842B. DO NOT try to put a conductive object into the 42842B connector.

Performing the Measurement

The 4284A/4285A suspends measurement automatically while the DC bias current of the 42841A is in transition. When the DC bias current settles down, the 4284A/4285A automatically continues the measurement. Measurement results are displayed on the LCD display of the 4284A/4285A according to the display page format selected.

In the following cases, the applied DC bias current is automatically turned OFF while the measurement is being performed.

- Fixture cover is open.
- DC bias current source of the 42841A is overloaded.
- The 42842A/B/C overheats.
- Back-e.m.f. (electromotive force) protection circuit of the 42842A/B/C is defective.
- Fixture cover open detector wire is open.

Caution

DO NOT allow the temperature of the DUT to exceed 180°C which may damage side panel of the 42842A/B/C.

Note

If the DUT overheated, internal temperature-responsive reed switch automatically cuts the DC bias off. Also the 4284A/4285A beeps and displays **E-22 Fixture over temperature** error message on the LCD display. In this case, let the 42842A/B/C cool down until it recovers.

Disable the DC Bias Output.

When the measurement is finished, DC bias current is still flowing through the DUT until you turn it OFF. Turn OFF the DC bias with the **DC BIAS** key on the 4284A/4285A front panel to prevent overheating the DUT. DC bias on/off LED indicators of the 4284A/4285A and the 42841A will go off simultaneously.

Warning

Very high voltages (many kilovolts) are generated if an inductive circuit is opened while a high DC bias current is flowing through it. The stored energy is proportional to the square of the current flowing. Turn the bias off before disconnecting the device under test from the 42842A/B Bias Current Test fixture.

Measurement Terminals Extension

If the lead wires of the DUT can't reach the measurement terminals of the 42842A/B/C, provide an appropriate extension using alligator clips. The maximum continuous current that may safely carried in a wire (in a given environment) is limited by the wire temperature rating. When you choose the extension wire, pay attention to the current capacity of the extension wire. Table 3-1 shows the example of the extension wire.

Table 3-1. Allowable Current Capacity Of The Wire

AWG	Stranding ¹	Rated Voltage	Temp. Rating	Curr. Capacity	UL Style	CSA Type
22	(7×30) TOC	300V	80°C	2.6A	1061 VW-1	SRPVC
22	(7×30) TOC	300V	90°C	2.6A	1569 VW-1	TR64
18	(19×30)	300V	90°C	7.2A	1569 VW-1	TR64
16	(26×30)	300V	90°C	9.9A	1569 VW-1	TR64
22	(7×30) TOC	600V	105°C	3.6A	1015 VW-1	TEW
22	(19×34)	600V	105°C	3.8A	1015 VW-1	TEW
18	(19×30) TOC	600V	105°C	9.9A	1015 VW-1	TEW
18	(19×30)	600V	105°C	9.9A	1015 VW-1	TEW
16	(26×30)	600V	105°C	13.5A	1015 VW-1	TEW
14	(41×30) TOC	600V	105°C	21.3A	1015 VW-1	TEW
12	(65×30) TOC	600V	105°C	33.8A	1015 VW-1	TEW
10	(105×30) TOC	600V	105°C	54.6A	1015 VW-1	TEW
TOC = Tin Overcoat (formerly BT, bunch tinned)						
¹ Number of strand × conductor size (AWG)						

When laced wires are used, the current capacity values listed in Table 3-1 must be reduced by the following percentages.

Table 3-2. Current Capacity Reducing Rate

Numbers	Reducing Rate
2 wires	94%
3 wires	89%
4 wires	83%
5 wires	76%

Current capacity determined from the percentages above Table 3-2 presumes equal current distribution between wires.

Inductance Measurements

This section describes a practical example for an inductance measurement, at 20A DC current, using a $490\mu\text{H}$ ferrite-cored inductor as the DUT, so that you can quickly learn the basic operation of the 4284A combined with an 42841A.

The basic procedure for this measurement is the same as for the “Basic Measurement Procedure” described previously. A ferrite-cored inductor will be measured under the following conditions.

- Sample (DUT) : $490\mu\text{H}$ ferrite-cored inductor
(Agilent Part Number 9140-1358)

- Measurement Conditions

Function : Ls-Rs
Frequency : 100kHz
Test Signal Level : 1V (constant)
DC bias : 20A
Integration Time : Long
Cable Length : 1 m
Short Correction : ON

1. Turn the 4284A and 42841A on.
2. Setup the 4284A measurement conditions by modifying values and settings in the fields on the *MEAS DISPLAY* page and the *MEAS SETUP* page.
 - a. Move the cursor to the *FUNC* field.

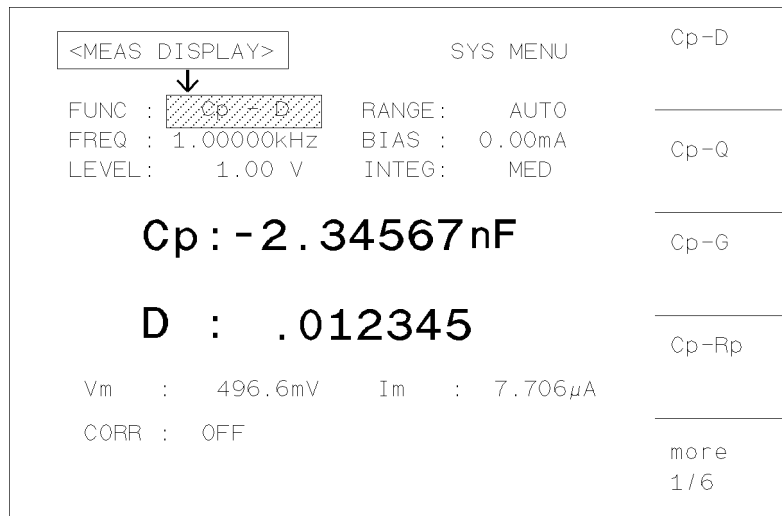
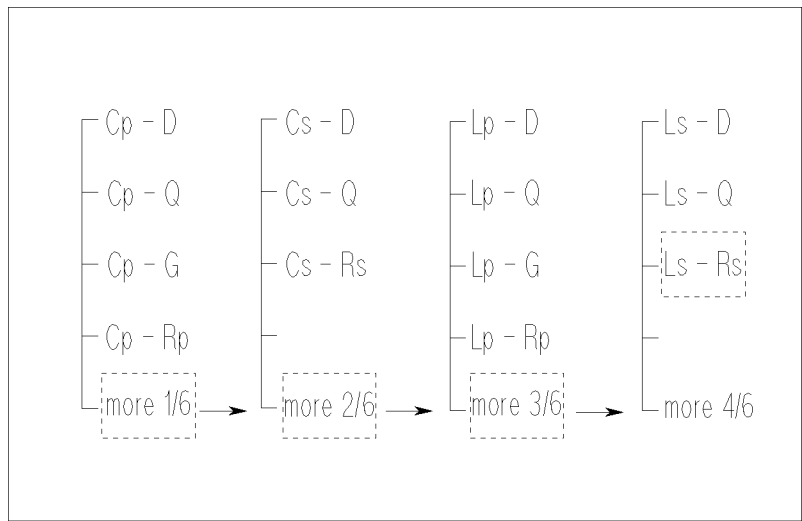

Figure 3-7. Moving Cursor to the *FUNC* Field

- b. Press the **more x/6** softkey three times and press the **Ls-Rs** softkey to choose the *Ls-Rs* function.



a40mr308

Figure 3-8. Softkey Path To The **Ls-Rs softkey**

- c. Move the cursor to the *FREQ* field. The default measurement frequency, 1.00000kHz, is displayed in this field.

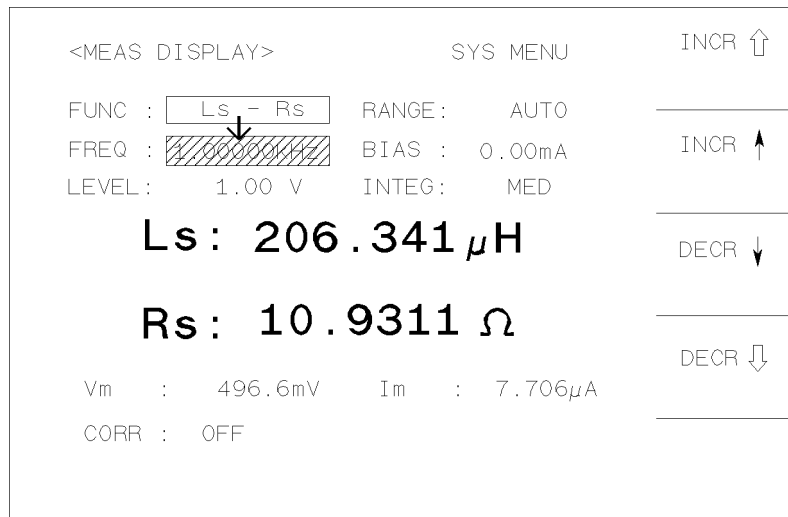

a40mr309

Figure 3-9. Moving Cursor to the *FREQ* Field

- d. Press the **1**, **0**, **0** keys. 100 will be displayed on the system message line, and the softkey labels will change to the available units. Press the **kHz** softkey. 100.000kHz is displayed on the *FREQ* field.

Note



Measurement frequency can also be changed using the **INCR** and **DECR** softkeys displayed when the cursor is moved to the **FREQ** field.

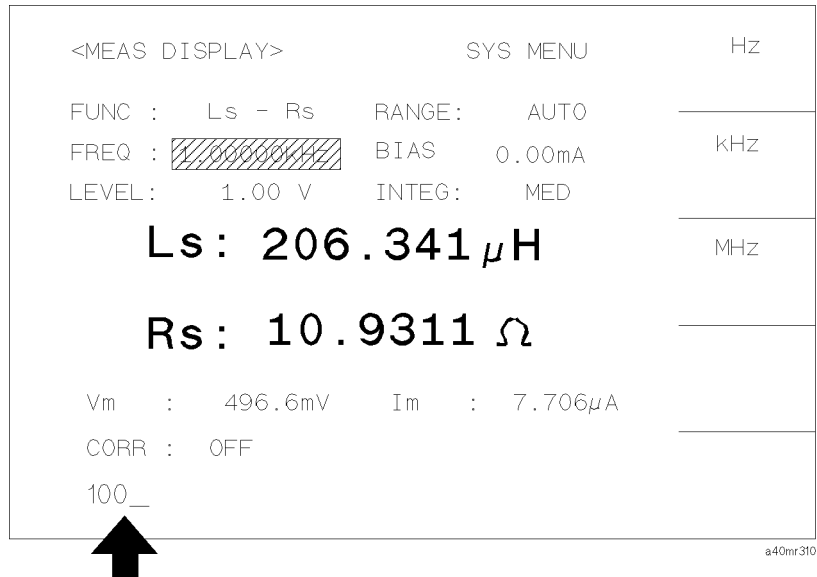

Figure 3-10. Measurement Frequency Value Entry

- e. Move the cursor to the **BIAS** field. The current DC bias level, 0.00 mA, is displayed in this field.

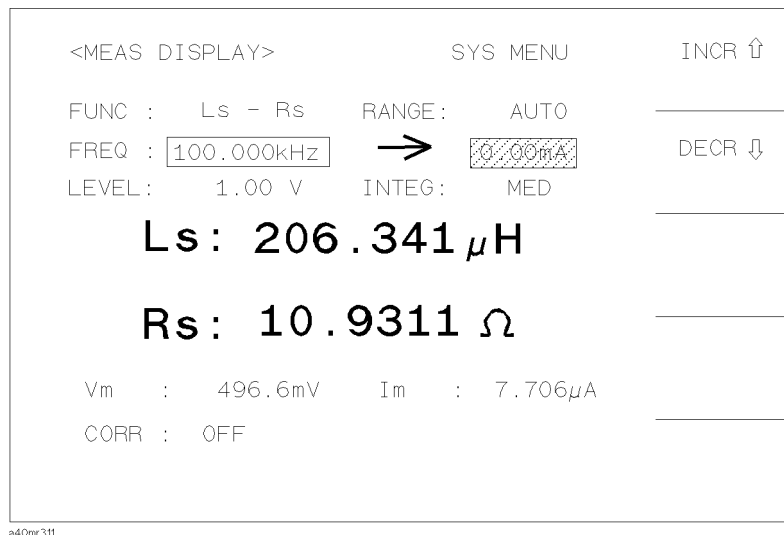

Figure 3-11. Moving Cursor to the BIAS Field

- f. Press the **2** and **0** keys. 20 will be displayed on the system message line, and the softkey labels are changed to the available units. Press the **A** softkey. 20.00A is displayed on the **BIAS** field.

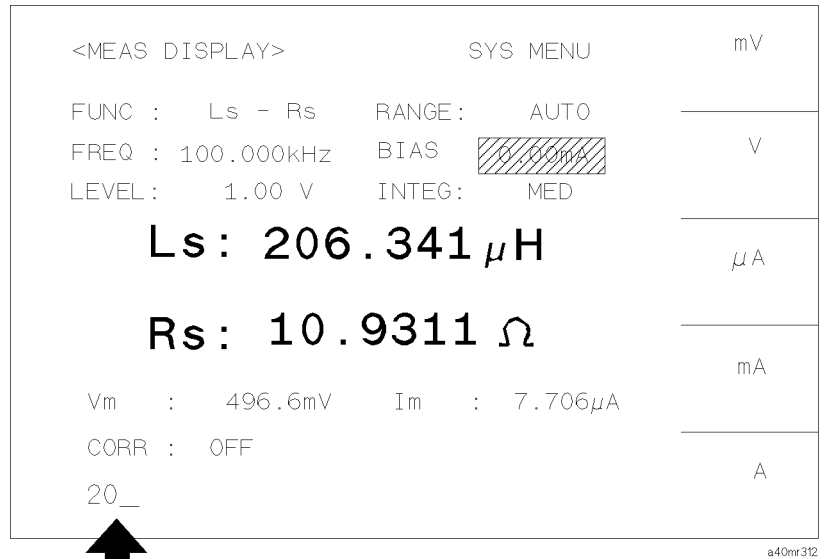

Figure 3-12.
Bias Current Value Entry (before pressing the **A softkey)**

- g. Move the cursor to the *INTEG* field. The default integration mode, **MED**, is displayed in this field and the **SHORT**, **MED**, and **LONG** softkeys will be displayed.
- h. Press the **LONG** softkey to select the LONG integration mode.

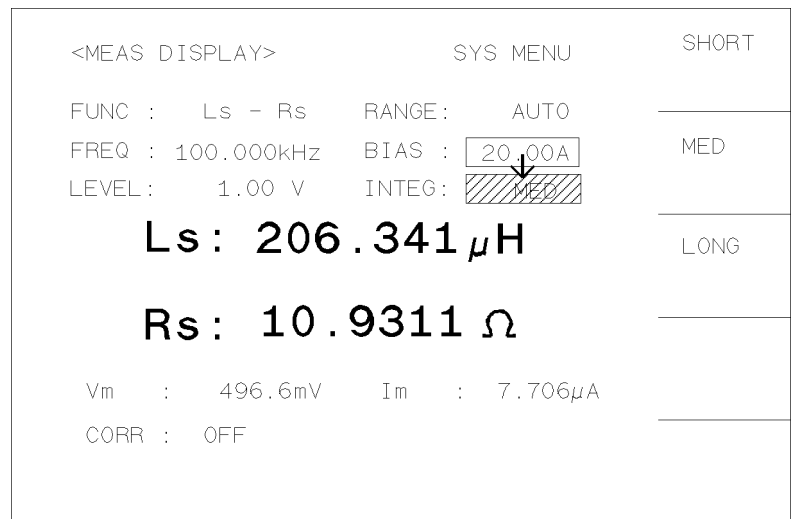

Figure 3-13. Moving Cursor to the *INTEG* Field

Note



These measurement conditions can also be set from the *MEAS SETUP* page displayed when the **MEAS SETUP** menukey is pressed. The setting operation on the *MEAS SETUP* page is the same as in the preceding steps (a) to (h).

- i. Press the **MEAS SETUP** menukey. The *MEAS SETUP* page is displayed.

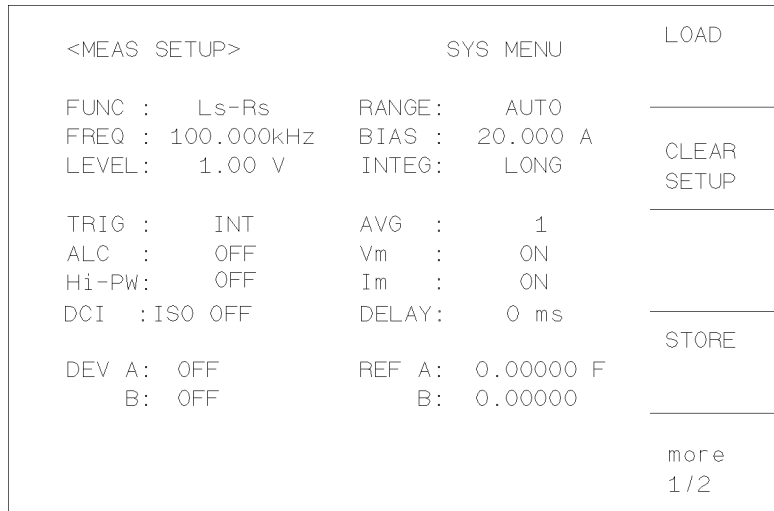

a40mr314

Figure 3-14. Select Measurement Setup Page

- j. Move the cursor to the *ALC* field. The default status of the *ALC* function, **OFF**, is displayed on this field, and the **ON** and the **OFF** softkeys are displayed.

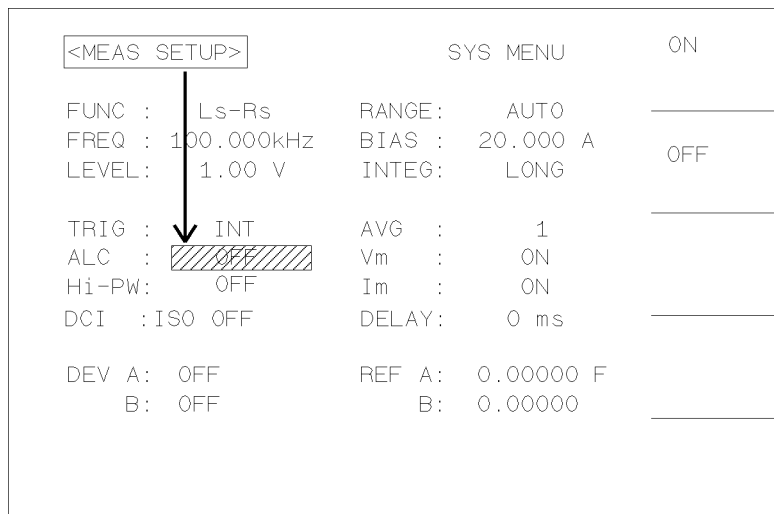

a40mr315

Figure 3-15. Move Cursor to the *ALC* field.

- k. Press the **ON** softkey to enable automatic leveling for the test signal voltage. An asterisk is displayed in the left most position of the *LEVEL* field.

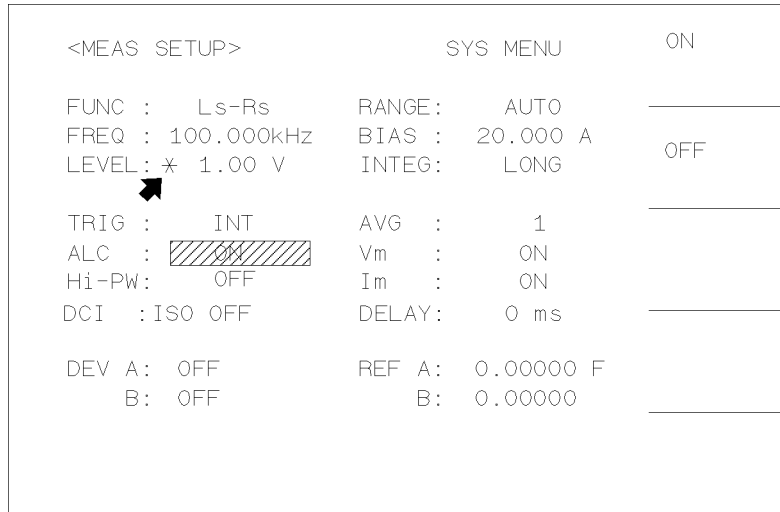

a40mr316

Figure 3-16. To Enable the Automatic Level Control Function

3. Perform a SHORT correction data measurement.

To compensate measurement errors due to residual impedance of the 42842A/B, a SHORT correction is required. Press the **MEAS SETUP** menukey and the **CORRECTION** softkey. The *CORRECTION* page is displayed.

- Move the cursor to the *CABLE* field. The current cable length is displayed on this field and the **0 m**, **1 m**, **2 m**, and **4 m** softkeys are displayed.
- Press the **1 m** softkey to set the cable length to 1 m.

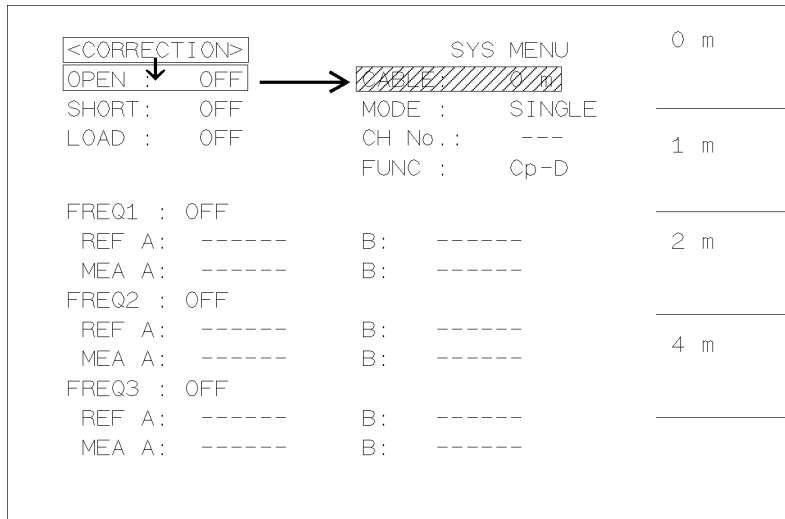

a40mr317

Figure 3-17. Set Cable Length

- c. Connect a shorting bar to the 42842A/B to set up the SHORT condition as shown in Figure 3-18.

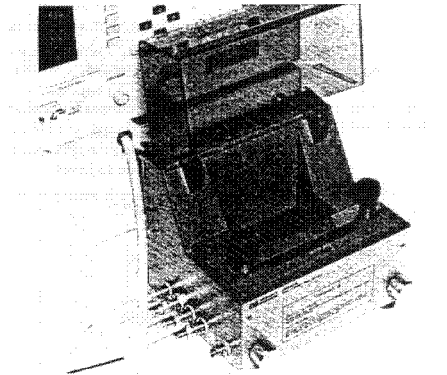
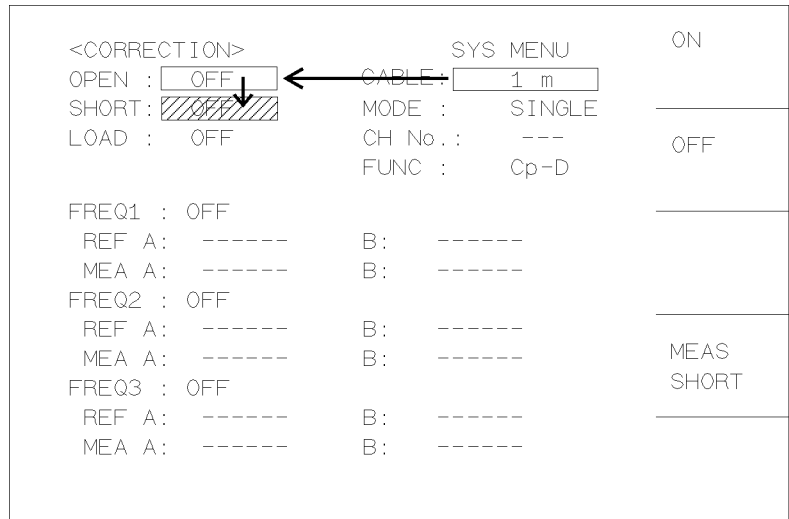

Figure 3-18. Connecting the Furnished Shorting Bar

- d. Move the cursor to the *SHORT* field. The **ON**, **OFF**, and **MEAS SHORT** softkeys is displayed.



a40mr319

Figure 3-19. Move the Cursor to the *SHORT* Field

- e. Press the **MEAS SHORT** softkey to perform the SHORT correction data measurement. It will take approximately 90 seconds. Wait until the 4284A beeps and displays the message **SHORT measurement completed.** on the system message line.
- f. Press the **ON** softkey to set the SHORT correction function to ON.

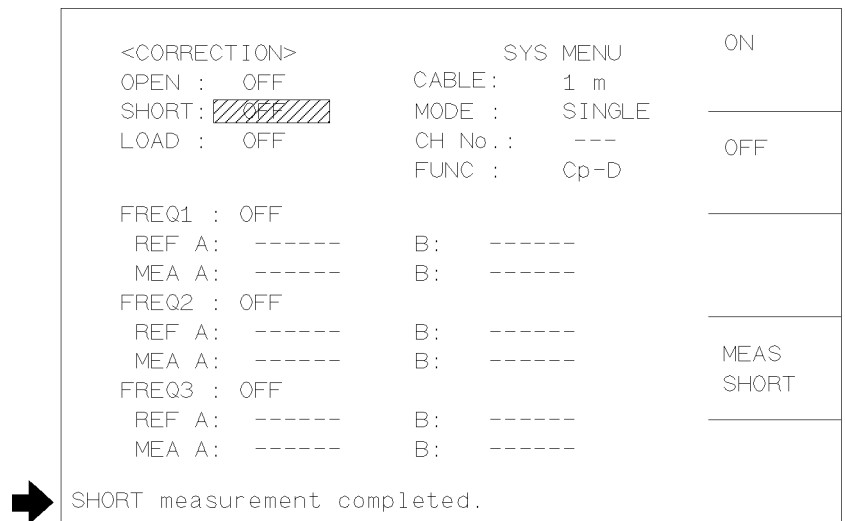

a40mr320

Figure 3-20.

System Message When the Short Measurement is Completed

Note



When you measure at a spot frequency, spot SHORT correction function is useful. Correction data at the spot frequency of a maximum of three frequency points you specify can be obtained quickly and easily.

4. Connect the DUT to the test fixture.

Connect the DUT to the 42842A/B measurement terminals and close the test fixture protective cover.

5. Enable the DC bias output.

Press the **DC BIAS** key on the 4284A front panel to turn the DC bias on. The DC bias on/off LED indicators of the 4284A and 42841A will come ON simultaneously.

6. Perform the measurement.

Press the **DISP FORMAT** menukey.

Measurements are triggered continuously by the internal trigger and the measured L_s and R_s values of the ferrite-cored inductor are displayed in large characters as shown in Figure 3-21.

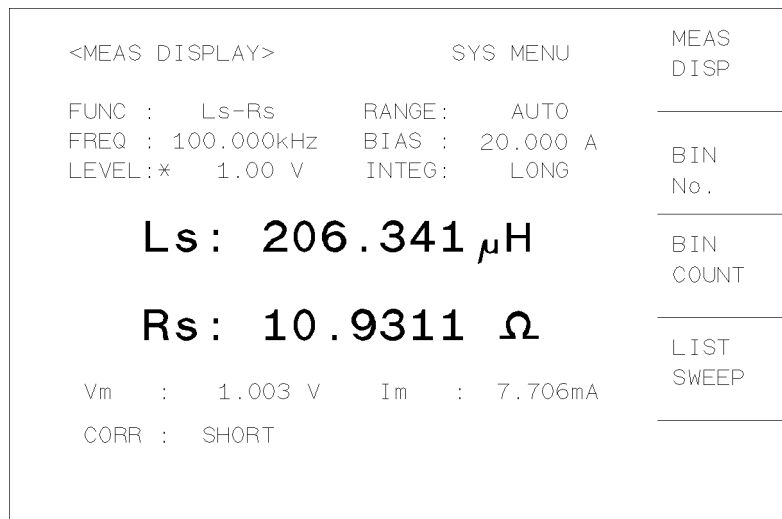

a40mr321

Figure 3-21. Ferrite-Cored Inductor Measurement Results

7. Disable the DC bias output.

When the measurement is finished, turn the DC bias off by pressing the **DC BIAS** key to prevent the DUT from overheating. The DC bias on/off LED indicators of the 4284A and 42841A will go off simultaneously.

DC Bias Current List Sweep

The 4284A's LIST SWEEP function allows setting of a maximum of ten frequency, test signal level, or DC bias voltage points. Also, DC bias current can be set when using with the 42841A. Figure 3-22 shows the measurement example of the DC bias current list sweep.

<LIST SWEEP DISPLAY>			SYS MENU	MEAS DISP
MODE :	SEQ			
BIAS [A]	Ls [H]	Rs [Ω]	CMP	BIN No.
10.00m	480.744u	95.4078		
20.00m	480.100u	95.1209		
40.00m	479.420u	94.8240		
100.00m	479.223u	94.7603		BIN COUNT
200.00m	479.860u	95.0813		
400.00m	480.517u	95.4147		
1.000	476.869u	93.9077		LIST SWEEP
2.000	464.542u	88.8160		
4.000	424.901u	73.5477		
10.000	306.412u	37.2422		

e40ur322

Figure 3-22. DC Bias Current List Sweep Result

Note



In the manual trigger mode, list sweep function holds the last measurement condition until it is changed. Set last point to the 0A to prevent the DUT from overheating.

Remote Control

This section provides information about the remote control capability of the 42841A.

The 42841A is fully controlled by the 4284A with Option 002 Bias Current Interface. The 4284A converts GPIB commands into control commands for the 42841A and outputs them to the 42841A via the bias current interface.

Error Messages for the 42841A used with the 4284A, refer to the *4284A Operation Manual, Appendix B, Error Message And System Message*.

Remote Control Capability

When combined with the 42841A, all remote control capabilities of the 4284A are available except for the limitations described in “Operation Limitations” on page 3-1. For the remote control capabilities of the 4284A, refer to the *4284A Operation Manual, Section 7, Remote Control*, and *Section 8, Command Reference*.

The following nine GPIB commands are available to control the 42841A.

BIAS:STATe ON(1)	<i>Turn the DC current bias on.</i>
BIAS:STATe OFF(0)	<i>Turn the DC current bias off.</i>
BIAS:STATe?	<i>Query the current DC current bias status.</i>
BIAS:CURRent <value>	<i>Set the DC current bias value.</i>
BIAS:CURRent?	<i>Query the current DC current bias value.</i>
BIAS:CURRent MAX	<i>Set the maximum DC current bias value.</i>
BIAS:CURRent? MAX	<i>Query the maximum DC current bias value.</i>
BIAS:CURRent MIN	<i>Set the minimum DC current bias value.</i>
BIAS:CURRent? MIN	<i>Query the minimum DC current bias value.</i>

Sample Program

A typical DC biased measurement program is listed below. This program applies the DC bias from 1A to 20A in 1A steps and displays measurement result. This program is written in HP 9000 series 200/300 BASIC statements.

Here, it assumed that the 4284A's GPIB address is 717.

```
10  Lcr=717
20  OUTPUT Lcr;"*RST;*CLS"           Initialize the 4284A.
30  OUTPUT Lcr;"CORR:LENG 1;METH SING"
40  OUTPUT Lcr;"CORR:OPEN:STAT OFF"
50  OUTPUT Lcr;"CORR:LOAD:STAT OFF"
60  OUTPUT Lcr;"SPOT1:STAT OFF"
70  OUTPUT Lcr;"SPOT2:STAT OFF"
80  OUTPUT Lcr;"SPOT3:STAT OFF"
90  OUTPUT Lcr;"FUNC:IMP LSRS;:APER LONG"
100 OUTPUT Lcr;"INIT:CONT ON;:TRIG:SOUR BUS"
110 OUTPUT Lcr;"BIAS:STAT ON"       Enable the DC bias.
120 FOR I=1 TO 20                   Measure from 1A to 20A in 1A steps.
130   OUTPUT Lcr;"BIAS:CURR ";VAL$(I) Set the bias current value.
140   OUTPUT Lcr;"*TRG"             Trigger the instrument.
150   ENTER Lcr;A,B,C               Get result.
160   PRINT I,A,B                   Display result.
170 NEXT I
180 OUTPUT Lcr;"BIAS:STAT OFF"     Disable the DC bias when finished.
190 LOCAL Lcr                       Release the 4284A.
200 END
```

General Information

Introduction

This section describes specifications, supplemental performance characteristics, storage/repackaging, and other general information about the 42841A.

Serial Number

Agilent Technologies uses a two-section, nine character serial number which is stamped on the serial number plate (Figure 4-1) attached to the instrument's rear panel. The first four digits and a letter are the serial number prefix, and the last five digits are the suffix. The letter placed between the two sections identifies the country where the instrument was manufactured. The prefix is the same for all identical instruments; it changes only when a change is made to the instrument. The suffix, however, is assigned sequentially and is different for each instrument. The contents of this manual applies to instruments with the serial number prefix(es) listed under the serial numbers on the title page.



Figure 4-1. Serial Number Plate

An instrument manufactured after the printing of this manual may have a serial number prefix which indicates that the instrument is different from those described in this manual. The manual for this new instrument may be accompanied by a yellow Manual Change supplement or have a different manual part number. This sheet contains “change information” that explains how to adapt the manual to the newer instruments.

In addition to change information, the supplement may contain information for correcting errors (Errata) in the manual. To keep this manual as current and accurate as possible, Agilent Technologies recommends that you periodically request the latest Manual Changes supplement. The supplement for this manual is identified by this

manual's printing date and its part number, both of which appear on the manual's title page. Complimentary copies of the supplement are available from Agilent Technologies. If the serial prefix or number of an instrument is lower than that on the title page of this manual, see

For information concerning, a serial number prefix that is not listed on the title page or in the Manual Change supplement, contact the nearest Agilent Technologies office.

Specifications

The complete 42841A specifications are described below. These specifications are the performance standards or limits against which the 42841A is tested. When shipped from the factory, the 42841A meets the specifications listed in this section. The specification test procedures are covered in Chapter 5.

DC Bias Current Output

The 42841A covers from 0.00A to 20.0A in three ranges.

Table 4-1. DC Bias Current Accuracy

Range	Resolution	Accuracy ¹
0.00A to 1.00A	0.01A	1% + 5mA
1.1A to 5.0A	0.1A	2%
5.1A to 20.0A	0.1A	3%

¹ \pm (% of setting + offset current)

Specified for an ambient temperature range of 23°C \pm 5°C. Add the following temperature induced setting error for the temperature range of 0°C to 55°C.

Temperature (°C)	0	8	18	28	38	55
Additional Error	1.5%	0.5%	0%	0.5%	1.5%	

Figure 4-2. Temperature Induced Setting Error

Output Voltage

Depends on the DC resistance of Device Under Test. Maximum voltage is shown in Figure 4-3

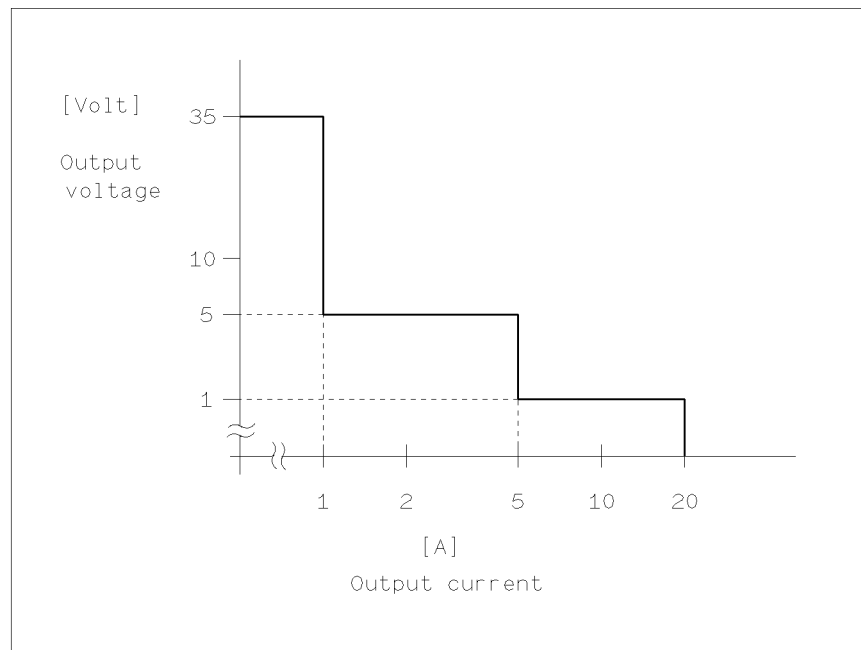

Figure 4-3. DC Bias Output Range

Applicable Test Signal

4284A or 4285A test signal voltage setting is 0.5V to 2V_{rms}.

Interface

Digital interface for connection to an Option 002 of 4284A or an Option 002 of 4285A.

Other Options

Option 907:	Front Handle Kit
Option 908:	Rack Mount Kit
Option 909:	Rack Flange and Handle Kit

Furnished Accessories

Bias Current Interface Cable	Agilent Part Number 42841-61640
Operation Manual	Agilent Part Number 42841-90000
Power Cord	Depends on the country where the 42841A is being used. Refer to Figure 1-1.

Test Fixtures	42842A Bias Current Test Fixture (for 4284A 20A system) 42842B Bias Current Test Fixture (for 4284A 40A system) 42842C Bias Current Test Fixture (for 4285A)
Other Accessories	42843A Bias Current Cable (for 40A system)
Line Voltage	100, 120, 220V \pm 10%, 240V +5%-10%
Line Frequency	47 to 66Hz
Power Consumption	600VA max.
Operating Temperature	0°C to 55°C
Operating Humidity	RH \leq 95% at 40°C
Operating Altitude	0 m to 2000 m
Dimensions	426(W) by 177(H) by 498(D) (mm)
Weight	18 kg

Supplemental Performance Characteristics

The 42841A measurement accuracy represent characteristics are listed below. Supplemental performance characteristics are not specifications, but are typical characteristics included as supplemental information for the operator.

42841A Measurement Accuracy (used for 4284A)

The measurement range of the 4284A is limited to 10 Ω and 100 Ω when used with the 42841A and 42842A/B. Measurement accuracy of inductance(L), impedance(|Z|), series resistance (Equivalent Series Resistance; R_s), D, and θ when the 42841A is used with the 4284A and 42842A/B are as follows:

L and |Z| Accuracy : A_e (for L accuracy; D_x \leq 0.1)

$$A_e = A_0 + A_1 [\% \text{ of reading}]$$

Where,

- A_0 : L and $|Z|$ accuracy of the 4284A when used with the 42841A. A_0 is determined from the measurement accuracy lines shown in Figure 4-4. Select the proper accuracy line in Figure 4-5. When the test signal voltage level is not on the three points listed in Figure 4-5, linear interpolation is required from the nearest two measurement accuracy points to determine the measurement accuracy to be applied.
- A_1 : L and $|Z|$ additional error of the 42842A/B.
- D_x : Measured D value.

When $D_x > 0.1$, multiply A_1 by $\sqrt{1 + D_x^2}$ for L accuracy.

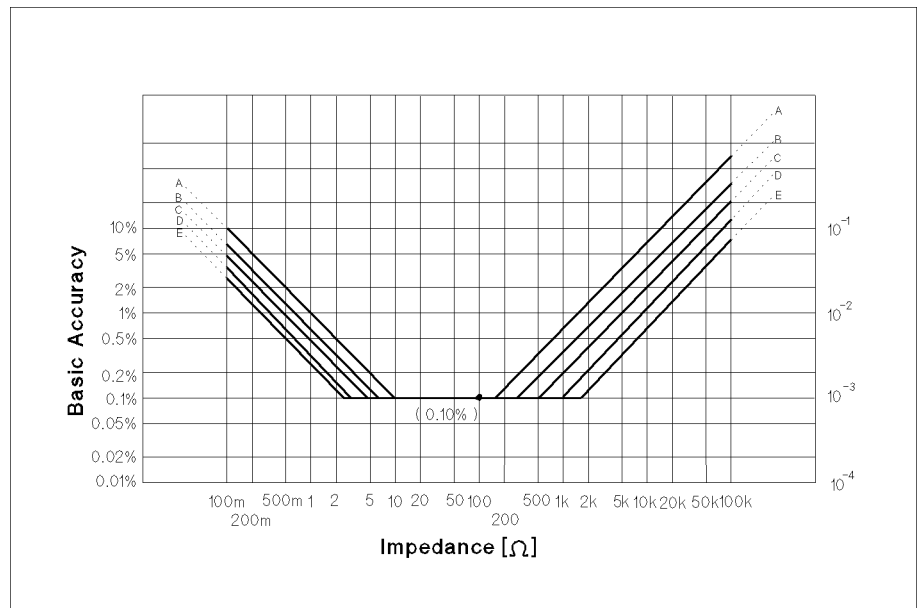

Figure 4-4. 4284A Accuracy

Test Signal Voltage	Temperature(°C)					
	5	8	18	28	38	45
0.5Vrms	A	B	C	B	A	
1Vrms	B	C	D	C	B	
2Vrms	C	D	E	D	C	

Figure 4-5. 4284A Basic Accuracy Line Selection Chart

D Accuracy : D_e ($D_x \leq 0.1$)

$$D_e = \frac{A_e}{100}$$

Where,

A_e : L and |Z| measurement accuracy

D_x : Measured D value.

When $D_x > 0.1$, multiply D_e by $(1 + D_x)$ for D accuracy.

 θ Accuracy : θ_e

$$\theta_e = \frac{180 \times A_e}{\pi \times 100} [^\circ]$$

 R_s (Equivalent Series Resistance) Accuracy : R_{se} ($D_x \leq 0.1$)

$$R_{se} = 2\pi f L_x \times D_e [\Omega]$$

Where,

f : Measurement frequency [Hz]

L_x : Measured inductance [H]

D_e : D measurement accuracy

**Additional Error Caused
by 42842A/B**

The 42841A measurement accuracy represents the tolerance of additional errors to the 4284A's accuracy and applies at the 42842A/B's measurement terminals when all the following conditions are satisfied,

- 4284A Integration mode : LONG
- Test signal voltage setting : 1Vrms
- Test cable : 16048A
- Test cable length : 1 m
- SHORT compensation has been performed.
- Ambient temperature : 23°C ± 5°C
- Dissipation factor of the DUT is less than 1

L and |Z| Additional Error (for L accuracy; $D_x < 0.1$)

L and |Z| accuracy, A_1 , is read from the figures listed in Table 4-2 depending on the measurement conditions and the system configuration.

Where,

D_x : D measurement accuracy

When $0.1 \leq D_x < 1$, multiply A_1 by $\sqrt{1 + D_x^2}$ for L accuracy.

For ambient temperature range of 5°C to 45°C, add the temperature induced error given in Figure 4-8 of Figure 4-11, to A_1 value.

Table 4-2. Accuracy Chart Selection Table

	20A Configuration	40A Configuration
Inductance $L-D, R_s$	Figure 4-7	Figure 4-10
Impedance $ Z -\theta$	Figure 4-8	Figure 4-11
Temperature Induced Error	Figure 4-9	Figure 4-12

Note



The error represented by the following equations has already been factored into the error model in “42841A Measurement Accuracy (used for 4284A)”. So, the operator does not have to make these calculate when only the system accuracy is required.

D Additional Error : D_1 ($D_x < 0.1$)

D_1 Additional error is given as,

$$D_1 = \frac{A_1}{100}$$

Where,

D_x : Measured D value

When $0.1 \leq D_x < 1$, multiply D_1 by $1 + D_x$ for D accuracy.

 θ Additional Error : θ_1

$$\theta_1 = \tan^{-1} D_1 [^\circ]$$

Where,

D_1 : D Additional error

 R_s (Equivalent Series Resistance) Additional Error : R_{s1} ($D_x < 0.1$)

R_s additional error, R_{s1} is given as,

$$R_{s1} = 2\pi f L_x \times D_1$$

Where,

L_x : Measured inductance [H]

D_1 : D additional error

D_x : Measured D value

f : Measurement frequency

Note

The upper 2% accuracy lines at frequencies above 1kHz can be gotten by drawing line at double the inductance values of the upper 1% lines.

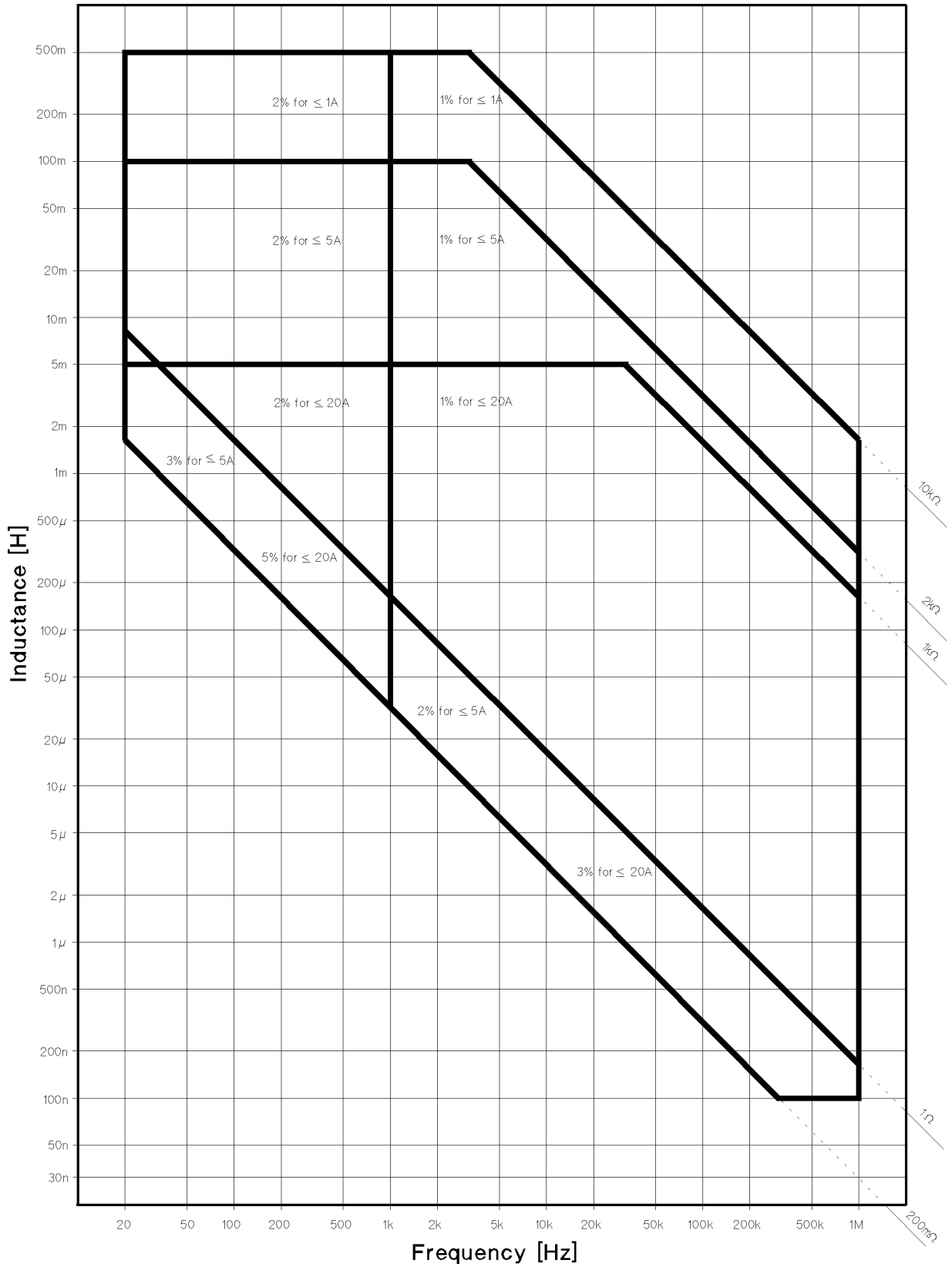

Figure 4-6. Inductance measurement accuracy of 42841A (20A Configuration)

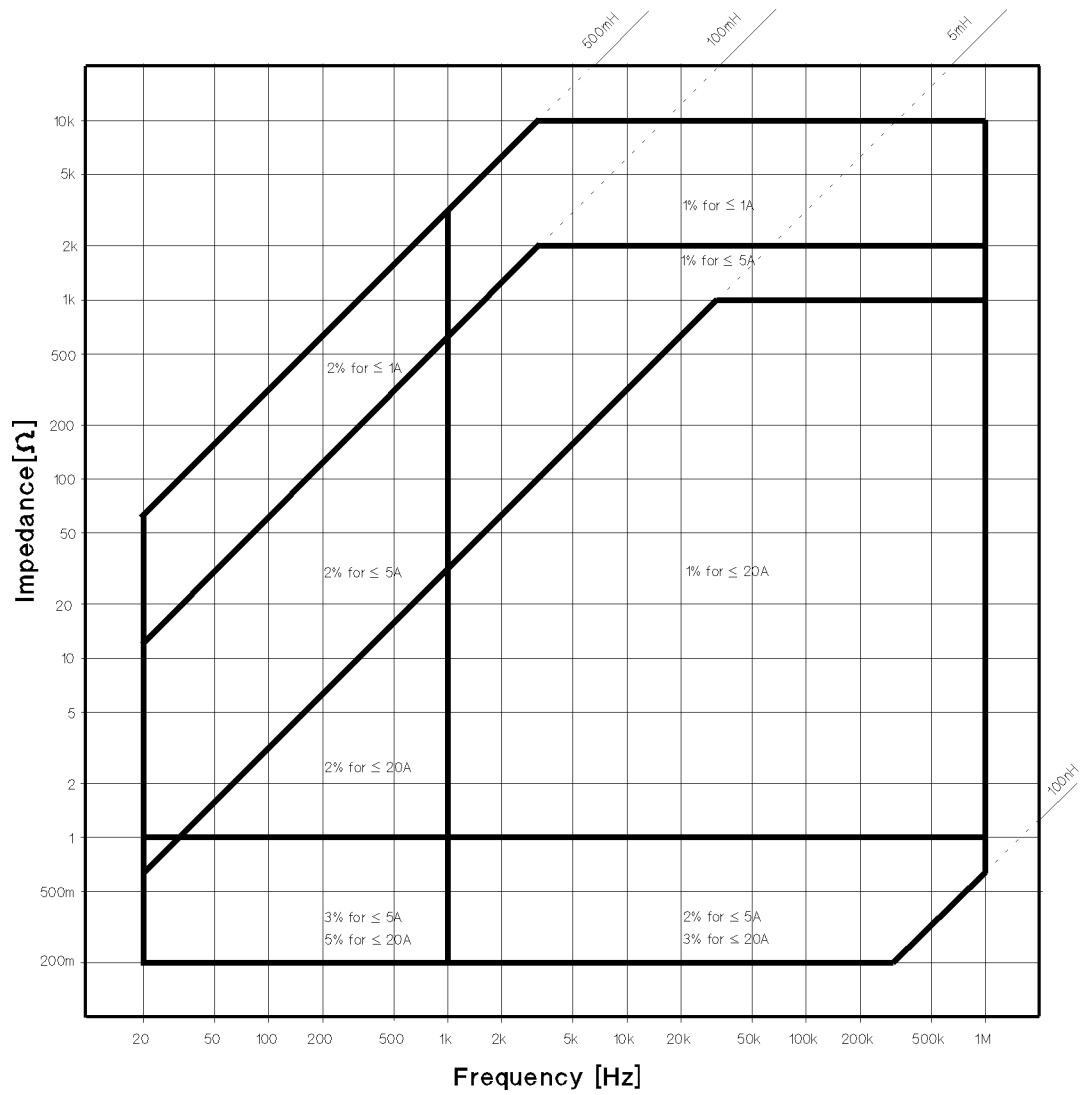

Figure 4-7. Impedance measurement accuracy of 42841A (20A Configuration)

Temperature (°C)	5	8	18	28	38	45 ^x
Additional Error	2%	1%	0%	1%	2%	

Figure 4-8. Temperature additional error of 42841A (20A Configuration)

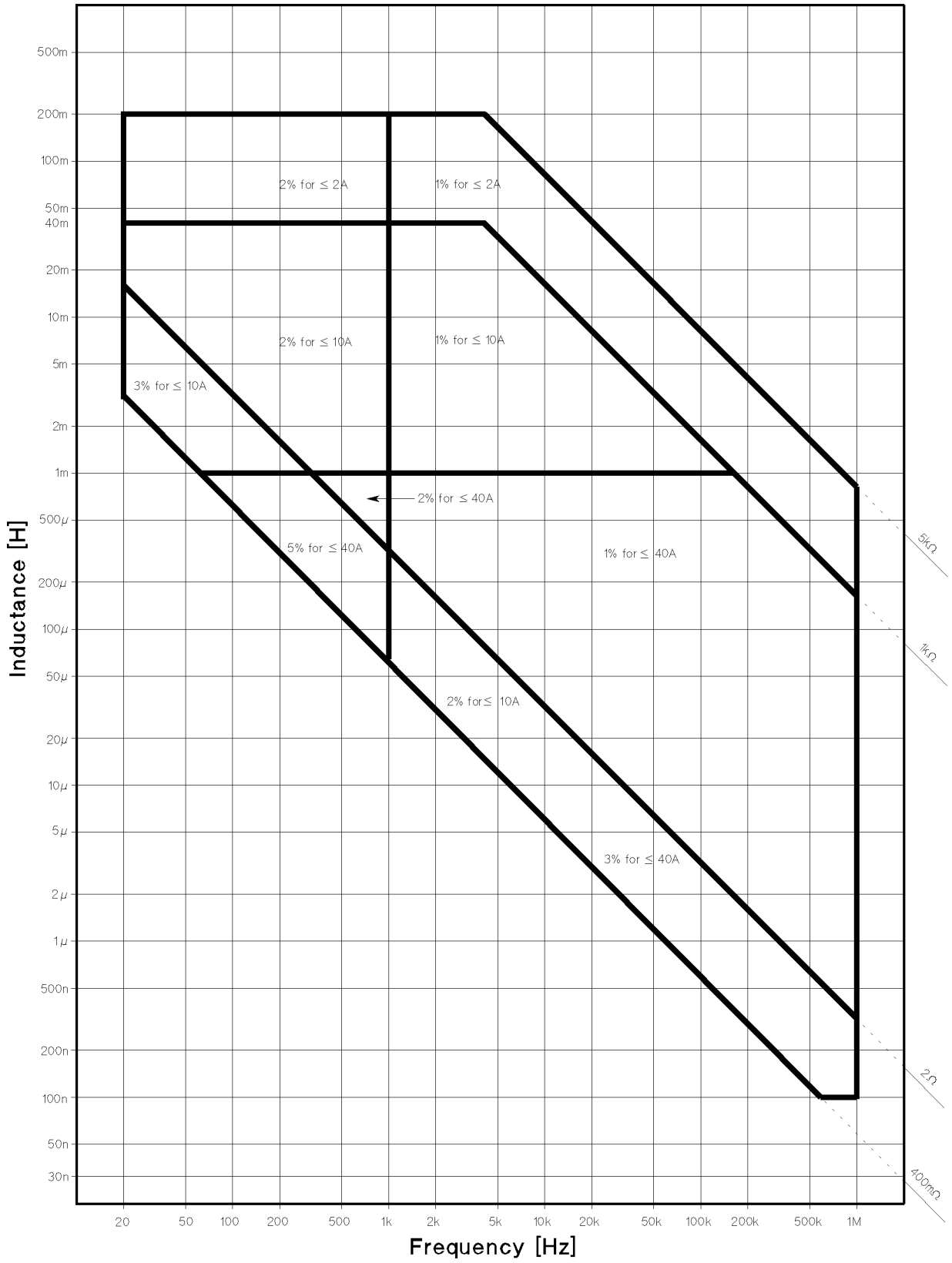

Figure 4-9. Inductance measurement error of 42841A (40A Configuration)

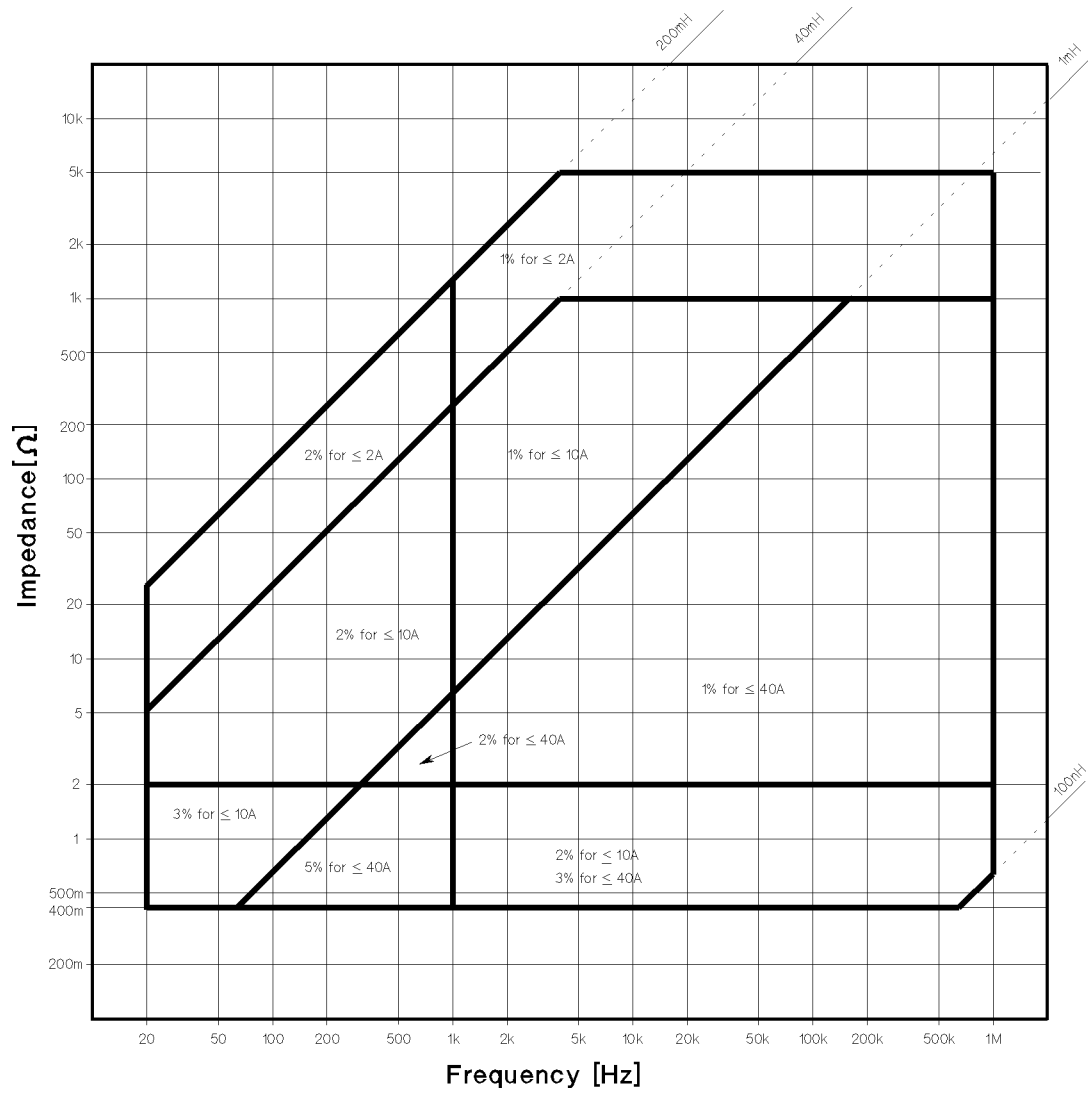

Figure 4-10. Impedance measurement accuracy of 42841A (40A Configuration)

Temperature (°C)		5	8	18	28	38	45
Additional Error	$I_{bias} \leq 10[A]$	3.0%	1.5%	0%	1.5%	3.0%	
	$I_{bias} \leq 40[A]$	4.0%	2.0%	0%	2.0%	4.0%	

Figure 4-11. Temperature additional error of 42841A (40A Configuration)

Measurement Accuracy (used for 4285A)

Measurement accuracy of inductance (L), impedance ($|Z|$), series resistance (Equivalent Series Resistance: R_s), D, and θ when the 42841A is used with an 4285A and 42842C are as follows:

L and $|Z|$ Accuracy : A_e (for L accuracy; $D_x \leq 0.1$ or $Q_x \geq 10$)

$$A_e = A_0 + A_1 + A_2 + A_3 \text{ [% of reading]}$$

Where,

A_0 : L and $|Z|$ accuracy of the 4285A when 1 m cable is used [%]. Refer to the specifications in *4285A Operation Manual* (Agilent Part Number 04285-90000).

A_1 : L and $|Z|$ additional error of the 42842C [%]. Refer to “42842C Additional Error”.

A_2 : L and $|Z|$ additional error caused by residuals of 42842C [%];

$$= \left(\frac{40nH}{L_x} + 2 \times f_m^2 \times L_x \right) \times 100$$

When SMD Test Fixture is used;

$$= \left(\frac{10nH}{L_x} + 1.2 \times f_m^2 \times L_x \right) \times 100$$

A_3 : Additional error caused by SMD Test Fixture [%];

$$= \sqrt{\frac{f_m}{10}}$$

f_m : Measurement frequency [MHz]

L_x : Measured inductance [H]

D_x : Measured D value

When $D_x > 0.1$, multiply A_e by $\sqrt{1 + D_x^2}$ for L and $|Z|$ accuracy.

D Accuracy : D_e ($D_x \leq 0.1$)

$$D_e = \frac{A_e}{100}$$

Where,

A_e : L and $|Z|$ measurement accuracy

D_x : Measured D value

When $D_x > 0.1$, multiply D_e by $(1 + D_x)$ for D accuracy.

θ Accuracy : θ_e

$$\theta_e = \frac{180 \times A_e}{\pi \times 100} [^\circ]$$

A_e : L and |Z| measurement accuracy

R_S (Equivalent Series Resistance) Accuracy : R_e

$$R_e = 2\pi f L_x \times \frac{A_e}{100} + (2 + 7 \times \sqrt{f_m}) \times 10^{-3} [\Omega]$$

When an SMD Test Fixture is used:

$$R_e = 2\pi f L_x \times \frac{A_e}{100} + 0.005 [\Omega]$$

Where,

f : Measurement frequency [Hz]

L_x : Measured inductance [H]

A_e : L and |Z| measurement accuracy

42842C Additional Error

The 42841A and 42842C additional error represents the tolerance of additional error to the 4284A's accuracy and applies at the 42842C measurement terminals when all the following conditions are satisfied.

- 4285A Integration mode : LONG
- Test signal voltage setting : 0.5V to 2V_{rms}
- Test cable : 16048A
- Test cable length : 1 m
- Cable Correction and SHORT compensation has been performed.
- Ambient temperature : 0 to 45°C
- Dissipation factor of the DUT is less than 1

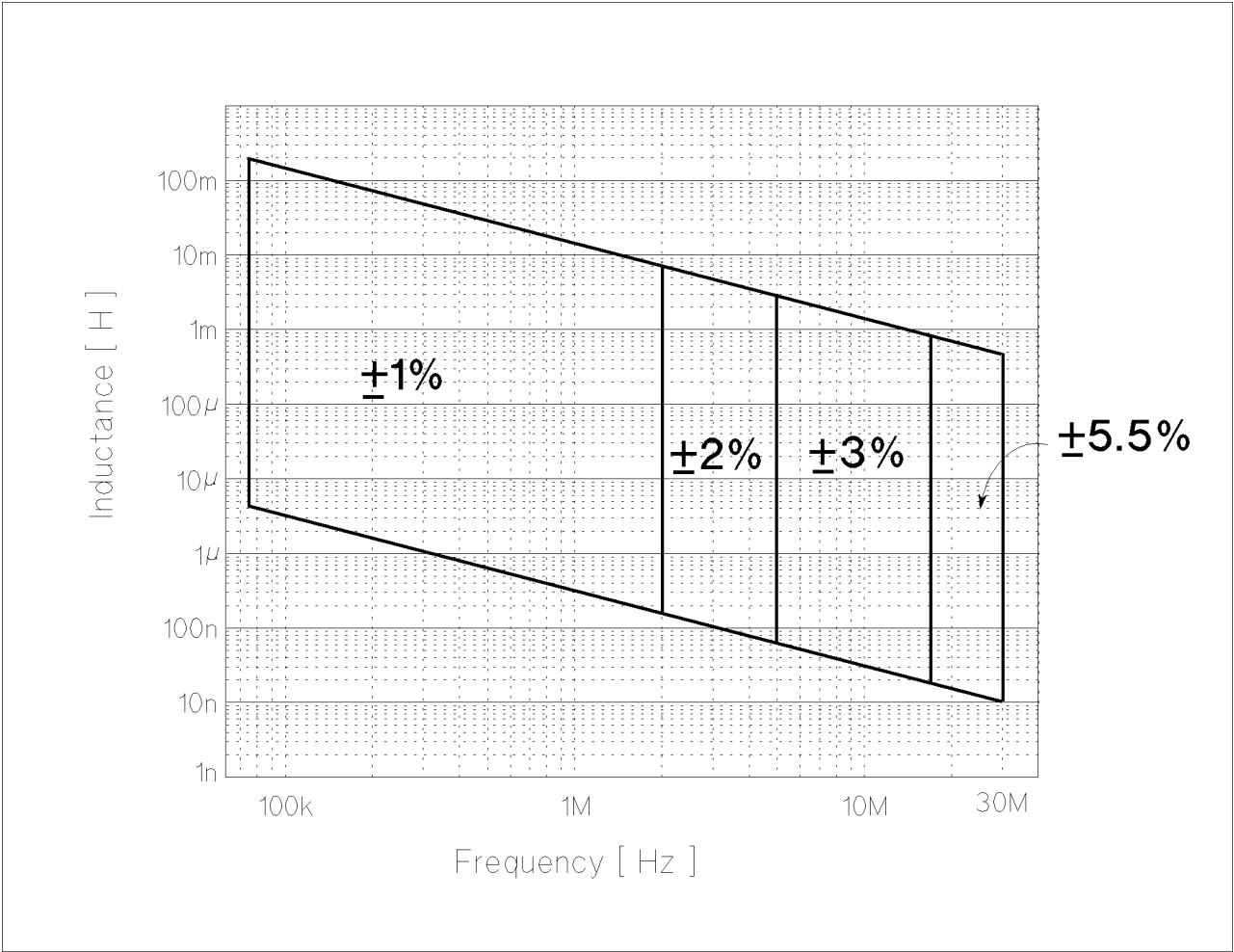

a40mr412

Figure 4-12. Additional Inductance Error of the 42842C

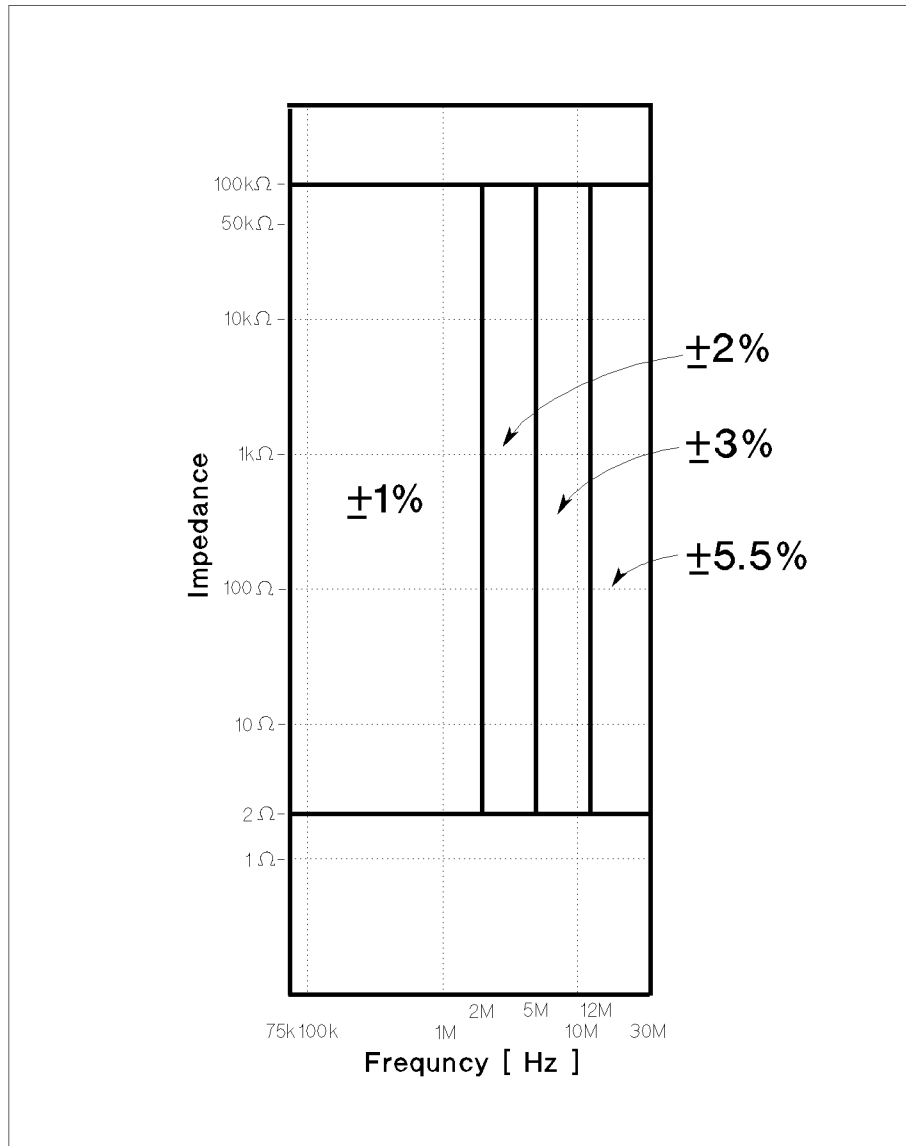

Figure 4-13. Additional Impedance Error of the 42842C

L and |Z| Additional Error: A₁

L and |Z| additional error, A₁, is read from Figure 4-12 and Figure 4-13 respectively.

L additional error applies when D_x (measured D value) < 0.1.

Note



The error represented by the following equations has already been factored into the error model in “Measurement Accuracy (used for 4285A)”. So, the operator does not have to make these calculate when only the system accuracy is required.

D Additional Error

When D_x (measured D value) < 0.1, D additional error, D₁, is given as follows,

$$D_1 = \frac{A_1}{100}$$

Where,

A₁ : L and |Z| additional error

θ Additional Error : θ₁

θ additional error, θ₁, is given as follows,

$$\theta_1 = \tan^{-1} D_1 [^\circ]$$

Where,

D₁ : D additional error

R_s (Equivalent Series Resistance) Additional Error : R₁

When D_x (measured D value) < 0.1, R_s additional error, R₁, is given as follows,

$$R_1 = (2\pi f L_x \times D_1) [\Omega]$$

Where,

f : Measurement frequency [Hz]

L_x : Measured inductance [H]

D₁ : D additional error

Bias Current Settling Time

Typical time required for the bias current to reach 99% of setting from zero amperes is given as

$$\text{Bias current } \leq 1\text{A: } 1 \text{ s} \times I_{\text{bias}} + 0.6 \text{ s}$$

$$\text{Bias current } \leq 5\text{A: } 0.2 \text{ s} \times I_{\text{bias}} + 0.6 \text{ s}$$

$$\text{Bias current } > 5\text{A: } 0.1 \text{ s} \times I_{\text{bias}} + 0.6 \text{ s}$$

where, I_{bias} is the bias current setting in amperes.

Signal Voltage ALC Operation Area

ALC function of the 4284A is operational to $1V_{\text{rms}}$ on the 1A range of the 42841A. On the other ranges, the available ALC operating area varies depending on the applied current bias, the test frequency, and the DUT's impedance.

Measurement Error Calculation Example

This example calculates L_s - R_s measurement accuracy.

Measurement Conditions:

- DUT: 10 mH
- Test signal level: $1V_{\text{rms}}$
- Test frequency: 1kHz
- Integration time: LONG
- Short compensation: Performed
- DC current bias: 5A
- Operating temperature: 28°C

Inductance measurement accuracy A_e , and series resistance (Equivalent Series Resistance) measurement accuracy R_e of the HP 4284A when used with the 42841A are derived using the following equations respectively.

$$A_e = A_0 + A_1$$

$$R_e = R_0 + R_1$$

Where, A_0 is L and $|Z|$ accuracy of the 4284A.

R_0 is R_s (ESR) accuracy of the 4284A.

A_1 is L and $|Z|$ accuracy of the 42841A.

R_1 is R_s (ESR) accuracy of the 42841A.

Step 1:

Determine A_0 and R_0 of the 4284A when using with the HP 42841A.

1. DUT's inductance is 10 mH, so the measurement impedance Z_m is

$$\begin{aligned} Z_m &= 2\pi f_m L_x \\ &\approx 62.8 \quad [\Omega] \end{aligned}$$

Where, f_m is test frequency.

L_x is DUT's measured inductance value.

2. Determine measurement accuracy line from Figure 4-5 to be applied to Figure 4-4.

Line D is selected from the operating temperature of 28°C, and test signal voltage of 1V_{rms}.

3. Find the impedance along the x axis.
4. Mark the intersection of the above two steps. Both axes are in log format. Interpolation may be required.
5. Determine A_0 by extrapolating horizontally to the vertical basic accuracy axis.

$$A_0 = 0.10 \quad [\%]$$

$$\begin{aligned} D_0 &= \frac{A_0}{100} \\ &= \frac{0.10}{100} \\ &= 0.001 \end{aligned}$$

$$\begin{aligned} R_0 &= (2\pi f L_x \times D_0) \\ &= (2\pi \times 1000 \times 0.01 \times 0.001) \\ &\approx 0.063 \quad [\Omega] \end{aligned}$$

Step 2:

Determine the 42841A's additional error, L_1 .

1. Choose an accuracy chart from Table 4-2. Figure 4-6 is chosen for the 20A configuration and L_s - R_s measurement.
2. Find the frequency along the X axis in Figure 4-6.
3. Find the Inductance along the Y axis in Figure 4-6.
4. Mark the intersection of above two steps. Both axis are in log format. Interpolation may be required.
5. Determine L_1 . When a value falls at a boundary line, apply the better value. Confirm the DC current bias applying to the DUT. It must be less than the maximum DC current bias on the marked area.

Test frequency = 1kHz, $L_x = 10$ mH, and DC current bias = 5A, therefore:

$$L_1 = 1 \quad [\%]$$

Step 3:

Determine the 42841A's temperature induced error, K_1 , from Figure 4-8, and derive R_1 .

Operating temperature = 28°C, therefore:

$$K_1 = 0 \quad [\%]$$

From L_1 and K_1

$$\begin{aligned} A_1 &= L_1 + K_1 \\ &= 1 + 0 \\ &= 1 \quad [\%] \end{aligned}$$

$$\begin{aligned} D_1 &= \frac{A_1}{100} \\ &= \frac{1}{100} \\ &= 0.01 \end{aligned}$$

Test frequency = 1kHz, $L_x = 10$ mH, and $D_1 = 0.01$ therefore:

$$\begin{aligned} R_1 &= (2\pi f L_x \times D_1) \\ &= 2\pi \times 1000 \times 0.01 \times 0.01 \\ &\approx 0.63 \quad [\Omega] \end{aligned}$$

Therefore, the 4284A's measurement accuracy when used with the 42841A and 42842A/B is:

$$\begin{aligned} A_e &= A_0 + A_1 \\ &= (0.1 + 1) \\ &= 1.1 \quad [\%] \end{aligned}$$

$$\begin{aligned} R_e &= R_0 + R_1 \\ &= (0.063 + 0.63) \\ &= 0.693 \quad [\Omega] \end{aligned}$$

Storage and Repacking

This paragraph describes the environment for storing or shipping the 42841A, and how to repack it for shipment when necessary.

Environment

The 42841A should be stored in a clean, dry environment. The following environmental limitations apply for both storage and shipment.

Temperature: -20°C to 60°C
Humidity: ≤95% RH (at 40°C)

To prevent condensation from taking place on the inside of the 42841A, protect the instrument against temperature extremes.

Original Packaging

Containers packing materials identical to those used in factory packaging are available through your closest Agilent Technologies. For servicing, attach a tag indicating the service required, the return address, the model number, and the full serial number. Mark the container *FRAGILE* to help ensure careful handling. In any correspondence, refer to the instrument by model number and its full serial number.

Other Packaging

The following general instructions should be used when repacking with commercially available materials:

1. Wrap the 42841A in heavy paper or plastic. When shipping to a Agilent Technologies sales office or service center, attach a tag indicating the service required, return address, model number, and the full serial number.
2. Use a strong shipping container. A double-walled carton made of at least 350 pound test material is adequate.
3. Use enough shock absorbing material (3 to 4 inch layer) around all sides of the instrument to provide a firm cushion and to prevent movement inside the container. Use cardboard to protect the front panel.
4. Securely seal the shipping container.
5. Mark the shipping container *FRAGILE* to help ensure careful handling.
6. In any correspondence, refer to the 42841A by model number and by its full serial number.

This ISM device complies with Canadian ICES-001.
Cet appareil ISM est conforme à la norme NMB-001 du Canada.

Performance Test

Introduction

This section provides the test procedures used to be sure that the 42841A meets the specifications listed in Chapter 4. All tests can be performed without accessing the interior of the instrument.

Performance tests are used to perform incoming inspection and to be sure that the 42841A is within its performance specifications after troubleshooting or adjustments have been performed.

If the performance tests show that the 42841A is not within specifications, check your test setup, then proceed to Adjustment or Troubleshooting as required. The adjustment and troubleshooting information are included in the 42841A Service Manual.

Note



Allow the 42841A to warm up for a minimum of 5 minutes before starting the performance test.

Note



The performance tests are valid only when performance in an ambient temperature of $23^{\circ}\text{C} \pm 5^{\circ}\text{C}$.

Test Equipment

The test Equipment required for the performance test is listed in Table 5-1. Use only calibrated test equipment when performance testing the 42841A.

If the recommended test Equipment is not available, Equipment with specifications equal to or surpassing those of the recommended test equipment may be used.

Table 5-1. Recommended Test Equipment

Equipment	Requirement	Recommended Model	Qty
Resistance Meter	Range: up to 1Ω Accuracy: ≤ ± 0.5% at 50mΩ ≤ ±0.2% at 200mΩ ≤ ±0.05% at 1Ω	3458A	1
DC Voltmeter	Range: up to 1V Accuracy: ≤ ±0.05%	3458A	1
LCR Meter	No substitute	4284A(opt. 002) or 4285A(opt. 002)	1
50mΩ Resistor	No substitute	Agilent PN 42841-65100	1
200mΩ Resistor	No substitute	Agilent PN 42841-65101	1
1Ω Resistor	No substitute	Agilent PN 42841-65102	1
Test Lead	Low thermal, banana to banana	11058A	2

Performance Test Record

Record the results of the performance test in the Performance Test Record, located at the end of this chapter. Keep a record of past test results for comparison purpose to help showing any possible areas of developing trouble.

Note

The test limit shown in the performance test does not consider the measurement errors induced by the test equipment used. Be sure to consider this when determining whether the 42841A meets its shown specifications or not.

Calculation Sheet

The Calculation Sheet is used to as an aid for recording raw measurement data, and calculating the performance test result. Photocopy the calculation sheet, and use it to calculate the test result according to the performance test procedure.

Calibration Cycle

The 42841A requires periodic performance proof. How often you verify performance depends on the operating and environmental conditions. Check the 42841A using the performance test described in this manual at least once a year. To reduce instrument down-time and to insure best operation, perform preventive maintenance and calibration at least twice a year.

DC Bias Current Accuracy Test

This test makes be sure that the 42841A's DC Bias Current meets specifications. Table 5-2 lists the 42841A's DC Bias Current accuracy specifications. The accuracy is specified for an ambient temperature range of $23^{\circ}\text{C} \pm 5^{\circ}\text{C}$.

Table 5-2. Bias Current Accuracy Specification

Current Range	Accuracy
0.00A to 1.00A	$\pm(1\%+5\text{mA})$
1.1A to 5.0A	$\pm 2\%$
5.1A to 20A	$\pm 3\%$

Test Equipment Table 5-3 shows the recommended performance test equipment.

Table 5-3. Recommended Test Equipment

Equipment	Requirements	Recommended Model	Qty
DC Voltmeter	Range: up to 1V, Accuracy: $\leq \pm 0.05\%$	3458A	1
LCR Meter	No substitute	4284A (opt. 002) or 4285A (opt. 002)	1
50m Ω Resistor	No substitute	Agilent PN 42841-65100	1
200m Ω Resistor	No substitute	Agilent PN 42841-65101	1
1 Ω Resistor	No substitute	Agilent PN 42841-65102	1
Test Lead	Low thermal, banana to banana	11058A	1

Note



When bias current is applied to the Resistor Box, the resistor box heats and its resistance value changes. The Resistor Boxes are designed to perform the DC Bias Current Accuracy Test, considering the resistance value change caused by applying bias current. The value of resistance changes for the 50m Ω , 200m Ω and 1 Ω Resistor Boxes are:

- 50m Ω Resistor Box: Resistance change=0.2% (Typical value, at 20A DC bias)
 - 200m Ω Resistor Box: Resistance change=0.15% (Typical value, at 5A DC bias)
 - 1 Ω Resistor Box: Resistance change=0.05% (Typical value, at 1A DC bias)
-

Procedure

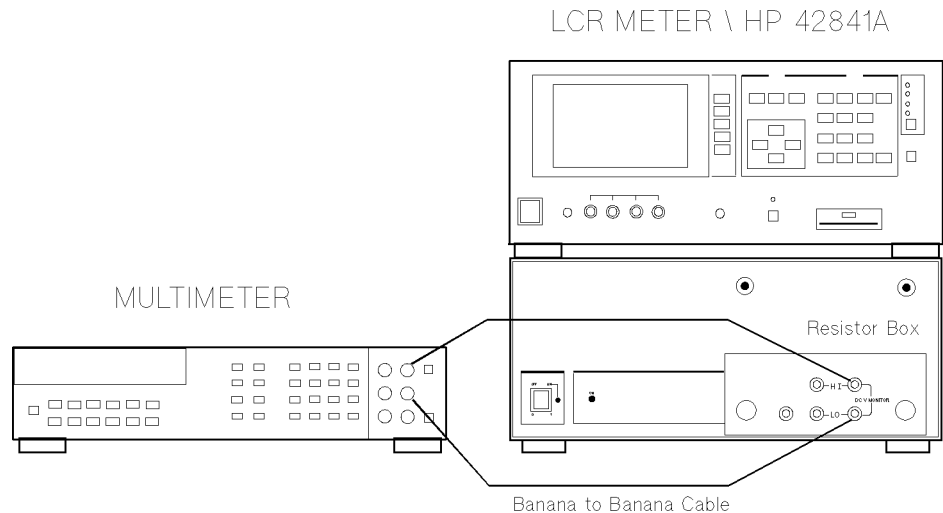

Figure 5-1. Bias Current Accuracy Test Setup

1. Calibrate the 50m Ω , 200m Ω and 1 Ω Resistor Boxes as described in “Resistor Box Calibration”

Note



Resistor Box Calibration must be performed each time the test is performed

Note



Step 2 and 3 is only required when the 4285A is used.

2. Press the **CATALOG SYSTEM MENU** key and the **SYSTEM CONFIG** softkey to display the *SYSTEM CONFIG* page.
3. Move the cursor to the *CONFIG* field, and press the **I BIAS** softkey to enable the 4285A to control the 42841A.
4. Connect the LCR meter to the 42841A using the Bias Interface Cable.
5. Cycle the LCR meter’s power OFF and ON to initialize it.
6. Set the Multimeter as follows.
(Settings for the 3458A)
Measurement Function: DCV
Measurement Range: Auto
Guard: OPEN
7. Connect the 1 Ω Resistor Box to the 42841A’s output.
8. Connect the Resistor Box’s V-MONITOR HI terminal to the terminal to the Multimeter’s HI Input, and connect the V-MONITOR LO terminal to the LO Input, as shown in Figure 5-1.
9. Turn the 42841A ON.

10. Perform steps 11 through 15 for all the DC bias settings listed in Table 5-4.
11. Set the DC bias using the LCR meter.
12. Press the LCR meter's **DC BIAS** key to turn the DC bias ON.
13. Record the Multimeter reading on the Calculation Sheet using 5 significant digits.
14. Press the LCR meter's **DC BIAS** key to turn the DC bias OFF.
15. Calculate the DC bias current, and confirm that the value is within the test limits.

DC Bias Current is given as:

$$(\text{Multimeter reading}) \div (\text{Resistor Box cal. value})$$

16. Turn the 42841A OFF.

Table 5-4.
1A Range Bias Current Accuracy Test Limit

Bias Current Setting	Minimum Limit	Maximum Limit
0A	-5.0mA	5.0mA
10mA	4.9mA	15.1mA
100mA	94.0mA	106.0mA
200mA	193.0mA	207.0mA
300mA	292.0mA	308.0mA
500mA	490.0mA	510.0mA
700mA	688.0mA	712.0mA
900mA	886.0mA	914.0mA
1A	0.985A	1.015A

17. Connect the 200mΩ Resistor Box to the 42841A's output.
18. Connect the Resister Box's V-MONITOR HI terminal to the Multimeter's HI Input, and connect the V-MINITOR LO terminal to the LO Input, as shown in Figure 5-1.
19. Turn the 42841A ON.
20. Perform steps 11 through 15 for all the DC bias settings listed in Table 5-5.
21. Turn the 42841A OFF.

**Table 5-5.
5A Range Bias Current Accuracy Test Limit**

Bias Current Setting	Minimum Limit	Maximum Limit
1.1A	1.078A	1.122A
2A	1.960A	2.040A
3A	2.940A	3.060A
4A	3.920A	4.080A
5A	4.900A	5.100A

22. Connect the 50mΩ Resistor Box to the 42841A's output.
23. Connect the Resistor Box's V-MONITOR HI terminal to the Multimeter's HI Input, and connect the V-MONITOR LO terminal to the LO Input, as shown in Figure 5-1.
24. Turn the 42841A ON.
25. Perform steps 11 through 15 for all the DC bias settings listed in Table 5-6.
26. Turn the 42841A OFF.

Table 5-6. 20A Range Bias Current Accuracy Test Limit

Bias Current Setting	Minimum Limit	Maximum Limit
5.1A	4.947A	5.253A
8A	7.760A	8.240A
10A	9.70A	10.30A
15A	14.55A	15.45A
17A	16.49A	17.51A
20A	19.40A	20.60A

Resistor Box Calibration

This section tells how to calibrate the 50mΩ, 200mΩ and 1Ω Resistor Boxes.

Test Equipment Table 5-7 lists the recommended performance test equipment.

Table 5-7. Recommended Test Equipment

Equipment	Requirement	Recommended Model	Qty
Resistance Meter	Range: up to 1Ω Accuracy: ≤ ±0.5% at 50mΩ ≤ ±0.2% at 200mΩ ≤ 0.05% at 1Ω	3458A	1
Test Lead	Low thermal, banana to banana	11058A	2

Procedure

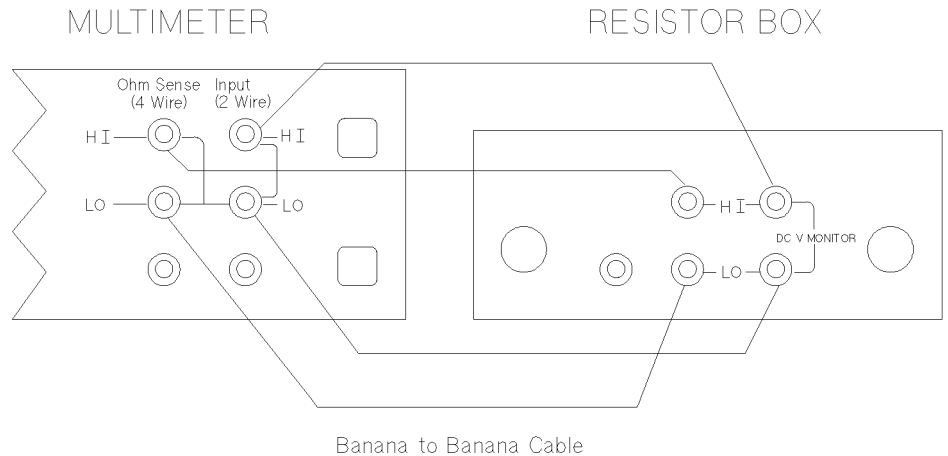

Figure 5-2. Resistor Box Calibration Setup

1. Set the Multimeter as follows:

(Setting for the 3458A)

Measurement Function:	4-wire ohms
Measurement Range:	Auto
Integration Time:	100 PLCs
Auto Zero:	ON
Offset Compensation:	ON

2. Connect the 50mΩ Resistor Box to the Multimeter's 4-wire Ω sense input, as shown in Figure 5-2
3. Record the Multimeter reading on the Calculation Sheet using 5 significant digits for the Resistor Box calibration value.
4. Connect the 200mΩ resistor Box to the Multimeter's 4-wire Ω sense input as shown in Figure 5-2.

5. Record the Multimeter reading on the Calculation Sheet using 5 significant digits for the Resistor Box calibration value.
6. Connect the 1Ω Resistor Box to the Multimeter's 4-wire Ω sense input as shown in Figure 5-2.
7. Record the Multimeter reading on the Calculation Sheet using 5 significant digits for the Resistor Box Calibration value.

Calication Sheet*1A Range DC Bias Current Accuracy Test*1 Ω Resistor Box Calibration Value (a=) [Ω]

Bias Current Setting	Multimeter Reading (b=)	Test Result (b\diva=)
0A	[mV]	[mA]
10 mA	[mV]	[mA]
100mA	[mV]	[mA]
200mA	[mV]	[mA]
300mA	[mV]	[mA]
500mA	[mV]	[mA]
700mA	[mV]	[mA]
900mA	[mV]	[mA]
1A	[mV]	[mA]

*5A Range DC Bias Current Accuracy Test*200m Ω Resistor Box Calibration Value (a=) [Ω]

Bias Current Setting	Multimeter Reading (b=)	Test Result (b\diva=)
1.1A	[V]	[A]
2A	[V]	[A]
3A	[V]	[A]
4A	[V]	[A]
5A	[V]	[A]

20A Range DC Bias Current Accuracy Test

50m Ω Resistor Box Calibration Value (a=) [Ω]

Bias Current Setting	Multimeter Reading (b)=	Test Result (b \div a=)
5.1A	[V]	[A]
8A	[V]	[A]
10A	[V]	[A]
15A	[V]	[A]
17A	[V]	[A]
20A	[V]	[A]

Performance Test Record

HEWLETT-PACKARD 42841A BIAS CURRENT SOURCE

Tested by	
Serial Number	
Test Date	

DC Bias Current Accuracy Test

Bias Current Setting	Minimum Limit	Test Result	Maximum Limit
0A	-5.0mA	[mA]	5.0mA
10mA	4.9mA	[mA]	15.1mA
100mA	94.0mA	[mA]	106.0mA
200mA	193.0mA	[mA]	207.0mA
300mA	292.0mA	[mA]	308.0mA
500mA	490.0mA	[mA]	510.0mA
700mA	688.0mA	[mA]	712.0mA
900mA	886.0mA	[mA]	914.0mA
1A	0.985A	[A]	1.015A
1.1A	1.078A	[A]	1.122A
2A	1.960A	[A]	2.040A
3A	2.940A	[A]	3.060A
4A	3.920A	[A]	4.080A
5A	4.900A	[A]	5.100A
5.1A	4.947A	[A]	5.253A
8A	7.760A	[A]	8.240A
10A	9.70A	[A]	10.30A
15A	14.55A	[A]	15.45A
17A	16.49A	[A]	17.51A
20A	19.40A	[A]	20.60A

Manual Changes

Introduction

This appendix contains the information required to adapt this manual to earlier versions or configurations of the 42841A than the current printing date of this manual. The information in this manual applies directly to 42841A Bias Current Source whose serial number prefix is listed on the title page of this manual.

Manual Changes

To adapt this manual to your 42841A, refer to Table A-1, and make all the manual changes listed opposite your instrument's serial number.

Instruments manufactured after the printing of this manual may be different from those documented in this manual. Later instrument versions will be documented in a manual changes supplement that will accompany the manual shipped with that instrument. If your instrument serial number is not listed on the title page of this manual or in Table A-1, it may be documented in *yellow MANUAL CHANGES* supplement.

For additional information on serial number coverage, refer to "Serial Number" in Chapter 4.

Table A-1. Manual Changes by Serial Number

Serial Prefix or Number	Make Manual Changes
	There are no earlier configurations than the printing date of this manual.

REGIONAL SALES AND SUPPORT OFFICES

For more information about Agilent Technologies test and measurement products, applications, services, and for a current sales office listing, visit our web site: <http://www.agilent.com/find/tmdir>. You can also contact one of the following centers and ask for a test and measurement sales representative.

11/29/99

United States:

Agilent Technologies
Test and Measurement Call Center
P.O.Box 4026
Englewood, CO 80155-4026
(tel) 1 800 452 4844

(fax) (61 3) 9272 0749
(tel) 0 800 738 378 (New Zealand)
(fax) (64 4) 802 6881

Canada:

Agilent Technologies Canada Inc.
5150 Spectrum Way
Mississauga, Ontario
L4W 5G1
(tel) 1 877 894 4414

Asia Pacific:

Agilent Technologies
24/F, Cityplaza One, 1111 King's Road,
Taikoo Shing, Hong Kong
(tel) (852)-3197-7777
(fax) (852)-2506-9284

Europe:

Agilent Technologies
Test & Measurement
European Marketing Organization
P.O.Box 999
1180 AZ Amstelveen
The Netherlands
(tel) (31 20) 547 9999

Japan:

Agilent Technologies Japan Ltd.
Call Center
9-1, Takakura-Cho, Hachioji-Shi,
Tokyo 192-8510, Japan
(tel) (81) 426 56 7832
(fax) (81) 426 56 7840

Latin America:

Agilent Technologies
Latin American Region Headquarters
5200 Blue Lagoon Drive, Suite #950
Miami, Florida 33126
U.S.A.
(tel) (305) 267 4245
(fax) (305) 267 4286

Australia/New Zealand:

Agilent Technologies Australia Pty Ltd
347 Burwood Highway
Forest Hill, Victoria 3131
(tel) 1-800 629 485 (Australia)