

OTDR

Optical Time Domain Reflectometer

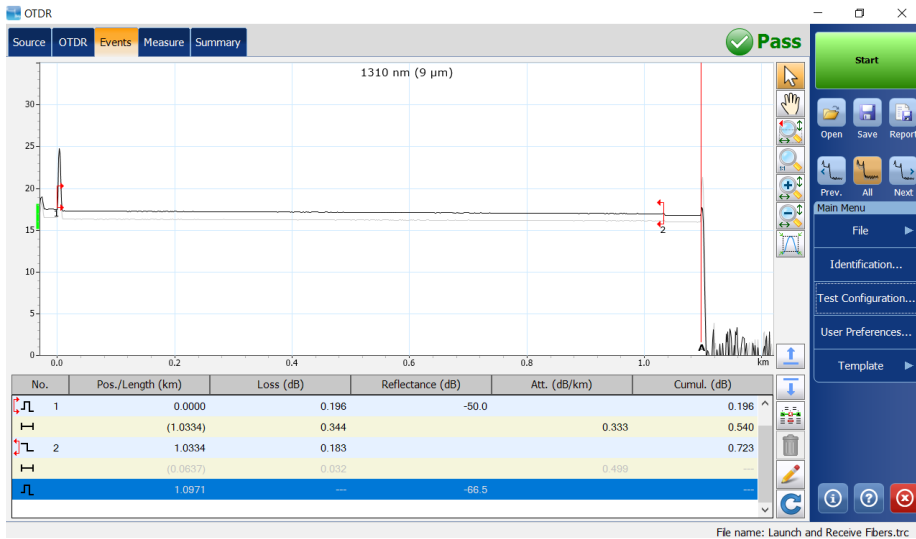

Copyright © 2013–2019 EXFO Inc. All rights reserved. No part of this publication may be reproduced, stored in a retrieval system or transmitted in any form, be it electronically, mechanically, or by any other means such as photocopying, recording or otherwise, without the prior written permission of EXFO Inc. (EXFO).

Information provided by EXFO is believed to be accurate and reliable. However, no responsibility is assumed by EXFO for its use nor for any infringements of patents or other rights of third parties that may result from its use. No license is granted by implication or otherwise under any patent rights of EXFO.

EXFO's Commerce And Government Entities (CAGE) code under the North Atlantic Treaty Organization (NATO) is 0L8C3.

The information contained in this publication is subject to change without notice.

Trademarks

EXFO's trademarks have been identified as such. However, the presence or absence of such identification does not affect the legal status of any trademark.

Units of Measurement

Units of measurement in this publication conform to SI standards and practices.

Patents

Feature(s) of this product is/are protected by one or more of: US patent 8,576,389 and equivalent patents pending and/or granted in other countries; US patent 9,170,173; US patent 9,571,186; US patent 10,014,935; US patent 9,641,243; US patent 9,134,197 and equivalent patents pending and/or granted in other countries; US patent 9,506,838; US design patent D710,222 and equivalent(s) in other countries; US design patent D764,328; US design patent D798,171 and equivalent(s) in other countries; and US design patent D842,144 and equivalent(s) in other countries.

Version number: 15.0.1.1

Contents

Regulatory Information	vii
1 Introducing the OTDR	1
Main Window	7
Software Options	8
Data Post-Processing	8
OTDR Basic Principles	9
Technical Specifications	11
Conventions	11
2 Safety Information	13
General Safety Information	13
Laser Safety Information for FTB-7000/FTB-700Gv2/FTB/FTBx/MAX-700C Series (Units without VFL)	15
Laser Safety Information for FTBx-740C DWOCC and MAX-740C DWOCC Modules (Units without VFL)	17
Laser Safety Information for FTB-7000 Series (Units with VFL)	18
Laser Safety Information for MAX-700C Series (Units with VFL)	19
Laser Safety Information for FTBx-740C DWOCC and MAX-740C DWOCC Modules (Units with VFL)	20
Laser Safety Information for MAX-700B Series	21
Electrical Safety Information	22
3 Preparing Your OTDR for a Test	23
Installing the EXFO Universal Interface (EUI)	23
Cleaning and Connecting Optical Fibers	24
Naming Trace Files Automatically	26
Setting the IOR, RBS Coefficient, and Helix Factor	32
Excluding and Including Span Start and Span End	37
Setting the Analysis Detection Thresholds	39
Setting Macrobend Parameters	45
Setting Pass/Fail Thresholds	49
Enabling or Disabling the Automated Acquisition Sequence	53

Contents

4 Working With the DWDM OTDR Module	57
Main Features	57
Selecting a Channel Filter	58
Selecting a Channel	59
Managing Favorite Channels	60
Testing Channels Sequentially	63
Performing Live-Fiber Testing	65
5 Working With the CWDM OTDR Module	67
Main Features	67
Selecting a Channel Filter	68
Selecting a Channel	69
Managing Favorite Channels	70
Testing Channels Sequentially	73
Detecting Macrobends on Fiber Links	75
Performing Live-Fiber Testing	78
Understanding Fiber Water Peak	78
6 Testing Fibers	79
Setting the Automatic Acquisition Parameters	85
Defining Launch and Receive Fiber Settings	89
Enabling or Disabling the First Connector Check	92
Applying Acquisition Settings by Wavelength	93
Setting Distance Range, Pulse Width, and Acquisition Time	94
Monitoring Fibers in Real-Time Mode	96
7 Customizing Your OTDR	99
Setting Event Table and Graph Display Parameters	99
Displaying or Hiding Fiber Sections on a Trace	101
Selecting the Distance Units	102
Customizing the Acquisition Distance Range Values	104
Customizing the Acquisition Time Values	106
Selecting a Trace Display Mode	108
Customizing Trace Colors	109
Selecting the Default View	110
Setting the Default Storage Folder	112
Selecting the Default File Format	113
Enabling or Disabling File Name Confirmation	115
Enabling or Disabling the Automatic Storage of the Files	116

8 Analyzing Traces and Events	117
Graph	118
Summary Tab	119
Events Tab	123
Linear View	126
Measure Tab	129
Switching Between Full-Screen, Condensed, and Split Views	130
Using Zoom Controls	132
Viewing Span Start and Span End in the Table of Events	135
Selecting the Displayed Wavelength	136
Working With Template Traces	137
Viewing and Modifying Current Measurement Settings	141
Modifying Events	146
Inserting Events	149
Deleting Events	154
Managing Comments	156
Analyzing or Reanalyzing a Trace	158
Analyzing the Fiber on a Specific Fiber Span	159
Enabling or Disabling the Detection of Reflective Ends of Fiber	162
Opening Measurement Files	165
9 Analyzing the Results Manually	167
Using Markers	167
Getting Event Distances and Relative Powers	169
Getting Event Loss and Maximum Reflectance	171
Getting Section Loss and Attenuation	174
Getting Optical Return Loss (ORL)	176
10 Managing Trace Files from the OTDR Test Application	177
11 Creating and Generating Reports	179
Adding Information to the Test Results	179
Generating a Report	181
12 Using the OTDR as a Light Source	187
13 Maintenance	191
Cleaning EUI Connectors	192
Recalibrating the Unit	194
Recycling and Disposal	195

Contents

14 Troubleshooting	197
Solving Common Problems	197
Viewing Online Documentation	199
Contacting the Technical Support Group	199
Viewing Information About Your OTDR	200
Transportation	200
15 Warranty	201
General Information	201
Liability	202
Exclusions	202
Certification	202
Service and Repairs	203
EXFO Service Centers Worldwide	204
A Description of Event Types	205
Span Start	206
Span End	206
Short Fibers	206
Continuous Fiber	207
End of Analysis	208
Non-Reflective Event	209
Reflective Event	210
Positive Event	211
Launch Level	212
Fiber Section	213
Merged Event	214
Echo	220
Reflective Event (Possible Echo)	221
Coupler	222
Index	223

Regulatory Information

Electromagnetic Interference and Compatibility Regulatory Information

For Electromagnetic Interference and Compatibility Regulatory information on your product, refer to the user documentation of your platform.

European Declaration of Conformity

The full text of the EU declaration of conformity is available at the following Internet address: *www.exfo.com/en/resources/legal-documentation*.

1 Introducing the OTDR

The Optical Time Domain Reflectometer (OTDR) allows you to characterize a fiber-optic span, usually optical fiber sections joined by splices and connectors.

Depending on the type of acquisition you want to perform and the environment you are working in, different modules are available for your tests:

- The standard OTDR provides an inside view of the fiber, and can calculate fiber length, attenuation, breaks, total return loss as well as splice, connector and total losses.
- The MAX/FTBx-740C-DWx module is a DWDM (dense wavelength-division multiplexing) OTDR in the C-band and is designed to test through field mux/demux channels. This high-resolution particular type of OTDR provides complete end-to-end link characterization and helps troubleshooting metro Ethernet links as well as commercial services. See *Working With the DWDM OTDR Module* on page 57 for details.
- The MAX/FTBx-740C-CW module is an OTDR that covers up to 18 CWDM ITU channels, from 1270 nm to 1610 nm (with a channel spacing of 20 nm), and is designed to test through field mux/demux channels. This high-resolution particular type of CWDM (coarse wavelength-division multiplexing) OTDR provides complete end-to-end link characterization and helps troubleshooting commercial, C-RAN networks as well as metro Ethernet links deployments. See *Working With the CWDM OTDR Module* on page 67 for details.

Note: *In this documentation, the words “tap” and “double-tap” (related to the use of a touchscreen) replace the words “click” and “double-click”.*

Introducing the OTDR

MAX-700B Series

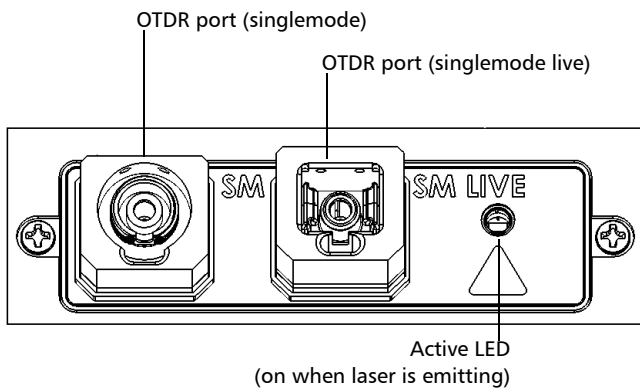

FTB-7000 Series for FTB-2/FTB-2 Pro and FTB-4 Pro

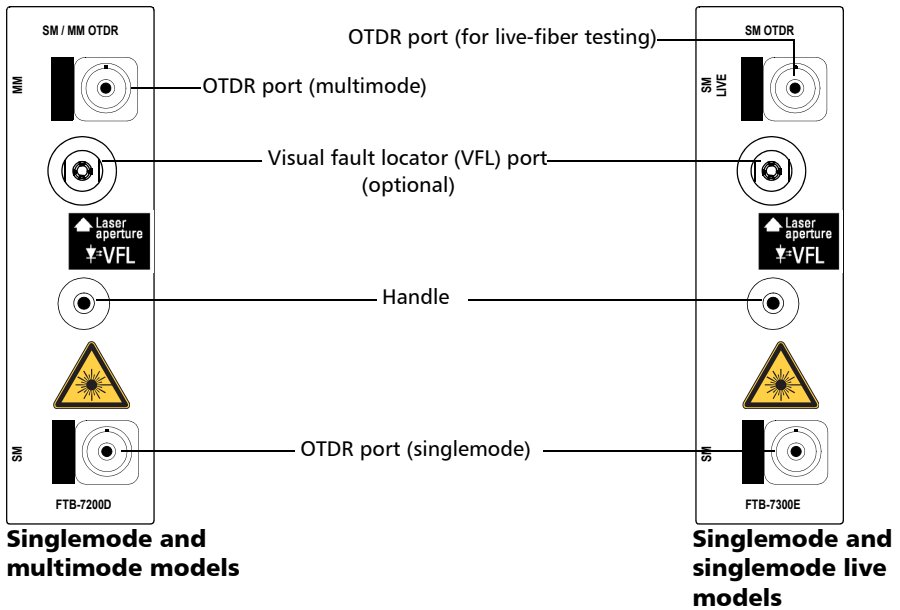

Introducing the OTDR

FTB-7000 Series for FTB-2/FTB-2 Pro and FTB-4 Pro

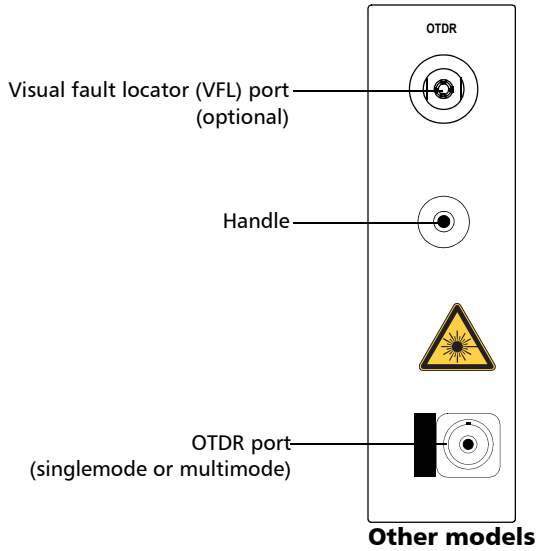

FTB-700C Series, MAX-700C Series, FTB-700Gv2 Series, and FTBx-700C Series

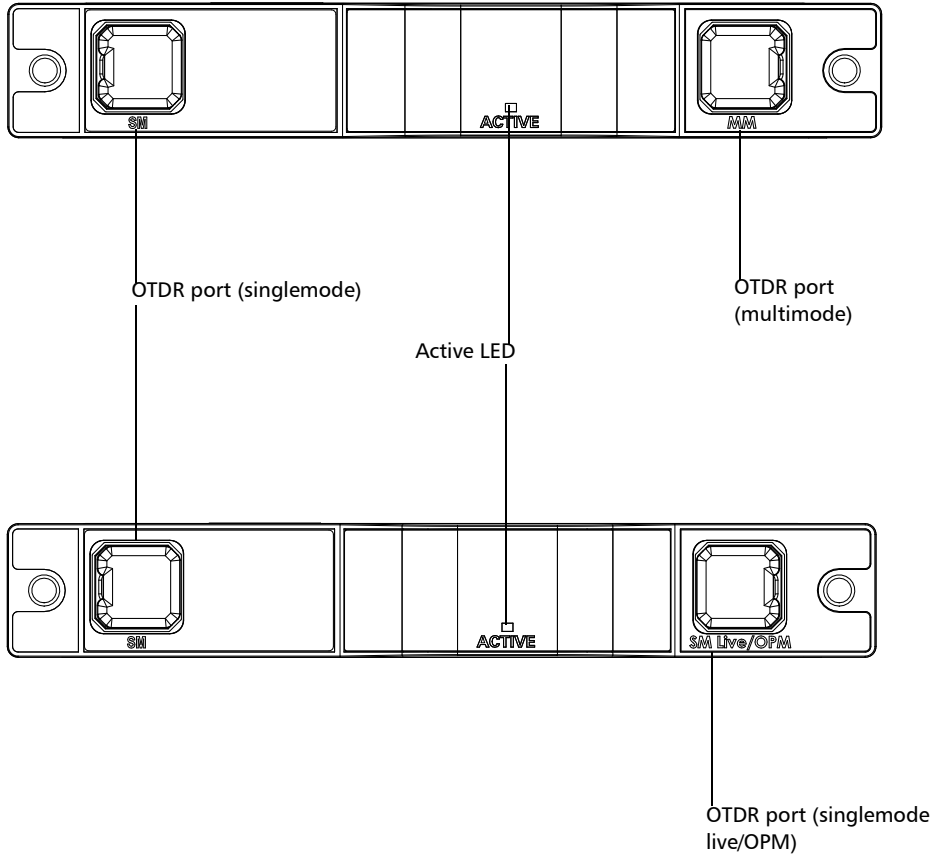

Introducing the OTDR

FTBx-740C

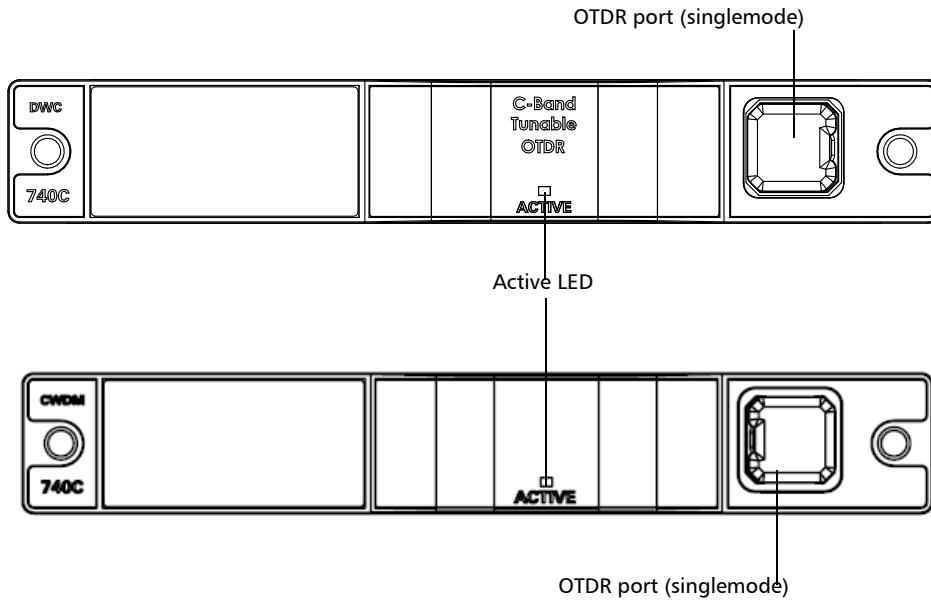

MAX/FTBx-740C DWOCC

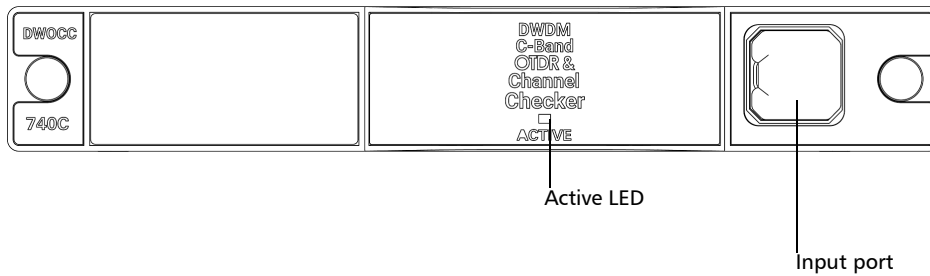

Main Window

The main window (shown below) contains all the commands required to control the OTDR instrument:

Graph overview window

Data display

Table of events

Button bar

The screenshot shows the OTDR software interface. At the top, there are tabs for Source, OTDR, Events, Measure, and Summary. A 'Fail' indicator is visible in the top right. The main area is a graph showing a signal trace with a prominent peak at 1.310 nm (9 μm). Below the graph is a table of events with the following data:

No.	Pos./Length (km)	Loss (dB)	Reflectance (dB)	Att. (dB/km)	Cumul. (dB)
2	1.0907 (0.0030)	1.383	0.001	0.250	1.731
3	1.0337 (0.1018)	0.946	-49.3	0.250	2.678
4	1.1856 (0.1038)	0.130	0.044	0.419	2.877

File name: Macroband_Merco.trc

Note: Due to screen resolution, the appearance of your OTDR application may vary slightly from the illustrations presented in this user guide.

Software Options

Software options are offered with your unit.

- The OTDR option activates the OTDR application.
- The QUAD option activates singlemode wavelengths on units.
- With the IADV software option, when working with the iOLM application, you can also have access to the OTDR by enabling the **OTDR real time** feature. In this case, the only button available to start an acquisition is the **Real Time** button. Most of the standard OTDR features, such as the **Events** tab, the **Summary** tab, the **Identification**, and the **Test Configuration** button, are disabled.
- The CWDM-8W option enables 8 wavelengths in the 1470 nm - 1610 nm range.
- The CWDM-10W option enables 10 wavelengths in the 1430 nm - 1610 nm range.
- The M-1310W option enables the 1310 nm wavelength.
- The CWDM-18W option enables the 18 wavelengths available.

Data Post-Processing

To view and analyze traces without the OTDR application, use a computer onto which FastReporter is already installed.

OTDR Basic Principles

An OTDR sends short pulses of light into a fiber. Light scattering occurs in the fiber due to discontinuities such as connectors, splices, bends, and faults. The OTDR then detects and analyzes the backscattered signals. The signal strength is measured for specific intervals of time and is used to characterize events.

The OTDR calculates distances as follows:

$$\text{Distance} = \frac{c}{n} \times \frac{t}{2}$$

where

- c = speed of light in a vacuum (2.998×10^8 m/s)
- t = time delay from the launch of the pulse to the reception of the pulse
- n = index of refraction of the fiber under test (as specified by the manufacturer)

Introducing the OTDR

OTDR Basic Principles

An OTDR uses the effects of Rayleigh scattering and Fresnel reflection to measure the fiber's condition, but the Fresnel reflection is tens of thousands of times greater in power level than the backscatter.

- Rayleigh scattering occurs when a pulse travels down the fiber and small variations in the material, such as variations and discontinuities in the index of refraction, cause light to be scattered in all directions. However, the phenomenon of small amounts of light being reflected directly back toward the transmitter is called backscattering.
- Fresnel reflections occur when the light traveling down the fiber encounters abrupt changes in material density that may occur at connections or breaks where an air gap exists. A very large quantity of light is reflected, as compared with the Rayleigh scattering. The strength of the reflection depends on the degree of change in the index of refraction.

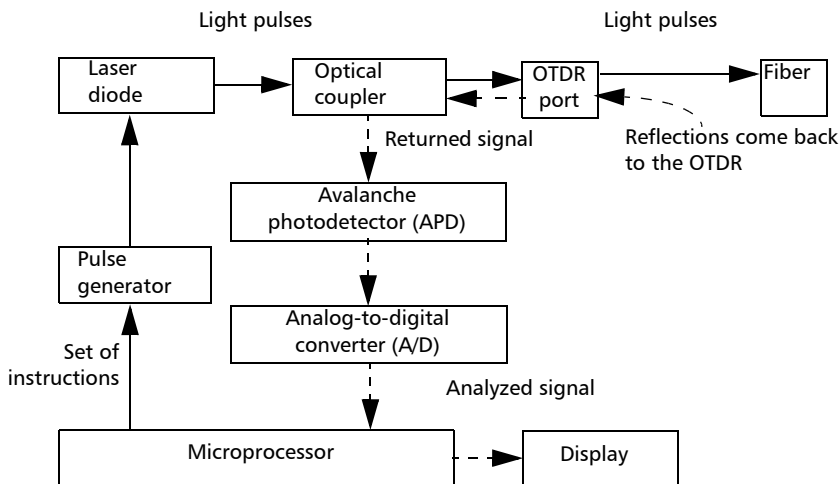

When the full trace is displayed, each point represents an average of many sampling points. You will have to zoom to see each point.

Technical Specifications

To obtain this product's technical specifications, visit the EXFO Web site at www.exfo.com.

Conventions

Before using the product described in this guide, you should understand the following conventions:



WARNING

Indicates a potentially hazardous situation which, if not avoided, could result in *death or serious injury*. Do not proceed unless you understand and meet the required conditions.



CAUTION

Indicates a potentially hazardous situation which, if not avoided, may result in *minor or moderate injury*. Do not proceed unless you understand and meet the required conditions.



CAUTION

Indicates a potentially hazardous situation which, if not avoided, may result in *component damage*. Do not proceed unless you understand and meet the required conditions.



IMPORTANT

Refers to information about this product you should not overlook.

2 **Safety Information**

General Safety Information



WARNING

Do not install or terminate fibers while a light source is active. Never look directly into a live fiber and ensure that your eyes are protected at all times.



WARNING

The use of controls, adjustments and procedures, namely for operation and maintenance, other than those specified herein may result in hazardous radiation exposure or impair the protection provided by this unit.



WARNING

If the equipment is used in a manner not specified by the manufacturer, the protection provided by the equipment may be impaired.



WARNING

Use only accessories designed for your unit and approved by EXFO. For a complete list of accessories available for your unit, refer to its technical specifications or contact EXFO.

Safety Information

General Safety Information



IMPORTANT

Refer to the documentation provided by the manufacturers of any accessories used with your EXFO product. It may contain environmental and/or operating conditions limiting their use.



IMPORTANT

When you see the following symbol on your unit , make sure that you refer to the instructions provided in your user documentation. Ensure that you understand and meet the required conditions before using your product.



IMPORTANT

When you see the following symbol on your unit , it indicates that the unit is equipped with a laser source, or that it can be used with instruments equipped with a laser source. These instruments include, but are not limited to, modules and external optical units.



IMPORTANT

Other safety instructions relevant for your product are located throughout this documentation, depending on the action to perform. Make sure to read them carefully when they apply to your situation.

Laser Safety Information for FTB-7000/FTB-700Gv2/FTB/FTBx/MAX-700C Series (Units without VFL)

Your instrument is in compliance with standards IEC 60825-1: 2007 and 2014.



WARNING

(IEC 60825-1: 2007) Viewing the laser output with certain optical instruments designed for use at a distance (for example, telescopes and binoculars) may pose an eye hazard.



WARNING

(IEC 60825-1: 2014) Viewing the laser output with telescopic optical instruments (for example, telescopes and binoculars) may pose an eye hazard and thus the user should not direct the beam into an area where such instruments are likely to be used.

Laser radiation may be encountered at the optical output port.

The following labels indicate that the product contains a Class 1M source:

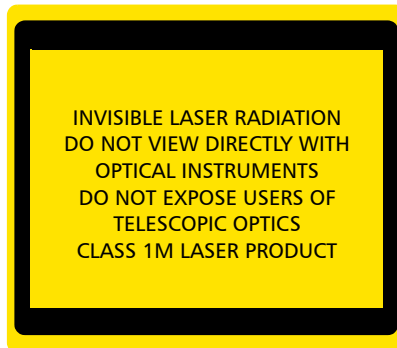

Safety Information

Laser Safety Information for FTB-7000/FTB-700Gv2/FTB/FTBx/MAX-700C Series (Units without VFL)

Wavelength: / Longueur d'onde : 800-1300 nm

Pulse width: / Largeur de l'impulsion : $\tau \leq 1 \mu s$

Max. peak power: / Puissance crête maximum : $P \leq 500 \text{ mW}$

Wavelength: / Longueur d'onde : 1250-1400 nm

Pulse width: / Largeur de l'impulsion : $\tau \leq 20 \mu s$

Max. peak power: / Puissance crête maximum : $P \leq 260 \text{ mW}$

Wavelength: / Longueur d'onde : 1400-1700 nm

Pulse width: / Largeur de l'impulsion : $\tau \leq 20 \mu s$

Max. peak power: / Puissance crête maximum : $P \leq 600 \text{ mW}$

Complies with standards 21 CFR 1040.10, except for deviations pursuant to Laser Notice No. 50, dated June 24, 2007.

Laser Safety Information for FTBx-740C DWOCC and MAX-740C DWOCC Modules (Units without VFL)

Your instrument is in compliance with standard IEC 60825-1: 2014.



WARNING

Viewing the laser output with telescopic optical instruments (for example, telescopes and binoculars) may pose an eye hazard and thus the user should not direct the beam into an area where such instruments are likely to be used.

Laser radiation may be encountered at the optical output port.

The following labels indicate that the product contains a Class 1M source:

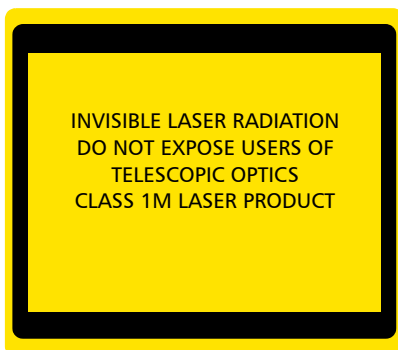

Wavelengths: / Longueurs d'onde : 1525-1570 nm

Pulse width: / Largeur de l'impulsion : $\leq 20 \mu\text{s}$

Max. peak power: / Puissance crête maximum : $\leq 600 \text{ mW}$

Complies with FDA performance standards for laser products except for conformance with IEC 60825-1 Ed. 3, as described in Laser Notice No. 56, dated May 8, 2019.

Safety Information

Laser Safety Information for FTB-7000 Series (Units with VFL)

Laser Safety Information for FTB-7000 Series (Units with VFL)

Your instrument is in compliance with standards IEC 60825-1: 2007 and 2014.

Laser radiation may be encountered at the output port. It is potentially harmful in direct intrabeam viewing.

The following label(s) indicate that the product contains a Class 3R source:

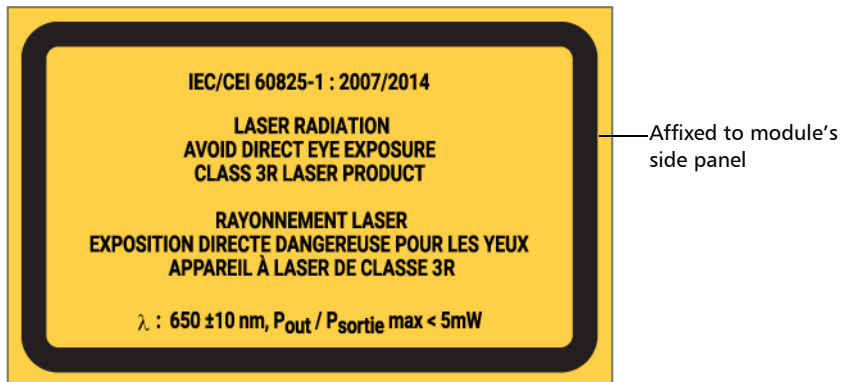

Complies with standards 21 CFR 1040.10, except for deviations pursuant to Laser Notice No. 50, dated June 24, 2007.

Laser Safety Information for MAX-700C Series (Units with VFL)

Your instrument is in compliance with standards IEC 60825-1: 2007 and 2014.

Laser radiation may be encountered at the optical output port.

The following label(s) indicate that the product contains a Class 2 source:



Complies with standards 21 CFR 1040.10, except for deviations pursuant to Laser Notice No. 50, dated June 24, 2007.

Safety Information

Laser Safety Information for FTBx-740C DWOCC and MAX-740C DWOCC Modules (Units with VFL)

Laser Safety Information for FTBx-740C DWOCC and MAX-740C DWOCC Modules (Units with VFL)

Your instrument is in compliance with standard IEC 60825-1: 2014.

Laser radiation may be encountered at the optical output port.

The following label(s) indicate that the product contains a Class 2 source:



Complies with FDA performance standards for laser products except for conformance with IEC 60825-1 Ed. 3, as described in Laser Notice No. 56, dated May 8, 2019.

Laser Safety Information for MAX-700B Series

Your instrument is in compliance with standards IEC 60825-1: 2007 and 2014.



WARNING

(IEC 60825-1: 2007) Viewing the laser output with certain optical instruments designed for use at a distance (for example, telescopes and binoculars) may pose an eye hazard.



WARNING

(IEC 60825-1: 2014) Viewing the laser output with telescopic optical instruments (for example, telescopes and binoculars) may pose an eye hazard and thus the user should not direct the beam into an area where such instruments are likely to be used.

Laser radiation may be encountered at the optical output port.

The following labels indicate that the product contains a Class 1M source:

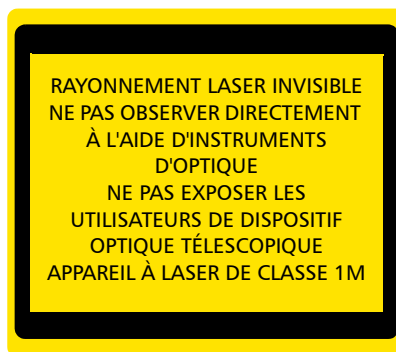
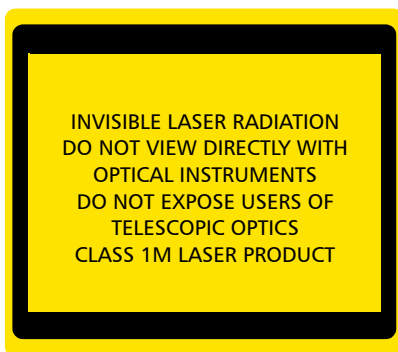

Safety Information

Electrical Safety Information

Wavelength: / Longueur d'onde : 1300-1400 nm

Pulse width: / Largeur de l'impulsion : $\tau \leq 20 \mu\text{s}$

Max. peak power: / Puissance crête maximum : $P \leq 260 \text{ mW}$

Wavelength: / Longueur d'onde : 1400-1700 nm

Pulse width: / Largeur de l'impulsion : $\tau \leq 20 \mu\text{s}$

Max. peak power: / Puissance crête maximum : $P \leq 600 \text{ mW}$

Complies with standards 21 CFR 1040.10, except for deviations pursuant to Laser Notice No. 50, dated June 24, 2007.

Electrical Safety Information

For more information on product safety and equipment ratings, refer to the user documentation of your platform.

The power consumption for all OTDR modules is below 10 W.

3 **Preparing Your OTDR for a Test**

Installing the EXFO Universal Interface (EUI)

The EUI fixed baseplate is available for connectors with angled (APC) or non-angled (UPC) polishing. The type of border around the baseplate indicates which type of connector it is designed for.

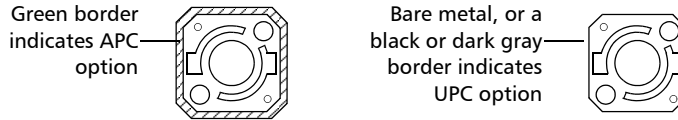

To install an EUI connector adapter onto the EUI baseplate:

1. Hold the EUI connector adapter so the dust cap opens downwards.

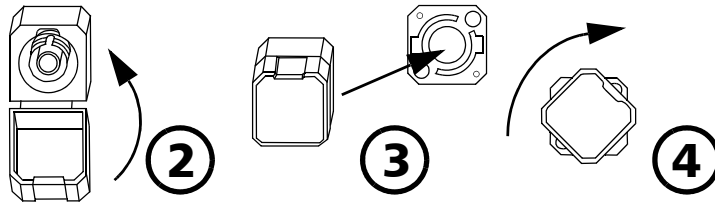

2. Close the dust cap in order to hold the connector adapter more firmly.
3. Insert the connector adapter into the baseplate.
4. While pushing firmly, turn the connector adapter clockwise on the baseplate to lock it in place.

Cleaning and Connecting Optical Fibers



IMPORTANT

To ensure maximum power and to avoid erroneous readings:

- Always inspect fiber ends and make sure that they are clean as explained below before inserting them into the port. EXFO is not responsible for damage or errors caused by bad fiber cleaning or handling.
- Ensure that your patchcord has appropriate connectors. Joining mismatched connectors will damage the ferrules.

To connect the fiber-optic cable to the port:

- 1.** Inspect the fiber using a fiber inspection probe. If the fiber is clean, proceed to connecting it to the port. If the fiber is dirty, clean it as explained below.
- 2.** Clean the fiber ends as follows:
 - 2a.** Gently wipe the fiber end with a lint-free swab dipped in optical-grade liquid cleaner.
 - 2b.** Use a dry swab to dry the connector completely.
 - 2c.** Visually inspect the fiber end to ensure its cleanliness.

3. Carefully align the connector and port to prevent the fiber end from touching the outside of the port or rubbing against other surfaces.

If your connector features a key, ensure that it is fully fitted into the port's corresponding notch.

4. Push the connector in so that the fiber-optic cable is firmly in place, thus ensuring adequate contact.

If your connector features a screw sleeve, tighten the connector enough to firmly maintain the fiber in place. Do not overtighten, as this will damage the fiber and the port.

Note: *If your fiber-optic cable is not properly aligned and/or connected, you will notice heavy loss and reflection.*

EXFO uses good quality connectors in compliance with EIA-455-21A standards.

To keep connectors clean and in good condition, EXFO strongly recommends inspecting them with a fiber inspection probe before connecting them. Failure to do so will result in permanent damage to the connectors and degradation in measurements.

Naming Trace Files Automatically

Each time you start an acquisition, the application suggests a file name based on autonaming settings. This file name appears at the bottom of the window.

The file name is made of one or more static parts (alphanumeric) and one or more variable parts (numeric) that will be incremented or decremented, according to your selection, as follows:

If you choose incrementation...	If you choose decrementation...
Variable part increases until it reaches the <i>highest possible value</i> with the selected number of digits, then restarts at 1.	Variable part decreases until it reaches 1, then restarts at the <i>highest possible value</i> with the selected number of digits.

Note: *To decrement values, the start number must be higher than the stop number.*

After saving a result, the unit prepares the next file name by incrementing (or decrementing) the suffix.

You can select the number of digits displayed for the incremented or decremented values.

Select "#" if you want to keep the value exactly in the same format as defined in the start and stop values. If a value is to be incremented from 1 to 10, it becomes 1, 2, 3, ... 9, 10. One "#" is the default format.

Select two, three, or four "#" if you want all values to be expressed with the same number of digits. The application fills the empty spaces with zeros before the increment or decrement to ensure the appropriate format is displayed. For example, if you select two "#" and the value is to be incremented from 1 to 10, it becomes 01, 02, 03, ... 09, 10.

The file name can be incremented using one or more identifiers. Selecting a single identifier will follow the incrementation (or decrementation) value you have set.

When selecting more than one identifier, the latter appear sequentially in the order that you have set, and the incrementation will start with the last item in the list (the one with the farthest indentation). For example, if you have a file name with the Location, Cable and Fiber identifiers, in that order, the first item to be incremented is the Fiber identifier, then Cable, then Location:

Location 1, Cable 1, Fiber 1

Location 1, Cable 2, Fiber 1

Location 1, Cable 2, Fiber 2

and so forth.

Note: *If you choose not to save a particular trace file, the suggested file name remains available for the next trace you acquire.*

This function is particularly useful when testing multiple-fiber cables.

If you deactivate the automatic file naming function, the application will use the default file name, which is *Unnamed.trc*.

By default, traces are saved in native (.trc) format, but you can configure your unit to save them in Bellcore (.sor) format (see *Selecting the Default File Format* on page 113 for details).

Note: *If you select the Bellcore (.sor) format, the unit creates one file per wavelength (for example, TRACE001_1310.sor and TRACE001_1550.sor, if you included both 1310 nm and 1550 nm in your test). The native (.trc) format contains all wavelengths in a single file.*

Note: *If you are working with a MAX/FTBx-740C-DWx module, the application uses the nominal wavelength of the C-band, which is 1550 nm.*

Preparing Your OTDR for a Test

Naming Trace Files Automatically

The autonaming parameters can be set only for files that have not been saved yet. You will only see the parameters for the current and next acquisition (when the test is done but not saved yet), or for the next acquisition only (test is not done yet). Otherwise, the parameters will not be displayed.

It is also possible to revert the settings to their default values.

To configure the automatic file naming:

1. From the **Main Menu**, tap **Identification**.
2. From the **Apply to** list, ensure that **Next acquisition** or **Current acquisition** is selected.

Identification

Apply to: Next acquisition

Identifiers	Value	Increment	File name
Job ID			<input type="checkbox"/>
Company			<input type="checkbox"/>
Customer			<input type="checkbox"/>
Operator A			<input type="checkbox"/>
Operator B			<input type="checkbox"/>
Comments			<input type="checkbox"/>
Cable ID		Not active	<input type="checkbox"/>
Fiber ID	Fiber 1	1	<input checked="" type="checkbox"/>
Location A		Not active	<input type="checkbox"/>

File name preview: Fiber 11.trc

Separator: Underscore (_)

Increment... Clear Values

Revert to Factory Settings

OK Cancel

3. Enter all the information as follows:
 - 3a. Locate the row corresponding to the identifier that you want to modify.
 - 3b. Tap the **Value** column corresponding to the desired identifier.
 - 3c. Enter the information.

Note: You cannot edit the information in the dark gray boxes.

4. If you want to increment automatically the cable ID, the fiber ID or the location (A and/or B), proceed as follows:

4a. Tap the **Increment** button.

Identification

Apply to: Next acquisition

Identifiers	Value	Increment	File name
Job ID		<input type="checkbox"/>	
Company		<input type="checkbox"/>	
Customer		<input type="checkbox"/>	
Operator A		<input type="checkbox"/>	
Operator B		<input type="checkbox"/>	
Comments		<input type="checkbox"/>	
Cable ID		Not active	
Fiber ID	Fiber 1	<input checked="" type="checkbox"/>	1
Location A		Not active	

File name preview: Fiber 11.trc

Separator: Underscore (_)

Increment... Clear Values

Revert to Factory Settings

OK Cancel

- 4b.** In the **Increment** window, select the **Auto Increment** check box corresponding to the identifier you want to increment.

- 4c.** Enter the start, stop and increment values as desired.

Increment

Identifiers	Auto Increment	Start	Stop	Step	Format
Cable ID	<input checked="" type="checkbox"/>	1	99	1	##
Fiber ID	<input checked="" type="checkbox"/>	1	99	5	#
Location A	<input checked="" type="checkbox"/>	1	99	1	###
Location B	<input checked="" type="checkbox"/>	1	99	5	#

"Location B" must reach stop value before "Location A" is incremented. "Location A" must reach stop value before "Fiber ID" is incremented. "Fiber ID" must reach stop value before "Cable ID" is incremented.

OK Cancel

Note: To decrement values, the start number must be higher than the stop number.

Preparing Your OTDR for a Test

Naming Trace Files Automatically

- 4d.** Choose the type of format in the list.
- 4e.** Tap **OK** to return to the **Identification** window.
- 5.** Select the desired identifiers to include in the file name. You can change the order of appearance of the highlighted component with the up and down arrow buttons.

The screenshot shows the 'Identification' dialog box with the following components and annotations:

- Apply to:** Next acquisition
- Table:**

Identifiers	Value	Increment	File name
Job ID			<input checked="" type="checkbox"/>
Company			<input type="checkbox"/>
Customer			<input type="checkbox"/>
Operator A			<input type="checkbox"/>
Operator B			<input type="checkbox"/>
Comments			<input type="checkbox"/>
Cable ID		Not active	<input type="checkbox"/>
Fiber ID	Fiber 1	1	<input checked="" type="checkbox"/>
Location A		Not active	<input type="checkbox"/>
- File name preview:** Fiber 11.trc
- Separator:** Underscore (_)
- Buttons:** Increment..., Clear Values, Revert to Factory Settings, OK, Cancel

Annotations:

- Items that can be included in the file name (points to the 'File name' column checkboxes)
- This preview is updated automatically as you make your selections (points to the 'File name preview' field)
- To modify the order of appearance of the selected identifiers in the file name (points to the up/down arrow buttons)
- To select the separator in the automatic numbering section (points to the 'Separator' dropdown)
- To revert to factory settings (not available for the Current acquisition) (points to the 'Revert to Factory Settings' button)

- 6.** Tap **OK** to confirm your new settings and to return to the main window.

To clear the values:

- 1.** From the **Main Menu**, tap **Identification**.
- 2.** In the **Apply to** list, select **Next acquisition**.
- 3.** Tap the **Clear Values** button.

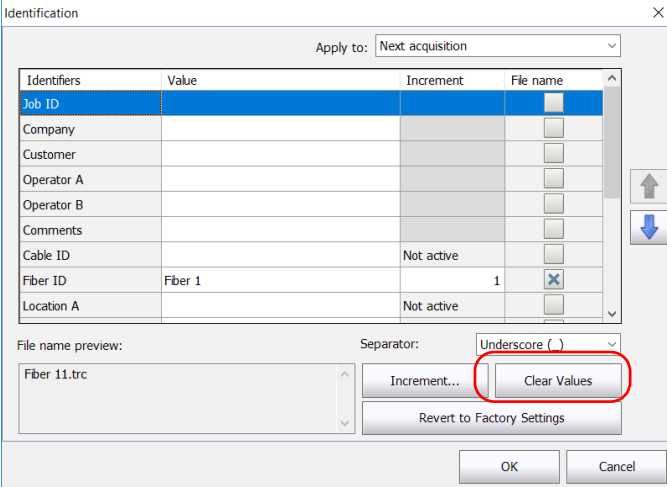

The screenshot shows the 'Identification' dialog box with the 'Apply to' dropdown set to 'Next acquisition'. A table lists various identifiers with checkboxes for file naming. The 'Fiber ID' row is selected, showing 'Fiber 1' in the Value column and '1' in the Increment column. The 'Clear Values' button is circled in red.

Identifiers	Value	Increment	File name
Job ID			<input type="checkbox"/>
Company			<input type="checkbox"/>
Customer			<input type="checkbox"/>
Operator A			<input type="checkbox"/>
Operator B			<input type="checkbox"/>
Comments			<input type="checkbox"/>
Cable ID		Not active	<input type="checkbox"/>
Fiber ID	Fiber 1	1	<input checked="" type="checkbox"/>
Location A		Not active	<input type="checkbox"/>

File name preview: Fiber 11.trc
Separator: Underscore (_)
Buttons: Increment..., Clear Values, Revert to Factory Settings, OK, Cancel

- 4.** Tap **OK** to return to the main window.

All values in the **Value** column are erased from the white boxes.

Preparing Your OTDR for a Test

Setting the IOR, RBS Coefficient, and Helix Factor

Setting the IOR, RBS Coefficient, and Helix Factor

Note: *If you are working with a MAX/FTBx-740C-DWx module, only the 1550 nm wavelength is available. This value is set by default.*

Note: *If you are working with the DWDM OTDR, the application uses the IOR and backscatter values of the 1550 nm wavelength (nominal wavelength of the C-band).*

You should set the IOR (group index), backscatter coefficient and helix factor before performing tests in order to apply them to all newly acquired traces. However, you can also set them at a later time but in that case, you have to reanalyze the trace if you change the backscatter coefficient (see *Viewing and Modifying Current Measurement Settings* on page 141 for details).

- The index of refraction (IOR) value (also known as group index) is used to convert time-of-flight to distance. Having the proper IOR is crucial for all OTDR measurements associated with distance (event position, attenuation, section length, total length, etc.). IOR is provided by the cable or fiber manufacturer.

The test application determines a default value for each wavelength. You can set the IOR value for each available wavelength. You should verify this information before each test.

- The Rayleigh backscatter (RBS) coefficient represents the amount of backscatter in a particular fiber. The RBS coefficient is used in the calculation of event loss and reflectance, and it can usually be obtained from the cable manufacturer.

The test application determines a default value for each wavelength. You can set the RBS coefficient for each available wavelength.

- The helix factor represents the ratio between the length of the cable and the length of the fiber inside the cable. Since fibers within a cable are spiraling around the cable core, the fiber length is different from the cable length.

By setting the helix factor, the length of the OTDR distance axis is always equivalent to the physical length of the cable.

The helix factor is expressed as a percentage. For example, a helix factor of 1 % implies that the fiber is 1 % longer than the cable. If you specify a helix factor of 1 %, the displayed length would be reduced by 1 % according to the cable length.

Thresholds values are saved with the measurement. It is possible to view these thresholds values even if you open the file on another unit.

You can revert the IOR, RBS coefficient, and helix factor to their default values.

Preparing Your OTDR for a Test

Setting the IOR, RBS Coefficient, and Helix Factor

To set the IOR, RBS, and helix factor parameters:

1. From the **Main Menu**, tap **Test Configuration**.
2. From the **Apply to** list, select **Next acquisition**.



IMPORTANT

In the **Apply to** list, **Next acquisition** and **Current acquisition** will be displayed if an acquisition was performed, but not saved yet. The current trace as well as the future acquisitions will be modified.

3. From the **Test Configuration** window, go to the **Link Definition** tab.

The screenshot shows the 'Test Configuration' window with the 'Link Definition' tab selected. The 'Apply to' dropdown is set to 'Next acquisition'. The 'Fiber Characteristics' section includes: Wavelength: 1310 nm/9 μm, IOR: 1.467700, Backscatter: -79.45 dB, and Helix factor: 0.00%. The 'Calculation and Pass/Fail Thresholds' section has 'Include span end' checked. The 'Detection Thresholds' section includes: Splice loss: 0.020 dB, Splitter loss: 2.500 dB, End-of-fiber: 5.000 dB, Reflectance: -72.0 dB, and Delta (loss): 0.500 dB. A 'Revert to Factory Settings' button is at the bottom right, and 'Copy to Current Acquisition', 'OK', and 'Cancel' buttons are at the bottom.

Preparing Your OTDR for a Test

Setting the IOR, RBS Coefficient, and Helix Factor

4. Select the desired wavelength.

Note: You cannot select a wavelength if you are working with a MAX/FTBx-740C-DWx module. The wavelength is set to 1550 nm by default.

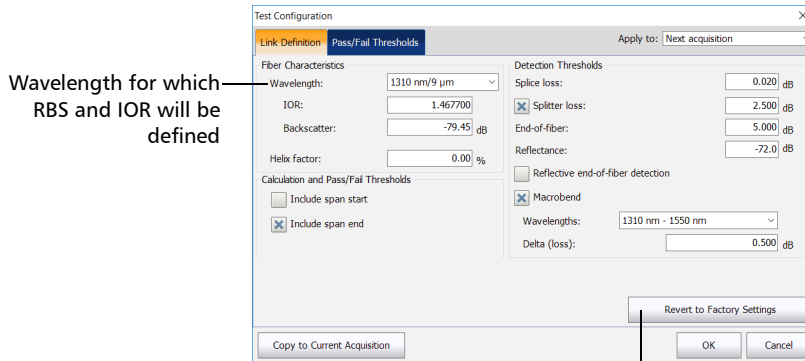

The Revert to Factory Settings button resets all the values in the Link Definition tab



IMPORTANT

Change the default RBS coefficient *only* if you have values provided by the fiber manufacturer. If you set this parameter incorrectly, your reflectance measurements will be inaccurate.

Note: The helix factor value takes into account the difference between the length of the cable and the length of the fiber inside the cable; it does not vary with wavelengths. For this reason, you cannot define a different helix factor for each wavelength.

Preparing Your OTDR for a Test

Setting the IOR, RBS Coefficient, and Helix Factor

5. If you want to apply the test configuration information to the current acquisition, proceed as follows:

5a. Tap the **Copy to Current Acquisition** button.

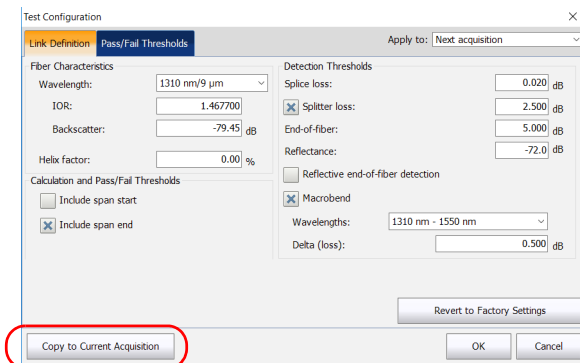

5b. When the application prompts you, select **Yes**.

Note: The information in the **Link Definition** and **Pass/Fail Thresholds** tabs will be copied to the current acquisition.

6. Tap **OK** to return to the main window.

Excluding and Including Span Start and Span End

When applicable, the application includes the losses caused by the span start and span end events to the span loss value. The application also includes the ORL caused by the span start and span end events to the span ORL.

When the spans are included, the loss and reflectance values associated with the events are taken into account to determine the pass/fail thresholds.

To exclude or include span starts and span ends:

1. From the **Main Menu**, tap the **Test Configuration** button.
2. Select the **Link Definition** tab.
3. Under **Calculation and Pass/Fail Thresholds**, select the inclusion of the span start and span end you want to display in the table.

OR

To exclude the span start and span end, clear the boxes.

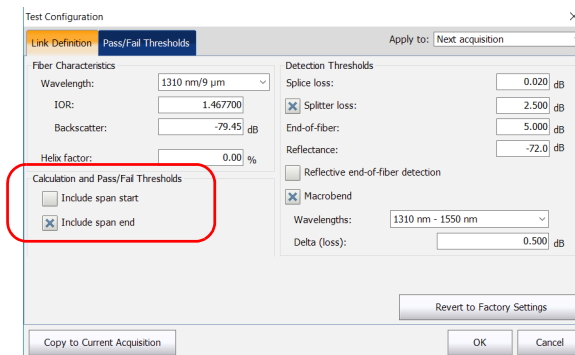

Preparing Your OTDR for a Test

Excluding and Including Span Start and Span End

- If you want to apply the test configuration information to the current acquisition, proceed as follows:

- 4a.** Tap the **Copy to Current Acquisition** button.

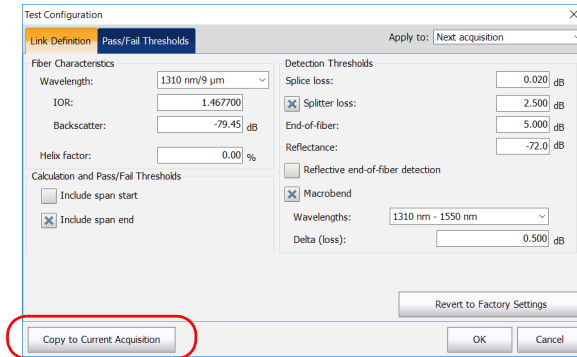

- 4b.** When the application prompts you, select **Yes**.

Note: The information in the **Link Definition** and **Pass/Fail Thresholds** tabs will be copied to the current acquisition.

- 5.** Tap **OK** to return to the main window.

Setting the Analysis Detection Thresholds

To optimize event detection, you can set the following analysis detection thresholds:

- *Splice loss threshold*: To display or hide small non-reflective events.
- *Splitter loss detection threshold*: To detect splitters on a link. Splitters are passive fiber optic couplers that divide light from a single fiber into two or more fiber channels. The splitter loss detection threshold value must be smaller than the end-of-fiber threshold value and greater than the splice loss threshold value. This threshold is not selected by default.

Note: *When working with a standard OTDR, the first event detected after the span start and the last event detected before the span end are defined as splitters, if they have a loss value higher than the splitter detection threshold value.*

If you are working with a MAX/FTBx-740C module and you apply a splitter detection threshold value for an acquisition, the algorithm of the application detects the couplers first.

- *Reflectance threshold*: To hide false reflective events generated by noise, transform non-harmful reflective events into loss events, or detect reflective events that could be harmful to network and other fiber-optic equipment.

Preparing Your OTDR for a Test

Setting the Analysis Detection Thresholds

- *End-of-fiber threshold:* To stop the analysis as soon as an important event loss occurs; for example, an event that could compromise signal transmission toward the end of a network.

When the end of fiber detection threshold is modified for an existing measurement, the span end position at the new end of fiber position can be automatically reset by the application.

Note: *If you are working with a MAX/FTBx-740C module, the end-of-fiber threshold value is set to 15 dB by default.*

Note: *Changing detection thresholds on the current trace leads to a reanalysis. All manual changes made will be lost.*



IMPORTANT

The end-of-fiber (EoF) threshold that you define will be used if you let the application evaluate the acquisition settings. If you set this threshold, an EoF event will be inserted at the first event for which the loss crosses the threshold. The application then uses this EoF event to determine the acquisition settings.

Setting the thresholds allow you either to ignore events with known lower values, or to ensure that all events are detected—even the ones for which very small values are measured.

The following examples show how different splice-loss threshold levels can affect the number of displayed events, especially small non-reflective events such as those caused by two splices. Three traces are shown, corresponding to three threshold level settings.

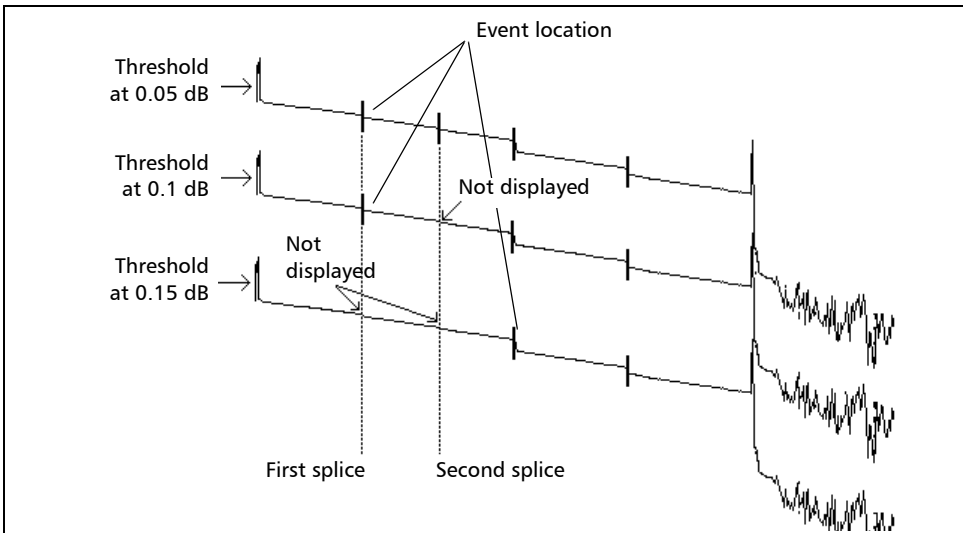

➤ *Threshold at 0.05 dB*

With the threshold set to 0.05 dB, two events are displayed at distances corresponding to the location of the first and second splices.

➤ *Threshold at 0.1 dB*

Only the first splice is displayed, as the threshold is set to 0.1 dB and the second splice loss is lower than 0.1 dB.

➤ *Threshold at 0.15 dB*

The first two splices are not displayed, as the threshold is set to 0.15 dB and the first and second splice losses are lower than 0.15 dB.

Thresholds values are saved with the measurement. It is possible to view these thresholds values even if you open the file on another unit.

Preparing Your OTDR for a Test

Setting the Analysis Detection Thresholds

To set the analysis detection thresholds:

1. From the **Main Menu**, tap **Test Configuration**.
2. From the **Apply to** list, select **Next acquisition**.

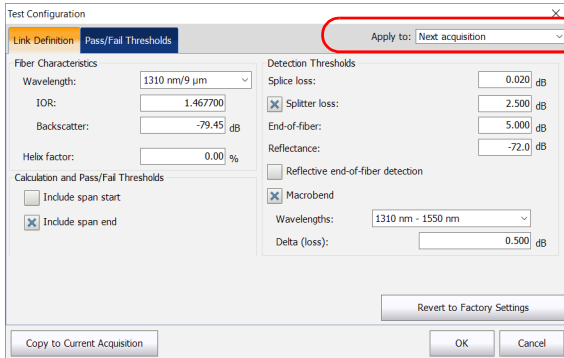

3. From the **Test Configuration** window, go to the **Link Definition** tab.

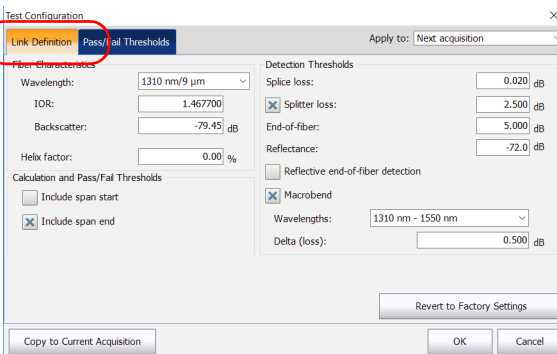



IMPORTANT

The Revert to Factory Settings button resets all the values in the Link Definition tab.

4. Under **Detection Thresholds**, enter the desired values in the appropriate boxes.

OR

If you want to revert all settings to their default values, tap the **Revert to Factory Settings** button.

Test Configuration

Link Definition Pass/Fail Thresholds Apply to: Next acquisition

Fiber Characteristics

Wavelength: 1310 nm/9 μ m

IOR: 1.467700

Backscatter: -79.45 dB

Helix factor: 0.00 %

Calculation and Pass/Fail Thresholds

Include span start

Include span end

Detection Thresholds

Splice loss: 0.020 dB

Splitter loss: 2.500 dB

End-of-fiber: 5.000 dB

Reflectance: -72.0 dB

Reflective end-of-fiber detection

Macrobend

Wavelengths: 1310 nm - 1550 nm

Delta (loss): 0.500 dB

Revert to Factory Settings

Copy to Current Acquisition OK Cancel

Preparing Your OTDR for a Test

Setting the Analysis Detection Thresholds

5. If you want to apply the test configuration information to the current acquisition, proceed as follows:

- 5a. Tap the **Copy to Current Acquisition** button.

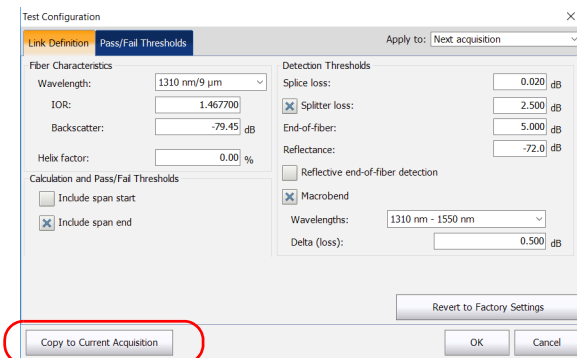

- 5b. When the application prompts you, select **Yes**.

Note: The information in the **Link Definition** and **Pass/Fail Thresholds** tabs will be copied to the current acquisition.

6. Tap **OK** to return to the main window.

The analysis detection thresholds you have just set will be applied to future traces.

Setting Macrobend Parameters

Note: *This feature is not available if you are working with a MAX/FTBx-740C-DWx module.*

Your unit can locate macrobends by comparing the loss value of an event at a given wavelength (for example, 1310 nm) with the loss value at the same location with another wavelength (for example, 1550 nm).

The unit will identify a macrobend when comparing two loss values if:

- Of the two loss values, the greater loss occurred at the greater wavelength.

AND

- The difference between the two loss values exceeds the defined delta loss value. The default delta loss value is 0.5 dB (which is suitable for most fibers), but you can modify it.

You can also disable macrobend detection.

Note: *Macrobend detection is only possible with singlemode wavelengths. Filtered wavelengths or port with only one wavelength are not available for macrobend detection.*

For information on how the information about macrobends is available after an acquisition, see *Summary Tab* on page 119.

Preparing Your OTDR for a Test

Setting Macrobend Parameters

To set macrobend parameters:

- 1.** From the **Main Menu**, tap **Test Configuration**.
- 2.** From the **Apply to** list, select **Next acquisition**.
- 3.** Select the **Link Definition** tab.
- 4.** To enable the macrobend detection, select the **Macrobend** check box.

OR

To disable it, clear the check box.

The screenshot shows the 'Test Configuration' dialog box with the 'Pass/Fail Thresholds' tab selected. The 'Apply to:' dropdown is set to 'Next acquisition'. The 'Macrobend' checkbox is checked and highlighted with a red circle. Other settings include:

Section	Parameter	Value
Fiber Characteristics	Wavelength	1310 nm/9 μm
	IOR	1.467700
	Backscatter	-79.45 dB
	Helix factor	0.00 %
Detection Thresholds	Splice loss	0.020 dB
	Splitter loss	2.500 dB
	End-of-fiber	5.000 dB
	Reflectance	-72.0 dB
	Reflective end-of-fiber detection	<input type="checkbox"/>
Calculation and Pass/Fail Thresholds	Include span start	<input type="checkbox"/>
	Include span end	<input checked="" type="checkbox"/>
Macrobend	Wavelengths	1310 nm - 1550 nm
	Delta (loss)	0.500 dB

Buttons at the bottom: Copy to Current Acquisition, Revert to Factory Settings, OK, Cancel.

5. If necessary, set the delta value as follows:

5a. From the wavelengths list, select the pair of wavelengths for which you want to define the delta value.

Note: *Only the combinations of wavelengths your module can support will be available for a next acquisition. For a current acquisition, the available wavelength in the file will be used.*

5b. In the **Delta (loss)** box, enter the desired value.

The screenshot shows the 'Test Configuration' dialog box with the 'Pass/Fail Thresholds' tab selected. The 'Apply to:' dropdown is set to 'Next acquisition'. The 'Fiber Characteristics' section includes 'Wavelength: 1310 nm/9 μm', 'IOR: 1.467700', 'Backscatter: -79.45 dB', and 'Helix factor: 0.00 %'. The 'Calculation and Pass/Fail Thresholds' section has 'Include span start' unchecked and 'Include span end' checked. The 'Detection Thresholds' section includes 'Splice loss: 0.020 dB', 'Splitter loss: 2.500 dB', 'End-of-fiber: 5.000 dB', and 'Reflectance: -72.0 dB'. The 'Macrobend' section has 'Reflective end-of-fiber detection' unchecked and 'Macrobend' checked. The 'Wavelengths' dropdown is set to '1310 nm - 1550 nm', and the 'Delta (loss)' field is set to '0.500 dB'. A red circle highlights the 'Wavelengths' and 'Delta (loss)' fields. At the bottom, there are buttons for 'Copy to Current Acquisition', 'Revert to Factory Settings', 'OK', and 'Cancel'.

5c. Repeat steps 5a and 5b for all wavelength combinations.

Preparing Your OTDR for a Test

Setting Macrobend Parameters

6. If you want to apply the test configuration information to the current acquisition, proceed as follows:

- 6a.** Tap the **Copy to Current Acquisition** button.

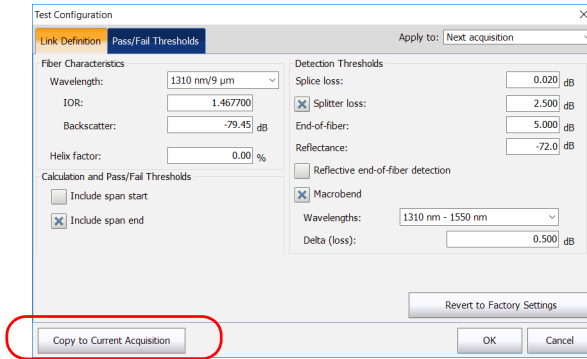

- 6b.** When the application prompts you, select **Yes**.
7. Tap **OK** to return to the main window.

Setting Pass/Fail Thresholds

Note: *If you are working with a MAX/FTBx-740C-DWx module, only the 1550 nm wavelength is available. This value is set by default.*

You can activate and set Pass/Fail threshold parameters for your tests.

Thresholds values are saved with the measurement file. It is possible to view these thresholds values even if you open the file on another unit.

You can set thresholds for splice loss, connector loss, splitter loss, reflectance, fiber section attenuation, span loss, span length, and span ORL. You can apply the same pass/fail thresholds to all test wavelengths or set different thresholds for each available test wavelength.

These pass/fail thresholds will be applied to the analysis results of all newly acquired traces as well as current traces with the corresponding wavelength.

If you work with files containing other wavelengths, the application will automatically add these wavelengths to the list of available wavelengths. You will then be able to define thresholds for these new wavelengths. You can revert all thresholds to their default values.

The loss, reflectance and attenuation thresholds that you set are applied to all events where such values can be measured.

Once the thresholds are set, the application will be able to perform Pass/Fail tests to determine the status of the results (pass or fail) .

Values that are greater than the predefined thresholds are displayed in white on a red background in the table of events. Span length, span loss and span ORL values are displayed in the **Summary** tab.

Preparing Your OTDR for a Test

Setting Pass/Fail Thresholds

To set pass/fail thresholds:

1. From the **Main Menu**, select **Test Configuration**.
2. From the **Apply to** list, select **Next acquisition**.
3. Select the **Pass/Fail Thresholds** tab.



IMPORTANT

In the **Apply to** list, **Next acquisition** and **Current acquisition** will be displayed if an acquisition was performed, but not saved yet. The current trace as well as the future acquisitions will be modified.

4. From the wavelength list, select the wavelength for which you want to set thresholds.

Note: You cannot select a wavelength if you are working with a *MAX/FTBx-740C-DWx* module. The wavelength is set to 1550 nm by default.

Note: If you are working with a standard OTDR or a *MAX/FTBx-740C-CWDM* module, select **All** to test all the wavelengths available.

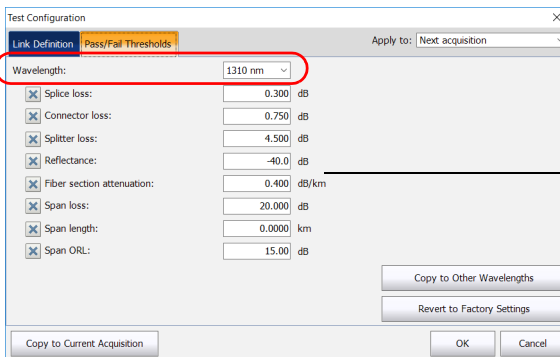

Value and unit associated with the threshold to set

5. Select the boxes corresponding to the thresholds that you want to use, and enter the desired values in the appropriate fields.

Parameter	Value
Splice loss:	0.300 dB
Connector loss:	0.750 dB
Splitter loss:	4.500 dB
Reflectance:	-40.0 dB
Fiber section attenuation:	0.400 dB/km
Span loss:	20.000 dB
Span length:	0.0000 km
Span ORL:	15.00 dB

The Revert to Factory Settings button resets all the values in the Pass/Fail Thresholds tab

Note: *If you no longer want the application to take into account a particular threshold, simply clear the corresponding check box.*

Note: *Selecting or clearing a particular thresholds check box will affect all the available wavelengths, not only the selected one.*

Preparing Your OTDR for a Test

Setting Pass/Fail Thresholds

- Depending on the wavelengths supported on your unit, if you want to apply the thresholds you have just defined to one or several other wavelengths, proceed as follows:

- Tap the **Copy to Other Wavelengths** button.

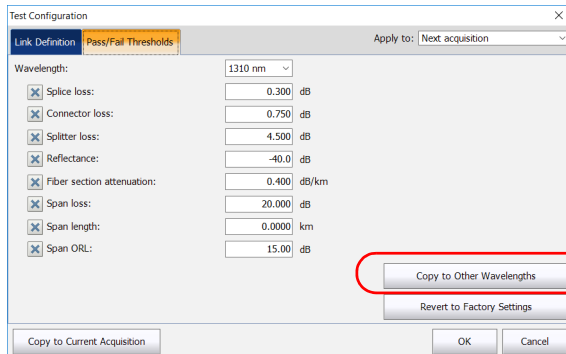

- Select the boxes corresponding to the wavelengths for which you want to use the same thresholds.

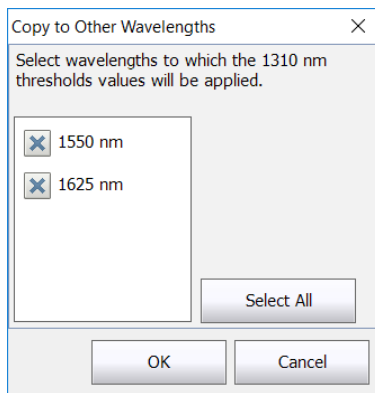

Note: You can use the **Select All** button to quickly select all boxes at the same time.

- Tap **OK** to confirm your selection.

7. If you want to apply the test configuration information to the current acquisition, proceed as follows:

7a. Tap the **Copy to Current Acquisition** button.

7b. When the application prompts you, select **Yes**.

Note: *The information in the **Link Definition** and **Pass/Fail Thresholds** tabs will be copied to the current acquisition.*

8. Tap **OK** to return to the main window.

Enabling or Disabling the Automated Acquisition Sequence

Note: *The MAX/FTBx-740C module does not support this feature.*

If your module is equipped with both an SM and an SM Live ports, you can perform automated acquisition sequences. The acquisition is always performed on the SM port first, and then on the SM Live port. If your module supports more than one wavelength, you need to select at least one wavelength to perform the acquisition on the SM port and one wavelength on the SM Live port.

When the feature is enabled, the application does not prompt you to connect the fiber on the SM Live port after the acquisition has been completed on the SM port.

When the feature is disabled, the application displays a message to indicate the moment you need to connect the fiber to the SM Live port. However, if you use a coupler between the fibers connected to the SM and SM Live ports, the application will perform the acquisitions one after another, and it will not prompt you.

The application stops automatically after it is complete but you can also stop it at any time while it is in progress.

Preparing Your OTDR for a Test

Enabling or Disabling the Automated Acquisition Sequence

Whether the feature is enabled or not, only one report is generated after the acquisition sequence is complete.

To enable or disable the automated acquisition sequence:

1. From the main window, go to the **OTDR** tab.
2. From the **Port/Fiber** list, select an **SM + SM Live** port.

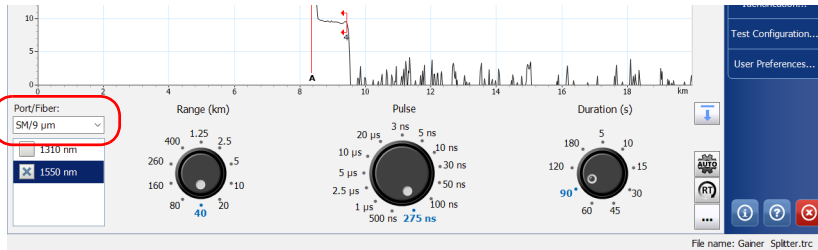

3. Select the boxes corresponding to the desired test wavelengths.

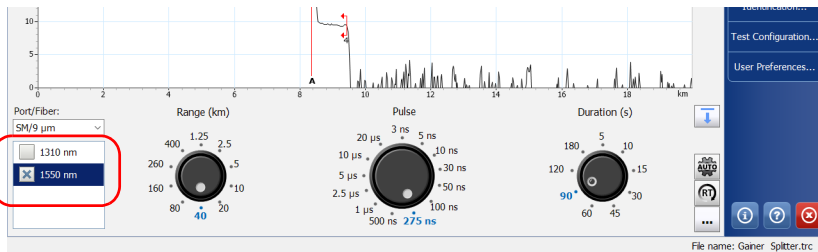

4. Tap the  button.

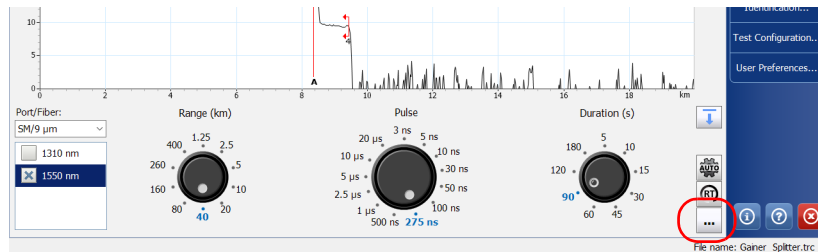

Preparing Your OTDR for a Test

Enabling or Disabling the Automated Acquisition Sequence

5. Under **Advanced Parameters**, to enable the automated acquisition sequence, select the **Automate SM and SM Live sequence** check box.

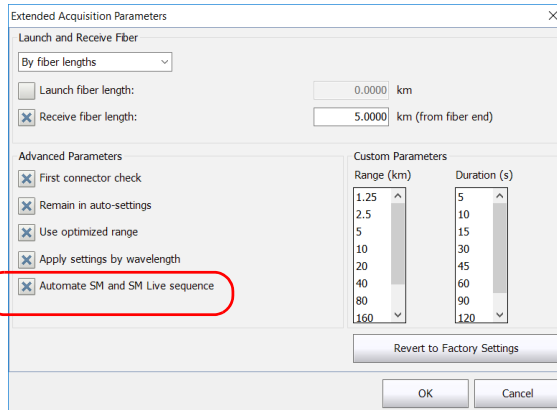

6. Tap **OK** to return to the main window.

4 **Working With the DWDM OTDR Module**

The MAX/FTBx-740C-DWx module is a DWDM (dense wavelength-division multiplexing) OTDR in the C-band and is designed to test through field mux/demux channels. This high-resolution particular type of OTDR provides a complete end-to-end link characterization and helps troubleshooting metro Ethernet links as well as commercial services.

Based on the ITU-T standard grid, the DWDM OTDR covers a channel spacing of 50/100/200 GHz. The channel width used by the OTDR is always 50 GHz, regardless of the selected channel spacing.

Main Features

The DWDM OTDR offers the following:

- C-band ITU grid channel selection to test through DWDM ports
- Mux/demux and add/drop testing
- In-service testing of active networks
- High-resolution and short dead zones
- Selection in a customized favorite channels list

Selecting a Channel Filter

The DWDM OTDR increases the bandwidth of an optical fiber by multiplexing several wavelengths onto it. Using the different channel spacings, the module can place several dozens of wavelengths on a single fiber. The channel filter selected by default is 100 GHz.

When you choose a channel filter, the list of available wavelengths is updated accordingly. If the channel that was selected before the change of filter is still available, it will remain selected by default. However, if the channel is no longer available after the change of channel spacing, the one nearest to your previous selection will be selected by default.

To select a specific channel filter:

1. From the main window, go to the **OTDR** tab.
2. From the **Channel filter** list, select a channel spacing width to use for your tests.

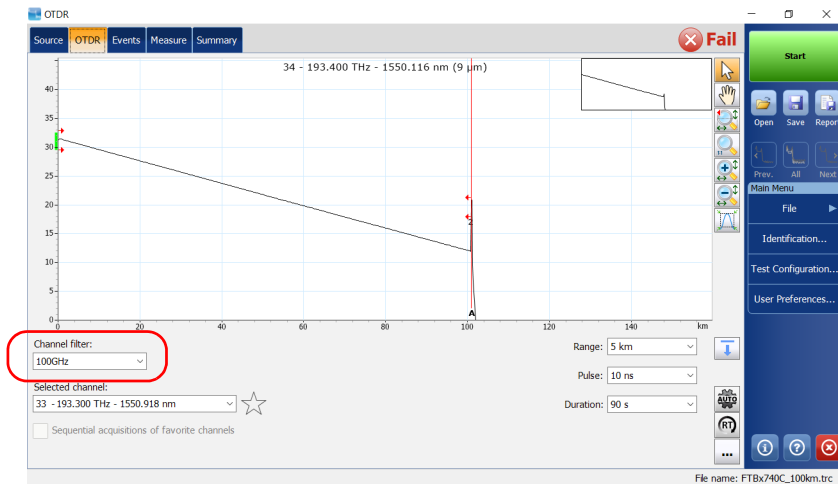

Note: The channels marked as favorite in the **Selected channel** list can be retrieved in the **Channel filter** list. See *Managing Favorite Channels on page 60* for details.

Selecting a Channel

Based on the ITU-T DWDM frequency grid, the DWDM OTDR offers many wavelengths you can choose from.

Note: Changing the channel filter does not affect the selected channel unless it is not available with the new channel filter.

To select a specific channel:

1. From the main window, go to the **OTDR** tab.
2. From the **Selected channel** list, select a wavelength to use for your tests.

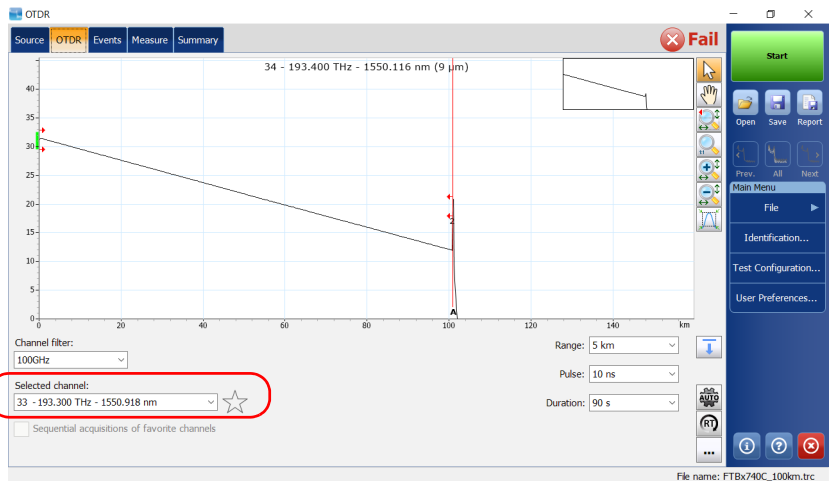

Managing Favorite Channels

You can add the channels you use the most often in a list of favorite channels and recall them for future acquisitions. You can also remove them from the list if they are not relevant anymore.

If you want to display the list of favorite channels only, you can do so.

To add favorite channels:

1. From the main window, go to the **OTDR** tab.
2. From the **Selected channel** list, select the wavelength you want to add to the list.
3. When the wavelength is highlighted in blue, tap .

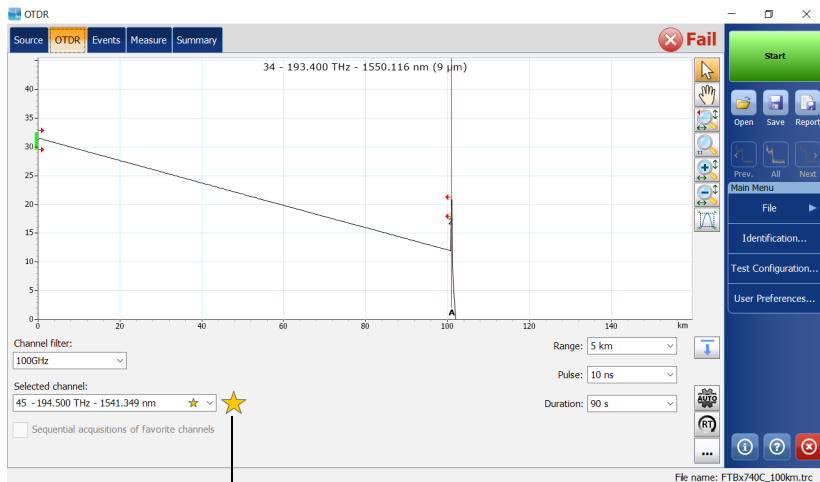

When the star becomes yellow, it indicates the wavelength has been added to the list.

To remove favorite channels from the list:

1. From the main window, go to the **OTDR** tab.
2. From the **Selected channel** list, select a wavelength with a  next to it.

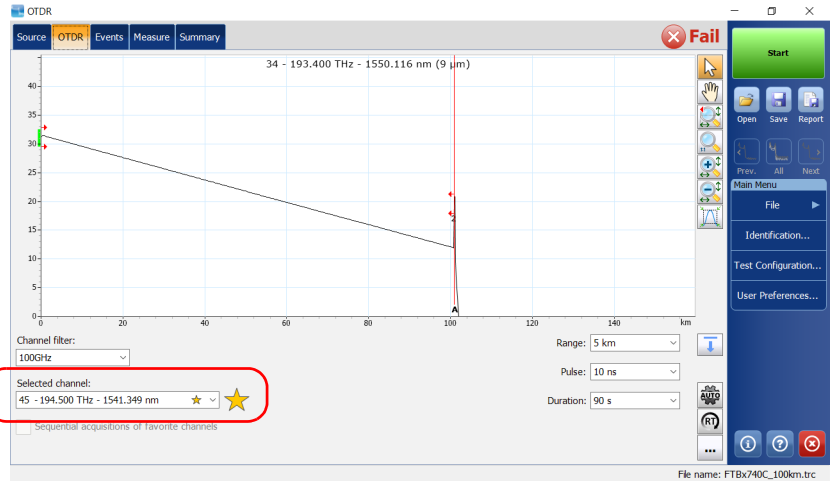

3. When the wavelength is highlighted in blue, tap .

Note: When the star is no longer yellow, it indicates the wavelength has been removed from the list.

Working With the DWDM OTDR Module

Managing Favorite Channels

To display the list of favorite channels only:

1. From the main window, go to the **OTDR** tab.
2. From the **Channel filter** list, select **Favorite channels**.

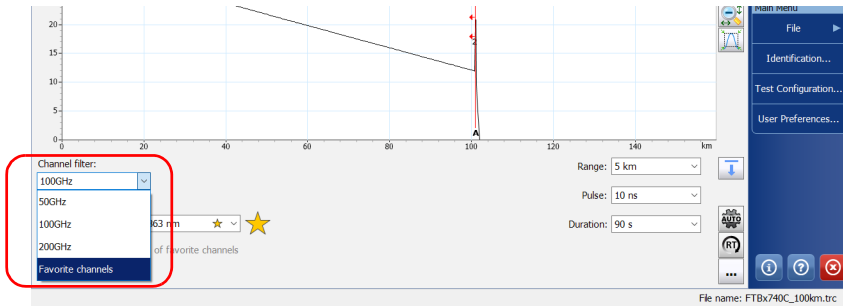

The list of favorite channels is displayed in the drop-down menu under **Selected channel**.

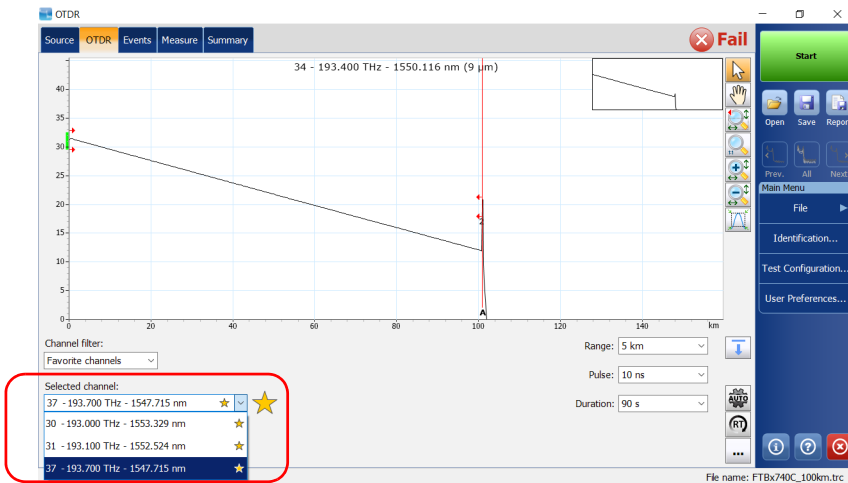

Testing Channels Sequentially

You can acquire traces sequentially for channels tagged as favorite channels.

The acquisitions are performed sequentially in the same order as the channels appear in the list of favorite channels as soon as you start an acquisition.

You can stop the acquisition at any time while it is in progress. The application stores the traces already acquired in the default folder you have defined. See *Setting the Default Storage Folder* on page 112 for details.

By default, the application saves the trace in native (.trc) format. This format contains all measurements of the sequence in a single file. If you choose to save all measurements of the sequence in Bellcore (.sor) format, the application will create one file per channel. See *Selecting the Default File Format* on page 113 for details.

To test channels sequentially:

1. From the main window, go to the **OTDR** tab.
2. From the **Channel filter** list, select **Favorite channels**.

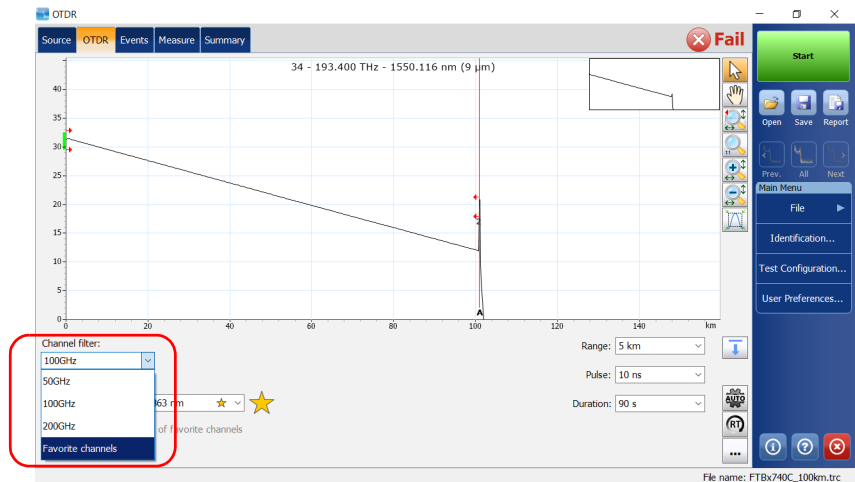

Working With the DWDM OTDR Module

Testing Channels Sequentially

3. Select the **Sequential acquisitions of favorite channels** box.

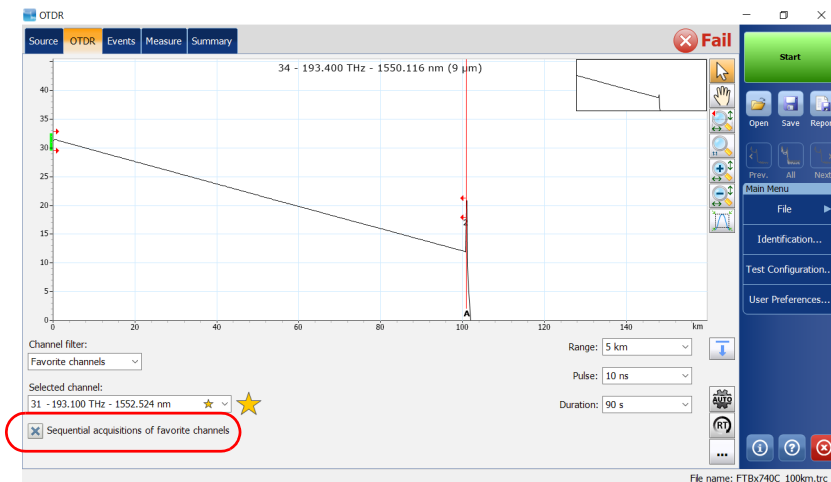

The list of favorite channels is displayed in the drop-down menu under **Selected channel**.

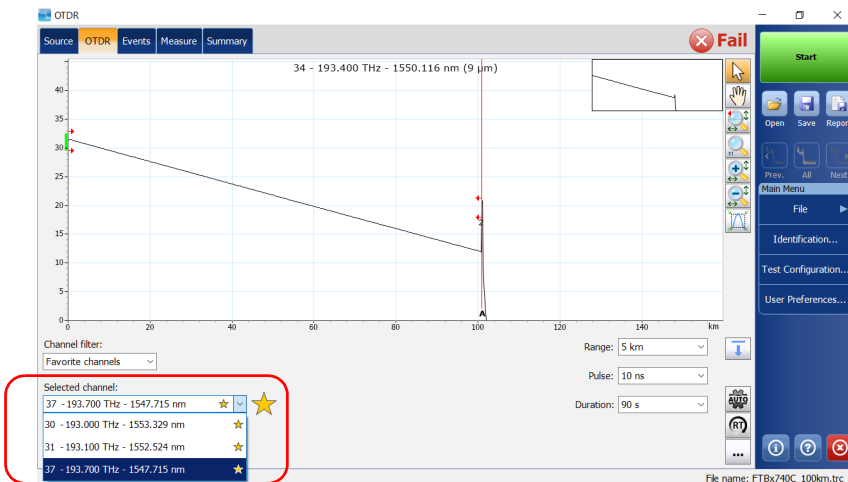

The acquisitions are performed sequentially as soon as you tap the **Start** button.

Performing Live-Fiber Testing

During live-fiber testing, the light signals transmitted in other channels than the channel under test will be largely rejected by the mux/demux and the OTDR filters, but some residual light that reaches the OTDR connector will increase the electronic noise. This residual light reduces the dynamic range of the OTDR, especially when larger pulse widths are used. The DWDM OTDR can test a channel while other channels are live but the channel under test must be dark.

Before performing a test on a specific channel, you have to disconnect the end of the link from the far-end transmitter/receiver device. Consequently, to test a transport fiber with active channels, you must connect the OTDR to a mux/demux port that contains no active channels or devices.

5 Working With the CWDM OTDR Module

The MAX/FTBx-740C-CW module is an OTDR that covers up to 18 CWDM ITU channels, from 1270 nm to 1610 nm, with a channel spacing of 20 nm, and is designed to test through field mux/demux channels. This high-resolution particular type of CWDM (coarse wavelength-division multiplexing) OTDR provides a complete end-to-end link characterization and helps troubleshooting commercial, C-RAN networks as well as metro Ethernet links deployments.

Note: *The official channel values have been shifted by 1 nm (from 1271 nm to 1611 nm). Your OTDR was defined with the values of 1270 nm to 1610 nm for simplicity purposes, but is fully compatible with previous and present channel center wavelengths.*

Main Features

The CWDM OTDR offers the following:

- CWDM ITU grid channel selection to test through CWDM ports
- Up to 18 CWDM channels covered into a single port, depending on the type of OTDR model and available options
- In-service testing of active networks
- High-resolution and short dead zones
- Selection in a customized favorite channels list

Working With the CWDM OTDR Module

Selecting a Channel Filter

Selecting a Channel Filter

The CWDM OTDR offers two different channel filters. You can choose to work with all the wavelengths available on your unit or with your favorite channels. See *Managing Favorite Channels* on page 70 for details.

To select a specific channel filter:

1. From the main window, go to the **OTDR** tab.
2. Select a channel filter to use for your test.

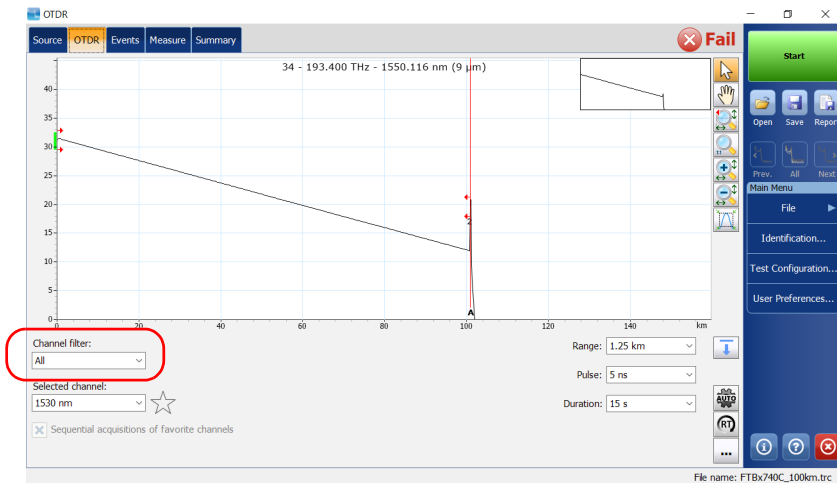

Note: If no channel has been added to the **Favorite channels** list, the application selects **All** by default.

Selecting a Channel

Based on the ITU-T CWDM wavelength grid, the OTDR offers 18 wavelengths (from 1270 nm to 1610 nm) you can choose from.

To select a specific channel:

1. From the main window, go to the **OTDR** tab.
2. From the **Selected channel** list, select a wavelength to use for your tests.



Managing Favorite Channels

You can add the channels you use most often in a list of favorite channels and recall them for future acquisitions. You can also remove them from the list if they are not relevant anymore.

If you want to display the list of favorite channels only, you can do so.

To add favorite channels:

1. From the main window, go to the **OTDR** tab.
2. From the **Selected channel** list, select the wavelength you want to add to the list.
3. When the wavelength is highlighted in blue, tap .

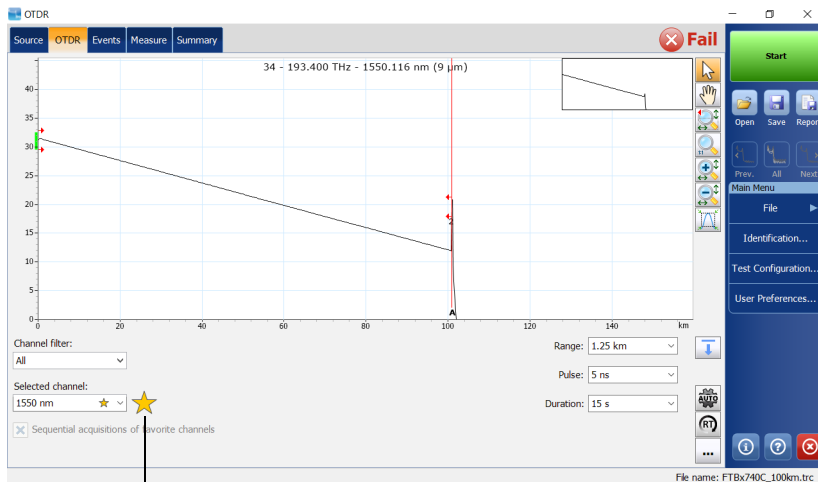

When the star becomes yellow, it indicates the wavelength has been added to the list.

To remove favorite channels from the list:

1. From the main window, go to the **OTDR** tab.
2. From the **Selected channel** list, select a wavelength with a  next to it.

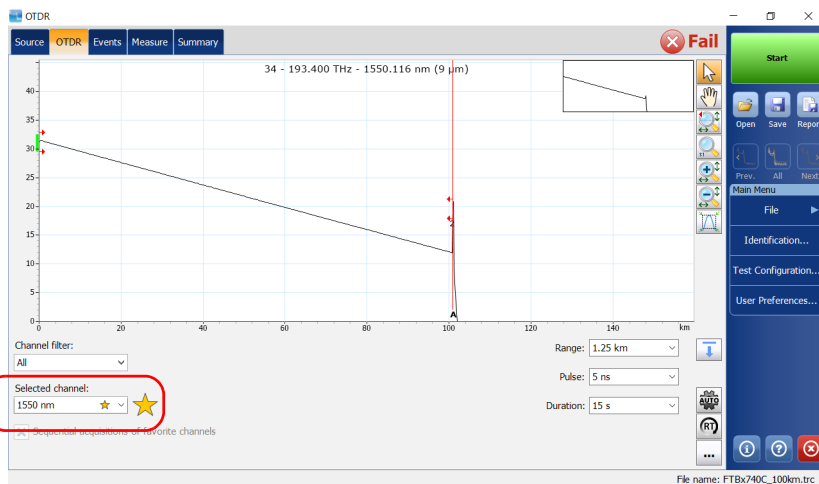

3. When the wavelength is highlighted in blue, tap .

Note: When the star is no longer yellow, it indicates the wavelength has been removed from the list.

Working With the CWDM OTDR Module

Managing Favorite Channels

To display the list of favorite channels only:

1. From the main window, go to the **OTDR** tab.
2. From the **Channel filter** list, select **Favorite channels**.

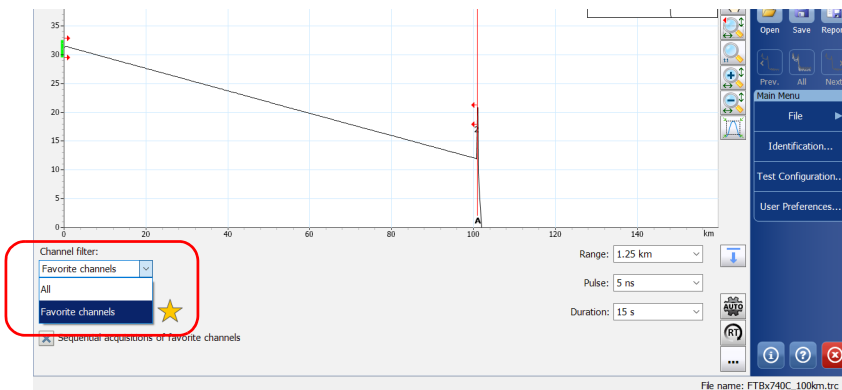

The list of favorite channels is displayed in the drop-down menu under **Selected channel**.

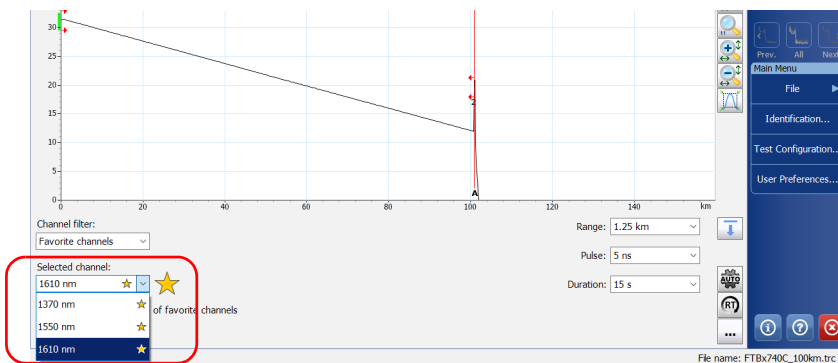

Testing Channels Sequentially

You can acquire traces sequentially for channels tagged as favorite channels.

The acquisitions are performed sequentially in the same order as the channels appear in the list of favorite channels as soon as you start an acquisition.

You can stop the acquisition at any time while it is in progress. The application stores the traces already acquired in the default folder you have defined. See *Setting the Default Storage Folder* on page 112 for details.

By default, the application saves the trace in native (.trc) format. This format contains all measurements of the sequence in a single file. If you choose to save all measurements of the sequence in Bellcore (.sor) format, the application will create one file per channel. See *Selecting the Default File Format* on page 113 for details.

To test channels sequentially:

1. From the main window, go to the **OTDR** tab.
2. From the **Channel filter** list, select **Favorite channels**.

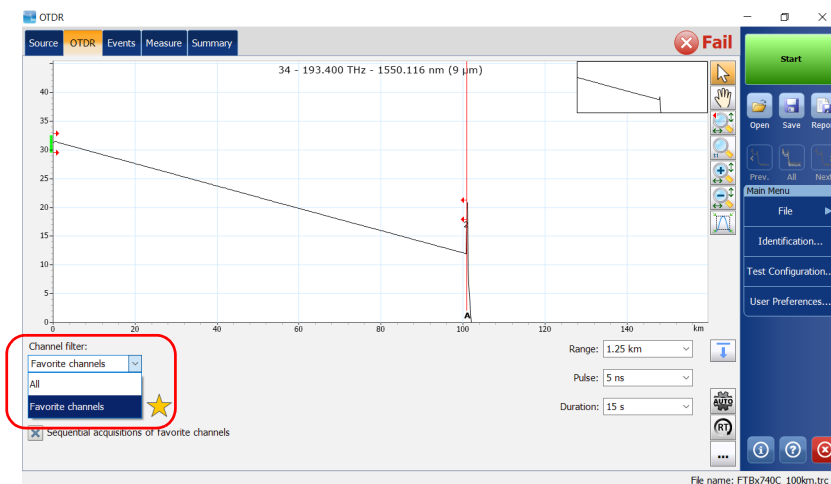

Working With the CWDM OTDR Module

Testing Channels Sequentially

3. Select the **Sequential acquisitions of favorite channels** box.

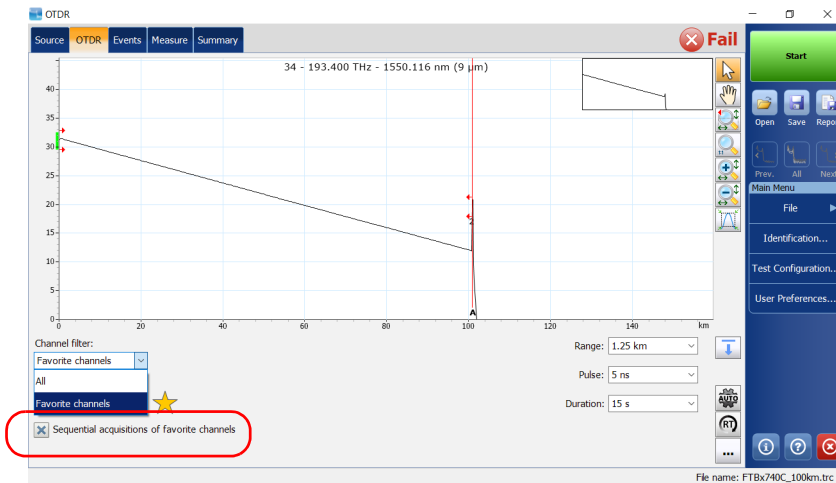

The list of favorite channels is displayed in the drop-down menu under **Selected channel**.



The acquisitions are performed sequentially as soon as you tap the **Start** button.

Detecting Macrobends on Fiber Links

The CWDM module allows you to detect macrobends on fiber links only when you select the 1310 nm - 1550 nm wavelength combination in the channel filter list.

Note: You need to activate the CWDM-18W option to detect macrobends on fiber links. See Software Options on page 8 for details.

You can edit the macrobend detection threshold value. If you do not define one, the application will apply the default value of 0.5 dB automatically when you load a test configuration.

Note: The application cannot detect couplers on the fiber link when the 1310 nm-1550 nm wavelength combination is selected.

To detect macrobends on fiber links:

1. From the main window, go to the **OTDR** tab.
2. From the **Channel filter** list, select **1310 nm - 1550 nm**.

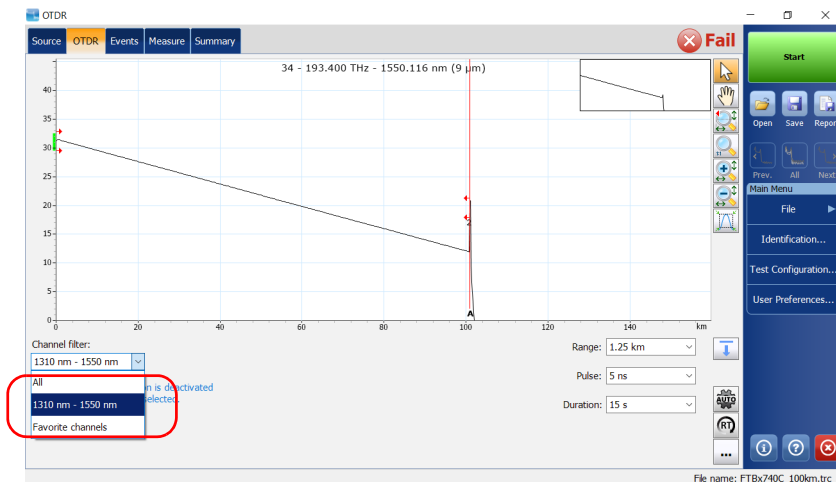

Working With the CWDM OTDR Module

Detecting Macrobends on Fiber Links

3. From the Main Menu, tap Test Configuration.

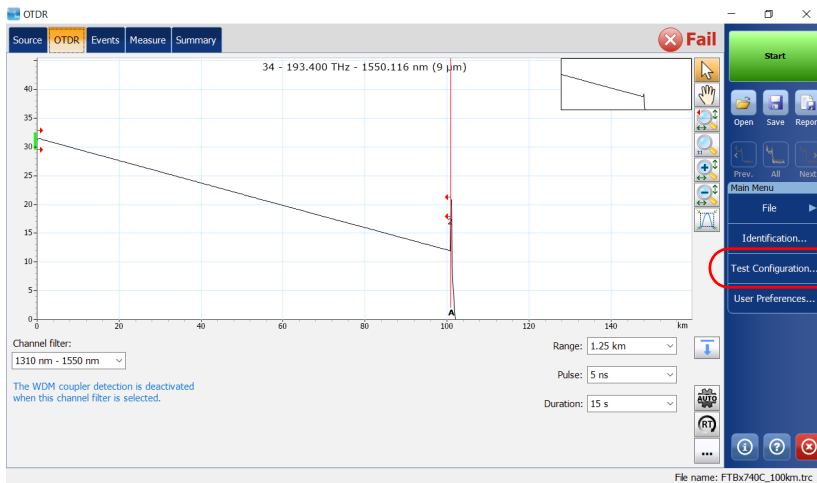

4. Select the Link Definition tab.

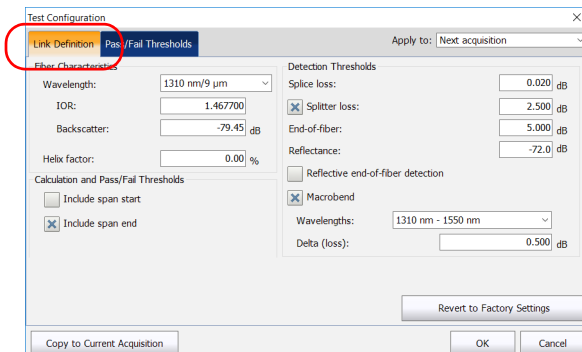

5. Select the **Macrobend** check box to enable the macrobend detection.

The screenshot shows the 'Test Configuration' dialog box with the 'Pass/Fail Thresholds' tab selected. The 'Detection Thresholds' section contains several settings: Splice loss (0.020 dB), Splitter loss (checked, 2.500 dB), End-of-fiber (5.000 dB), and Reflectance (-72.0 dB). The 'Macrobend' checkbox is checked and highlighted with a red circle. Other settings include Wavelength (1310 nm/9 μm), IOR (1.467700), Backscatter (-79.45 dB), Helix factor (0.00%), and Delta (loss) (0.500 dB). Buttons for 'Copy to Current Acquisition', 'Revert to Factory Settings', 'OK', and 'Cancel' are visible at the bottom.

6. In the **Delta (loss)** box, enter the desired value.

This screenshot is identical to the previous one, but the 'Delta (loss)' input field, which contains the value '0.500', is highlighted with a red circle. This indicates the step where the user enters the desired value for the Delta (loss) parameter.

7. Tap **OK** to return to the main window.

Performing Live-Fiber Testing

During live-fiber testing, the light signals transmitted in other channels than the channel under test will be largely rejected by the mux/demux, but some residual light that reaches the OTDR connector will increase the electronic noise. This residual light reduces the dynamic range of the OTDR, especially when larger pulse widths are used. The CWDM OTDR can test a channel while other channels are live but the channel under test must be dark.

Before performing a test on a specific channel, you have to disconnect the end of the link from the far-end transmitter/receiver device. Consequently, to test a transport fiber with active channels, you must connect the OTDR to a mux/demux port that contains no active channels or devices.

Understanding Fiber Water Peak

When water molecules are trapped within the glass core structure of the fiber, the light absorbed, as well as the fiber attenuation, will increase around 1383 nm. This is known as a fiber water peak and is more pronounced on older fibers. When working with a CWDM module, you will notice that wavelengths 1370 nm and 1390 nm are more likely to be affected by this phenomenon. The accuracy of an OTDR measurement performed at one of these two wavelengths may be affected if there are high fiber water peak on specific fiber sections.

6 *Testing Fibers*

Several tools are available to perform complete OTDR tests; you can also control all test parameters.

By default, all available test wavelengths are selected.

You can either set the acquisition parameters yourself or let the application determine the most appropriate values.

In the latter case, the application will automatically evaluate the best settings according to the fiber link currently connected to the unit.

Note: *If you are working with a MAX/FTBx-740C module and you use it for the first time, the auto-setting parameters feature is enabled by default. See Setting the Automatic Acquisition Parameters on page 85 for details.*

The pulse width will be determined using a factory-defined signal-to-noise ratio (SNR) requirement specified where the End-of-Fiber (EoF) event has been detected.

The EoF event detection algorithm uses the end-of-fiber threshold defined in the **Test Configuration** window (see *Setting the Analysis Detection Thresholds* on page 39 for details). If you are not sure about which value to choose, revert to the factory default value for this parameter.

Although the application sets the acquisition parameters, you can modify these values as needed, even while the acquisition is in progress. The OTDR simply restarts the averaging each time a modification is made.

Note: *You can interrupt the acquisition at any time. The application will display the information acquired to that point.*

Testing Fibers

After analysis, events appear in the **Events** tab. See *Analyzing Traces and Events* on page 117 for details.

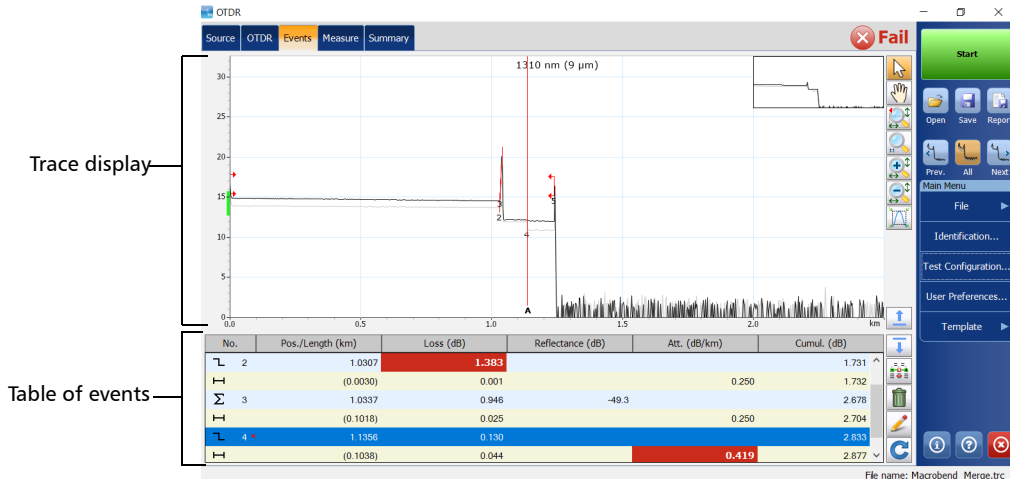

You can save the measurement after analysis. If former results have not been saved yet, the application prompts you to save them before starting a new acquisition.

To acquire traces:

1. Clean the connectors properly (see *Cleaning and Connecting Optical Fibers* on page 24 for details).
2. Connect a fiber to the OTDR port.

If your unit is equipped with two OTDR ports, ensure that you connect the fiber to the appropriate port (singlemode, singlemode live, or multimode), depending on the wavelength you intend to use.



CAUTION

Never connect a live fiber to the OTDR port without a proper setup. Any incoming optical power ranging from -65 dBm to -40 dBm will affect the OTDR acquisition. The way the acquisition will be affected depends on the selected pulse width.

Any incoming signal greater than 10 dBm could damage your OTDR module permanently. For live-fiber testing, refer to the SM Live port specifications for the characteristics of the built-in filter.

3. If you want to set your own IOR (group index), RBS coefficient or helix factor, see *Setting the IOR, RBS Coefficient, and Helix Factor* on page 32 for details.
4. If you want to set the first connector check, see *Enabling or Disabling the First Connector Check* on page 92 for details.
5. Go to the **OTDR** tab.

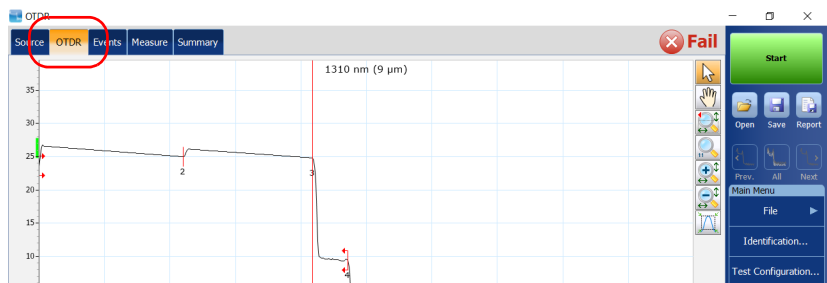

Testing Fibers

- If you have a standard OTDR, from the **Port/Fiber** list, select the desired fiber type (for live-fiber testing, select SM Live; for C fiber, select 50 μm and for D fiber, select 62.5 μm).

OR

If you have a DWDM or a CWDM OTDR, select a channel filter and a specific channel. See *Working With the DWDM OTDR Module* on page 57 or *Working With the CWDM OTDR Module* on page 67 for details.

Standard OTDR

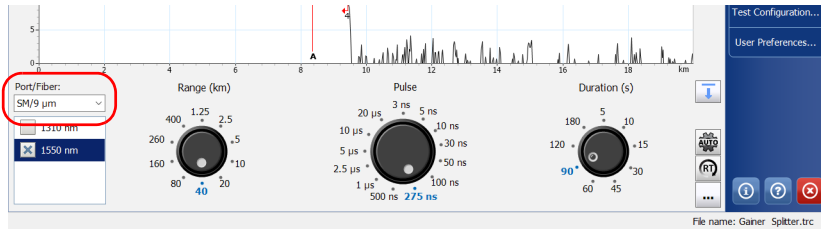

DWDM and CWDM OTDR

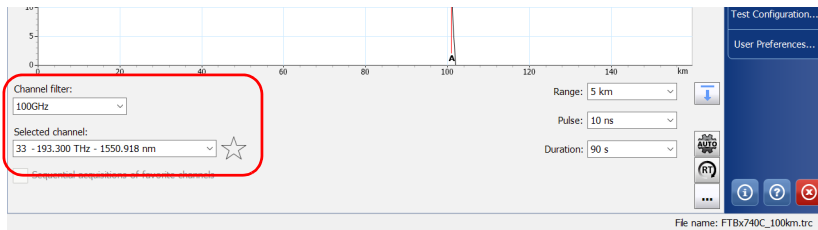

7. If you have a standard OTDR, select the boxes corresponding to the desired test wavelengths.
8. Select the desired distance range, pulse, and time values. See *Setting Distance Range, Pulse Width, and Acquisition Time* on page 94 for details.

Standard OTDR

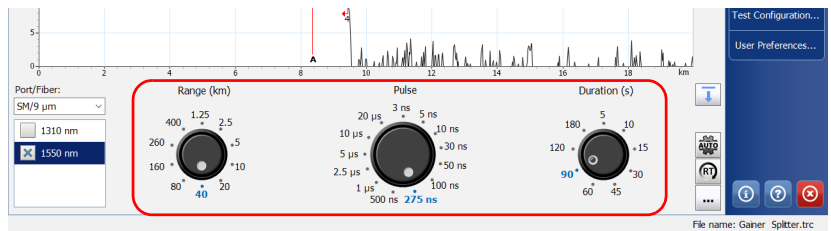

DWDM and CWDM OTDR

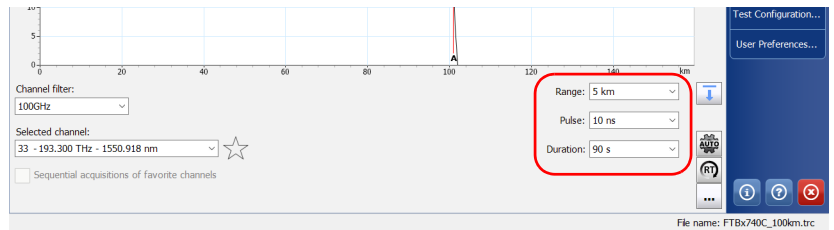

Note: To configure different parameters for each wavelength, see *Applying Acquisition Settings by Wavelength* on page 93 for details.

- 9.** Tap **Start**. If the first connector check feature is enabled, a message will appear if there is a problem with the injection level (see *Enabling or Disabling the First Connector Check* on page 92 for details).

Note: *The acquisition starts with the selected wavelength. The following wavelengths are tested in increasing order (smallest to largest).*

You can modify the acquisition parameters as needed while the acquisition is in progress. The OTDR simply restarts the averaging each time a modification is made. This applies only to the wavelength currently under test. Changing the time parameter does not restart the acquisition.

- 10.** Once the analysis is complete, save the trace by tapping **Save** in the button bar.

The application will use a file name based on the autonaming parameters you defined (see *Naming Trace Files Automatically* on page 26 for details). This file name appears in the status bar.

The files that have to be saved are sent in the default file folder (see *Setting the Default Storage Folder* on page 112 for details).

Note: *The application will only display the **Save As** dialog box if you have activated the feature to always be prompted when you save a file. From this dialog box, you can change the location, the file name and the file format. See *Enabling or Disabling File Name Confirmation* on page 115 for details.*

Even if you modify the name of the file, next time you save a trace, the unit will prepare the next file name by incrementing or decrementing the suffix.

- 10a.** If necessary, change the folder to which the file will be saved by tapping the parent folder button until you reach the desired location.

10b. If necessary, specify a file name.

10c. Tap **Save** to confirm.

Setting the Automatic Acquisition Parameters

When the auto-setting parameters are activated, and if your module supports more than one wavelength, the application calculates the distance and pulse for the first wavelength, then for the second wavelength, and so on.

You can also enable a feature that will let you select the optimized range and pulse for the distance as determined by the application when the auto-settings parameters are used at least once.

To set the automatic acquisition parameters:

1. From the main window, go to the **OTDR** tab.
2. Select the appropriate time for your test. The default value is 15 seconds.

Standard OTDR

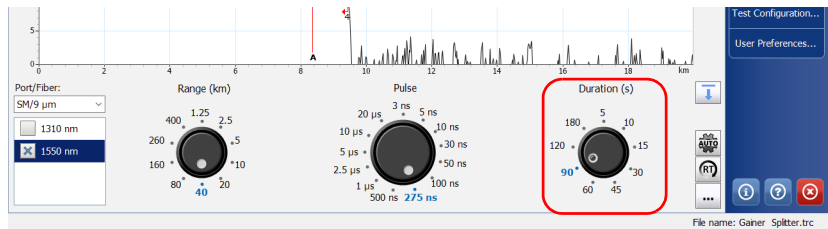

DWDM and CWDM OTDR

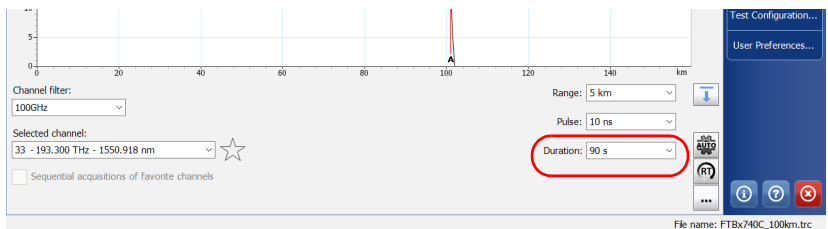

Testing Fibers

Setting the Automatic Acquisition Parameters

3. Tap AUTO.

Standard OTDR

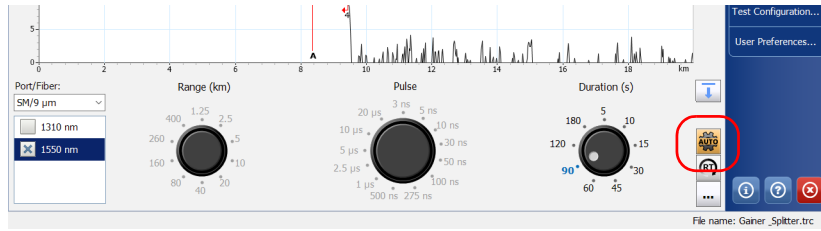

DWDM and CWDM OTDR

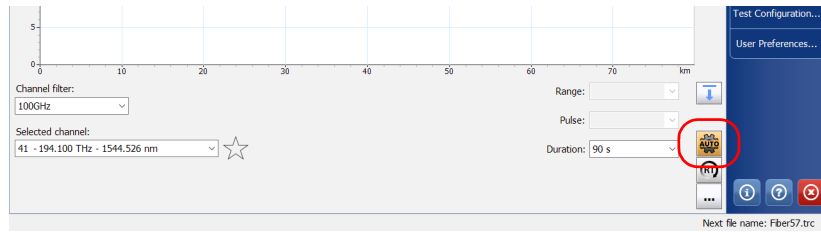

4. If you want to keep the auto-settings activated once an acquisition is done, proceed as follows:
 - 4a. Tap the  button in the OTDR tab.
 - 4b. Under **Advanced Parameters**, select the **Remain in auto-settings** box.

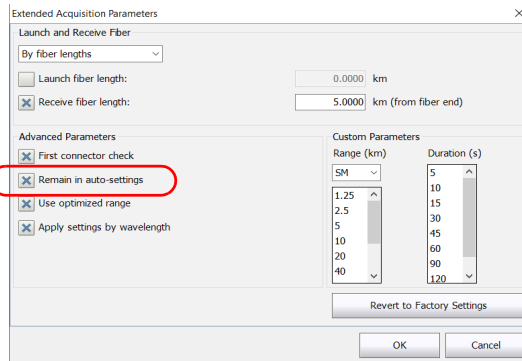

Note: *If you are working with a MAX/FTBx-740C module and you use it for the first time, this parameter is activated by default.*

- 4c. Tap **OK** to return to the main window.

Testing Fibers

Setting the Automatic Acquisition Parameters

5. If you want to use the optimized range feature, proceed as follows:
 - 5a. Tap the  button in the OTDR tab.
 - 5b. Under **Advanced Parameters**, select the **Use optimized range** box.

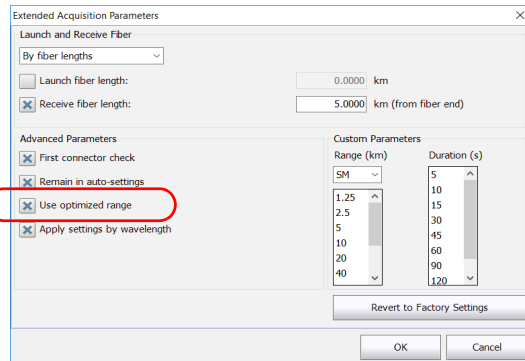

- 5c. Tap **OK** to return to the main window.
6. Tap **Start** to launch the acquisition.

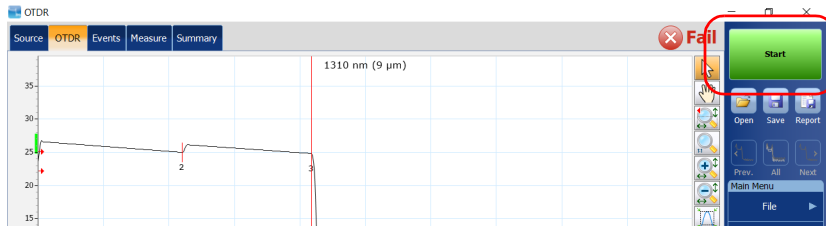

Defining Launch and Receive Fiber Settings

Launch and receive fibers are used to characterize respectively the first and last connectors in your fiber under test. A launch fiber allows the OTDR to recover after the test pulse is sent into the fiber, while a receive fiber is used to enable measurements of the connector (loss and reflectance) at the end of the fiber under test.

When you perform tests with your unit, you connect a launch fiber between your unit and the fiber under test. You can also connect a receive fiber at the end of the fiber under test. By default, the fiber span includes the receive fiber (but not the launch fiber).

When you define the length of the launch fiber, the application sets the fiber span start at the beginning of the fiber under test. The span start becomes event 1 and its distance reference becomes 0. It allows to characterize the first connector at the beginning of the fiber. The application will include the loss caused by the span start event in the displayed values. The span start event will also be taken into account when determining the status (pass/fail) of connector loss and reflectance. If you do not know the fiber length, it is also possible to define the launch fiber by event number.

When the receive length is mentioned, the application finds the event which is characterized as the end of fiber. The span end is moved according to a value corresponding to the specified receive fiber length (except for continuous or end of analysis events). When the span end is positioned, an event should be near the new position of the span end. If no event is found, the application will automatically add an event where there should be one. The application can also set the span end according to a number of events instead of using a distance.

If the launch and receive fibers are not defined, they will appear as if they were part of the fiber under test (fiber span). The cumulative loss is calculated for the defined fiber span only. Events excluded from the fiber span are shaded in the table of events, and do not appear in the trace display.

Testing Fibers

Defining Launch and Receive Fiber Settings

To set the launch and receive settings for the next acquisition:

1. From the main window, go to the **OTDR** tab, then tap the **☰** button.

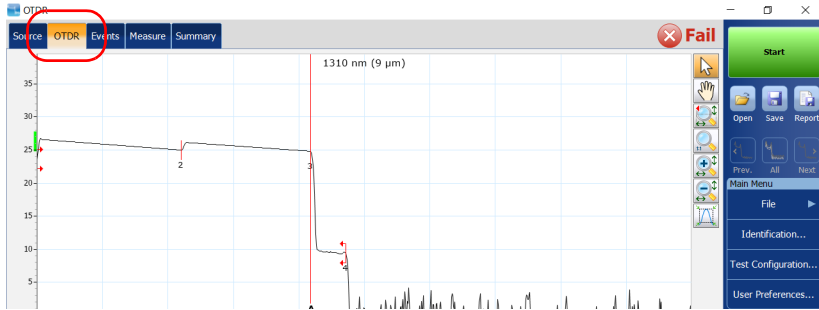

2. Under **Launch and Receive Fiber**, select if you want to apply settings **By fiber lengths** or **By event**.

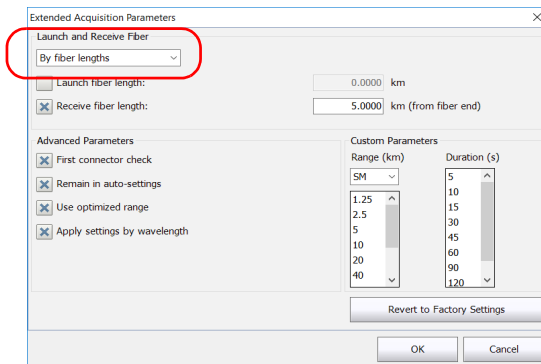

3. Select the check boxes corresponding to your needs and enter the appropriate information in the boxes.

Extended Acquisition Parameters

Launch and Receive Fiber

By fiber lengths

Launch fiber length: 0.0000 km

Receive fiber length: 5.0000 km (from fiber end)

Advanced Parameters

First connector check

Remain in auto-settings

Use optimized range

Apply settings by wavelength

Custom Parameters

Range (km)	Duration (s)
SM	5
1.25	10
2.5	15
5	30
10	45
20	60
40	90
	120

Revert to Factory Settings

OK Cancel

4. Tap **OK** to return to the main window.

Testing Fibers

Enabling or Disabling the First Connector Check

Enabling or Disabling the First Connector Check

The first connector check feature is used to verify that the fibers are properly connected to the OTDR. It verifies the injection level and displays a message when an unusually high loss occurs at the first connection, which could indicate that no fiber is connected to the OTDR port. By default, this feature is disabled.

To enable or disable the first connector check:

1. From the main window, tap the **OTDR** tab then tap the  button.

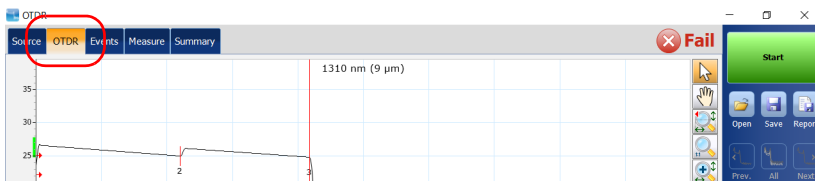

2. Under **Advanced Parameters**, to enable the first connector check, select the **First connector check** box.

OR

To disable it, clear the box.

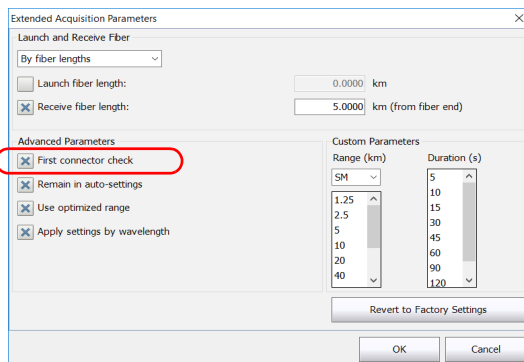

3. Tap **OK** to return to the main window.

Applying Acquisition Settings by Wavelength

By default, the modifications made to the parameters (distance, pulse, and time) are applied to all wavelengths. However, it is possible to modify the acquisition parameters independently for each wavelength.

To apply acquisition settings by wavelength:

1. From the main window, select the **OTDR** tab then tap the  button.
2. Under **Advanced Parameters**, select the **Apply settings by wavelength** box.

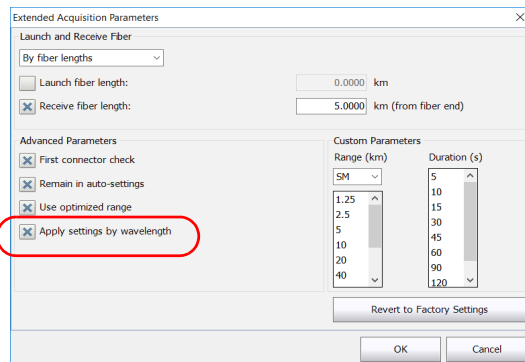

Note: This feature is not displayed if you are working with a MAX/FTBx-740C module.

3. Tap **OK** to return to the main window.

You can now set the distance range, the pulse width, and the acquisition time independently for each wavelength.

Setting Distance Range, Pulse Width, and Acquisition Time

The distance range, pulse width and acquisition time are set with the controls in the OTDR main window.

- **Range:** corresponds to the distance range of the fiber under test according to the selected measurement units (see *Selecting the Distance Units* on page 102 for details).

Changing the distance range modifies the available settings of the pulse width and leaves only the settings available for the specified range.

- **Pulse:** corresponds to the pulse width for the test. A longer pulse allows you to probe further along the fiber, but results in less resolution. A shorter pulse width provides higher resolution, but less distance range. The available distance ranges and pulse widths depend on your OTDR model.

Note: *Not all pulse widths are compatible with all distance ranges.*

- **Duration:** corresponds to the acquisition duration (period during which results will be averaged). Generally, longer acquisition times generate cleaner traces (this is especially true with long-distance traces) because as the acquisition time increases, more of the noise is averaged out. This averaging increases the signal-to-noise ratio (SNR) and the OTDR's ability to detect small events.

The time settings will also determine how the timer (displayed in the toolbar) counts time during testing.

You can use the same distance range, pulse width and acquisition time parameters for testing at all wavelengths on a multiwavelength OTDR. See *Applying Acquisition Settings by Wavelength* on page 93 for details.

To set the parameters:

If you have a standard OTDR, from the **OTDR** tab:

- Tap the dial corresponding to the parameter you wish to set (the selection marker will move clockwise).

OR

- Tap directly the value to select it. The selection marker will go to that value immediately.

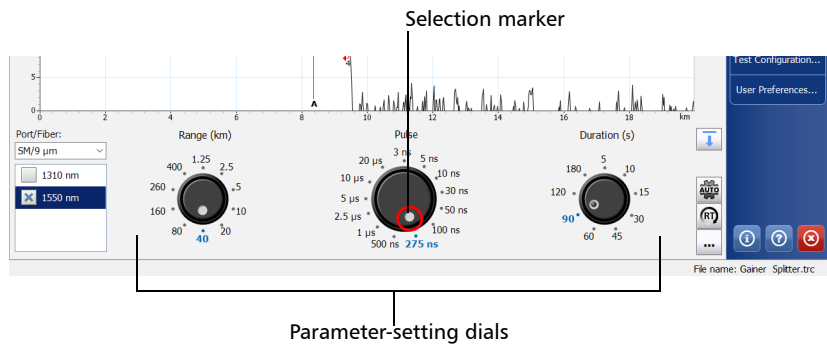

OR

If you have a DWDM or a CWDM OTDR, select the parameters you wish to set and use the drop-down list to set the values accordingly.

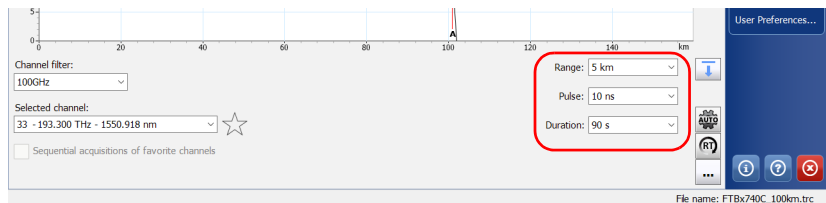

Note: *If your OTDR supports singlemode, singlemode live, or multimode wavelengths, settings would be applied to either singlemode, singlemode live, or multimode wavelengths, depending on the selected fiber type (same settings for 50 μm and 62.5 μm).*

Testing Fibers

Monitoring Fibers in Real-Time Mode

Monitoring Fibers in Real-Time Mode

The application allows you to immediately view sudden changes in the fiber link. In this mode, the trace is refreshed instead of averaged until you switch to average mode or stop the acquisition.

Note: You can only use one wavelength at a time to monitor your fiber.

You can switch from real-time mode to the averaging time interval mode at any time. You can also switch between wavelengths during an acquisition.

To activate the real-time mode:

1. From the **OTDR** tab, tap **RT**. The **RT** button turns orange to show that the real-time mode is activated.

Standard OTDR

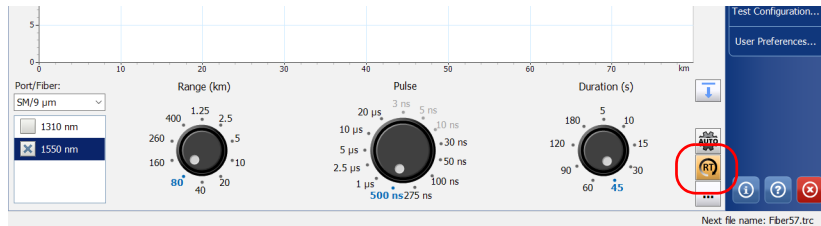

DWDM and CWDM OTDR

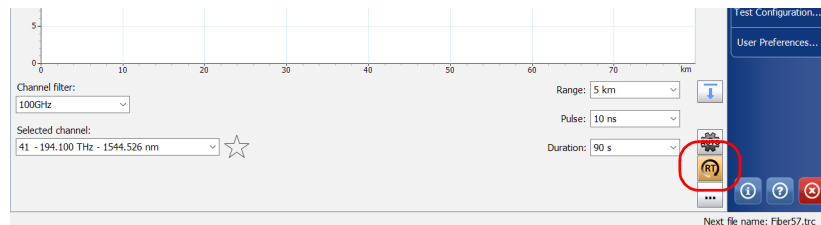

2. If you have a standard OTDR, from the **Port/Fiber** list, select the desired fiber type (for live-fiber testing, select SM Live; for C fiber, select 50 μm and for D fiber, select 62.5 μm).

OR

If you have a DWDM or a CWDM OTDR, select a channel filter and a specific channel. See *Working With the DWDM OTDR Module* on page 57 or *Working With the CWDM OTDR Module* on page 67 for details.

Standard OTDR

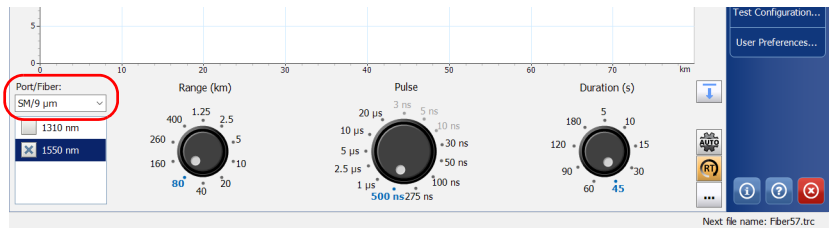

DWDM and CWDM OTDR

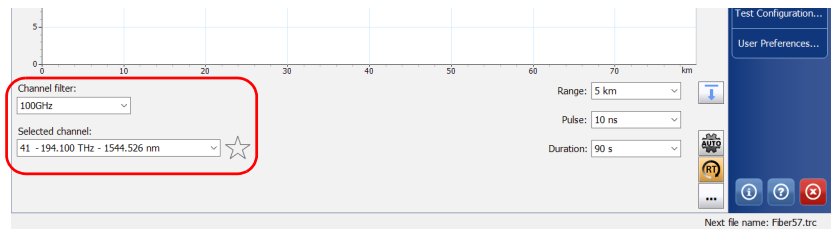

Testing Fibers

Monitoring Fibers in Real-Time Mode

3. If you have a standard OTDR, select the boxes corresponding to the desired test wavelengths.
4. Select the desired distance range, pulse, and time values. See *Setting Distance Range, Pulse Width, and Acquisition Time* on page 94 for details.
5. Tap **Start RT**.

Note: *The timer is not displayed during real-time acquisition.*

6. If you have a standard OTDR, from the wavelength list, tap the wavelength value (not the checkbox) corresponding to the wavelength that you want to monitor.

To deactivate the real-time mode :

- If you want to stop monitoring, tap **Stop RT**.
- If you have the full OTDR application, you can also stop the real-time acquisition by starting an averaged acquisition. All the wavelengths for which boxes are selected will be tested in averaging time interval mode (not only the highlighted one).

7 Customizing Your OTDR

You can customize the appearance and behavior of your OTDR application.

Setting Event Table and Graph Display Parameters

You can include or exclude items from the table of events to better suit your needs. You can also change several trace display parameters:

- the gridlines: You can display or hide the grid appearing on the graph's background. By default, the grid is displayed.
- the graph background: You can display the graph with a black (invert color feature) or a white background. By default, the background is white.
- the graph overview: The graph overview window shows you which portion of the graph is being magnified.

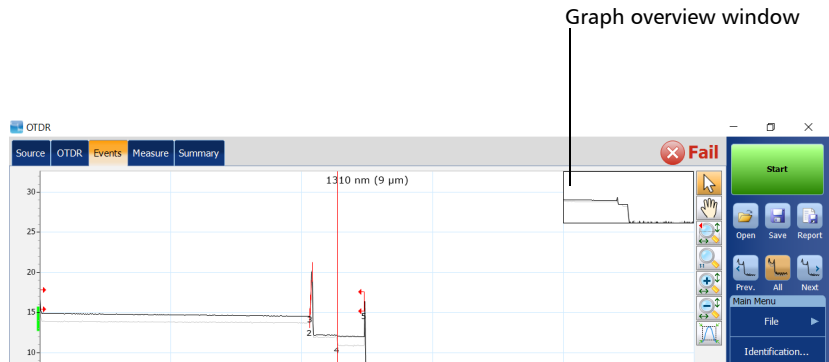

Note: The application always generates graphs with a white background in the reports.

Customizing Your OTDR

Setting Event Table and Graph Display Parameters

To set the event table and graph display parameters:

1. From the **Main Menu**, tap the **User Preferences** button.
2. Select the **Graph** tab.
3. Under **Display**, select the boxes corresponding to the item you want to display or include in the table.

OR

To hide them, clear the boxes.

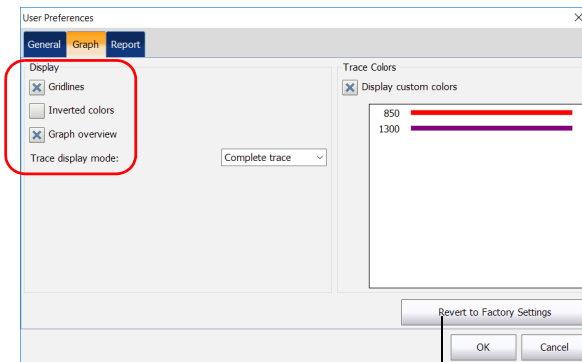

The **Revert to Factory Settings** button resets all the values in the **Graph** tab

4. Tap **OK** to return to the main window.

Displaying or Hiding Fiber Sections on a Trace

You can display or hide fiber sections in the table of events, depending on the types of values you want to display. When the fiber sections are hidden, the **Att.** column is also hidden.

Note: *Hiding the fiber sections will not delete them.*

To display or hide fiber sections on a trace:

1. From the **Main Menu**, tap the **User Preferences** button.
2. Select the **General** tab.
3. If you want to display the fiber sections on a trace, select the **Fiber sections** check box.

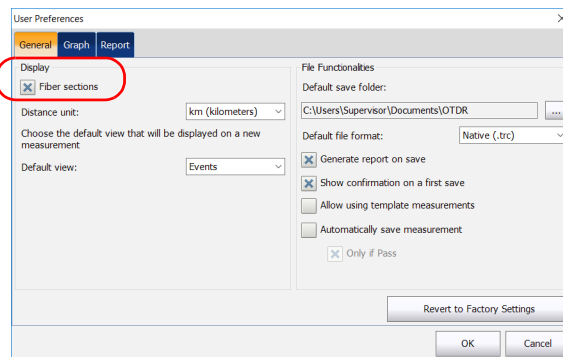

4. Tap **OK** to return to the main window.

Customizing Your OTDR

Selecting the Distance Units

Selecting the Distance Units

You can select the measurement units that will be used throughout the application.

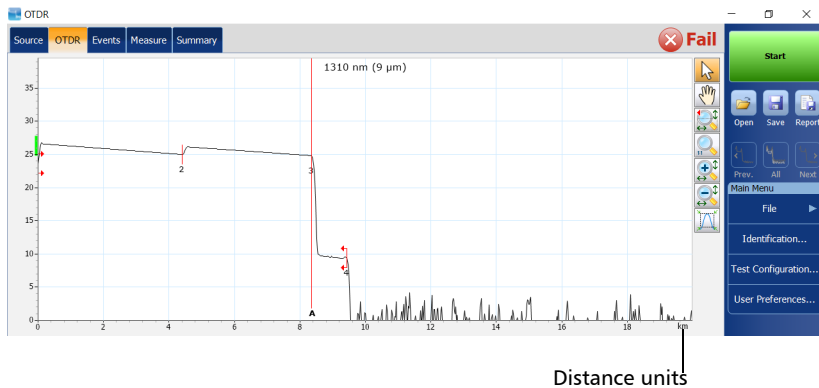

The default distance units are the kilometers.

Note: *The attenuation of fiber sections is always presented in dBs per kilometer even if the distance units you selected are not the kilometers. This follows the standards of the fiber-optic industry that provides the attenuation values in dBs per kilometer.*

To select the distance units for your display:

- 1.** From the **Main Menu**, tap the **User Preferences** button.
- 2.** Select the **General** tab.
- 3.** From the **Distance unit** list, select the item corresponding to the desired distance units.

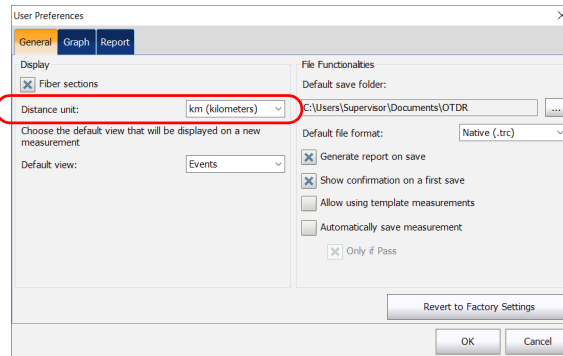

- 4.** Tap **OK** to return to the main window.

You return to the main window and the newly selected distance unit appears everywhere units are used.

Customizing Your OTDR

Customizing the Acquisition Distance Range Values

Customizing the Acquisition Distance Range Values

The distance range value is one of the parameters you can customize before performing acquisitions. Depending on what you want to examine on a fiber, you can set a longer or shorter distance. See *Setting Distance Range, Pulse Width, and Acquisition Time* on page 94 for details.

Standard OTDR

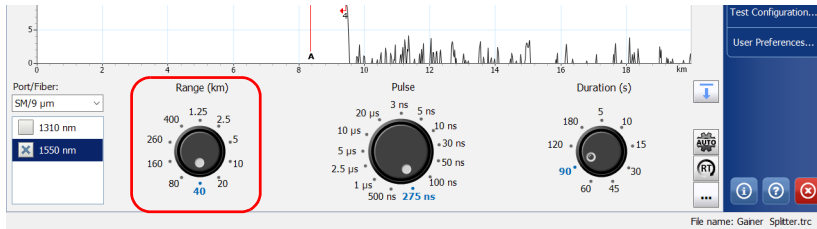

DWDM and CWDM OTDR

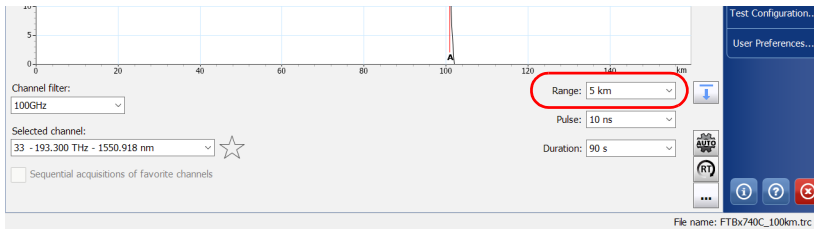

Note: The value found by an auto acquisition cannot be modified.

To customize the distance range values:

1. From the main window, select the **OTDR** tab then tap the  button.
2. Under **Custom Parameters**, if your OTDR supports singlemode or multimode, specify the desired fiber type.

Note: The fiber type list is not displayed if the module has only one fiber type.

3. From the **Range** list, select the value you want to modify.
4. When the value becomes highlighted, enter the new value.

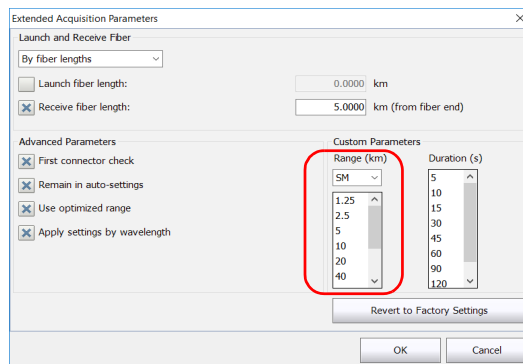

5. Tap **OK** to return to the main window.

Note: You can revert to factory values by pressing the **Revert to Factory Settings** button.

Customizing Your OTDR

Customizing the Acquisition Time Values

Customizing the Acquisition Time Values

You can customize the acquisition time values. These values represent the time during which the OTDR will average acquisitions. See *Setting Distance Range, Pulse Width, and Acquisition Time* on page 94 for details.

Standard OTDR

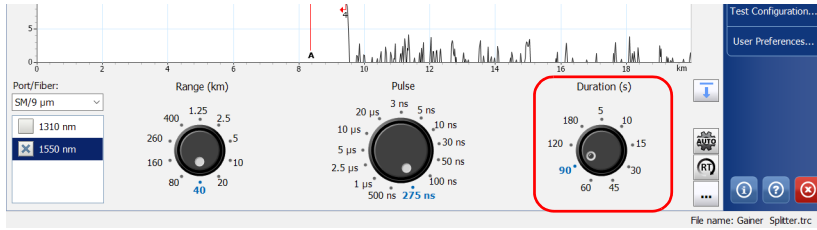

DWDM and CWDM OTDR

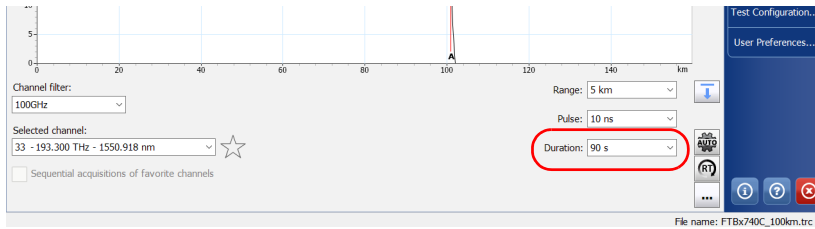

You can customize the acquisition time to improve the signal-to-noise ratio (SNR) of the trace and enhance the detection of low-level events. The SNR improves by a factor of two (or 3 dB) each time the acquisition time is increased by a factor of four.

To customize the acquisition time values:

1. From the main window, select the **OTDR** tab then tap the  button.
2. Under **Custom Parameters**, from the **Duration** list, select the value you want to modify.
3. When the value becomes highlighted, enter the new value.

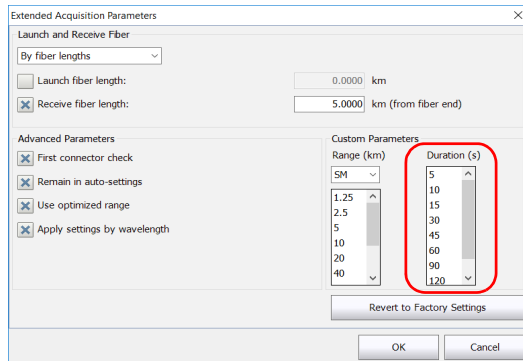

4. Tap **OK** to return to the main window.

Note: You can revert to factory values by pressing the **Revert to Factory Settings** button.

Selecting a Trace Display Mode

You can choose the way the application will display traces on-screen and in reports. The available choices are:

- **Complete trace:** to display the whole trace and full acquisition distance.
- **Span:** to display the trace from the span start to the span end.

To select a trace display mode:

1. From the **Main Menu**, tap the **User Preferences** button.
2. Select the **Graph** tab.
3. From the **Trace display mode** list, select a display mode.

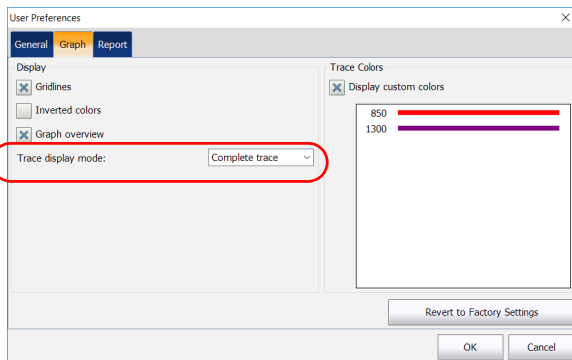

4. Tap **OK** to return to the main window.

Customizing Trace Colors

Note: This feature is not available if you are working with a MAX/FTBx-740C-DWx module.

By default, the application displays traces in black or grey (see *Selecting the Displayed Wavelength* on page 136 for details). When you enable the trace colors feature, the application uses specific colors for each wavelength your module supports but you can modify the trace colors to better suit your needs. The colors are kept in memory when you close the application. However, reverting to factory settings restores custom trace colors to the default colors assigned by the application.

The wavelengths that are not part of the list of predefined wavelengths are displayed in black.

To customize trace colors:

1. From the **Main Menu**, tap the **User Preferences** button.
2. Select the **Graph** tab.
3. To use the trace colors feature, select the **Display custom colors** check box.

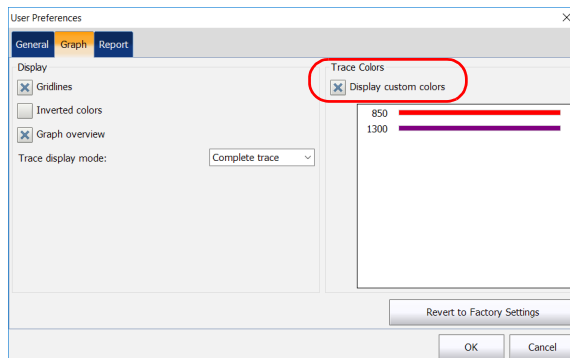

Customizing Your OTDR

Selecting the Default View

4. To customize trace colors, proceed as follows:
 - 4a. Tap on the wavelength to modify its color manually.
 - 4b. In the **Color** window, make your selection.
 - 4c. Tap **OK** to exit the **Color** window.
5. Tap **OK** to return to the main window.

The changes are applied automatically.

Selecting the Default View

You can select which view will be displayed by default once all the acquisitions are performed (at all the selected wavelengths) and the analysis of the last wavelength is complete. The default view will also be used when opening a measurement file.

The table below indicates the views that can be displayed.

View	Remarks
Keep current	The tab selected before the acquisition is started remains the same once the acquisition is complete.
OTDR	Displays the graph and the controls for the OTDR acquisitions. Depending on the module used (standard or DWDM and CWDM OTDR), and if the graph is in full view or not, the appearance of this view may be slightly different. See <i>Graph</i> on page 118 for details.
Events	Default view. Displays the results in the Events tab after an acquisition. See <i>Events Tab</i> on page 123 for details.

View	Remarks
Measure	Displays the results in the Measure tab after an acquisition. This view allows you to take measurement with markers manually. See <i>Measure Tab</i> on page 129 for details.
Summary	This tab gives, for each wavelength, information such as: the pass/fail status of the results, the span loss and span ORL values. Span length is also displayed. See <i>Summary Tab</i> on page 119 for details.

To select the default view:

1. From the **Main Menu**, tap the **User Preferences** button.
2. Select the **General** tab.
3. From the **Default view** list, select the desired view.

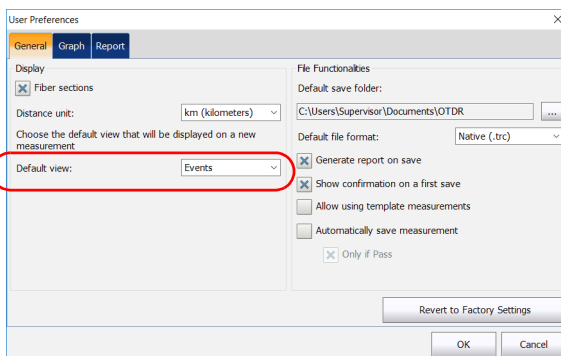

4. Tap **OK** to return to the main window.

The application will automatically switch to the selected view when you perform the next acquisitions or open already existing files.

Setting the Default Storage Folder

The default storage folder is Data\My Documents\OTDR but you can change the folder to better suit your needs. You can also work with a USB key. If the USB key is not connected to the device upon saving, the acquisitions are saved in the default storage folder.

Note: *The **Save As** button allows you to save your files to a folder different than the default storage folder. If you change the storage folder from the **Save As** dialog box, it will be used the next time you use the **Save As** feature again. The default storage folder will not be modified.*

To set the default storage folder:

1. From the **Main Menu**, tap the **User Preferences** button, then select the **General** tab.
2. Under **File Functionalities**, tap the  button next to **Default save folder**.

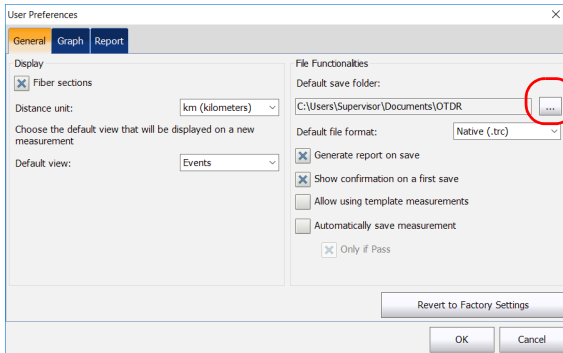

3. In the **Browse For Folder** window, select the location where you want to save the file.
4. Tap **OK** to exit the **Browse For Folder** window.
5. Tap **OK** to return to the main window.

Selecting the Default File Format

You can define the default file format the application will use when you save your traces.

By default, traces are saved in native (.trc) format, but you can configure your unit to save them in Bellcore (.sor) format.

If you select the Bellcore (.sor) format, the unit will create one file per wavelength (for example, TRACE001_1310.sor and TRACE001_1550.sor, if you included both 1310 nm and 1550 nm in your test). The native format contains all wavelengths in a single file.

Note: *If you selected the feature to be prompted each time you save a measurement, you can also modify the file format temporarily. Next time you save a measurement, the default file format will be used.*

Note: *The **Save As** button allows you to save your files to a folder different from that of the default file format. If you change the file format from the **Save As** dialog box, it will be used the next time you use the Save As feature again. The default file format will not be modified.*

Customizing Your OTDR

Selecting the Default File Format

To select the default file format:

1. From the **Main Menu**, tap the **User Preferences** button.
2. Select the **General** tab.
3. From the **Default file format** list, select the type of file.

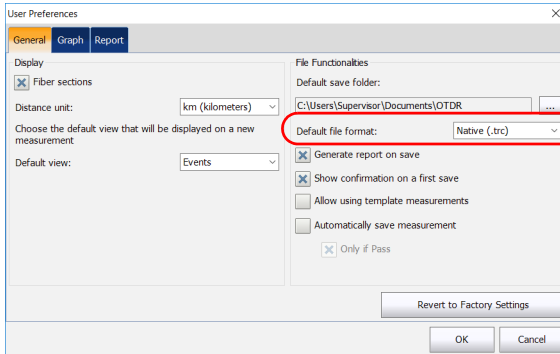

4. Tap **OK** to return to the main window.

The next files will be saved in the new format.

Enabling or Disabling File Name Confirmation

By default, each time you save a file, the application saves it without asking for a file name or a folder and uses a file name based on autonaming settings. See *Naming Trace Files Automatically* on page 26 and *Setting the Default Storage Folder* on page 112 for details.

If the option is activated, a new name will be automatically generated and you will be able to confirm this file name, the folder or file type each time you save a new trace. The application will not prompt you for a confirmation as long as you do not close the current trace.

To enable or disable file name confirmation:

1. From the **Main Menu**, tap the **User Preferences** button.
2. Select the **General** tab.
3. If you want to confirm the file name, folder, or file type, select the **Show confirmation on a first save** check box.

OR

If you never want to be prompted, clear the check box.

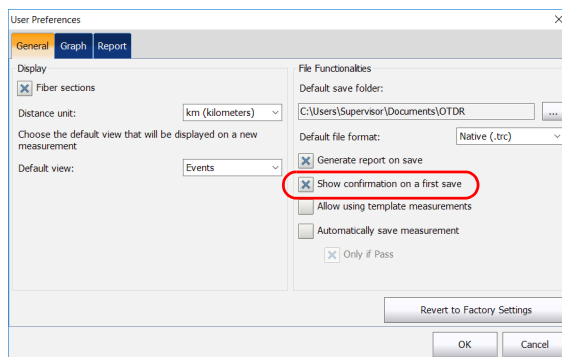

4. Tap **OK** to return to the main window.
The changes are applied automatically.

Customizing Your OTDR

Enabling or Disabling the Automatic Storage of the Files

Enabling or Disabling the Automatic Storage of the Files

By default, the application does not save the measurements automatically after an analysis. However, you can configure it to save the measurements automatically. You can also specify if you prefer to store all the measurements regardless of the results, or only when the results have a pass status.

To enable or disable the automatic storage of the files:

1. From the **Main Menu**, tap the **User Preferences** button.
2. Select the **General** tab.
3. Select whether you want the measurements to be stored automatically regardless of the results, or only when the results have a pass status.

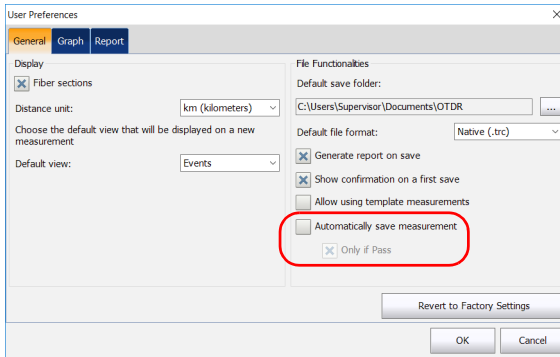

Note: *If the measurement was not automatically stored and you want to keep it, you will have to store it manually.*

4. Tap **OK** to return to the main window.
The changes are applied automatically.

8 **Analyzing Traces and Events**

Once the acquired trace is analyzed, it appears in the trace display and the events are displayed in the table of events at the bottom of the screen. The trace display and the table of events are explained in the following sections. You can also reanalyze existing traces. For information on the various file formats you can open with the application, see *Opening Measurement Files* on page 165.

There are several ways to view the results:

- Graph view
- Summary table
- Events table
- Measure table
- Linear view

In addition, you can generate trace reports directly from your unit. See *Generating a Report* on page 181 for details.

Analyzing Traces and Events

Graph

Graph

The events, that are detailed in the table of events (see *Events Tab* on page 123 for details), are marked by numbers along the displayed trace.

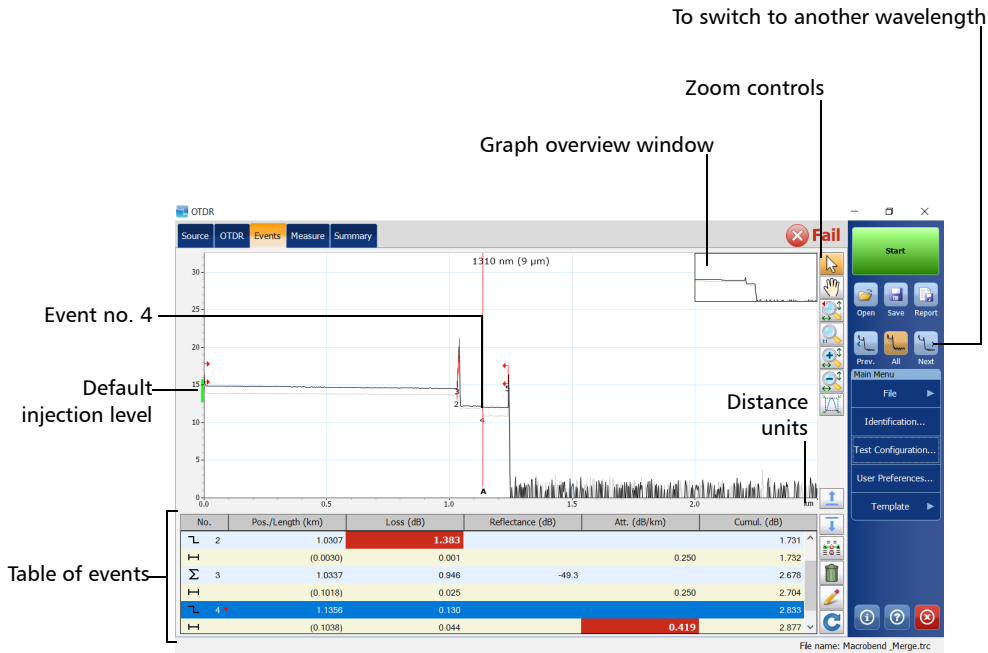

Some items in the trace display are always visible, while others will appear only if you choose to display them.

The green rectangle on the Y axis (relative powers) indicates the proper injection level range for the defined test pulse.

Note: *For multimode measurement, the location of the injection level depends on the type of fiber that you select.*

You can change trace display parameters (such as the grid). See *Setting Event Table and Graph Display Parameters* on page 99 for details.

You can view all of the traces, in turn, in the trace display with the navigation buttons. See *Selecting the Displayed Wavelength* on page 136 for details.

Summary Tab

For each wavelength, the **Summary** tab gives the span loss, the span ORL values, and the global status of the results:

- pass: no results exceed the thresholds
- fail: at least one result exceeds the thresholds
- unknown: no threshold is configured or a span value (length, loss, ORL) is not available

The span length (distance between span start and span end) is also displayed, except if a continuous fiber is detected for all wavelengths.

The live fiber power value displayed in the **Summary** tab corresponds to the residual light coming from the network under test through the external and internal OTDR filters that hit the OTDR detector. This affects the performance of the module in terms of dynamic range. Your OTDR can still perform measurements at power levels above -40 dBm.

Analyzing Traces and Events

Summary Tab

You must remember however that when using short pulses, the impact on the dynamic range is moderate, whereas it will be significant in the case of long pulses. There are noticeable effects on the dynamic range of long pulses at a level as low as -70 dBm.

Depending on the modules and ports you are using, you should consider the information below:

- SM Live ports are designed for out-of-band testing and are built with bandpass filters that reject incoming light from the network. The filter properties, such as width and rejection, depend on the OTDR model you have selected. A high live fiber power value can mean two things:
 - The bandpass filters are not adequate. To decrease the live fiber power value, you can add an external filter. Remember however that when using this method, you must consider the nominal wavelength tolerances of the laser.
 - Too much noise is coming through the network in the optical spectral band of the OTDR. Therefore, the noise cannot be rejected by internal bandpass filters. This noise may come from the laser sidebands, the amplifiers or it can be the result of the Raman effect.
- Singlemode and multimode ports are not built with filters that reject incoming light from the fiber under test. No transmitter should transmit at the distal end.
- With CWDM and DWDM modules, if a high live fiber power value prevents an adequate measurement of a link, you can add in-line channel filters to the OTDR. The live fiber power value should decrease because the light comes from adjacent channels.

Standard OTDR

DWDW and CWDM OTDR

To navigate between wavelengths

Parameter	Value
Information	1310 nm (9 µm)
Pass/fail status	Fail
Span length	1.2394 km
Span loss	2.877 dB
Span ORL	39.19 dB
Injection level	14.9 dB
Range	2.5000 km
Pulse	10 ns
Duration	46 s
Date	5/30/2013
Time	6:45:04 AM
Average loss	2.321 dB/km
Average splice loss	0.756 dB
Maximum splice loss	1.383 dB
Macrobend Postion	Macrobend C
	1.1356 km, 0.890 dB

Parameter	Value
Information	34 - 193.400 THz - 1550.116 nm (9 µm)
Pass/fail status	Fail
Span length	100.9126 km
Span loss	19.588 dB
Span ORL	31.48 dB
Injection level	31.5 dB
Range	160.0000 km
Pulse	1 µs
Duration	30 s
Date	2/16/2016
Time	12:10:40 PM
Average loss	0.194 dB/km
Average splice loss	---
Maximum splice loss	---
Live power value	< -60.6 dBm

- In the **Summary** tab, when you tap the pass/fail status row with a fail status, the application automatically switches to the **Events** tab. The graph is displayed with “full trace” zoom. If the zoom on event feature is enabled, the application zooms in on the first event or fiber section for which the status is “fail”.
- Traces must have been analyzed before you can see them in the **Summary** tab. Real-time traces cannot be analyzed. The summary is always displayed but may be incomplete.

Analyzing Traces and Events

Summary Tab

- If you configure the application to show the macrobends (**Test Configuration > Link Definition** tab), the information will appear at the bottom of the **Summary** tab. See *Setting Macroband Parameters* on page 45 for details.

Note: *This feature is not available if you are working with a MAX/FTBx-740C-DWx module.*

- If no macrobends were detected, the application displays “No macroband detected” instead of the information on the macrobends. “Invalid parameters” is displayed when the parameters are inappropriate.

To display the Summary tab:

From the main window, tap the **Summary** tab.

Note: *To display the **Summary** tab as the default view after the acquisitions are all performed (at all the selected wavelengths) and the analysis of the last wavelength is complete, see *Selecting the Default View on page 110* for details.*

Events Tab

You can view information about all detected events on a trace and fiber sections by scrolling through the table of events. When the graph is visible, when you select an event in the table of events, marker **A** appears on the trace over the selected event. When the selected event is a fiber section, this fiber section is delimited by two markers (**A** and **B**). For more information on markers, see *Using Markers* on page 167.

These markers pinpoint an event or a fiber section, depending on what is selected in the table of events. You can move markers directly by selecting an element in the table of events or on the graph.

The table of events lists all the events detected on the fiber. An event can be defined as the point at which change in the transmission properties of light can be measured. Events can consist of losses due to transmission, splices, connectors or breaks. If the event is not within the established thresholds, its status will be set to “fail”.

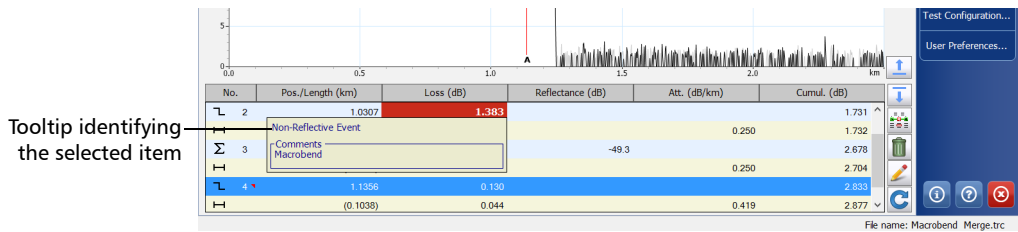

A red triangle appears next to the event number to indicate that a comment has been inserted manually for a specific event.

If you tap and hold the row corresponding to a specific event or fiber section for a few seconds, the application will display a tooltip identifying the item (for example, Non-reflective fault). In the case of a merged event, you will also see details about the “sub-events”.

The tooltip displays any comment that you have inserted manually.

Analyzing Traces and Events

Events Tab

If an asterisk appears next to the event symbol, the tooltip will also show “(*:Modified)” to indicate that this event has been modified manually. If the asterisk appears next to the event number, “(*:Added)” will appear to indicate that this event has been inserted manually. See *Modifying Events* on page 146 for details.

For each item listed in the table of events, information is displayed:

- **No.:** Event number (a sequential number assigned by the OTDR test application) or, in parentheses, the length of a fiber section (the distance between two events).
Various symbols are also used to describe different event types. For a more detailed description of symbols, see *Description of Event Types* on page 205.
- **Pos./Length:** Distance between the OTDR and the measured event or between the event and the beginning of the fiber span.
- **Loss:** Loss in dB for each event or fiber section (calculated by the application).
- **Reflectance:** Reflectance measured at each reflective event along the fiber.
- **Att.:** Attenuation (loss/distance) measured for each fiber section. The **Att.** column is only visible when the fiber sections are displayed. See *Displaying or Hiding Fiber Sections on a Trace* on page 101 for details.

Note: *The attenuation value is always presented in dB per kilometers, even if the distance units you selected are not the kilometers. This follows the standards of the fiber-optic industry that provides the attenuation values in dB per kilometers.*

- **Cumul.:** Cumulative loss from the trace span start to span end; the running total is provided at the end of each event and fiber section.

Cumulative loss is calculated for the events displayed in the table of events, excluding those that are hidden.

If you want to modify events or fiber sections, see *Modifying Events* on page 146 and *Inserting Events* on page 149 for details.

To quickly locate an event:

1. From the main window, go to the **Events** tab.
2. Ensure that the  button is selected in the zoom button bar.
3. Select the event on the trace.

The list scrolls automatically to the event you selected.

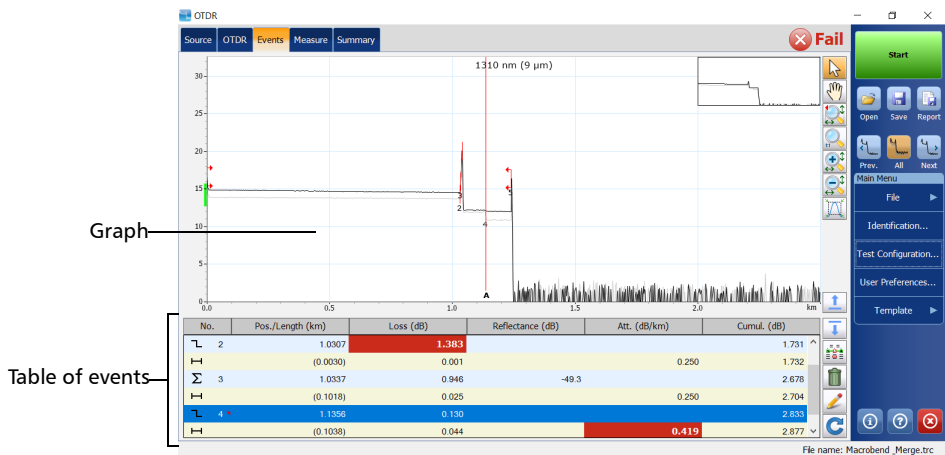

Analyzing Traces and Events



Linear View

Linear View

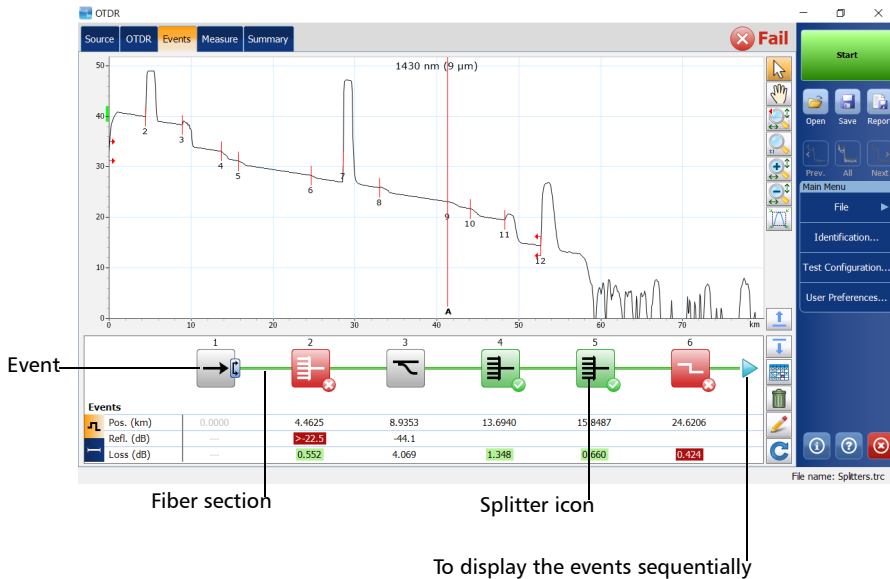
In the linear view, the events are displayed sequentially, from left to right. You can scroll the linear view with your finger.



- Each rounded square represents an event.
- Each horizontal line that “links” two rounded squares represents a fiber section.
- Rounded squares and lines will be displayed in colors: green for pass (✓), red for fail (✗), gray for events and fiber sections appearing outside the current fiber span. Sections and events are also displayed in gray when they are not tested by the pass/fail thresholds.

- Spans ( and ) and macrobends () icons are displayed on the rounded square. When macrobends are detected, icons will be displayed to identify them. Colors of the rounded squares correspond to the status of the events (green for pass, red for fail) and do not change if macrobends are detected.

Note: *The macrobends are not available if you are working with a MAX/FTBx-740C-DWx module.*

- When you select an event or a fiber section in the table of events or in the graph, the linear view automatically scrolls to display the element.
- You can also select a rounded square or an horizontal line and the corresponding item will be selected in the table of events or in the graph.
- The linear view always displays the current trace.
- A red triangle appears next to the event number to indicate that a comment has been inserted manually. See *Events Tab* on page 123 for details.
- The linear view cannot be displayed when the table of events is empty. Traces must have been analyzed before you can see them in the linear view.

Analyzing Traces and Events

Linear View

- The standard mode allows you to view, at the same time, the graph in the upper part of the main window, as well as the events and fiber sections information in the lower part of the main window.

To switch between Events and Fiber Sections

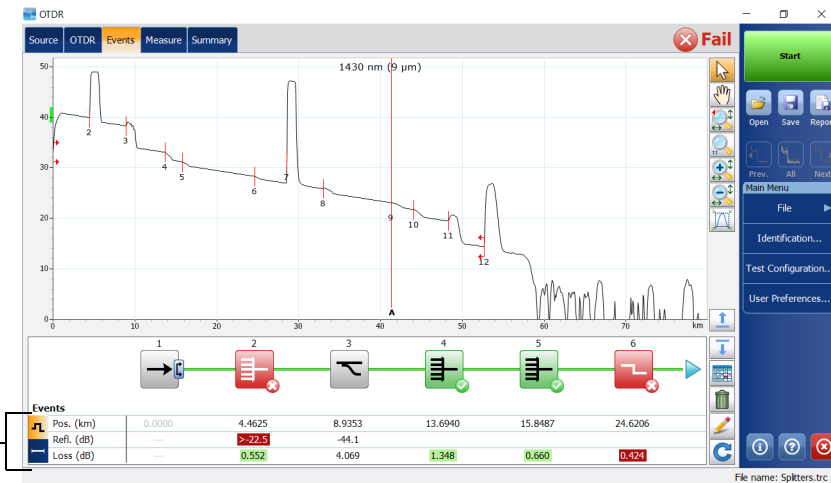

To display the linear view:

1. From the main window, go to the **Events** tab.
2. Tap  to go to the linear view.

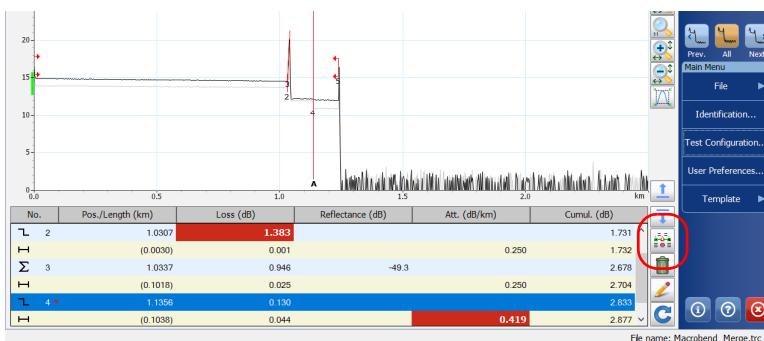

Measure Tab

The application shows two, three or four markers: **a**, **A**, **B**, and **b**, depending on your selection.

These markers can be repositioned along the trace to calculate loss, attenuation, reflectance, and optical return loss (ORL).

You can reposition all markers by using the controls as needed. You can drag them directly from the trace display. You can also move the markers using the left/right arrows.

For more information on how to perform manual measurements, see *Analyzing the Results Manually* on page 167.

To display the Measure tab:

From the main window, tap the **Measure** tab.

Note: *To display the Measure tab as the default view after the acquisitions are all performed (at all the selected wavelengths) and the analysis of the last wavelength is complete, see Selecting the Default View on page 110 for details.*

Switching Between Full-Screen, Condensed, and Split Views

You can change the way the information is displayed by navigating between the available display modes:

- **Default:** in the **Events** tab, corresponds to a view with the graph and the table of events
- **Condensed:** shows the graph and only one row of the table of events visible at a time (available only from the **Events** tab)
- **Full-screen:** in the **Events** tab, only the table of events is visible

You can display the graph in full screen at any time, even when an acquisition is underway. The graph will keep the same display options as in normal view (grid, file name, inverted colors).

You can start acquisitions directly without having to go back to normal view first. During real-time mode acquisition, you can switch from one wavelength to another.

As soon as a trace is displayed (new acquisition or existing file), zoom controls are available (see *Using Zoom Controls* on page 132 for details).

Once all acquisitions are complete, the application will automatically switch to the defined default view. If you prefer that the graph remains displayed after the acquisitions are complete, ensure that the default view is set to **OTDR**. See *Selecting the Default View* on page 110 for details.

Analyzing Traces and Events

Switching Between Full-Screen, Condensed, and Split Views

To switch between the available views:

Use the up and down arrows to navigate between the views.

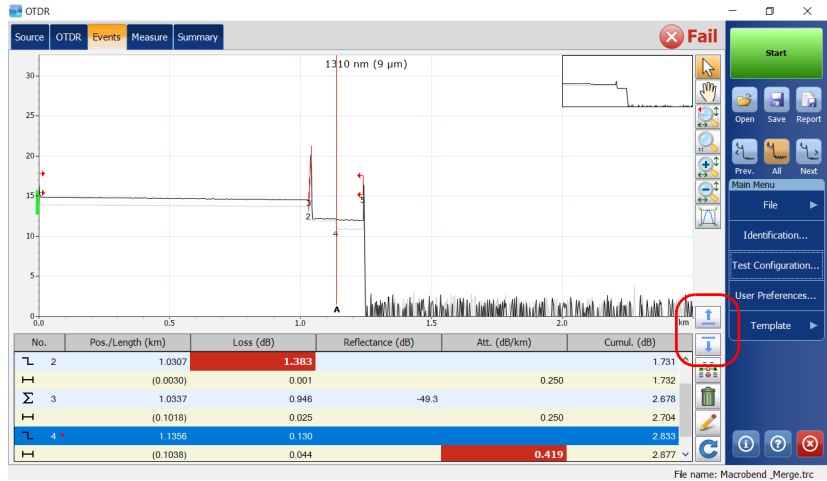

Using Zoom Controls

Use the zoom controls to change the scale of the trace display.

You can zoom in on or out of the graph using the corresponding buttons or let the application automatically adjust the zoom on the currently selected event from the table of events (table only available when the events window is displayed).

You can quickly zoom in on or out of the selected event.

You can also return to the original graph value.

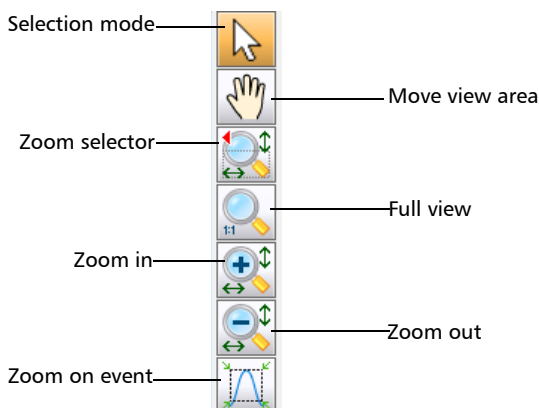

You cannot move the markers with the  button.

- When you manually zoom in or out on a trace, the application will apply the new zoom factor and marker positions to the other traces (wavelengths) of a same file. Both the zoom factor and marker positions will be saved along with the trace (same settings for all wavelengths).
- When you zoom in or out on the selected event, the application keeps the zoom on this event until you select another event or change zoom. You can select a different event for each wavelength (for example, event 2 at 1310 nm and event 5 at 1550 nm). The selected events will be saved along with the trace.

To view specific portions of the graph:

- You can define which portion of the graph will be visible by selecting the  button and dragging the graph with the stylus or your finger.



This could be useful, for example, if you want to zoom in on events located outside the defined fiber span.

- The  button is the zoom selector. It allows you to select whether the zooming will be performed according to the horizontal axis, the vertical axis, or both.

Tap and hold this button to select the zooming direction in the menu.



Then, define the zoom area with the stylus or your finger (a rectangle with dotted lines will appear to help you define the area). Once you release the stylus, the application automatically zooms in on the graph according to the zooming type you have selected. All of the other zoom buttons (except for the zoom on selected event button) will reflect your selection and behave accordingly.

- You can zoom in or out on the graph by first using, respectively, the  or the  button, and then by tapping the location where you want to zoom on the graph with the stylus or your finger. The application automatically adjusts the zoom by a factor 2 around the point that was tapped.

Analyzing Traces and Events

Using Zoom Controls

To revert to the complete graph view:

Tap the  button or double-tap the graph overview window when it is displayed.

To automatically zoom in on the selected event:

1. Select the desired event:
 - From the **OTDR** tab: place marker A on the event
 - From the **Events** tab: select the item from the table of events
 - From the **Measure** tab: go to the **Events** tab to select the item from the table of events, and then go back to the **Measure** tab.
2. Tap the  button to zoom in.

Viewing Span Start and Span End in the Table of Events

When applicable, the application will include the losses caused by the span start and span end events to the span ORL and span loss values. See *Excluding and Including Span Start and Span End* on page 37 for details.

If you activate the pass/fail test (see *Setting Pass/Fail Thresholds* on page 49 for details), span-start and span-end events will be taken into account when determining the status (pass/fail) of splice and connector loss and reflectance.

To view span start and span end in table of events:

1. From the **Main Menu**, tap the **Test Configuration** button.
2. Select the **Link Definition** tab.
3. Under **Calculation and Pass/Fail Thresholds**, select the boxes corresponding to the item you want to display or include in the table.

OR

To hide them, clear the boxes.

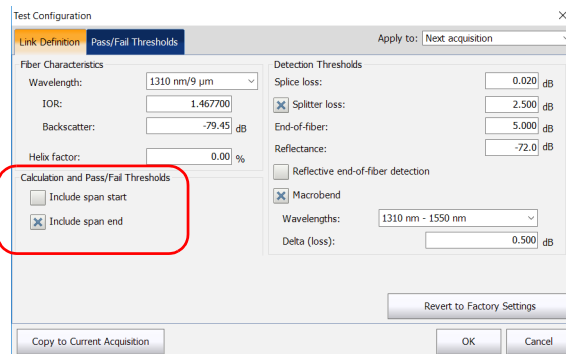

4. Tap **OK** to return to the main window.

Selecting the Displayed Wavelength



You can switch from one wavelength to another. You can view all the trace files you have opened. When working in template mode, this includes the current and reference traces.

The table below shows the possible colors of the traces.

Current Trace	Reference Trace (Template mode only)
Black when the trace is selected.	
Light grey when the trace is not selected.	The reference trace is golden.

You can also hide traces and display the current trace only.

To display traces in turn:

Tap  or  to switch between the available traces.

To display only the current wavelength or all wavelengths:

Tap  to switch between a single-wavelength view and a multiple-wavelength view.

Note: In the **Events** and **Summary** tabs, the information displayed will behave accordingly.

Note: Hiding a trace has no impact on the pass/fail status or the result values.

Working With Template Traces

When you set a trace as a template, the application uses this trace as a reference to create all the traces that will be acquired during a given work session. This ensures that the acquired traces have exactly the same number of events, located at the same positions, as those of the reference trace.

By default, the option allowing you to work with template traces is deactivated. You must activate the option before setting your reference measurement (newly acquired and saved trace, or open trace file).

When this reference measurement contains more than one wavelength, the wavelength of the current trace is set as the reference trace. Your module, whether it is singlemode or multimode, must support the wavelength used to set the reference trace.

If you are working with the QUAD option, the application automatically selects the OTDR port (singlemode or multimode) corresponding to the wavelength of the reference trace.

By default, the application tries to match the distance range, the pulse width and the acquisition time values with those defined in the reference trace if the module allows it. If these values are not available on your module, the application selects the available values nearest to those of the reference trace.

As soon as you close the reference trace, it is removed from the memory of the application.

Note: *You cannot edit or reanalyze a reference trace.*

Analyzing Traces and Events

Working With Template Traces

To allow template measurements:

1. From the **Main Menu**, tap the **User Preferences** button.
2. Select the **General** tab.
3. Under **File Functionalities**, select the **Allow using template measurements** box.

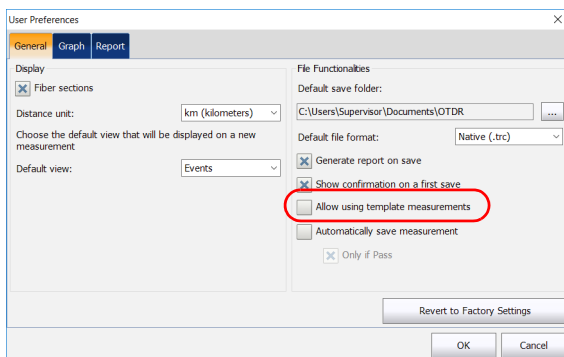

4. Tap **OK** to return to the main window.

You can now work with template traces.

To set the current trace as a reference:

1. If the trace you want to work with is already opened, go directly to step 3.

OR

To open a measurement file, proceed as follows:

- 1a. From the main window, tap .

OR

From the **Main Menu**, go to **File** then tap **Open**.

- 1b. In the list, select the file that you want to use as a reference trace.

- 1c. Tap **Open** to confirm.

2. Ensure that the selected wavelength corresponds to the one you want to set as template.

3. From the **Main Menu**, tap the **Template** button.



Analyzing Traces and Events

Working With Template Traces

4. Tap the **Set as Template** button.



You will automatically return to the main window.

To close a reference measurement in memory:

1. From the **Main Menu**, tap the **Template** button.
2. Tap **Close Template**.

Viewing and Modifying Current Measurement Settings

You can view the trace settings and modify them at your convenience.

Two groups of settings can be changed:

- Fiber settings: index of refraction (IOR), also known as group index, Rayleigh backscatter (RBS) coefficient, and helix factor.

Note: *If you are working with the DWDM OTDR, the application uses the IOR and backscatter values of the 1550 nm wavelength (nominal wavelength of the C-band).*

- Detection thresholds: for splice loss, reflectance, and end-of-fiber detection.

Note: *If you are working with a MAX/FTBx-740C module, the end-of-fiber threshold value is set to 15 dB by default.*

Modifications you make are only applied to the current trace (that is, to a particular wavelength), not to all traces.

The application will only prompt you to reanalyze the trace if you modify the RBS coefficient (no analysis necessary when you modify the IOR or helix factor). If you want to modify the settings that will be used for future acquisitions, see *Setting the IOR, RBS Coefficient, and Helix Factor* on page 32 and *Setting the Analysis Detection Thresholds* on page 39 for details.

Analyzing Traces and Events

Viewing and Modifying Current Measurement Settings

When viewing or modifying trace settings, these parameters are displayed:

- *Wavelength*: Test wavelength.
- *IOR*: Refraction index of the displayed trace, also known as group index. If you modify this parameter, the distance measurements for the trace will be adjusted. You can enter an IOR value directly, or let the application calculate it with the distance between span start and span end you provide. The IOR value is displayed with six digits after the decimal point.
- *Backscatter*: Rayleigh backscatter coefficient setting of the displayed trace. If you modify this parameter, the reflectance and ORL measurements for the trace will be adjusted.
- *Helix factor*: Helix for the displayed trace. If you modify this parameter, the trace distance measurements will be adjusted.

Note: *You cannot define a different helix factor for each wavelength. This value takes into account the difference between the length of the cable and the length of the fiber inside the cable; it does not vary with wavelengths.*

Note: *If you are working with the DWDM OTDR, the application uses the IOR and backscatter values of the 1550 nm wavelength (nominal wavelength of the C-band).*

- Detection thresholds:
 - *Splice loss*: Current setting for detecting small non-reflective events during trace analysis.
 - *Reflectance*: Current setting for detecting small reflective events during trace analysis.
 - *End-of-fiber*: Current setting for detecting important event loss that could compromise signal transmission during trace analysis.

See *Setting the Analysis Detection Thresholds* on page 39 for details.

To view or modify measurement settings:

1. From the **Main Menu**, tap **Test Configuration**.
2. From the **Apply to** list, select **Current acquisition**.

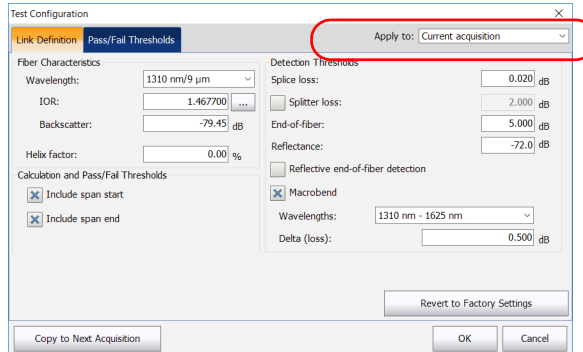

3. From the **Test Configuration** window, go to the **Link Definition** tab.
4. Under **Fiber Characteristics**, from the wavelength list, select the desired wavelength.

Note: If you are working with a MAX/FTBx-740C-DWx module, the application uses the nominal wavelength of the C-band, which is 1550 nm.

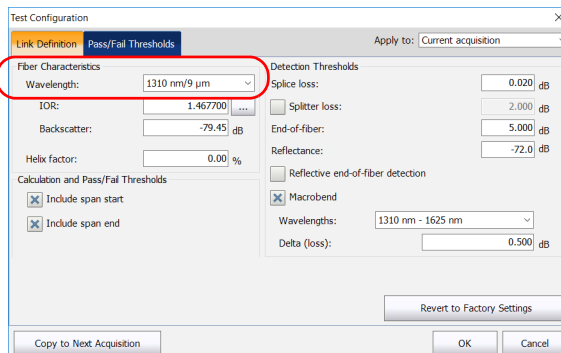

Analyzing Traces and Events

Viewing and Modifying Current Measurement Settings

5. If you want to modify the parameters, enter the desired values for the current trace in the appropriate boxes.

OR

If you want to revert all settings to their default values, tap the **Revert to Factory Settings** button.

The screenshot shows the 'Test Configuration' dialog box with the 'Pass/Fail Thresholds' tab selected. The 'Apply to:' dropdown is set to 'Current acquisition'. The 'Fiber Characteristics' section includes 'Wavelength' (1310 nm/9 μm), 'IOR' (1.467700), 'Backscatter' (-79.45 dB), and 'Helix factor' (0.00 %). The 'Detection Thresholds' section includes 'Splice loss' (0.020 dB), 'Splitter loss' (2.000 dB), 'End-of-fiber' (5.000 dB), and 'Reflectance' (-72.0 dB). There are also checkboxes for 'Include span start', 'Include span end', 'Reflective end-of-fiber detection', and 'Macrobend'. A 'Revert to Factory Settings' button is located at the bottom right of the dialog.

Note: The modifications you make will only be applied to the selected wavelength, except for the detection thresholds.

Note: You cannot define a different helix factor for each wavelength. This value takes into account the difference between the length of the cable and the length of the fiber inside the cable; it does not vary with wavelengths.

- Unless you are absolutely sure of the different parameter values, revert to default values to avoid fiber setting mismatches.
- If you already know the IOR value, you can enter it in the corresponding box. However, if you prefer to let the application calculate the IOR value as a function of the known distance between span start and span end, tap the **...** button next to **IOR**, then enter the distance value.

Note: The **...** button is not available if you are working with a DWDM or a CWDM OTDR module.

- If you want to save the modified IOR, RBS, and helix factor values for the next acquisitions performed at the current wavelength, proceed as follows:

- Tap the **Copy to Next Acquisition** button.

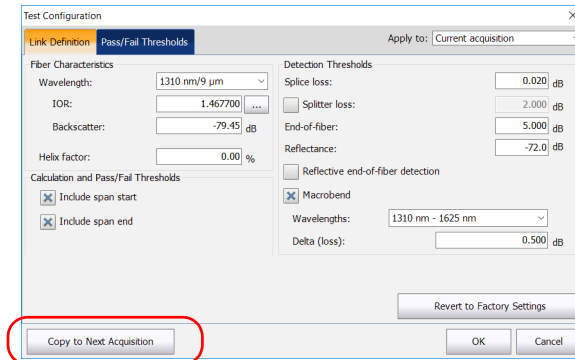

- When the application prompts you, select **Yes**.

Note: The information in the **Link Definition** and **Pass/Fail Thresholds** tabs will be copied to the current acquisition.

- Tap **OK** to apply the changes.
You return to the main window.

Modifying Events

You can change the loss and reflectance of almost any existing event except:

- continuous fiber
- end of analysis
- launch level
- merged events
- span start
- span end



IMPORTANT

If you reanalyze a trace, all of the modified events will be lost and the table of events will be re-created.

To modify an event:

1. Select the event you want to modify.
2. In the **Events** tab, tap .

Markers **a**, **A**, **B**, and **b** appear on the graph. With these markers, you can define a new location for the selected event.

You can reposition all markers directly by dragging them, or by tapping where you want to relocate them on the graph.

Note: *The current marker locations are set, during the analysis, to calculate and display the original event loss and reflectance.*

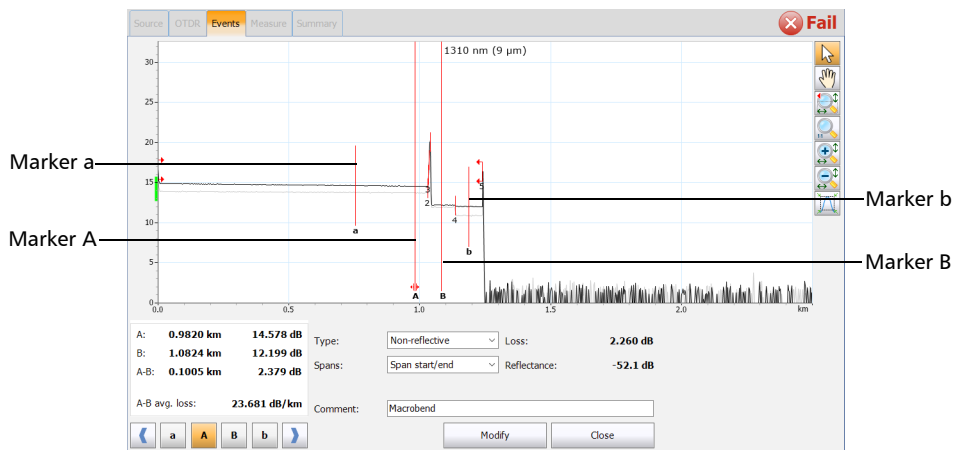

3. Position marker **A** on the event, and submarker **a** (to the left of marker **A**) as far as possible from marker **A**, without including the preceding event.

The area between markers **A** and **a** must not include any significant variation. For more information on positioning markers, see *Using Markers* on page 167.

Analyzing Traces and Events

Modifying Events

4. Position marker **B** after the end of the event, where the trace returns to a regular loss inside the fiber, and submarker **b** (to the right of marker **B**), as far as possible from marker **B**, without including the following event.

The area between markers **B** and **b** must not include any significant variation. For more information on positioning markers, see *Using Markers* on page 167.



Event loss and reflectance are displayed, respectively, in the **Loss** and **Reflectance** boxes.

A: 0.9820 km	14.578 dB	Type: Non-reflective	Loss: 2.260 dB
B: 1.0824 km	12.199 dB	Spans: Span start/end	Reflectance: -52.1 dB
A-B: 0.1005 km	2.379 dB	Comment: Macrobend	
A-B avg. loss: 23.681 dB/km			

Buttons: a, A, B, b, Modify, Close

5. Tap **Modify** to accept the modifications you have made or **Close** to return to the table of events without saving the changes.

The modified events are identified with “*” (appearing beside the event symbol) in the table of events as shown below.

No.	Pos./Length (km)	Loss (dB)	Reflectance (dB)	Att. (dB/km)	Cumul. (dB)
1	0.0000	0.196	-50.0	0.196	0.196
1*	(1.0334)	0.344		0.333	0.540
2	1.0334	0.184		0.724	0.724
	(0.0637)	0.030		0.469	
	1.0334	0.184			

File name: Launch and Receive Fibers.trc

Inserting Events

There are two ways to insert new events manually:

- The most straightforward method is to use only one marker. You can insert new event at the position where marker A is positioned.
- If you want to have more control over the place where you want to insert events you can choose to work with all four markers.

This could be useful, for example, if you know that there is a splice at a given location, but the analysis does not detect it because it is hidden in the noise or because the splice loss is lower than the minimum detection threshold (see *Setting Pass/Fail Thresholds* on page 49 for details).

You can select the event type you want to insert on a trace. By default, the event type is set to **Auto. detected**. This means that the application automatically sets the most appropriate event type according to the position of the markers.

You can add an event to the table of events manually. This will add a number on the trace at the location of the insertion, but it will *not* modify the trace.

Note: *Inserting an event between A and B when there is already one event implies that the application merges both events located between A and B. Once two events are merged, it becomes impossible to delete only one of them since the application treats them as one.*



IMPORTANT

Inserted events are removed when you reanalyze a trace.

Analyzing Traces and Events

Inserting Events

To insert events with one marker:

1. From the **Measure** tab, tap .
2. Using marker A, select the location where you want to insert an event.

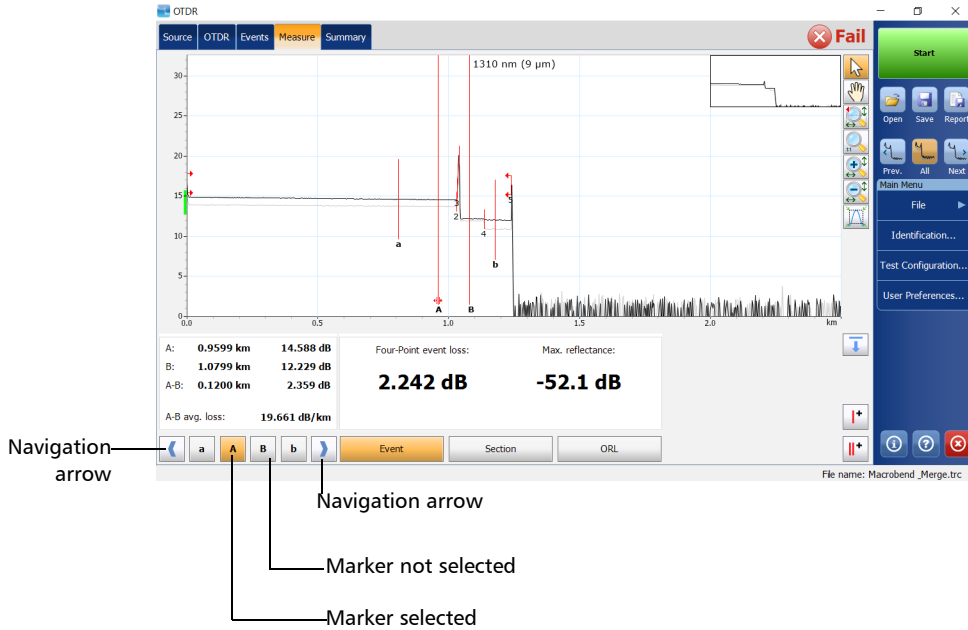

3. Once you have determined the location, from the **Type** list, select the desired event type.

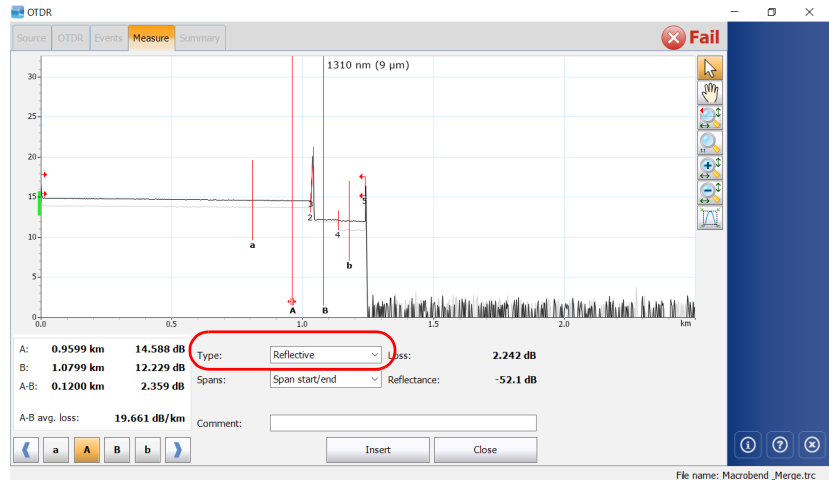

4. From the **Spans** list, select the desired span type.
5. If necessary, enter a comment in the box.
6. Tap **Insert** to insert the event on the trace.
7. Repeat steps 2 to 6 for each new event you want to insert.
8. Tap **Close** to return to the **Measure** tab.

Inserted events are marked with asterisks (appearing beside the event number).

Analyzing Traces and Events

Inserting Events

To insert events with all four markers:

1. From the **Measure** tab, tap .
2. Select the location where you want to insert an event.

Four markers are available to measure the inserted event, but Marker **A** identifies where the event will be inserted. Use the marker arrows to move markers **A** and **B** on the trace display.

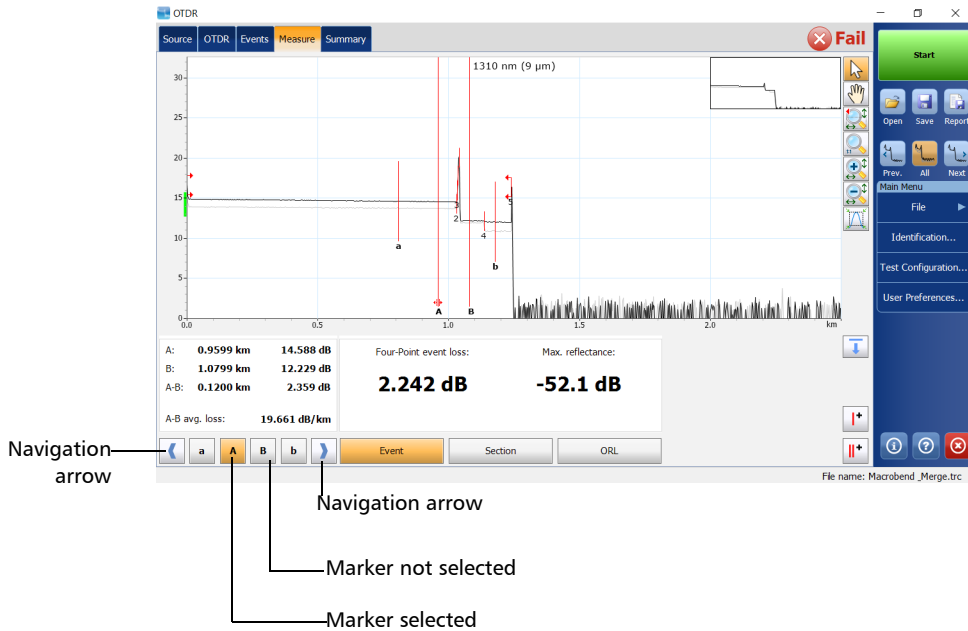

3. Once you have determined the location, from the **Type** list, select the desired event type.

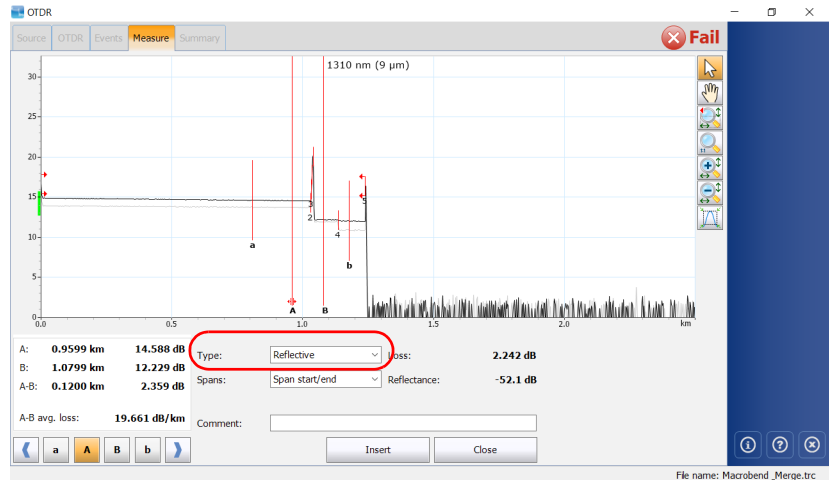

4. From the **Spans** list, select the desired span type.
5. If necessary, enter a comment in the box.
6. Tap **Insert** to insert the event on the trace.
7. Repeat steps 2 to 6 for each new event you want to insert.
8. Tap **Close** to return to the **Measure** tab.

Inserted events are marked with asterisks (appearing beside the event number).

Deleting Events

Almost any event can be deleted from the table of events, except:

- end of analysis
- fiber section
- launch level
- end of fiber
- span start
- span end

Note: *Inserting an event between A and B when there is already one event implies that the application merges both events located between A and B. Once two events are merged, it becomes impossible to delete only one of them since the application treats them as one.*





IMPORTANT

The only way to “recover” deleted items is to reanalyze the trace, as you would for a new trace. For more information, see *Analyzing or Reanalyzing a Trace* on page 158.

To delete an event:

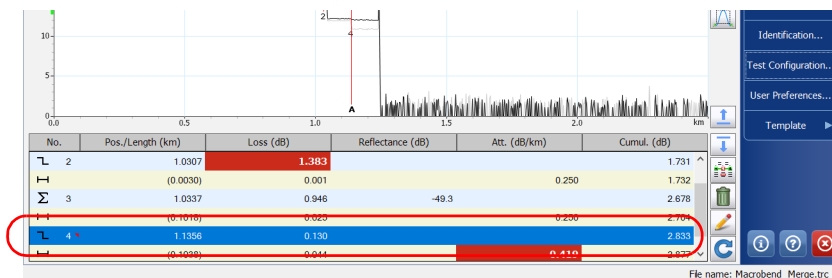
1. In the **Events** tab, select the event you want to delete.



2. Tap  .
3. When the application prompts you, tap **Yes** to confirm the deletion, or **No** to keep the event.

Managing Comments

You can insert comments manually on a specific event. If comments are already present, you can modify or delete them. A red triangle on the event indicates that a comment has been added. This way, you can locate rapidly the events you have customized.

To insert a comment:

1. Select the event on which you want to insert a comment.
2. From the **Events** tab, tap .
3. Next to **Comment**, enter a comment in the box.

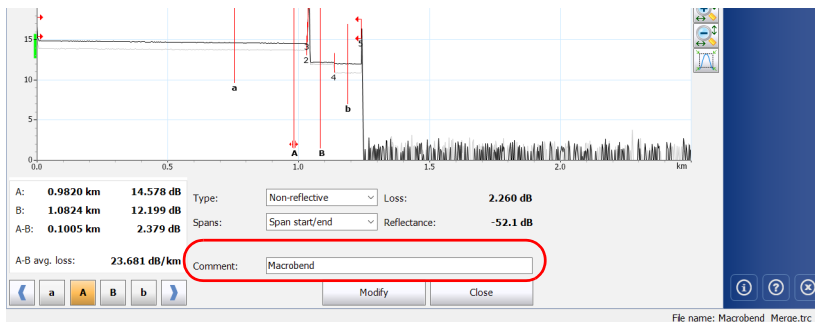

4. Tap **Modify**.

A red triangle appears next to the event number to indicate that a comment has been inserted manually. The comments can be seen in the tooltip.

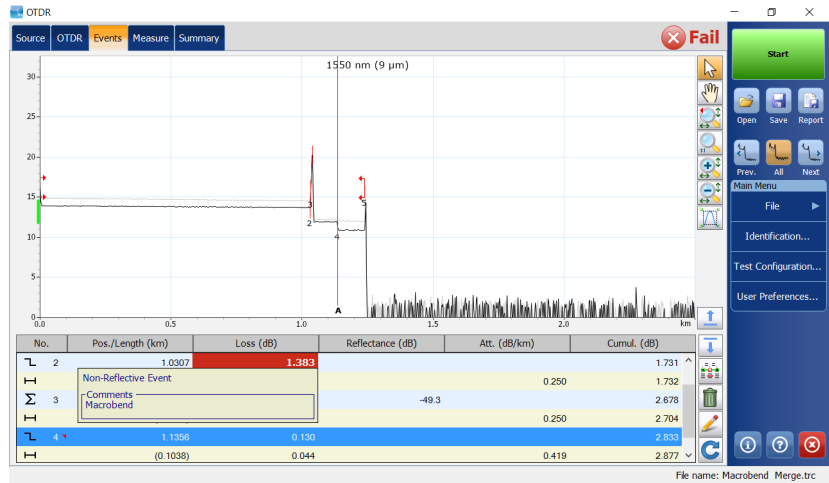

To modify or delete a comment:

1. Select the event on which you want to modify or delete a comment.
2. From the **Events** tab, tap .
3. Modify or delete the text in the **Comment** box.
4. Tap **Modify** to return to the main window.

Analyzing or Reanalyzing a Trace

You can analyze a displayed trace at any time. Analyzing or reanalyzing a trace will:

- reanalyze a trace acquired with a previous version of the software.
- re-create the table of events if it was modified.
- perform a Pass/Fail test, if enabled (see *Setting Pass/Fail Thresholds* on page 49 for details).

If you prefer to focus your analysis on a specific fiber span, see *Analyzing the Fiber on a Specific Fiber Span* on page 159 for details.

To reanalyze a trace:

1. From the main window, go to the **Events** tab.
2. Tap .
3. From the **Reanalysis** dialog box, select an item for setting the span start and end markers on the trace. On the first analysis after acquisition, this dialog box is not displayed and the default span start and end are applied according to acquisition parameters. See *Defining Launch and Receive Fiber Settings* on page 89 for details.

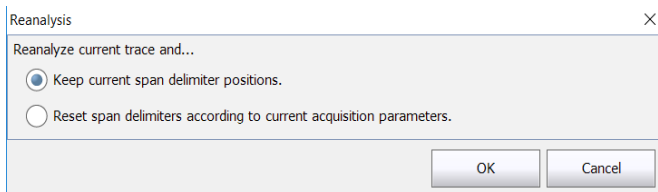



- **Keep current span delimiter positions** applies the current fiber span upon trace reanalysis.
 - **Reset span delimiters according to current acquisition parameters** applies the fiber span defined in the Extended Acquisition Parameters upon trace reanalysis.
4. Tap **OK** to confirm.

Analyzing the Fiber on a Specific Fiber Span

If you want to focus your fiber analysis on a specific fiber span, you can define events (new or existing) as a span start and/or span end. You can even define a fiber span for short fibers by placing the span start and the span end on the same event.

Note: *You can set a default span start and end, which will be applied during the first analysis or reanalysis performed upon trace acquisition.*

To set a fiber span:

1. From the main window, go to the **Events** tab (for existing events) and tap .
OR
From the main window, go to the **Measure** tab (for new events) and tap .
2. For new events, define the span event location by moving marker **A** along the trace using the left/right arrows. See *Using Markers* on page 167 for details.

Analyzing Traces and Events

Analyzing the Fiber on a Specific Fiber Span

- From the **Spans** list, set the span start or span end marker on the appropriate event in the trace display.

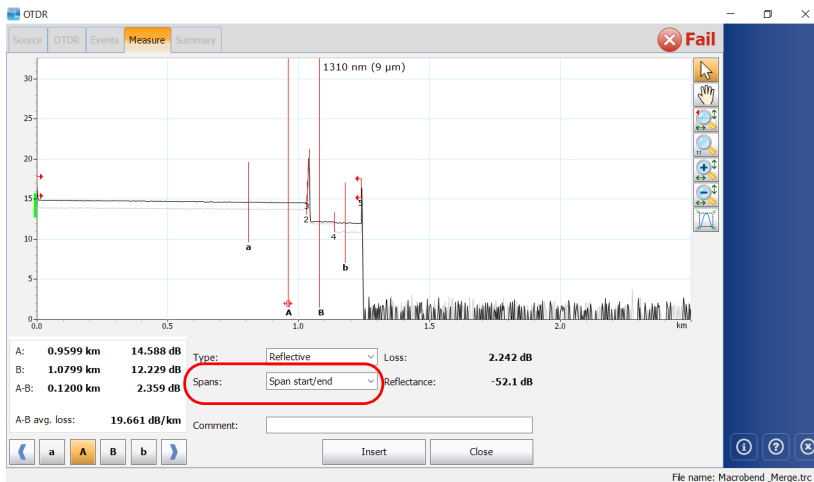

4. Tap **Modify** (Events tab) or **Insert** (Measure tab) to return to the main window.

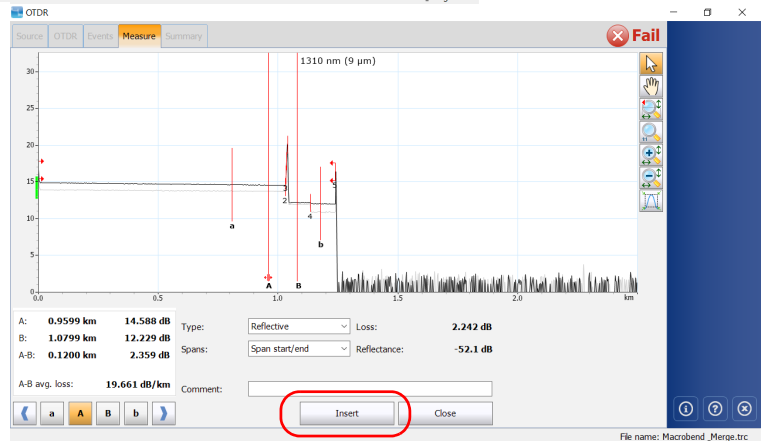
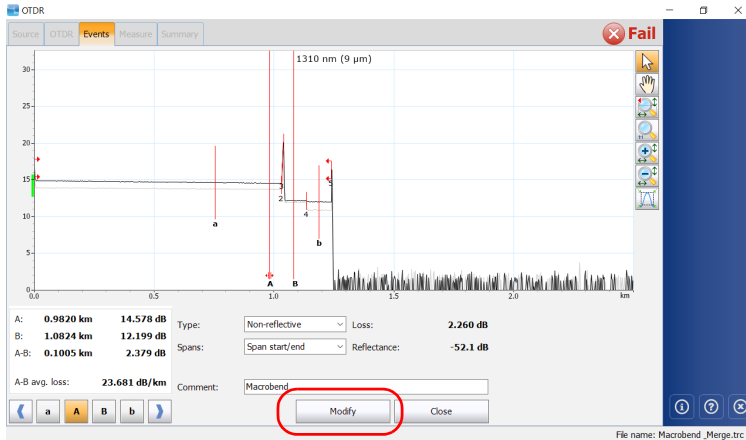

Changes to the span start and span end will modify the contents of the table of events. The span start becomes event 1 and its distance reference becomes 0. The cumulative loss is calculated within the defined fiber span only.

Enabling or Disabling the Detection of Reflective Ends of Fiber

By default, the application stops the analysis as soon as there is too much noise on a trace to ensure accurate measurements. However, you can configure the application to search the “noisy” portion of the trace to detect strong reflective events (such as those caused by UPC connectors) and set the span end at this point.

Once you have selected the option, the detection will be performed automatically on the next acquisitions.







If a trace was acquired without selecting the option first, you will be prompted to reanalyze the trace (for more information on trace reanalysis, see *Analyzing or Reanalyzing a Trace* on page 158). When you reanalyze a trace, to benefit from the option, you should select *Reset span delimiters according to current acquisition parameters*.

The application will take into account the option only if there is a significant reflective event located after the end of analysis.

Analyzing Traces and Events

Enabling or Disabling the Detection of Reflective Ends of Fiber

The table below shows the differences you will notice in the table of events depending on if you enable the detection of reflective ends of fiber or not.

Option not selected (conventional analysis)			Option selected	
Case	Event on which span end is set	Loss or reflectance value	Event on which span end is set	Loss or reflectance value
Span end located on a physical event that crosses the end-of-fiber (EoF) threshold	Non-reflective fault  or reflective fault 	Value as calculated by the conventional analysis	Same as the conventional analysis	Same as the conventional analysis
Span end located on a physical event whose loss is below the EoF threshold	Non-reflective fault  or reflective fault 	Value as calculated by the conventional analysis	If applicable, reflective fault  (located in the “noisy” area) ^a	If applicable, reflectance value as calculated by the conventional analysis. ^b
Span end not located on any physical event	End of analysis 	N/A	If applicable, reflective fault  (located in the “noisy” area) ^{c,d}	If applicable, reflectance value as calculated by the conventional analysis. ^b

- The cumulative loss value will remain the same for all elements appearing after the event on which the span end was set according to the conventional analysis. The span loss value will correspond to the loss calculated between span start and the event on which the span end was set according to the conventional analysis.
- Value is underestimated because the event is located in the “noisy” area.
- The end-of-analysis event is replaced by a non-reflective event  with a loss value of 0 dB.
- The cumulative loss value will remain the same for all elements appearing after the inserted event. The span loss value will correspond to the loss calculated between span start and the inserted event.

Analyzing Traces and Events

Enabling or Disabling the Detection of Reflective Ends of Fiber



IMPORTANT

The analysis will stop as soon as the loss of an event crosses the end-of-fiber (EoF) threshold. The application will mark the event as an end-of-fiber event.

In this case, even if you selected the option, the application *will not* search the “noisy” portion of the trace for reflective ends of fiber. If you want to do so, you will have to increase the EoF threshold (see *Setting the Analysis Detection Thresholds* on page 39).

To enable or disable the detection of reflective ends of fiber:

1. From the **Main Menu**, tap **Test Configuration**.
2. From the **Apply** to list, select **Current acquisition**.
3. From the **Test Configuration** dialog box, go to the **Link Definition** tab.
4. If you want to enable the option, select the **Reflective end-of-fiber detection** box.

OR

If you prefer to disable the option, clear the box.

The screenshot shows the 'Test Configuration' dialog box with the 'Pass/Fail Thresholds' tab selected. The 'Apply to' dropdown is set to 'Current acquisition'. The 'Detection Thresholds' section includes fields for Splice loss (0.020 dB), Splitter loss (2.000 dB), End-of-fiber (5.000 dB), and Reflectance (-72.0 dB). The 'Reflective end-of-fiber detection' checkbox is unchecked and highlighted with a red circle. Other settings include Wavelength (1310 nm/9 μm), IOR (1.467700), Backscatter (-79.45 dB), Helix factor (0.00 %), and Macroband (checked, 1310 nm - 1625 nm, Delta (loss) 0.500 dB). Buttons for 'Revert to Factory Settings', 'Copy to Next Acquisition', 'OK', and 'Cancel' are visible at the bottom.

5. Tap **OK** to return to the main window.

Opening Measurement Files

By default, when you open trace files, the application tries to match the wavelength with the one you have selected on your module. If this wavelength is not available on your module, the application selects the available wavelength nearest to the wavelength of the trace you have opened. The default view is displayed when opening a file (see *Selecting the Default View* on page 110 for details).

The table below presents the possible behavior of the zoom and markers when you open traces. If you open old OTDR traces, see the corresponding row for more information.

File Type	Zoom	Markers	Selected Events
Measurement that has been saved with a manual zoom.	Application zooms in according to the zoom area and zoom factor that were saved with the file. The same zoom will be applied to all wavelengths.	Markers are displayed in the same state they were when you saved the file. Markers will remain in the same location even if you switch to another wavelength.	Selected events are displayed in the same state they were when you saved the file. The selected events can be different for each wavelength.
Old trace file.	Traces are displayed in full view mode.	Application defines default positions for markers.	The first event of the trace is selected.



IMPORTANT

If only the zoom, markers, or the selected event are modified, you will not be prompted to save the file when measurement is closed, you must save your file before opening another one.

For information on how to navigate between traces, see *Selecting the Displayed Wavelength* on page 136.

Analyzing Traces and Events

Opening Measurement Files

To open a measurement file:

- 1.** From the **Main Menu**, tap **File**, then **Open**.

OR

From the main window, tap .

- 2.** If necessary, change the location to retrieve the file that was stored.
- 3.** Scroll through the list of files and select a trace file to open.
- 4.** Tap **Open**.

You return to the main window.

If you had already acquired (but not stored) a trace, the application prompts you to save the current trace. Tap **Save** to store the trace. You can now open another trace file.

9 Analyzing the Results Manually

You can move markers and zoom in on or out of any event or trace segment to measure splice loss, fiber section attenuation, reflectance, and optical return loss. It is possible to do this once a trace has been acquired or opened, or even when an acquisition is in progress.

Using Markers

You can use markers to view the position and relative loss or reflectance of an event.

Markers are available from the **Events** tab (when you modify an event) or the **Measure** tab (when you add an event) in the main window.

You can lock or unlock the distance between the four markers and move them as a block. You can lock or unlock the distance between the A and a marker pair, as well as the B and b marker pair and move them. You can also lock a, A, b, B markers and move them as a group.

To move a marker directly from the graph:

1. Ensure that the  button is selected in the zoom button bar.
2. In the **Measure** tab, select the marker directly on the trace display and drag it to the desired position.

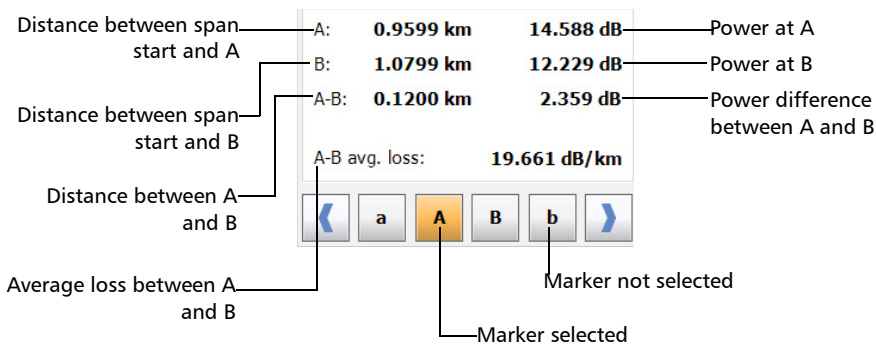

Analyzing the Results Manually

Using Markers

To move a marker with the arrow buttons:

1. From the **Measure** tab, tap the marker buttons to select the desired markers.

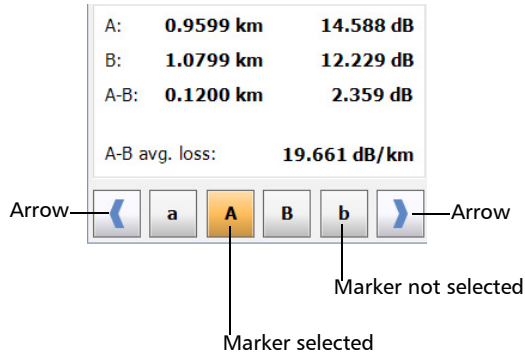

2. Once the appropriate markers are selected, use the right and left arrow buttons to move the markers along the trace.

Note: *If you select more than one marker, they will move as a block.*

To bring back a marker to the visible area:

1. Ensure that only the marker that corresponds to the one that you want to retrieve is selected.
2. Use the left and right arrows to move the marker.

Getting Event Distances and Relative Powers

The OTDR test application automatically calculates the position of an event and displays this distance in the **Events** tab.

You can retrieve the position of an event as well as the distance between events manually. You can also display various relative power readings.

Distances and relative powers correspond to the X-axis and Y-axis, respectively.

To get the distance to an event and the associated relative power level automatically:

1. From the main window, select the **Measure** tab.
2. Tap  to display all markers. Markers are automatically positioned at the right location.

Analyzing the Results Manually

Getting Event Distances and Relative Powers

To get the distance to an event and the associated relative power level manually:

1. From the main window, select the **Measure** tab.
2. Move marker **A** to the beginning of the event. See *Using Markers* on page 167 for details.



Getting Event Loss and Maximum Reflectance

Event loss (expressed in dB) is calculated by measuring the signal level reduction in Rayleigh backscatter (RBS) caused by this event. Event loss can result from both reflective and non-reflective events.

The loss calculation provided is called the “four-point event loss”. The four-point event loss calculation uses the least-square approximation (LSA) method to determine the event loss. The four-point event loss corresponds to the loss displayed in the Events tab.

- *For the four-point event loss:* the LSA method is used to fit a straight line to the backscatter data within the two regions defined by markers a, A and b, B, that is over the regions to the left and to the right of the event bordered by markers A and B, respectively.

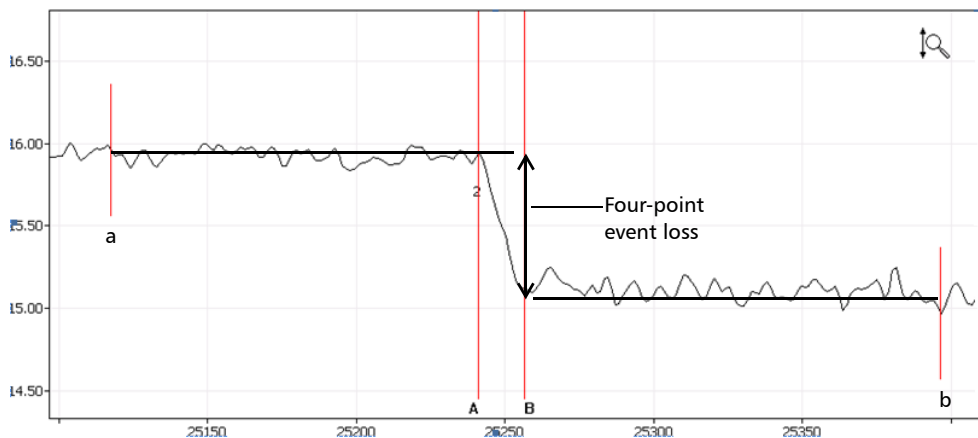

The two fitted lines are then extrapolated toward the center of the event and the loss event is directly read from the drop in power between the two lines.

- Reflectance is the ratio of reflected light to input light.

Note: *If you are testing in real-time mode, the reflectance value you will get is not necessarily accurate.*

Analyzing the Results Manually

Getting Event Loss and Maximum Reflectance

To get event loss and maximum reflectance:

- 1.** From the main window, select the **Measure** tab.
- 2.** At the bottom of the window, tap **Event**. Markers **a**, **A**, **B** and **b** appear on the graph.
- 3.** Zoom in and position marker **A** at the *end* of the linear area *preceding* the event to be measured. See *Using Zoom Controls* on page 132 and *Using Markers* on page 167 for details.
- 4.** Position submarker **a** at the *beginning* of the linear area *preceding* the event to be measured (must not include any significant events).
- 5.** Position marker **B** at the *beginning* of the linear area *following* the event to be measured.

6. Position submarker **b** at the *end* of the linear area *following* the event to be measured (must not include any significant events).

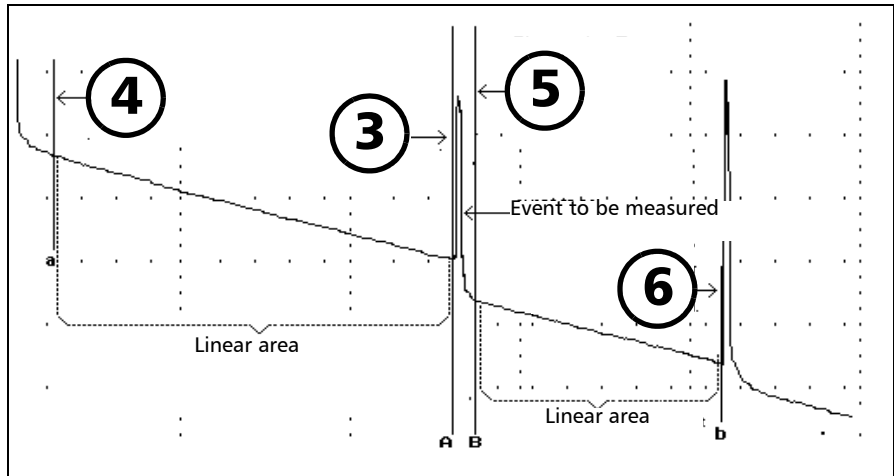

Four-point event loss from the areas delimited by markers a, A, B and b

Four-Point event loss:	Max. reflectance:
2.242 dB	-52.1 dB
Event	Section ORL

Maximum reflectance

Note: For non-reflective events, — will be displayed.

Analyzing the Results Manually

Getting Section Loss and Attenuation

Getting Section Loss and Attenuation

The least-square approximation (LSA) method measures the attenuation (loss over distance) between two points by fitting a straight line in the backscatter data between markers **A** and **B**. The LSA attenuation corresponds to the difference in power (Δ dB) over the distance between two points.

The LSA method, when compared to a two-point method, gives an average measurement and is more reliable when there is a high level of noise. However, it should not be used if an event such as an echo appears between the two markers.

A-B LSA loss: the loss of the event bordered by the markers A and B is obtained by fitting a straight line to the backscatter data between these two markers.

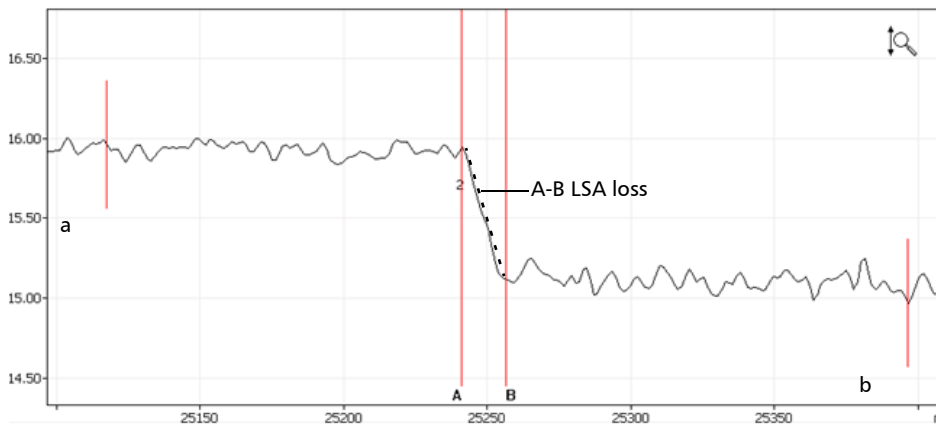

The event is then obtained by the reduction in power (dB) over the distance between the two markers, as calculated from the slope of the fitted line.

Although this method works fairly well for splice loss, it is clearly not appropriate for reflective events (definitely not a “straight-line” event). A-B LSA loss is mainly used to rapidly compute loss over a given length of a fiber section.

Note: *A-B LSA event loss measurements should be used on fiber sections only. Measuring events will not yield meaningful results.*

To get section loss and attenuation:

1. From the main window, select the **Measure** tab.
2. Tap the **Section** button. Markers **A** and **B** appear on the graph.
3. Place markers **A** and **B** at any two points on the trace. See *Using Markers* on page 167 for details.
4. Zoom in on the trace and fine-tune the marker positioning if necessary. See *Using Zoom Controls* on page 132 for details.

Note: *There should not be any event between markers A and B when performing a measurement.*

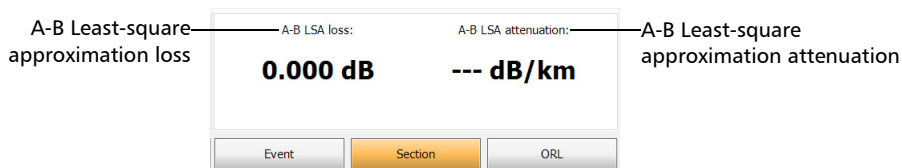

Analyzing the Results Manually

Getting Optical Return Loss (ORL)

Getting Optical Return Loss (ORL)

The ORL calculation will provide the following information:

- the ORL between markers **A** and **B**
- the total ORL is calculated either between the span start and the span end, or on the total fiber span, depending on the option you have selected. See *Excluding and Including Span Start and Span End* on page 37 for details.

Optical return loss (ORL) refers to the total effect of multiple reflections and scattering events within a fiber-optic system.

To get the ORL value:

1. From the main window, select the **Measure** tab.
2. At the bottom of the window, tap **ORL**. Markers A and B appear on the graph.

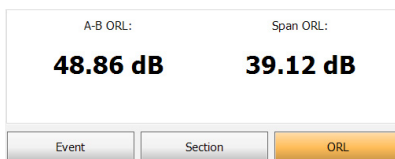

3. Position markers A and B to delimit the area for which you want to know the ORL value.

10 **Managing Trace Files from the OTDR Test Application**

Once you have acquired traces, or when you want to work with them after an acquisition, you will need to save, open, rename, and delete trace files.

To rename, copy, move, and delete trace files, you must use the **File Manager** utility.

With the OTDR application, you can open trace files and save them in native (.trc) and Bellcore (.sor) formats. By default, the application saves the traces in native (.trc) format. For information on how to define the default file format, see *Selecting the Default File Format* on page 113.

To save an OTDR trace file in another format:

Use a computer onto which FastReporter is already installed.

11 *Creating and Generating Reports*

For future reference, you can add notes on the location of the tested fiber, type of job performed and general comments related to a trace in trace reports.

Adding Information to the Test Results

Before or after acquiring a trace, you might want to include or update information about the tested fiber and job or add comments. The information you enter is saved for the currently open trace file or the next acquisition depending on your choice.

The information is common to all wavelengths (location A and B, cable ID and fiber ID, etc.). If you clear information from the **Identification** window, all information will be deleted.

Creating and Generating Reports

Adding Information to the Test Results

To add information to the test results :

1. From the **Main Menu**, tap **Identification**.
2. Select either **Current acquisition** or **Next acquisition** from the **Apply to** list.
3. Enter the desired information. See *Naming Trace Files Automatically* on page 26 for details.

Identifiers	Value	Increment	File name
Job ID			<input type="checkbox"/>
Company			<input type="checkbox"/>
Customer			<input type="checkbox"/>
Operator A			<input type="checkbox"/>
Operator B			<input type="checkbox"/>
Comments			<input type="checkbox"/>
Cable ID		Not active	<input type="checkbox"/>
Fiber ID	Fiber 1	1	<input checked="" type="checkbox"/>
Location A		Not active	<input type="checkbox"/>

File name preview: Fiber 11.trc

Separator: Underscore (_)

Buttons: Increment..., Clear Values, Revert to Factory Settings, OK, Cancel

Note: The information in the **Serial number**, **Model**, and **Calibration date** boxes is provided by the application and cannot be edited. The **Wavelength(s)**, **Pulse(s)**, and **Duration(s)** cannot be edited in the **Identification** window but can be set before taking an acquisition in the **OTDR** tab.

4. Tap **OK** to return to the trace display.

The information entered is saved with the trace and can be viewed or changed at any time using the same process.

To clear all the information from the Identification window:

Tap the **Clear Values** button.

Note: *The information appearing in the **Wavelength(s), Pulse(s), Duration(s), Serial number, Model, and Calibration date** boxes cannot be deleted.*

Generating a Report

You can generate trace reports directly from your unit in PDF or XML format. By default, all traces are generated in a report, but you can also generate all the traces the current file contains.

The XML file does not contain the graphs, but contains all of the other information with the appropriate indicator so that the report generator displays it or not.

The following list shows the various items that can appear on a PDF report. By default, all these items are selected.

- **Global pass/fail:** this element shows if a result is Pass or Fail. It is displayed in the upper right part of the report.
- **General information:** contains information such as file name, test date and time, cable ID, job ID, comments, customer, company, and fiber ID.
- **Locations:** displays information such as location A and B, operator A and operator B, the unit's model and serial number, and the calibration date.
- **Results:** displays information on the link measurement such as span length, span loss, average loss, average splice loss, maximum splice loss and span ORL.
- **Graph:** Graphs will be generated exactly as they appear on screen. The same zoom factor will be applied to all traces (wavelengths) of a particular file. Markers will also be displayed on the graph.

Creating and Generating Reports

Generating a Report

- **Markers:** marker information: a, A, B, b as well as A to B LSA attenuation, LSA loss, and ORL. The attenuation, 4 point event loss, and maximum reflectance are also displayed.
- **Table of events:** the failed results will appear in white on a red background. Otherwise, they will not be “highlighted”.
- **Macrobend table:** contains the location and the delta loss of all the detected macrobends.

Note: *The macrobends are not available if you are working with a MAX/FTBx-740C-DWx module.*

Note: *This table is global to the fiber and will be generated if the application has detected macrobends (at any wavelength). For example, even if you choose to only include the current trace (for which no macrobends have been detected at this particular wavelength), the table could be generated if macrobends have been detected at other wavelengths.*

- **Pass/Fail thresholds:** splice loss, connector loss, reflectance, fiber section attenuation, span loss, span length and span ORL thresholds as they are defined in **Test Configuration**, under **Pass/Fail Thresholds**.
- **Test parameters:** displays wavelength, range, pulse, and duration.
- **Test settings:** displays IOR, backscatter, helix factor, splice loss threshold, reflectance threshold, end-of-fiber thresholds, macrobend wavelengths, and macrobend delta loss.

Once you generate a report, the application will keep in memory the items you have included in your reports for future use.

To define report contents:

- 1.** From the **Main Menu**, tap the **User Preferences** button.
- 2.** Select the **Report** tab.
- 3.** Select the desired file type.

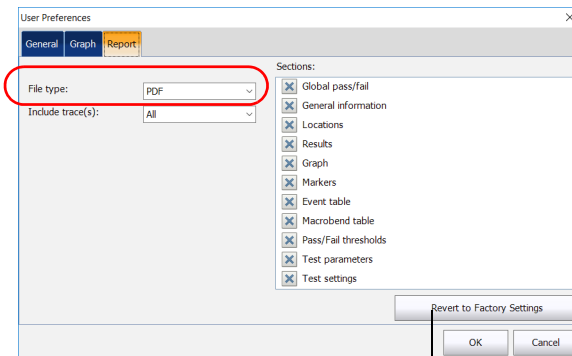

The **Revert to Factory Settings** button resets all the values in the **Report** tab.

Note: *If you want to use the data or to customize your report later with your own tools, select **XML**.*

Creating and Generating Reports

Generating a Report

4. From the **Include trace(s)** list, select **All** to generate a report for all traces (wavelengths) or **Current** to generate a report for the current trace.

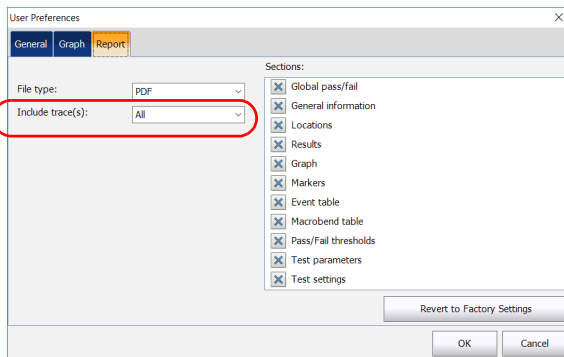

5. If the selected file type is PDF, select the report characteristics, including whether you want to include the graphs or not.

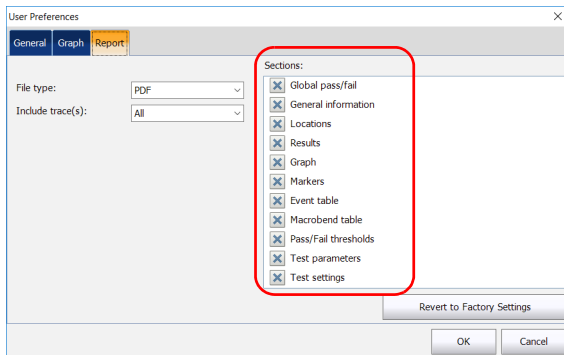

6. Tap **OK** to return to the main window.

To generate reports manually:

1. From the main window, tap .

OR

From the **Main Menu**, go to **File** then tap **Report**.

2. From the **Save As** dialog box, select a folder or create one to save your file.
3. If desired, modify the file name and the file type (.pdf or .xml).
4. Tap **Save** to confirm.

You will automatically return to the main window and a report will be generated.

To generate reports automatically:

1. If you want to generate a report automatically on save, from the **Main Menu**, tap the **User Preferences** button.
2. Select the **General** tab.
3. Select the **Generate report on save** check box.

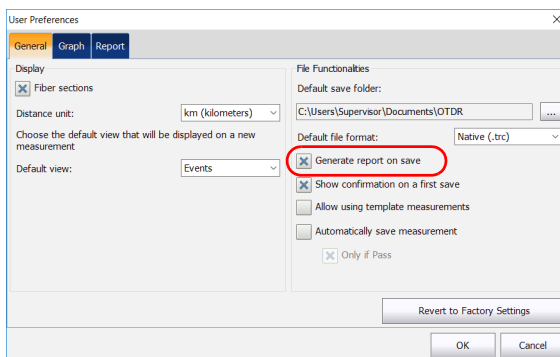

4. Tap **OK** to return to the main window.

Note: Each time a file is saved, reports are saved automatically at the same time as the OTDR file.

12 Using the OTDR as a Light Source

If you want to perform measurements with a power meter and your OTDR as a source, the OTDR port can transmit a special tone. This port can be used only to transmit—not detect that tone.



CAUTION

Never connect a live fiber to the OTDR port without a proper setup. Any incoming optical power ranging from -65 dBm to -40 dBm will affect the OTDR acquisition. The way the acquisition will be affected depends on the selected pulse width. Any incoming signal greater than 10 dBm could damage your OTDR module permanently. For live-fiber testing, refer to the SM Live port specifications for the characteristics of the built-in filter.

Note: *If you have a DWDM or a CWDM OTDR, the parameters set in the **OTDR** tab are applied automatically in the **Source** tab. See Working With the DWDM OTDR Module on page 57 or Working With the CWDM OTDR Module on page 67 for details.*

To use your OTDR as a source:

1. Clean the connectors properly (see *Cleaning and Connecting Optical Fibers* on page 24 for details).
2. Connect one end of the fiber under test to the OTDR port.

If your unit is equipped with two OTDR ports, ensure that you connect the fiber to the appropriate port (singlemode, singlemode live, or multimode), depending on the wavelength you intend to use.

3. From the main window, tap the **Source** tab.

Using the OTDR as a Light Source

4. If you have a standard OTDR, select the desired wavelength in the list of available choices.

OR

If you have a DWDM or a CWDM OTDR, select a channel filter and a specific channel. See *Working With the DWDM OTDR Module* on page 57 or *Working With the CWDM OTDR Module* on page 67 for details.

Standard OTDR



DWDM and CWDM OTDR



Note: If you have a DWDM or a CWDM OTDR, the parameters set in the **OTDR** tab are applied automatically in the **Source** tab. See *Working With the DWDM OTDR Module* on page 57 or *Working With the CWDM OTDR Module* on page 67 for details.

Note: If only one wavelength is available, it is selected by default.

5. Select the desired modulation in the list of available choices.
 - For loss measurement, with a power meter at the other end, select **Continuous**.



IMPORTANT

OTDR can be used in continuous source mode (CW) to perform optical power measurements and it is compatible only with the following: high power Germanium (GeX) versions of the 300 and 600 Series, as well as any unit's built-in GeX power meters.

The EPM-50 power meter and MPC-100 power checker are not compatible for measurements using an OTDR in Continuous setting.

- For fiber identification, select **330 Hz**, **1 kHz** or **2 kHz**. This will allow the person at the other end of the link to identify the fiber under test, which could be particularly useful when working with cables containing many fibers.

For easier fiber identification, the application also offers a flashing pattern. If you select this pattern, the modulated signal (1 KHz or 2 KHz) will be sent for 1 second, then will be off for the next second, then be sent again for 1 second, and so on. If you want the OTDR to emit light in a flashing pattern, select **1 kHz+Blink** or **2 kHz+Blink**.

Using the OTDR as a Light Source

6. Tap **Turn On**. You can stop light emission at any time by tapping **Turn Off**.

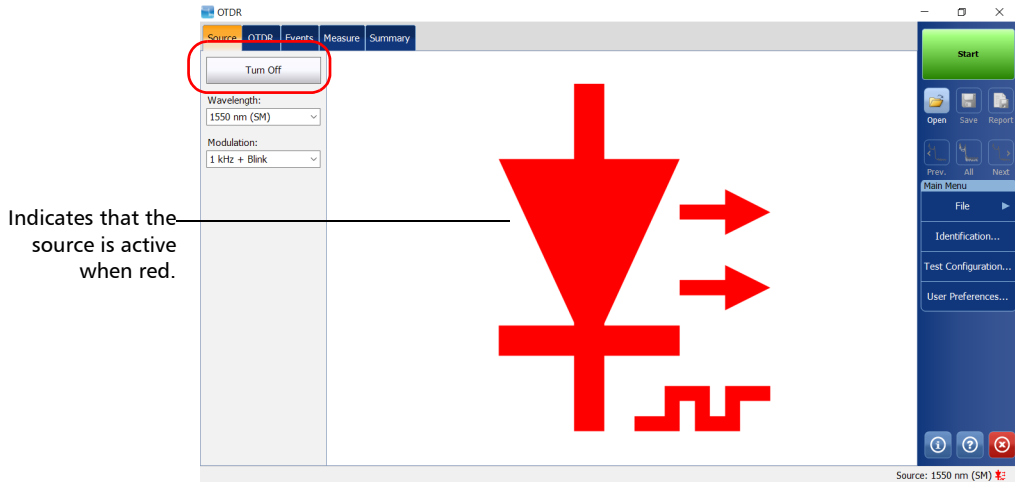

Using an EXFO power meter with tone-detection features, such as the FOT-930 or FPM-300, an operator at the other end will be able to quickly locate the correct fiber or perform loss measurements. Refer to the power meter user guide for details.

13 *Maintenance*

To help ensure long, trouble-free operation:

- Always inspect fiber-optic connectors before using them and clean them if necessary.
- Keep the unit free of dust.
- Clean the unit casing and front panel with a cloth slightly dampened with water.
- Store unit at room temperature in a clean and dry area. Keep the unit out of direct sunlight.
- Avoid high humidity or significant temperature fluctuations.
- Avoid unnecessary shocks and vibrations.
- If any liquids are spilled on or into the unit, turn off the power immediately, disconnect from any external power source, remove the batteries and let the unit dry completely.



WARNING

The use of controls, adjustments and procedures, namely for operation and maintenance, other than those specified herein may result in hazardous radiation exposure or impair the protection provided by this unit.

Cleaning EUI Connectors

Regular cleaning of EUI connectors will help maintain optimum performance. There is no need to disassemble the unit.



IMPORTANT

If any damage occurs to internal connectors, the module casing will have to be opened and a new calibration will be required.



WARNING

Looking into the optical connector while the light source is active **WILL** result in permanent eye damage. EXFO strongly recommends to **TURN OFF** the unit before proceeding with the cleaning procedure.

To clean EUI connectors:

1. Remove the EUI from the instrument to expose the connector baseplate and ferrule.

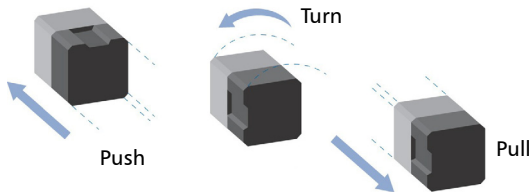

2. Moisten a 2.5 mm cleaning tip with *one drop* of optical-grade liquid cleaner.

3. Slowly insert the cleaning tip into the EUI adapter until it comes out on the other side (a slow clockwise rotating movement may help).

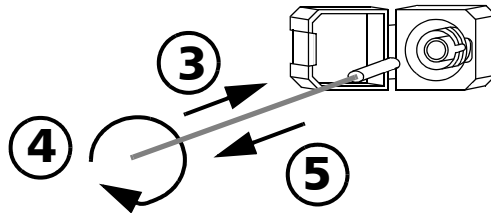

4. Gently turn the cleaning tip one full turn, then continue to turn as you withdraw it.
5. Repeat steps 3 to 4 with a dry cleaning tip.

Note: *Make sure you don't touch the soft end of the cleaning tip.*

6. Clean the ferrule in the connector port as follows:
 - 6a. Deposit *one drop* of optical-grade liquid cleaner on a lint-free wiping cloth.



IMPORTANT

Avoid contact between the tip of the bottle and the wiping cloth, and dry the surface quickly.

- 6b. Gently wipe the connector and ferrule.
- 6c. With a dry lint-free wiping cloth, gently wipe the same surfaces to ensure that the connector and ferrule are perfectly dry.
- 6d. Verify connector surface with a fiber inspection probe (for example, EXFO's FIP).
7. Put the EUI back onto the instrument (push and turn clockwise).
8. Throw out cleaning tips and wiping cloths after one use.

Recalibrating the Unit

EXFO manufacturing and service center calibrations are based on the ISO/IEC 17025 standard (*General Requirements for the Competence of Testing and Calibration Laboratories*). This standard states that calibration documents must not contain a calibration interval and that the user is responsible for determining the re-calibration date according to the actual use of the instrument.

The validity of specifications depends on operating conditions. For example, the calibration validity period can be longer or shorter depending on the intensity of use, environmental conditions and unit maintenance, as well as the specific requirements for your application. All of these elements must be taken into consideration when determining the appropriate calibration interval of this particular EXFO unit.

Under normal use, the recommended interval for your OTDR is: one year.

For newly delivered units, EXFO has determined that the storage of this product for up to six months between calibration and shipment does not affect its performance.

To help you with calibration follow-up, EXFO provides a special calibration label that complies with the ISO/IEC 17025 standard and indicates the unit calibration date and provides space to indicate the due date. Unless you have already established a specific calibration interval based on your own empirical data and requirements, EXFO would recommend that the next calibration date be established according to the following equation:

Next calibration date = Shipping date + Recommended calibration period (one year)

To ensure that your unit conforms to the published specifications, calibration may be carried out at an EXFO service center or, depending on the product, at one of EXFO's certified service centers. Calibrations at EXFO are performed using standards traceable to national metrology institutes.

Note: *You may have purchased a FlexCare plan that covers calibrations. See the Service and Repairs section of this user documentation for more information on how to contact the service centers and to see if your plan qualifies.*

Recycling and Disposal



This symbol on the product means that you should recycle or dispose of your product (including electric and electronic accessories) properly, in accordance with local regulations. Do not dispose of it in ordinary garbage receptacles.

For complete recycling/disposal information, visit the EXFO Web site at www.exfo.com/recycle.

14 Troubleshooting

Solving Common Problems

The table below presents common problems and their solutions.

Problem	Cause	Solution
The application displays a message indicating that a “Non-resolved fiber end” event has been found.	The fiber under test is too long.	Ensure that the fiber under test is shorter than the maximum length the OTDR can measure.
The application displays a message indicating that a “live fiber error” occurred and the fiber <i>was not</i> connected to the SM Live port.	Light has been detected on the OTDR port during the acquisition or while you were monitoring a fiber in real-time mode.	<p>Disconnect the fiber from the OTDR port. Press OK to close the message.</p> <p>Start another acquisition without any fiber connected to the OTDR. The message about live fiber error should not appear and the OTDR trace should look “normal”.</p> <p>If you still see the message about live fiber error even if no fiber is connected to the OTDR, contact EXFO.</p> <p>Never connect a live fiber to the OTDR port without a proper setup. Any incoming optical power ranging from -65 dBm to -40 dBm will affect the OTDR acquisition. The way the acquisition will be affected depends on the selected pulse width.</p> <p>Any incoming signal greater than -20 dBm could damage your OTDR module permanently. For live-fiber testing, refer to the SM Live port specifications for the characteristics of the built-in filter.</p>

Troubleshooting

Solving Common Problems

Problem	Cause	Solution
The application displays a message indicating that a “live fiber error” occurred and the fiber <i>was</i> connected to the SM Live port.	The level of integrated power in the filter bandwidth of the SM Live port is too high. A transmission wavelength from the network could be too close to the SM Live wavelength.	<p>Disconnect the fiber from the OTDR port. Press OK to close the message.</p> <p>Start another acquisition without any fiber connected to the OTDR. The message about live fiber error should not appear and the OTDR trace should look “normal”.</p> <p>If you still see the message about live fiber error even if no fiber is connected to the OTDR, contact EXFO.</p> <p>Singlemode live-fiber testing requires that the integrated power in the test channel (corresponding to the filter bandwidth of the SM Live port) be as low as possible. Any incoming optical power ranging from –65 dBm to – 40 dBm will affect the OTDR acquisition. The way the acquisition will be affected depends on the selected pulse width. Higher power levels will prevent acquisition from running. Verify network compatibility with the SM Live wavelength. Ensure that the network is not transmitting wavelengths greater than 1600 nm.</p>

Viewing Online Documentation

An online version of the OTDR user guide is available at all times from the application.

To access online help:

At the bottom of the **Main Menu**, tap .

Contacting the Technical Support Group

To obtain after-sales service or technical support for this product, contact EXFO at one of the following numbers. The Technical Support Group is available to take your calls from Monday to Friday, 8:00 a.m. to 7:00 p.m. (Eastern Time in North America).

Technical Support Group

400 Godin Avenue
Quebec (Quebec) G1M 2K2
CANADA

1 866 683-0155 (USA and Canada)
Tel.: 1 418 683-5498
Fax: 1 418 683-9224
support@exfo.com

For detailed information about technical support, and for a list of other worldwide locations, visit the EXFO Web site at www.exfo.com.

If you have comments or suggestions about this user documentation, you can send them to customer.feedback.manual@exfo.com.

To accelerate the process, please have information such as the name and the serial number (see the product identification label), as well as a description of your problem, close at hand.

Troubleshooting

Viewing Information About Your OTDR

Viewing Information About Your OTDR

You can view information about your OTDR such as the version number and contact information for technical support in the **About** window.

To view OTDR information:

From the main window, tap .

Transportation

Maintain a temperature range within specifications when transporting the unit. Transportation damage can occur from improper handling. The following steps are recommended to minimize the possibility of damage:

- Pack the unit in its original packing material when shipping.
- Avoid high humidity or large temperature fluctuations.
- Keep the unit out of direct sunlight.
- Avoid unnecessary shocks and vibrations.

15 Warranty

General Information

EXFO Inc. (EXFO) warrants this equipment against defects in material and workmanship for a period of one year from the date of original shipment. EXFO also warrants that this equipment will meet applicable specifications under normal use.

During the warranty period, EXFO will, at its discretion, repair, replace, or issue credit for any defective product, as well as verify and adjust the product free of charge should the equipment need to be repaired or if the original calibration is erroneous. If the equipment is sent back for verification of calibration during the warranty period and found to meet all published specifications, EXFO will charge standard calibration fees.



IMPORTANT

The warranty can become null and void if:

- unit has been tampered with, repaired, or worked upon by unauthorized individuals or non-EXFO personnel.
- warranty sticker has been removed.
- case screws, other than those specified in this guide, have been removed.
- case has been opened, other than as explained in this guide.
- unit serial number has been altered, erased, or removed.
- unit has been misused, neglected, or damaged by accident.

THIS WARRANTY IS IN LIEU OF ALL OTHER WARRANTIES EXPRESSED, IMPLIED, OR STATUTORY, INCLUDING, BUT NOT LIMITED TO, THE IMPLIED WARRANTIES OF MERCHANTABILITY AND FITNESS FOR A PARTICULAR PURPOSE. IN NO EVENT SHALL EXFO BE LIABLE FOR SPECIAL, INCIDENTAL, OR CONSEQUENTIAL DAMAGES.

Warranty

Liability

Liability

EXFO shall not be liable for damages resulting from the use of the product, nor shall be responsible for any failure in the performance of other items to which the product is connected or the operation of any system of which the product may be a part.

EXFO shall not be liable for damages resulting from improper usage or unauthorized modification of the product, its accompanying accessories and software.

Exclusions

EXFO reserves the right to make changes in the design or construction of any of its products at any time without incurring obligation to make any changes whatsoever on units purchased. Accessories, including but not limited to fuses, pilot lamps, batteries and universal interfaces (EUI) used with EXFO products are not covered by this warranty.

This warranty excludes failure resulting from: improper use or installation, normal wear and tear, accident, abuse, neglect, fire, water, lightning or other acts of nature, causes external to the product or other factors beyond the control of EXFO.



IMPORTANT

In the case of products equipped with optical connectors, EXFO will charge a fee for replacing connectors that were damaged due to misuse or bad cleaning.

Certification

EXFO certifies that this equipment met its published specifications at the time of shipment from the factory.

Service and Repairs

EXFO commits to providing product service and repair for five years following the date of purchase.

To send any equipment for service or repair:

- 1.** Call one of EXFO's authorized service centers (see *EXFO Service Centers Worldwide* on page 204). Support personnel will determine if the equipment requires service, repair, or calibration.
- 2.** If equipment must be returned to EXFO or an authorized service center, support personnel will issue a Return Merchandise Authorization (RMA) number and provide an address for return.
- 3.** If possible, back up your data before sending the unit for repair.
- 4.** Pack the equipment in its original shipping material. Be sure to include a statement or report fully detailing the defect and the conditions under which it was observed.
- 5.** Return the equipment, prepaid, to the address given to you by support personnel. Be sure to write the RMA number on the shipping slip. *EXFO will refuse and return any package that does not bear an RMA number.*

Note: *A test setup fee will apply to any returned unit that, after test, is found to meet the applicable specifications.*

After repair, the equipment will be returned with a repair report. If the equipment is not under warranty, you will be invoiced for the cost appearing on this report. EXFO will pay return-to-customer shipping costs for equipment under warranty. Shipping insurance is at your expense.

Routine recalibration is not included in any of the warranty plans. Since calibrations/verifications are not covered by the basic or extended warranties, you may elect to purchase FlexCare Calibration/Verification Packages for a definite period of time. Contact an authorized service center (see *EXFO Service Centers Worldwide* on page 204).

Warranty

EXFO Service Centers Worldwide

EXFO Service Centers Worldwide

If your product requires servicing, contact your nearest authorized service center.

EXFO Headquarters Service Center

400 Godin Avenue
Quebec (Quebec) G1M 2K2
CANADA

1 866 683-0155 (USA and Canada)
Tel.: 1 418 683-5498
Fax: 1 418 683-9224
support@exfo.com

EXFO Europe Service Center

Winchester House, School Lane
Chandlers Ford, Hampshire S053 4DG
ENGLAND

Tel.: +44 2380 246800
Fax: +44 2380 246801
support.europe@exfo.com

EXFO Telecom Equipment (Shenzhen) Ltd.

3rd Floor, Building C,
FuNing Hi-Tech Industrial Park, No. 71-3,
Xintian Avenue,
Fuhai, Bao'An District,
Shenzhen, China, 518103

Tel: +86 (755) 2955 3100
Fax: +86 (755) 2955 3101
support.asia@exfo.com

To view EXFO's network of partner-operated Certified Service Centers nearest you, please consult EXFO's corporate website for the complete list of service partners:

<http://www.exfo.com/support/services/instrument-services/exfo-service-centers>.

A ***Description of Event Types***

This section describes all types of events that may appear in the events table generated by the application. Here is a guide to the descriptions:

- Each type of event has its own symbol.
- Each type of event is represented by a graph of a fiber trace, which illustrates the power reflected back toward the source as a function of distance.
- An arrow points to the location of the event type in the trace.
- Most graphs show one complete trace; that is, an entire acquisition range.
- Some graphs show only a portion of the entire range to view events of interest more closely.

Description of Event Types

Span Start

Span Start

The Span Start of a trace is the event that marks the beginning of the fiber span. By default, the Span Start is placed on the first event of a tested fiber (typically the first connector of the OTDR itself).

You can make another event the start of the span you want to focus your analysis on. This will set the beginning of the events table at a specific event along the trace.

Span End

The Span End of a trace is the event that marks the end of the fiber span. By default, the Span End is placed on the last event of a tested fiber, and is called the end-of-fiber event.

You can also make another event the end of the span you want to focus your analysis on. This will set the end of the events table at a specific event along the trace.

Short Fibers

You can test short fibers with the application. You can even define a fiber span for short fibers by placing the span start and the span end on the same event.

Continuous Fiber ----

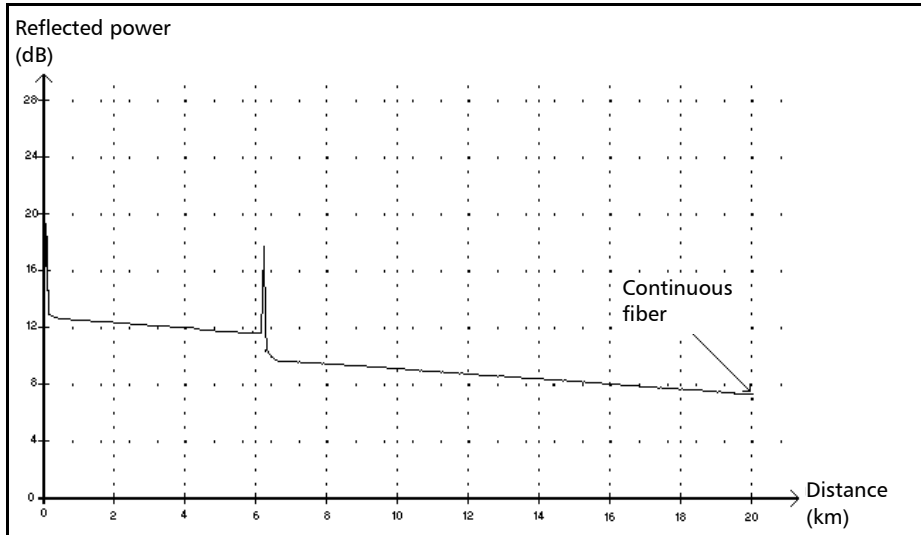

This event indicates that the selected acquisition range was shorter than the fiber length.

- The fiber end was not detected because the analysis process ended before reaching the end of the fiber.
- The acquisition distance range should therefore be increased to a value greater than the fiber length.
- There is no loss or reflectance specified for continuous fiber events.

Description of Event Types

End of Analysis

End of Analysis →

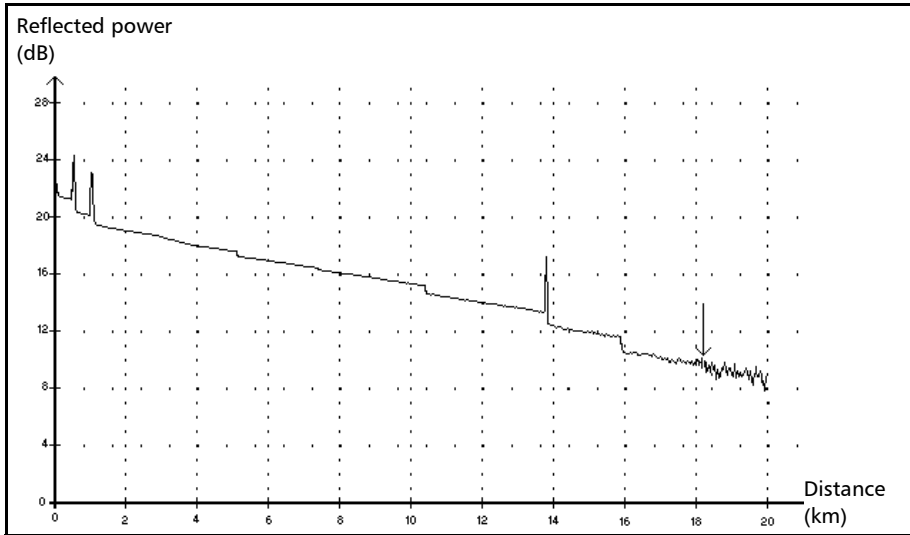

This event indicates that the pulse width used did not provide enough dynamic range to get to the end of the fiber.

- The analysis ended before reaching the end of the fiber because the signal-to-noise ratio was too low.
- The pulse width should therefore be increased so the signal reaches the end of the fiber with a sufficient signal-to-noise ratio.
- There is no loss or reflectance specified for end-of-analysis events.

Non-Reflective Event

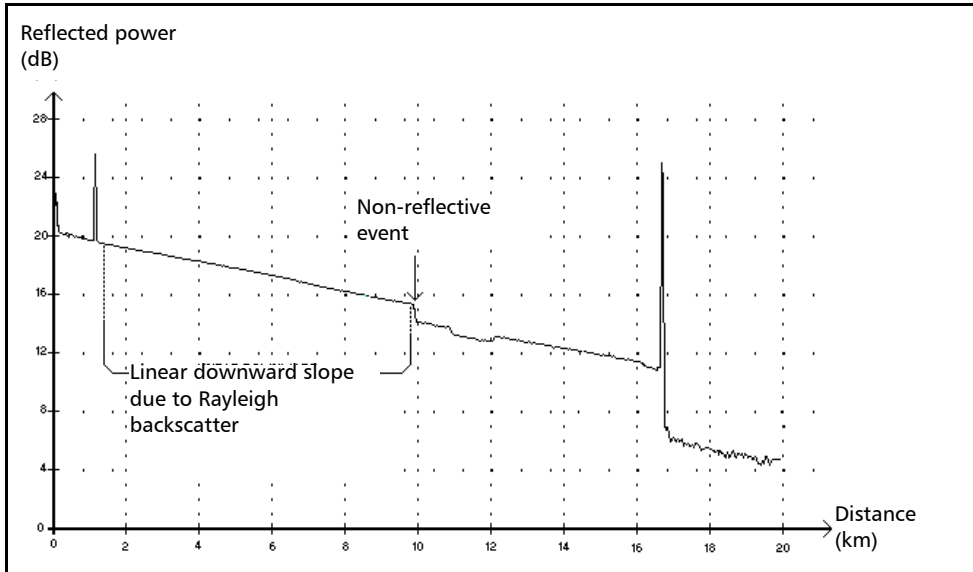

This event is characterized by a sudden decrease in the Rayleigh backscatter signal level. It appears as a discontinuity in the downward slope of the trace signal.

- This event is often caused by splices, macrobends, or microbends in the fiber.
- A loss value is specified for non-reflective events. There is no reflectance specified for this type of event.
- If you set thresholds, the application indicates a non-reflective fault in the events table, whenever a value exceeds the loss threshold.

Description of Event Types

Reflective Event

Reflective Event ↴

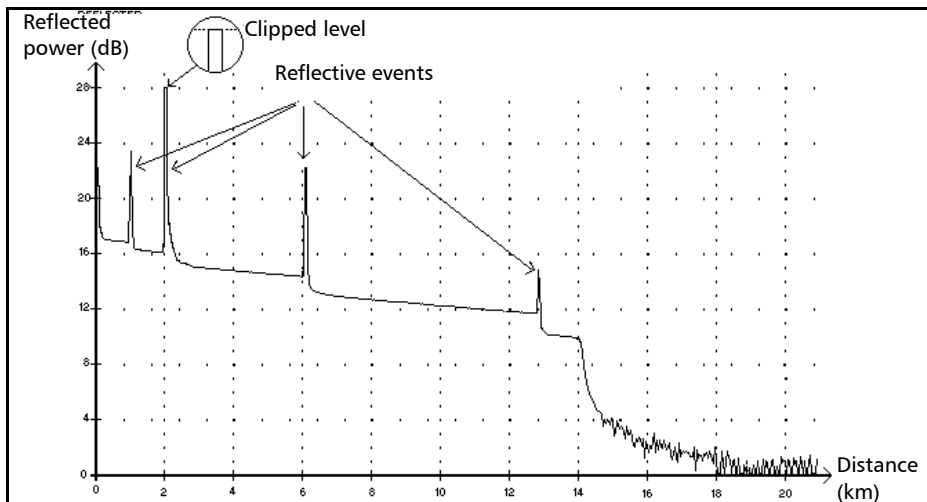

Reflective events appear as spikes in the fiber trace. They are caused by an abrupt discontinuity in the index of refraction.

- Reflective events cause a significant portion of the energy initially launched into the fiber to be reflected back toward the source.
- Reflective events may indicate the presence of connectors, mechanical splices, or even poor-quality fusion splices or cracks.
- Normally, loss and reflectance values are specified for reflective events.
- When the reflective spike reaches the maximum level, its top may be clipped due to the saturation of the detector. As a result, the dead zone (minimum distance for making a detection or attenuation measurement between this event and a second nearby) may be increased.
- If you set thresholds, the application indicates a reflective fault in the events table, whenever a value exceeds reflectance or connector loss thresholds.

Positive Event

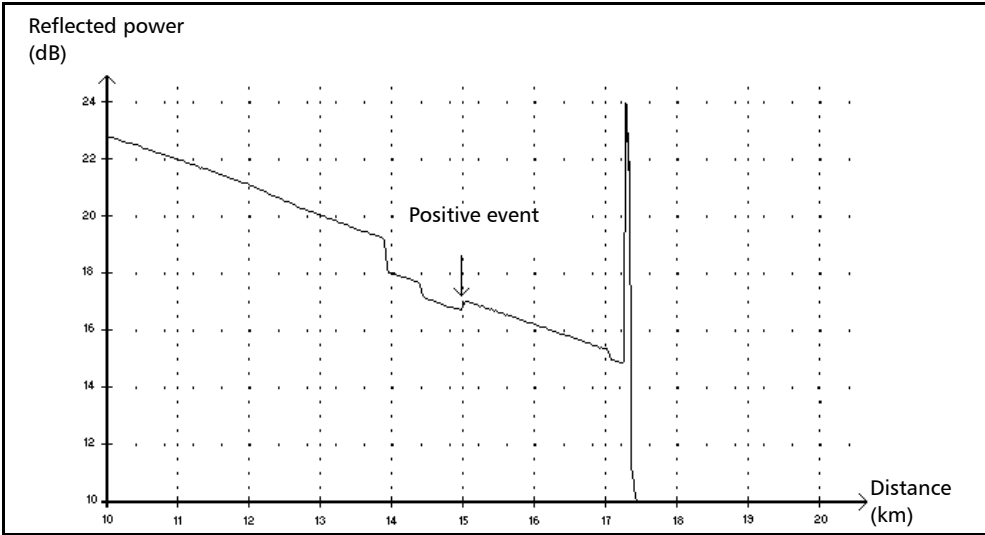

This event indicates a splice with an apparent gain, due to the junction of two fiber sections having different fiber backscatter characteristics (backscatter and backscatter capture coefficients).

Description of Event Types

Launch Level

Launch Level →

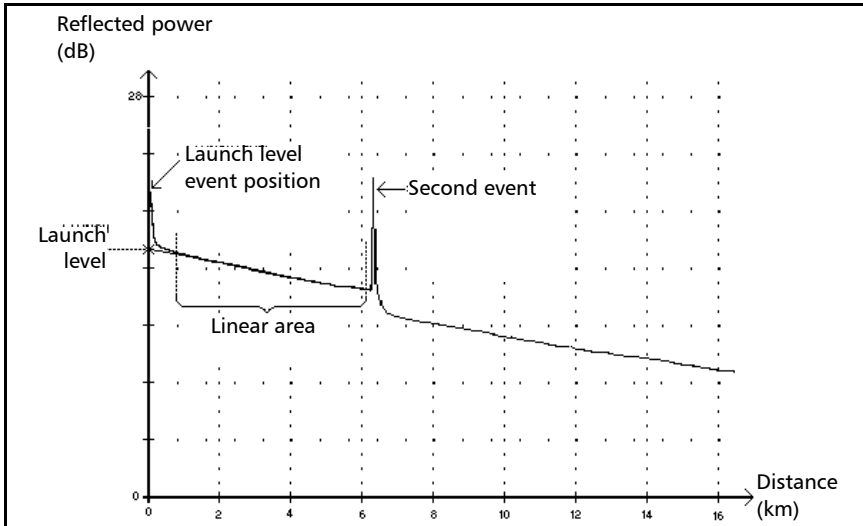

This event indicates the level of the signal launched into the fiber.

- The figure above shows how the launch level is measured.

A straight line is plotted using least-square approximation to fit all trace points in the linear area between the first and second detected events.

The straight line is projected toward the Y-axis (dB) until it crosses the axis.

The crossing point indicates the launch level.

- <<<< in the events table indicates that the launch level is too low.

Fiber Section

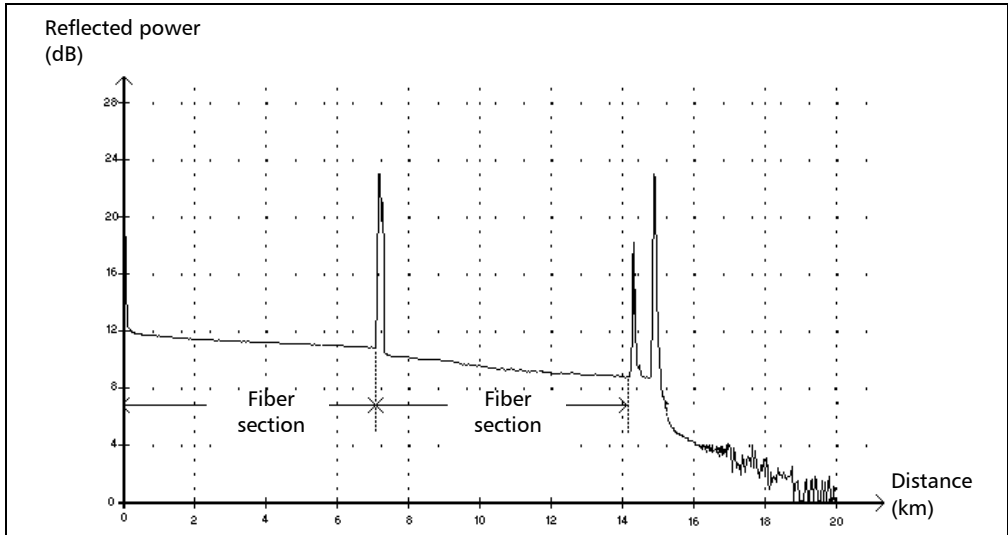

This symbol denotes a fiber section with no event.

- The sum of all fiber sections contained in an entire fiber trace equals the total fiber length. Detected events are distinct even if they cover more than one point on the trace.
- A loss value is specified for fiber section events. No reflectance is specified for this type of event.
- The attenuation (dB/distance in kilometers) is obtained by dividing the loss by the fiber section length.

Description of Event Types

Merged Event

Merged Event Σ

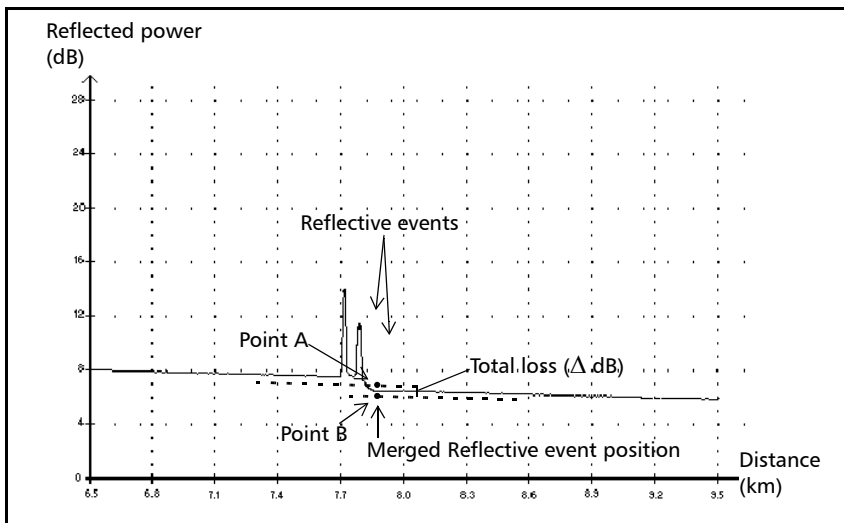

This symbol denotes an event combined with one or more other events. It also indicates the total loss produced by the merged events following it in the events table.

- A Merged Event is composed of subevents. Only the Merged Event is attributed a number in the events table, not the subevents composing it, if they are displayed.
- *Reflective* events may indicate the presence of connectors, mechanical splices, or poor-quality fusion splices or cracks.
- *Non-reflective* events may indicate the presence of splices, splitters or bendings.
- A reflectance value is specified for all merged events and indicates the maximum reflectance for the merged event. A reflectance value is also displayed for each reflective subevent composing the Merged Event.

- The total loss (Δ dB) produced by the events is measured by plotting two straight lines.
 - The first line is plotted by fitting, through least-square approximation, trace points in the linear area preceding the first event.
 - The second line is plotted by fitting, through least-square approximation, trace points in the linear area following the second event. If there were more than two merged events, this line would be plotted in the linear area following the last merged event. This line is then projected toward the first merged event.
 - The total loss (Δ dB) equals the power difference between the point where the first event begins (point A) and the point on the projected straight line located just below the first event (point B).
 - No loss value can be specified for the subevents.

Description of Event Types

Merged Event

Pass/Fail Tests

As an example about pass/fail tests, let us consider the situation below:

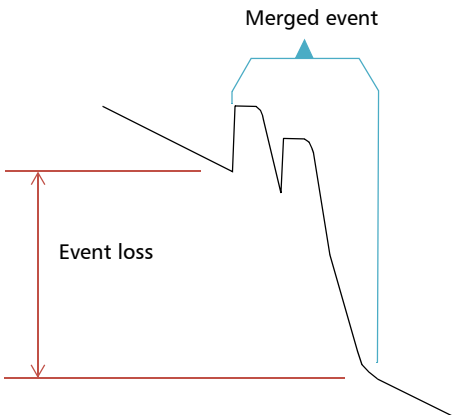

Merged sub-events:

2 reflective losses
1 non-reflective loss

Thresholds:

Reflective loss: 0.5 dB
Non-reflective Loss: 0.2 dB

For a merged event, it is possible to determine the global event loss, but not the contribution of each sub-event. This is why the pass/fail test may sometimes lead to “false positive” or “false negative” results.

When evaluating event status against thresholds, we are faced with two possible conditions:

- All event types are tested (reflective, non-reflective)
- Only some event types are selected (for example, you could decide not to test reflective loss)

The third case would be to test none of the event types, which means the same as not wanting to know the status of the events.

All Event Types Are Tested

In the first case, where all event types are tested, the pass/fail conditions are as follows:

- If the event loss is less than or equal to the smallest threshold value, then the event status is *Pass*.
- If the event loss is greater than the sum of the number of sub-events of a type, multiplied by the threshold value for this event type, then the event status is *Fail*.
- If the event loss is “in between”, since it is not possible to know exactly the weight of a sub-event in the merged event, the global event is considered to have a status of *Pass*.

Pass/Fail Analysis

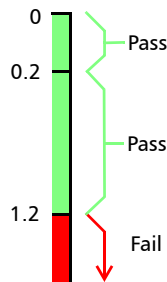

Fail Level

$$\begin{aligned}
 &= \sum(N_{\text{sub}} \times Th_{\text{sub}}) \\
 &= (2 \times 0.5) + (1 \times 0.2) \\
 &= 1.2
 \end{aligned}$$

If the merged event loss is smaller than or equal to 1.2, then the status is *Pass*. Otherwise, it is *Fail*.

Description of Event Types

Merged Event

Not All Event Types Are Tested

In this situation, the only thing that we can clearly know is when the loss has a *Pass* status. If the global event loss is less than or equal to the smallest threshold value (a value that is tested, of course), we are sure that the merged event status is *Pass*. Otherwise, we cannot know, so the status of the event is *Unknown*.

In our example, if we suppose that you chose not to test non-reflective losses, then the analysis would be done as shown below:

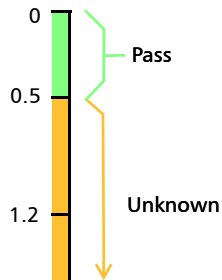

Effect of Event Status in the Global Trace Status

- A trace status is, by default, set to *Unknown*.
- If a trace is set to *Fail* once, it remains with that status (it cannot be set back to *Pass* or *Unknown*).
- Whenever an event status is *Fail*, so is the trace status.
- If an event status is *Pass*, the trace status can change from *Unknown* to *Pass*.
- If an event status is *Unknown*, the trace status remains the same. In other words, the event, in this case, has no influence on the trace status.

To avoid *Unknown* statuses, do not unselect loss thresholds individually.

Description of Event Types

Echo

Echo Π_{nr}

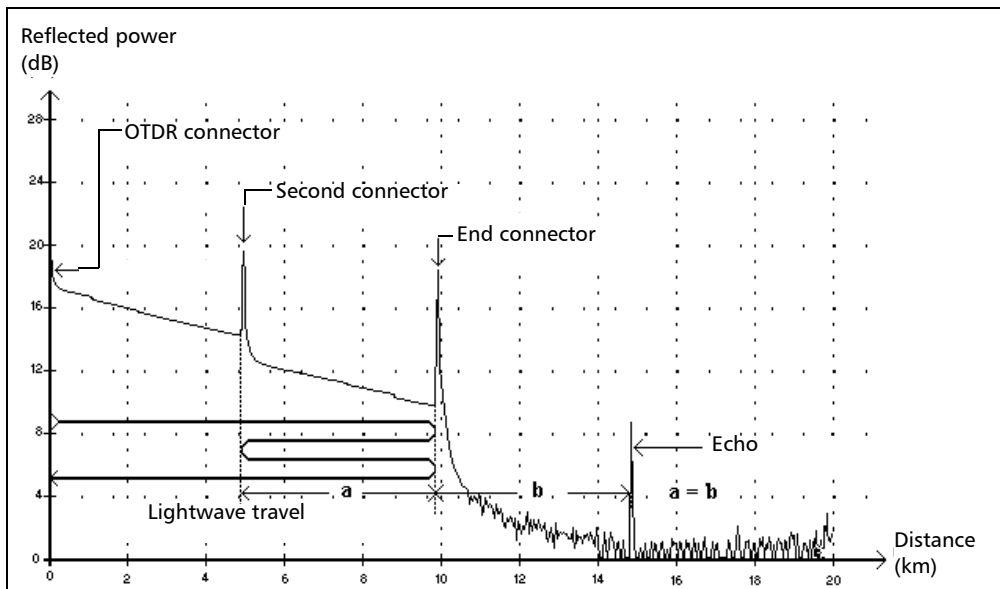

This symbol indicates that a reflective event has been detected after the end of the fiber.

- In the example above, the launched pulse travels up to the end connector and is reflected back toward the OTDR. Then, it reaches the second connector and is reflected again toward the end connector. It is then reflected back to the OTDR.
- The application interprets this new reflection as an echo because of its characteristics (reflectance and particular position with respect to other reflections).
- The distance between the second connector reflection and the end connector reflection is equal to the distance between the end connector reflection and the echo.
- There is no loss specified for echo events.

Reflective Event (Possible Echo)

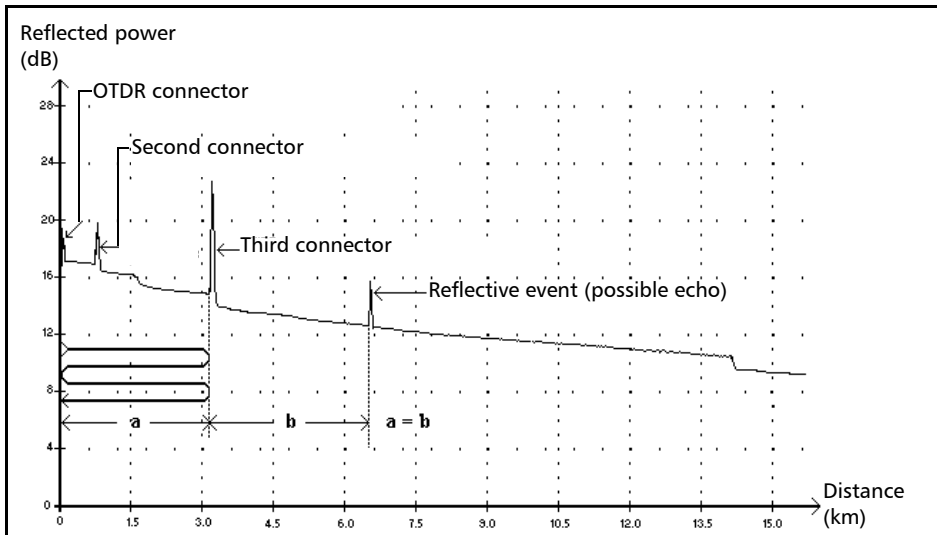

This symbol indicates a reflective event that can be a real reflection or an echo produced by another stronger reflection located closer to the source.

- In the example above, the launched pulse hits the third connector, is reflected back to the OTDR and reflected again into the fiber. It then reaches the third connector a second time and is reflected once more to the OTDR.

The application would therefore detect a reflective event located at twice the distance of the third connector. Since this event is almost null (no loss), and since its distance is a multiple of the third connector distance, the application would interpret it as a possible echo.

- A reflectance value is specified for reflective events (possible echo).

Coupler

This symbol indicates that the event is a coupler port.

A coupler port is an optical fiber device with one or more input fibers and one or several output fibers. This device is associated with a minimum loss value; for example, a 1 1x2 coupler has a loss of 3 dB. The coupler port is also used to represent wavelength filters such as MUX, DEMUX and ODAM.

Any event can be set as a coupler port in the application. However, once an event is set as a coupler port, its loss threshold cannot be applied anymore, but its loss is taken into account in the total loss value.

If you are using a CWDM or DWDM OTDR, the OTDR analysis automatically sets the span start and span end events as coupler ports if their losses are greater than 1.2 dB.

Index

- indication 173
 - * 124, 148, 151, 153
 - # 26
- A**
- A-B LSA loss, method 174
 - acquiring traces
 - sequentially with a CWDM module..... 73
 - sequentially with a DWDM module 63
 - with a standard OTDR..... 81
 - acquisition
 - analysis detection thresholds..... 39, 42
 - automated sequence 53, 54
 - by wavelength 93
 - changing resolution..... 94
 - distance range values 104, 105
 - interrupting 79
 - real-time mode 96
 - time selection 94, 95, 106
 - wavelength used 142
 - activating
 - automated acquisition sequence 53, 54
 - automated file saving 115
 - automated report creation 185
 - automated storage of the files 116
 - real-time mode 96
 - adding
 - favorite channels 60, 70
 - information to the results..... 179, 180
 - after-sales service 199
 - allowing template measurements 138
 - analysis
 - after acquisition..... 158
 - fiber span 159
 - thresholds, detection 39, 42
 - thresholds, pass/fail 49
 - analyzing a trace. *see* analysis, after acquisition
 - applying acquisition settings 93
 - attenuation
 - column in table of events..... 124
 - fiber-section thresholds 49
 - high values..... 78
 - reflectance 171
 - value 174, 175
 - automated
 - acquisition sequence..... 53, 54
 - file saving..... 115
 - report creation 185
 - storage of the files 116
 - automatic
 - acquisition parameters..... 85
 - event distance measurement 169
 - zoom on event 134
 - autonaming feature 26, 28
- B**
- background color 99
 - basic OTDR theory 9
 - Bellcore (.sor) format..... 27, 63, 73, 113, 114
177
 - buttons, zoom. *see* controls, zoom
- C**
- caution
 - of personal hazard 11
 - of product hazard 11
 - changing
 - default file format..... 113, 114
 - default folder 112
 - default name 26
 - default view 110, 111
 - distance units..... 102, 103

Index

- trace display mode 108
- trace display scale 132
- channel
 - filter selection 68
 - spacing selection 58
 - wavelength selection 59, 69
- characterizing the first connector 89
- cleaning
 - EUI connectors 192
 - fiber ends 24
 - front panel 191
- closing reference measurement 140
- color
 - of background 99
 - of displayed trace 136
 - of the trace, modifying manually 109
- comments inserted manually 123, 127, 156
157
- complete view 134
- condensed screen 130, 131
- configuring automatic file naming 28
- connector loss, thresholds 49
- connectors, cleaning 192
- controls, zoom 132
- conventions, safety 11
- creating zoom area 133
- cumulative loss
 - in table of events 125
 - value 89
- current
 - measurement settings 141
 - trace 136
- customer service 203
- customizing
 - distance range values 104, 105
 - graph display parameters 99, 100
 - reports 181, 183
 - table of events 99, 100
 - test results 179, 180
 - time values 106, 107
 - trace colors 109

- CWDM OTDR
 - adding favorite channels 70
 - channel filter selection 68
 - channel selection 69
 - dark fiber 78
 - definition 1, 67
 - displaying favorite channels 72
 - dynamic range 78
 - electronic noise 78
 - live-fiber testing 78
 - macro bend detection 75
 - main features 67
 - mux/demux channels 78
 - removing favorite channels 71
 - residual light 78

D

- dark fiber 65, 78
- data post-processing 8
- deactivating
 - automated acquisition sequence 53, 54
 - automated file saving 115
 - automated storage of the files 116
 - real-time mode 98
- decrementing name 26
- default
 - file folder 84, 112
 - file format 113, 114
 - trace name 26
 - view 110, 111
- defining
 - fiber span start 89
 - launch and receive fibers 89, 90
 - report content 183
 - zoom area 133
- definition
 - CWDM OTDR 1
 - DWDM OTDR 1
 - standard OTDR 1

-
- deleting
 - comments..... 156, 157
 - events..... 154, 155
 - delimiting fiber span 37, 101
 - delta loss value..... 45, 75
 - description, event types 205
 - detecting
 - macrobends, CWDM module..... 75
 - reflective events..... 162, 164
 - detection thresholds
 - for end of fiber 141, 142
 - for reflectance 141, 142
 - for splice loss..... 141, 142
 - disabling
 - automated acquisition sequence 53, 54
 - automated file saving 115
 - automated storage of the files 116
 - first connector check 92
 - reflective ends of fiber detection . 162, 164
 - disappearing marker 168
 - display modes 130, 131
 - displaying
 - complete view 134
 - favorite channels 62, 72
 - fiber sections 101
 - graph in condensed screen..... 130, 131
 - graph in full screen..... 130, 131
 - graph in split screen 130, 131
 - linear view 128
 - Measure tab 129
 - Summary tab..... 122
 - tooltip..... 123, 157
 - traces..... 108, 136
 - distance
 - equation 9
 - range selection 83, 94, 95, 98
 - range values 104, 105
 - units 102
 - DWDM OTDR
 - adding favorite channels 60
 - channel selection 59
 - channel spacing selection 58
 - dark fiber 65
 - definition 1, 57
 - displaying favorite channels..... 62
 - dynamic range 65
 - electronic noise 65
 - live-fiber testing..... 65
 - main features..... 57
 - mux/demux channels 65
 - removing favorite channels..... 61
 - residual light..... 65
 - dynamic range..... 65, 78, 120
- E**
- electrical safety information 22
 - electronic noise 65, 78
 - enabling
 - automated acquisition sequence 53, 54
 - automated file saving 115
 - automated storage of the files..... 116
 - first connector check..... 92
 - reflective ends of fiber detection . 162, 164
 - end-of-fiber
 - detection thresholds 39, 141, 142, 164
 - event..... 79, 206
 - equation of distance..... 9
 - equipment returns..... 203
 - EUI
 - connector adapter 23
 - connectors, cleaning..... 192
 - dust cap..... 23
 - event
 - attenuation..... 124
 - cumulative loss 125
 - deleting 154, 155
 - distance measurement..... 169, 170
 - effect of setting as span start/end..... 161
 - inserting with four markers..... 149, 152
 - inserting with one marker..... 149, 150
 - length in table of events 124
 - location..... 125
 - marking fault in table of events 49

Index

- merged 149, 154
- modification 146, 147
- name, displaying 123
- number in table of events 124
- number one 89
- reflectance 124
- threshold, pass/fail 49
- unchangeable 146
- undeletable 154
- zooming automatically 134
- event loss
 - in table of events 124
 - measurement 171, 172
- event types
 - description 205
 - continuous fiber 207
 - coupler 222
 - echo 220
 - end of analysis 208
 - end of fiber 206
 - fiber section 213
 - launch level 212
 - merged event 214
 - non-reflective event 209
 - positive event 211
 - reflective event 210
 - reflective event (possible echo) 221
 - short fiber 206
 - span end 206
 - span start 206
- Events tab 123
- events, description of types 205
- excluding span start and span end 37

- F**
- fail status 119, 121, 126
- fault, marking in table of events 49
- favorite channels
 - adding 60, 70
 - displaying 62, 72
- managing 60, 70
- removing 61, 71
- fiber
 - attenuation 124
 - attenuation threshold for section 49
 - dark 65, 78
 - identifying by name 26, 84
 - sections displayed/hidden 101
 - setting default values 32
 - water peak 78
- fiber ends, cleaning 24
- fiber settings
 - index of refraction (IOR) 141
 - Rayleigh backscatter coefficient (RBS) .. 141
- fiber span
 - analysis 159
 - delimitation 101
 - end 89
 - start 89
- file name
 - configuration 28
 - confirmation 115
 - decrementing 26
 - incrementing 26
 - order of appearance 30
 - preview 30
 - separator 30
- file. see trace
- files
 - opening in Bellcore format 177
 - opening in native format 177
 - saving in another format 177
 - saving in Bellcore format ... 27, 63, 73, 113
114, 177
 - saving in native format 27, 63, 73, 113
114, 177
- first connector check, feature 81, 92
- flagging failed events 49
- four-point event loss calculation 171
- Fresnel reflection 10
- front panel, cleaning 191
- full screen, graph 130, 131

- G**
- generating a report
 - automated acquisition sequence 54
 - automatically 185
 - manually 185
 - PDF or XML format 181, 183
 - getting
 - attenuation 174, 175
 - event distance automatically 169
 - event distance manually 170
 - event loss 171, 172
 - maximum reflectance 171, 172
 - optical return loss (ORL) 176
 - relative powers automatically 169
 - relative powers manually 170
 - section loss 174, 175
 - global status
 - in reports 181
 - in Summary tab 119
 - graph
 - background 99
 - condensed screen 130, 131
 - displayed in report 181
 - full screen 130, 131
 - overview window 99
 - split screen 130, 131
 - view 118
 - viewing portions 133
 - grid display 99
- H**
- helix factor
 - definition 33
 - modification 141
 - parameter 141, 142
 - setting 32, 34, 81
 - help icon 199
 - help. see online user guide
- I**
- hiding
 - fiber sections 101
 - traces 136
 - high attenuation, values 78
- I**
- icon
 - fail 126
 - macrobend 127
 - pass 126
 - span 127
 - identification label 199
 - including span start and span end 37
 - incrementing name 26
 - injection level 84, 92, 119
 - inserting
 - comments 156
 - events with four markers 149, 152
 - events with one marker 149, 150
 - IOR
 - definition 32
 - modification 141
 - setting 32, 34, 81
 - value 142, 144
 - ITU-T grid 57, 59, 67, 69
- L**
- label, identification 199
 - laser, using OTDR as source 187
 - last connector 89
 - launch fiber length 89
 - least-square approximation (LSA) 171, 174
 - length
 - in table of events 124
 - of the launch fiber 89
 - level of injection 92
 - linear view 126, 128
 - live-fiber
 - power value, definition 120
 - testing 65, 78
 - locating events 125

Index

- locking distance between markers 167
- loss
 - connector, threshold 49
 - in table of events 124
 - modification 146
 - on event 171, 172
 - span, threshold 49
 - splice, threshold 49
 - splitter, threshold 49

- M**
- macrobend
 - detection 45
 - detection, CWDM module 75
 - displayed in report 182
 - icon 127
 - in Summary tab 122
 - parameters settings 45, 46
- main
 - features, CWDM OTDR 67
 - features, DWDM OTDR 57
 - window, OTDR 7
- maintenance
 - EUI connectors 192
 - front panel 191
 - general information 191
- managing
 - comments 156, 157
 - events deleting 154, 155
 - events inserted with four markers 149
 - 152
 - events inserted with one marker 149
 - 150
 - events modifying 146
 - favorite channels 60, 70
- manual event distance measurement 170
- markers
 - behavior when opening traces 165
 - disappearing on zoom 168
 - location 147
 - on a trace 129
- maximum reflectance 171, 172
- Measure tab 129
- measurement
 - event loss 171, 172
 - method 171, 172
 - opening file 166
 - settings 141, 143
 - units 102
- merging two events 149, 154
- method of measurement
 - four-point event loss 171
 - least-square approximation 171, 174
 - two-point 174
- modifying
 - acquisition time ... 83, 94, 95, 98, 106, 107
 - comments 156, 157
 - current measurement settings 141
 - default file format 113, 114
 - default folder 112
 - default view 110, 111
 - distance range 83, 94, 95, 98, 104, 105
 - distance units 102
 - events 146, 147
 - helix factor 32, 34, 81, 141
 - IOR 32, 34, 81, 141
 - measurement settings 143
 - pulse width 83, 94, 95, 98
 - RBS coefficient 32, 34, 81, 141
 - trace colors 109
 - trace display mode 108
- modulation 189
- monitoring fibers in real-time mode 96
- mounting EUI connector adapter 23
- moving a marker
 - from the graph 167
 - with the arrows 168
- multimode port 3, 4, 5, 81, 187
- multiwavelength trace file displaying 136
- mux/demux channels 65, 78

- N**
- naming trace automatically..... 26, 84
 - native (.trc) format .. 27, 63, 73, 113, 114, 177
 - navigating between display modes ... 130, 131
 - noise detected on a trace 162
 - non-reflective events 142
 - number
 - in table of events 124
 - of digits displayed 26
- O**
- online user guide..... 199
 - opening
 - files in Bellcore format..... 177
 - files in native format..... 177
 - measurement file..... 166
 - trace file 165
 - traces, markers behavior..... 165
 - traces, zoom behavior 165
 - OPM port 5
 - optical return loss. *see* ORL
 - order of appearance in file name 30
 - ORL
 - parameter..... 37, 176
 - thresholds..... 49
 - OTDR
 - basic theory 9
 - definition 1
 - internal components..... 10
 - main window 7
 - ports..... 2, 3, 4, 5, 6, 53, 81, 187
 - selecting a port..... 54
 - using as laser source..... 187
- P**
- parameters
 - acquisition time 83, 94, 95, 98
 - automated acquisition sequence 53, 54
 - distance range 83, 94, 95, 98
 - first connector check 81, 92
 - helix factor 32, 34, 81
 - IOR..... 32, 34, 81
 - pulse width..... 83, 94, 95, 98
 - Rayleigh backscatter coefficient. 32, 34, 81
 - trace display..... 99
 - pass status..... 119, 126
 - pass/fail threshold parameters..... 49, 50
 - PDF format for reports..... 181
 - PDF. *see* online user guide
 - performing
 - live-fiber testing 65, 78
 - pass/fail tests 49
 - port selection 54
 - portion of the graph
 - displayed..... 133
 - magnified 99
 - positioning markers..... 129, 147, 173
 - post-processing data 8
 - preview of the file name..... 30
 - product
 - identification label 199
 - specifications 11
 - pulse width selection..... 79, 83, 94, 95, 98
- R**
- Rayleigh backscatter
 - description 10, 32
 - modification 141
 - parameter 142, 171
 - setting 32, 34, 81
 - real-time mode
 - deactivation 98
 - performing acquisitions 96
 - reanalyzing traces..... 158
 - receive fiber length..... 89
 - red triangle next to event number..... 123, 127
156, 157
 - reference
 - closing measurement in memory 140
 - trace 136

Index

- reflectance
 - attenuation..... 171
 - column in table of events 124
 - modification 146
 - of event 124
 - of non-reflective events 173
 - source of inaccurate measurements 35
 - thresholds..... 39, 49, 141, 142
- reflective
 - ends of fiber, detection 162, 164
 - events detection 142, 162
- regulatory information vii
- relative powers..... 169, 170
- removing favorite channels 61, 71
- report
 - defining content..... 183
 - generated automatically 185
 - generated manually 185
- residual light 65, 78, 120
- return merchandise authorization (RMA) .. 203
- reverting to the complete view 134

S

- safety
 - caution 11
 - conventions 11
 - warning 11
- saving files
 - automatically..... 115
 - in another format 177
 - in Bellcore format 27, 63, 73, 113, 114, 177
 - in native format..... 27, 63, 73, 113, 114, 177
- section loss..... 174, 175
- selecting
 - channel..... 59, 69
 - channel filter 68
 - channel spacing..... 58
 - default file format 113, 114
 - default view..... 110, 111

- distance units..... 102, 103
- modulation 189
- port..... 54
- trace display mode..... 108
- wavelength 54, 83, 98, 188
- separator used in file name 30
- sequential acquisitions 63, 73
- service and repairs 203
- service centers 204
- setting
 - acquisition time 94, 95
 - analysis detection thresholds 39, 42
 - automated acquisition sequence 53, 54
 - automatic acquisition parameters..... 85
 - current trace as a reference 139
 - default storage folder 112
 - distance range 94, 95
 - first connector check..... 81, 92
 - graph display parameters 99, 100
 - helix factor 32, 34, 81
 - IOR..... 32, 34, 81
 - launch and receive fibers 90
 - macroband parameters..... 45, 46, 75
 - pass/fail thresholds 49, 50
 - pulse width 94, 95
 - RBS coefficient 32, 34, 81
 - table of events 99, 100
 - trace as templates..... 137
- shipping to EXFO..... 203
- signal-to-noise ratio 79, 94, 106
- singlemode
 - live port 2, 5, 53, 81, 187
 - OTDR port..... 2, 3, 4, 5, 6, 53, 81, 187
- software options 8
- source
 - performing measurements..... 187
 - selecting modulation 189
- span
 - length, thresholds..... 49
 - loss, thresholds 49
 - ORL, thresholds..... 49
 - position, updating 159

- span end
 - description..... 206
 - effect of setting on table of events..... 161
 - icon 127
 - including or excluding 37
 - position 89
 - viewing in table of events 135
 - span start
 - description..... 206
 - effect of setting on table of events..... 161
 - icon 127
 - including or excluding 37
 - position 89
 - viewing in table of events 135
 - specifications, product 11
 - splice loss, detection thresholds.... 39, 49, 141
142
 - split screen, graph..... 130, 131
 - splitter loss, detection thresholds..... 39, 49
 - standard OTDR, definition 1
 - starting tests 7
 - status
 - fail 119, 121, 126
 - pass 119, 126
 - unknown 119
 - stopping trace acquisition..... 79
 - storage requirements 191
 - storing
 - files automatically..... 116
 - trace autonaming 26, 84
 - Summary tab..... 119, 122
 - switching
 - between traces 136
 - between views..... 130, 131
 - symbols, safety..... 11
- T**
- tab
 - Events 123
 - Measure..... 129
 - Summary 119
 - technical specifications 11
 - technical support..... 199
 - temperature for storage 191
 - template traces..... 137, 138
 - testing channels sequentially..... 63, 73
 - theory, OTDR 9
 - thresholds
 - analysis detection 39, 42
 - connector loss..... 49
 - end-of-fiber detection..... 39, 141, 142
 - fiber-section attenuation 49
 - ORL 49
 - reflectance detection 39, 49, 141, 142
 - span length..... 49
 - span loss..... 49
 - splice loss..... 39, 49, 141, 142
 - splitter loss..... 49
 - splitter loss detection..... 39
 - trace analysis 49
 - time values 107
 - tooltip 123, 157
 - trace
 - acquisition 81
 - analysis 158
 - analysis detection thresholds 39, 42
 - changing default name..... 26
 - colors 109
 - current 136
 - defining content in report..... 183
 - formats 177
 - opening file..... 165
 - pass/fail analysis threshold..... 49
 - reanalysis 158
 - reference..... 136
 - stopping the acquisition 79
 - trace display
 - behavior on zoom..... 132
 - graph 118
 - mode 108
 - parameter 99
 - scale..... 132

Index

transportation requirements 191, 200
two-point method..... 174

U

unchangeable events 146
undeletable events 154
unknown status 119
unlocking distance between markers 167
UPC connectors 162
updating span position 159
USB device 112
user guide. see online user guide
using
 markers..... 167
 OTDR as a source 187
 zoom controls..... 132

V

viewing
 changes on fiber link 96
 condensed screen 130, 131
 current measurement settings 141
 default view 110, 111
 Events tab 123
 full-screen 130, 131
 graph 118
 linear view 126
 macrobends in Summary tab 122
 Measure tab 129
 measurement settings 143
 portions of the graph 133
 span start and span end 135
 split screen 130, 131
 Summary tab 119
visible portions of the graph 133
visual fault locator (VFL) port 3, 4

W

warranty
 certification 202
 exclusions 202
 general 201
 liability 202
 null and void 201
wavelength selection 54, 83, 98, 188
working
 with templates traces 137, 138
 with the CWDM OTDR 67
 with the DWDM OTDR 57

X

XML format for reports 181

Z

zoom
 area 133
 behavior when opening traces 165
 controls 132
zooming automatically on event 134

CHINESE REGULATION ON RESTRICTION OF HAZARDOUS SUBSTANCES (RoHS)

中国关于有害物质限制的规定

NAMES AND CONTENTS OF THE TOXIC OR HAZARDOUS SUBSTANCES OR ELEMENTS
CONTAINED IN THIS EXFO PRODUCT

包含在本 EXFO 产品中的有毒有害物质或元素的名称及含量

Part Name 部件名称	Lead 铅 (Pb)	Mercury 汞 (Hg)	Cadmium 镉 (Cd)	Hexavalent Chromium 六价铬 (Cr(VI))	Polybrominated biphenyls 多溴联苯 (PBB)	Polybrominated diphenyl ethers 多溴二苯醚 (PBDE)
Enclosure 外壳	O	O	O	O	O	O
Electronic and electrical sub-assembly 电子和电气组件	X	O	X	O	X	X
Optical sub-assembly ^a 光学组件 ^a	X	O	O	O	O	O
Mechanical sub-assembly ^a 机械组件 ^a	O	O	O	O	O	O

Note:

注:

This table is prepared in accordance with the provisions of SJ/T 11364.

本表依据 SJ/T 11364 的规定编制。

O: Indicates that said hazardous substance contained in all of the homogeneous materials for this part is below the limit requirement of GB/T 26572.

O: 表示该有害物质在该部件所有均质材料中的含量均在 GB/T 26572 标准规定的限量要求以下。

X: indicates that said hazardous substance contained in at least one of the homogeneous materials used for this part is above the limit requirement of GB/T 26572. Due to the limitations in current technologies, parts with the "X" mark cannot eliminate hazardous substances.



X: 表示该有害物质至少在该部件的某一均质材料中的含量超出 GB/T 26572 标准规定的限量要求。

标记 "X" 的部件, 皆因全球技术发展水平限制而无法实现有害物质的替代。

a. If applicable.

如果适用。

MARKING REQUIREMENTS
标注要求

Product 产品	Environmental protection use period (years) 环境保护使用期限 (年)	Logo 标志
This EXFO product 本 EXFO 产品	10	
Battery ^a 电池	5	

a. If applicable.
如果适用。

P/N: 1078686

www.EXFO.com · info@EXFO.com

CORPORATE HEADQUARTERS 400 Godin Avenue

Quebec (Quebec) G1M 2K2 CANADA
Tel.: 1 418 683-0211 · Fax: 1 418 683-2170

TOLL-FREE (USA and Canada)

1 800 663-3936

© 2019 EXFO Inc. All rights reserved.
Printed in Canada (2019-12)

The logo for EXFO, featuring the letters 'EXFO' in a bold, blue, sans-serif font. The letters are composed of horizontal lines, giving it a modern, digital appearance.