

WARNING

Death, serious injury, or fire hazard could result from improper connection of this instrument. Read and understand this manual before connecting this instrument. Follow all installation and operating instructions while using this instrument.

Connection of this instrument must be performed in compliance with the National Electrical Code (ANSI/NFPA 70-1996) of USA and any additional safety requirements applicable to your installation.

Installation, operation, and maintenance of this instrument must be performed by qualified personnel only. The National Electrical Code defines a qualified person as one familiar with the construction and operation of the equipment and the hazards involved.

Power Platform[®] PP1 & PP1E

TASKCard[®] - PQPLUS

OPERATOR'S MANUAL

Revision A

April 15, 1997



DRANETZ-BMI
1000 New Durham Road
Edison, New Jersey 08818-4019

Part Number OM-PP1-TASK-PQPLUS

ADVERTENCIA

Una conexión incorrecta de este instrumento puede producir la muerte, lesiones graves y riesgo de incendio. Lea y entienda este manual antes de conectar. Observe todas las instrucciones de instalación y operación durante el uso de este instrumento.

La conexión de este instrumento debe ser hecha de acuerdo con las normas del Código Eléctrico Nacional (ANSI/NFPA 70-1996) de EE. UU., además de cualquier otra norma de seguridad correspondiente a su establecimiento.

La instalación, operación y mantenimiento de este instrumento debe ser realizada por personal calificado solamente. El Código Eléctrico Nacional define a una persona calificada como "una que esté familiarizada con la construcción y operación del equipo y con los riesgos involucrados."

AVERTISSEMENT

Si l'instrument est mal connecté, la mort, des blessures graves, ou un danger d'incendie peuvent s'en suivre. Lisez attentivement ce manuel avant de connecter l'instrument. Lorsque vous utilisez l'instrument, suivez toutes les instructions d'installation et de service.

Cet instrument doit être connecté conformément au National Electrical Code (ANSI/NFPA 70-1996) des Etats-Unis et à toutes les exigences de sécurité applicables à votre installation.

Cet instrument doit être installé, utilisé et entretenu uniquement par un personnel qualifié. Selon le National Electrical Code, une personne est qualifiée si "elle connaît bien la construction et l'utilisation de l'équipement, ainsi que les dangers que cela implique".

WARNUNG

Der falsche Anschluß dieses Gerätes kann Tod, schwere Verletzungen oder Feuer verursachen. Bevor Sie dieses Instrument anschließen, müssen Sie die Anleitung lesen und verstanden haben. Bei der Verwendung dieses Instruments müssen alle Installation- und Betriebsanweisungen beachtet werden.

Der Anschluß dieses Instruments muß in Übereinstimmung mit den nationalen Bestimmungen für Elektrizität (ANSI/NFPA 70-1996) der Vereinigten Staaten, sowie allen weiteren, in Ihrem Fall anwendbaren Sicherheitsbestimmungen, vorgenommen werden.

Installation, Betrieb und Wartung dieses Instruments dürfen nur von Fachpersonal durchgeführt werden. In dem nationalen Bestimmungen für Elektrizität wird ein Fachmann als eine Person bezeichnet, welche "mit der Bauweise und dem Betrieb des Gerätes sowie den dazugehörigen Gefahren vertraut ist."

Safety Summary

Definitions WARNING statements inform the user that certain conditions or practices could result in loss of life or physical harm.

CAUTION statements identify conditions or practices that could harm the Power Platform, its data, other equipment, or property.

NOTE statements call attention to specific information.

Symbols The following International Electrotechnical Commission (IEC) symbols are marked on the top and rear panel in the immediate vicinity of the referenced terminal or device:



Caution, refer to accompanying documents (this manual).



Alternating current (ac) operation of the terminal or device.



Direct current (DC) operation of the terminal or device.



Symbol preceding a fuse rating indicates the fuse is a time delay (slow-blow) type. Example: T10A = time-delay, 10 Ampere fuse.

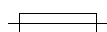

Fuse WARNING notice.



Protective conductor terminal.



Power Switch.

Definiciones Las ADVERTENCIAS informan al usuario de ciertas condiciones o prácticas que podrían producir lesiones mortales o daño físico.

Las PRECAUCIONES identifican condiciones o prácticas que podrían dañar la Power Platform, sus datos, otros equipos o propiedad.

Las NOTAS llaman la atención hacia la información específica.

Continued on next page

Safety Summary, Continued

Símbolos

Los siguientes símbolos de la Comisión Internacional Electrotécnica (IEC) aparecen marcados en el panel superior y el posterior inmediatos al terminal o dispositivo en referencia:



Precaución, consulte los documentos adjuntos (este manual).



Operación de corriente alterna (ca) del terminal o dispositivo.



Operación de corriente continua (CC) del terminal o dispositivo.

T

El símbolo que precede la capacidad nominal de un fusible indica que se trata de un fusible con retardo de tiempo (fundido lento).
Ejemplo: T10A = fusible con retardo de tiempo, 10 Amperios.

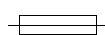

ADVERTENCIA de fusible.



Terminal de protección del conductor.



Interruptor de encendido.

Définitions

Les messages d'AVERTISSEMENT préviennent l'utilisateur que certaines conditions ou pratiques pourraient entraîner la mort ou des lésions corporelles.

Les messages de MISE EN GARDE signalent des conditions ou pratiques susceptibles d'endommager "Power Platform", ses données, d'autres équipements ou biens matériels.

Les messages NOTA attirent l'attention sur certains renseignements spécifiques.

Continued on next page

Safety Summary, Continued

Symboles

Les symboles suivants de la Commission électrotechnique internationale (CEI) figurent sur le panneau arrière supérieur situé à proximité du terminal ou de l'unité cité:



Mise en garde, consultez les documents d'accompagnement (ce manual).



Fonctionnement du terminal ou du dispositif sur le courant alternatif (c.a.).



Fonctionnement du terminal ou de l'unité en courant continu (CC).

T

Symbole précédant la valeur nominale d'un fusible et indiquant que le fusible est du type à temporisation (fusible à action retardée).
Exemple : T10A = fusible de 10 ampères à temporisation.

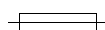

AVERTISSEMENT sur les fusibles.



Borne conductrice de protection.



Interrupteur de tension.

Definitionen

WARNUNGEN informieren den Benutzer darüber, daß bestimmte Bedingungen oder Vorgehensweisen körperliche oder tödliche Verletzungen zur Folge haben können.

VORSICHTSHINWEISE kennzeichnen Bedingungen oder Vorgehensweisen, die zu einer Beschädigung von Power Platform, seiner Daten oder anderer Geräte bzw. von Eigentum führen können.

HINWEISE machen auf bestimmte Informationen aufmerksam.

Continued on next page

Safety Summary, Continued

Symbole

Die folgenden Symbole der Internationalen Elektrotechnischen Kommission (International Electrotechnical Commission; IEC) befinden sich auf der Abdeck- und Seitenplatte unmittelbar am betreffenden Terminal oder Gerät.



Vorsichtshinweis, siehe Begleitdokumente (dieses Handbuch).



Wechselstrombetrieb des Terminals bzw. Geräts.



Gleichstrombetrieb im Terminal oder Gerät.

T

Dieses Symbol vor einem Sicherungswert weist darauf hin, daß es sich um eine Sicherung mit Zeitverzögerung (Trägsicherung) handelt. Beispiel: T10A = Trägsicherung mit 10 Ampere.

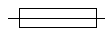

WARNHINWEIS Sicherung.



Terminal-Schutzleiter.



Netzschalter.

Safety Summary, Continued

Safety precautions

The following safety precautions must be followed whenever any type of connection is being made to the instrument.

- Connect the green safety (earth) ground first, before making any other connections.
- When connecting to electric circuits or pulse initiating equipment, open their related breakers. DO NOT install any connection of the instrument on live power lines.
- Connections must be made to the instrument first, then connect to the circuit to be monitored.
- Wear safety glasses and insulated gloves when making connections to power circuits.
- Hands, shoes and floor must be dry when making any connection to a power line.
- Make sure the unit is turned OFF before connecting probes to the rear panel.
- Before each use, inspect all cables for breaks or cracks in the insulation. Replace immediately if defective.

Medidas de seguridad

Las medidas de seguridad siguientes deberán observarse cuando se realice cualquier tipo de conexión al instrumento.

- Antes de hacer cualquier conexión, deberá enchufarse el conector de seguridad verde a tierra.
- Cuando se haga conexiones a circuitos eléctricos o a equipo de activación por pulso, deberá abrirse sus respectivas cajas de seguridad. NO deberá hacerse ninguna conexión del instrumento en líneas eléctricas bajo tensión.
- Las conexiones deberán hacerse primero al instrumento y, luego, al circuito a ser monitorizado.
- Al hacer conexiones a circuitos eléctricos, deberá utilizar anteojos y guantes protectores.
- Sus manos, zapatos y el piso deberán estar secos en todo momento en que se haga una conexión a un cable eléctrico.
- Verifique que la unidad esté DESACTIVADA antes de conectar sondas en el panel posterior.
- Previo a cada uso, deberá verificarse que los cables no estén rotos y que el material aislante no tenga rajaduras. Reemplace de inmediato cualquier parte defectuosa.

Mesures de Sécurité

Les mesures de sécurité suivantes doivent être prises chaque fois qu'un type de connexion quelconque est effectué sur l'instrument.

Continued on next page

Safety Summary, Continued

- Connecter d'abord la prise de terre de sécurité verte (terre) avant d'effectuer toute autre connexion.
 - Ouvrir les disjoncteurs correspondants lors d'une connexion à des circuits électriques ou à des équipement de génération d'impulsions. NE PAS effectuer de connexion d'instrument sur des lignes électriques sous tension.
 - Une fois toutes les connexions de l'instrument effectuées, connecter au circuit à contrôler.
 - Porter des lunettes de protection et des gants isolants pour effectuer des connexions aux circuits électriques.
 - S'assurer que les mains, les chaussures et le sol soient secs lors de connexions à une ligne électrique.
 - S'assurer que l'unité est ÉTEINTE avant de connecter les sondes au panneau arrière.
 - Inspecter tous les câbles, avant chaque utilisation, pour s'assurer que les isolants ne sont pas coupés ou fendus. Remplacer immédiatement tous les équipements défectueux.
-

Sicherheitsvorkehrungen

Die folgenden Sicherheitsvorkehrungen sind immer dann zu befolgen, wenn eine Verbindung zum Instrument hergestellt wird.

- Schließen Sie zuerst die grüne Sicherheits-/Erdleitung an, bevor Sie eine andere Verbindung herstellen.
 - Öffnen Sie beim Anschluß an elektrische Stromkreise oder Impulsauslösungseinrichtungen die entsprechenden Unterbrecher. Es dürfen KEINE Anschlüsse an das Instrument unter stromführenden Spannungsleitungen montiert werden.
 - Die Verbindungen müssen zuerst am Instrument und danach an der zu überwachenden Schaltung hergestellt werden.
 - Tragen Sie Schutzbrillen und Isolierhandschuhe, wenn Sie Anschlüsse an den Stromkreisen vornehmen.
 - Hände, Schuhe und Fußboden müssen trocken sein, wenn Sie Anschlüsse an den Stromkreisen durchführen.
 - Stellen Sie sicher, daß das Gerät AUSgeschaltet ist, bevor Sie an der rückwärtigen Konsole Meßfühler anschließen.
 - Prüfen Sie vor jedem Gebrauch alle Kabel auf Bruchstellen und Risse in der Isolierung. Wechseln Sie schadhafte Kabel sofort aus.
-

Change Status

Revisions

Original Issue: March 1, 1994.
 Change 1: April 15, 1994, ECOs 3294 and 3299.
 Change 2: April 1, 1995, ECO 3378 and ECR 3380-1.
 Change 3: November 25, 1996, ECO 3387.
 Revision A: April, 1997, ECO 3313 and 3437.

Revised Sections

Section	Change No.	Section	Change No.
Cover	A	Appendix A	A
Table of Contents	A	Appendix B	A
Chapter 1	A	Appendix C	A
Chapter 2	A	Appendix D	A
Chapter 3	A	Appendix E	A
Chapter 4	A	Appendix F	A
Chapter 5	A	Appendix G	2
Chapter 6	A	Appendix H	0
Chapter 7	A	Appendix I	A
Chapter 8	A	Appendix J	0
Chapter 9	A	Appendix K	A
Chapter 10	A	Glossary	A
Chapter 11	A	Index	A
Chapter 12	A		

Statements and Notices

Statement of warranty

All products of Dranetz-BMI are warranted to the original purchaser against defective material and workmanship for a period of one year from the date of delivery. Dranetz-BMI will repair or replace, at its option, all defective equipment that is returned, freight prepaid, during the warranty period. There will be no charge for repair provided there is no evidence that the equipment has been mishandled or abused. This warranty shall not apply to any defects resulting from improper or inadequate maintenance, buyer-supplied hardware/software interfacing, unauthorized modification or misuse of the equipment, operation outside of environmental specifications, or improper site preparation or maintenance.

Statement of reliability

The information in this manual has been reviewed and is believed to be entirely reliable, however, no responsibility is assumed for any inaccuracies. All material is for informational purposes only and is subject to change without prior notice.

Notice regarding FCC compliance

This device has been tested and found to comply with the limits for a Class A digital device, pursuant to Part 15 of the FCC Rules. These limits are designed to provide reasonable protection against harmful interference when the equipment is operated in a commercial environment. This equipment generates, uses, and can radiate radio frequency energy and, if not installed and used in accordance with the instruction manual, may cause harmful interference to radio communications. Operation of this equipment in a residential area is likely to cause harmful interference in which case the user will be required to correct the interference at his/her own expense.

Notice regarding proprietary rights

This publication contains information proprietary to Dranetz-BMI. By accepting and using this manual, you agree that the information contained herein will be used solely for the purpose of operating equipment of Dranetz-BMI.

Continued on next page

Statements and Notices, Continued

Copyright

This publication is protected under the Copyright laws of the United States, Title 17 et seq. No part of this publication may be reproduced, transmitted, transcribed, stored in a retrieval system, or translated into any language or computer language, in any form, by any means, electronic, mechanical, magnetic, optical, chemical, manual, or otherwise, without the prior written consent of Dranetz-BMI, 1000 New Durham Road, Edison, New Jersey 08818.

Copyright © 1997, Dranetz-BMI
All Rights Reserved. Printed in the United States of America.

Trademarks

Power Platform, TASKCard, and Scope Mode are registered trademarks of Dranetz-BMI.

Table of Contents

Safety Summary	iii
Change Status	ix
Statements and Notices	x
 CHAPTER 1 - Introduction	
Overview	1-1
Unpacking The Power Platform	1-3
Physical Description	1-4
Operational Description	1-6
 CHAPTER 2 - Easy Start	
Overview	2-1
Turning On the Power Platform	2-2
Changing the Tolerance for the Easy Start Setup	2-3
Using Easy Start	2-5
 CHAPTER 3 - Controls, Indicators, and Connectors	
Overview	3-1
Front Panel	3-2
Rear Panel	3-4
Positioning the Unit	3-8
 CHAPTER 4 - Getting Started	
Overview	4-1
Section A - Turn On Procedures	
Overview	4-2
Setting the Voltage Selector	4-3
Power Requirements	4-5
Installing a TASKCard	4-6
Turning the Unit On	4-7
Section B - Voltage and Current Cable Connections	
Overview	4-11
Connecting a Voltage Probe	4-15
Connecting to a Potential Transformer (PT)	4-20
Connecting a Current Probe	4-22
Connecting to a Current Transformer (CT)	4-26
Connecting to an Isolated Current Transformer (ISO)	4-28
Verifying Voltage and Current Connections	4-34
Section C - Circuit Diagrams for Power Measurements	
Overview	4-37
Single Phase	4-39

Table of Contents, Continued

Split Phase.....	4-40
Four Wire Wye	4-41
Floating Delta	4-42
Delta, One Leg Grounded.....	4-43
Open Leg Delta.....	4-44
High-Leg Delta	4-45
Phasor Diagrams for Standard Power Connections.....	4-46
Section D - Monitoring Setup Procedures	
Overview.....	4-49
Selecting and Activating a Setup	4-50
Reading Setups from a Memory Card	4-53
Turning On Monitoring	4-55
Section E - Scope and Meter Mode	
Overview.....	4-56
Viewing Scope Mode.....	4-57
Viewing Meter Mode.....	4-59
Viewing Voltage and Current Phasors.....	4-62
Viewing Voltage and Current Harmonics	4-63
CHAPTER 5 - Input Channels Setup	
Overview.....	5-1
Turning Input Channels On and Off.....	5-2
Selecting Your Circuit Type	5-4
About Scale Factors	5-6
Entering Scale Factors	5-7
About Frequency Synchronization	5-9
Selecting Sync Frequency.....	5-11
CHAPTER 6 - Custom Event Monitoring Setups	
Overview.....	6-1
Creating a Custom Event Monitoring Setup.....	6-3
Copying the Easy Start Setup	6-4
Viewing a Setup.....	6-6
Editing Parameter Thresholds.....	6-7
Setting Waveform Capture	6-12
Controlling Event Monitoring with the Digital Inputs	6-14
Making Digital Input Connections to the Rear Panel	6-15
Changing the Digital Inputs Configuration	6-17

Table of Contents, Continued

CHAPTER 7 - Housekeeping Functions

Overview.....	7-1
Entering a Site Name	7-2
Setting the Time and Date	7-4
Selecting the Language.....	7-6
Setting Error Message Output.....	7-7
Setting the Audible Alarm and LCD Mode	7-9
Clearing Memory	7-10
Resetting the Unit to the Factory Configuration.....	7-11
Running a Self-Test	7-15
Setting Memory Storage Mode.....	7-17
Setting Auto-transfer to Memory Card.....	7-18

CHAPTER 8 - Reports

Overview.....	8-1
Automatic Reports	8-2
Setting Automatic Reports.....	8-4
Selecting a Report Type.....	8-5
Making Relay Connections to the Rear Panel	8-8
Setting Relay #1	8-10

CHAPTER 9 - Viewing Time Plot Report

Overview.....	9-1
Viewing Analog Time Plots	9-2
Selecting a Parameter.....	9-4
Using Horizontal Zoom	9-5
Changing the Vertical Scale	9-7
Changing the Timed Interval Setting.....	9-9
Viewing Digital Time Plots	9-11

CHAPTER 10 - Viewing Events

Overview.....	10-1
Section A - Viewing Event Reports from Internal Memory	
Overview.....	10-3
Event Descriptions.....	10-5
Viewing the Individual Event Reports.....	10-9
Viewing Worst Case Events	10-16
Viewing Event Waveforms.....	10-18
Viewing Waveform Data	10-20
Viewing Event Details	10-21

Table of Contents, Continued

IEEE 1159 Classifications	10-22
Printing Event Reports.....	10-23
Section B - Viewing Events Recorded on Memory Cards	
Overview.....	10-25
Section C - Viewing Events Recorded in Auto-transfer Mode	
CHAPTER 11 - Transferring Data	
Overview.....	11-1
Connecting Local Devices to the RS232D Port.....	11-4
Connecting a Printer to the Parallel Port	11-10
Connecting Remote Devices to RS232D Port	11-14
Connecting Remote Devices to RJ-11C Jack (not available on PP1E)	11-20
Connecting to a Facsimile (Fax) Machine (not available on PP1E).....	11-25
Output Connected Device Configuration Test.....	11-28
Formatting a Memory Card	11-30
Writing to a Memory Card.....	11-31
CHAPTER 12 - Printer Operation	
Overview.....	12-1
Printer Controls.....	12-2
Normal Operation	12-5
Paper Replacement	12-7
APPENDIX A - Optional Accessories	
Optional Accessories List	A-2
Optional Accessories Descriptions	A-4
APPENDIX B - Repacking for Return Shipment	
APPENDIX C - Battery Specifications and Replacement Procedure	
Overview.....	C-1
Battery Specifications	C-2
Battery Pack Safety Precautions	C-3
Battery Pack Replacement	C-5
Memory Card Battery Replacement	C-6
APPENDIX D - Fuse Replacement	
Overview.....	D-1
Main Power Fuses.....	D-2
Battery Fuse	D-5

Table of Contents, Continued

APPENDIX E - Operator Replaceable Parts List

APPENDIX F - Technical Specifications

Overview.....	F-1
General.....	F-2
Interfaces.....	F-3
Measured Parameters.....	F-5
Computed Parameters.....	F-7
Current Probes.....	F-9
Isolated Current Transformer Boxes.....	F-10

APPENDIX G - Predefined Setups

Overview.....	G-1
Setup #1: Single-Phase 120 Volt w/Neutral to Ground.....	G-2
Setup #2: Single-Phase 208 Volt.....	G-3
Setup #3: Single-Phase 220 Volt.....	G-4
Setup #4: Split-Phase 120/240 Volt.....	G-5
Setup #5: 3-Phase Wye 120 Volt.....	G-6
Setup #6: 3-Phase Wye 120 Volt w/CT-10.....	G-7
Setup #7: 3-Phase Wye 277 Volt.....	G-8
Setup #8: 3-Phase Delta 240 Volt.....	G-9
Setup #9: 3-Phase Delta 480 Volt.....	G-10
Setup #10: Easy Start.....	G-11

APPENDIX H - PP1-PQPlus Messages

Overview.....	H-1
Message Types.....	H-2
Messages.....	H-3

APPENDIX I - Connecting an External DC Power Supply

Overview.....	I-1
Making and Connecting the DC Input Cable.....	I-3
External Battery Filter.....	I-6
Extension Cables.....	I-7
Installing the Battery Filter.....	I-8

APPENDIX J - PQPlus Menu Structure

Table of Contents, Continued

APPENDIX K - Internal Modem Commands

Command Codes.....	K-2
Register Access Codes.....	K-5

Glossary

Index

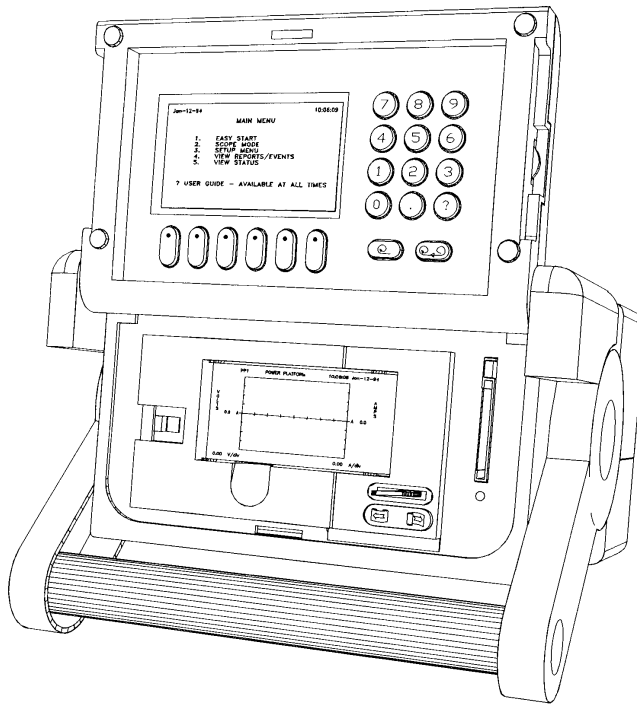

8600-37

Dranetz Power Platform, Models PP1 & PP1E.

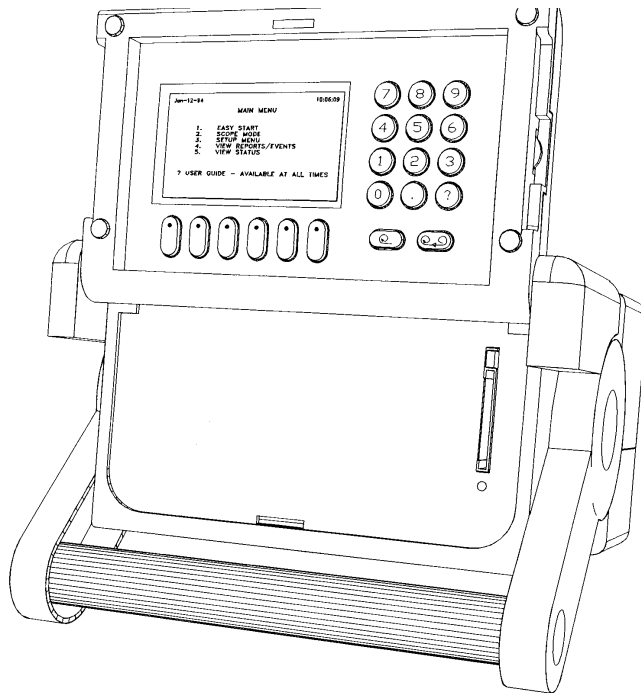

8600-46

Dranetz Power Platform, Models PP1 & PP1E, without printer.

Chapter 1

Introduction

Overview

Power Platform description The Dranetz-BMI Power Platform, Models PP1 & PP1E, shown with and without printer on the facing page, introduces a new concept in power monitoring equipment by allowing you to change the type of monitoring the unit does by changing a TASKCard.

TASKCard definition A TASKCard is a removable memory card that is installed in the rear panel of the Power Platform and contains an operating system that is designed for a specific application (task).

PQPlus TASKCard The PQPlus TASKCard, shown below, changes the Power Platform to a power quality monitor so that it can record sags, swells, transients, and outages, plus demand, energy and harmonics.

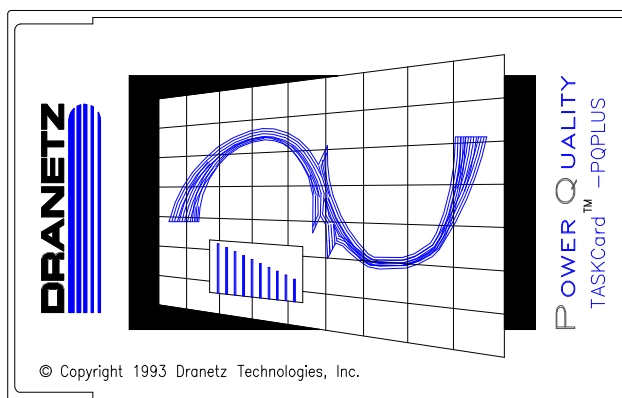

8600-43

Available TASKCards Each available TASKCard provides the Power Platform with different capabilities. Refer to the optional accessories list in Appendix A for a description of all available TASKCards.

Continued on next page

Overview, Continued

This manual This manual contains instructions for operating the Dranetz-BMI Power Platform, Model PP1 with or without the printer, with the PQPlus TASKCard installed.

Throughout this manual reference to the Power Platform will be made when hardware or other generic functions are being described. Where software functions are being referenced, the term PP1-PQPlus will be used.

Index An Index is provided at the rear of this manual to assist you in quickly finding related subject information.

Easy Start Chapter 2 provides you with the information needed to quickly and easily set up the Power Platform for monitoring.

In this chapter The following topics are covered in this chapter.

Topic	See Page
Unpacking The Power Platform	1-3
Physical Description	1-4
Operational Description	1-6

Unpacking The Power Platform

Introduction

For maximum protection against possible shipping damage, the Power Platform has been sealed in a two-piece, pre-molded urethane foam pack, enclosed within a durable shipping carton. After opening the carton, inspect the contents for possible shipping damage and check the carton inventory. Save the carton for possible return of the Power Platform.

Unpacking

Unpack the Power Platform from the carton as follows:

1. Remove any remaining literature inside the top of the carton.
 2. Carefully remove the Power Platform from its shipping carton.
 3. Remove all accessories inside the carton. Check that the standard accessories (See next page) are included.
 4. Place all of the shipping materials back into the carton, close its flaps, and store it away. **DO NOT** throw away the carton and packing materials. Save the carton and packing materials in case you have to return the Power Platform to Dranetz-BMI for maintenance, repair, or calibration.
-

Shipping damage inspection

Visually inspect the Power Platform for possible shipping damage. If any damage exists, first notify and file an insurance claim with your carrier or underwriter or both. Then notify Dranetz-BMI Customer Service Department (refer to the REPAIR/SERVICE ORDER form enclosed in this manual) of your intentions to return the unit. **DO NOT** return the Power Platform without prior instructions from Dranetz-BMI Customer Service Department, telephone 732-287-3680 or 1-800-372-6832.

Repacking for return shipment

If you have to return the Power Platform to Dranetz-BMI Customer Service Department, repack it in its original packing materials. Refer to the repacking instructions in Appendix B.

Physical Description

Dimensions The Dranetz-BMI Power Platform is a self-contained, portable instrument weighing less than 21 pounds and measuring 10" deep by 13" wide by 7" high.

Front panel The front panel, including screen, keypad, printer, and memory card is protected by a locking, flip-top type display housing. The padded bail handle can be used as a carrying handle or as a means to position the unit. See Chapter 3 for description of the front panel controls and indicators and how to position the Power Platform.

Rear panel The rear panel contains the input and output connectors including the slot for the TASKCard. See Chapter 3 for rear panel controls, indicators, and connectors.

Standard accessories The following table lists the Power Platform's standard accessories.

Part Number	Description
OM-PP1-TASK-PQPLUS	Operator's Manual
TASKCard-PQPLUS-E*	PQPlus TASKCard, English only
TASKCard-PQPLUS-F*	PQPlus TASKCard, French and English
TASKCard-PQPLUS-S*	PQPlus TASKCard, Spanish and English
115815-G1*	Measurement Cable Set (Domestic)
115815-G2*	Measurement Cable Set (Euro)
115815-G3*	Measurement Cable Set (UK)
115323-G1	Thermal Paper (4 rolls)
113218-G3	Terminal Block, 6 pin
113218-G4	Terminal Block, 8 pin
107506	Connector Plug, Battery
115520-G1	Wire Marker Kit
115240-G1	Shipping Carton
115818-G1	TASKCard Cover
107539-G13	TASKCard Cover Screw, Phillips Head, 4-40 x 1/4" long. Two used.
* User specified, one standard only.	

Optional accessories The optional accessories are described in Appendix A.

Physical Description, Continued

Batteries	Refer to Appendix C for the description and replacement of the batteries contained in the Power Platform.
------------------	---

Fuses	Refer to Appendix D for fuse information.
--------------	---

Replaceable Parts	Refer to Appendix E for operator replaceable parts.
--------------------------	---

Operational Description

Monitoring Capacity

The Dranetz-BMI PP1-PQPlus can monitor any of the following power configurations:

- Single phase, 2 wire
- Split phase, 3 wire
- 3 phase, 3 wire (delta)
- 3 phase, 4 wire (wye)

While monitoring any of the above configurations, the Power Platform can also be wired to monitor neutral to ground voltage and neutral current.

Technical Specifications

Specifications for the PP1-PQPlus, measured parameters, computed parameters, current probes, and isolated current transformers, are listed in Appendix F.

Easy start

The Easy Start function prompts you for information about the circuit you want to monitor and then automatically sets up the Power Platform for monitoring and reporting. See next chapter.

Meter Mode

In addition to monitoring for power disturbances, the PP1-PQPlus is a true RMS voltmeter and true RMS clamp-on ammeter. Voltage and current measurements, along with all other calculated parameters, are displayed on the Meter Mode screens. The PP1-PQPlus also functions as a phase angle meter, wattmeter, VAR meter, PF meter, and frequency meter.

Available Parameters: The following table lists all the parameters and their abbreviations as displayed on the Power Platform's screens.

Parameter	Abbreviation
Volts	V
Amps	I
Watts	W
Volt-Amperes	VA
Volt-Amperes Reactive	VAR
Power Factor (True)	PF
Frequency	HZ

Continued on next page

Operational Description, Continued

Meter Mode (continued)

Parameter	Abbreviation
Voltage Unbalance	Vunb%
Voltage Harmonic Distortion	Vthd
Current Harmonic Distortion	Ithd
Current Crest Factor	Icf
K-Factor	Kf
Voltage Harmonic N	VharmN
Current Harmonic N	IharmN
Demand	Dmd
Energy	WH

Phase angle meter: The PP1-PQPlus can display voltage and current phasors for all of the channels. Functioning as a phase angle meter, the Power Platform can display system imbalance conditions. The phase angle display can also verify that monitoring connections have been made correctly.

Meter mode operation does not interfere with any of the analyzer's other monitoring or recording functions. The meter mode is not effected by the configuration of the PP1-PQPlus. Turning monitoring off or individual channels off does not effect meter readings.

Scope mode

When in scope mode, the PP1-PQPlus is an oscilloscope, displaying real-time waveforms of voltage and current for all channels.

Setups

A setup is a list of parameter thresholds that controls the events that the PP1-PQPlus records.

The PP1-PQPlus has 10 setups. Setups 1 through 9 are pre-defined but can be modified. Setup 10 is used for Easy start and can't be modified, but it can be copied and modified. Refer to Appendix G for the description of all setups.

Events

An event is stored in memory when a threshold is crossed (either going out-of-limits or on return-to-normal), when a device is configured, or when system status changes.

Continued on next page

Operational Description, Continued

Reports A report is a unit of information pertaining to one or more channels and parameters that can be sent to an output device when a trigger condition is met. Although report types are pre-defined, the parameters that are contained in some reports are user-selectable.

Relay reports are used to activate a relay when a trigger condition is met.

Communication The PP1-PQPlus provides full duplex communication for both RS232 and modem.

Help Help is available by pressing the question mark (?) key on the numeric keypad. A help screen is a one page description of the screen (function) presently displayed.

Calibration The recommended calibration interval for this unit is once every 12 months.

We recommend that you return the unit to the factory for calibration. If you decide to do so, first contact the Dranetz-BMI Customer Service Department to obtain an Authorization Number.

Telephone: (732) 287-3680

Fax: (732) 248-9240

PP1-PQPlus Messages Messages that appear on the display are described in Appendix H.

Connecting to an external power source Connecting the Power Platform to an external DC power source is described in Appendix I.

Menu structure The PP1-PQPlus menu structure is described and shown in Appendix J.

Continued on next page

Operational Description, Continued

Digital Inputs

The Power Platform's rear panel has four digital inputs. These inputs can be used for

- External triggers, to generate a report
- Start/stop measurements, for recording measurements only during a specified interval
- Snapshot enable, to take a snapshot of all active channels.

Memory Card

A memory (data) card is used with the Power Platform to provide a removable, rugged, compact, solid state mass storage device. A memory card, shown below, uses low power, has an internal battery for data retention, and is available as an optional accessory in sizes from 512 Kbytes to 2 Mbytes.

For information about the battery, refer to Appendix C.

The PP1-PQPlus treats the memory card like a floppy disk storing files in a DOS format. In the PP1-PQPlus, the memory cards are used to store events and setups.

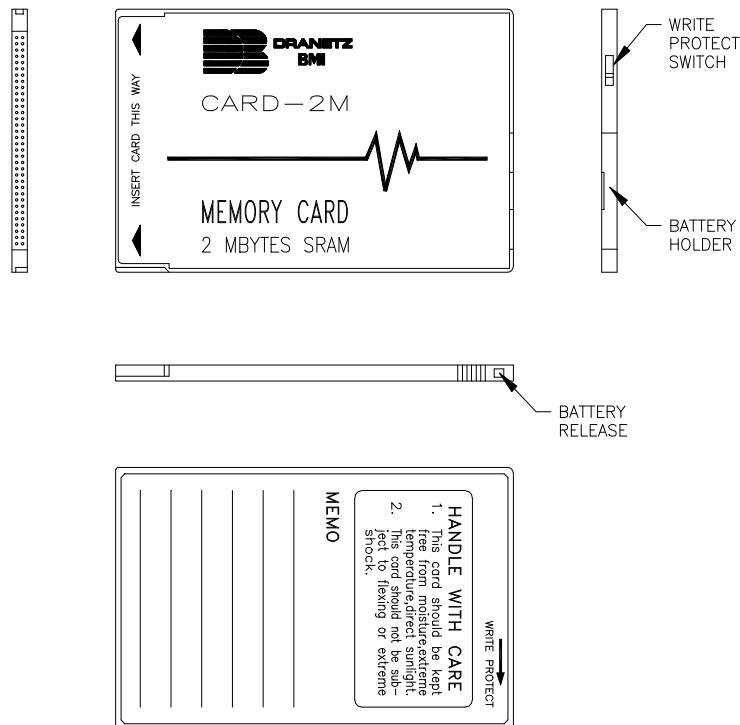

Continued on next page

Operational Description, Continued

Printing options There are three printing conditions possible dependent on which version of the PP1 is being used and whether or not an external printer is connected. These conditions are as follows:

- PP1 with internal printer,
- PP1 with internal printer and external parallel printer connected,
- PP1 without Internal printer and external parallel printer connected.

In all three of these conditions, pressing the PRINT function key, when displayed, will produce a normal printing function to occur, on either the internal or external printer.

A PP1 having an internal printer and connected to an external parallel printer, will automatically bypass the internal printer and will print to the external printer only.

Chapter 2

Easy Start

Overview

Introduction This chapter provides you with a quick and easy way to start monitoring if you are familiar with the setup and operation of similar power monitoring equipment. If you are not familiar with equipment of this type, proceed to Chapter 3 for a detailed description of the PP1-PQPlus.

Easy Start description This chapter provides information for using the Easy Start function of the Power Platform-PQPlus. Easy Start is a series of screens that prompts you for information about the circuit you will be monitoring. The PP1-PQPlus then automatically turns on the correct channels, sets the monitoring thresholds, and chooses the types of reports that it will print out.

Percent tolerance description Easy start sets the monitoring thresholds for the PP1-PQPlus at a certain percentage above and below the values you enter. The tolerance has a default value of 10%.

Example: For the default setting of +/- 10%, if you enter 120 V for your nominal line voltage, then Easy Start will set your thresholds to the following values:

- V HIGH RMS: 132 V
- V LOW RMS: 108 V

The tolerance can be changed to other values if desired. Refer to page 2-3 for changing the Easy Start tolerance.

In this chapter The following topics are covered in this chapter.

Topic	See Page
Turning On the Power Platform	2-2
Changing the Tolerance for the Easy Start Setup	2-3
Using Easy Start	2-5

Turning On the Power Platform

Procedure Follow these steps to turn on the Power Platform.

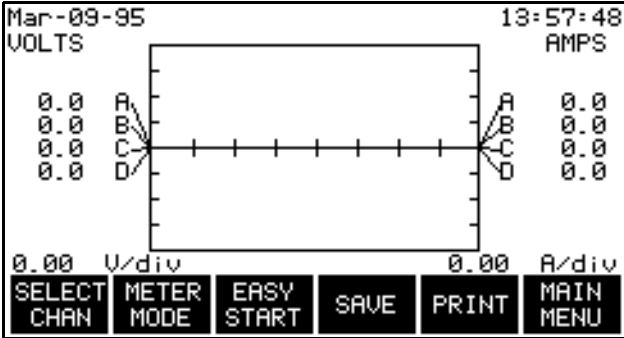
Step	Action
1	Plug unit into an ac power source.
2	Verify that the PQPlus TASKCard is inserted into the slot on the rear panel.
3	<p>Turn on the unit.</p> <p><u>Result:</u> If the TASKCard is inserted correctly, the unit will perform internal diagnostics, momentarily display the message “TASKCard Found, Loading PQPlus Vxx”, then display the scope mode screen shown below.</p>  <p><u>Note:</u> If the TASKCard is not inserted correctly, or if the TASKCard is corrupted, an error message will be displayed indicating TASKCard or downloading failure. Refer to page 4-7 for a list of the error message types and what to do next.</p>
4	Pressing PRINT will print a copy of the empty display as shown. Refer to page 11-10 for printing options depending on the PP1 you have.
5	<p>Do you want to change the percent tolerance?</p> <ul style="list-style-type: none"> • If <u>yes</u>, go to page 2-3. • If <u>no</u>, go to page 2-5.

Changing the Tolerance for the Easy Start Setup

Introduction

Easy start percent tolerance is the percent used by easy start to calculate the values of the threshold settings above and below the nominal voltage and current values that you will enter.

If you want to keep the default setting, go to page 2-5.

Parameters affected

The following parameters are affected by the easy start percent tolerance setting.

Parameter	Default Setting
V HIGH RMS	+ 10%
V LOW RMS	- 10%
I HIGH RMS	+ 10%

Range

1 to 1000%

Displaying the screen

Follow these steps to display the Set Easy Start Percent Tolerance screen.

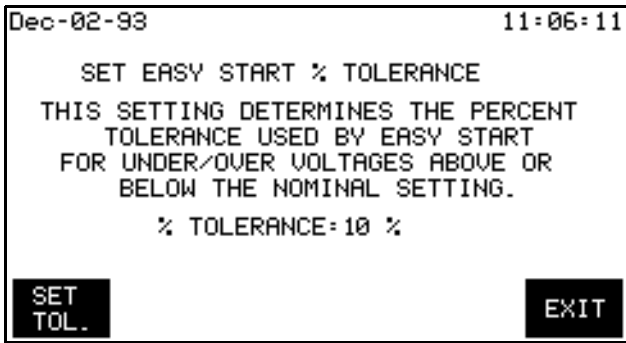
Step	Action
1	From the scope mode screen, press MAIN MENU.
2	Select item 3, Setup Menu, from the Main Menu.
3	Select item 6, Set Easy Start Percent Tolerance, from the Setup Menu. <u>Result:</u> The following screen will appear. 

Continued on next page

Changing the Tolerance for the Easy Start Setup, Continued

Procedure Follow these steps to change the easy start percent tolerance.

Step	Action
1	Press SET TOL. <u>Result:</u> The menu bar will change to the following. 
2	Enter the number from the keypad.
3	Press ENTER.
4	Press EXIT twice to return to the Main Menu.

Using Easy Start

Introduction Refer to the tables on the following pages for the possible easy start combinations based on the information that you enter.

CAUTION The Easy Start process will change previously programmed instrument settings and configurations. Monitoring is also shut down during Easy Start programming.

PRECAUCION El proceso Inicio fácil cambiará los ajustes y configuraciones del instrumento programados anteriormente. También se detiene el monitoreo durante la programación de Inicio fácil.

MISE EN GARDE Le processus Easy Start modifiera les configurations et les réglages des instruments précédemment programmés. La fonction de contrôle est également éteinte pendant la programmation de Easy Start.

VORSICHT Der Vorgang "Easy Start" (Einfacher Start) ändert vorher programmierte Instrumenteneinstellungen und -konfigurationen. Das Überwachen wird während des "Easy Start"-Programmierens ebenfalls ausgeschaltet.

Procedure Follow these steps if you are using the Easy Start function of the PP1-PQPlus.

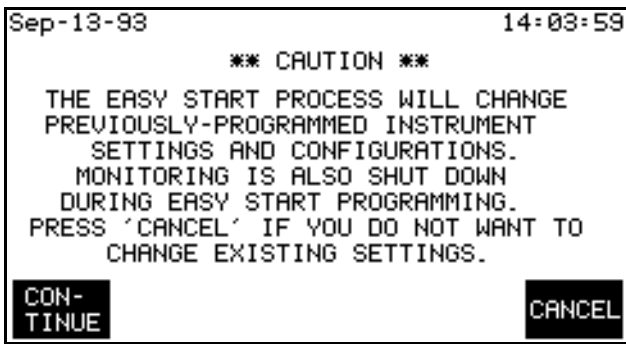
Step	Action
1	<p>From the scope mode screen, press EASY START.</p> <p><u>Result:</u> The following screen will appear.</p> 

Continued on next page

Using Easy Start, Continued

Procedure (continued)

Step	Action
2	<p>Is the unit connected to a circuit and collecting data?</p> <ul style="list-style-type: none"> • If <u>yes</u>, press CANCEL and save data to a memory card before proceeding. See page 11-31. • If <u>no</u>, press CONTINUE and enter the required information as you proceed through the Easy Start screens.

Monitoring Combinations

The following table lists the input channels that will be turned on based on the circuit type that you choose, monitor current setting, and neutral to ground setting.

Monitor Current	Neutral to Ground	Single Phase	Split Phase	3 Phase (Wye or Delta)
ON	ON	Va, Vd, Ia, Id	Va, Vb, Vd, Ia, Ib, Id	Va, Vb, Vc, Vd, Ia, Ib, Ic, Id
ON	OFF	Va, Ia	Va, Vb, Ia, Ib	Va, Vb, Vc, Ia, Ib, Ic
OFF	ON	Va, Vd	Va, Vb, Vd	Va, Vb, Vc, Vd
OFF	OFF	Va	Va, Vb	Va, Vb, Vc

Continued on next page

Using Easy Start, Continued

Easy Start setup Parameter thresholds: The following table lists the settings for the parameters in the Easy Start setup. All other parameters are turned off.

Parameter	Setting
V HIGH RMS	+ 10% * from nominal
V LOW RMS	- 10% * from nominal
V TRANSIENT	150% of nominal
V THD %	10%
V FREQ	2.0 Hz
I HIGH RMS	+ 10% * from nominal
PF LOW LIM	0.85
V SENS OUT LIM	5
V TRANS % RAISED	50%
I TRANS % RAISED	50%
* This number is the default percent tolerance of Easy Start.	

Waveform capture settings: The following table lists the parameters that will have waveforms saved to memory when the corresponding threshold is exceeded. All other parameters are turned off.

Parameter	Waveform Capture	Record All Channels
V LOW RMS	ON	ON
V TRANSIENT	ON	ON
V THD %	ON	OFF
#nTH V HARM %	ON	OFF
#nTH I HARM %	ON	OFF

Note: Waveform Capture set to ON means that the waveform for the channel that the event occurred on will be saved. Record All Channels set to ON means that waveforms for all channels will be saved when an event occurs.

Example: From the table above, if the V LOW RMS limit is crossed on Channel C, then waveform data will be saved for that channel and all other active channels. However, if the V THD % limit is crossed on Channel C, then waveform data will be saved for that channel only.

Continued on next page

Using Easy Start, Continued

Automatic Report Settings The following table list the reports that will be printed out based on the values that you entered into easy start. All reports will be printed out daily at midnight.

Report	Monitoring Circuit Type							
	Single Phase		Split Phase		3 Phase Delta		3 Phase Wye	
	V	V+I	V	V+I	V	V+I	V	V+I
Time Plot Channel A Vrms	X	X	X	X	X	X	X	X
Time Plot Channel B Vrms			X	X	X	X	X	X
Time Plot Channel C Vrms					X	X	X	X
Time Plot Channel D Vrms*	X	X	X	X	X	X	X	X
Time Plot Channel A Vtrans	X	X	X	X				
Time Plot Channel B Vtrans			X	X				
Time Plot Channel D Vtrans*	X	X	X	X	X	X	X	X
Time Plot Channel A Vthd	X	X	X		X		X	
Time Plot Channel B Vthd			X		X		X	
Time Plot Channel A Irms		X		X		X		X
Time Plot Channel B Irms				X		X		X
Time Plot Channel C Irms						X		X
Time Plot V Unbalance					X		X	
Worst Case Events	X	X	X	X	X	X	X	X
Key V: Only voltage monitoring is turned on. V+I: Voltage and current monitoring is turned on. *If neutral to ground monitoring is turned on.								

Chapter 3

Controls, Indicators, and Connectors

Overview

Introduction This chapter identifies and describes the controls, indicators, and connectors on the front and rear panels of the Power Platform. In addition, the methods of positioning the unit for carrying, operating, and securing the unit are discussed.

In this chapter The following topics are covered in this chapter.

Topic	See Page
Front Panel	3-2
Rear Panel	3-4
Positioning the Unit	3-8

Front Panel

Diagram

Models PP1 & PP1E

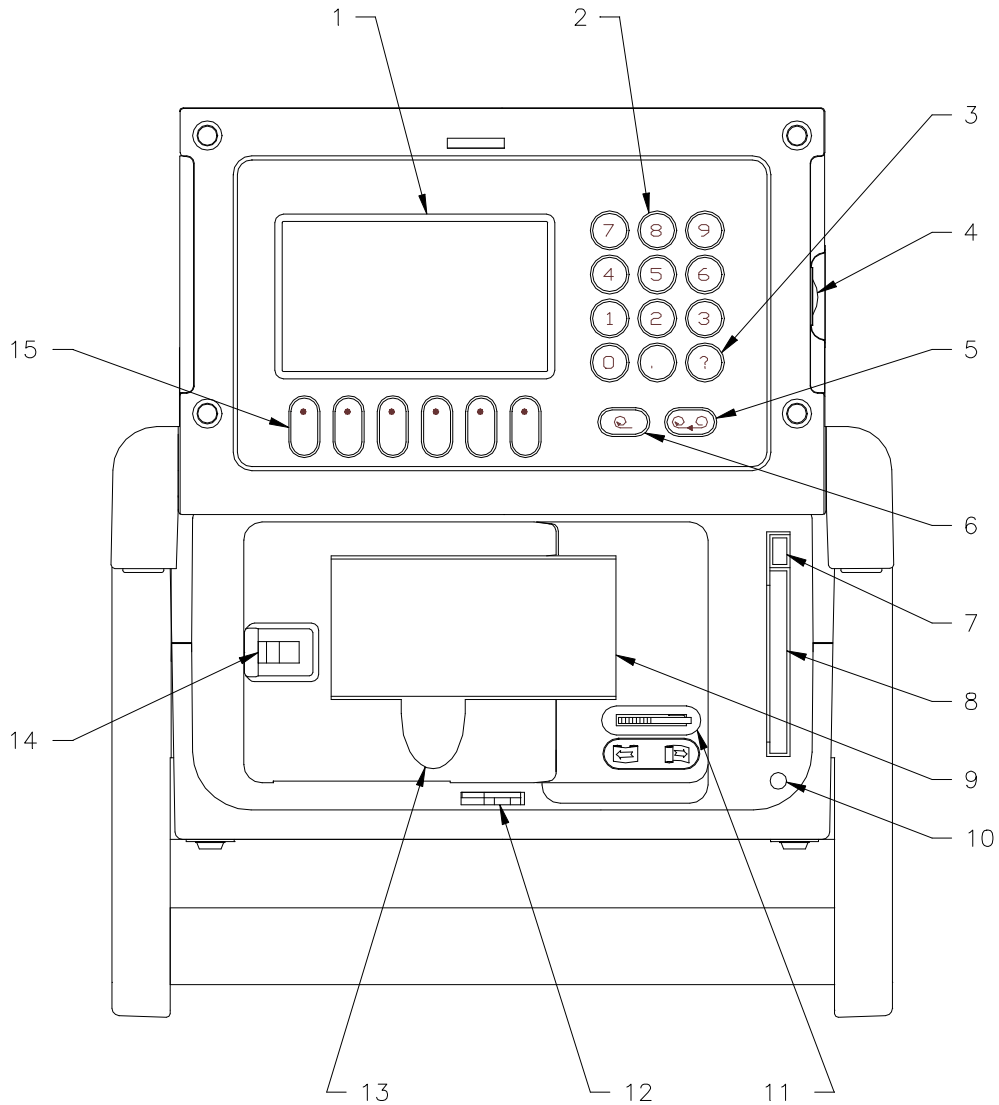

8600-16

Continued on next page

Front Panel, Continued

Parts Table

Part	Function
1	Liquid Crystal Display (LCD). Provides 2 3/4 x 4 1/2 inch (5 x 10 cm) display consisting of 240 by 128 pixels (dots) of text and graphic information. Has electroluminescent (EL) backlighting for low light level viewing.
2	Numeric keypad. Consists of keyboard keys 0 thru 9 and decimal point (.). Permits menu selection and numerical data entry.
3	Question Mark Key. Provides selection of User Guide to display help screens with reference to screen displayed at any time.
4	Contrast Control. Provides contrast range control for LCD viewing.
5	Paper Feed. Controls paper feed and take up to advance the paper uniformly across window from right to left.
6	Paper Take-up. Controls paper slack.
7	Data Card Release. Ejects data (memory) card.
8	Data Card Holder. Holds and connects data (memory) card to internal circuitry.
9*	Thermal Paper Printout. High-resolution thermal print of real-time data and report information.
10	Data Card Busy LED. Yellow LED indicates data (memory) card is being accessed.
11*	Run/Load Printhead Control. Lever in left position for normal run operation. Lever in right position lifts printhead from paper for loading or paper pulling.
12	Keylock. Secures front panel in locked shut position.
13*	Finger Groove. Access to grasp and pull paper out for viewing. (Note: Printhead control must be in LOAD position before paper is pulled.)
14*	Printer Door Latch. Moves to right to unlock printer door.
15	Function Keys. Used to select options that appear on bottom of screen. Function selected varies with screen displayed.
*Part of PP1 with printer.	

Rear Panel

Diagram

Model PP1

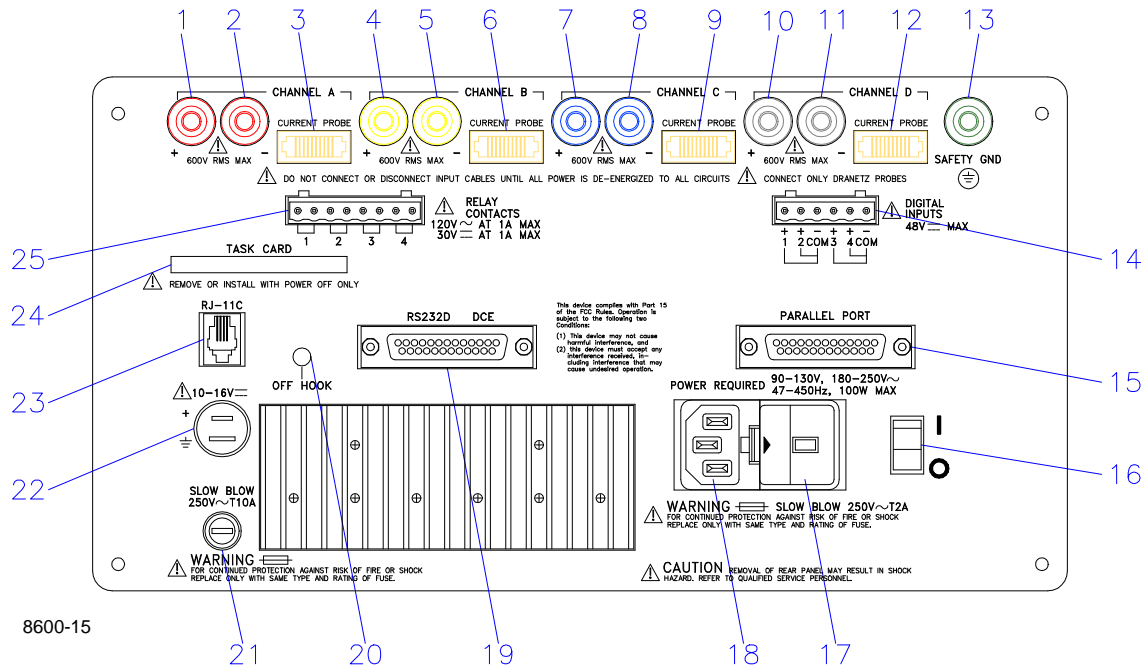

Continued on next page

Rear Panel, Continued

Diagram

Model PP1E

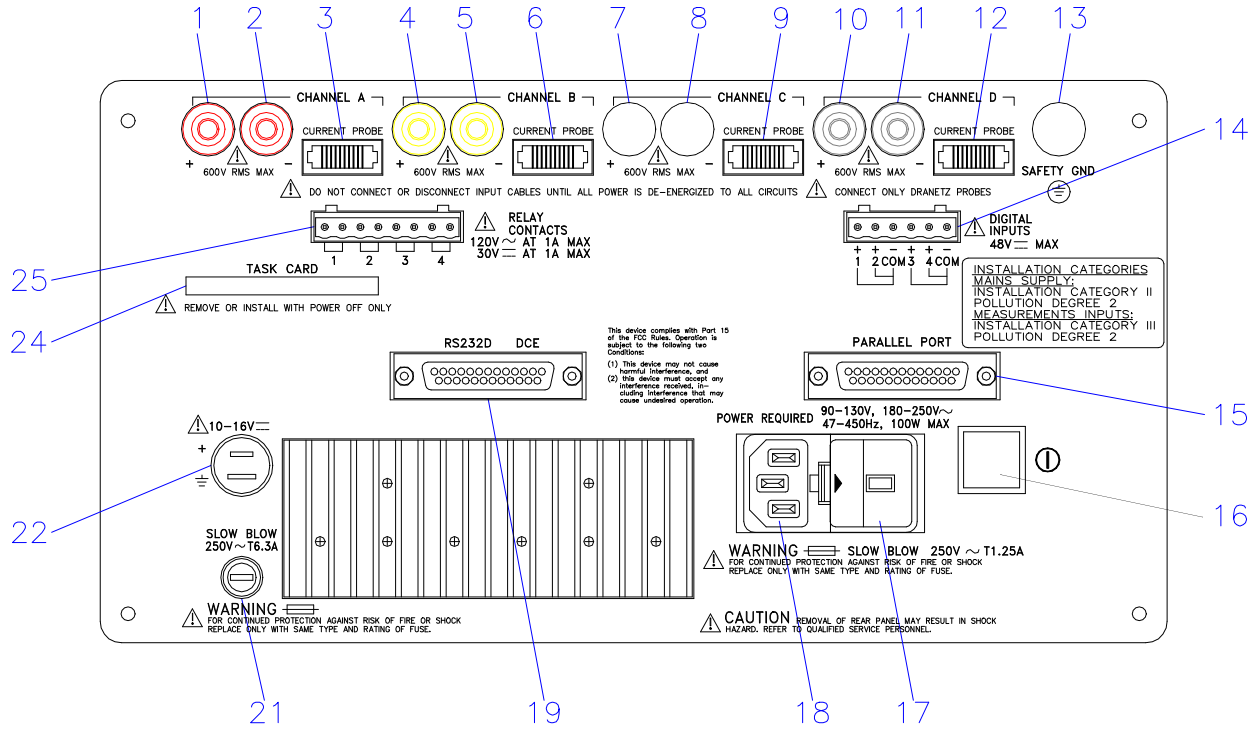

Continued on next page

Rear Panel, Continued

Parts Table

Models PP1 & PP1E

Part	Description
1	CHANNEL A, + Differential Voltage Input Connector; color red.
2	CHANNEL A, - Differential Voltage Input Connector; color white.
3	CHANNEL A, CURRENT PROBE Input Connector.
4	CHANNEL B, + Differential Voltage Input Connector; color yellow.
5	CHANNEL B, - Differential Voltage Input Connector; color white.
6	CHANNEL B, CURRENT PROBE Input Connector.
7	CHANNEL C, + Differential Voltage Input Connector; color blue.
8	CHANNEL C, - Differential Voltage Input Connector; color white.
9	CHANNEL C, CURRENT PROBE Input Connector.
10	CHANNEL D, + Differential Voltage Input Connector; color grey.
11	CHANNEL D, - Differential Voltage Input Connector; color white.
12	CHANNEL D, CURRENT PROBE Input Connector.
13	SAFETY GROUND Connector; color green.
14	DIGITAL INPUTS, 12-48 VDC. Four channels of digital signal inputs.
15	PARALLEL PORT, Parallel data port.
16	On/Off Switch. 1 = ON, 0 = OFF.
17*	PP1: SLOW BLOW 250 VAC T2A. Fuseholder. (Main Power) PP1E: SLOW BLOW 250 VAC T1.25A 5x20 mm Fuseholder (Main Power).
18	POWER REQUIRED, 90-130 VAC 180-250 VAC, 47-450 Hz, 100 W MAX. Input power plug.
19	RS232D DCE, Serial data port.
20	PP1: OFF HOOK indicator. When lit yellow indicates that the telephone line is active. PP1E: Not available
21*	PP1: SLOW BLOW, 250 VAC T10A. Internal/External battery fuse. PP1E: SLOW BLOW, 250 VAC T6.3A 5x20 mm Internal/External battery fuse.

Continued on next page

Rear Panel, Continued

Parts Table (continued)

Part	Description
22	10-16VDC, External DC voltage source input.
23	PP1: RJ-11C. Telephone jack for internal 2400 baud modem connection. PP1E: Not available.
24	TASK CARD, connector slot. TASKCard Protective Cover, mounted with screws after TASKCard is installed. (Not shown.)
25	RELAY CONTACTS, 120 VAC AT 1A MAX, 30 VDC AT 1A MAX. Four sets of relay contacts.
* Refer to Appendix D for Fuse Replacement	

Positioning the Unit

Handle release Handle releases, in the pivots of the handles, must be pressed inwards together to unlock the handles. Once released, the handles can be positioned in three positions: one for carrying the unit, and two for viewing the display at 15 or 45 degrees. At each position the handles will lock and must be released again to be repositioned.

Handle release location and carrying position

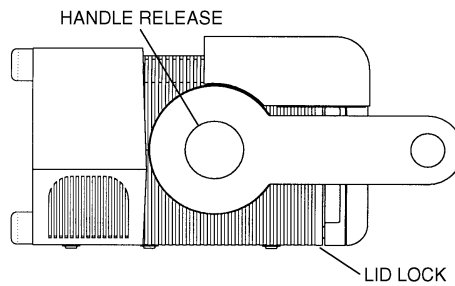

8600-53

Viewing positions

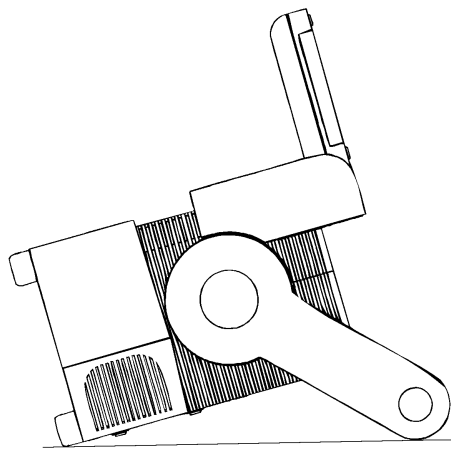

8600-54

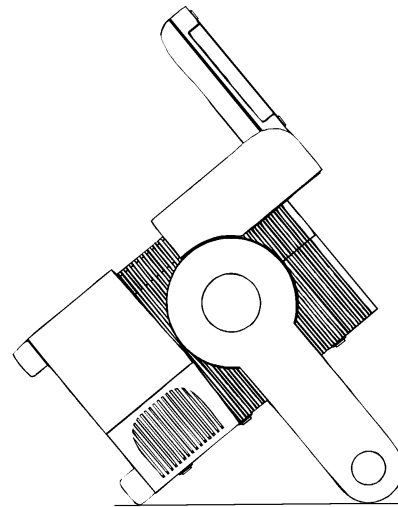

8600-55

Chapter 4

Getting Started

Overview

What is getting started? This chapter helps you to get started in making the required connections to the circuit to be monitored, verify that your connections are made correctly, activate a monitoring setup so that the unit can begin gathering information, and view the basic displays of the parameters being monitored.

In this chapter This chapter is divided into five sections.

Section	Title	See Page
A	Turn On Procedures	4-2
B	Voltage and Current Cable Connections	4-11
C	Circuit Diagrams for Power Measurements	4-37
D	Monitoring Setup Procedures	4-49
E	Scope and Meter Mode	4-56

Section A

Turn On Procedures

Overview

Introduction This section describes the procedures you need to perform before you turn the unit on and what you should see after it is on. Possible error conditions and the necessary corrective actions are also discussed.

In this section The following topics are covered in this section.

Topic	See Page
Setting the Voltage Selector	4-3
Power Requirements	4-5
Installing a TASKCard	4-6
Turning the Unit On	4-7

Setting the Voltage Selector

Introduction The Power Platform input voltage may be set to 115VAC or 230VAC by manually positioning a selector type switch. The selected operating voltage is indicated in a window of the fuse holder.

WARNING The power to the Power Platform must be off when changing the voltage selector.

ADVERTENCIA Se debe cortar la energía a la Plataforma de energía cuando se cambie el selector de voltaje.

AVERTISSEMENT L'alimentation jusqu'à la plate-forme d'alimentation doit être coupée lors du changement de tension.

WARNUNG Die Stromzufuhr zur "Power Platform" (Stromplattform) muß ausgeschaltet sein, wenn der Spannungswähler ausgewechselt wird.

Procedure Follow these steps to set the voltage selector.

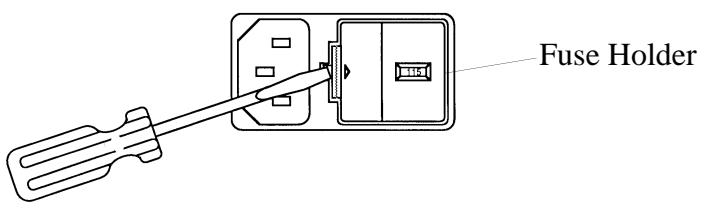
Step	Action
1	Turn power switch off and remove power cord, if connected.
2	Place screwdriver blade in fuse holder retaining slot and push to right to release fuse holder.
	
8600-56	
3	Remove fuse holder.

Continued on next page

Setting the Voltage Selector, Continued

Procedure (continued)

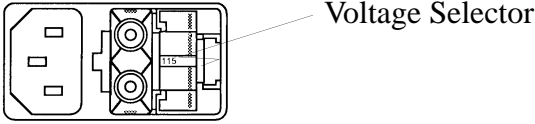
Step	Action
4	Grasp and pull out voltage selector from fuse holder body.  8600-57
5	Rotate voltage selector so that desired voltage marking is facing rear of panel.
6	Insert voltage selector into fuse holder slot and push firmly to seat.
7	Replace fuse holder.
8	Verify that voltage selector indicator displays the required voltage. If not, repeat steps 2 through 7.

Power Requirements

Introduction

The Power Platform can be operated from an AC or DC power source. Refer to Appendix I for information about connecting to an external DC power source.

Connecting to an AC power source

Follow these steps to connect to an AC power source.

Step	Action
1	Verify that the power switch is off. See rear panel, page 3-5, item 16.
2	Verify that the voltage selector on the rear panel is set to the operating voltage of your facility. If voltage selection is wrong, refer to page 4-3.
3	Connect female end of correct operating voltage power cord (listed below) to the AC power input receptacle on the rear panel. <ul style="list-style-type: none">• 115 VAC power cord - Part No. 110893-G1 (Domestic)• 230 VAC power cord - Part No. 110726-G1 (Domestic)• 230 VAC power cord - Part No. 115369-G1 (Euro)• 230 VAC power cord - Part No. 115368-G2 (UK)
4	Connect male end of power cord to input power source.

Operating the PP1 using the internal battery

Follow these steps to run the Power Platform on the internal battery.

Step	Action
1	Turn the unit off.
2	Disconnect AC power cord.
3	Turn on power to the unit. <u>Note:</u> The unit will operate up to one hour without using printer. Using printer continuously will deplete the battery in approximately 15 minutes.

Installing a TASKCard

Procedure

Follow these steps to install a TASKCard.

Step	Action
1	Turn off power to the unit.
2	Remove TASKCard-PQPlus from its protective holder and check that the plug end of card is clean and free of any obstruction. <u>Note:</u> If plug end of card is dirty, clean with static-free, dry, low pressure air to remove any foreign material causing obstruction of the plug holes.
3	Verify that the Write Protect switch (end opposite plug) is set to the Write Protect position. Use pencil point to move switch.
4	At the rear of the unit, position the TASKCard-PQPlus with the label facing up and the plug end facing the TASK CARD slot.
5	Insert the card fully into the slot until resistance is felt, then press firmly until the card engagement is felt. <u>Note:</u> Do not force the card further into the slot if no card engagement is felt. Remove card and check that there is no foreign object on or in the plug end of the card. Remove any obstruction. Reinsert card and repeat card engagement. If card cannot be engaged, STOP all further action and call Dranetz Service for further instructions.
6	To prevent the inserted TASKCard from being removed during operation, install the TASKCard cover accessory (shown below) over the TASKCard and secure the cover with the two screws provided.
7	Go to next page for power turn on procedure.

TASKCard cover

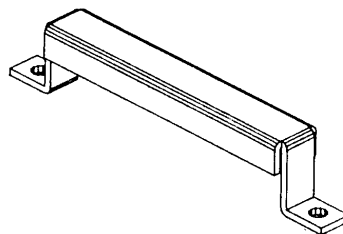

8600-59

Turning the Unit On

WARNING Do not turn power on unless a secure safety ground, using the green safety wire, is connected to the green ground terminal on the rear panel.

ADVERTENCIA No encienda la energía a menos de que haya una conexión a tierra de seguridad, utilizando el alambre de seguridad verde, con el terminal de conexión a tierra verde en el panel posterior.

ATTENTION Ne pas mettre sous tension sauf si une mise à la terre adéquate, en utilisant le câble vert de sécurité, est connectée à la borne de mise à la terre verte sur le panneau arrière.

WARNUNG Schalten Sie den Strom nicht ein, bevor Sie eine sichere Erdung mit dem grünen Erdungsdraht hergestellt haben, der an den grünen Erdungsterminal auf der Rückwand angeschlossen ist.

Procedure Follow these steps when turning on the Power Platform.

Step	Action
1	Verify that the green grounding connector is attached to the Safety Gnd connector on the rear panel and that the other end is firmly attached to a secure ground.
2	Verify that all voltage probe connections at the source or load are secure and that voltage probes are connected securely to the rear panel.
3	Verify that all current probe connections at the source or load are secure and that current probes are connected securely to the rear panel.
4	Verify that the PQPlus TASKCard is installed in the rear panel.

Continued on next page

Turning the Unit On, Continued

Procedure (continued)

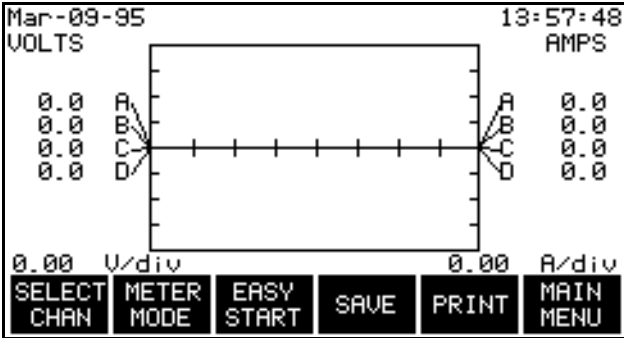
Step	Action
5	<p>Turn on power to the unit.</p> <p><u>Result:</u> If the TASKCard is inserted correctly, the unit will perform internal diagnostics, momentarily display the message “TASKCard Found, Loading PQPlus Vxx”, then display the scope mode screen shown below.</p>  <p><u>Note:</u> If the TASKCard is not inserted correctly, or if the TASKCard is corrupted, an error message will be displayed indicating TASKCard or downloading failure. Refer to the error message table on next page for the error message types and what to do next.</p>

TASKcard error messages The following table describes the possible error messages when loading the TASKCard and the corrective action to take for each.

Error Message	What to Do Next
TASKCard Not Found. Booting From ROM.	TASKCard may not be installed or is installed incorrectly. Turn off power and recheck TASKCard installation. To boot from ROM see next page.

Continued on next page

Turning the Unit On, Continued

TASKcard error messages (continued)

Error Message	What to Do Next
Corrupt TASKCard. Booting from ROM.	A TASKCard was found but it was not recognized as a valid TASKCard. Turn off power and recheck TASKCard. If the TASKCard is properly inserted, there may be a problem, notify Dranetz. To boot from ROM, see next page.
<p>WARNING: The TASKCard found: (now installed) Is different than last used: (previous TASKCard) CHANGING TASKCARDS MAY ERASE MEMORY!</p> <p>ADVERTENCIA: La TASKCard que se encontró: (ahora instalada) Es diferente de la utilizada la última vez: (TASKCard anterior) ¡CAMBIAR LAS TASKCARDS PUEDE BORRAR LA MEMORIA!</p> <p>AVERTISSEMENT: La TASKCard détectée : (actuellement installée) est différente de la dernière utilisée : (TASKCard précédente) LE CHANGEMENT DE TASKCARDS PEUT EFFACER LA MÉMOIRE !</p> <p>WARNUNG: Die gefundene TASKCard: (jetzt installiert) ist unterschiedlich von der zuletzt benutzen: (vorherige TASKCard) WECHSELN DER TASKCARDS KANN SPEICHER LÖSCHEN!</p>	<p>Press any key to continue or turn off the unit and reinstall the last TASKCard used.</p> <p>Pulse cualquier tecla para continuar o apague la unidad y vuelva a instalar la última TASKCard utilizada.</p> <p>Appuyez sur une touche pour continuer ou éteignez l'unité et réinstallez la dernière TASKCard utilisée.</p> <p>Betätigen Sie eine Taste, um fortzufahren oder schalten Sie die Einheit aus und installieren Sie die zuletzt benutzte TASKCard erneut.</p>
<p>Any of the following:</p> <ul style="list-style-type: none"> •I/O Processor Download Failed •ACP Processor Download Failed •I/O Processor Will Not Respond •ACP Processor Will Not Respond 	<p>TASKCard download problem. Notify Dranetz for further assistance.</p>

Turning the Unit On, Continued

When to boot from ROM

Boot from ROM under the following conditions:

- you have a problem loading the TASKCard, or
- you want to operate the power platform without the TASKCard.

Booting from ROM

To boot from ROM proceed as follows:

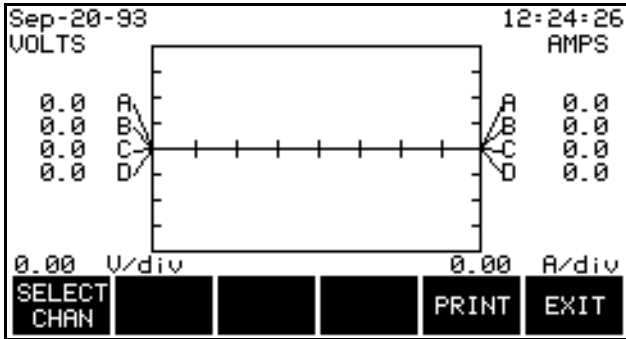
Step	Action
1	<p>From the error message screen, press any key. The following screen is displayed.</p> 
2	Press EXIT to display the Meter Mode Menu.

Available Functions

When you boot from ROM, only the following functions are available.

Function	See Page
Scope Mode	4-57
One Channel, All Parameters Meter Mode	4-60
All Channels, One Parameter Meter Mode	
Voltage and Current Phasors	4-62
Set Time and Date	7-4

Note

No further monitoring or displaying of parameter data is possible without having a TASKCard installed.

Section B

Voltage and Current Cable Connections

Overview

Introduction This section covers topics related to the connection of the various voltage and current devices that can be used when making measurements. For specific circuit applications, refer to Section C.

WARNING **Death, serious injury, or fire hazard could result from improper connection of this instrument. Read and understand this manual before connecting this instrument. Follow all installation and operating instructions while using this instrument.**

Connection of this instrument must be performed in compliance with the National Electrical Code (ANSI/NFPA 70-1996) of USA and any additional safety requirements applicable to your installation.

Installation, operation, and maintenance of this instrument must be performed by qualified personnel only. The National Electrical Code defines a qualified person as “one familiar with the construction and operation of the equipment and the hazards involved.”

ADVERTENCIA **Una conexión incorrecta de este instrumento puede producir la muerte, lesiones graves y riesgo de incendio. Lea y entienda este manual antes de conectar. Observe todas las instrucciones de instalación y operación durante el uso de este instrumento.**

La conexión de este instrumento debe ser hecha de acuerdo con las normas del Código Eléctrico Nacional (ANSI/NFPA 70-1996) de EE. UU., además de cualquier otra norma de seguridad correspondiente a su establecimiento.

La instalación, operación y mantenimiento de este instrumento debe ser realizada por personal calificado solamente. El Código Eléctrico Nacional define a una persona calificada como "una que esté familiarizada con la construcción y operación del equipo y con los riesgos involucrados."

Overview, Continued

AVERTISSE- MENT

Si l'instrument est mal connecté, la mort, des blessures graves, ou un danger d'incendie peuvent s'en suivre. Lisez attentivement ce manuel avant de connecter l'instrument. Lorsque vous utilisez l'instrument, suivez toutes les instructions d'installation et de service.

Cet instrument doit être connecté conformément au National Electrical Code (ANSI/NFPA 70-1996) des Etats-Unis et à toutes les exigences de sécurité applicables à votre installation.

Cet instrument doit être installé, utilisé et entretenu uniquement par un personnel qualifié. Selon le National Electrical Code, une personne est qualifiée si "elle connaît bien la construction et l'utilisation de l'équipement, ainsi que les dangers que cela implique".

WARNUNG

Der falsche Anschluß dieses Gerätes kann Tod, schwere Verletzungen oder Feuer verursachen. Bevor Sie dieses Instrument anschließen, müssen Sie die Anleitung lesen und verstanden haben. Bei der Verwendung dieses Instruments müssen alle Installation- und Betriebsanweisungen beachtet werden.

Der Anschluß dieses Instruments muß in Übereinstimmung mit den nationalen Bestimmungen für Elektrizität (ANSI/NFPA 70-1996) der Vereinigten Staaten, sowie allen weiteren, in Ihrem Fall anwendbaren Sicherheitsbestimmungen, vorgenommen werden.

Installation, Betrieb und Wartung dieses Instruments dürfen nur von Fachpersonal durchgeführt werden. In dem nationalen Bestimmungen für Elektrizität wird ein Fachmann als eine Person bezeichnet, welche "mit der Bauweise und dem Betrieb des Gerätes sowie den dazugehörigen Gefahren vertraut ist."

Safety precautions

The following safety precautions must be followed whenever any type of connection is being made to the instrument.

- Connect the green safety (earth) ground first, before making any other connections.
 - When connecting to electric circuits or pulse initiating equipment, open their related breakers. DO NOT install any connection of the instrument on live power lines.
-

Continued on next page

Overview, Continued

- Connections must be made to the instrument first, then connect to the circuit to be monitored.
 - Wear safety glasses and insulated gloves when making connections to power circuits.
 - Hands, shoes and floor must be dry when making any connection to a power line.
 - Make sure the unit is turned OFF before connecting probes to the rear panel.
 - Before each use, inspect all cables for breaks or cracks in the insulation. Replace immediately if defective.
-

Medidas de seguridad

Las medidas de seguridad siguientes deberán observarse cuando se realice cualquier tipo de conexión al instrumento.

- Antes de hacer cualquier conexión, deberá enchufarse el conector de seguridad verde a tierra.
 - Cuando se haga conexiones a circuitos eléctricos o a equipo de activación por pulso, deberá abrirse sus respectivas cajas de seguridad. NO deberá hacerse ninguna conexión del instrumento en líneas eléctricas bajo tensión.
 - Las conexiones deberán hacerse primero al instrumento y, luego, al circuito a ser monitorizado.
 - Al hacer conexiones a circuitos eléctricos, deberá utilizar anteojos y guantes protectores.
 - Sus manos, zapatos y el piso deberán estar secos en todo momento en que se haga una conexión a un cable eléctrico.
 - Verifique que la unidad esté DESACTIVADA antes de conectar sondas en el panel posterior.
 - Previo a cada uso, deberá verificarse que los cables no estén rotos y que el material aislante no tenga rajaduras. Reemplace de inmediato cualquier parte defectuosa.
-

Mesures de Sécurité

Les mesures de sécurité suivantes doivent être prises chaque fois qu'un type de connexion quelconque est effectué sur l'instrument.

- Connecter d'abord la prise de terre de sécurité verte (terre) avant d'effectuer toute autre connexion.
 - Ouvrir les disjoncteurs correspondants lors d'une connexion à des circuits électriques ou à des équipement de génération d'impulsions. NE PAS effectuer de connexion d'instrument sur des lignes électriques sous tension.
 - Une fois toutes les connexions de l'instrument effectuées, connecter au circuit à contrôler.
-

Continued on next page

Overview, Continued

-
- Porter des lunettes de protection et des gants isolants pour effectuer des connexions aux circuits électriques.
 - S'assurer que les mains, les chaussures et le sol soient secs lors de connexions à une ligne électrique.
 - S'assurer que l'unité est ÉTEINTE avant de connecter les sondes au panneau arrière.
 - Inspecter tous les câbles, avant chaque utilisation, pour s'assurer que les isolants ne sont pas coupés ou fendus. Remplacer immédiatement tous les équipements défectueux.
-

Sicherheitsvorkehrungen

Die folgenden Sicherheitsvorkehrungen sind immer dann zu befolgen, wenn eine Verbindung zum Instrument hergestellt wird.

- Schließen Sie zuerst die grüne Sicherheits-/Erdleitung an, bevor Sie eine andere Verbindung herstellen.
 - Öffnen Sie beim Anschluß an elektrische Stromkreise oder Impulsauslösungseinrichtungen die entsprechenden Unterbrecher. Es dürfen KEINE Anschlüsse an das Instrument unter stromführenden Spannungsleitungen montiert werden.
 - Die Verbindungen müssen zuerst am Instrument und danach an der zu überwachenden Schaltung hergestellt werden.
 - Tragen Sie Schutzbrillen und Isolierhandschuhe, wenn Sie Anschlüsse an den Stromkreisen vornehmen.
 - Hände, Schuhe und Fußboden müssen trocken sein, wenn Sie Anschlüsse an den Stromkreisen durchführen.
 - Stellen Sie sicher, daß das Gerät AUSgeschaltet ist, bevor Sie an der rückwärtigen Konsole Meßfühler anschließen.
 - Prüfen Sie vor jedem Gebrauch alle Kabel auf Bruchstellen und Risse in der Isolierung. Wechseln Sie schadhafte Kabel sofort aus.
-

In this section

The following topics are covered in this section.

Topic	See Page
Connecting a Voltage Probe	4-15
Connecting to a Potential Transformer (PT)	4-20
Connecting a Current Probe	4-22
Connecting to a Current Transformer (CT)	4-26
Connecting to an Isolated Current Transformer (ISO)	4-28
Verifying Voltage and Current Connections	4-34

Connecting a Voltage Probe

Safety precautions

Follow the safety precautions listed on page 4-12 when making all voltage probe connections.

Medidas de seguridad

Siga las medidas de seguridad listadas en la página 4-13 cuando efectúe todas las conexiones potenciales del transformador.

Mesures de sécurité

Suivez les mesures de sécurité données en page 4-13 lors de la réalisation de toutes les connexions du transformateur de tension.

Sicherheitsvorkehrungen

Folgen Sie den auf Seite 4-14 aufgeführten Sicherheitsvorkehrungen, wenn Sie an potentiellen Trafo-Verbindungen arbeiten.

Measurement cable set

Description: Voltage probes, jumpers, and power cord are provided as standard accessories and are stored in a cable pallet as part of the measurement cable set, part number 115815-G1 (Domestic), 115815-G2 (Euro), or 115815-G3 (UK).

Voltage Rating: Direct connection of all voltage probes for measurement are rated at 600 Vrms max. For measuring voltages greater than 600 Vrms Potential Transformers (PT's) must be used.

Contents: The voltage cables are shown in the figure on the next page (positioned relative to their actual use) and consist of the following:

- Eight, 8-foot channel measurement cable assemblies (probes), each with a detachable, crocodile jaw, safety clip assembly. The safety clip assemblies are red (+) and black (-) for each of the four channels. One probe assembly each of red (channel A), yellow (channel B), and blue (channel C) and five each of black are provided.
- Four 1-foot blue jumpers for input connector jumpering.
- A shielded power cord.

A pallet for storage of the cables and the input power cord are included in the contents of the measurement cable set but are not shown in the figure.

Continued on next page

Connecting a Voltage Probe, Continued

Voltage Safety Clip Assemblies

Voltage safety clips, shown below, are supplied as four sets of the standard accessory measurement cable set. Each clip is a detachable, crocodile jaw type voltage probe that connects to a slip-on end connector of the channel measurement cables.

Voltage Safety Clip, Red
(Fluke, Model AC20-2)

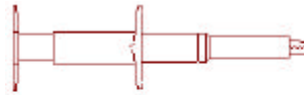

Voltage Safety Clip, Black
(Fluke, Model AC20-0)

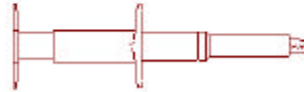

WARNING

Do not exceed 600 Vrms for the safety clip assemblies. The safety clip assemblies supplied are intended for use with Dranetz products only and we do not authorize them for any other use.

ADVERTENCIA

No supere los 600 V, valor eficaz, en los conjuntos de pinzas de seguridad. Los conjuntos provistos están diseñados para ser usados con productos Dranetz únicamente y no están autorizados para ningún otro uso.

AVERTISSEMENT

Ne dépassez pas 600 Veff pour les assemblages de clips de sécurité. Ces assemblages ont été conçus pour être utilisés avec les produits Dranetz seulement; nous n'autorisons aucune autre utilisation.

WARNUNG

Die Effektivspannung für die Sicherheitsklammern darf 600 Volt nicht überschreiten. Die mitgelieferten Sicherheitsklammern dürfen nur mit Produkten von Dranetz benutzt werden. Eine Verwendung auf einer anderen Art und Weise ist nicht gestattet.

Connecting a Voltage Probe, Continued

Measurement cable set

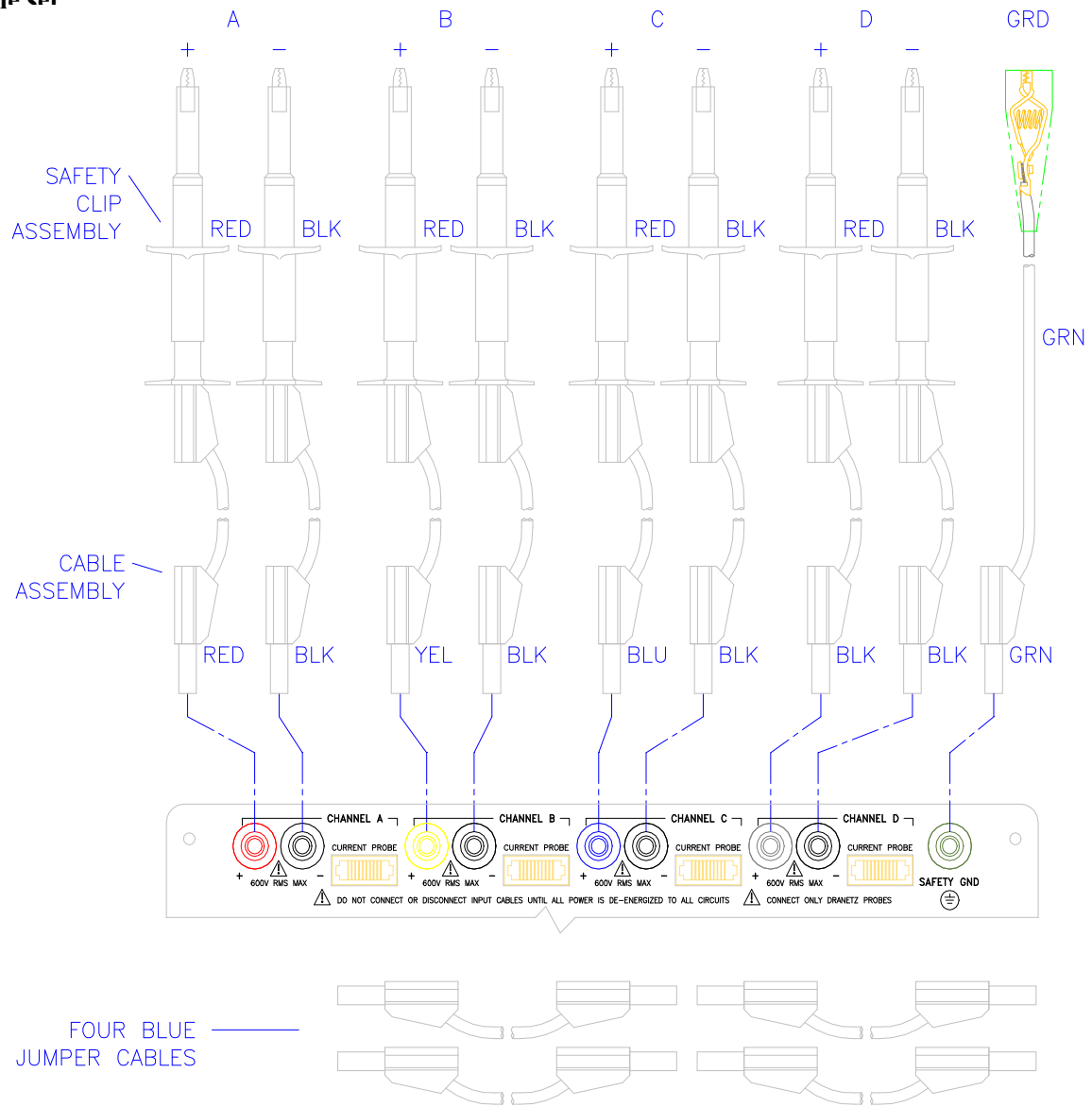

NOTE: Pallet and input power cable not shown.

8600-28

Connecting a Voltage Probe, Continued

Connection guidelines

Follow these guidelines when making voltage connections.

- Refer to the measurement test set figure for color coding of probes that connect to input channel connectors A, B, C, and D.
- Each channel input has plus (+) and minus (-) differential inputs of 60 to 600Vrms max. Unused voltage channel differential inputs must be jumpered together using the blue jumpers provided.
- Channel D has an additional low voltage range of 0 to 60 Vrms max. for low voltage measurements.

Single phase connection example

The following figure shows a voltage connection to a single phase circuit for channel A. Jumpers are used to connect the differential inputs of channels B, C, and D together as shown to prevent erroneous data. The green cable is always connected to a secure ground (earth) connection as a safety ground.

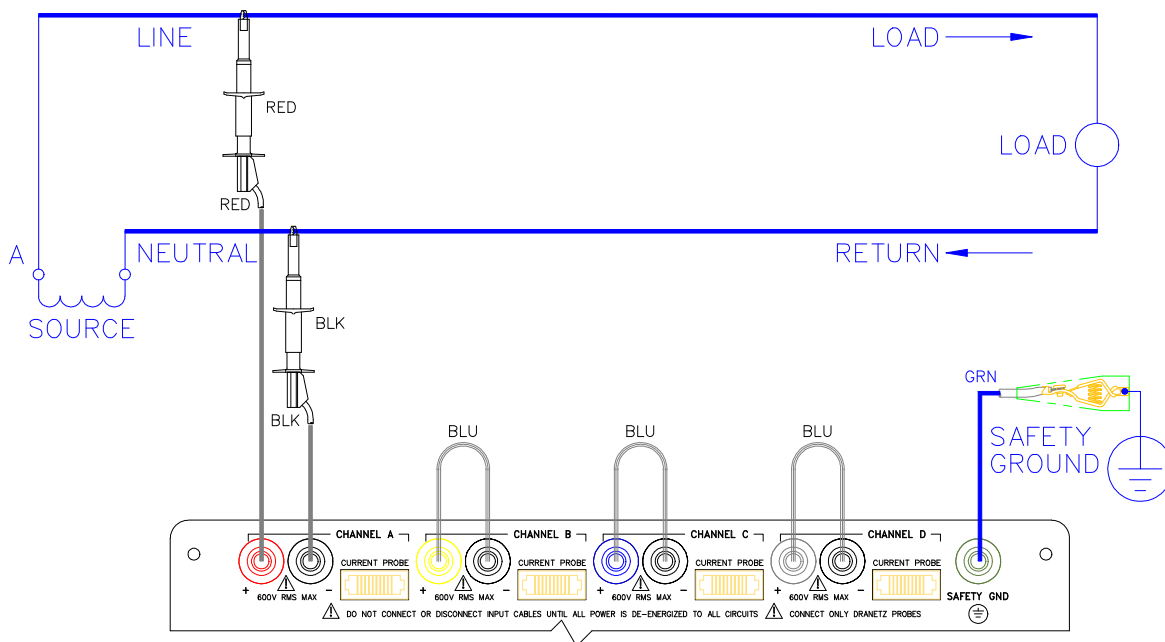

8600-18

Continued on next page

Connecting a Voltage Probe, Continued

Neutral to ground connection example

The following figure shows a voltage connection using channel D as a differential input for a single phase connection. Connections are identical for split phase, delta, and wye configurations. One probe connects the source neutral line to the D+ input. Another probe connects the safety ground to the D- input. Any channel input may be used to perform this measurement but Channel D is usually used because it provides a low voltage range of 0 to 60 Vrms.

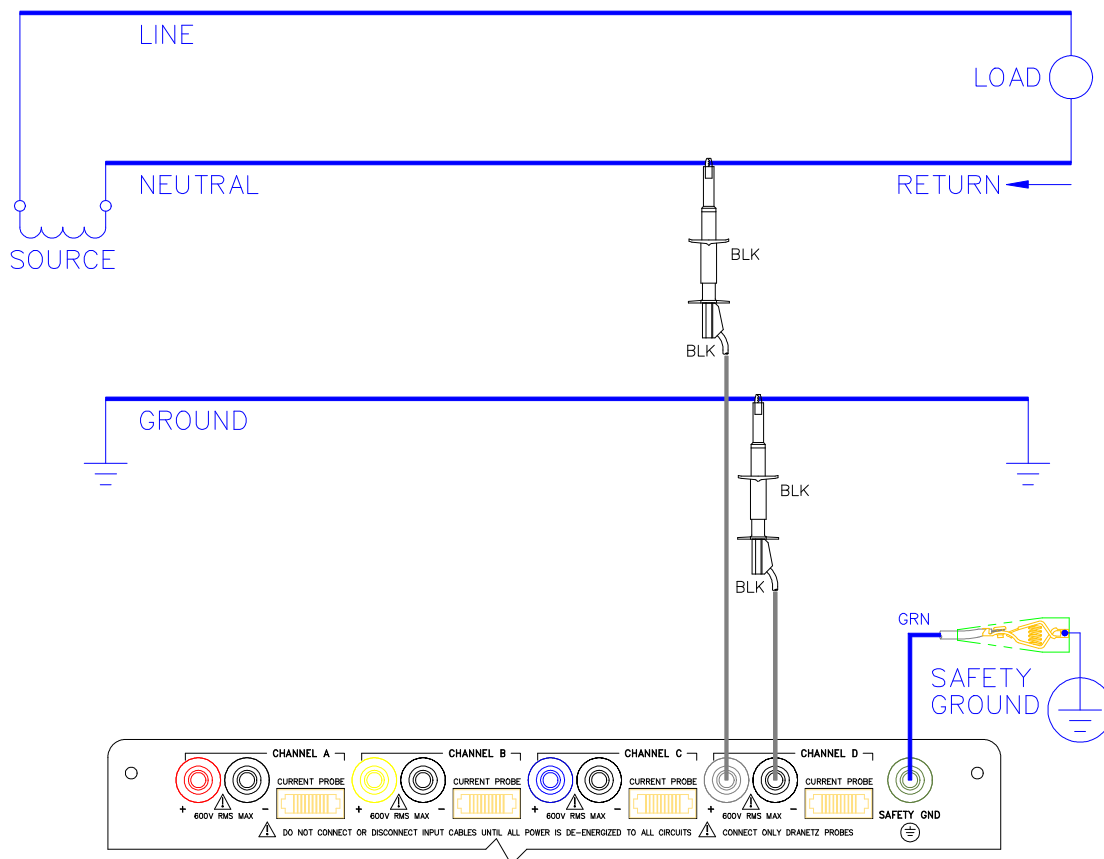

8600-19

Continued on next page

Connecting to a Potential Transformer (PT)

**Safety
Precautions**

Follow the safety precautions listed on page 4-12 when making all potential transformer connections.

**Medidas de
seguridad**

Siga las medidas de seguridad listadas en la página 4-13 cuando efectúe todas las conexiones potenciales del transformador.

**Mesures de
sécurité**

Suivez les mesures de sécurité données en page 4-13 lors de la réalisation de toutes les connexions du transformateur de tension.

Sicherheitsvorkehrungen

Folgen Sie den auf Seite 4-14 aufgeführten Sicherheitsvorkehrungen, wenn Sie an potentiellen Trafo-Verbindungen arbeiten.

Note

Potential Transformers are not manufactured by Dranetz and are discussed here for informational purposes only.

Definition

A potential transformer (PT), also referred to as a voltage instrument transformer, provides the necessary step-down ratio to reduce the high voltage of circuits above 600V_{rms} to a level for safe measurement. A PT also provides isolation and proper connections for instrument attachment.

Connections

PT's are usually fixed in position and require that the voltage probe(s) be connected to their terminal connections.

WARNING

Refer to the manufacturer's instructions, related to the PT, for exact information for probe connection for voltage monitoring. Do not exceed 600V_{rms} input to the PP1 Voltage inputs.

ADVERTENCIA

Consulte las instrucciones del fabricante referentes a TP (transformador potencial), para la información exacta de la conexión de sonda a fin de monitorear el voltaje. No supere la entrada de 600 V_{rms} a las entradas de voltaje de PP1.

Continued on next page

Connecting to a Potential Transformer (PT), Continued

AVERTISSEMENT

Se reporter aux instructions du fabricant relatives au transformateur de tension (Potential Transformer - PT) pour obtenir les renseignements exacts sur la connexion de sonde utilisée pour la surveillance du courant. Ne pas dépasser l'entrée de tension efficace de 600 RMS dans les entrées de tension de PP1.

WARNUNG

Genaue Informationen zur Meßfühlerverbindung für die Spannungsüberwachung entnehmen Sie bitte den Anleitungen des Herstellers (siehe Spannungsteilertransformator). Die Eingangsspannung von 600 V (Effektivwert) in die PP1 Spannungseingänge sollte nicht überschritten werden.

Procedure

Follow these steps to connect voltage probes to a potential transformer.

Step	Action
1	Turn off power to the PT.
2	Connect the green ground connector to the Safety Gnd connector on the rear panel of the Power Platform.
3	Connect the green ground connector to a solid ground point at or near the PT in accordance with the PT manufacturer's instructions.
4	Connect the colored voltage probes to the PT's connections in accordance with the manufacturer's instructions.
5	Connect the colored voltage probes to the channel inputs designated for monitoring.
6	Turn on power to the PT.

Scale factor

The scale factor of the PT must be accounted for in making accurate voltage measurements. Because the monitored output voltage of the PT is stepped-down (divided) from the original voltage, this ratio must be stepped-up (multiplied) by the PP1-PQPlus when voltage computations are performed. The PT scale factor is usually mounted on the PT assembly and is entered into the PP1-PQPlus on the scale factors screen (refer to Chapter 5). Refer to the PT manufacturer's literature for definition of the scale factors.

Connecting a Current Probe

Safety precautions

The following safety precautions apply to current probe connections in addition to those safety precautions stated on page 4-12.

- DO NOT attempt to measure current in any circuit in which the circuit to ground voltage exceeds the insulation rating of the current probe (600 Vrms max).
 - Make sure the jaws of the current probe are tightly closed. Keep mating surfaces clean and free from foreign matter.
-

Medidas de seguridad

Las siguientes precauciones de seguridad se aplican a las conexiones de la sonda actual además de las precauciones de seguridad que aparecen en la página 4-13.

- NO deberá intentar medir la corriente eléctrica en ningún circuito en que el voltaje del mismo a tierra sea mayor al promedio de aislamiento de la sonda eléctrica (600 Vrms máx).
 - Verifique que la mordaza de la sonda eléctrica esté bien apretada. Mantenga las superficies de fusión limpias y libres de materia extraña.
-

Mesures de sécurité

Les consignes de sécurité suivantes doivent être respectées en plus des consignes de sécurité données en page 4-13 lors de la réalisation de connexions de sondes.

- NE PAS essayer de mesurer le courant dans un circuit où la tension est supérieure au régime d'isolation de la sonde (600 Vrms max.).
 - S'assurer que les mâchoires de la sonde sont bien serrées. S'assurer que la surface de contact est propre et exempte de corps étrangers.
-

Sicherheitsvorkehrungen

Die folgenden Sicherheitsmaßnahmen treffen auf derzeitige "Probe"-Verbindungen zu und gelten zusätzlich zu den Sicherheitsmaßnahmen auf Seite 4-14.

- Versuchen Sie NICHT, den Strom in einem Schaltkreis zu messen, in dem der Durchgang zur Erdspannung den Isolierwert des Spannungsmeßfühlers (600 Volt Effektivwert) übersteigt.
 - Stellen Sie sicher, daß die Klemmbanken des Spannungsmeßfühlers fest geschlossen sind. Halten Sie die zusammengehörigen Oberflächen sauber und frei von Fremdteilen.
-

Continued on next page

Connecting a Current Probe, Continued

Types of current probes Several types of current probes¹ (clamp-on current transformers) are available as optional accessories. These probes are shown in the figure on the next page and consist of the smallest current probe (Dranetz model CT10), used to monitor up to 10 amps rms max, to the largest current probe (Dranetz model CT3000) for measurements up to 3000 amps rms max.

Refer to Appendix F for complete probe specifications.

WARNING When using either the CT-10 or CT-150 current probe, **DO NOT** connect the probe jaws around a non-insulated wire. These probes are to be used to monitor current of insulated wire only.

ADVERTENCIA Cuando use la punta de prueba de corriente CT-10 o CT-150, **NO** sujete las mandíbulas de la punta alrededor de un cable sin aislación. Esta punta se usa para mediciones en cables aislados solamente.

AVERTISSEMENT Lorsque vous utilisez la sonde de courant CT-10 ou CT-150, **NE FERMEZ PAS** les mâchoires de la sonde sur un fil non isolé. Cette sonde ne doit être utilisée qu'avec des fils isolés.

WARNUNG Der Stromfühler CT-10 oder CT-150 **DARF NICHT** an ein unisoliertes Kabel angeschlossen werden. Dieser Stromfühler darf nur für die Überwachung von isolierten Kabeln benutzt werden.

Description Each probe has a polarized plug to fit any one of the four current input connectors (A, B, C, or D) on the rear panel of the Power Platform.

Maximum jaw openings are described in the specifications in Appendix F.

An arrow marking on the handle is a guide to ensure that you position the probe with the arrow pointing towards the load. Correct position of the probe is necessary for correct power measurements.

1. Portions of this product manufactured under license from BMI, Patent No. 5,089,979.

Connecting a Current Probe, Continued

Wire marker kit The wire marker kit, supplied as a standard accessory, helps you identify which current probe is connected to each current channel input. This kit, part number 155520, contains adhesive backed color-coded marker labels to attach to the probe handle and the plug end of the probe. Use red label for channel A, yellow for B, and blue for C. Channel D is left unmarked. See figure for proper wire marker placement.

Wire marker placement

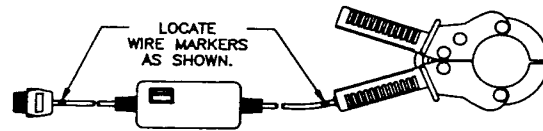

8600-62

Dranetz current probes

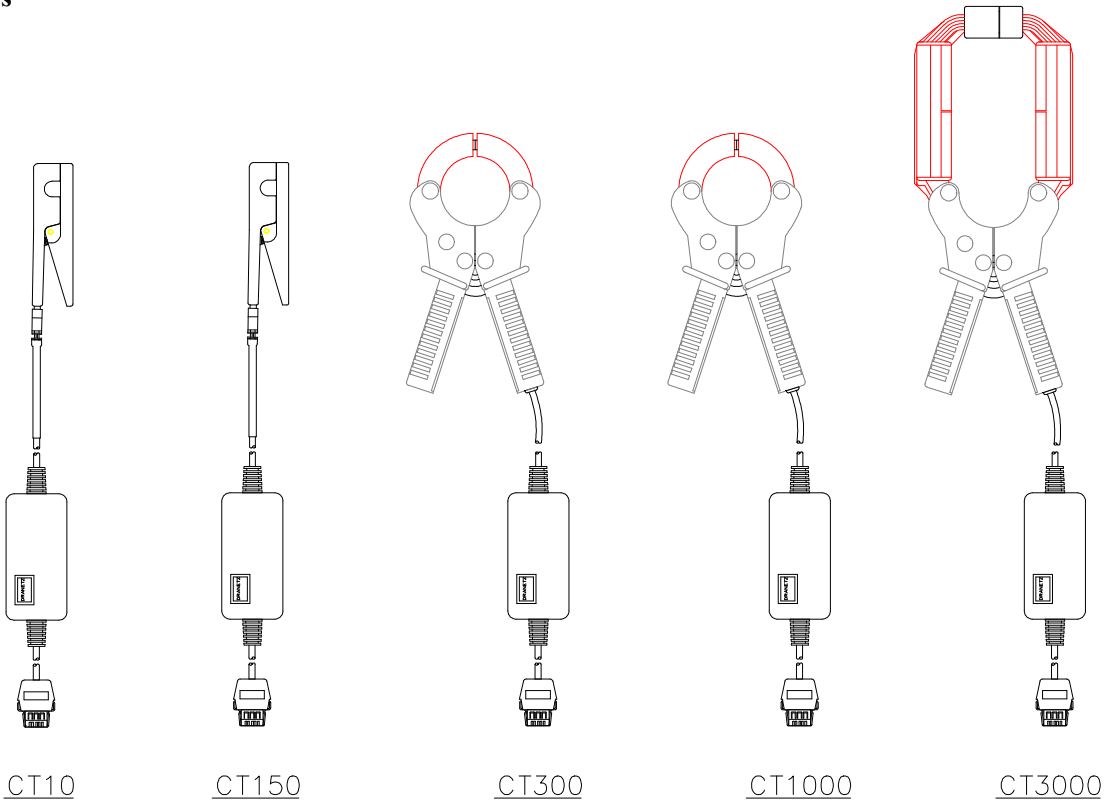

8600-21

Connecting a Current Probe, Continued

Connection guidelines

Follow these guidelines when making current connections.

- Position the probe with the arrow on the handle facing the load.
- For greatest accuracy, use a probe that is rated at no more than twice the nominal value you expect to measure.

Example

The following figure shows how to connect a current probe to channel A for current monitoring of a single phase line.

The current probe may be connected to the return line if desired to measure the return current when checking for load current leakage, loop current relationships, etc.

Single phase current probe connection example

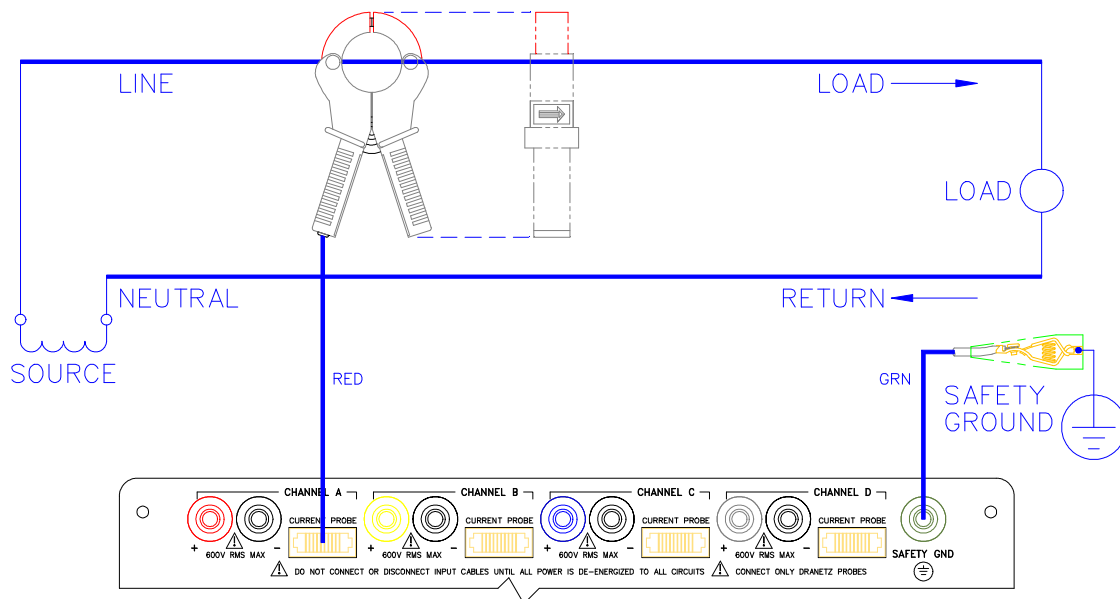

8600-20

Note

The connection shown above is not recommended without a voltage connection to ensure frequency synchronization. If this configuration is used, then an internal frequency reference must be entered. Refer to page 5-9.

Connecting to a Current Transformer (CT)

Safety precautions

The following safety precautions apply to current transformer (CT) connections in addition to those safety precautions stated on page 4-12.

- Never energize a CT with the secondary open.
 - Never disconnect the secondary of a CT with primary energized.
-

Medidas de seguridad

Las medidas de seguridad siguientes corresponden a conexiones de transformadores eléctricos (CT) además de las medidas de seguridad que aparecen en la página 4-13.

- Nunca deberá poner bajo tensión un CT con el transformador secundario abierto.
 - Nunca deberá desconectar el transformador secundario de un transformador eléctrico si el transformador primario está bajo tensión.
-

Mesures de sécurité

Les mesures de sécurité suivantes s'appliquent aux connexions de transformateurs de couranten plus des mesures de sécurité données en page 4-13.

- Un jamais mettre un transformateur sous tension lorsque la bobine secondaire est ouverte.
 - Ne jamais déconnecter la bobine secondaire d'un transformateur lorsque la bobine primaire est sous tension.
-

Sicherheitsvorkehrungen

Die folgenden Sicherheitsvorkehrungen gelten für Anschlüsse an Transformatoren und gelten zusätzlich zu den Sicherheitsvorkehrungen auf Seite 4-14.

- Führen Sie einem Transformator niemals Strom zu, wenn die Niederspannungsseite geöffnet ist.
 - Lösen Sie niemals die Verbindung der Niederspannungsseite eines Transformators, wenn die Oberspannungsseite unter Strom steht.
-

WARNING

Refer to the manufacturer's instructions related to the CT for exact information for connections for current monitoring. Do not exceed manufacturer's ratings.

ADVERTENCIA

Consulte las instrucciones del fabricante referentes a TC (transformador de corriente) para la información exacta de las conexiones a fin de monitorear la corriente. No exceda las capacidades nominales del fabricante.

Connecting to a Current Transformer (CT), Continued

ADVERTISSE- MENT

Se reporter aux instructions du fabricant relatives au transformateur de courant (Current Transformer - CT) pour obtenir les renseignements exacts sur les connexions utilisées pour la surveillance du courant. Ne pas dépasser la puissance recommandée par le fabricant.

WARNUNG

Genaue Informationen zu Verbindungen für die Stromüberwachung entnehmen Sie bitte den Anleitungen des Herstellers (siehe Stromumwandler). Die Grenzwerte des Herstellers sollten nicht überschritten werden.

Note

Current Transformers are not manufactured by Dranetz and are discussed here for informational purposes only.

Description

Current transformers, also known as instrument transformers, reduce high level currents to low level currents so they can be safely monitored. These devices are similar to PT's used for voltage measurements in that both reduce values for safe measurement. The reduction, or step-down ratio, is stated as a scale factor that is used by the PP1-PQPlus to step-up the measured value to its original value.

Types of CT's

There are single-phase CT's and polyphase CT's dependent on the source transformer used. Current reduction ratios vary widely and are also dependent on the source transformer used. Rating plates attached to the CT provide information as to the ratio and current limitations.

Connecting to an Isolated Current Transformer (ISO)

Safety precautions

The following safety precautions apply to isolated current transformer connections in addition to those safety precautions stated on page 4-12.

- Never energize a CT with the secondary open.
- Never disconnect the secondary of a CT probe with primary energized.

Medidas de seguridad

Las medidas de seguridad siguientes corresponden a conexiones de transformadores eléctricos (CT).

- Nunca deberá poner bajo tensión un CT con el transformador secundario abierto.
- Nunca deberá desconectar el transformador secundario de un transformador eléctrico si el transformador primario está bajo tensión.

Mesures de sécurité

Les mesures de sécurité suivantes s'appliquent aux connexions de transformateurs de courant.

- Un jamais mettre un transformateur sous tension lorsque la bobine secondaire est ouverte.
- Ne jamais déconnecter la bobine secondaire d'un transformateur lorsque la bobine primaire est sous tension.

Sicherheitsvorkehrungen

Die folgenden Sicherheitsvorkehrungen gelten für Anschlüsse an Transformatoren.

- Führen Sie einem Transformator niemals Strom zu, wenn die Niederspannungsseite geöffnet ist.
- Lösen Sie niemals die Verbindung der Niederspannungsseite eines Transformators, wenn die Oberspannungsseite unter Strom steht.

Description

Low current monitoring devices made by Dranetz are called isolated current transformers or ISO boxes for short. Dranetz makes two types of ISO boxes; one model (ISO-1A) monitors up to 1 amp rms of current maximum, the other model (ISO-5) up to 5 amps rms maximum. Both are available as optional accessories.

WARNING

Physical injury or equipment damage could result if ISO boxes are improperly connected. Do not connect an ISO box between two conductors which are at different voltage potentials.

Continued on next page

Connecting to an Isolated Current Transformer (ISO), Continued

ADVERTENCIA

Podrían producirse lesiones físicas o daños al equipo si se conectan indebidamente las cajas del transformador aislado de corriente (ISO). No conecte una caja del ISO entre dos conductores que tengan distintos potenciales de voltaje.

AVERTISSEMENT

Une mauvaise connexion des transformateurs d'intensité isolés (ISO) peut provoquer des blessures corporelles ou des dégâts matériels. Ne pas relier les transformateurs ISO entre deux conducteurs de tensions différentes.

WARNUNG

Falsch angeschlossene ISO-Kästen (Isolierte Stromumwandler) können zu körperlichen Verletzungen oder Geräteschäden führen. Schliessen Sie einen ISO-Kasten nicht zwischen zwei Leiter mit unterschiedlichem Spannungspotential.

Applications

ISO boxes can be used in a number of ways. These methods include connecting them to the secondary of CT's for metering by the PP1-PQPlus, inserting them in series with the load current to measure low current values, and connecting them to a non-Dranetz clamp-on current transformer and using that CT to monitor current with the PP1-PQPlus.

Continued on next page

Connecting to an Isolated Current Transformer (ISO), Continued

ISO box connection to a current transformer

The figure below shows an ISO box connected from Channel B current input to a permanently installed CT. Polarities of the ISO box and CT are kept in-phase by matching markings. Scale factors of both devices must be multiplied together to get the resultant scale factor. Refer to page 5-6 for more information about scale factors.

ISO box connection to a CT

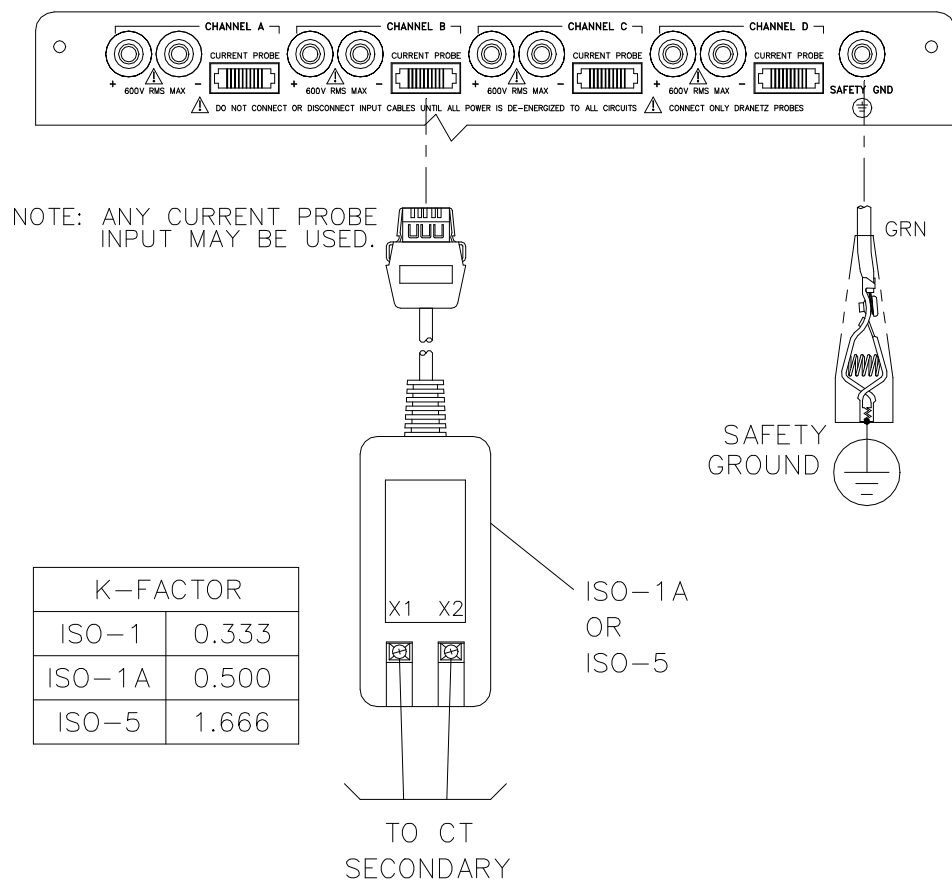

8600-24

Continued on next page

Connecting to an Isolated Current Transformer (ISO), Continued

ISO box in-line connection

The figure below shows the ISO box connected in series with the load of a single-phase line. The connection is made with the X1 terminal connected to the source input line and X2 connected to the load line. The scale factor is that of the ISO box only.

ISO box connection in-line with a load

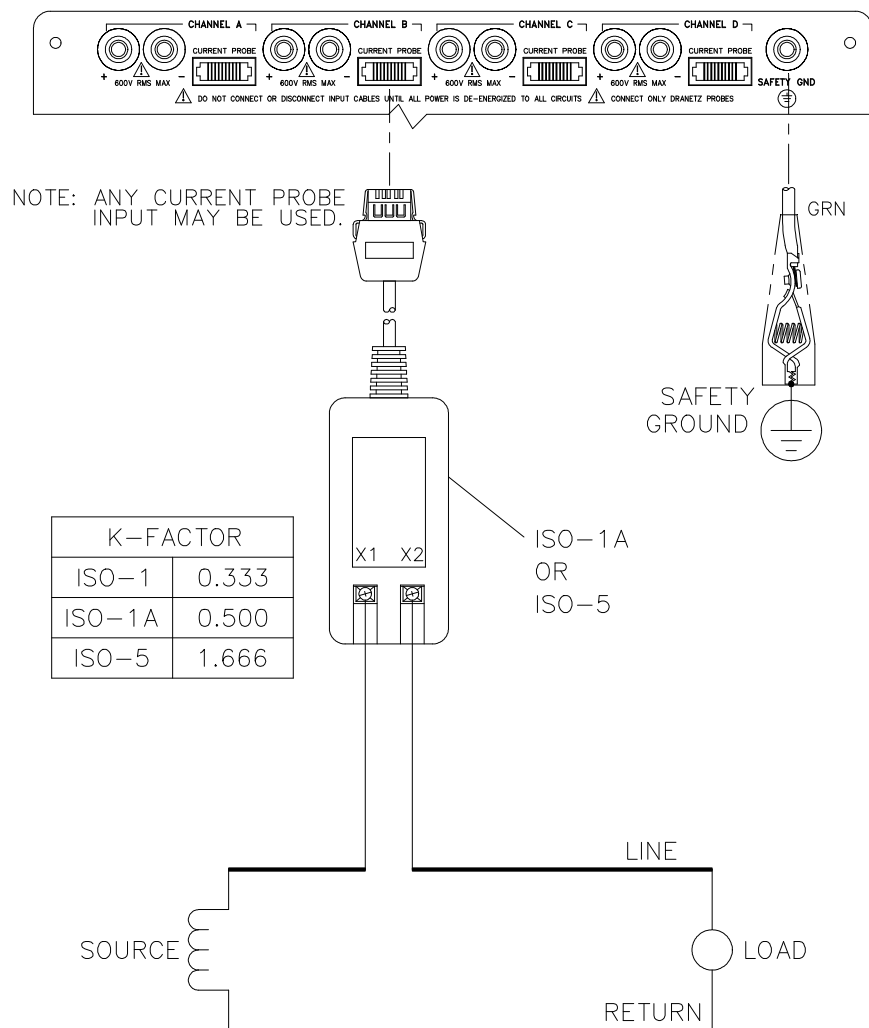

8600-25

Continued on next page

Connecting to an Isolated Current Transformer (ISO), Continued

Connecting to a non-Dranetz current probe The figure below shows the ISO box connected to a non-Dranetz clamp-on current transformer. In this case the scale factor is the product of the ISO box and the CT. Refer to manufacturer's literature to determine the CT scale factor.

WARNING Refer to the manufacturer's instructions related to the CT for exact information for connections for current monitoring. Do not exceed manufacturer's ratings.

ADVERTENCIA Consulte las instrucciones del fabricante referentes a TC (transformador de corriente) para la información exacta de las conexiones a fin de monitorear la corriente. No exceda las capacidades nominales del fabricante.

ADVERTISSEMENT Se reporter aux instructions du fabricant relatives au transformateur de courant (Current Transformer - CT) pour obtenir les renseignements exacts sur les connexions utilisées pour la surveillance du courant. Ne pas dépasser la puissance recommandée par le fabricant.

WARNUNG Genaue Informationen zu Verbindungen für die Stromüberwachung entnehmen Sie bitte den Anleitungen des Herstellers (siehe Stromumwandler). Die Grenzwerte des Herstellers sollten nicht überschritten werden.

Continued on next page

Connecting to an Isolated Current Transformer (ISO), Continued

Diagram

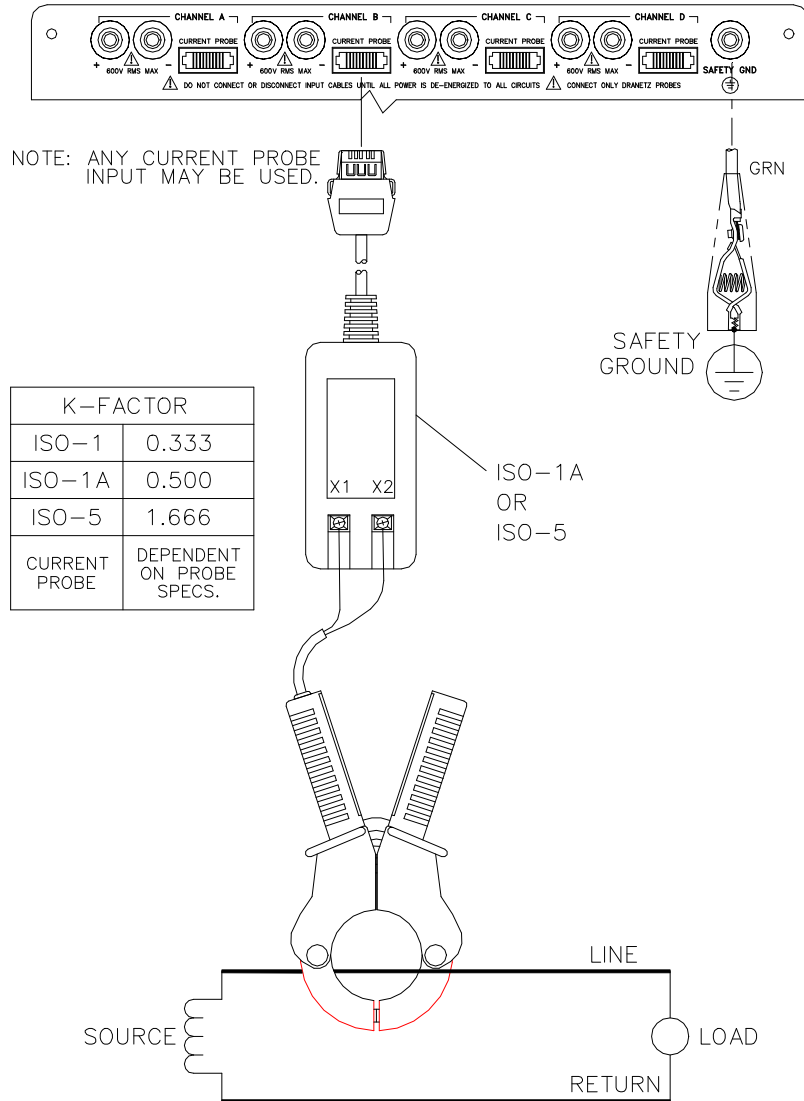

8600-26

Verifying Voltage and Current Connections

Introduction

Correct voltage and current connection of single phase, split phase, or polyphase connections can be verified using phasor diagrams. Phasor diagrams are graphic representations that show the magnitude and angular relationship of each phase of a monitored connection.

Displaying the screen

Follow these steps to display the Voltage and Current Phasor screen.

Step	Action
1	From Main Menu, select item 2, Scope Mode.
2	From Scope Mode, press METER MODE.
3	From Meter Mode Menu, select item 4, Voltage and Current Phasors.

Note: The following screen will appear if no voltage inputs are connected. See next page for actual inputs.

Single phase

A single phase voltage or current phasor is displayed as a single line showing a channel reference at 0 degrees and a magnitude relative to its measured value. An arrowhead on the line indicates direction.

Split phase

Split phase vectors are displayed as dual lines showing channel references and magnitudes and opposite (180 degrees) directions.

Three phase

Three phase vectors are displayed as three lines, 120 degrees apart in a resistive load (unity power factor). Phase displacement will occur in a reactive load.

Continued on next page

Verifying Voltage and Current Connections, Continued

Correct 3-phase voltage phasor connections

The voltage phasor display shown below is for a three phase, four wire, wye connection.

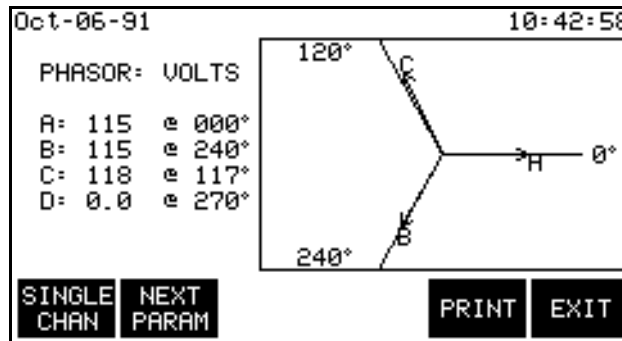

Correct 3-phase current phasor connections

The current phasor display shown below is for a three phase, 4 wire wye connection.

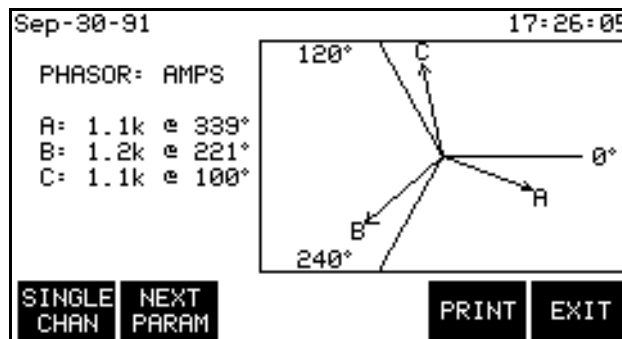

Continued on next page

Verifying Voltage and Current Connections, Continued

Incorrect current phasor diagram

The following phasor display shows an incorrect current probe connection. The phasor for channel C is 180° out of phase. This can be corrected by connecting the probe so that the arrow on the probe handle points toward the load.

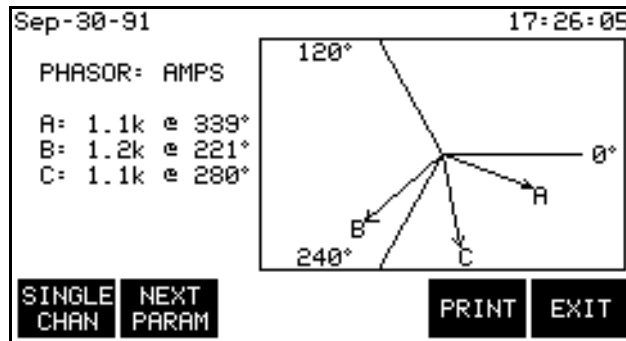

Single channel phasor diagram

The following display shows the voltage and current phasors for channel A.

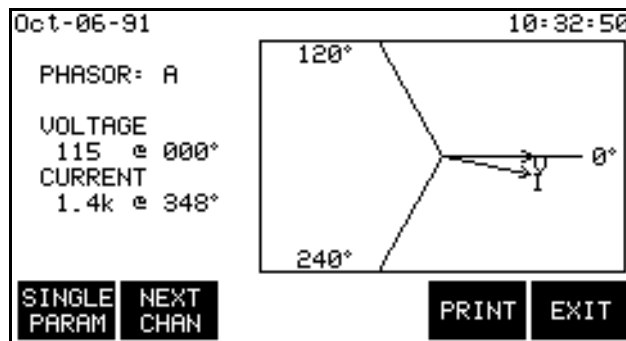

Section C

Circuit Diagrams for Power Measurements

Overview

Who should read this section

If you are making power measurements, follow these diagrams so that your ABC totals are calculated correctly.

If you are not making power measurements, you can skip this section and go to Section D.

Safety Precautions

Follow the safety precautions listed on page 4-12 when making connections.

Medidas de seguridad

Siga las medidas de seguridad listadas en la página 4-13 cuando efectúe todas las conexiones potenciales del transformador.

Mesures de sécurité

Suivez les mesures de sécurité données en page 4-13 lors de la réalisation de toutes les connexions du transformateur de tension.

Sicherheitsvorkehrungen

Folgen Sie den auf Seite 4-14 aufgeführten Sicherheitsvorkehrungen, wenn Sie an potentiellen Trafo-Verbindungen arbeiten.

Voltage and current connections

This section contains numerous drawings of both voltage and current probe connections that are required when power measurements are to be made.

Voltage: Voltage probes are connected to the individual source or load line and are referenced to the return (common) line voltage probe connection for greatest accuracy.

Current: Current probes are connected to each line and positioned to measure currents with reference to the voltage probe. Incorrectly positioned current probes may produce erroneous power measurement.

Continued on next page

Overview Continued

In this section The following power connection diagrams are shown in this section.

Diagram	See Page
Single Phase	4-39
Split Phase	4-40
Four Wire Wye	4-41
Floating Delta	4-42
Delta, One Leg Grounded	4-43
Open Leg Delta	4-44
High-Leg Delta	4-45
Phasor Diagrams for Standard Power Connections	4-46

Single Phase

Introduction

When making voltage connections to a single phase circuit use channel A differential inputs as shown below. Connect both terminals of channels B, C, and D together to prevent erroneous data. Channels D should be turned off if not used.

Note

Be sure to connect the current probe with the arrow on the handle pointing towards the load or an erroneous power reading will result.

Diagram

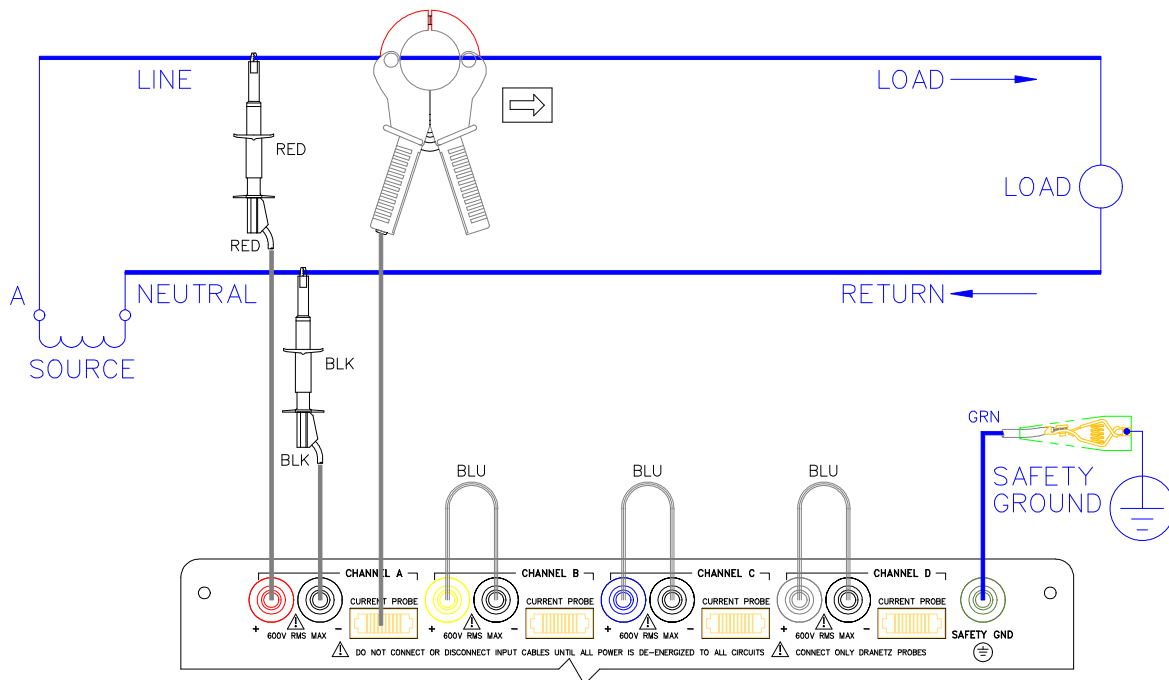

8600-6

Split Phase

Introduction

When making split phase measurements use both channels A and B for voltage and current connections. Connect both terminals of Channels C and D together to prevent erroneous data. The neutral is chosen as the reference for measurement purposes.

Diagram

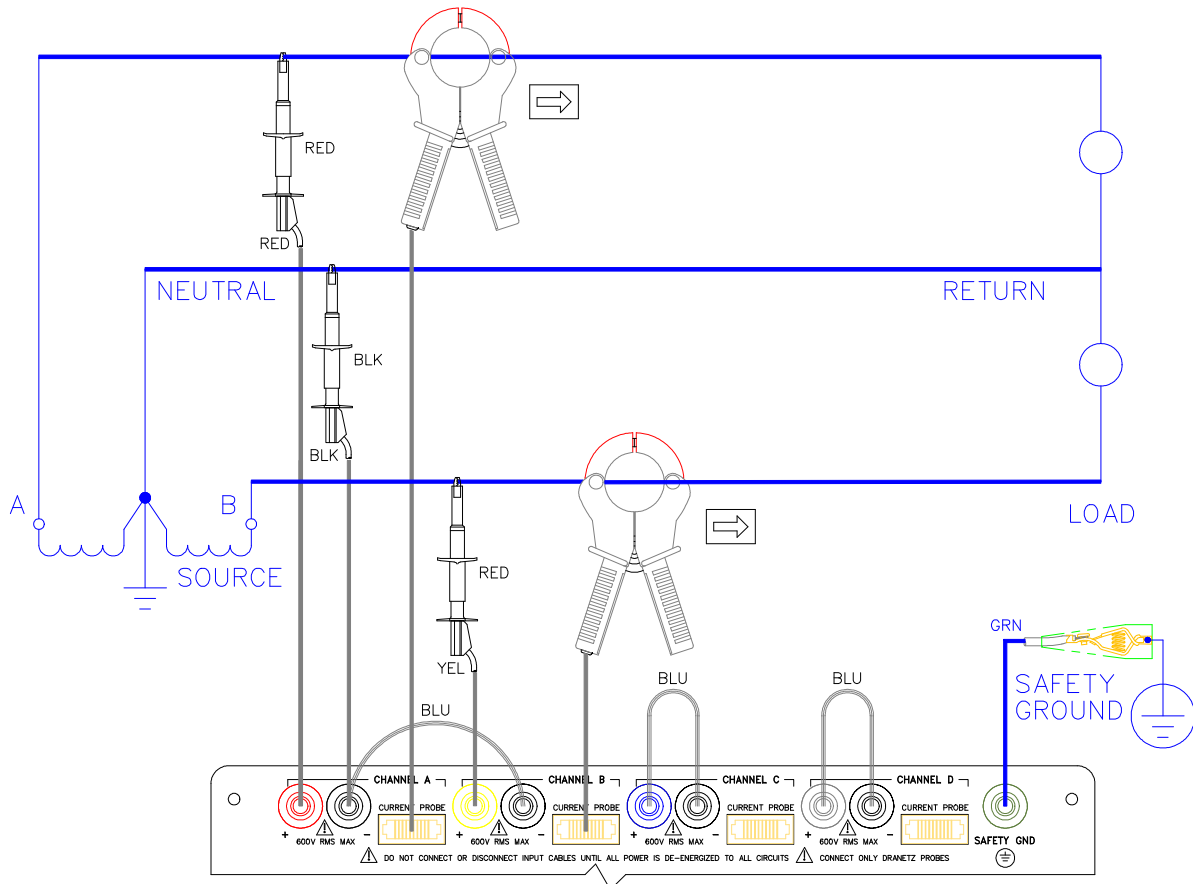

8600-7

Four Wire Wye

Introduction

Channels A, B, and C are connected to voltage and current probes. The neutral is connected to common and is the reference for the three channels. Connect both terminals of Channel D together to prevent erroneous data.

Diagram

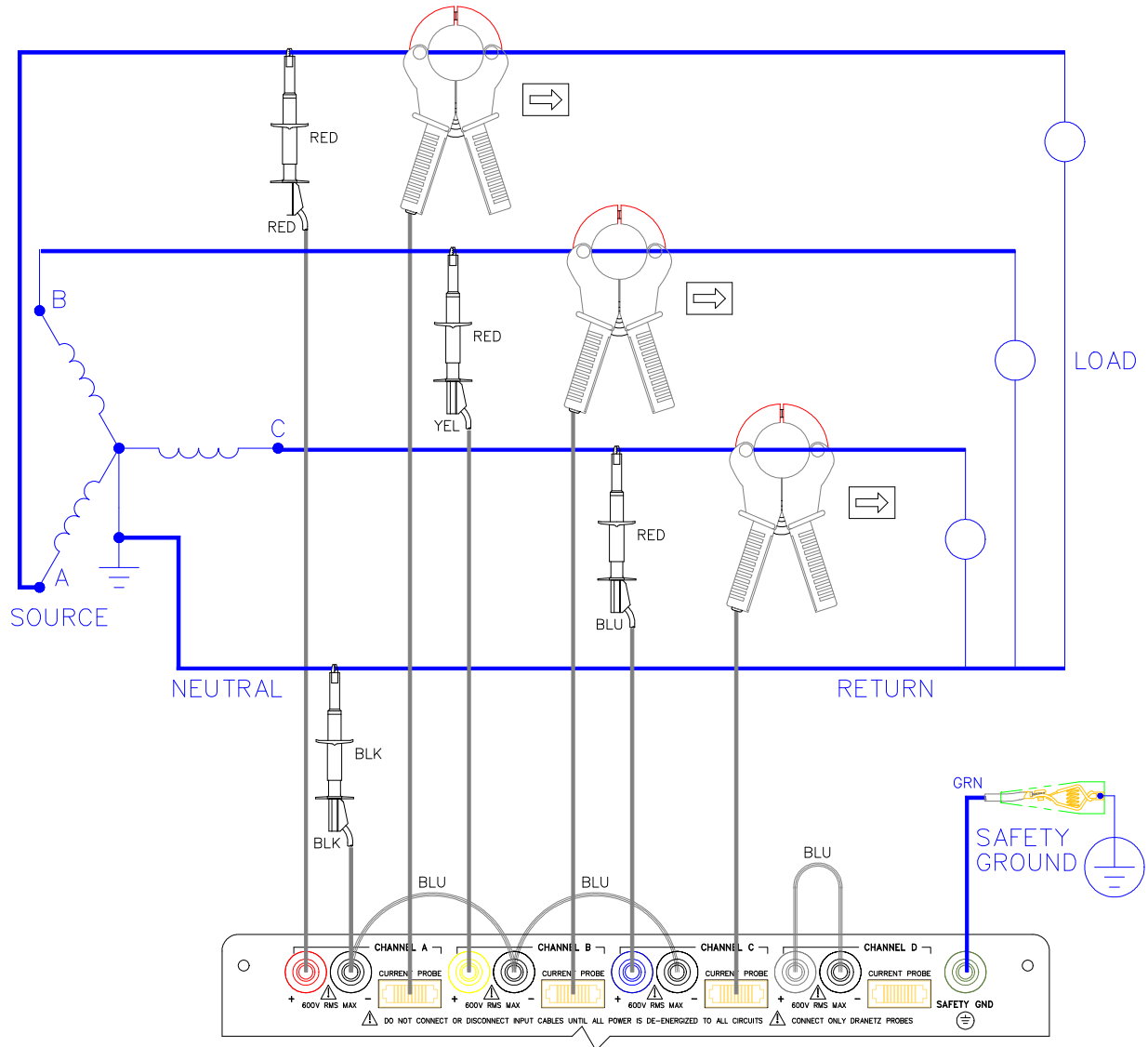

8600-12

Floating Delta

Introduction

In this power connection, the PP1-PQPlus uses voltage channels A, B, and C as differential inputs with channel A using source voltage A-B, channel B using B-C, and channel C using C-A as the reference. Current probes are connected to channels A, B, and C. Connect both terminals of Channel D together to prevent erroneous data.

Diagram

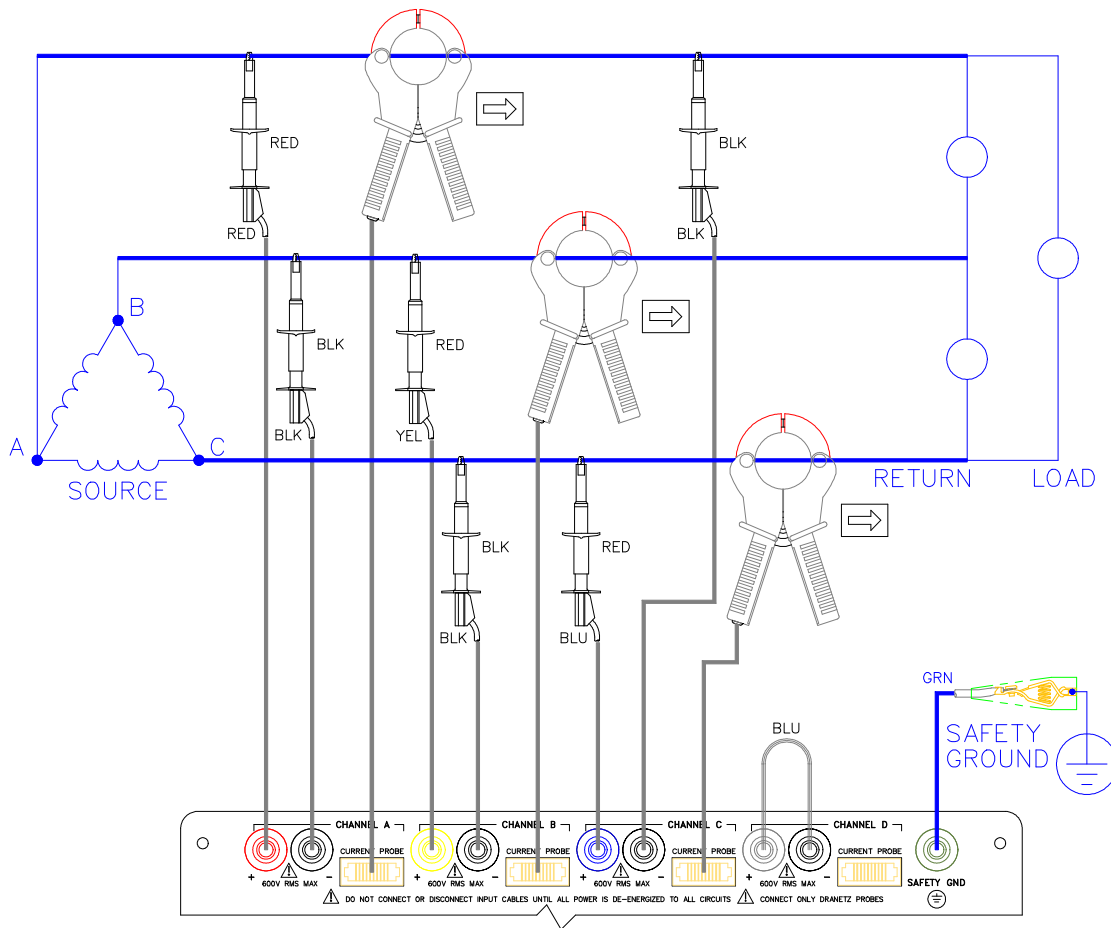

8600-9

Delta, One Leg Grounded

Introduction

In this power connection, the PP1-PQPlus uses voltage channels A, B, and C as differential inputs with channel A using source voltage A-B, channel B using B-C, and channel C using C-A as the reference. Current probes are connected to channels A, B, and C. Connect both terminals of Channel D together to prevent erroneous data.

Diagram

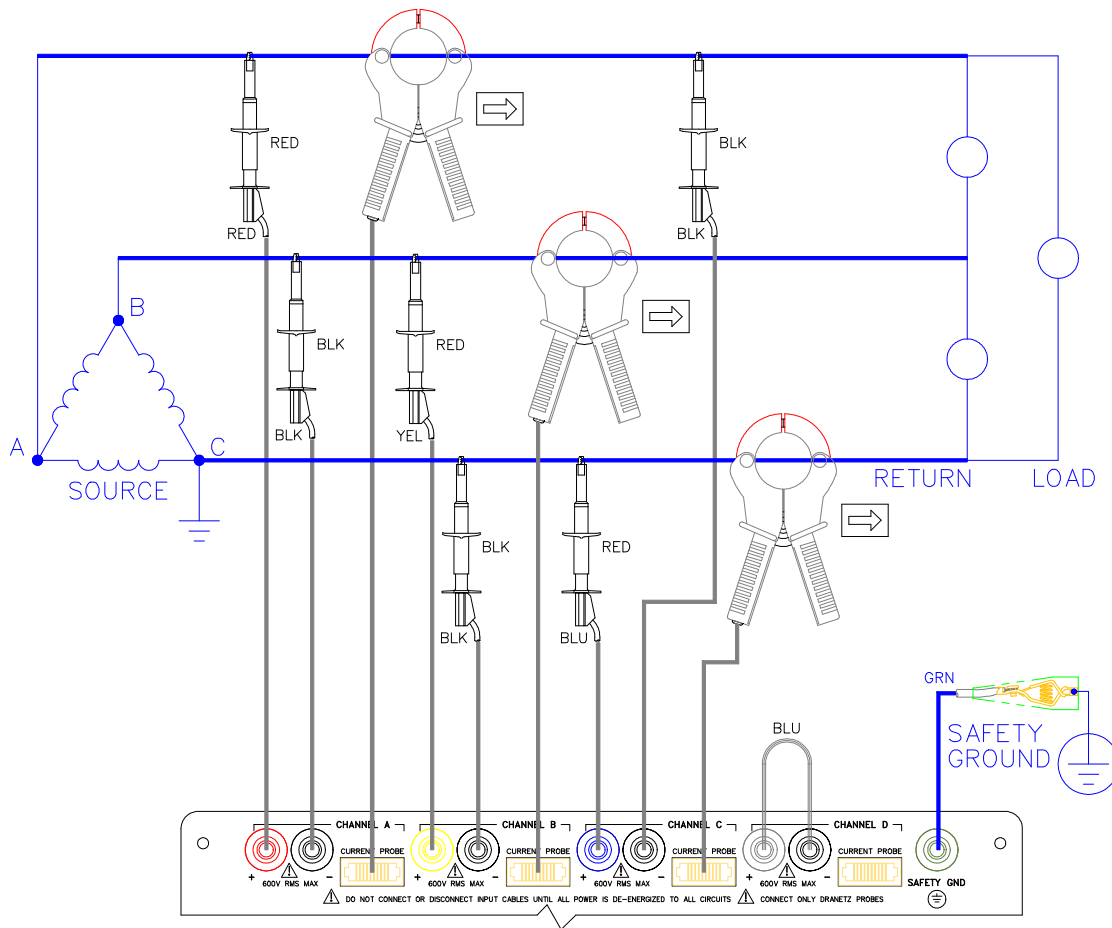

8600-8

Open Leg Delta

Introduction

The figure below shows the open leg delta with phase A-C connected to channel A and phase B-C connected to channel B. A jumper connects the A- and B-terminal. Current probes are connected to channels A and B.

Diagram

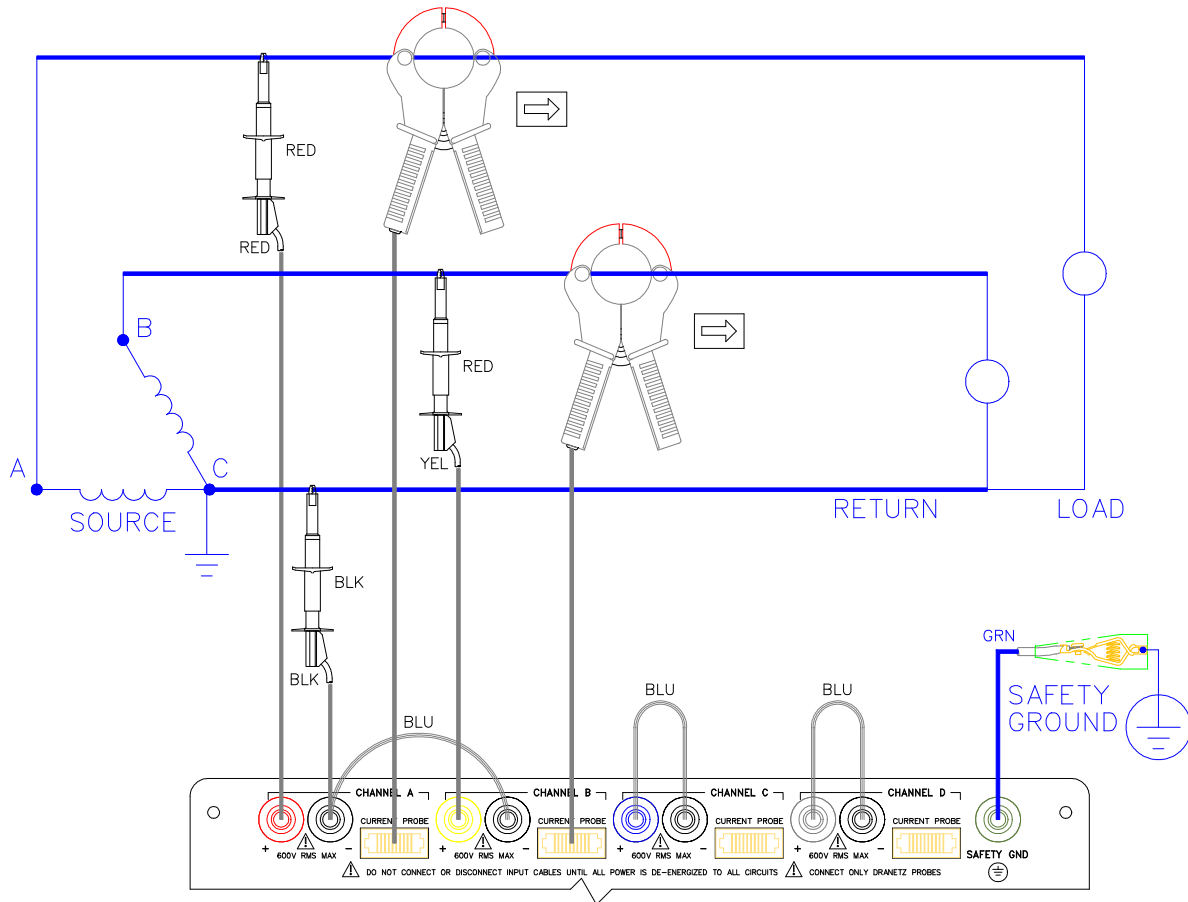

8600-10

High-Leg Delta

Introduction

The 4-wire delta connected 120/240V source shown in the figure on the next page is connected with one phase connected to ground at mid-point. This phase provides 120V at phases A and C to ground. Phase B is designated the high-leg connection and is measured at 208V ($120V \times 1.73 = 208V$) to ground. The National Electrical Code (NEC 215-8) identifies the high-leg phase as the Orange colored line.

Diagram

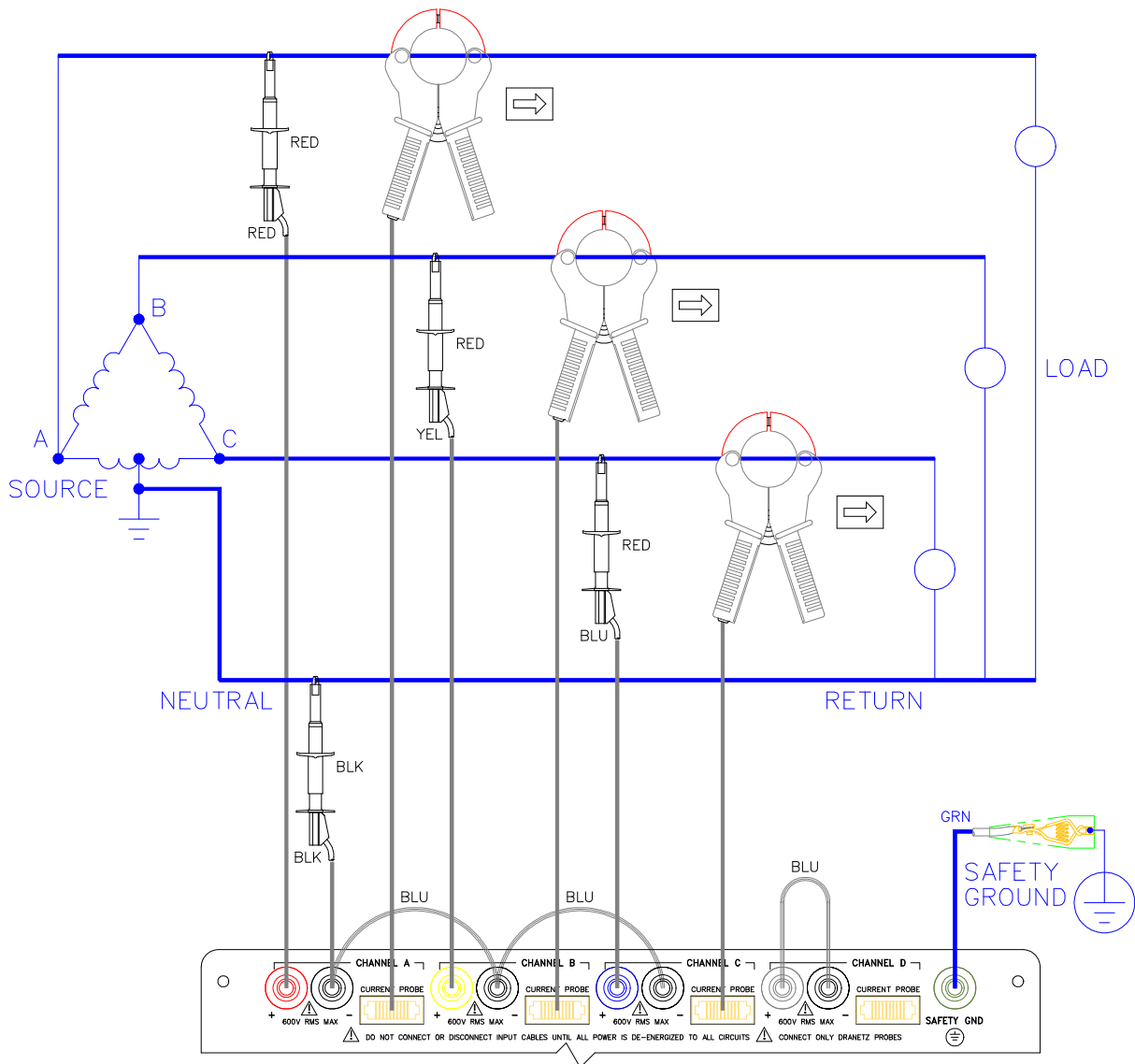

8600-11

Phasor Diagrams for Standard Power Connections

Diagrams The following diagrams describe the voltage and current phasors (for resistive loads) for the standard type of power connections when selected for viewing in meter mode. The page number for the related power connection diagram is given in the left column. Refer to Chapter 4, Section E, for information about viewing voltage and current phasors.

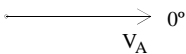
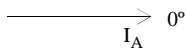
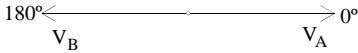
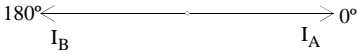
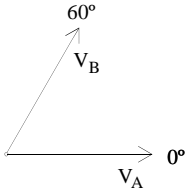
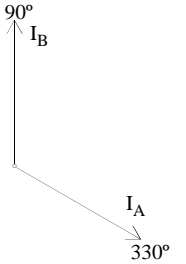
Power Connection Diagram	Voltage Phasor	Current Phasor
<p>Single Phase (See page 4-39)</p>		
<p>Split Phase (See page 4-40)</p>		
<p>Delta, One Leg Grounded (See page 4-43)</p>		

Continued on next page

Phasor Diagrams for Standard Power Connections, Continued

Diagrams
(continued)

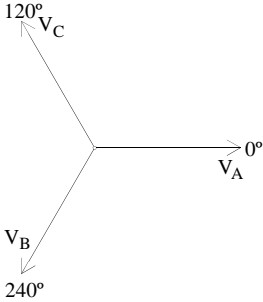
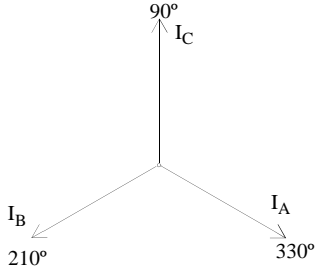
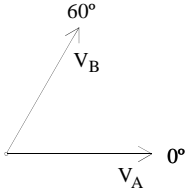
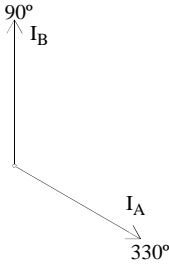
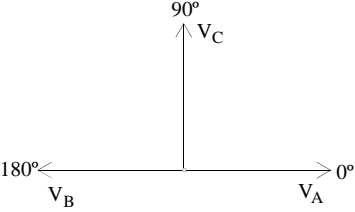
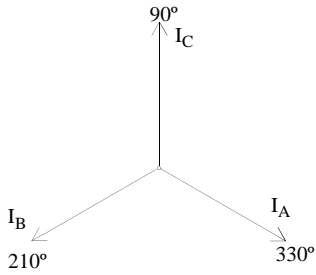
Power Connection Diagram	Voltage Phasor	Current Phasor
<p>Floating Delta (See page 4-42)</p>		
<p>Open Leg Delta (See page 4-44)</p>		
<p>High Leg Delta (See page 4-45)</p>		

Continued on next page

Phasor Diagrams for Standard Power Connections, Continued

Diagrams
(continued)

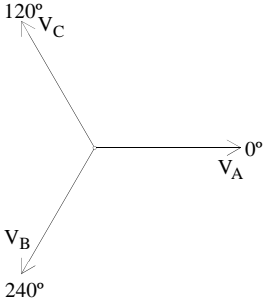
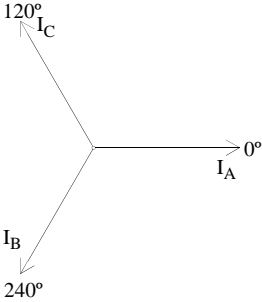
Power Connection Diagram	Voltage Phasor	Current Phasor
<p>Four Wire Wye (See page 4-41)</p>		

Section D

Monitoring Setup Procedures

Overview

Introduction This section describes the procedures required to select and activate a monitoring setup and start the monitoring process.

In this section The following topics are covered in this section.

Topic	See Page
Selecting and Activating a Setup	4-50
Reading Setups from a Memory Card	4-53
Turning On Monitoring	4-55

Selecting and Activating a Setup

Introduction

The following procedure is for selecting and activating a setup only. Screens show data related to the default setups. For details on how to modify a setup, see Chapter 6. Predefined setups are detailed in Appendix G.

A setup can be selected in two ways:

- From one of nine predefined setups. Setup number 10, Easy Start, can be viewed only.
 - From the preprogrammed setups stored on a memory card. See page 4-53.
-

Recording status setup

Before selecting a new setup for activation or editing, review the setup currently active and make a print record of the current setup status and thresholds in case you want to return to this setup.

To make a record proceed as follows:

- From the Main Menu, select 5- View Status, then press PRINT to record present status.
- Press EXIT to Main Menu.
- Press 3- Setup Menu.
- Press 1- Set Thresholds/Channel Config.
- Press NEXT SCREEN, then press PRINT SETUP.

The printout will provide you with a referable record and reminder of your present setup.

Once you select the Threshold/Channel Configuration screen in the Setup Menu you can exit to the previous status setup *only* by selecting the previous status setup number using the NEXT SETUP key. Pressing ACTIVATE will then reactivate the previous setup.

Continued on next page

Selecting and Activating a Setup, Continued

Displaying the screen

Follow these steps to display the Setup screen.

Step	Action
1	Select item 3, Setup Menu, from the Main Menu.
2	Select item 1, Set Thresholds/Channel Config., from the Setup Menu. The following screen appears. <div style="text-align: center; border: 1px solid black; padding: 5px; margin: 10px 0;"> <pre> Sep-14-93 09:16:12 INPUT CHANNEL CONFIGURATION CHAN VOLTS AMPS A ON ON B ON ON C ON ON D LOW ON NEXT VOLTS AMPS SCALE ABC NEXT CHAN ON/OFF ON/OFF FACTOR TOTALS SCREEN </pre> </div> <p><u>Note:</u> If you want to select your wiring configuration or enter scale factors, refer to Chapter 5.</p>
3	Set Volts and Amps to ON for all channels. For channel D set Volts to Low.
Step	Action
4	Press the NEXT SCREEN key. <p><u>Result:</u> The following default sample screen will appear. If a setup screen other than setup #1 is displayed, then it is the last setup activated.</p> <div style="text-align: center; border: 1px solid black; padding: 5px; margin: 10px 0;"> <pre> Mar-21-95 11:56:46 SETUP # 1-SINGLE-PHASE 120 VOLT W/N-G THRESHOLD CH.A CH.B CH.C CH.D V HI LIM 127.0 XXX XXX 5.0 V LO LIM 105.0 XXX XXX XXX V TRANS 100.0 XXX XXX 25.0 V THD % 5.0 XXX XXX XXX V FREQ HZ 0.5 XXX XXX XXX NEXT NEXT PREV EDIT PRINT ACTI- SETUP GROUP GROUP SETUP SETUP VATE </pre> </div>

Continued on next page

Selecting and Activating a Setup, Continued

Procedure Follow these steps to display and activate a setup.

Step	Action
1	Press NEXT SETUP to display the next numbered setup (1 to 9).
2	Press NEXT GROUP to display the next group of parameters in the presently displayed setup.
3	Repeat steps 1 and 2 until the desired setup is displayed.
4	Press ACTIVATE to activate the presently displayed setup. <u>Result:</u> Messages at the top of the screen will be displayed in the following sequence: Monitoring off Sync Acquired, Ch A Monitoring on. Then the screen will return to the Setup Menu.

Activated screen reference To determine which setup is active at any time, select the View Status screen from the Main Menu.

Reading Setups from a Memory Card

Introduction Setups stored on a memory card are usually preprogrammed setups that have been established as tried and true conditions. All setups on the card are read in and the one setup required for monitoring must be selected and activated. A setup file must exist on the memory card with the site name agreeing with the present PQPlus siteID.

Note Setups presently in memory will be overwritten.

Displaying the screen Follow these steps to display the Memory Card Functions screen.

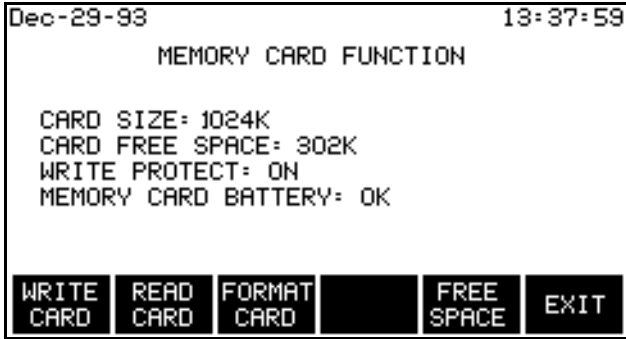
Step	Action
1	Select item 3, Setup Menu, from the Main Menu.
2	Select item 7, Memory Functions, from the Setup Menu.
3	Select item 1, Memory Card Functions, from the Memory Functions Menu. <u>Result:</u> The following screen will appear. 

Continued on next page

Reading Setups from a Memory Card, Continued

Procedure Follow these steps to read setups from a memory card.

Step	Action
1	Insert memory card.
2	Press READ CARD to display Read Data From Memory Card screen. Card size and card free space is shown. CAUTION: Reading card data will erase any events presently in memory!
3	Press READ SETUPS. Setups are displayed.

Select and activate the setup

Select and activate the setup required as described on page 4-50.

Turning On Monitoring

Procedure Follow these steps to turn on monitoring.

Step	Action
1	<p>Select item 3, Setup Menu, from the Main Menu.</p> <p><u>Result:</u> The following screen will appear.</p> <div data-bbox="675 558 1295 892" data-label="Code-Block"><pre>Sep-14-93 09:14:13 SETUP MENU 1. SET THRESHOLDS / CHANNEL CONFIG. 2. SET ANALYZER PARAMETERS 3. TURN MONITORING ON 4. SET AUTOMATIC REPORTS 5. SET INTERVAL FOR TIMED READINGS 6. SET EASY START % TOLERANCE 7. MEMORY FUNCTIONS 8. I/O DEVICES EXIT</pre></div> <p>Note: If monitoring was turned on, then line 3 would read Turn Monitoring Off. Then the following screen action references would be the reverse of that shown.</p>
2	<p>Press 3, Turn Monitoring On.</p> <p><u>Result:</u> The following screen will appear.</p> <div data-bbox="675 1167 1295 1501" data-label="Code-Block"><pre>Jan-20-94 15:22:43 YOU HAVE CHOSEN TURN MONITORING ON PRESS 'YES' TO TURN MONITORING ON PRESS 'EXIT' TO CANCEL YES EXIT</pre></div>
3	<p>Press YES to turn on monitoring.</p>

Section E

Scope and Meter Mode

Overview

Introduction This section describes the operation of scope and meter mode, which allows you to view real-time parameter data.

In this section The following topics are covered in this section.

Topic	See Page
Viewing Scope Mode	4-57
Viewing Meter Mode	4-49
Viewing Voltage and Current Phasors	4-62
Viewing Voltage and Current Harmonics	4-63

Viewing Scope Mode

Introduction Scope Mode allows you to view the present voltage and current waveforms for up to four channels.

Displaying the screen From Main Menu, select item 2, Scope Mode.

Result: A screen similar to that shown below is displayed.

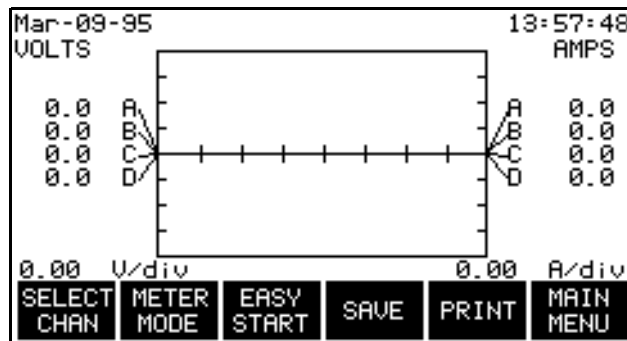

Screen description

Waveform labels: Voltage waveforms are labeled on the left at the point where they cross the vertical axis. Current waveforms are labeled on the right at the point where they cross the vertical axis.

When more than one waveform crosses the vertical axis at the same point (same phase angle), the channel identifier for the waveform with the highest amplitude is placed first, and the lower values follow below. If the amplitudes are also identical then the A-B-C order is used.

Vertical scale: Scaled relative to the waveform with the largest peak value. Voltage and current are scaled separately.

Horizontal scale: Scaled to display one cycle. Each tick mark is 45 degrees.

Update rate: The display is updated approximately once every two seconds.

How to save scope mode data Press the SAVE key to save the display as an event. This display can then be viewed with the view events option and will be listed in the event report as a SCOPE SNPSHT event. See Chapter 10.

Continued on next page

Viewing Scope Mode, Continued

How to select channels for display

Follow these steps to select channels for the Scope Mode display.

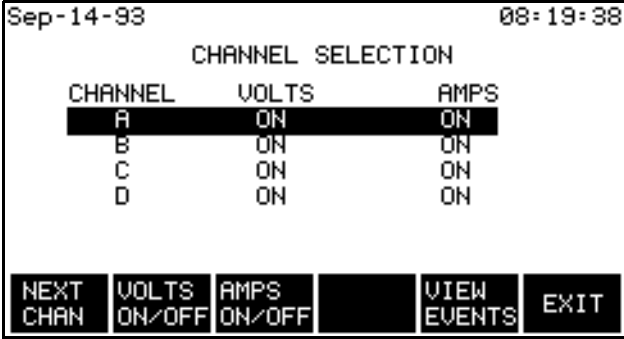
Step	Action
1	<p>In Scope Mode display, press SELECT CHAN. The Channel Selection screen is displayed as shown below.</p> <p><u>Result:</u> The following screen will appear.</p>  <pre> Sep-14-93 08:19:38 CHANNEL SELECTION CHANNEL VOLTS AMPS ----- A ON ON B ON ON C ON ON D ON ON NEXT CHAN VOLTS AMPS VIEW EXIT CHAN ON/OFF ON/OFF EVENTS </pre>
2	Press VOLTS ON/OFF to toggle selected channel On or Off for voltage waveform display.
3	Press AMPS ON/OFF to toggle selected channel On or Off for current waveform display.
4	Press NEXT CHAN to select channels A, B, C, and/or D as shown below.
5	Repeat steps 2 through 4 for each channel to be selected.
6	Press EXIT to display the channels selected.

Viewing Meter Mode

Types of displays

You can select any one channel for viewing with all parameters displayed, or you can select an individual parameter for viewing with all channels displayed.

Channels that can be viewed

Channels A, B, C, or D can be viewed individually or collectively for single phase monitoring. For Delta mode the sequence is: A-B, B-C, C-A, D, and ABC.

Available parameters

The following table lists the parameters that can be viewed in meter mode.

Parameter	Symbol	Group
Volts RMS	V	1
Amps RMS	I	1
Watts	W	1
Volt-amps	VA	1
Volt-amps Reactive	VAR	2
Power Factor (True)	PF	2
Voltage Frequency	Hz	2
Voltage Unbalance	Vunb%	2
Volts, Total Harmonic Distortion	Vthd	3
Amps, Total Harmonic Distortion	Ithd	3
Current Crest Factor	Icf	3
k-Factor	KF	3
Demand	Dmd	4
Energy	WHR	4
Volts, Harmonic Number*	V harm n	4
Amps, Harmonic Number*	I harm n	4
*The harmonic number is selected on the threshold configuration screen. See page 6-7.		

Continued on next page

Viewing Meter Mode, Continued

Procedure Follow these steps to view the meter mode displays.

Step	Action
1	<p>In Scope Mode display press METER MODE to view the Meter Mode Menu below.</p> <div data-bbox="673 554 1295 890" style="border: 1px solid black; padding: 5px; margin: 10px auto; width: fit-content;"> <pre> Jan-20-94 14:37:09 METER MODE MENU 1. ONE CHANNEL, ALL PARAMETERS 2. ALL CHANNELS, ONE PARAMETER 3. ALL CHANNELS, ALL PARAMETERS 4. VOLTAGE & CURRENT PHASORS 5. VOLTAGE & CURRENT HARMONICS EXIT </pre> </div>
2	<p>Press 1 if one channel and all parameters are to be viewed.</p> <div data-bbox="673 1005 1295 1341" style="border: 1px solid black; padding: 5px; margin: 10px auto; width: fit-content;"> <pre> Oct-06-91 10:26:56 CHANNEL : A 114.5 V 1.368 kI 143.6 kW 156.7 kVA NEXT CHAN NEXT GROUP PRINT EXIT </pre> </div> <p>Press NEXT CHAN to display next channel parameters. Press NEXT GROUP to display the next group of data for the channel selected.</p>

Continued on next page

Viewing Meter Mode, Continued

Procedure
(continued)

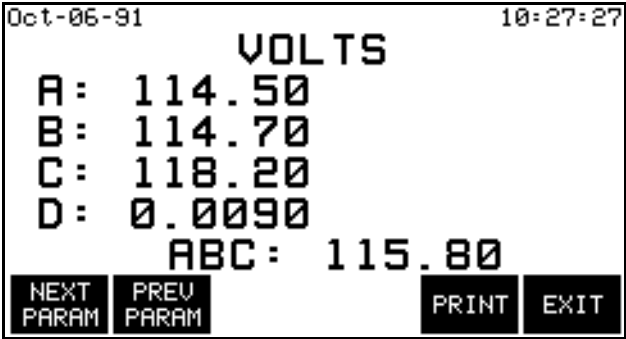
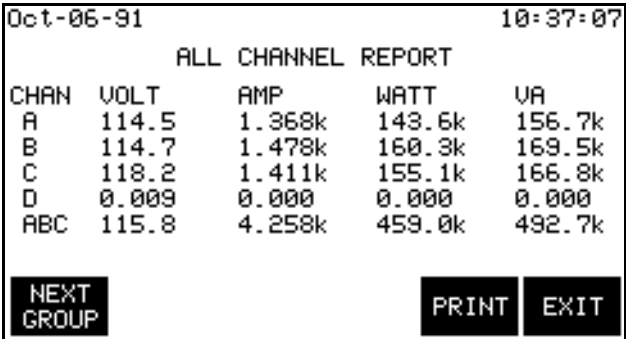
Step	Action
3	<p>Press 2 if all channels and one parameter are to be viewed.</p>  <pre> Oct-06-91 10:27:27 VOLTS A: 114.50 B: 114.70 C: 118.20 D: 0.0090 ABC: 115.80 NEXT PREV PRINT EXIT PARAM PARAM </pre>
4	<p>Press 3 for the all channels, all parameters display.</p>  <pre> Oct-06-91 10:37:07 ALL CHANNEL REPORT CHAN VOLT AMP WATT VA A 114.5 1.368k 143.6k 156.7k B 114.7 1.478k 160.3k 169.5k C 118.2 1.411k 155.1k 166.8k D 0.009 0.000 0.000 0.000 ABC 115.8 4.258k 459.0k 492.7k NEXT PRINT EXIT GROUP </pre>

Viewing Voltage and Current Phasors

Procedure Follow these steps to view the current and voltage phasors displays.

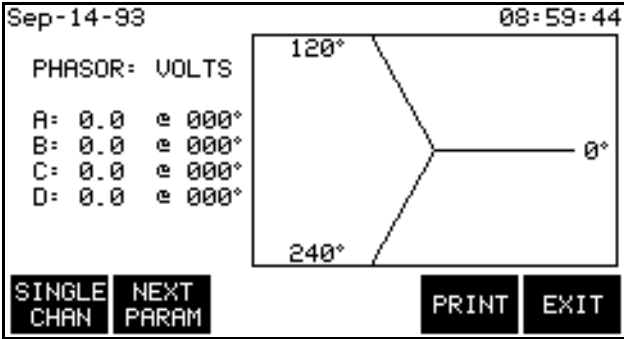
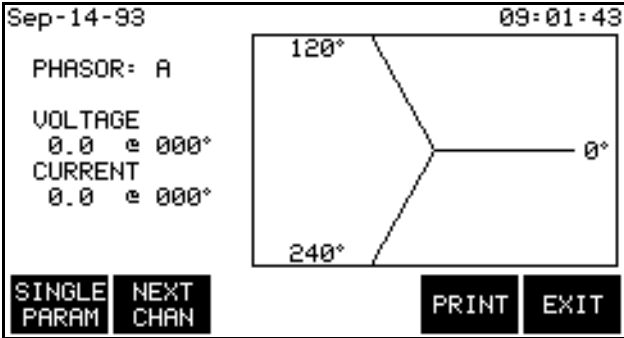
Step	Action
1	From Scope Mode display select METER MODE.
2	<p>From Meter Mode menu press 4, Voltage & Current Phasors.</p> <p>The following screen will appear if no inputs are connected.</p> 
3	<p>Press SINGLE CHAN to display the Single Channel Phasors display.</p> 

Display symbols Phasor vectors are displayed clockwise from the zero degrees reference. Dependent on the phases being monitored, up to four channels may be displayed at any one time for either volts or amps, or a single channel for both volts and amps. An arrow head and channel label are displayed on the vector arm.

Viewing Voltage and Current Harmonics

Screen description

Viewing the voltage and current harmonics permits you to display harmonics in the form of a graph or a table.

Graph: The graph displays the magnitude of each harmonic as a percentage of the fundamental, rms, or maximum load current. The left edge of the graph represents the fundamental frequency.

Table: The table lists the magnitude and phase for each harmonic. This screen displays harmonic's magnitude and phase relative to fundamental, rms, or maximum load current of the channel and parameter selected.

Update rate: All displays are updated once every five seconds.

Harmonics displayed: The number of harmonics displayed is up to the 50th for 60Hz and up to the 8th for 400Hz.

Displaying the graph screen

Follow these steps to view the harmonics graph display.

Step	Action
1	From Main Menu select 2, Scope Mode.
2	From Scope Mode display press METER MODE.
3	From Meter Mode select 5, Voltage and Current Harmonics.

Result: A screen similar to the following will appear.

For the table display of this graph, see page 4-55.

Continued on next page

Viewing Voltage and Current Harmonics, Continued



Changing the channel and parameter

Use the following keys to change the channels and/or parameter displayed.

- NEXT CHAN to select channels A, B, C, or D.
- NEXT PARAM for selection of V, A, or W.

Changing the vertical scale

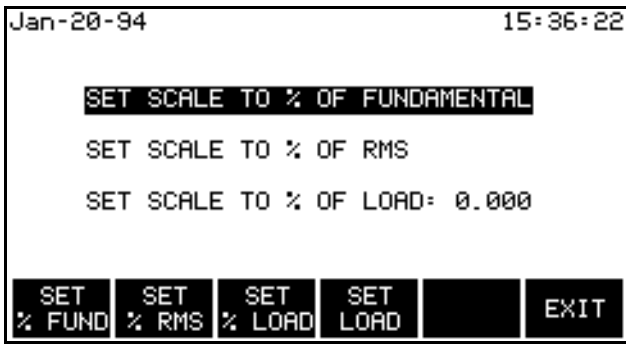
Follow these steps to change the vertical scale of the harmonic graph display.

Step	Action
1	<p>Press SET SCALES.</p> <p><u>Result:</u> The following screen is displayed.</p>  <p><u>Note:</u> Scale based on following values and conventions:</p> <ul style="list-style-type: none"> •% of Fund - THD, North American convention •% of rms - THD, IEC 555-2, European convention •% of load - TDD, IEEE 519 recommendation
2	<p>Press one of the SET% keys.</p> <ul style="list-style-type: none"> • If you pressed SET% FUND or SET% RMS, go to step 5. • If you pressed SET% LOAD (current) go to step 3.
3	<p>Press SET LOAD</p> <p><u>Result:</u> The menu bar changes to the following.</p> 
4	Enter the value for maximum load current.
5	Press EXIT to return to harmonics graph.

Continued on next page

Viewing Voltage and Current Harmonics, Continued

Viewing the text display To view the harmonics text display, press the TEXT MODE key from the graph display.

Result: A screen similar to the following will appear.

```

Oct-06-91                               10:53:24
HARMONICS=CH A   REF   112.8 V, 60.0Hz
%FUND   Vthd
H# MAG%  PHS H# MAG%  PHS H# MAG%  PHS
02 0.000 000 09 0.288 000 16 0.000 000
03 0.288 180 10 0.000 000 17 0.000 000
04 0.000 000 11 0.000 000 18 0.000 000
05 0.672 000 12 0.000 000 19 0.000 000
06 0.000 000 13 0.000 000 20 0.000 000
07 0.000 000 14 0.000 000 21 0.000 000
08 0.000 000 15 0.000 000 22 0.000 000
NEXT  NEXT  NEXT  GRAPH  PRINT  EXIT
CHAN  PARAM SET  MODE
  
```

Note For the watts parameter only, harmonic power direction is indicated by a sign in front of the MAG% (watts magnitude) value. A minus sign (-) indicates that the harmonic power flows in the opposite direction of the source-load arrow on the CT. No sign indicates that the harmonic power flows in the same direction as the source-load arrow on the CT.

A load is indicated if the CT arrow is pointing at the physical load and there is no sign on the watts magnitude. This is the normal situation. If the sign on the watts magnitude is negative, then the load is actually a source (generator).

A negative sign on the fundamental watts usually indicates that the CT is on backwards, or the arrow is pointing in the wrong direction.

Function keys The following table provides a description of the function keys for the harmonics text screen.

Key	Function
NEXT CHAN	Displays the next channel of data.
NEXT PARAM	Displays the next parameter of data: V, A, or W.
NEXT SET	Displays the next set of harmonics: 02 to 22, 23 to 43, 44 to 50th harmonics for 60 Hz.
GRAPH MODE	Returns to the harmonics graph screen.
PRINT	Prints the screen.

Chapter 5

Input Channels Setup

Overview

Introduction This chapter contains the procedures you need to perform after you have connected the unit to the circuit that you want to measure. Once you have made all voltage and current connections, you have to set up the unit so that it knows what inputs you are using and what kind of circuit you are measuring.

In this chapter This chapter covers the following topics:

Topic	See Page
Turning Input Channels On and Off	5-2
Selecting Your Circuit Type	5-4
About Scale Factors	5-6
Entering Scale Factors	5-7
About Frequency Synchronization	5-9
Selecting Sync Frequency	5-11

Turning Input Channels On and Off

Introduction You must turn on any input channel that will be used for monitoring. If a channel is not turned on, no data will be collected for it.

Definition Input channels are the four voltage and current channels on the rear panel labelled A, B, C, and D.

Displaying the screen Follow these steps to display the Input Channel Configuration screen.

Step	Action
1	Select item #3, Setup Menu, from the Main Menu.
2	<p>Select item #1, Set Thresholds/Channel Config., from the Setup Menu.</p> <p>The following screen will appear.</p> <div data-bbox="673 961 1295 1297" data-label="Image"> <pre> Sep-14-93 09:16:12 INPUT CHANNEL CONFIGURATION CHAN VOLTS AMPS A ON ON B ON ON C ON ON D LOW ON NEXT CHAN VOLTS AMPS SCALE ABC NEXT ON/OFF ON/OFF FACTOR TOTALS SCREEN </pre> </div>

Continued on next page

Turning Input Channels On and Off, Continued

Procedure Follow these steps to turn on any or all input channels.

Step	Action
1	Press the VOLTS ON/OFF key to toggle the highlighted voltage channel between on and off. <u>Note:</u> Channel D voltage has three possible settings: LOW, HIGH, and OFF. Pressing this key cycles through the three settings.
2	Press the AMPS ON/OFF key to toggle the highlighted current channel between on and off.
3	Press the NEXT CHAN key.
4	Repeat steps 1 to 3 for each channel.

Where to go from here Refer to the following table to find the next topic.

IF you want to...	THEN see page
return to Setup Menu	see below
select your circuit type (ABC TOTALS)	5-4
enter scale factors	5-6
select sync frequency	5-9
change an event monitoring setup (NEXT SCREEN)	6-1

Return to setup menu If you want to return to the Setup Menu without any further editing of the thresholds, etc., you must first press NEXT SCREEN. Then determine if the Setup # is the one in which you want to continue. If it is, press ACTIVATE. If not, press NEXT SETUP until the Setup # corresponds to the operating setup you require, then press ACTIVATE.

Selecting Your Circuit Type

Introduction

You must select a circuit type when you are collecting data for power parameters such as watts, VA's, and VAR's. If you don't select the proper circuit type, the ABC totals won't be calculated correctly.

Displaying the screen

Follow these steps to display the Wiring Configuration and Scale Factors screen.

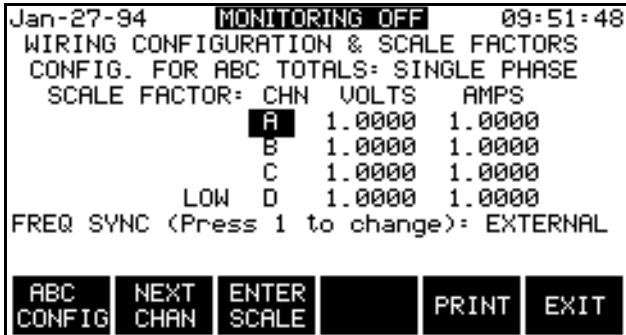
Step	Action
1	Select item #3, Setup Menu, from the Main Menu.
2	Select item #1, Set Thresholds/Channel Config., from the Setup Menu. The Input Channel Configuration screen is displayed.
3	Press the ABC TOTALS key. The following screen will appear. 

Continued on next page

Selecting Your Circuit Type, Continued

Procedure Follow these steps to select your circuit type.

Step	Action																
1	Determine the circuit type that the Power Platform is connected to according to the diagrams in Chapter 4, Section C.																
2	Press the ABC CONFIG key until the correct ABC config. is displayed according to the following table: <table border="1" data-bbox="607 590 1349 1010"> <thead> <tr> <th>IF the Power Platform is connected to this circuit type...</th> <th>THEN select this ABC config...</th> </tr> </thead> <tbody> <tr> <td>Single Phase</td> <td>Single Phase</td> </tr> <tr> <td>Split Phase</td> <td>Split Phase</td> </tr> <tr> <td>Four Wire Wye</td> <td>3 Phase Wye</td> </tr> <tr> <td>Floating Delta</td> <td>3 Phase Delta</td> </tr> <tr> <td>Delta, One Leg Grounded</td> <td>3 Phase Delta</td> </tr> <tr> <td>Open Leg Delta</td> <td>Split Phase</td> </tr> <tr> <td>High-Leg Delta</td> <td>3 Phase Wye</td> </tr> </tbody> </table>	IF the Power Platform is connected to this circuit type...	THEN select this ABC config...	Single Phase	Single Phase	Split Phase	Split Phase	Four Wire Wye	3 Phase Wye	Floating Delta	3 Phase Delta	Delta, One Leg Grounded	3 Phase Delta	Open Leg Delta	Split Phase	High-Leg Delta	3 Phase Wye
IF the Power Platform is connected to this circuit type...	THEN select this ABC config...																
Single Phase	Single Phase																
Split Phase	Split Phase																
Four Wire Wye	3 Phase Wye																
Floating Delta	3 Phase Delta																
Delta, One Leg Grounded	3 Phase Delta																
Open Leg Delta	Split Phase																
High-Leg Delta	3 Phase Wye																
3	Press the EXIT key.																

Where to go from here Refer to the following table to find the next topic.

IF you want to...	THEN see page
enter scale factors	5-6
select sync frequency	5-9
change an event monitoring setup (NEXT SCREEN)	6-1

About Scale Factors

What are scale factors? Scale factors are the ratio of input to output for a particular current transformer (CT) or potential transformer (PT). Scale factors are entered into the PP1-PQPlus and then multiplied automatically by the measured voltage and current so that the unit displays the correct values.

Note: If voltage and current connections are made without using any of the above named devices, the scale factor should be set to 1.

When to use Scale factors other than 1 must be entered for the following conditions.

- A Dranetz current probe is connected to a permanently installed CT.
- The current connections are made using an ISO box.
- The voltage connections are made using a PT.

Dranetz equipment Current Probes: All Dranetz current probes have a scale factor of 1.

ISO-1: 0.333
ISO-1A: 0.500
ISO-5: 1.666

Non-Dranetz equipment Refer to the CT name plate or to the manufacturers literature to determine the scale factor.

What to enter Single device: The scale factor for a single CT or PT is calculated from its step-up or step-down ratio.

Example: A potential transformer has a step-down ratio of 1000:5, therefore:
Scale Factor = $1000/5 = 200$

Multiple devices: Multiply the scale factors of the all devices.

Example: A CT with a scale factor of 200 is connected to a Dranetz ISO-5.
Scale Factor = $200 \times 1.666 = 333$

Entering Scale Factors

Range 0.001 to 999,900

Displaying the screen Follow these steps to display the Wiring Configuration and Scale Factors screen.

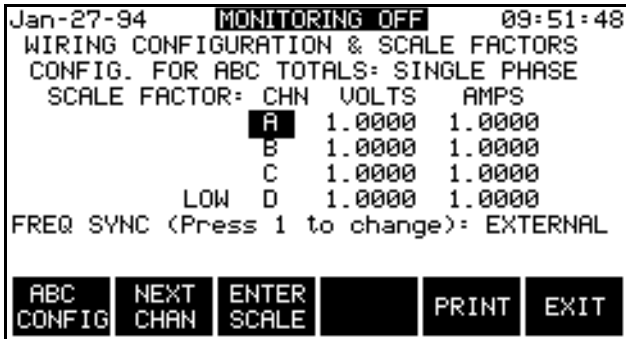
Step	Action
1	Select item #3, Setup Menu, from the Main Menu.
2	Select item #1, Set Thresholds/Channel Config., from the Setup Menu. The Input Channel Configuration screen will appear.
3	<p>Press the SCALE FACTOR key.</p> <p>The following screen will appear.</p> 

Continued on next page

Entering Scale Factors, Continued

Procedure Follow these step to enter scale factors.

Step	Action
1	Press the ENTER SCALE key. The menu bar will change to the following. 
2	Enter the scale factor for the voltage channel.
3	Press ENTER.
4	Enter the scale factor for the current channel.
5	Press ENTER.
6	Press NEXT CHAN.
7	Repeat steps 2 to 7 for each channel that needs scale factors.
8	Press EXIT.

Note If no scale factor is entered, the scale factor defaults to 1.0 when EXIT is pressed.

About Frequency Synchronization

Introduction

Normal frequency synchronization (sync) of PP1-PQPlus analog signal processing circuits is controlled by sampling the external AC signal input on channel A. Loss of external sync causes the PP1-PQPlus to sample other valid voltage channels for an alternate external sync. If none exists, then internal sync is automatically selected.

Failure to connect an external sync, or select an internal sync, during current monitoring will result in erroneous data being collected and displayed.

Sync during power-up

On power-up, the PP1-PQPlus will initially attempt to sync on channel A input voltage phase. If a valid input is available, then the PP1-PQPlus will sync in the external mode and will remain in this mode until the sync level is lost.

If channel A sync cannot be acquired, then the next valid voltage channel will be polled to re-initiate external sync in accordance with the following wiring configuration.

Wiring Configuration	Valid Voltage Channel for Sync
Single Phase	A, D
Split Phase	A, B, D
3 Phase Delta	A, B, C, D
3 Phase Wye	A, B, C, D

Loss of external sync during power up

If external sync cannot be acquired on any valid channel, then the PP1-PQPlus will revert to internal sync. The frequency used for internal sync is entered on the Wiring Configuration screen. Refer to page 5-11 for the procedure.

The valid voltage channels will be polled in the background in an attempt to require external sync.

When no external sync signal is found, an error message is displayed (and printed) to inform you of this condition. The loss of sync is also sent to event memory for future recall.

About Frequency Synchronization, Continued

Loss of sync during monitoring

If sync is lost during monitoring of out of limit events, the PP1-PQPlus will attempt to reacquire sync on the present sync channel for one minute. If after one minute sync cannot be reacquired, the other valid channels will be attempted without any delay. If sync cannot be acquired on any valid channel then the PP1-PQPlus will switch to internal sync.

The internal sync in this condition will be the last frequency measured before sync was lost. The internal sync frequency entered in the wiring configuration screen (see next page) will not be used unless you change over to internal sync.

The one minute timeout simulates a long duration interruption which, in turn, generates a TIMEOUT event that normally permits the PP1-PQPlus to attempt to sync at another valid channel.

Selecting Sync Frequency

Introduction

Selection of the sync frequency is fixed to the input voltage monitoring frequency in external sync mode and to a frequency selected by the operator in the internal sync mode. The default sync frequency is the external sync. You can select either of the sync modes.

Procedure

Follow these steps select an internal or external sync.

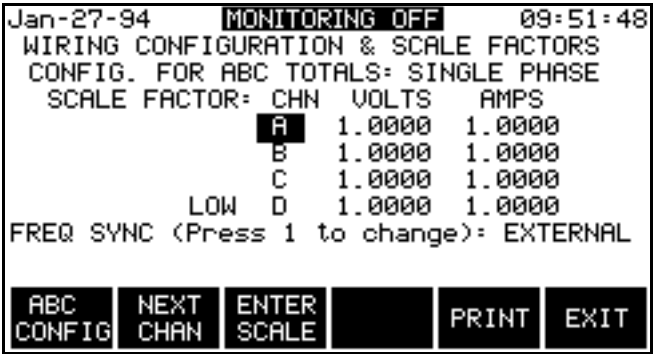
Step	Action
1	Select item #3, Setup Menu, from the Main Menu.
2	Select item #1, Set Thresholds/Channel Config. from the Setup Menu. The Input Channel Configuration screen will appear.
3	Press SCALE FACTOR. The following screen appears when External sync is the default sync frequency. 

Continued on next page

Selecting Sync Frequency, Continued

Procedure
(continued)

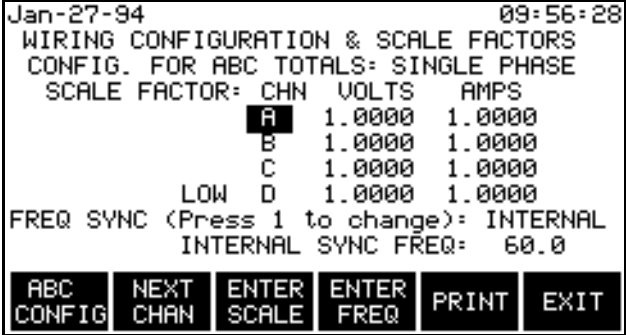
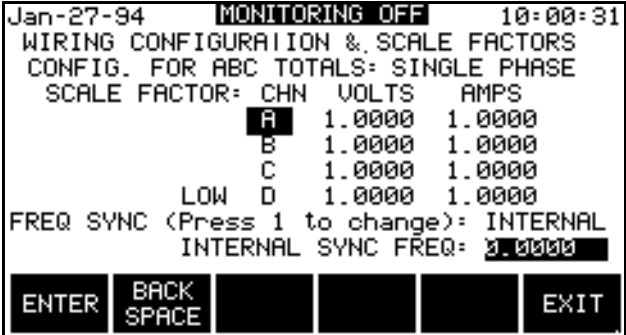
Step	Action
4	<p>Press number 1 from the keyboard. The following screen appears to display the Internal sync mode.</p> 
5	<p>To change the Internal Sync Frequency press ENTER FREQ. The following screen appears.</p> 
6	<p>Enter the internal frequency desired using format XX.XX. Allowable range is 15 to 499.9.</p>
7	<p>Press ENTER to redisplay the screen of step 5 to verify selection.</p>
8	<p>Press PRINT to provide a printout to verify and record the frequency selection.</p>
9	<p>To return to External sync, press numeral 1 at the keyboard. The display of step 3 will return.</p>

Chapter 6

Custom Event Monitoring Setups

Overview

Who should read this chapter

This chapter contains information about creating custom setups. If you don't want to create a setup and only want to use one of the predefined setups for monitoring, see page 4-55.

Definition

A monitoring setup is a list of parameters and thresholds for each channel that controls the way the unit records event data. A setup also contains settings that control how waveforms are captured. In essence, a setup is a list of the criteria that the PPI-PQPlus uses to determine what constitutes an event and what waveform data is saved when an event occurs.

Predefined setups

The PQPlus TASKCard comes with all ten setups predefined for specific purposes. Setups 1 to 9 can be modified and setup 10 is used for Easy Start. Refer to Appendix G for the complete descriptions of all setups.

Custom setups

If you want to create a custom setup, you must modify one of the nine available.

Digital control of monitoring

The digital inputs, located on the rear panel, provide control of start/stop and snapshot monitoring.

Continued on next page

Overview, Continued

In this chapter The following topics are covered in this chapter:

Topic	See Page
Creating a Custom Event Monitoring Setup	6-3
Copying the Easy Start Setup	6-4
Viewing a Setup	6-6
Editing Parameter Thresholds	6-7
Setting Waveform Capture	6-12
Controlling Event Monitoring with the Digital Inputs	6-14
Making Digital Input Connections to the Rear Panel	6-15
Changing the Digital Inputs Configuration	6-17

Creating a Custom Event Monitoring Setup

Description Creating a custom setup consists of setting the thresholds and waveform capture for the various parameters. The process starts with choosing a setup that is similar to the one you want to create, then modifying the parameters to meet your specification. If the Easy Start setup (setup #10) is similar to what you want, an edit screen is provided for copying this setup to setup #9 so that it can be modified. See Appendix G for the listing of all setups.

Process diagram The following block diagram gives an overview of creating a custom setup.

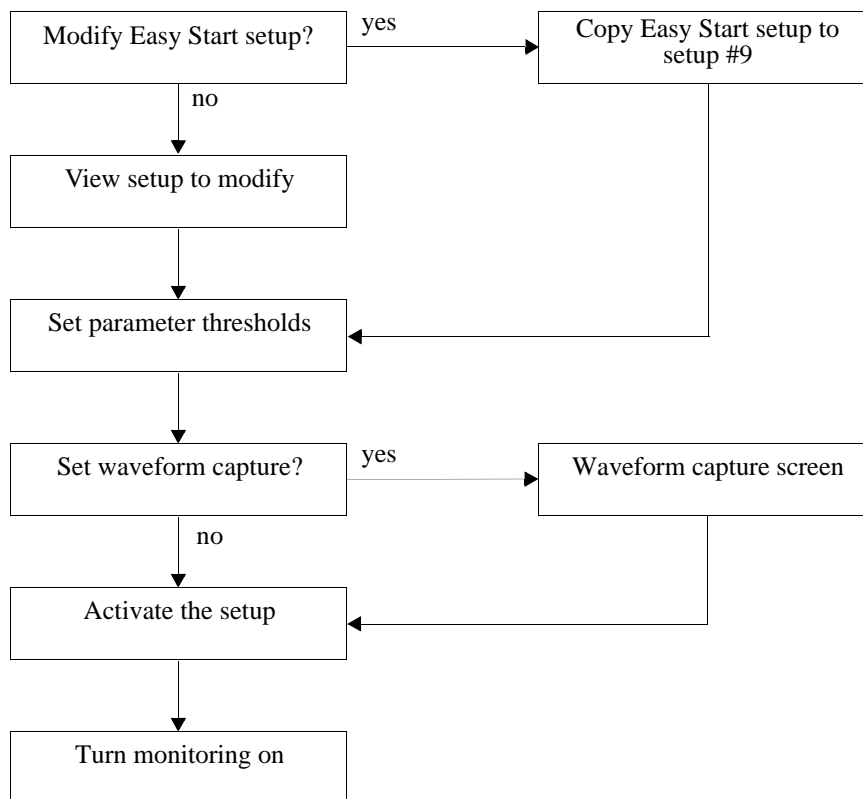

Copying the Easy Start Setup

Introduction If you want to modify setups 1 to 9, refer to page 6-7.

If the Easy Start setup is similar to what you want to use, it can be copied to setup #9 so that you can modify it.

Definition The Easy Start setup consists of the parameter and waveform capture settings for setup #10, which is the setup that is activated during the easy start procedure. This setup can be viewed but not modified. See page 2-6 for the listing of the Easy Start setup. See page G-11 for the detailed listing of this setup.

CAUTION Easy Start setup overwrites setup #9.

PRECAUCION La configuración de Inicio fácil sobrescribe la configuración #9.

MISE EN GARDE L'installation de Easy Start annule l'installation no. 9.

ACHTUNG "Easy Start"-Einstellung überschreibt Einstellung Nr. 9.

Displaying the screen Follow these steps to display the Copy Easy Start setup to threshold setup #9.

Step	Action
1	Select item #3, Setup Menu, from the Main Menu.
2	Select item #1, Set Thresholds/Channel Config., from the Setup Menu.
3	Press the NEXT SCREEN key.
4	Press EDIT SETUP.

Continued on next page

Copying the Easy Start Setup, Continued

Displaying the screen
(continued)

Step	Action
5	<p>Select item #4, Copy Easy Start Thresholds to #9, from the Edit Setups Menu.</p> <p>The following screen will appear.</p> <div data-bbox="675 655 1297 989" style="border: 1px solid black; padding: 5px; margin: 10px auto; width: fit-content;"><pre>Sep-29-93 17:10:34 * CAUTION * EASY START THRESHOLD SETTING WILL OVERWRITE SETUP #9 PRESS 'EXIT' TO RETURN TO NORMAL OPERATION PRESS 'COPY' TO CONTINUE COPY EXIT</pre></div>

Note Make sure that setup #9 is one that you don't want to use. If you want to copy the Easy Start setup and use setup #9 at a later time, save the setups to a memory card before copying. See page 11-31.

Procedure Select COPY.

Setup #9 will be the displayed setup and you can select item 1, 2, or 3 to perform editing functions. If you don't select any item, the setup will revert to its previous values.

After selection of COPY, the display returns to Edit Setups Menu.

Viewing a Setup

Introduction

If one of the predefined setups is similar to what you want, you should view that setup and edit only the threshold settings for the parameters that you want to change. You can then edit some or all of the threshold settings.

If none of the setups suits your needs, you can pick any setup to edit.

Displaying the screen

Follow these steps to display the Thresholds screen.

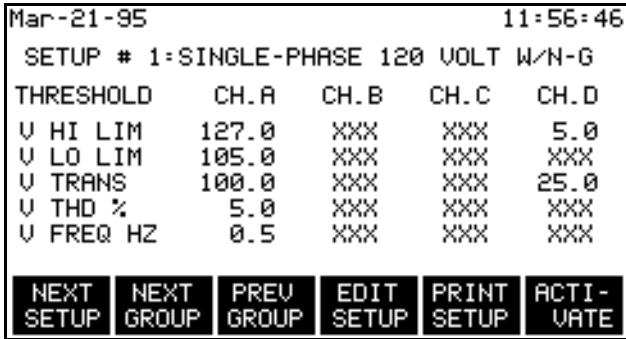
Step	Action
1	Select item #3, Setup Menu, from the Main Menu.
2	Select item #1, Set Thresholds/Channel Config., from the Setup Menu.
3	<p>Press the NEXT SCREEN key.</p> <p><u>Result:</u> The following screen will appear.</p> 

Procedure

Follow these steps to view a setup.

Step	Action
1	Press NEXT SETUP to display the next numbered setup (1 to 10).
2	Press NEXT GROUP or PREV GROUP to view all the threshold settings.
3	Repeat steps 1 and 2 until the desired setup is displayed.
4	Go to next page.

Editing Parameter Thresholds

Introduction

Parameter thresholds can be edited by two methods: three phase or individual channel. Both screens are identical except that the three phase screen allows you to enter the same value for channels A, B, and C only once.

Threshold list

The following table lists the threshold parameters and the allowable range for each. The heavy lines separate the parameters into the groups as they appear on screen.

Parameter	Range
V HI LIM	0.2 to 10.0M
V LO LIM	0.1 to 10.0M
V TRANS	5 to 10.0M
V THD %	0.5 to 1.0K
V FREQ HZ	0.1 to 450.0
I HI RMS	0.2 to 10.0M
I LO RMS	0.1 to 10.0M
I PEAK	0.1 to 10.0M
I THD %	0.5 to 1.0K
I TRANS	0.1 to 10.0M
WATTS LIM	0.1 to 10.0M
VA HI LIM	0.1 to 10.0M
VAR HI LIM	0.1 to 10.0M
PF LOW LIM	0.1 to 1.0
V SENS OUT	0.5 to 10.0M
V SENS IN	0.5 to 10.0M
I SENS OUT	0.1 to 10.0M
I SENS IN	0.1 to 10.0M
V TRANS %	1 to 10.0M
I TRANS %	1.1 to 10.0M
# 3 V HARM %	0.1 to 1.0K
# 3 I HARM %	0.1 to 1.0K

Continued on next page

Editing Parameter Thresholds, Continued

Choosing an editing method

Follow these steps to modify either three phase or individual channel thresholds.

Step	Action
1	View the desired setup (see page 6-6).
2	<p>Press EDIT SETUP.</p> <p>The following screen will appear.</p> <div data-bbox="669 674 1287 1014" data-label="Code-Block"> <pre> Jan-21-94 15:07:51 EDIT SETUPS MENU SETUP # 1: SINGLE-PHASE 120 VOLT W/N-G 1. SET IDENTICAL 3-PHASE THRESHOLDS 2. SET INDIVIDUAL CHANNELS THRESHOLDS 3. SELECT WAVEFORM CAPTURE 4. COPY EASY START THRESHOLDS TO #9 EXIT </pre> </div>
3	Select item 1 or 2.

Set identical three phase thresholds screen

If you selected item 1, the following screen will appear.

```

Sep-24-93                               17:43:34
                                SETUP # 1: SINGLE-PHASE 120 VOLT W/N-G
                                THRESHOLD   CH.A   CH.B   CH.C   CH.D
                                U HI LIM    128.0  128.0  128.0  128.0
                                U LO LIM    108.0  108.0  108.0  108.0
                                U TRANS     2.0K   2.0K   2.0K   2.0K
                                U THD %     100.0  100.0  100.0  100.0
                                U FREQ HZ    0.5    0.5    0.5    0.5
                                NEXT  NEXT  ON/OFF  ENTER  EDIT  EXIT
                                LIMIT GROUP PARAM. VALUE NAME

```

Continued on next page

Editing Parameter Thresholds, Continued

Set individual channel thresholds screen

If you selected item 2, the following screen will appear.

Sep-29-93	17:06:44				
SETUP # 1=SINGLE-PHASE 120 VOLT W/N-G					
THRESHOLD	CH.A	CH.B	CH.C	CH.D	
V HI LIM	128.0	128.0	128.0	128.0	
V LO LIM	108.0	108.0	108.0	108.0	
V TRANS	2.0K	2.0K	2.0K	2.0K	
V THD %	100.0	100.0	100.0	100.0	
V FREQ HZ	0.5	0.5	0.5	0.5	
NEXT LIMIT	NEXT GROUP	ON/OFF PARAM.	ENTER VALUE	EDIT NAME	EXIT

EDIT HARM # key

This key replaces the EDIT NAME key when the group containing #n V HARM and #n I HARM is displayed. It allows you to enter a harmonic number from 2 to 50 for 60 Hz or 2 to 8 for 400 Hz.

Changing a threshold setting

Follow these steps to change a threshold setting.

Step	Action						
1	Press the NEXT LIMIT key to move the highlight bar to the desired parameter and channel.						
2	Press ENTER VALUE. The menu bar will change to the following. <div style="text-align: center;"> <table border="1"> <tr> <td>ENTER</td> <td>BACK SPACE</td> <td></td> <td></td> <td></td> <td>EXIT</td> </tr> </table> </div>	ENTER	BACK SPACE				EXIT
ENTER	BACK SPACE				EXIT		
3	Enter the number from the keypad. The number for the highlighted parameter must be within the range shown on page 6-7.						
4	Press ENTER.						

Note

Hi Lim must be set to a value that is greater than Lo Lim,

Continued on next page

Editing Parameter Thresholds, Continued

Disabling a parameter

Follow these steps to disable a parameter.

Step	Action
1	Press the NEXT LIMIT key to move the highlight bar to the desired parameter and channel.
2	Press ON/OFF PARAM to toggle parameter on or off. Off indicated by xxx. <u>Result:</u> The string XXX will be displayed for that parameter.

Changing the setup name

Follow these steps to edit the setup name. The setup name can be up to 29 characters long.

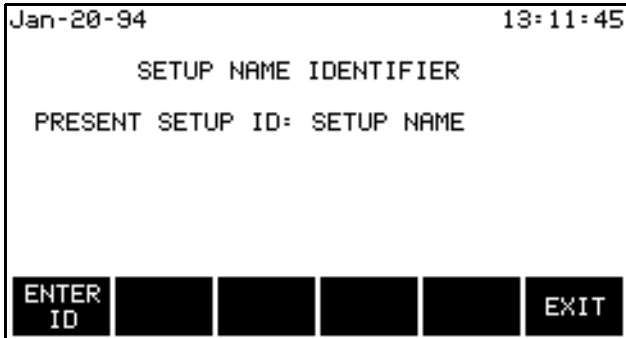
Step	Action
1	Press EDIT NAME. <u>Result:</u> The following screen will appear. 
2	Press ENTER ID to display alphabetic entry screen.
3	Enter the new name. Up to 29 characters are available.
4	Press EXIT.

Continued on next page

Editing Parameter Thresholds, Continued

Entering a harmonic number

Follow these steps to enter a harmonic number for V HARM or I HARM.

Step	Action
1	Press NEXT GROUP until the harmonics parameters are displayed.
2	Move the highlight bar to #n V HARM or #n I HARM.
3	Press EDIT HARM# The numeric bar will change to the following. 
4	Enter the number from the keypad. The number for the highlighted parameter must be within the range shown on page 6-7. Valid range is 2-50 for 60 HZ and 2-8 for 400 Hz.
5	Press ENTER.

Saving the settings

Press EXIT to save all of the threshold settings.

Where to go from here

Refer to the next page if you want to change the waveform capture settings.

Refer to pages 4-50 and 4-53 if you want to activate the setup and turn on monitoring.

Setting Waveform Capture

Definition Waveform capture is a function that saves waveform data when an event is triggered by a threshold crossing. This function can be set so that waveforms for the triggered channel, from all channels, or from no channels are saved.

Note Waveform capture must be individually set for each parameter listed on page 6-7.

Combinations The following table lists all the combinations available for waveform capture, and describes each setting.

Wave Capture	Record All Channels	Description
ON	ON	Saves waveform data for all channels for the chosen parameter.
ON	OFF	Saves waveform data for the triggered channel only.
OFF	ON	Invalid combination*
OFF	OFF	No waveform data is saved.

* Invalid combination can not be entered in PP1-PQPlus and audible beeps will be heard.

Displaying the screen Follow these steps to display the waveform capture screen.

Step	Action
1	Select item #3, Setup Menu, from the Main Menu.
2	Select item #1, Set Thresholds/Channel Config., from the Setup Menu.
3	Press the NEXT SCREEN key.
4	Press NEXT SETUP until the desired setup is displayed.
5	Press EDIT SETUP.

Continued on next page

Setting Waveform Capture, Continued

Displaying the screen
(continued)

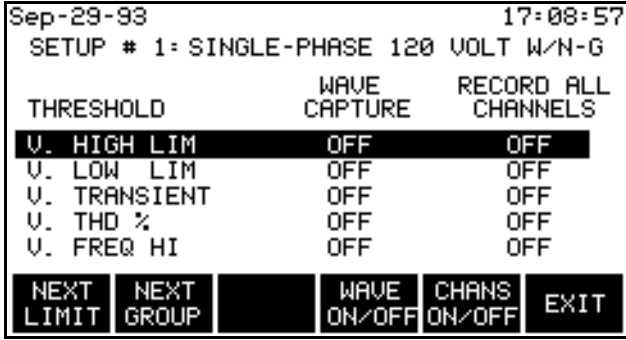
Step	Action
6	<p>Select item #3, Select Waveform Capture, from the Edit Setups Menu.</p> <p>The following sample screen will appear. This screen shows default condition for setup #1.</p> 

Changing a setting

Follow these steps to change the waveform capture settings.

Step	Action
1	Press NEXT GROUP to display the desired parameter group.
2	Press the NEXT LIMIT key to move the highlight bar to the desired line.
3	Press WAVE ON/OFF to change the setting in the Wave Capture column.
4	Press CHANS ON/OFF to change the setting in the Record All Channels column.
5	Repeat steps 1 to 4 for all parameters that you want to change.

Where to go from here

Refer to pages 4-50 and 4-53 to activate the setup and turn on monitoring.

Controlling Event Monitoring with the Digital Inputs

Control Functions The digital inputs located on the rear panel can be used to control monitoring in two ways: Start/stop and generate a snapshot.

Start/stop definition Function whereby the unit starts monitoring when a start signal is received at digital input #1 and continues to monitor until a stop signal is received at digital input #2.

Start signal: low to high transition on digital input #1.

Stop signal: high to low transition on digital input #2.

Snapshot enable definition Function whereby an on signal received at digital input #3 or #4 causes instantaneous data from all channels to be saved as a DIG WAVE CAPT event.

On signal: low to high transition on digital input #3 or #4.

Note Both start/stop and snapshot can be active at the same time.

Process Controlling event monitoring with the digital inputs can be broken down into the following two stages.

Stage	Description	See Page
1	Making connections to the rear panel.	6-15
2	Changing the digital inputs configuration.	6-17

Making Digital Input Connections to the Rear Panel

WARNING Make all connections with the power off.

ADVERTENCIA Haga todas las conexiones con la energía apagada.

AVERTISSEMENT Effectuez toutes les connexions avec l'alimentation coupée.

WARNUNG Arbeiten Sie nur mit ausgeschaltetem Strom an allen Verbindungen.

Pluggable terminal block

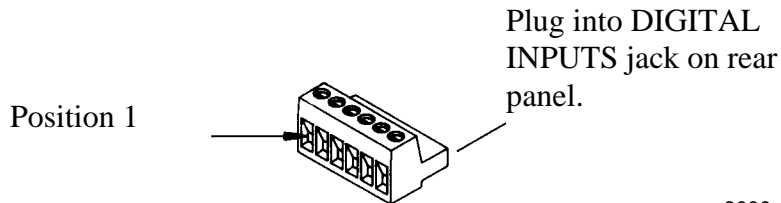

8000-14

Wire gauges #30 to #14 AWG

Start/stop connection diagram Make start/stop connections to the rear panel according to the following diagram. Users must provide the external DC supply.

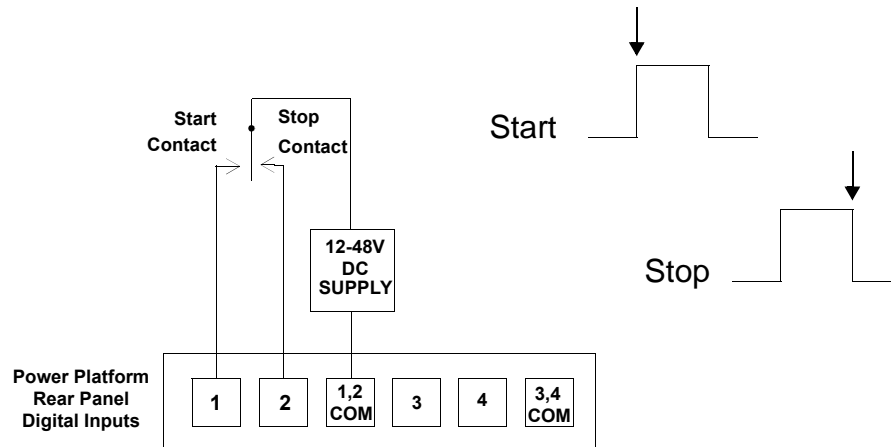

8600-60

Making Digital Input Connections to the Rear Panel, Continued

Snapshot enable connection diagram Make snapshot enable connections to the rear panel according to the following diagram. Users must provide the external DC supply.

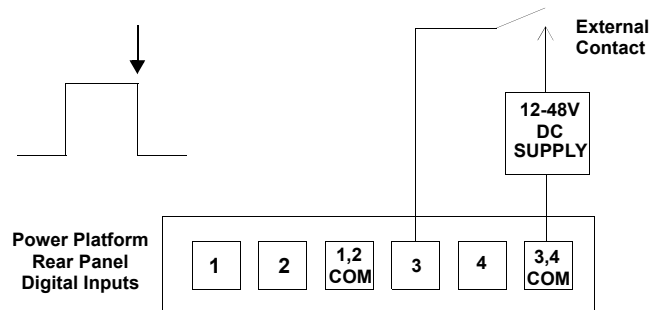

8600-61

Note The inputs labeled 1,2 COM and 3,4 COM are not connected together internally. If the same power source is used to power contacts 1&2 and 3&4, then the commons must be connected together externally.

Connection procedure Follow these steps when making connections to the digital inputs on the rear panel.

Step	Action
1	Insert a wire into the appropriate open position on the terminal block.
2	Tighten the screw clamp.
3	Repeat steps 1 and 2 for each wire you want to connect.
4	Push the terminal block into the digital input connector on the rear panel.

Changing the Digital Inputs Configuration

Displaying the screen

Follow these steps to display the Digital Inputs Configuration screen.

Step	Action
1	Select item #3, Setup Menu, from the Main Menu.
2	Select item #8, I/O Devices, from the Setup Menu.
3	Select item #1, Digital Inputs, from the Configure Input/Output Devices Menu. The following screen will appear.

```

Sep-14-93                               10:39:13
          DIGITAL INPUTS CONFIGURATION
CHANNEL      PRESENT CONFIGURATION
  1          NOT USED
  2          NOT USED
  3          NOT USED
  4          NOT USED
NEXT CHAN  NEXT CONFIG  PRINT  EXIT
    
```

Start/stop procedure

Follow these steps to configure the digital inputs for stop/start monitoring.

Step	Action
1	Press NEXT CHAN to highlight channel 1 or 2. Input channels 1 and 2 are paired together for the start/stop function.
1	Press NEXT CONFIG. <u>Result:</u> START/STOP will appear for channels 1 and 2.
2	Press EXIT.

Continued on next page

Changing the Digital Inputs Configuration, Continued

Snapshot enable procedure Follow these steps to configure the digital inputs for snapshot enable monitoring.

Step	Action
1	Press NEXT CHAN until channel 3 or 4 is highlighted.
2	Press NEXT CONFIG. <u>Result:</u> SNAPSHOT ENABLE will appear for the selected channel. Input channel 3 or 4 can be independently set for snapshot enable.
3	Press EXIT.

Chapter 7

Housekeeping Functions

Overview

Introduction Housekeeping functions consists of the miscellaneous tasks that you need to perform to keep your PP1-PQPlus running in an efficient and organized way. These are tasks that you might perform only occasionally.

Printing options Refer to page 1-6 for printing options if you have any questions about using the print functions in this chapter.

In this chapter The following topics are covered in this chapter.

Topic	See Page
Entering a Site Name	7-2
Setting the Time and Date	7-4
Selecting the Language	7-6
Setting the Audible Alarm and LCD Mode	7-9
Setting Error Message Output	7-7
Clearing Memory	7-10
Resetting the Unit to the Factory Configuration	7-11
Running a Self-Test	7-15
Setting Memory Storage Mode	7-17
Setting Auto-transfer to Memory Card	7-18

Entering a Site Name

Introduction

This function allows you to enter a site name of up to 20 characters. The site name appears on printouts and is included with reports sent to the fax/modem, RS-232, printer, PC, or memory card. The site name is also used for file names on the memory card.

Procedure

Follow these steps to enter a site name.

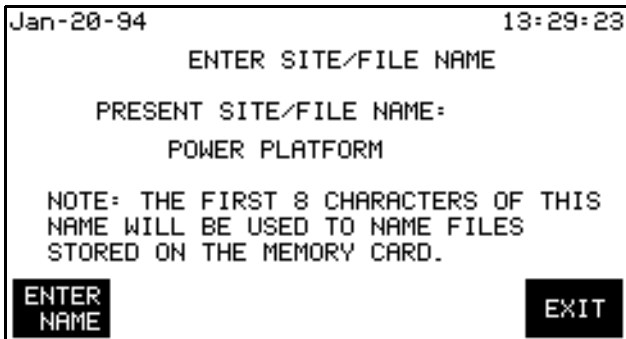
Step	Action
1	Select item #3, Setup Menu, from the Main Menu.
2	Select item #2, Set Analyzer Parameters, from the Setup Menu.
3	Select item #1, Set Site/File Name, from the Set Analyzer Parameters Menu. The following screen will appear. 

Continued on next page

Entering a Site Name, Continued

Procedure
(continued)

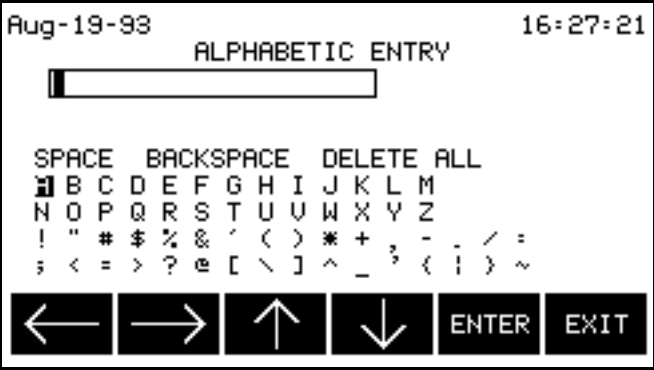
Step	Action
4	<p>Press the ENTER NAME key.</p> <p><u>Result:</u> The following screen will appear.</p> 
5	Highlight a desired letter or symbol using the arrow keys, then press ENTER.
6	Numbers are entered directly from keypad.
7	Repeat steps 5 and 6 until the entire name has been entered. Characters limited to 20.
8	<p>Use the Backspace command to delete characters.</p> <p>Enter numbers from the keypad.</p>

Setting the Time and Date

Displaying the screen

Follow these steps to display the time and date screen.

Step	Action
1	Select item #3, Setup Menu, from the Main Menu.
2	Select item #2, Set Analyzer Parameters, from the Setup Menu.
3	Select item #2, Set Time & Date, from the Set Analyzer Parameters Menu. The following screen will appear. 

Setting the time

Follow these steps to set the time.

Step	Action
1	Press the ENTER TIME key. The menu bar changes to the following. 
2	Enter the hours, minutes, and seconds, pressing the ENTER key after each number. Time is set in 24 hour format.

Continued on next page

Setting the Time and Date, Continued

Setting the date Follow these steps to set the date.

Step	Action						
1	<p>Press the ENTER DATE key.</p> <p>The menu bar changes to the following.</p> <div data-bbox="675 600 1297 667" style="text-align: center; border: 1px solid black; padding: 5px;"><table border="1" style="display: inline-table; border-collapse: collapse;"><tr><td style="padding: 2px 10px;">ENTER</td><td style="padding: 2px 10px;">BACK SPACE</td><td style="padding: 2px 10px;"> </td><td style="padding: 2px 10px;"> </td><td style="padding: 2px 10px;"> </td><td style="padding: 2px 10px;">EXIT</td></tr></table></div>	ENTER	BACK SPACE				EXIT
ENTER	BACK SPACE				EXIT		
2	<p>Enter the number of the month.</p> <p><u>Example:</u> Enter 1 for January, 2 for February, etc.</p>						
3	<p>Press ENTER. Month number is displayed and highlight moves to the day number for selection.</p>						
4	<p>Enter the day and press ENTER. The day number is displayed and the year is highlighted next.</p>						
5	<p>Enter the last two digits of the year and press ENTER. The new date will be displayed on the screen.</p>						

Selecting the Language

Introduction

The PQPlus TASKcard is available in three language configurations:

- PQPlus-E, English only
- PQPlus-S, Spanish and English (Spanish is default)
- PQPlus-F, French and English (French is default)

With the bilingual TASKcards, all of the PQPlus's screens, including help screens and error messages, will appear in the selected language.

Procedure

Follow these steps to select a new language.

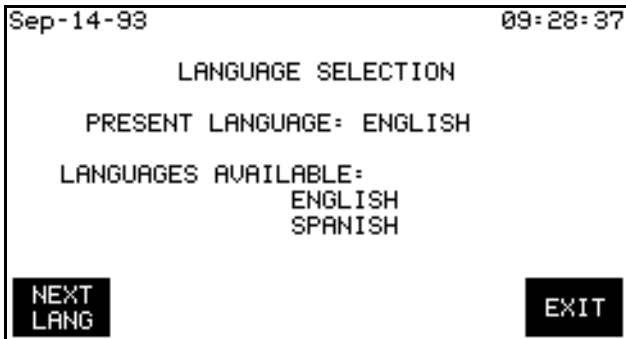
Step	Action
1	Select item #3, Setup Menu, from the Main Menu.
2	Select item #2, Set Analyzer Parameters, from the Setup Menu.
3	Select item #3, Select Language, from the Set Analyzer Parameters menu. <u>Result:</u> The following screen will appear for the PQPlus-S TASKCard.  For the PQPlus-F TASKCard the available languages are English and French.
4	Press NEXT LANG for other language selection.
5	Press EXIT to enable language selected. <u>Result:</u> All screens will be displayed in the selected language.

Setting Error Message Output

Introduction

Error messages are always sent to the LCD display and the printer (if it is on). Additional outputs (RS-232, modem, relay #1) can be selected for specific error messages.

Displaying the screen

Follow these steps to display the Error Message Output screen.

Step	Action
1	Select item #3, Setup Menu, from the Main Menu.
2	Select item #2, Set Analyzer Parameters, from the Setup Menu.
3	Select item #4, Select Error Message Output, from the Set Analyzer Parameters Menu. A screen similar to the following will appear.

```

Feb-25-94                               15:45:25
      ERROR MESSAGE OUTPUT
  ERROR MESSAGES           OUTPUT DEVICE
PRINTER PAPER LOW        RS232 MODEM
BATTERY LOW              RS232 MODEM RLY 1
AC POWER LOSS            RS232 MODEM
SYNCH LOSS               RS232 MODEM
INPUT OVERLOAD           RS232 MODEM
DEVICE FAULT             RS232 MODEM
MISC. ERRORS             RS232 MODEM
NEXT  SELECT  SELECT  SELECT  [ ]  EXIT
ERROR  RS232  MODEM  RELAY1
    
```

Selecting output devices

Follow these steps to select the devices for error message output.

Step	Action
1	Press NEXT ERROR to move the highlight to the desired error message.
2	Select the desired output device(s) by pressing the appropriate key(s) at the bottom of the screen. Each select key toggles that choice on/off.
3	Repeat steps 1 and 2 for each error message.

Continued on next page

Setting Error Message Output, Continued

**Where to go
from here**

Refer to the following table for the page numbers containing information about your chosen output device(s).

IF you selected...	THEN see page
RS-232	11-14
Modem	11-20
Relay #1	8-10

Setting the Audible Alarm and LCD Mode

Displaying the screen

Follow these steps to display the Other Devices Configuration screen.

Step	Action
1	Select item #3, Setup Menu, from the Main Menu.
2	Select item #8, I/O Devices, from the Setup Menu.
3	Select item #6, Other Devices, from the Configure Input/Output Devices Menu. The following default screen will appear. <div data-bbox="683 632 1308 968" data-label="Image"> </div>

LCD backlight auto-shutoff

Enabled: The backlight for the LCD display will shut off if no key has been pressed for 15 minutes.

Disabled: The backlight for the LCD display will stay on continuously.

Note: The enabled auto-shutoff feature extends the life of the backlight and is recommended for use. Battery run time is also extended.

Audible alarm

Press the ALARM ON/OFF to toggle the alarm on and off. In the off condition, all beeps are disabled.

LCD mode

Press numeral 1 key to toggle.

Normal: Displays text and graphics as blue on a white background.

Inverted: Displays text and graphics as white on a blue background.

Note

See Chapter 12 for printer functions.

Clearing Memory

CAUTION Clearing memory deletes all events that are currently saved. To avoid losing data, save all events to a memory card before proceeding.

PRECAUCIÓN Si se despeja la memoria se suprimen todos los sucesos actualmente guardados. Para evitar perder datos, guarde todos los eventos en una tarjeta de memoria antes de proceder.

MISE EN GARDE La fonction d'effacement de mémoire supprime tous les événements sauvegardés au fur et à mesure. Pour éviter toute perte de données, avant de poursuivre sauvegardez tous les événements sur une carte à mémoire.

VORSICHT Durch das Löschen des Arbeitsspeichers werden alle aktuell gespeicherten Ereignisse entfernt. Um einen Datenverlust zu vermeiden, sollten Sie alle Ereignisse vor dem Fortfahren auf einer Speicherkarte speichern.

Procedure Follow these steps to clear memory.

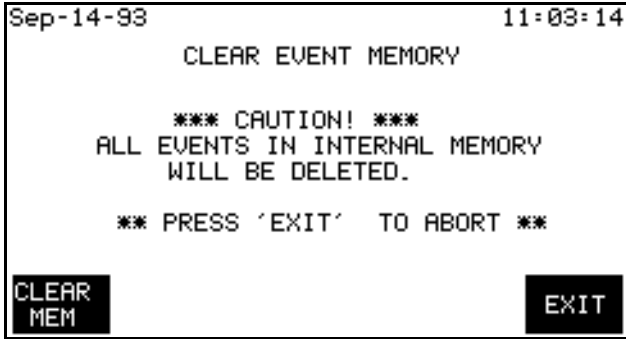
Step	Action
1	Select item #3, Setup Menu, from the Main Menu.
2	Select item #7, Memory Functions, from the Setup Menu.
3	Select item #3, Clear Memory, From the Memory Functions Menu. The following screen will appear. 
4	Press the CLEAR MEM key.

Resetting the Unit to the Factory Configuration

Definition The factory configuration is the default setting of each screen, variable parameter or text field of the PP1-PQPlus when it left the factory.

Reset to default To reset to factory set configuration defaults, EXIT to Main Menu, then select menu items 3, 7, 5, in sequence to the Reset screen. Press RESET.

List Factory configurations consist of the following with their screen references.

Configuration	Factory Setting	Reference Screen*
ABC Totals	Single Phase	3, 1, ABC-Totals
Alarm (Beeps)	On	3, 8, 6
Automatic Reports Settings	Status: Off Output Device: Printer Trigger Condition: Memory Full Report Type: 1. Plot Ch A, V rms 2. Plot Ch A, I rms 3. Plot Ch A, K-factor 4. Digital Time Plot 1 5. Relay Closure 6. Worse Case Events 7. Plot V Unbalance	3, 4
Digital Inputs	Channels 1, 2, 3, 4 Not Used	3, 8, 1
Easy Start Percent Tolerance	10%	3, 6
Error Message Output	None	3, 2, 4
Input Voltage/Current Channels Setup	Channels A, B, C, D (Low) set to on.	3, 1

* To find the screen reference associated with the configuration, exit to the Main Menu, then select the path of screen item numbers referenced in this column. For example; from the Main Menu, Reference Screen 3, 8, 6 relates to selecting 3 (Setup Menu), then 8 (I/O Devices), then 6 (Other Devices) where you will find the configuration selection. Some screens in the path require you to select items from the Menu Bar on the screen bottom, such as ABC Totals and Freq Sync.

Continued on next page

Resetting the Unit to the Factory Configuration, Continued

List (continued)

Configuration	Factory Setting	Ref. Screen
Interval for Timed Readings	15 minutes	3, 5
Fax/Modem	Set Device: Modem Baud Rate: 2400 Auto Baud: On Parity: None Flow Control: None # Rings Before Answer: 2 # Dial Attempts: 10 Modem Header: ATQ0V0X4S7=60S9=10S10=5 Modem Phone #:1-908-2878874 Fax Phone: 1-908-2481834	3, 8, 4
Frequency Sync	External	3, 1, Freq Sync
Language	English	3, 2, 3
LCD Backlight Auto-Shutoff	Enabled	3, 8, 6
LCD Display Mode	Normal	3, 8, 6
Memory Auto-transfer	Do Not Auto Transfer	3, 7, 2
Memory Storage Type	Fill and Stop	3, 7, 4
Monitoring (of inputs)	On	3, 3
Parallel Port	Off	3, 8, 3
Printer (Internal)	On	3, 8, 6
Printer Battery Operation	Time Limit	3, 8, 6
Record waveform data for all Channels	Refer to Appendix G	3, 1, Next Screen, Edit, 3
Relay Inputs	Relays 1, 2, 3, 4 open	3, 8, 5

Continued on next page

Resetting the Unit to the Factory Configuration, Continued

List (continued)

Configuration	Factory Setting	Ref. Screen
RS-232D	Baud Rate: 9600 Parity: None # Stop Bits: 1 Flow Control: Software Device: Terminal	3, 8, 2
Scale Factors	Channels A, B, C, D (Low) set to 1.000	3, Scale Factor
Setup active	Setup #1 - Single phase	3, 1, Next Screen
Site/File Name	Power Platform	3, 2, 1
Time and Date	Last setting	3, 2, 2
Thresholds levels for Setups 1 to 10	Refer to Appendix G	3, 1, Next Screen
Waveform capture settings	Refer to Appendix G	3, 1, Next Screen, Edit, 3

Factory Configuration, Continued

CAUTION This command resets all threshold settings, port configurations and other defaults to factory settings.

PRECAUCIÓN Este comando reajusta todos los ajustes de umbral, configuraciones de puerto y otros valores predeterminados devolviéndolos a los ajustes de fábrica.

MISE EN GARDE Cette commande réinitialise tous les réglages de seuil, les configurations des ports et autres réglages par défaut d'usine.

VORSICHT Dieser Befehl setzt alle Schwelleneinstellungen, Ausgangskonfigurationen und andere Voreinstellungen auf die Fabrikeinstellung zurück.

Procedure Follow these steps to reset the PP1-PQPlus to its factory configuration.

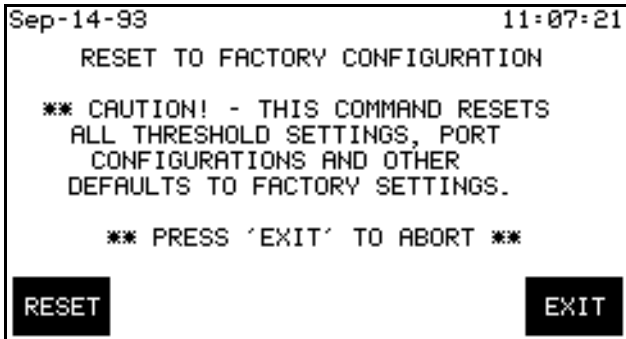
Step	Action
1	Select item #3, Setup Menu, from the Main Menu.
2	Select item #7, Memory Functions, from the Setup Menu.
3	Select item #5, Reset to Factory Configuration, From the Memory Functions Menu. The following screen will appear. 
4	Press the RESET key. Reset complete when unit beeps (10 sec).

Running a Self-Test

Introduction The self-test function performs an extensive test of the system. The test lasts approximately 45 seconds. Only run the self-test during non-critical monitoring times, as no data is acquired during the test.

CAUTION **Monitoring will be turned off for the duration of the test.**

PRECAUCIÓN **El monitoreo quedará apagado mientras dure la prueba.**

MISE EN GARDE **La surveillance sera mise à l'arrêt pour toute la durée du test.**

VORSICHT **Die Überwachung ist während des Tests ausgeschaltet.**

Procedure Follow these steps to run a self-test.

Step	Action
1	Select item #5, View Status, from the Main Menu. <div data-bbox="675 1068 1292 1402" style="border: 1px solid black; padding: 5px; margin: 10px auto; width: fit-content;"> <pre> Jan-28-94 01:26:19 SITE STATUS SITE NAME: POWER PLATFORM START EVENT: 28 Jan 94, 00:18:03 ACTIVE SETUP: # 1 VOLTAGE CHANNELS ON: A, B, C, D CURRENT CHANNELS ON: A, B, C, D MEMORY: 0 % FULL ANLYZR SELF PRINT EXIT STATUS TEST </pre> </div>
2	Press SELF TEST to display the following message. <div data-bbox="675 1522 1292 1856" style="border: 1px solid black; padding: 5px; margin: 10px auto; width: fit-content;"> <pre> Aug-18-93 15:47:03 RUN SELF-TEST CAUTION: SELF TEST HAS BEEN SELECTED. THE ANALYZER SHUTS DOWN NORMAL DATA ACQUISITION AND ANALYSIS DURING THIS TIME. MISREPRESENTATION OF DATA MAY RESULT. * PRESS 'BEGIN TEST' TO CONTINUE. * PRESS 'EXIT' TO ABORT. BEGIN EXIT TEST </pre> </div>

Running a Self-Test, Continued

Note Once BEGIN TEST is pressed, the test cannot be stopped by pressing the EXIT key (or the BEGIN TEST key). The test will run through completion.

Procedure
(continued)

Step	Action
3	Press BEGIN TEST. The following screen is displayed. 

Note If monitoring was on, it turns monitoring off, and sounds alarm for duration of the test - approximately 40 seconds.

Pressing EXIT does not terminate test.

At the completion of the test, the analyzer status screen is displayed.

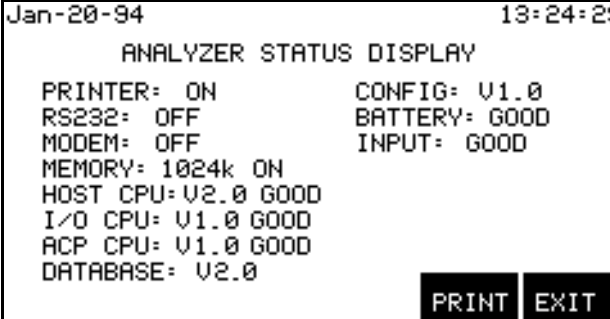

```
Jan-20-94 13:24:29
ANALYZER STATUS DISPLAY
PRINTER: ON          CONFIG: V1.0
RS232: OFF          BATTERY: GOOD
MODEM: OFF          INPUT: GOOD
MEMORY: 1024k ON
HOST CPU: V2.0 GOOD
I/O CPU: V1.0 GOOD
ACP CPU: V1.0 GOOD
DATABASE: V2.0
PRINT EXIT
```

Setting Memory Storage Mode

Introduction The memory storage mode affects how events are saved to internal memory. There are two settings: **Fill and Stop** and **Overwrite**.

Fill and Stop mode When in Fill and Stop mode, the PP1-PQPlus saves events until memory is full, then stops saving new events. All events in memory will be preserved.

Overwrite mode When in Overwrite mode, the PP1-PQPlus will save events normally until memory is full. After that, the PP1-PQPlus will replace the oldest events in memory with new events. This mode sacrifices old data in order to continuously save the most recent events.

Procedure Follow these steps to change the memory storage mode setting.

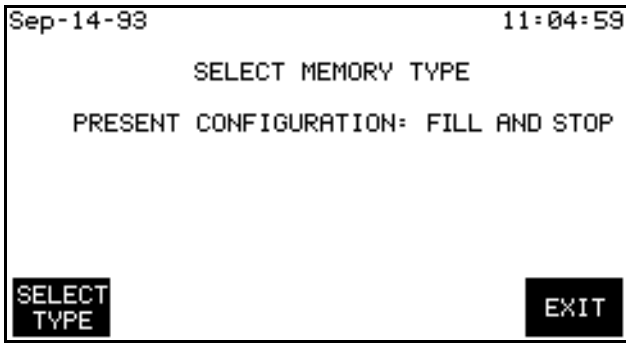
Step	Action
1	From the Main Menu, select item #3, Setup Menu.
2	From the Setup Menu, select item #7, Memory Functions.
3	<p>From the Memory Functions menu, select item #4, Set Memory Storage Mode.</p> <p><u>Result:</u> The following screen will appear.</p> 
4	Press NEXT MODE to change present configuration to Overwrite.
5	Press EXIT to enable Overwrite configuration and return to Memory Function screen.

Setting Auto-transfer to Memory Card

Introduction

The auto-transfer function allows you to set the PP1 to automatically copy events from internal memory to a file on a memory (data) card. This allows you to take advantage of the larger storage capacity of a memory card (for 1 Mbyte or larger cards).

Settings: There are two auto-transfer settings: Update Continuously (enabled) and Do Not Auto-transfer (disabled).

Note: To fully take advantage of the auto-transfer function, the memory storage mode should be set to Overwrite. See previous page about this setting.

Update continuously

When the auto-transfer mode is set to Update Continuously, the PP1-PQPlus will continuously store new event data to the memory card as well as to internal memory.

Do not auto-transfer

When the auto-transfer mode is set to Do Not Auto-transfer, events will be saved to internal memory only.

Auto-transfer file

Size: The file will be as large as the available free space on the memory card.

Filename: The filename for the auto-transfer file is *filename.mdb*. Where *filename* is the first eight characters of the Site/File Name. See page 7-2.

Overwrite mode: When the memory storage mode is set to Overwrite, the auto-transfer file will also Overwrite, independently of internal memory.

Retrieval: Auto-transfer events can be retrieved with the View Events From Memory Card function on the View Data Menu. See page 10-9.

Procedure

Follow these steps to change the auto-transfer setting.

Step	Action
1	From the Main Menu, select item #3, Setup Menu.
2	From the Setup Menu, select item #7, Memory Functions.

Continued on next page

Setting Auto-transfer to Memory Card, Continued

Procedure
(continued)

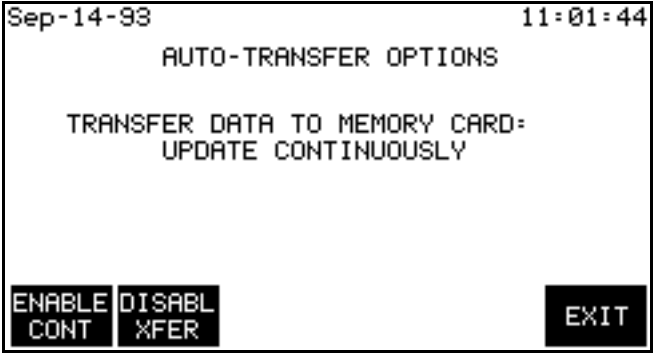
Step	Action
3	<p>From the Memory Functions menu, select item #2, Auto-transfer Options.</p> <p><u>Result:</u> The following screen will appear.</p> 
4	<p>Press ENABLE CONT or DISABLE XFER to change the auto-transfer mode.</p>
5	<p>Press EXIT to enable auto-transfer.</p> <p><u>Note:</u> When auto-transfer is enabled, events in memory will immediately be transferred to the memory card and the message "Auto-Transfer in Progress. Please Wait." will be displayed. The DATA CARD indicator will light when data is being transferred to the memory (data) card.</p>

Chapter 8

Reports

Overview

Introduction The reports function of the PP1-PQPlus allows you to send data, formatted as different report types, to various output devices when a programmed trigger condition is met.

Note The automatic reports function is optional. Normal data storage is not affected when this function is set.

Printing options Refer to page 1-9 for printing options if you have any questions about using the print functions in this chapter.

In this chapter The following topics are covered in this chapter:

Topic	See Page
Automatic Reports	8-2
Setting Automatic Reports	8-4
Selecting a Report Type	8-5
Making Relay Connections to the Rear Panel	8-8
Setting Relay #1	8-10

Automatic Reports

Definition Reports that are automatically sent to a designated output device when a certain trigger condition is met.

Report types The following table lists the four types of automatic reports that can be selected.

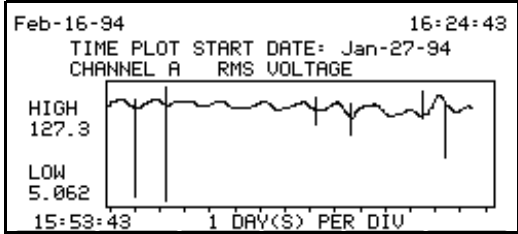
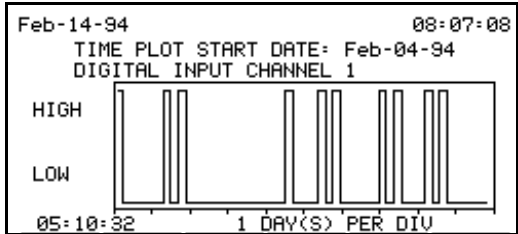
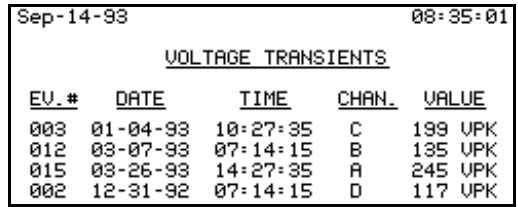
Report Type	What is sent	Example																									
Analog time plot	Time plot data for the specified parameter and channel since the memory was cleared. See page 9-2 for details.																										
Digital time plot	Time plot data for the specified digital input channel since the memory was cleared. See page 9-11 for details.																										
Worst case events	Worst case events that have occurred on each active channel since memory was cleared. See page 10-16 for details.	 <table border="1" data-bbox="880 1318 1382 1438"> <thead> <tr> <th>EV.#</th> <th>DATE</th> <th>TIME</th> <th>CHAN.</th> <th>VALUE</th> </tr> </thead> <tbody> <tr> <td>003</td> <td>01-04-93</td> <td>10:27:35</td> <td>C</td> <td>199 UPK</td> </tr> <tr> <td>012</td> <td>03-07-93</td> <td>07:14:15</td> <td>B</td> <td>135 UPK</td> </tr> <tr> <td>015</td> <td>03-26-93</td> <td>14:27:35</td> <td>A</td> <td>245 UPK</td> </tr> <tr> <td>002</td> <td>12-31-92</td> <td>07:14:15</td> <td>D</td> <td>117 UPK</td> </tr> </tbody> </table>	EV.#	DATE	TIME	CHAN.	VALUE	003	01-04-93	10:27:35	C	199 UPK	012	03-07-93	07:14:15	B	135 UPK	015	03-26-93	14:27:35	A	245 UPK	002	12-31-92	07:14:15	D	117 UPK
EV.#	DATE	TIME	CHAN.	VALUE																							
003	01-04-93	10:27:35	C	199 UPK																							
012	03-07-93	07:14:15	B	135 UPK																							
015	03-26-93	14:27:35	A	245 UPK																							
002	12-31-92	07:14:15	D	117 UPK																							
Relay closure	Nothing. Relay #1 changes state when trigger condition is met.																										

Continued on next page

Automatic Reports, Continued

Output devices The output devices available are based on the report type chosen, according to the following table:

Report Type	Possible Output Device(s)
Analog Time Plot	Printer, Fax
Digital Time Plot	Printer, Fax
Worst Case Events	Printer, Fax
Relay Closure	Printer, Fax

Trigger types The four types of triggers are listed below.

Trigger	Description
Memory full	Triggered when memory fills. If memory is in wrap mode, this trigger is only generated the first time memory fills.
Out-of-limits event	Triggered each time a threshold is crossed.
Digital input trigger	Triggered when a pulse is received on digital input channel #3 or 4.
Daily (00:00:00)	Triggered each day at midnight.

Setting Automatic Reports

Displaying the screen

Follow these steps to display the Set Automatic Reports screen.

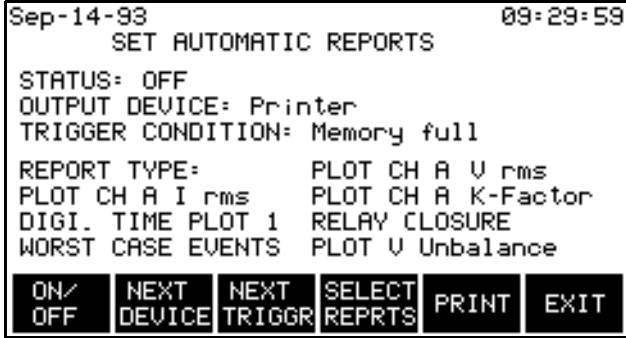
Step	Action
1	Select item #3, Setup Menu, from the Main Menu.
2	<p>Select item #4, Set Automatic Reports, from the Setup Menu.</p> <p>The following screen will appear for default settings and may vary if selections have been chosen previously.</p> 

Procedure

Follow these steps to set automatic reports.

Step	Action
1	Press NEXT DEVICE key until the desired output device of Printer or FAX is displayed.
2	<p>Press NEXT TRIGGR until the desired trigger condition of one of the following selection is displayed:</p> <ul style="list-style-type: none"> Memory full Out-of-limits events Digital input Daily (00-00-00)
3	Press ON/OFF to toggle Status to ON or OFF.
4	Press SELECT REPRTS.
5	Go to next page for screen display of available reports.

Selecting a Report Type

Select reports screen

The following default screen or similar selected report screen is displayed.

```

DEC-14-95                                09:31:42
      SELECT REPORT TYPE
REPORT 1. TIME PLOT CH A I rms
REPORT 2. TIME PLOT CH A V rms
REPORT 3. TIME PLOT CH A K-Factor
REPORT 4. DIGITAL TIME PLOT 1
REPORT 5. RELAY CLOSURE
REPORT 6. WORST CASE EVENTS
REPORT 7. TIME PLOT V Unbalance
NEXT  NEXT  DELETE SELECT SELECT
REPORT TYPE REPORT PARAM CHAN  EXIT
  
```

A maximum of seven reports can be selected. Each report allows selection of 4 different types of information (28 combinations of basic report types are possible). Each basic analog report can be modified to select 1 of 5 channel selections and 16 different parameters (90 combinations of analog information are possible).

Note

Reports 1, 2, 3, and 7 are shown above as selected reports of Analog Time Plots. Report 7 is not channel or parameter selectable.

Procedure



Follow these steps to select the desired report types.

Step	Action
1	Press NEXT REPORT to highlight the desired default report type or report of interest previously set up.
2	Press NEXT TYPE to cycle through the following report types until the desired report is displayed (this function is available for each report): <ul style="list-style-type: none"> Time Plot CH x (analog parameter) Digital Time Plot 1 Worse Case Events Relay Closure
3	If you selected Time Plot CH x (analog parameter) go to next step. If not, go to step 8.

Continued on next page

Selecting a Report Type, Continued

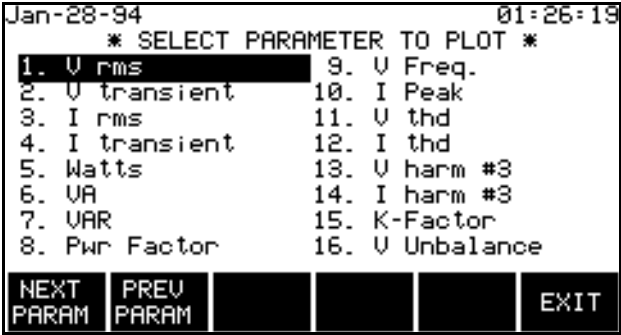
Procedure (continued)

Step	Action
4	<p>Press SELECT PARAM.</p> <p><u>Result:</u> The following screen appears.</p>  <p>Note: Harmonic number is selected for the active setup. See page 6-9 for selecting harmonic number.</p>
5	Press NEXT PARAM or PREV PARAM until the desired parameter to plot is highlighted.
6	Press EXIT to return to Select Report Type screen.
7	Press SELECT CHAN until the desired channel A, B, C, D, or ABC appears.
8	If you selected Digital Time Plot x, go to next step. If not, go to step 11.
9	<p>The following menu bar appears.</p> 
10	Press SELECT CHAN until the desired digital channel of 1, 2, 3, or 4 appears.

Continued on next page

Selecting a Report Type, Continued

Procedure
(continued)

Step	Action						
11	<p>When the Worse Case Events or Relay Closure report is selected, the following menu bar appears.</p> <div data-bbox="602 520 1179 590" style="border: 1px solid black; padding: 2px; text-align: center;"><table border="1"><tr><td>NEXT REPORT</td><td>NEXT TYPE</td><td>DELETE REPORT</td><td></td><td></td><td>EXIT</td></tr></table></div> <p>No further selections are required. Only relay number 1 is operational for automatic reports.</p>	NEXT REPORT	NEXT TYPE	DELETE REPORT			EXIT
NEXT REPORT	NEXT TYPE	DELETE REPORT			EXIT		
12	Press EXIT once to return to the Set Automatic Reports screen.						
13	Press SELECT REPRTS to return to the Select Report Type screen for selection of other reports.						
14	Press EXIT once to return to the Set Automatic Reports screen.						
15	Set Status to ON by pressing the ON/OFF softkey.						

Making Relay Connections to the Rear Panel

Introduction The PQPlus TASKCard uses Relay #1 for control of externally connected control or alarm circuits.

Pluggable Terminal Block The relay terminal block, shown below, is used to connect wires to control an external circuit from internal relay contacts of the Power Platform.

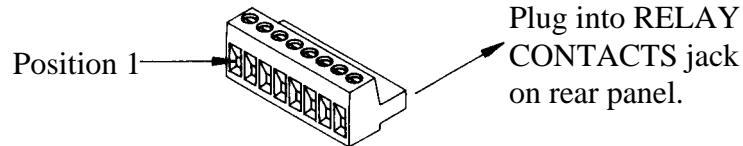

Wire gauges #30 to #14 AWG

WARNING **Make all connections with the power off.**

ADVERTENCIA **Haga todas las conexiones con la energía apagada.**

AVERTISSEMENT **Effectuez toutes les connexions avec l'alimentation coupée.**

WARNUNG **Arbeiten Sie nur mit ausgeschaltetem Strom an allen Verbindungen.**

Continued on next page

Making Relay Connections to the Rear Panel, Continued

Relay connection diagram

The connection diagram below shows how an external relay can be connected through the terminal block to the Power Platform internal relay contacts. Either DC (up to 30V) or AC (up to 120V) can be used as source voltage. The contacts are menu selected for normally open (NO) or normally closed (NC) configuration. Contact rating is 1 amp at 30VDC or 120VAC, resistive.

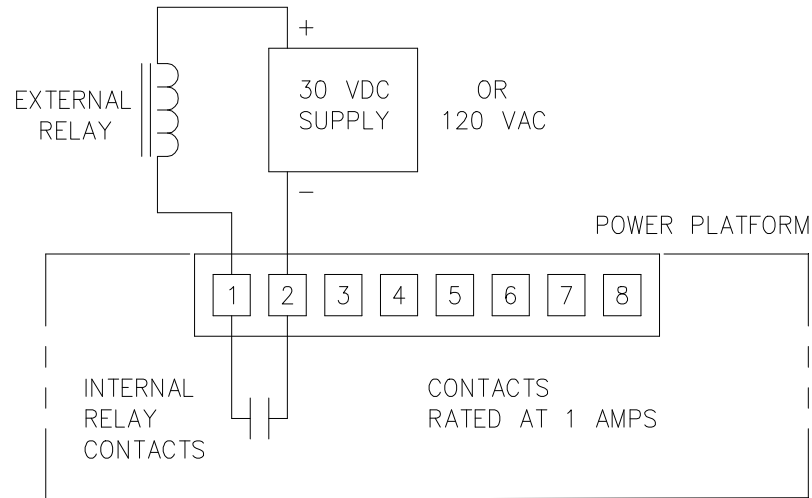

8600-41

Connection procedure

Follow these steps when making connections to relay #1 on the rear panel.

Step	Action
1	Connect the control wires to the external circuits.
2	Insert a wire into position 1 on the terminal block.
3	Tighten the screw clamp.
4	Repeat steps 2 and 3 for the wire connecting to position 2.
5	Push the terminal block into the relay input connector on the rear panel.

Setting Relay #1

Introduction

Relay #1 can be set for automatic operation from the Automatic Reports or the Error Message Output screen. When not under automatic control the relay can be manually controlled from the Relay Configuration screen to test connected circuitry. Refer to page 7-7 for the procedure about selecting error message outputs and page 8-4 for automatic reporting.

Displaying the screen

Follow these steps to display the Relay Configuration screen.

Step	Action
1	Select item #3, Setup Menu, from the Main Menu.
2	Select item #8, I/O Devices, from the Setup Menu.
3	Select item #5, Relays, from the Configure Input/Output Devices Menu. The following screen will appear.

```

Sep-14-93                               10:41:40
                                RELAY CONFIGURATION
                                RELAY      STATE      STATUS
                                1         OPEN      AUTOMATIC
                                2         OPEN      AUTOMATIC
                                3         OPEN      AUTOMATIC
                                4         OPEN      AUTOMATIC
                                SWITCH SWITCH SWITCH SWITCH PRINT EXIT
                                #1      #2      #3      #4

```

State

Power Platform internal relays #1 through #4 contacts can be set to open or closed condition by pressing the respective SWITCH #1-4 key.

Status

Automatic means that the relay is set to be controlled by either Reports or the Error Message Outputs.

Manual means that the relay is not being controlled by another screen.

Chapter 9

Viewing Time Plot Report

Introduction The view reports function consists of two types of time plots: analog and digital.

parameter. The time plot displays all data since the memory was cleared and is continuously updated. You can choose to display one of 16 parameters. Other can perform detailed analysis.

The digital time plot is a graphic summary of the data for one of the four digital and is continuously updated. You can also expand the horizontal axis.

Printing options Refer to page 1-9 for printing options if you have any questions about using the print functions in this chapter.

In this chapter The following topics are covered in this chapter.

Topic	See Page
Viewing Analog Time Plots	9-2
Selecting a Parameter	9-4
Using Horizontal Zoom	9-5
Changing the Vertical Scale	9-7
Changing the Timed Interval Setting	9-9
Viewing Digital Time Plots	9-11

Viewing Analog Time Plots

Update rate The time plot screen is updated every ten seconds.

Horizontal axis Auto-scaled to display all events of the given type.

Vertical axis Auto-scaled to the highest and lowest parameter values.

Channels A, B, C, D, ABC

Parameters The following parameters can be plotted on the time plot screen.

- V rms
- V transient
- I rms
- I transient
- Watts
- VA
- VAR
- Power Factor
- V Freq
- I Peak
- V thd
- I thd
- V harm#__
- I harm#__
- K-Factor
- V Unbalance

Continued on next page

Viewing Analog Time Plots, Continued

Displaying the screen

Follow these steps to display the Analog Time Plots screen.

Step	Action
1	Select item #4, View Reports/Events, from the Main Menu.
2	Select item #1 Time Plots - Analog Inputs, from the View Reports/Events Menu. The following screen will appear.

Function keys

The following table provides a description of the functions keys for the Analog Time Plot screen.

Key	Function
NEXT CHAN	Displays the next channel of data.
SELECT PARAM	Displays the Select Parameter screen. See page 9-4.
ZOOM	Changes the menu bar, allowing you to expand a portion of the plot. See page 9-5.
VERT. SCALE	Displays the Set Vertical Scale box, allowing you to set the high and low limits for the display. Overrides auto-scaling. See page 9-7.
PRINT	Prints the screen.

Selecting a Parameter

Follow these steps to select a parameter for the analog time plot.

Step	
1	<p data-bbox="565 428 883 457">Press SELECT PARAM.</p> <div data-bbox="675 596 1292 926"><pre>Jan-28-94 01:26:19 * SELECT PARAMETER TO PLOT * 1. V rms 9. V Freq. 2. V transient 10. I Peak 3. I rms 11. V thd 4. I transient 12. I thd 5. Watts 13. V harm #3 6. VA 14. I harm #3 7. VAR 15. K-Factor 8. Pwr Factor 16. V Unbalance NEXT PREV PARAM PARAM</pre></div> <p data-bbox="565 953 1276 1024">Note: The harmonic # is set when editing the parameter thresholds. See page</p>
2	Press NEXT PARAM or PREV PARAM until the desired
3	Press EXIT to return to Time Plot Graph.

Using Horizontal Zoom

Introduction

The zoom function allows you to expand the horizontal axis of a time plot in order to see the plot in greater detail. You may repeatedly zoom in on a plot down to the minimum resolution of 0.1 seconds/division.

Once you have zoomed in on the desired time period, you can view individual events that are of the type displayed in the timeplot.

This function is available for both the analog and digital time plots.

Note

Horizontal auto-scaling is disabled while the plot is in zoom mode and after exiting zoom.

How to Operate the Zoom Cursors

The cursors will initially be displayed on the left and right edges of the zoom window. Press and release the \rightarrow key to move the left cursor and the \leftarrow key to move the right cursor in increments.

Initially, both cursors will move inward. If one is moved so that it meets the other cursor, subsequent presses of the same cursor key will move it outward. The other cursor will still go in the same direction to follow the one that had reversed. When this cursor catches up to the initially reversed cursor, it will reverse direction, then both will move outwards normally.

Procedure

Follow these steps to operate the zoom function.

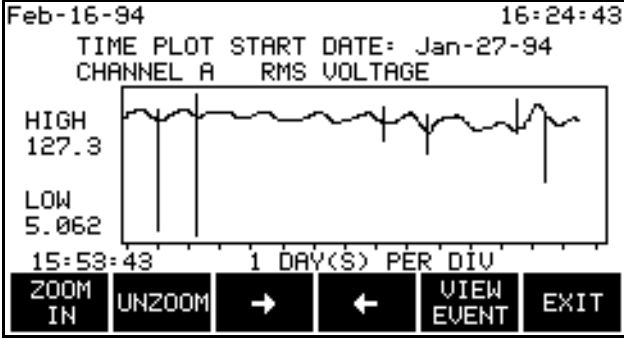
Step	Action
1	Press ZOOM IN. <div style="text-align: center; border: 1px solid black; padding: 5px; margin: 10px 0;">  </div>

Continued on next page

Using Horizontal Zoom, Continued

Procedure
(continued)

Step	Action
2	Select a time period using the zoom cursors.
3	Press ZOOM IN. Results: The portion of the plot between the zoom cursors will now fill the entire screen.
4	Repeat steps 2 to 3 for finer resolution.
5	Press VIEW EVENT to display the first event to the right of the left cursor. See page 10-21.
6	UNZOOM re-draws the plot to the previous level.
7	Select a time period using the zoom cursors.

Unzoom

You can use Unzoom to step backwards through each Zoom-in until you are at full-scale. Press EXIT to restore screen to auto-scaling.

Exiting

Pressing the EXIT key returns you to the previous screen. The zoom resolution is maintained and auto-scaling is disabled until UNZOOM is pressed or exiting the timeplot screen and returning.

Changing the Vertical Scale



Introduction

The Set Vertical Scale screen allows you to enter your own values for the high and low limits on the time plot. This stops the vertical axis of the plot from auto scaling. Vertical axis auto scaling will resume when another parameter is selected, or the time plot screen is exited.

The scale values that you set will be retained for plots of other channels of the same parameter.

Procedure

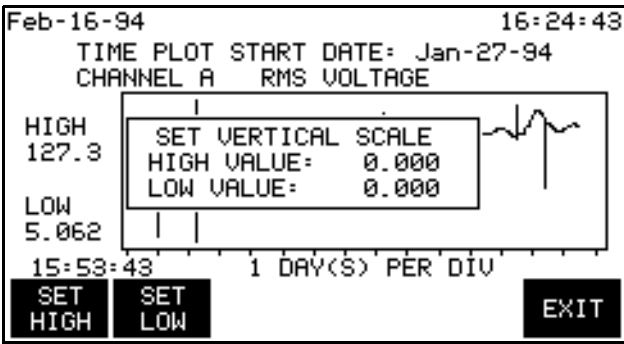
Follow these steps to change the vertical scale of an analog time plot.

Step	Action
1	<p>Press VERT SCALE</p>  <p>Note: To restore Auto-scale, set High Value and Low Value to 0.000, then press EXIT.</p>
2	<p>Press SET HIGH.</p> <p>The menu bar will change to the following.</p> 
3	Enter the high limit.
4	Press ENTER.
5	Press SET LOW.
6	Enter the low limit.
7	Press ENTER.
8	Press EXIT to accept the settings.

Continued on next page

Changing the Vertical Scale, Continued

Ranges

The ranges for the high and low values on the vertical scale are:

High: 0.1 to 10.0M but not lower than the low limit.

Low: 0.1 to 10.0M but not higher than the high limit.

Changing the Timed Interval Setting

Introduction The Interval For Timed Readings screen allows you to define how often data is recorded automatically.

Default 15 minutes.

Range 1 to 120 minutes.

What is saved? Each time interval, the unit saves the values for all parameters on all active channels. No waveform data is saved.

Displaying the screen Follow these steps to display the Interval For Timed Readings screen.

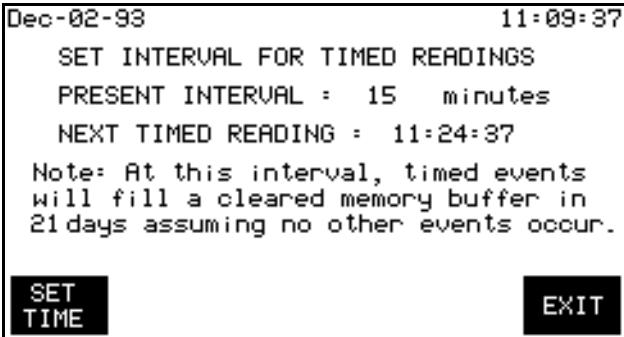
Step	Action
1	Select item #3, Setup Menu, from the Main Menu.
2	Select item #5, Set Interval For Timed Readings, from the Setup Menu. The following screen will appear. 

Continued on next page

Changing the Timed Interval Setting, Continued

Procedure Follow these steps to change the interval for timed readings.

Step	Action
1	<p>Press SET TIME.</p> <p>The menu bar will change to the following.</p> <div data-bbox="675 600 1297 667" style="text-align: center;"><p>The image shows a horizontal menu bar with six buttons. From left to right, the buttons are: 'ENTER', 'BACK SPACE', an empty button, another empty button, another empty button, and 'EXIT'. The buttons are arranged in a single row and are separated by thin vertical lines.</p></div>
2	Enter the number from the keypad.
3	Press ENTER.
4	Press EXIT to activate the new setting and return to the Setups Menu.

Viewing Digital Time Plots

Procedure Follow these steps to view the Digital Time Plot screen.

Step	Action
1	Select item #4, View Reports/Events, from the Main Menu.
2	Select item #2 Time Plots - Digital Inputs from the View Reports/Events Menu. The following screen will appear. <div data-bbox="673 680 1295 1018" data-label="Figure"> </div>
3	Press NEXT CHAN to view next channel of data.

Update rate Every ten seconds.

Horizontal axis Auto-scale to include all events in memory.

Zoom Operates the same as for analog time plots. Refer to page 9-5.

Chapter 10

Viewing Events

Overview

The event report Events stored in the internal memory are saved in a report file in chronological order of event happenings. This event report file is created during the time monitoring is turned on and ceases when monitoring is turned off or when the internal memory is full. The total report, and individual events, can be viewed by displaying the event report. All or part of the report can be printed. this normal method of event retrieval is discussed first in this chapter.

Memory cards Memory cards, of various capacities, are offered as optional accessories and are used in two ways to view events. The first method is to retrieve a snapshot of the event database in memory for event analysis. The second method is in an auto-transfer mode where events are transferred from a memory card that was used in an auto-transfer mode for an extended memory recording capability. These methods are discussed second and third in this chapter, respectively.

For information detailing with memory card formatting, and writing to a memory card for snapshot recording, are described in Chapter 11 beginning on page 11-30.

For information detailing writing to an extended memory card in an auto-transfer mode, refer to page 7-18.

Event reports Four types of normal event reports are available so that you can view events by number, date/time, channel, and type. In addition, the worst case types are also selectable. This allows you to view only the kinds of events you are interested in without having to look through the entire list.

When using the auto-transfer mode of extended memory operation, you can read events by time and date from the memory card for a period greater than that normally recorded on the internal memory.

Printing options Refer to page 1-10 for printing options if you have any questions about using the print functions in this chapter.

Overview, Continued

In this chapter This chapter is divided into three sections.

Section	Title	See Page
A	Viewing Event Reports from Internal Memory	10-3
B	Viewing Events Recorded on Memory Cards	10-25
C	Viewing Events Recorded in Auto-transfer Mode	10-28

Section A

Viewing Event Reports from Internal Memory

Overview

Recorded events Events are recorded on the internal memory and consist primarily of input voltage and current threshold monitoring when monitoring is turned on. Other events are monitored to provide a record of happenings that are related to hardware activities; such as clearing memory, turning power off and on, whenever a memory card is installed or removed, etc. Event descriptions begin on page 10-5.

Example event report A sample portion of an a selected event number report captured during input 3-phase monitoring is shown below. Each entry consists of the event number, the date and time the event occurred, and a brief description of the event.

EVENT REPORT			
EV.#	DATE	TIME	DESCRIPTION
0301	11-17-93	16:13:55.00	A WATTS NORMAL
0302	11-17-93	16:13:56.00	A WATTS LIMT
0303	11-17-93	16:13:57.00	A WATTS NORMAL
0304	11-17-93	16:13:58.00	B RMS SEN OUT
0305	11-17-93	16:13:58.00	C I TRANSIENT
0306	11-17-93	16:13:58.00	A WATTS LIMT

Event details Each event can be expanded to show detailed textual information about the event.

Event waveforms If an event has an associated waveform that was saved with it, this can be viewed and analyzed.

Continued on next page

Overview, Continued

In this section The following topics are covered in this section.

Topic	See Page
Event Descriptions	10-5
Viewing the Individual Event Reports	10-9
Viewing Worst Case Events	10-16
Viewing Event Waveforms	10-18
Viewing Waveform Data	10-20
Viewing Event Details	10-21
IEEE 1159 Classifications	10-22
Printing Event Reports	10-23

Event Descriptions

Threshold events

The following events occur when a parameter exceeds a specified limit. The Description column contains the name of the threshold that is affected.

Event Message	Description
V TRANSIENT	V TRANS exceeded
I TRANSIENT	I TRANS exceeded
PEAK CURRENT	I PEAK exceeded
V REP. TRANS I REP. TRANS	Generated when V TRANS or I TRANS has been exceeded for 10 successive cycles. Transient events will not be recorded again until a transient sensitivity event has occurred, or the impulse limit has not been exceeded for 10 cycles.
V REP OFF I REP OFF	Return to normal for repeat transient event.
V TRANS SENS I TRANS SENS	Transient sensitivity event while in repeat transient shutdown mode. A transient of 150% (or greater) of the worst transient recorded of the 10 successive transients was detected. This resets the repeat transient detection.
V RMS HIGH	V HI LIM exceeded
I RMS HIGH	I HI LIM exceeded
V RMS LOW	V LO LIM exceeded
I RMS LOW	I LO LIM exceeded
V RMS SEN IN	V SENS IN exceeded
I RMS SEN IN	I SENS IN exceeded
V RMS SEN OUT	V SENS OUT exceeded
I RMS SEN OUT	I SENS OUT exceeded
FREQ SENS	V FREQ exceeded <u>Note:</u> Frequency is averaged over 20 cycles.
PF LIMT	PF LO LIM exceeded
VA LIMT	VA HI LIM exceeded
VAR LIMT	VAR HI LIM exceeded
WATTS LIMT	WATTS LIM exceeded

Continued on next page

Event Descriptions, Continued

Threshold events (continued)

Event Message	Description
V Hn LIMT	#nTH V HARM% exceeded
I Hn LIMT	#nTH I HARM% exceeded
V THD LIMT	V THD% exceeded
I THD LIMT	I THD% exceeded

Return to normal events

The following events occur when a parameter value returns to normal.

- RMS NORMAL
 - PF NORMAL
 - VA NORMAL
 - VAR NORMAL
 - WATTS NORMAL
 - THD NORMAL
 - VHARM NORMAL
 - IHARM NORMAL
-

Device configured events

The following events occur when a device is configured.

- RS232 CONFIG
 - MOD/FX CONFIG
 - PRINT CONFIG
 - DIGIT CONFIG
 - RELAY CONFIG
-

Device status events

The following events occur when a devices' status has changed.

- RS232 STAT
 - MOD/FX STAT
 - PRINT STAT
 - DIGIT STAT
-

Continued on next page

Event Descriptions, Continued

Miscellaneous events

The following are miscellaneous events and their descriptions.

Event Message	Description
MONITOR OFF	Occurs under the following conditions: <ul style="list-style-type: none"> Monitoring turned off from Setups Menu Memory is full and set to Fill and Stop mode Easy start entered
MONITOR ON	Occurs under the following conditions: <ul style="list-style-type: none"> Monitoring turned on from Setups Menu Memory is cleared with monitoring turned on Easy start completed
POWER ON	Occurs after unit completes power-up diagnostics.
POWER OFF	Occurs when unit is turned off.
EVENT OVERWRITE	Occurs when memory Overwrites for the first time.
EVENT FULL	Occurs when memory fills and the unit is set to Fill and Stop.
SCOPE SNPSHT	Occurs when the SAVE key on scope mode is pressed.
POWER STAT	Occurs for events relating to the battery or the AC power.
ACP STAT	Occurs for events related to ACP conditions as follows: <ul style="list-style-type: none"> Self reset Board dead Configured D/A board dead Failure to start ACP Probe connect Probe disconnect
PP STAT	Occurs for peripheral processor self reset.
OVERANGE	Input exceeds safety rating.
OVERLOAD	Input saturates A/D converter.
SYNC LOST	Occurs when unit has lost sync.
SYNC ACQUIR	Occurs when the unit has acquired sync.
INT SYNC OFF	Occurs when internal sync is disabled.
INT SYNC ON	Occurs when internal sync is enabled.

Continued on next page

Event Descriptions, Continued

Miscellaneous events (continued)

Event Message	Description
LINE CONFG	Occurs when an entry in the analog inputs configuration screen has changed, or in easy start.
RELAY CONTRL	Occurs when a relay operate command has been issued.
MON RESTORED	Occurs when monitoring is restored after being shut down by the system.
TIMED EVENT	Timeplot point set.
THRESH CONFG	Occurs when threshold value is changed or percent tolerance is changed.
DIG WAVE CAPT	Occurs when digital input #3 or #4 has transition from low to high.
DIG START	Occurs when digital input #1 has transition from low to high.
DIG STOP	Occurs when digital input #2 has transition from high to low.

Viewing the Individual Event Reports

Introduction

Each of four individual type event reports is selectable from the View Events Menu. These reports are referenced to the event number, date and time, channel and type. The viewing of events from a memory card are described in Sections B and C.

Displaying the View Events menu

Follow these steps to display the View Events Menu screen.

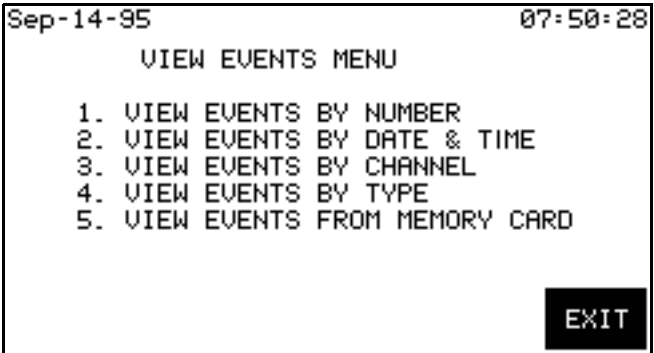
Step	Action
1	Select item #4, View Reports/Events, from the main menu.
2	Select item #3, View Events, from the View Reports/Events menu. The following screen will appear. 



Individual selection of the first four events are described in the following paragraphs.

Continued on next page

Viewing the Individual Event Report, Continued

Selecting events by number

To select the event by number proceed as follows:

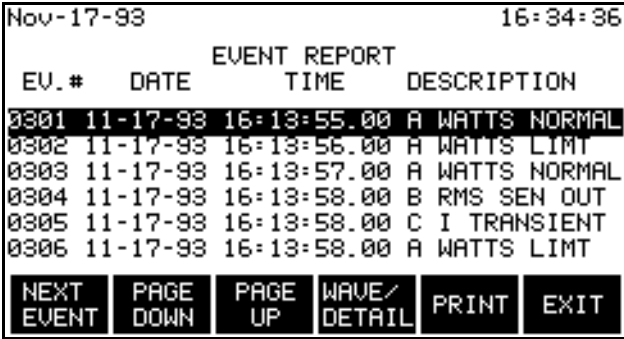
1	<p>Select item #1, View by Number, from the View Events menu.</p> <p>The following screen will appear.</p>  <p>Note: The default event number will be the last event in memory or the last number entered.</p> <p>If you want to view the default, go to step 7, else, go to step 4.</p>
2	<p>Press EVENT #.</p> <p>The menu bar will change to the following.</p> 
3	<p>Enter the desired event number.</p>
4	<p>Press ENTER.</p>
5	<p>Press VIEW EVENTS.</p> <p>The following screen will appear.</p> 

Viewing the Individual Event Report, Continued

Function keys The following table provides a description of the functions keys for the Event Report screen.

Key	Function
NEXT EVENT	Steps through events shown on screen.
PAGE UP	Displays the previous screen of events.
PAGE DOWN	Displays the next screen of events.
WAVE/DETAIL	Displays additional information about the highlighted event. If waveform information was saved with the event, the Event Waveform screen will appear, see page 10-18. If there is no waveform information, the Event Details screen will appear, see page 10-21.
PRINT	Displays the Print Event Reports screen. See page 10-23.

Viewing the Individual Event Report, Continued

Viewing Events by Date and Time

Follow these steps to display the view events by Date and Time.

Step	Action
1	<p>Select item #2, View Events by Date and Time, from the View Events Menu.</p> <p>The following screen will appear.</p> 

Procedure

Follow these steps to enter the starting date and time for the Event Report.

Step	Action
1	<p>Press SELECT DATE.</p> <p>The menu bar will change to the following.</p> 
2	Enter the desired starting date.
3	Press ENTER.
4	Press SELECT TIME.

Continued on next page

Viewing the Individual Event Report, Continued

Procedure
(continued)

Step	Action
5	Enter the desired starting time.
6	Press ENTER.
7	Press VIEW EVENTS. <u>Result:</u> The Event Report will be displayed, starting with the first event after the specified date and time. See page 10-9 for information about viewing the Event Report.

Viewing the Individual Event Report, Continued

Viewing Events by Channel Follow these steps to display the Channel Selection screen.

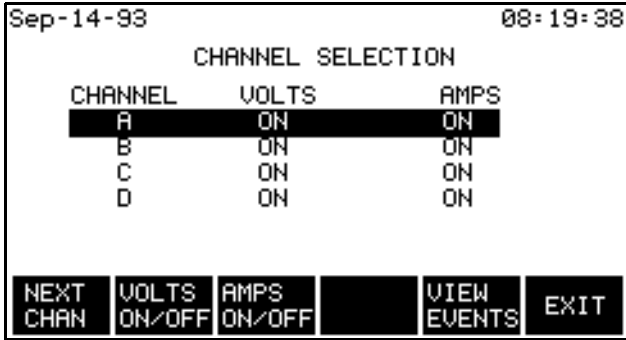
Step	Action
1	<p>Select item #3, View Events by Channel, from the View Events Menu.</p> <p>The following screen will appear.</p> 

Procedure Follow these steps to select the channels for the event report.

Step	Action
1	Press VOLTS ON/OFF to toggle the voltage channel on and off.
2	Press AMPS ON/OFF to toggle the current channel on and off.
3	Press NEXT CHAN.
4	Repeat steps 1 to 3 for each channel.
5	<p>Press VIEW EVENTS.</p> <p>Result: The Event Report will be displayed, listing events for the specified channel(s). See page 10-9 for information about viewing the Event Report.</p>

Viewing the Individual Event Report, Continued

Viewing Events by Type These event reports will include sags, swells, outages, and long term out-of-limits conditions.

Displaying the screen Follow these steps to display the Select Events by Type screen.

Step	Action
1	<p>Select item #4, View Events by Type, from the View Events Menu.</p> <p>The following screen will appear.</p> <div data-bbox="675 772 1295 1108" style="border: 1px solid black; padding: 5px; margin: 10px auto; width: fit-content;"><pre>Sep-14-93 08:21:52 SELECT EVENTS BY TYPE 1. VOLTAGE TRANSIENTS 2. CURRENT TRANSIENTS 3. UNDER/OVERVOLTAGES 4. UNDER/OVERCURRENTS 5. VOLTAGE HARMONICS 6. CURRENT HARMONICS 7. FREQUENCY 8. WATTS 9. POWER FACTOR EXIT</pre></div>

Procedure Select the number of the desired event type.

Result: The Event Report will be displayed, listing events for the specified type. See page 10-9 for information about viewing the Event Report.

Viewing Worst Case Events

Introduction

The Worst Case Events screen displays the four worst values recorded for the parameters listed below while they were out of limits.

- Voltage Transient
- Current Transient
- Under/Over Voltages
- Under/Over Currents
- Voltage Harmonics
- Current Harmonics
- Frequency
- Watts
- Power Factor

Displaying the screen

Follow these steps to view the Worst Case Events screen.

Step	Action
1	Select item #4, View Reports/Events, from the Main Menu.
2	<p>Select item #4, Worst Case Events, from the View Reports/Events Menu.</p> <p>The following screen will appear.</p> <div style="border: 1px solid black; padding: 5px; margin: 10px auto; width: fit-content;"> <pre> Sep-14-93 08:35:01 <u>VOLTAGE TRANSIENTS</u> <u>EV.#</u> <u>DATE</u> <u>TIME</u> <u>CHAN.</u> <u>VALUE</u> 003 01-04-93 10:27:35 C 199 UPK 012 03-07-93 07:14:15 B 135 UPK 015 03-26-93 14:27:35 A 245 UPK 002 12-31-92 07:14:15 D 117 UPK NEXT NEXT DETAIL PRINT PRINT EXIT EVENT TYPE ALL SCREEN </pre> </div>

Continued on next page

Viewing Worst Case Events, Continued

Function keys The following table provides a description of the functions keys for the Worst Case Events screen.

Key	Function
NEXT EVENT	Moves the highlight.
NEXT TYPE	Displays the worst case events for the next parameter type according to the list on the previous page. Note: If there are no events for a given parameter, the message “No Worst Case Events” is displayed.
DETAIL	Displays details of the highlighted event. See page 10-21 for a description of the Event Details screen.
PRINT ALL	Prints the entire Worst Case Events report. Event details and waveforms (if available) are printed also.
PRINT SCREEN	Prints only the screen you are viewing.

Viewing Event Waveforms

What is displayed?

The Event Waveform screen displays the waveforms for events that are stored in memory.

Waveform analysis

Detailed analysis of each waveform can be performed with the four functions on the Event Waveform Data screen: an all channels, all parameters report; scope mode display; voltage and current harmonics report; and voltage and current phasor display.

3-cycle waveform

Definition: A 3-cycle waveform consists of the cycle the event occurred in plus one cycle before and one cycle after. The three cycles are designated as pre-fault, fault, and post-fault.

Parameters: The following parameters will be displayed as three cycle waveforms: Vrms, Vtransient, Irms, Itransient, Freq, Ipeak, Vsens, and Isens.

Example:

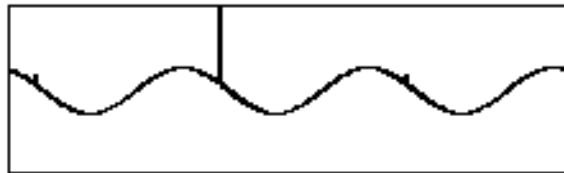

1-cycle waveform

Definition: The voltage or current waveform cycle that is displayed is a composite of the previous second's worth of data.

Parameters: The waveforms for the following parameters will be displayed as composites: Watts, VA, VAR, PF, Vthd, Ithd, Vharm#, Iharm#, Vunbalance, K-factor.

Example:

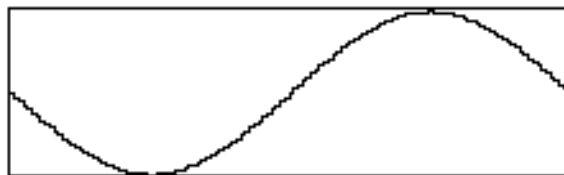

Continued on next page

Viewing Event Waveforms, Continued

Screen

The Event waveform screen is shown below. A composite waveform is displayed

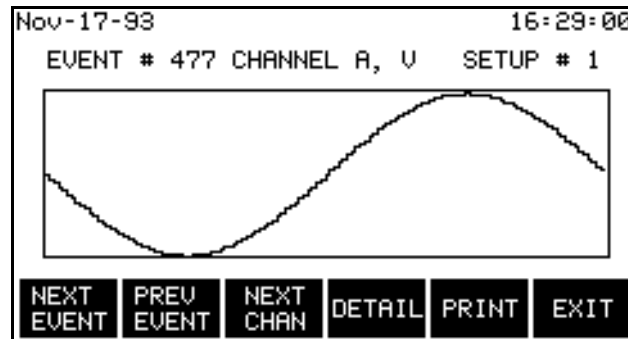

Function keys

The following table provides a description of the functions keys for the Event Waveform screen.

Key	Function
NEXT EVENT	Displays the next waveform event in memory, subject to the following conditions: <ul style="list-style-type: none">• If you entered this screen by way of the View Events by Channel screen, then only events for the chosen channel(s) will be displayed.• If you entered this screen by way of the View Events by Type screen, then only events of the chosen type will be shown.
PREV EVENT	Displays the previous event in memory, subject to the two conditions above.
NEXT CHAN	Displays the next channel's waveform. If no other waveforms are available, the unit will beep.
DETAIL	Displays the Event Details screen. See page 10-21.
PRINT	Prints screen plus Event Details screen.

Viewing Waveform Data

Reference screen Event Waveform screen.

Procedure Follow these steps to view waveform data.

Step	Action
1	Press DETAIL .
2	<p>Press DATA.</p> <p>The following screen is displayed.</p> <div data-bbox="669 743 1291 1079" data-label="Image"><pre>Nov-17-93 17:11:44 EVENT WAVEFORM DATA CYCLE TO ANALYZE : FAULT CYCLE 1. SCOPE MODE 2. HARMONICS - U, I & W 3. ALL CHANNELS, ALL PARAMETERS 4. VOLTAGE & CURRENT PHASORS SELECT PRE SELECT FAULT SELECT POST EXIT</pre></div>
3	Press the key corresponding to the cycle to be analyzed.
4	Select one of the numbered items.

Note 1: The three **SELECT** keys are available for 3-cycle waveforms only.

Note 2: Items 3 and 4 are available if waveforms were saved for all channels. See page 6-12 for information about setting waveform capture.

Viewing Event Details

Screen The event details screen is shown below.

```
Nov-17-93 16:38:35
EVENT DETAILS FOR EVENT # 326
EVENT TIME: 11-17-93 16:14:18.00
EVENT TYPE: CH A V RMS TIMEOUT
THRESHOLD CROSSED: 0.00 V
CATEGORY: MOMENTARY SWELL
OUT OF LIMIT MAX/MIN: 120.00 V
DURATION OUT OF LIMITS: 0.167 SEC.
NEXT  PREV  DATA  PRINT  EXIT
EVENT EVENT
```

Function keys The following table provides a description of the functions keys for the Event Details screen.

Key	Function
NEXT EVENT	Displays the details of the next event in memory, subject to the following conditions: <ul style="list-style-type: none">• If you entered this screen by way of the View Events by Channel screen, then only events for the chosen channels will be displayed.• If you entered this screen by way of the View Events by Type screen, then only events of the chosen type will be shown.
PREV EVENT	Displays the details of the previous event in memory, subject to the two conditions above.
DATA	Displays the Event Waveform Data screen. <u>Note:</u> This key appears if there is a waveform associated with the event.
PRINT	Prints screen plus Event Waveform screen if available.

Note The category is shown for voltage rms return to normal events only and is based on specification IEEE 1159 for voltage disturbances. See table on next page.

IEEE 1159 Classifications

Table

The table below lists the IEEE 1159 classifications that the PP1-PQPlus will display for voltage variations.

Category	Typical Duration	Typical Magnitudes
Short Duration Variations <ul style="list-style-type: none"> • Instantaneous <ul style="list-style-type: none"> • Interruption • Sag • Swell • Momentary <ul style="list-style-type: none"> • Interruption • Sag • Swell • Temporary <ul style="list-style-type: none"> • Interruption • Sag • Swell 	1 - 30 cycles 1 - 30 cycles 1 - 30 cycles 30 cycles - 3 sec 30 cycles - 3 sec 30 cycles - 3 sec 3 sec - 1 min 3 sec - 1 min 3 sec - 1 min	< 10% of Vnominal < V low limit > V high limit < 10% of Vnominal < V low limit > V high limit < 10% of Vnominal < V low limit > V high limit
Long Duration Variations <ul style="list-style-type: none"> • Interruption • Overvoltages • Undervoltages 	>1 min >1 min >1 min	< 10% of Vnominal > V high limit < V low limit
$V_{nominal} = \frac{V_{highlimit} + V_{lowlimit}}{2}$		

Note

Short duration variations will not be saved as events themselves, but will be recorded and categorized in the return to normal event for the associated channel. Long duration events will cause a TIMEOUT event for the channel that went out of limits.

Printing Event Reports

Reference screen The Print Event Reports screen is accessed from the Event Report screen. See page 10-9 for more information.

Displaying the screen From the Event Report screen, press PRINT.



What this screen does The Print Event Report screen will print the events for the report that you were last viewing or all events in memory.

Example: If you are viewing an event report that contains events from channel C only, then channel C events will be printed from this screen.

See Section B (page 10-25) for information about viewing specialized event reports.

Note The numbers on the screen default to the first and last events in memory of the type chosen.

Example: If you are viewing an event report that contains events from channel C only, then the first and last events to print will default to the first and last channel C events in memory.

To print the entire report To print the entire event report press ALL EVENTS, then press PRINT.

Continued on next page

Printing Event Reports, Continued

To print part of the event report Follow these steps to print a part of the event report.

Step	Action
1	Press ENTER FIRST. The menu bar changes to the following. 
2	Enter the first event number.
3	Press ENTER.
4	Press ENTER LAST.
5	Enter the last event number.
6	Press ENTER.
7	Press PRINT.

Section B

Viewing Events Recorded on Memory Cards

Overview

Introduction This section describes the reading of event data from a memory card into internal memory for subsequent viewing. Contents of a memory card can only be read if the contents are reloaded back into internal memory. In the read operation, described here, the snapshot of data is reloaded back into memory. Refer to page 11-31 for the write operation.

The amount of information that can be reloaded into the internal memory (RAM) cannot exceed 715kbytes. Error messages will provide indications of excess data on memory cards. A memory card capacity of 512kbytes is sufficient to write to and read from memory, but may not provide the full complement of memory that you require. A 1Mbyte or larger capacity memory card is recommended for snapshot loading of full memory.

Fill and Stop or Overwrite selection of memory storage does not affect the quantity of information stored, but rather the time period of data stored. In the Overwrite mode data collection start time will continuously be updated every time a Overwrite condition occurs. This condition may be monitored in the Site Status screen.

Larger amounts of data can be saved on a memory card in the auto-transfer mode, (described in Section C) but no more than 715kbytes can be read into memory at any one time.

CAUTION Events presently in memory will be deleted when events from the card are copied into memory.

PRECAUCIÓN Los eventos que están actualmente en la memoria se borrarán cuando se hayan copiado en la memoria los eventos de la tarjeta.

MISE EN GARDE Les événements actuellement en mémoire seront effacés lorsque les événements de la carte seront copiés dans la mémoire.

VORSICHT Die sich derzeit im Speicher befindlichen Vorgänge werden gelöscht, wenn Vorgänge von der Karte in den Speicher kopiert werden.

Overview, Continued

Procedure Follow these steps to load contents of a memory card into the internal memory.

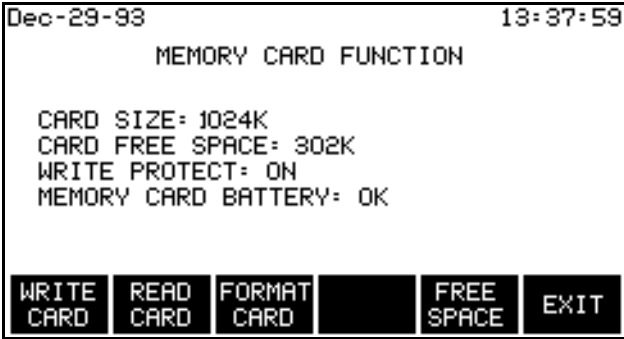
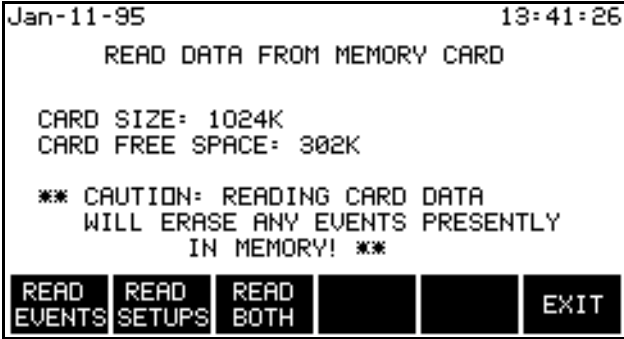
Step	Action
1	Select item #3. Setup Menu, from the Main Menu.
2	Select item #7, Memory Functions, from the Setup Menu.
3	Select item #1, Memory Card Functions, from the Memory Functions Menu.
4	<p>The following screen will appear without values for the card parameters. If a 1M card was used to copy a 100% full memory in Fill and Stop mode, the following screen with values shown will appear when inserted. Insertion of any other size card will change to its respective card and space values</p> 
5	<p>Press READ CARD. The following display will appear:</p> 

Overview, Continued

Procedure, continued

Step	Action
6	Press READ EVENTS. The following message is displayed: "Reading in data from the memory card. Please wait." The DATA CARD yellow indicator below the memory card will remain lit during data transfer. Monitoring of data will be stopped automatically and the Monitoring Off message will appear at the top of the screen.
7	When data transfer has finished, the wait message disappears and the DATA CARD indicator goes out. Press EXIT to return to Main Menu.
8	From Main Menu select items 4, then 3 to display the View Events Menu. Select the item 1 through 4 for the event information you require. Refer to page 10-9 for details. Note: Item 5. View Events from the Memory Card, is selected when the memory card is to be used in auto-transfer only. Refer to Section C for this selection.

Section C

Viewing Events Recorded in Auto-transfer Mode

Introduction

This section describes the method for viewing the events recorded in the Auto-Transfer Mode. This mode of operation uses the larger capacity of an external memory card of 1Mbytes or larger to record events for a longer period than that permitted by the internal memory (RAM) of 715kbytes. By using the Overwrite feature, normally applied to the internal memory, the auto-transfer mode can record approximately 30% more events on a 1 Mbytes memory card and 130% on a 2Mbytes memory card.

During the operation of the auto-transfer mode the events being monitored are automatically transferred to the external memory card and the DATA CARD indicator provides a visual indication each time an event is being recorded.

Once sufficient events are accumulated, the memory card is read into internal memory for viewing. Viewing selection is accomplished similar to the normal viewing of events from internal memory, except that there will be a larger storage capacity of events than the internal memory can hold. Selection of events from the memory card is limited to 715k blocks of data at any one time. Multiple transfers are required to view all the events stored on a memory card.

Enabling of auto-transfer

Refer to page 7-18 for information on recording events in auto-transfer to an external memory card. For reading of events from the memory card the auto-transfer option is set to Update Continuously.

Continued on next page

Viewing Events Recorded in Auto-transfer Mode, Continued

Auto-transfer file The auto-transfer file must be larger than internal memory. Because of this you will have to read the file two or more times if you want to view all of the data. A screen will appear allowing you to enter the date and time of the first event that you want to view.

Note In order for the PP1 to read the auto-transfer file, the site name must match the filename on the memory card.

Preliminary Before attempting to view events from the memory card file perform the following procedure.

Step	Action
1	Turn monitoring off.
2	Clear internal memory.
3	Insert memory card to be read into the Data Card slot. Select the Memory Card Function screen and verify that the card has been formatted for auto-transfer use. This can be done by noting the card size and space as follows: <ul style="list-style-type: none">• 1024k memory card, Size: 1024k, Free Space: 24k• 2048k memory card, Size: 2048k, Free Space: 48k. A memory card not formatted for auto-transfer cannot be accessed in this mode.
4	Verify that the auto-transfer mode is set to Update Continuously.

Continued on next page

Viewing Events Recorded in Auto-transfer Mode, Continued

CAUTION Events presently in memory will be deleted when events from the card are copied into memory.

PRECAUCIÓN Los eventos que están actualmente en la memoria se borrarán cuando se hayan copiado en la memoria los eventos de la tarjeta.

MISE EN GARDE Les événements actuellement en mémoire seront effacés lorsque les événements de la carte seront copiés dans la mémoire.

VORSICHT Die sich derzeit im Speicher befindlichen Vorgänge werden gelöscht, wenn Vorgänge von der Karte in den Speicher kopiert werden.

Displaying the screen Follow these steps to display the View Events From Memory Card screen.

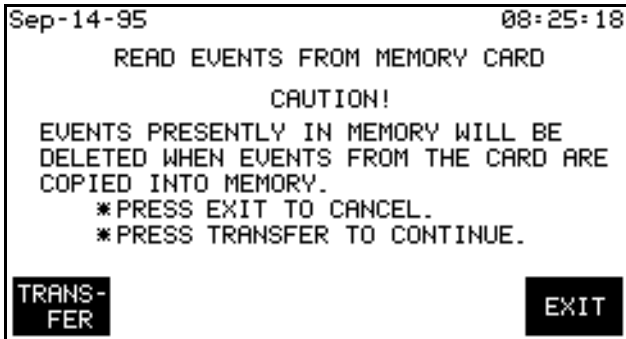
Step	Action
1	From the Main Menu, select item 4, View Reports/ Events.
2	From the View Reports/ Events Menu, select item 3, View Events.
3	From the View Events Menu, select item 5, Read Events From Memory Card. <u>Result:</u> The following screen will appear. 

Continued on next page

Viewing Events Recorded in Auto-transfer Mode, Continued

Procedure

Follow these steps to read the auto-transfer file on a memory card.

1	<p>Press TRANSFER. Monitoring will be turned off automatically. The DATA CARD indicator will light indicating data transfer. When the light goes out, the following screen will appear.</p> <div data-bbox="673 541 1295 877" style="border: 1px solid black; padding: 5px; margin: 10px auto; width: fit-content;"> <pre> Sep-14-95 08:17:06 STARTING DATE AND TIME STARTING DATE (mmm-dd-yy): Sep-14-93 STARTING TIME (hh:mm:ss.ms): 09:20:04.00 ENTER DATE ENTER TIME READ EVENTS EXIT </pre> </div> <p>Note 1: If an error message is displayed, refer to the table on the next page.</p> <p>Note 2: The default time and date will be for the first event in the file.</p>
2	<p>Are the date and time correct?</p> <p>If yes, go to step 5. If no, go to next step.</p>
3	<p>Press SELECT DATE.</p> <p>The menu bar will change to the following.</p> <div data-bbox="673 1476 1295 1545" style="border: 1px solid black; padding: 5px; margin: 10px auto; width: fit-content;"> <pre> ENTER BACK SPACE [] [] [] EXIT </pre> </div>
4	<p>Enter the desired starting date, pressing ENTER after each portion of the date.</p>

Continued on next page

Viewing Events Recorded in Auto-transfer Mode, Continued

Procedure (continued)

Step	Action
5	Press SELECT TIME.
6	Enter the desired starting time, pressing ENTER after each portion of the time.
7	Press READ EVENTS. <u>Note:</u> If the card had more data than can fit in memory, as much as possible will be copied. After you have viewed the initial batch of data, note the date and time of the last event and enter these values into the starting date and time screen to read the rest of the data.

Error messages The following error messages may be displayed when the TRANSFER key is pressed.

Error Message	Description
RAM CARD NOT FOUND! NO DATA TRANSFERRED	No memory card inserted, inserted improperly, or card not formatted for auto-transfer.
DATA FILE CORRUPTED! NO DATA TRANSFERRED.	The PP1 started to read a memory card file but detected an error in the data.
EMPTY MEMORY CARD DATABASE! NO DATA TRANSFERRED.	A valid database has been saved to the memory card but no events exist.
WRONG DATABASE VERSION! NO DATA TRANSFERRED.	The PP1 cannot read the database version on the memory card.
FILE NOT FOUND! NO DATA TRANSFERRED.	No file with the correct name on the memory card. The present site name must match the filename on the memory card. Memory card files use the first 8 characters of the site name. To change site name, see page 7-2.

Chapter 11

Transferring Data

Overview

Introduction The PP1-PQPlus transfers reports and error messages automatically (when configured) to the peripheral devices such as an external terminal, personal computer (PC), printer, or facsimile (Fax) machine. Transferring data also consists of writing data to a memory card.

Types of communication Data can be transferred by serial or parallel data transmission. Serial data transfer is accomplished through an RS-232D direct connection or through internal or external modems. Parallel data transmission is available through a parallel data port and is used only for a local external parallel printer.

Device connection description The table below shows the devices and their related connection description.

Device	Location	Port	Data	Connection
Terminal, PC, Printer	Local	RS232D	Serial	Direct
Terminal, PC, Printer	Remote	RS232D	Serial	External Modem
Printer only	Local	Parallel Port	Parallel	Direct
Terminal, PC, Printer	Remote	RJ-11C*	Serial	Internal Modem
Facsimile (Fax)	Remote	RJ-11C*	Serial	Internal Modem

* An RJ-11C jack is not available on the model PP1E.

CAUTION This equipment has been tested and found to comply with emissions and/or immunity requirements. Shielded cables and shielded connectors must be used when connecting external devices to the main or auxiliary ports. Only certified Class A or B peripherals, applicable to the national regulations of the user, are recommended for use with this equipment. The use of non-certified peripherals is likely to result in undesired interference.

Continued on next page

Overview, Continued

PRECAUCIÓN Este equipo ha sido probado y se ha encontrado en conformidad con los requisitos de emisiones y/o inmunidad. Deben utilizarse cables blindados y conectores blindados cuando se conecten dispositivos externos a los puertos principal o auxiliar. Con este equipo, se recomienda utilizar sólo periféricos certificados de Clase A o B, aplicables a las regulaciones nacionales del usuario. Es probable que el uso de periféricos sin certificación produzca una interferencia indeseable.

MISE EN GARDE Ce matériel a été testé et déterminé conforme aux règlements relatifs à la pollution de l'air et/ou à l'immunité. Des câbles et des connecteurs blindés doivent être utilisés lors de la connexion de dispositifs extérieurs au port principal ou aux ports auxiliaires. Seuls des périphériques homologués Classe A ou Classe B, applicables dans le cadre des règlements nationaux de l'utilisateur, sont recommandés pour être utilisés avec ce matériel. L'utilisation de périphériques non homologués produira vraisemblablement des parasites.

VORSICHT Dieses Gerät wurde getestet und entspricht Emissions- bzw. Störfestigkeitsanforderungen. Bei der Verbindung externer Geräte mit den Haupt- bzw. Zusatzanschlüssen müssen abgeschirmte Kabel und Stecker verwendet werden. Für die Verwendung mit diesem Gerät werden nur genehmigte Peripheriegeräte der Klasse A oder B, die den Vorschriften im jeweiligen Land des Benutzers entsprechen, empfohlen. Die Verwendung nicht genehmigter Peripheriegeräte führt voraussichtlich zu unerwünschten Störungen.

In this chapter This chapter describes how each device is configured, connected, then verified to ensure correct operation. The following topics are covered in this chapter.

Topic	See Page
Connecting Local Devices to the RS232D Port	11-4
Connecting a Printer to the Parallel Port	11-10
Connecting Remote Devices to RS232D Port	11-14
Connecting Remote Devices to RJ-11C Jack (not available on PP1E)	11-20

Continued on next page

Overview, Continued

In this chapter
(continued)

Topic	See Page
Connecting to a Facsimile (Fax) Machine (not available on PP1E)	11-25
Output Connected Device Configuration Test	11-28
Formatting a Memory Card	11-30
Writing to a Memory Card	11-31

Connecting Local Devices to the RS232D Port

Introduction

A terminal, PC, or serial printer may be connected through an accessory cable to the RS232D port as a direct connection for local operation. Once connected, the device is configured for operation by selection of options from the menu.

RS232D port description

The RS232D serial port is located on the rear panel of the Power Platform and consists of a 25-pin female connector and operates as a Data Communications Equipment (DCE) port. It provides data output of 300 to 9600 baud and parity control. This port permits the PP1-PQPlus to communicate with a terminal, PC, or printer for up to 50 feet.

Port pinout description

The following table describes the RS-232D port pinouts.

Pin and Name	Function	Data Direction	Description of Operation
1. GND	Protective ground	Not Applicable	Shielding of cable (Drain) is tied to this pin.
2. XMT	Transmit	To PP1	Serial data output from connected device. RTS and DTR must be TRUE for data to be recognized.
3. RCV	Receive	From PP1	Serial data output to connected device. RTS and DTR must be TRUE for data to be recognized
4. RTS *	Request To Send	To PP1	Controls data flow from PP1. Must be TRUE for PP1 to transmit data.
6. DSR	Data Set Ready	From PP1	Same as RTS.
7. GND	Signal Ground	Not Applicable	Signal ground for input/output data.
11. DCD	Carrier Detect	From External Modem	Used only with external modem interface cable.
20. DTR *	Data Terminal	To PP1	Must be TRUE for PP1 to acknowledge presence of connected device. A FALSE state causes immediate disabling of the port.

*If either RTS or DTR are de-asserted for more than two seconds, the PP1 will consider the line dead and disable the port.

Continued on next page

Connecting Local Devices to the RS232D Port, Continued

Cables required The following cables are provided as optional accessories.

Type	Part Number	Description
Direct, Shielded	113376-G1	RS232 Cable, 25-pin male to 25-pin female, 10 feet. D-sub connectors.
Adapter, Shielded	113394-G1	RS232 Cable, Adapter, 25-pin male to 9-pin female, 1 foot. D-sub connectors.

See figures for the shielded cable wiring.

CAUTION This equipment has been tested and found to comply with emissions and/or immunity requirements. Shielded cables and shielded connectors must be used when connecting external devices to the main or auxiliary ports. Only certified Class A or B peripherals, applicable to the national regulations of the user, are recommended for use with this equipment. The use of non-certified peripherals is likely to result in undesired interference.

PRECAUCIÓN Este equipo ha sido probado y se ha encontrado en conformidad con los requisitos de emisiones y/o inmunidad. Deben utilizarse cables blindados y conectores blindados cuando se conecten dispositivos externos a los puertos principal o auxiliar. Con este equipo, se recomienda utilizar sólo periféricos certificados de Clase A o B, aplicables a las regulaciones nacionales del usuario. Es probable que el uso de periféricos sin certificación produzca una interferencia indeseable.

MISE EN GARDE Ce matériel a été testé et déterminé conforme aux règlements relatifs à la pollution de l'air et/ou à l'immunité. Des câbles et des connecteurs blindés doivent être utilisés lors de la connexion de dispositifs extérieurs au port principal ou aux ports auxiliaires. Seuls des périphériques homologués Classe A ou Classe B, applicables dans le cadre des règlements nationaux de l'utilisateur, sont recommandés pour être utilisés avec ce matériel. L'utilisation de périphériques non homologués produira vraisemblablement des parasites.

Continued on next page

Connecting Local Devices to the RS232D Port, Continued

VORSICHT

Dieses Gerät wurde getestet und entspricht Emissions- bzw. Störfestigkeitsanforderungen. Bei der Verbindung externer Geräte mit den Haupt- bzw. Zusatzanschlüssen müssen abgeschirmte Kabel und Stecker verwendet werden. Für die Verwendung mit diesem Gerät werden nur genehmigte Peripheriegeräte der Klasse A oder B, die den Vorschriften im jeweiligen Land des Benutzers entsprechen, empfohlen. Die Verwendung nicht genehmigter Peripheriegeräte führt voraussichtlich zu unerwünschten Störungen.

Direct cable diagram

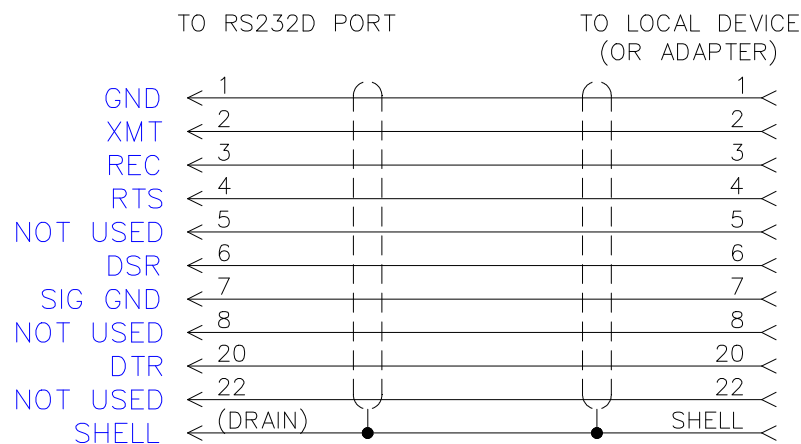

Adapter cable diagram

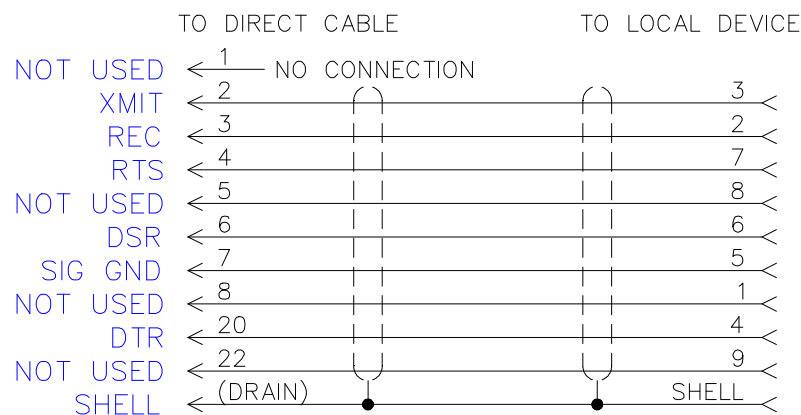

8600-42

Connecting Local Devices to the RS232D Port, Continued

Direct connections to RS232D port

The direct connections of a device connected to the RS232D port are shown below. Only one device can be connected to the RS232D port at any time using the direct connector cable, 113376-G1. Connection to a terminal or PC having a 9-pin connector port will require the use of the adapter cable, 113394-G1.

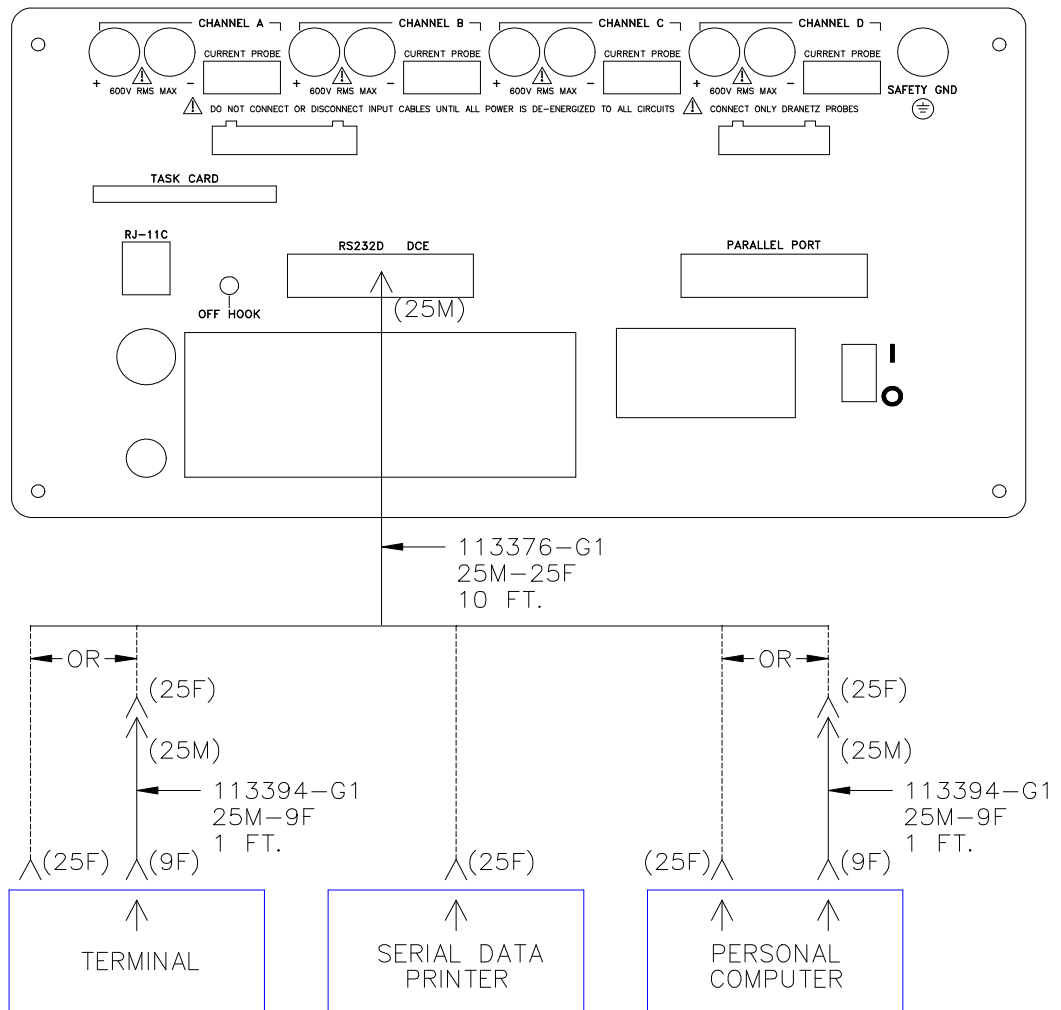

8600-2

Continued on next page

Connecting Local Devices to the RS232D Port, Continued

Displaying the screen

Follow these steps to display the RS232D Configuration screen.

Step	Action
1	Select item 3, Setup Menu, from the Main Menu.
2	Select item 8, I/O Devices from the Setup Menu.
3	Select item 2, RS232, from the Setup Menu. <u>Result:</u> The following screen appears.

```

Aug-25-93                               15:29:03
                                RS232D CONFIGURATION
BAUD RATE: 9600
PARITY TYPE NONE
# STOP BITS: 1
FLOW CONTROL: SOFTWARE (XON/XOFF)
DEVICE: TERMINAL

SET  SET  FLOW  SET
BAUD PARITY CONTRL DEVICE MORE EXIT
    
```

Direct connection configuration

To configure the PP1-PQPlus for the operation of a Terminal, Printer, or PC directly connected to the RS232D port, perform the following steps.

Step	Action
1	Press SET DEVICE to select the device to be used: Terminal (or PC), Modem, Printer=Okidata, or Printer=Epson. <u>Note:</u> Modem cannot be used for direct connection operation.
2	Press SET BAUD until the desired baud of 300, 1200, 2400, 4800, or 9600 is displayed.

Continued on next page

Connecting Local Devices to the RS232D Port, Continued

Direct connection configuration (continued)

Step	Action
3	Press SET PARITY and select Odd, Even, or None. <u>Note:</u> The # Stop Bits = 1 is preset and not alterable.
4	Press EXIT to activate the configuration.

Configuration test

To test that the configuration and connections are correct, perform the configuration test on page 11-28.

Connecting a Printer to the Parallel Port

Introduction An Epson model FX80, parallel data printer, (or another printer that can emulate an Epson FX80) can be connected to the parallel port on the rear of the Power Platform and configured for printer operation.

Note Connection of an external printer will disable the internal thermal printer.

Cable required A Centronics parallel data cable, not supplied, consisting of a 25-pin male to 36-pin male connectors is required.

CAUTION **This equipment has been tested and found to comply with emissions and/or immunity requirements. Shielded cables and shielded connectors must be used when connecting external devices to the main or auxiliary ports. Only certified Class A or B peripherals, applicable to the national regulations of the user, are recommended for use with this equipment. The use of non-certified peripherals is likely to result in undesired interference.**

PRECAUCIÓN **Este equipo ha sido probado y se ha encontrado en conformidad con los requisitos de emisiones y/o inmunidad. Deben utilizarse cables blindados y conectores blindados cuando se conecten dispositivos externos a los puertos principal o auxiliar. Con este equipo, se recomienda utilizar sólo periféricos certificados de Clase A o B, aplicables a las regulaciones nacionales del usuario. Es probable que el uso de periféricos sin certificación produzca una interferencia indeseable.**

MISE EN GARDE **Ce matériel a été testé et déterminé conforme aux règlements relatifs à la pollution de l'air et/ou à l'immunité. Des câbles et des connecteurs blindés doivent être utilisés lors de la connexion de dispositifs extérieurs au port principal ou aux ports auxiliaires. Seuls des périphériques homologués Classe A ou Classe B, applicables dans le cadre des règlements nationaux de l'utilisateur, sont recommandés pour être utilisés avec ce matériel. L'utilisation de périphériques non homologués produira vraisemblablement des parasites.**

Continued on next page

Connecting a Printer to the Parallel Port, Continued

VORSICHT

Dieses Gerät wurde getestet und entspricht Emissions- bzw. Störfestigkeitsanforderungen. Bei der Verbindung externer Geräte mit den Haupt- bzw. Zusatzanschlüssen müssen abgeschirmte Kabel und Stecker verwendet werden. Für die Verwendung mit diesem Gerät werden nur genehmigte Peripheriegeräte der Klasse A oder B, die den Vorschriften im jeweiligen Land des Benutzers entsprechen, empfohlen. Die Verwendung nicht genehmigter Peripheriegeräte führt voraussichtlich zu unerwünschten Störungen.

Port pinout description

The following table describes the parallel port pinouts.

Pin and Name	Function	Data Direction	Description of Operation
1. STROBE [~]	General Purpose	Output	Transfer latched data to printer.
2 - 9. D01 -D07	Data	Output	8-bit Parallel Data.
10. ACK [~]	Acknowledge	Input	Output from printer indicating data has been accepted.
11. BUSY	Printer Busy	Input	Output from printer indicating printer not ready to accept data.
12. PE	Paper Empty	Input	Output from printer indicating out of paper. (High = no paper)
13. SLCT	Select	Input	Output from printer indicating the printer has been selected.
14. AUTOFD [~]	Autofeed	Output	To signal printer for continuous form feed. (Auto linefeed)
15. ERROR [~]	Printer Error	Input	Output from printer indicating error.
16. INIT [~]	Initialize	Output	To signal printer to initialize.
17. SLCTIN [~]	Select printer	Output	To select printer.
18 -25. GND	Ground		Chassis signal Ground

Continued on next page

Connecting a Printer to the Parallel Port, Continued

Connection diagram

The following diagram shows the connection for the Epson FX80 printer.

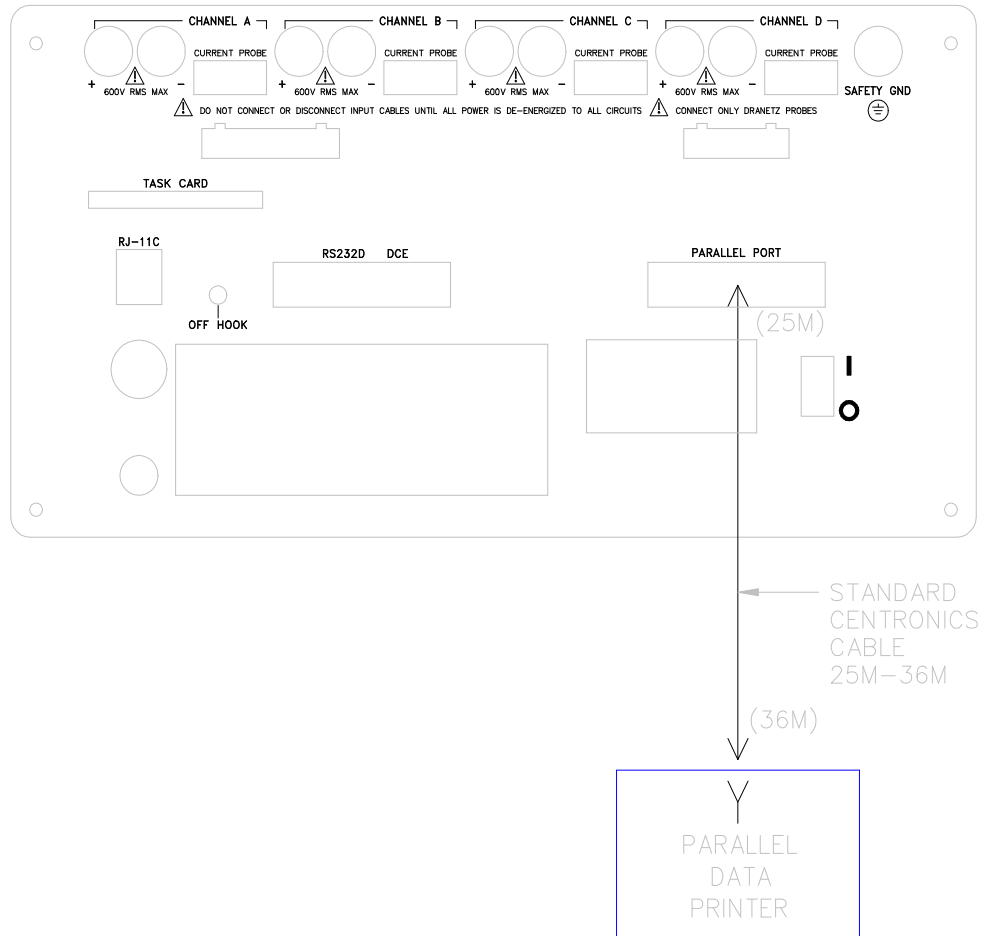

8600-29

Continued on next page

Connecting a Printer to the Parallel Port, Continued

Configure port Follow these steps to configure the parallel port.

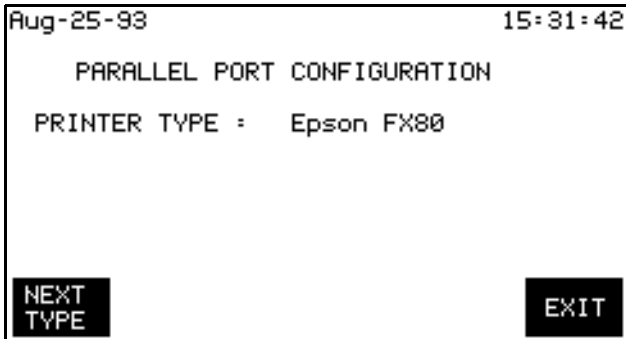
Step	Action
1	Select item 3, Setup Menu, from the Main Menu.
2	Select item 8, I/O Devices from the Setup Menu.
3	Select item 3, Parallel Port, from the Setup Menu. The following display appears. 
4	Press NEXT TYPE to select either Off or Epson FX80.
5	Press EXIT to initiate printer operation.

Connecting Remote Devices to RS232D Port

Introduction A remote serial data terminal, PC, or printer can be connected to the RS232D port of the Power Platform by means of external modems. Only one device can be connected at any time.

Modem Hayes AT command set compatible modems are recommended.

CAUTION **This equipment has been tested and found to comply with emissions and/or immunity requirements. Shielded cables and shielded connectors must be used when connecting external devices to the main or auxiliary ports. Only certified Class A or B peripherals, applicable to the national regulations of the user, are recommended for use with this equipment. The use of non-certified peripherals is likely to result in undesired interference.**

PRECAUCIÓN **Este equipo ha sido probado y se ha encontrado en conformidad con los requisitos de emisiones y/o inmunidad. Deben utilizarse cables blindados y conectores blindados cuando se conecten dispositivos externos a los puertos principal o auxiliar. Con este equipo, se recomienda utilizar sólo periféricos certificados de Clase A o B, aplicables a las regulaciones nacionales del usuario. Es probable que el uso de periféricos sin certificación produzca una interferencia indeseable.**

MISE EN GARDE **Ce matériel a été testé et déterminé conforme aux règlements relatifs à la pollution de l'air et/ou à l'immunité. Des câbles et des connecteurs blindés doivent être utilisés lors de la connexion de dispositifs extérieurs au port principal ou aux ports auxiliaires. Seuls des périphériques homologués Classe A ou Classe B, applicables dans le cadre des règlements nationaux de l'utilisateur, sont recommandés pour être utilisés avec ce matériel. L'utilisation de périphériques non homologués produira vraisemblablement des parasites.**

VORSICHT **Dieses Gerät wurde getestet und entspricht Emissions- bzw. Störfestigkeitsanforderungen. Bei der Verbindung externer Geräte mit den Haupt- bzw. Zusatzanschlüssen müssen abgeschirmte Kabel und Stecker verwendet werden. Für die Verwendung mit diesem Gerät werden nur genehmigte Peripheriegeräte der Klasse A oder B, die den Vorschriften im jeweiligen Land des Benutzers entsprechen, empfohlen. Die Verwendung nicht genehmigter Peripheriegeräte führt voraussichtlich zu unerwünschten Störungen.**

Connecting Remote Devices to RS232D Port, Continued

Cables required The following cables are provided as optional accessories.

Type	Part Number	Description
Direct, Shielded	113376-G1	RS232 Cable, 25-pin male to 25-pin female, 10 feet. D-sub connectors.
Adapter, Shielded	113394-G1	RS232 Cable, Adapter, 25-pin male to 9-pin female, 1 foot. D-sub connectors.
Modem, Shielded	115767-G1	RS232 Cable, External Modem Interface Cable Assembly, 6 feet. See Figure below.
Telephone	111024-G1	Four conductor, double ended, male plugs, 25 feet (Supplied with option MDM24).

Modem cable

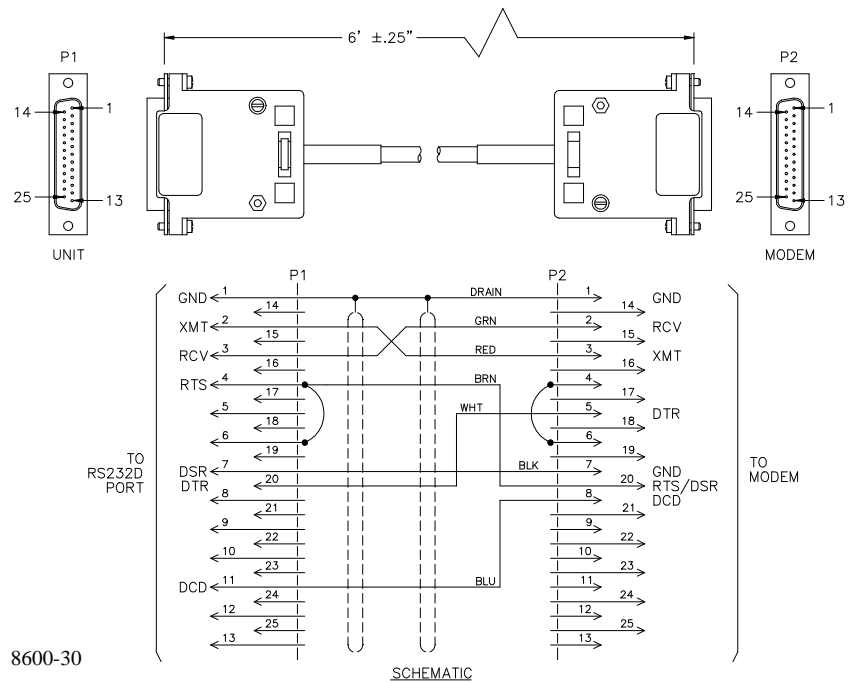

Continued on next page

Connecting Remote Devices to RS232D Port, Continued

Connection diagram

The following figure shows the physical connection of a remote device to the RS232D port using modems.

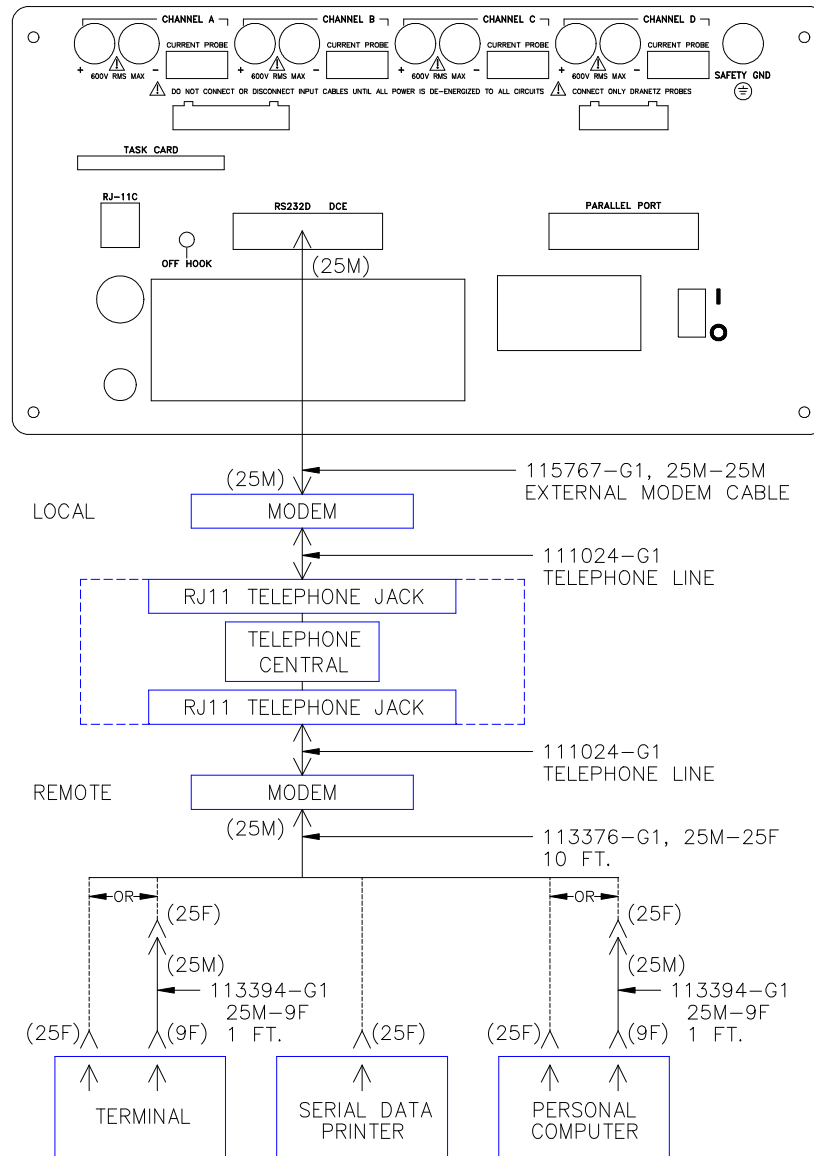

8600-3

Continued on next page

Connecting Remote Devices to RS232D Port, Continued

Displaying the screen

Follow these steps to display the RS232D Configuration screen.

Step	Action
1	Select item 3, Setup Menu, from the Main Menu.
2	Select item 8, I/O Devices, from the Setup Menu.
3	Select item 2, RS232, from the Setup Menu. <u>Result:</u> The following screen appears: <div data-bbox="670 686 1292 1022" data-label="Code-Block"> <pre> Dec-15-93 14:38:12 RS232D CONFIGURATION BAUD RATE: 9600 PARITY TYPE NONE # STOP BITS: 1 FLOW CONTROL: SOFTWARE (XON/XOFF) DEVICE: MODEM SET SET FLOW SET BAUD PARITY CONTRL DEVICE MORE EXIT </pre> </div>

Configuring the RS232D port for modem use

Follow these steps to configure the RS232D port for remote communication with a modem.

Step	Action
1	Press SET BAUD until the correct baud for your modem is displayed. <u>Note:</u> If using a 300 or 1200 Baud external modem, set the modem DIP switches for the following configuration: <ul style="list-style-type: none"> • DTR always ON • DCD REACT to CARRIER DETECT • ECHO MODE to OFF • VERBOSE MODE to OFF

Continued on next page

Connecting Remote Devices to RS232D Port, Continued

Configuring the RS232D port for modem use (continued)

Step	Action						
2	<p>Press SET PARITY and select odd, even, or none.</p> <p><u>Note:</u> # Stop Bits= 1 is not changeable.</p>						
3	<p>Press FLOW CONTRL for software control (XON/XOFF), hardware control (RTS/CTS), or NONE.</p> <p><u>Note:</u> Set for NONE if using a 9600 Baud modem</p>						
4	Press SET DEVICE until modem is displayed.						
5	Press MORE to display next screen.						
6	<p>Press #RINGS to set number of rings before answer.</p> <p><u>Result:</u> The menu bar will change to the following.</p> <div style="text-align: center; border: 1px solid black; padding: 5px;"> <table style="border-collapse: collapse; margin: 0 auto;"> <tr> <td style="border: 1px solid black; padding: 2px 10px;">ENTER</td> <td style="border: 1px solid black; padding: 2px 10px;">BACK SPACE</td> <td style="border: 1px solid black; width: 40px; height: 20px;"></td> <td style="border: 1px solid black; width: 40px; height: 20px;"></td> <td style="border: 1px solid black; width: 40px; height: 20px;"></td> <td style="border: 1px solid black; padding: 2px 10px;">EXIT</td> </tr> </table> </div>	ENTER	BACK SPACE				EXIT
ENTER	BACK SPACE				EXIT		
7	<p>Enter a number from 0 the 99.</p> <p><u>Note:</u> If 0 is entered, then the PP1-PQPlus will not answer.</p>						
8	<p>Press AUTO BAUD to toggle the auto baud function ON or OFF.</p> <p><u>Note:</u> When set to on, the modem will automatically adjust to the speed of the calling modem. If you are using a 300 Baud modem, set Auto Baud to OFF.</p>						
9	<p>Press ENTER HEADER to enter a header string. The alphanumeric entry screen appears to permit you to enter up to 37 command set characters. Refer to modem operating manual for command sets.</p> <p><u>Note:</u> It is not necessary to send the command ATZ or AT&F in the header string because the PP1-PQPlus automatically sends this command with every new configuration.</p>						
10	Press EXIT to initiate the configuration settings.						

Continued on next page

Connecting Remote Devices to RS232D Port, Continued

**Configuration
test**

To test that the device connected to the RS-232D port will respond to the configuration setup, perform the configuration test on page 11-28.

Connecting Remote Devices to RJ-11C Jack (not available on PP1E)

Introduction Remote devices can be connected to the RJ-11C jack if the internal modem option, MDM24, is purchased (not available on PP1E). This option is installed internal to the PP1-PQPlus and is provided with a 25 foot telephone cable. An FCC label is attached next to the RJ-11C on the rear panel to identify that the internal modem is installed.

RJ-11C jack description The RJ-11C telephone jack consists of a standard two-active-line (tip and ring) telephone cable for connection to a remote telephone jack.

Telephone active indicator The OFF HOOK indicator on the rear panel is lit yellow when the telephone line is active.

Cables required The following cables are provided as optional accessories.

Type	Part Number	Description
Direct, Shielded	113376-G1	RS232 Cable, 25-pin male to 25-pin female, 10 feet. D-sub connectors.
Adapter, Shielded	113394-G1	RS232 Cable, Adapter, 25-pin male to 9-pin female, 1 foot. D-sub connectors.
Telephone	111024-G1	Four conductor, double ended, male plugs, 25 feet (Supplied with option MDM24).

Compliance with FCC Rules and Regulations The optional internal Modem (MDM24) complies with Part 68 of the FCC rules. On the rear panel of this equipment is a label that contains, among other information, the FCC registration number and ringer equivalence number (REN) for this. If requested, this information must be provided to the telephone company.

Notification of the Telephone Company: All direct connection to the telephone network must be made through standard plugs and jacks as described in Part 68, Subpart F of the FCC Rules. The terminal equipment (Dranetz-BMI PP1-PQPlus equipped with Option MDM24) cannot be used on public coin service provided by the telephone company. Connection to Party Line Service is allowable and subject to state tariffs. (Contact the state public utility commission, public service or corporation commission for information.

Continued on next page

Connecting Remote Devices to RJ-11C Jack, Continued

Compliance with FCC rules and regulations (continued)

Before connecting the equipment to the telephone network, notify the telephone company of the line that you are using, the FCC Registration Number, the Ringer Equivalence of the Modem, and the type of Jack used for connection.

- FCC Registration Number: B46USA-65156-FA-E
- Ringer Equivalence: 0.2A
- Phone Jack (USOC): RJ-11C

Ringer equivalence number: The REN is used to determine the quantity of devices which may be connected to the telephone line. Excessive REN's on the telephone line may result in the devices not ringing in response to an incoming call. In most, but not all areas, the sum of the REN's should not exceed five (5.0). To be certain of the number of devices that may be connected to the line, as determined by the total REN's contact the telephone company to determine the maximum REN for the calling area.

Incidence of harm: If the terminal equipment (Dranetz-BMI Power Platform equipped with option MDM24) causes harm to the telephone network, the telephone company will notify you in advance that temporary discontinuance of service may be required. But if advance notice isn't practical, the telephone company will notify the customer as soon as possible. Also, you will be advised of your right to file a complaint with the FCC if you believe it is necessary.

Responsibilities of the telephone company: The telephone company may make changes in it's facilities, equipment, operations, or procedures that could affect the operation of the equipment. If this happens, the telephone company will provide advance notice in order for you to make the necessary modifications in order to maintain uninterrupted service.

In case of trouble: If trouble is experienced with this equipment (Dranetz-BMI Power Platform equipped with option MDM24), please contact Dranetz-BMI Customer Service Department, (732) 287-3680 for repair and warranty information. If the trouble is causing harm to the telephone network, the telephone company may request you to remove the equipment from the network until the problem is resolved.

Continued on next page

Connecting Remote Devices to RJ-11C Jack, Continued

Compliance with FCC rules and regulations
(continued)

Service: All service and repairs must be performed by Dranetz-BMI. If unauthorized modification or repair is performed, both the FCC Registration and the manufacturer's warranty in effect become null and void. If a malfunction is suspected, it is your responsibility to contact Dranetz-BMI Customer Service Department for further instructions. Telephone Number: (732) 287-3680

Connection diagram

The figure below shows the connection to external devices through the internal modem connected to the RJ-11C jack.

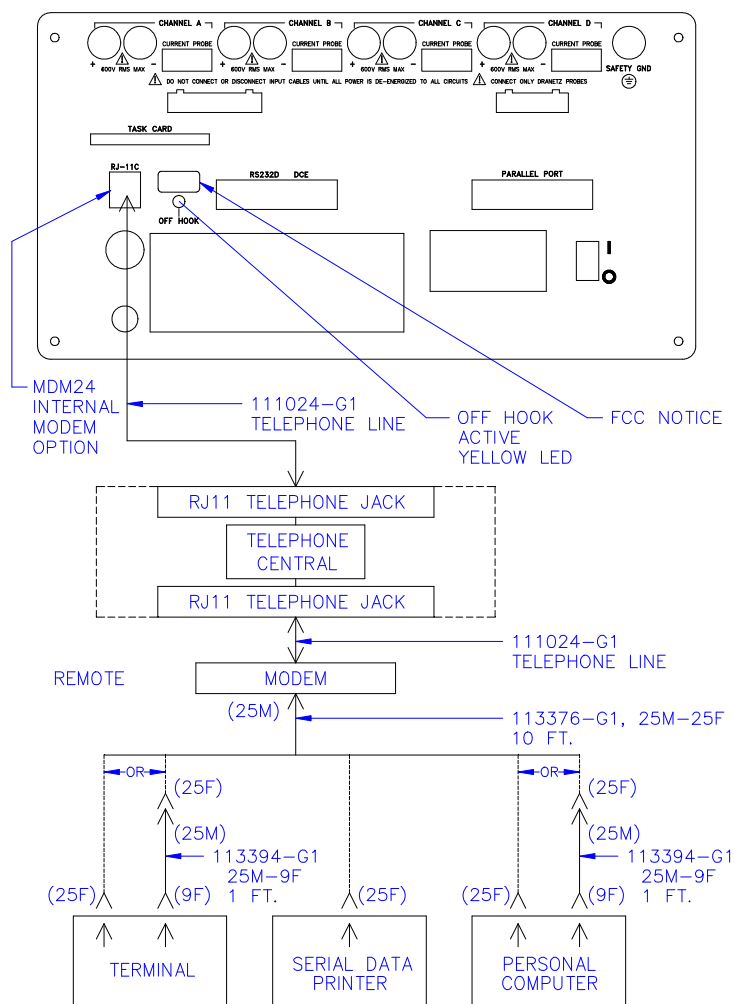

8600-4

Continued on next page

Connecting Remote Devices to RJ-11C Jack, Continued

Displaying the screen

Follow these steps to display the Modem/Fax Configuration screen.

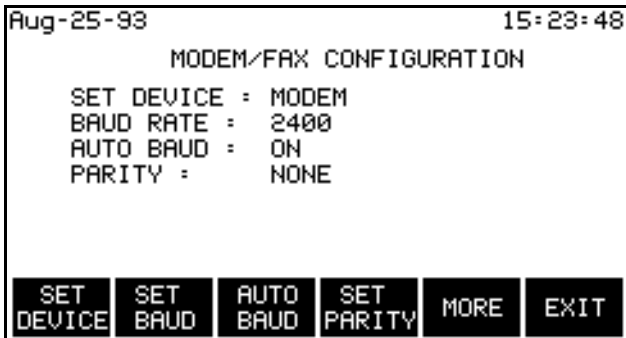
Step	Action
1	Select item 3, Setup Menu, from the Main Menu.
2	Select item 8, I/O Devices from the Setup Menu.
3	Select item 4, Modem/FAX, from the Setup Menu <u>Result:</u> The following screen will appear. 

Configure internal modem

Follow these steps to configure the internal modem for remote communication to a printer, terminal, or PC.

Step	Action
1	Press SET DEVICE to select Modem.
2	Press SET BAUD to select the desired baud.
3	Press AUTO BAUD to select either On or Off.
4	Press SET PARITY to select Odd, Even, or None.
5	Press MORE to display next screen.
6	Press FLOW CONTRL to select None, Software (XON/XOFF), or blank.
7	Press # RINGS and enter 0 to 99 digits in highlighted area for number of rings before answer selection.
8	Press # DIAL and enter 0 to 99 digits in highlighted area for number of dial attempts to be made.

Continued on next page

Connecting Remote Devices to RJ-11C Jack, Continued

Configure internal modem, continued

Step	Action
9	Press ENTER HEADER and enter modem header string. Refer to Appendix K for the explanation of valid character sequences and their meaning of the Hayes character set commands.
10	Press MORE to display next screen.
11	Press MODEM NUMBER and enter modem phone number.

Configuration test

To test that the configuration and cable connections are correct, perform the configuration test on page 11-28.

Connecting to a Facsimile (Fax) Machine (not available on PP1E)

Introduction Communication with a fax machine consists of connection to the RJ-11C jack on the rear of the Power Platform and configuring the modem/fax. This feature is not available on the model PP1E.

Cable required The only cable required for communication with a fax machine is a telephone cable. Telephone cable, part number 111024-G1, is available as an accessory.

Connection diagram The following figure shows the connection of the fax machine to the RJ-11C jack.

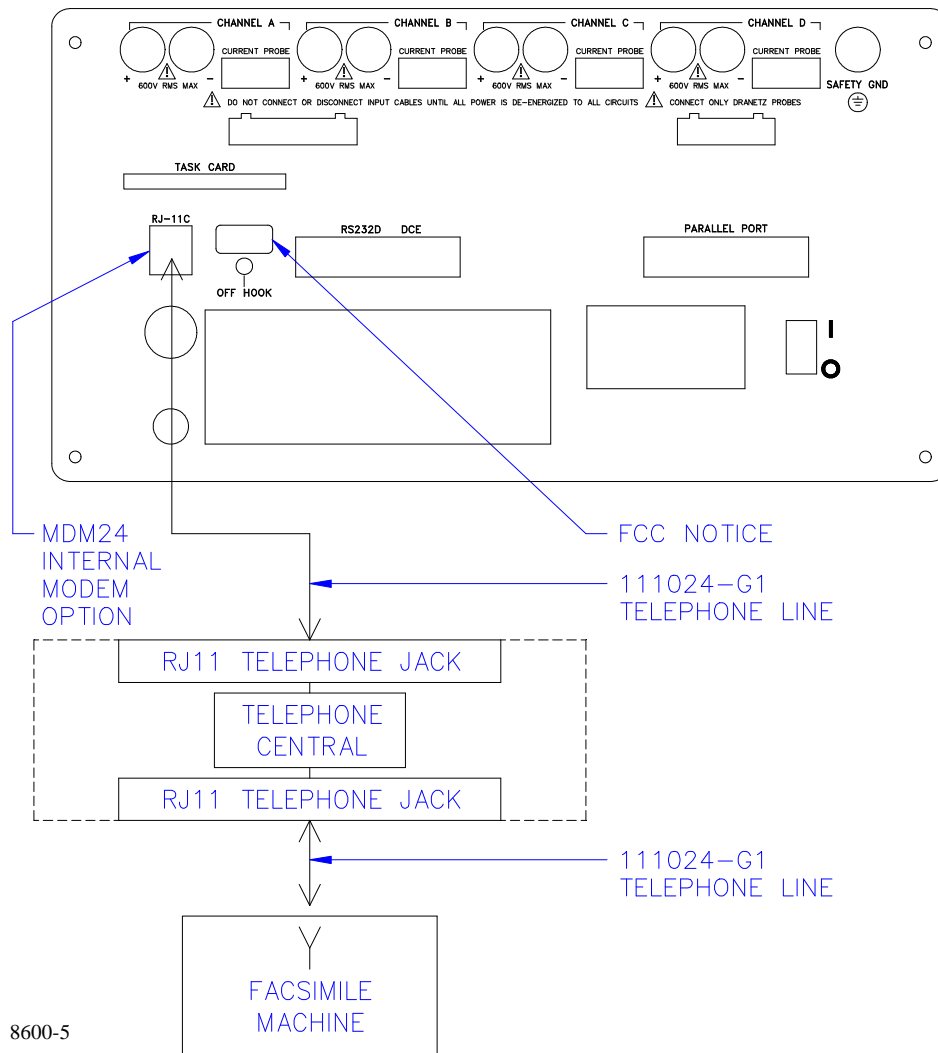

Continued on next page

Connecting to a Facsimile (Fax) Machine, Continued

Displaying the screen

Follow these steps to display the Modem/Fax Configuration screen.

Step	Action
1	Select item 3, Setup Menu, from the Main Menu.
2	Select item 8, I/O Devices, from the Setup Menu.
3	Select item 4, Modem/Fax, from the Setup Menu. <u>Result:</u> The following screen will appear.

```

Aug-25-93                               15:23:48
          MODEM/FAX CONFIGURATION
SET DEVICE : MODEM
BAUD RATE  : 2400
AUTO BAUD  : ON
PARITY     : NONE

SET DEVICE  SET BAUD  AUTO BAUD  SET PARITY  MORE  EXIT
    
```

Fax machine configuration

Follow these steps to configure the internal modem to communicate with a fax machine.

Step	Action
1	Press SET DEVICE and select FAX.
2	Press SET BAUD and select 300/1200/2400 rate.
3	Press AUTO BAUD and select On.
4	Press SET PARITY and select Odd/Even/None parity. <u>Note:</u> # Stop Bits= 1 is not changeable.
5	Press MORE to select next screen for more selections.
6	Press FLOW CONTRL and select None.
7	Press # RINGS and enter number of rings before answer.
8	Press # DIAL and enter number of dial attempts.
9	Press ENTER HEADER. Default header string of ATQ0V0X4S7=60S9=10S10=5 will be displayed.

Continued on next page

Connecting to a Facsimile (Fax) Machine, Continued

Step	Action
10	Press MORE to select next screen for more selections.
11	Press FAX# and enter FAX telephone number.
12	Press MODEM# and enter Modem telephone number.
13	Press EXIT.

Configuration test

To test that the configuration and cable connection is correct, refer to the configuration test on page 11-28.

Output Connected Device Configuration Test

Introduction

This test creates a simple fault and redirects the occurring fault message to the output connected device. The device may be connected directly to the RS232D, through an external modem, or internal modem. If the device is connected and configured correctly, then the error message will appear at that device.

Displaying the screen

Follow these steps to display the Error Message Output screen.

Step	Action
1	From Main Menu select item 3, Setup Menu.
2	From this menu select 2, Set Analyzer Parameters.
3	From this menu select 4, Select Error Message Output. <u>Result:</u> The following screen appears. <div style="border: 1px solid black; padding: 5px; margin: 10px 0;"> <pre> Feb-25-94 15:45:25 ERROR MESSAGE OUTPUT ERROR MESSAGES OUTPUT DEVICE PRINTER PAPER LOW RS232 MODEM BATTERY LOW RS232 MODEM RLY 1 AC POWER LOSS RS232 MODEM SYNCH LOSS RS232 MODEM INPUT OVERLOAD RS232 MODEM DEVICE FAULT RS232 MODEM MISC. ERRORS RS232 MODEM NEXT SELECT SELECT SELECT ERROR RS232 MODEM RELAY1 EXIT </pre> </div>

Configuration test

Follow these steps to perform the configuration test.

Step	Action
1	Press NEXT ERROR until Misc. Errors is highlighted.
2	Press SELECT RS232 and/or SELECT MODEM depending on the device connected. The screen should appear as shown above.

Continued on next page

Output Connected Device Configuration Test, Continued

**Configuration
test (continued)**

Step	Action
3	Press EXIT to initialize error message procedure.
4	Set the Run/Load lever to the load position. <u>Result:</u> A Printer Head Up error message will appear at the top of the display and will be redirected to the remote device.
5	Verify that the error message is received at the local or remote connected device.

Formatting a Memory Card

Formatting a card

Follow these steps to format a card.

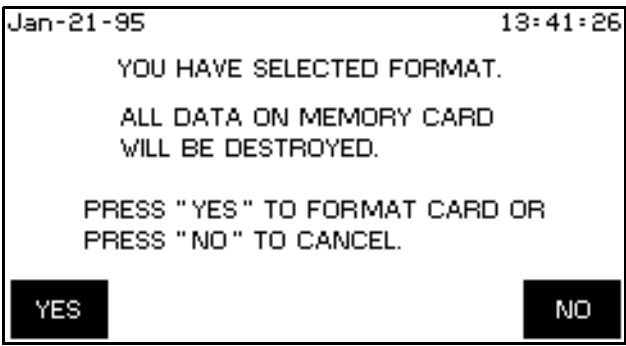
Step	Action
1	Insert a memory card.
2	From the Main Menu, select item 3, Setup Menu.
3	From the Setup Menu, select item 7, Memory Functions.
4	From the Memory Functions Menu, select item 1, Memory Card Functions.
5	<p>Press FORMAT CARD.</p> <p><u>Result:</u> The following screen will appear.</p> 
6	<p>Press YES.</p> <p><u>Result:</u> The message “Formatting and Verifying Data Card. Please Wait.” will be displayed until formatting is complete. The time it takes to format the card depends on the card size.</p>

Writing to a Memory Card

Introduction Events and setups can be written to a memory card. Information about the card size, card free space, whether the card is write protected or not, and the condition of the memory card battery, is displayed.

Procedure To write to a memory card perform the following steps.

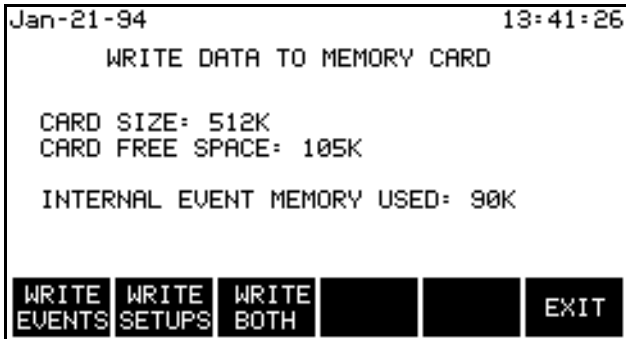
Step	Action
1	Insert memory card
2	Select item 3, Setup Menu, from the Main Menu.
3	Select item 7, Memory Functions, from the Setup Memory.
4	Select item 1, Memory Card Functions, from the Memory Functions Menu. the following screen will appear. 
5	Press WRITE CARD. The following screen will appear. 

Continued on next page

Writing to a Memory Card, Continued

Procedure (continued)

Step	Action
6	Press the desired write key. The following message will appear during write operations. Writing data into the memory card. Please wait.

Error messages and warning

The following error message will be displayed if there is insufficient space on the memory card.

Not enough free space on the memory card.
Data can not be written.

Note

The name of the files are taken from the site ID.

Files that don't exist

If a file selected to be written does not exist, it will be created. If the file already exists it will be overwritten.

Writing events

Selecting WRITE EVENTS will write all events in internal memory to the card.

Writing setups

Selecting WRITE SETUPS will write all configurations and threshold setups to the card. Configurations and setups include the following:

- Present monitoring (Analog input) configuration
 - Present wiring configuration (for ABC totals)
 - Present scale factors
 - Threshold setups for setups 1 - 10
 - Waveform capture settings
 - Interval for timed readings
 - Easy start and tolerance
 - Site name
 - Language setting
 - Error message output
 - Automatic report settings
 - Memory auto-transfer option
 - Memory type (wrap or overflow)
 - All I/O device settings (Fax/Modem, RS232, parallel port, relays, and other devices)
-

Chapter 12

Printer Operation

Overview

Introduction The Power Platform with a built-in thermal printer produces high resolution graphic or text output of 320 dots per line at one inch per second. Printing is done either automatically or manually. Automatic printing occurs for operator programmed triggering of reports or when error messages are generated. Manual printing is operator controlled with the PRINT key that is located on various screens.

In this chapter The following topics are covered in this chapter.

Topic	See Page
Printer Controls	12-2
Normal Operation	12-5
Paper Replacement	12-7

Printer Controls

Introduction

Printer controls are located on the front panel as well as in software. The printer assembly and its front panel controls are shown below.

Printer assembly

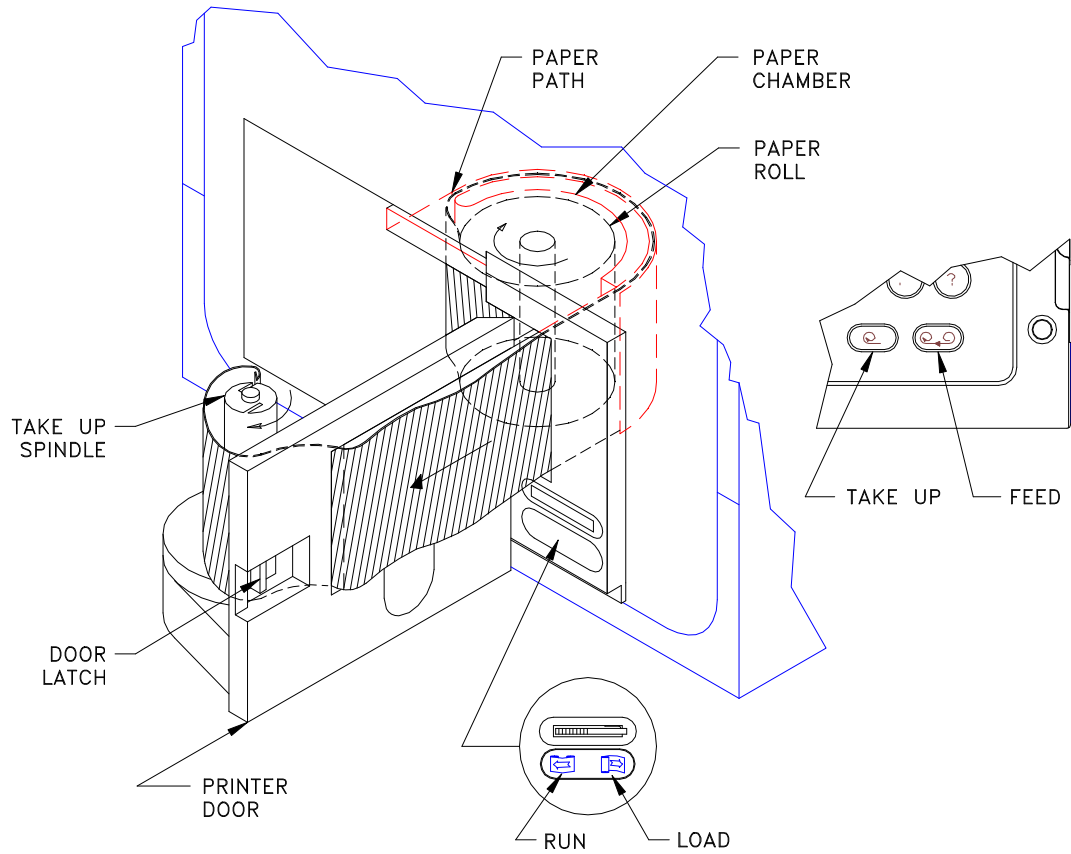

8000-13

Continued on next page

Printer Controls, Continued

Front panel controls

The following table provides a description of the front panel printer controls.

Part	Function
Run/Load lever	Used to raise and lower the printhead. <ul style="list-style-type: none">• In normal operation the lever is left in the RUN position.• With the lever in the LOAD position, printing is disabled and the printer paper may be removed or loaded.
Take-up button	Removes slack in the printer paper when pressed. The take-up feature stops under the following conditions: <ul style="list-style-type: none">• when there is some paper resistance, or• within ten seconds if the paper is torn or disconnected from the take-up spindle and the RUN/LOAD lever is in the RUN position.
Feed button	Advances the paper when pressed.

Continued on next page

Printer Controls, Continued

Software controls

The printer software controls are located on the Other Devices Configuration screen.

Displaying the screen: Follow these steps to display the screen.

Step	Action
1	From the Main Menu, select item 3, Setup Menu.
2	From the Setup Menu, select item 8, I/O Devices.
3	From the I/O Devices menu, select item 6, Other Devices. <u>Result:</u> The following screen will appear.

```

Jan-20-94                               13:37:35
      OTHER DEVICES CONFIGURATION
LCD BACKLIGHT AUTO-SHUTOFF: ENABLED
PRINTR ON/OFF: ON
PRINTR BATTERY OPERATION: TIME LIMIT
AUDIBLE ALARM ON/OFF: ON
LCD DISPLAY MODE: NORMAL
<press 1 to change>
BACK  PRINTR PRINTR ALARM  PRINT  EXIT
LIGHT ON/OFF BATTERY ON/OFF
    
```

Function keys: The following table provides a description of the printer related functions keys for the Other Devices configuration screen.

Key	Function
PRINTR ON/OFF	Turns printer on or off when pressed.
PRINTR BATTERY	Selects one of three operating modes when pressed: <ul style="list-style-type: none"> • Instant Off turns the printer off immediately after AC power loss • Time Limit turns the printer off 15 minutes after AC power loss • No Limit allows the printer to operate until the battery is completely depleted.

Note: The EXIT key must be pressed for either selection to take effect.

Normal Operation

Introduction To operate the printer normally (not running off the internal battery), the following conditions must be met:

- The printer must be turned on
- The RUN/LOAD lever must be in the RUN position.
- The printer must have paper.

Manual control of the printer from the function keys or the keypad and automatic printing of reports and error messages can now take place.

Manual printing Manual operation of the printer consists of selecting PRINT from the menu bar at the bottom of a screen (such as the Other Devices Configuration screen shown on the previous page) or pressing the correct number on the keypad for a menu screen that has a print selection. Pressing keypad number 7 for the screen shown below is an example of keypad print selection.

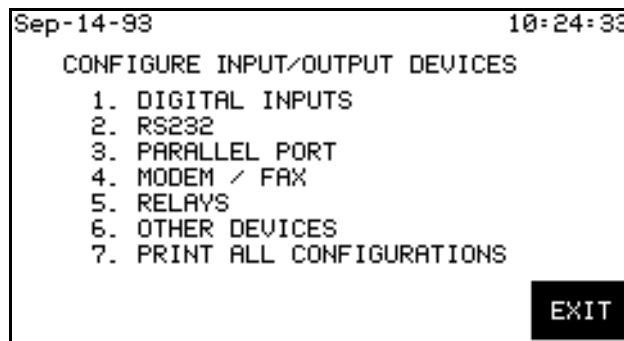

Automatic printing Automatic printing occurs when reports or error messages are generated. Report generation is controlled by the user; error message generation is not. Reports are printed automatically when user defined trigger conditions are met. Refer to Chapter 8 for more information.

Printout storage During printing, the paper is collected on the internal take-up spindle for storage and future review. Stored printouts can be viewed by inserting a finger into the finger groove, so that it is behind the paper tape, and pulling the paper tape straight out from the printer door. When finished viewing the earlier data, press the TAKE-UP pushbutton to remove the slack. If long lengths of paper are outside the Power Platform, be sure to keep paper from being twisted when using the paper take-up feature.

Continued on next page

Normal Operation, Continued

CAUTION Never grasp the printer paper and try to pull it out from the printhead with the RUN/LOAD lever in the RUN position. Damage to the printhead will result.

PRECAUCION Nunca tire del papel de impresora desde el cabezal de impresión con la palanca RUN/LOAD en la posición RUN. Puede ocasionar daños al cabezal de impresión.

MISE EN GARDE Ne jamais tirer le papier de la tête d'impression lorsque le levier RUN/LOAD est en position RUN. La tête d'impression serait endommagée.

VORSICHT Greifen und ziehen Sie nie das Druckpapier vom Druckkopf, wenn der "RUN/LOAD"-Hebel (Laufen/Laden-Hebel) sich in der RUN-Position (Laufen) befindet. Der Druckkopf kann beschädigt werden.

Snapshot printing Snapshot (single print) printing is used in the meter mode, scope mode, harmonic analysis, etc. These individual events are manually printed and are generally collected and cataloged into notebooks, ledgers, etc. Snapshot prints are separated from the print roll by tearing at the right edge of the printer window at the end of each print cycle.

Since snapshots are printed without the take-up motor engaged, the motor will run during each print cycle (approximately five seconds).

Paper Replacement

Paper low condition

The last 40 inches of paper is marked with a red stripe on the top and bottom edges. When the printer is out of paper, or the print head is up, the PP1-PQPlus will buffer the printouts until it can print again or until it runs out of memory.

CAUTION

To avoid damage to the printhead when loading or removing paper, the RUN/LOAD lever must be in the LOAD position.

PRECAUCION

Para evitar daños al cabezal de impresión cuando cargue o retire papel, la palanca RUN/LOAD debe estar en la posición LOAD.

MISE EN GARDE

Pour éviter d'endommager la tête d'impression lors de la mise en place et du retrait du papier, le levier RUN/LOAD doit être en position LOAD.

VORSICHT

Um während des Ladens oder Entfernens von Papier Beschädigung am Druckkopf zu verhindern, muß der "RUN/LOAD"-Hebel sich in der "LOAD"-Position (Laden) befinden.

Removing paper roll

Follow these steps to remove paper roll.

Step	Action
1	If paper is low, but not out, press the paper FEED pushbutton until only blank paper is showing.
2	Pull the paper out for slack and tear the paper on the right edge of the printer window.
3	Set the RUN/LOAD lever to the LOAD position.
4	Press the printer door latch to the right and open the door until it locks in place.
5	Remove the paper from the take-up spindle by tightly grasping the paper on the spindle, turning it clockwise, and gently pulling the paper up and off the spindle.
6	If there is paper remaining in the paper path, gently pull this paper out of the printer mechanism.
7	Remove the empty paper spool and any remaining paper from the paper chamber.

Paper Replacement, Continued

CAUTION Using thermal paper other than that supplied by Dranetz-BMI or its authorized representatives may damage the printhead.

PRECAUCIÓN El uso de papel térmico que no sea el suministrado por Dranetz-BMI o sus representantes autorizados puede causar daños a la impresora.

MISE EN GARDE L'utilisation d'un papier thermosensible différent de celui fourni par Dranetz-BMI ou par ses représentants autorisés peut endommager l'imprimante.

VORSICHT Nur das von Dranetz-BMI oder seinen Vertretungen gelieferte Thermopapier benutzen. Anderes Papier kann den Drucker beschädigen.

Before loading new paper roll Follow these steps before you load a new paper roll.

Step	Action
1	Remove the new paper roll from its box and remove any wrapping.
2	If the end of the paper roll is glued down, cut off and remove any glued portion.
3	Unroll approximately 12 inches of paper.
4	Verify that the RUN/LOAD lever is in the LOAD position.

Loading new paper roll Follow these steps to load a new paper roll.

Step	Action
1	Center the paper roll on the white nub on the bottom of the paper chamber with the loose end coming out clockwise from the back of the roll. See page 12-2 for paper routing.
2	Insert the end of the paper into the paper path slot to the left of the paper roll.
3	Feed the paper through the path until it comes out the front of the printer door.

Continued on next page

Paper Replacement, Continued

Loading new paper roll (continued)

Step	Action
4	Hold the paper against the spindle while rotating the bottom of the spindle at least two turns clockwise.
5	Move the end of the paper across the front of the printer door (from right to left) and guide it through the slot near the take-up spindle.

After loading new paper roll

Follow these steps after loading a new paper roll.

Step	Action
1	Set the RUN/LOAD lever to the RUN position. <u>Note:</u> Printer will not work if this lever is in the LOAD position.
2	Press the paper take-up pushbutton and note that all slack in the printer paper is removed, the paper is taut and the take up motor stops.
3	If the take up motor continues to spin, the paper is not engaged correctly. Repeat step 5 of the previous procedure.
4	Press the paper FEED pushbutton to ensure the paper advances freely across the printer door without slipping or stopping.
5	If the paper does not feed smoothly, remove the paper and repeat “Loading new paper roll” procedure on the previous page.
6	Close the printer door.

Ordering thermal paper

Contact Dranetz-BMI or your authorized Dranetz-BMI representative to order thermal paper (P/N 115323-G1) for the Power Platform thermal printer.

Appendix A

Optional Accessories

In this appendix The following topics are covered in this appendix.

Topic	See Page
Optional Accessories List	A-2
Optional Accessories Descriptions	A-4

Optional Accessories List

Accessory	Part Number
Power Quality Plus, TASKCard (English)	TASK-PQPlus-E
Power Quality Plus, TASKCard (Spanish)	TASK-PQPlus-S
Power Quality Plus, TASKCard (French)	TASK-PQPlus-F
8000, TASKCard	TASK-8000
Inrush, TASKCard	TASK-Inrush
Communications and Analysis Software	PCPP1
Field Handbook for Electrical Energy Management	HB114415
Service Manual	SM-PP1
Clamp-on Current Probe, 1 to 10 A	CT-10
Clamp-on Current Probe, 15 to 150 A	CT-150
Clamp-on Current Probe, 30 to 300 A	CT-300
Clamp-on Current Probe, 100 to 1000 A	CT-1000
Clamp-on Current Probe, 300 to 3000 A	CT-3000
Isolated Current Transformer Box, 1A	ISO-1A
Isolated Current Transformer Box, 5A	ISO-5
Memory Card Reader, Serial Port	
Memory Card Reader, Serial Port, 230 V	
Memory Card Reader, Parallel Port	
Memory Card Reader, Parallel Port, 230 V	
Memory Card Reader, Data Bus Plug-in	
Memory Card, 512k	CARD-512
Memory Card, 1M	CARD-1M
Memory Card, 2M	CARD-2M
Box of Thermal Paper (16 rolls)	CTP-16
External DC Battery Filter	XBF-12
External Battery Charger	

Continued on next page

Optional Accessories List, Continued

List (continued)

Accessory	Part Number
External Modem Interface Cable	XMC-8
RS-232 Cables, 25-pin M to 25-pin F, and a 25-pin M to 9-pin F adapter cable.	RSCOM
Soft Carrying Case (with probe pallet)	SCC-8
Reusable Shipping Case	RSC-8
Battery Pack, Field Replaceable	FBP-8
Internal Modem, 2400 Baud (not available on PP1E)	MDM24
Adapter Cable, 808 Probe to PP1 (see page A-6) (not available with PP1E)	115551-G1
Adapter Cable, 658 Probe to PP1 (see page A-6)	115552-G1

Optional Accessories Descriptions

Current probes and isolation current transformers

Current Probes: There are five clamp-on current probes, models CT 10, CT150, CT300, CT1000, and CT3000 used to measure ACrms currents up to a maximum of 10A, 150A, 300A, 1000A, and 3000A, respectively.

Isolation Current Transformers: Two isolation current transformers (ISO boxes), models ISO-1A (2Arms max) and ISO-5 (10Arms max) provide low level isolation nominal currents of 1Arms and 5Arms, respectively, for connection to low current devices or for connection to current probes of other manufacturers.

Either the clamp-on current probes or the isolation transformers can be connected to any one of the four current jacks on the Power Platform rear panel. A decal sheet is provided to allow color coding of the probes and transformers that correspond to the rear panel jacks.

Internal 2400 baud modem

The MDM24 option consists of a Hayes compatible 2400 Baud modem installed on the I/O controller board and a 25 foot modular plug/cable assembly for connection to telephone lines. Normally installed at factory when unit is originally purchased.

TASKCard-8000

The 8000 TASKCard changes the Power Platform to a power quantity monitor so that it measures, records, and displays electric power parameters to help you find inefficiencies in your electric system.

RSCOM cables

The RSCOM cables consist of two RS232 cables, one 10' long, the other 1' long. The ten foot cable has a 25-pin male connector and a 25-pin female connector. The one foot adapter cable has a 25-pin female connector and a 9-pin male connector for serial data connections. The cables permit the PP1-PQPlus to communicate with a terminal, computer, external printer, or external modem.

Memory cards

Several types of memory cards are available, from 512 kilobytes to 2 megabytes. A memory card is read by your PC with a memory card reader, also available as an option.

Continued on next page

Optional Accessories Descriptions, Continued

Memory card readers Three types of memory card readers are available as options. Each reader provides a different means of communications with an IBM compatible computer. The three types are: RS232 port, parallel port, and data bus plug-in.

External battery charger The optional external battery charger provides an alternate means for charging the FBP-8 battery pack or additional battery packs.

PCPP1 This is a Windows based program that is used to access and retrieve data from single or multiple remote Dranetz-BMI Power Platforms. Other features include totalization of demand and energy data from multiple units, manipulation of time plot data, and the ability to read data from a memory card if your PC is equipped with a memory card reader.

Handbook for Energy Management This optional reference handbook provides a comprehensive guide for information related to conducting a thorough energy audit, power distribution analysis, and methods of remedying inefficiencies of energy management.

Adapter cables Two types of adapter cables are available to permit connecting current probes of Dranetz-BMI models 808 and 658 to the PP1 current input jacks. These adapter cables are shown on the following page. Supplied with these cables is an information sheet (P/N 899009) that describes the cables and the scale factors of the respective current probes used with the cables.

Ordering information To order accessories, contact Dranetz-BMI Customer Service Department at:

Dranetz-BMI	Tel:(732) 287-3680
1000 New Durham Road	FAX: (732) 248-1834
Edison, NJ 08818-4019	www.dranetz-bmi.com
Attention: Customer Service	

Optional Accessories Descriptions, Continued

**Adapter cable,
808 to PP1,
P/N 115551-G1**
(not available
on PP1E)

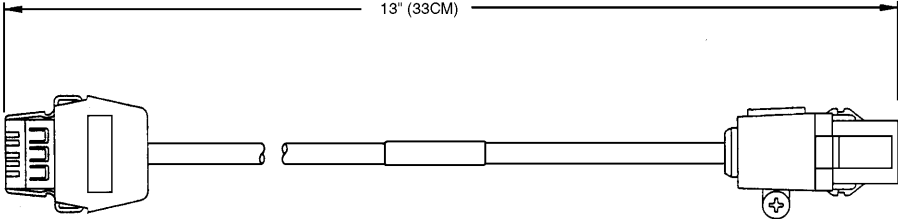

**Adapter cable,
658 to PP1,
P/N 115552-G1**

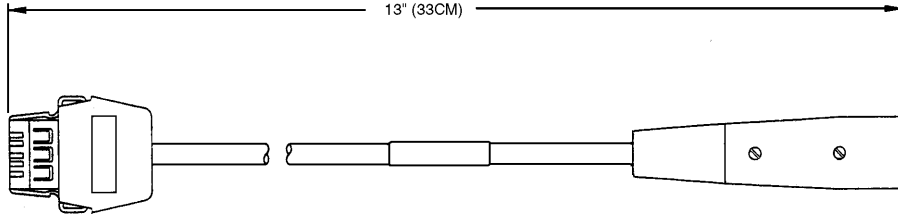

Appendix B

Repacking for Return Shipment

Introduction If the unit must be returned to Dranetz-BMI for service or repair, repack the unit in its original shipping carton as shown below. Do not return the Power Platform in an unpacked box. Dranetz-BMI will not be responsible for damage incurred during transit due to inadequate packing on your part.

Return notice Notify Dranetz-BMI Customer Service of your intention to return the unit. Do not return the unit without prior instructions from Dranetz-BMI Customer Service, telephone 732-287-3680 or 1-800-372-6832.

Original shipping carton

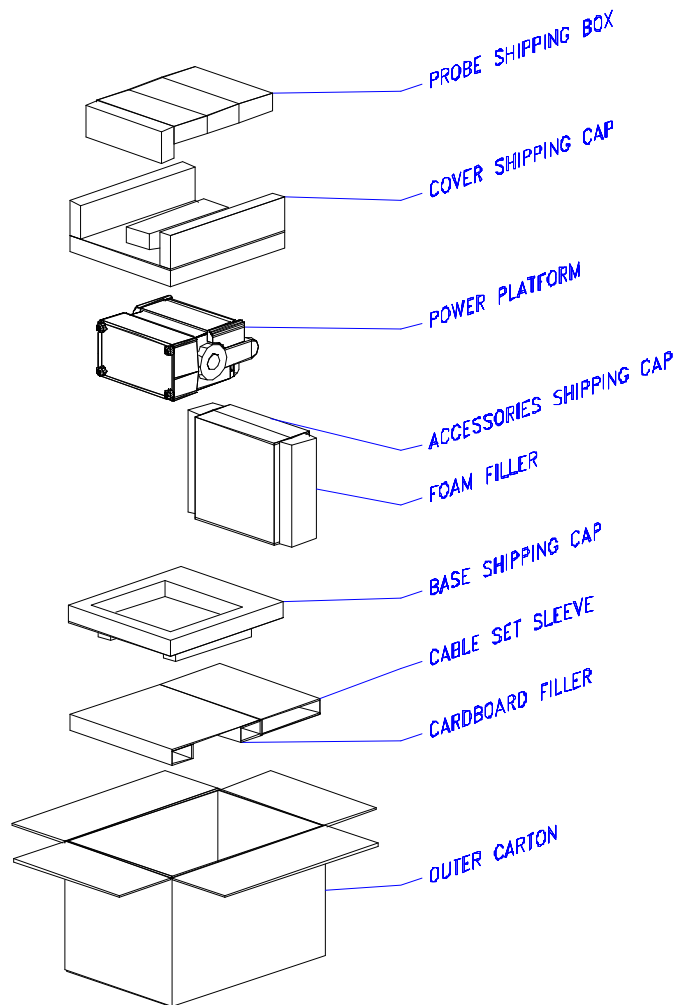

8600-31

Appendix C

Battery Specifications and Replacement Procedure

Overview

Introduction The internal battery pack used in the Power Platform functions as the uninterruptible power supply (UPS) in the event of AC power loss. It can also function as the primary power source when no AC power source is available.

The Power Platform also contains a lithium battery for memory backup.

In this appendix The following topics are covered in this appendix.

Topic	See Page
Battery Specifications	C-2
Battery Pack Safety Precautions	C-3
Battery Pack Replacement	C-5
Memory Card Battery Replacement	C-6

Battery Specifications

Battery Pack

Location: battery compartment on the top front of the unit

Number of cells: 10

Type: sealed, rechargeable NiCad cells

Voltage: 12 V DC

Capacity: 2.5 Ah

Length of operation: One hour of monitoring only operation when fully charged, or up to 15 minutes of continuous printer operation.

Suggested replacement interval: two years.

Note

The length of time that the Power Platform can operate on the battery pack degrades over the life of the batteries and the number of charge/discharge cycles.

Lithium Battery Power Module

A Lithium Battery Power Module is mounted on the CPU board and is used for memory backup of the PP1-PQPlus configurations and setups.

3 V, 1000 mAhrs Lithium battery for data retention with an estimated life of 2 years (operational), 1 1/2 years (storage). Replaced during each Dranetz calibration procedure.

The Lithium battery is not operator replaceable. Refer to the Power Platform service manual, SM-PP1, for replacement procedures by qualified service personnel.

Battery Pack Safety Precautions

WARNING

DO NOT intentionally short circuit the battery pack. The batteries are capable of producing hazardous output currents if short circuited. The Power Platform is equipped with an internal battery charger circuit. Do not attempt to charge the batteries with an external charger other than the Dranetz battery charger, since improper charging could cause battery explosion.

ADVERTENCIA

NO ponga intencionalmente la batería en cortocircuito. Las baterías son capaces de proporcionar corrientes de salida peligrosas si están en cortocircuito. La Power Platform está equipada con un circuito interno cargador de baterías. No intente cargar las baterías con un cargador externo que no sea el cargador de baterías Dranetz, puesto que la carga indebida podría hacer que explote la batería.

AVERTISSEMENT

NE PAS court-circuiter délibérément le bloc-batterie. Lors d'un court-circuit, les batteries risquent d'émettre des courants effectifs dangereux. "Power Platform" possède un circuit de chargeur de batterie intégré. Ne pas tenter de charger les batteries au moyen d'un chargeur externe autre que le chargeur de batterie Dranetz, car un rechargement fautif pourrait entraîner l'explosion de la batterie.

WARNUNG

Die Batterien dürfen NICHT kurzgeschlossen werden. Im Falle eines Kurzschlusses können die Batterien lebensgefährliche Ausgangsströme leiten. Power Platform ist mit einem internen Batterieladegerät ausgestattet. Die Batterien sollten nur mit dem Ladegerät von Dranetz geladen werden. Die Verwendung eines externen Ladegeräts kann zu einer Explosion der Batterien führen.

Battery Safety Precautions

The following safety precautions must be adhered to.

- Keep batteries away from children. Never permit a child to play with a battery as an ornament or toy.
 - Do not disassemble battery or battery pack.
 - Do not dispose of battery in fire.
 - Dispose of a used battery promptly in accordance with local Environmental Protection Agency (EPA) regulations.
-

Continued on next page

Battery Pack Safety Precautions, Continued

Battery Safety Precautions (continued)

- Visually inspect the battery pack for corrosion.
-

Medidas de seguridad de la batería

Deberán observarse las medidas de seguridad siguientes:

- No deberá mantenerse las baterías al alcance de los niños. No deberá permitirse que un niño juegue con una batería.
 - No deberá desensamblarse ninguna batería ni el compartimiento de la misma.
 - No deberá prenderse fuego a una batería.
 - Toda batería agotada deberá desecharse de manera rápida según las normas locales de la Agencia de protección del medio ambiente (EPA).
 - Deberá verificarse que el compartimiento de las baterías no esté corroído.
-

Mesures de sécurité relatives aux batteries

Il est très important de suivre les mesures de sécurité suivantes.

- Ne pas laisser les batteries à la portée des enfants. Ne jamais laisser un enfant jouer avec une batterie.
 - Ne pas démonter de batterie ou de bloc-batterie.
 - Ne pas jeter de batterie dans le feu.
 - Se débarrasser rapidement des batteries usagées en se conformant aux règlements de l'EPA (Agence américaine pour la protection de l'environnement).
 - Inspecter le bloc-batterie à l'oeil nu pour rechercher les signes de corrosion.
-

Batterie-Sicherheitsvorkehrungen

Die folgenden Sicherheitsvorkehrungen müssen beachtet werden.

- Halten Sie Batterien von Kindern fern. Erlauben Sie einem Kind unter keinen Umständen, eine Batterie als Verzierung oder Spielzeug zu benutzen.
 - Nehmen Sie Batterien oder Batteriepackungen nicht auseinander.
 - Entsorgen Sie Batterien nicht durch Verbrennen.
 - Entsorgen Sie verbrauchte Batterien umgehend nach den gesetzlichen Umweltschutzbestimmungen.
 - Prüfen Sie die Batteriepackung optisch auf Korrosion.
-

Note

The batteries have a safety pressure vent to prevent excessive gas build-up and corrosion indicates that venting has occurred. Possible causes of venting are: a defective charger, excessive temperature, excessive discharge rate, or a defective cell.

If corrosion is excessive, the battery pack may require replacement (contact Dranetz Customer Service Department).

Battery Pack Replacement

Introduction The Power Platform contains an easily replaceable internal battery pack. Replacement is recommended when the battery pack can no longer maintain a charge. Depleted battery packs may be charged outside the PP1 by using the optional battery charger. See Appendix A for battery pack ordering information.

Note During normal operation, the battery pack will be slightly warm to the touch.

Procedure Follow these steps to replace the battery pack.

Step	Action
1	Set the Power Platform's power switch to OFF.
2	On the top front section of the Power Platform, release the two slide fasteners holding the cover in place by pressing them inward.
3	Remove the cover.
4	Gently lift the battery pack from the battery compartment and disconnect the battery pack connector from the unit's mating connector.
5	Remove battery pack.
6	Connect the replacement battery pack connector to the unit's mating connector and place the new pack into the compartment.
7	Replace the cover and press down until it latches closed.
8	Discard the old battery pack in accordance with Environmental Protection Agency (EPA) regulations.
9	Set the Power Platform's power switch to ON.
10	Allow 8 hours to ensure a full charge. The Power Platform can be operated normally, using AC power, during this time.

Memory Card Battery Replacement

Introduction Replacement of the 3-volt lithium battery in the memory card is performed when the battery message in the Memory Card Function screen states the battery is depleted. Replacement is simple and requires no special tools. Two physically different types of batteries are used due to different manufacturers of the memory card. The correct replacement type must be used.

WARNING The battery used in this device may present a fire or chemical burn hazard if mistreated. Do not recharge, disassemble, or dispose of in fire. Replace battery with Panasonic BR2325 or CR2025 only. Use of another type battery may present a risk of fire or explosion.

ADVERTENCIA La batería empleada en este dispositivo puede presentar un peligro de incendio o quemadura química si se manipula indebidamente. No recargue, desarme ni deseche en el fuego. Cambie la batería por una Panasonic BR2325 o CR2025 solamente. El uso de cualquier otro tipo de batería puede presentar un peligro de incendio o explosión.

AVERTISSEMENT La batterie utilisée dans cette unité peut présenter des risques d'incendie ou de brûlures chimiques par suite d'une utilisation abusive. Ne pas recharger, démonter, ni jeter au feu. Remplacer uniquement la batterie par une batterie Panasonic BR2325 ou CR2025. L'utilisation d'un tout autre modèle de batterie peut entraîner des risques d'incendie ou d'explosion.

WARNUNG Die in diesem Gerät verwendete Batterie kann im Falle einer unsachgemäßen Behandlung zu Bränden oder chemischen Verätzungen führen. Sie sollte nicht wiederaufgeladen, auseinandergenommen oder verbrannt werden. Ersetzen Sie die Batterie nur mit Batterien vom Typ Panasonic BR2325 oder CR2025. Die Verwendung eines anderen Batterietyps kann Brände oder Explosionen hervorrufen.

Continued on next page

Memory Card Battery Replacement, Continued

Battery check To check the condition of the memory card battery, perform the following steps.

Step	Action
1	Insert questionable memory card in memory card slot on Power Platform and press card in firmly.
2	From Main Menu select 3, Setup Menu.
3	From Setup Menu select 7, Memory Functions.
4	From Memory Functions display select 1, Memory Card Functions.
5	Read Memory Card Battery = OK. If OK, do not replace the battery. If not OK, proceed to replacement procedure.
6	If message says OK, but the memory card is faulty, try a different memory card for operation. If the replacement memory card operates OK, the original memory card is faulty and should be replaced.

Battery types There are two types of physically different memory card batteries. Both batteries are 3-Volt, lithium, wafer type.

Part Number	Diameter	Thickness
Panasonic CR2025	0.79" (20mm)	0.1" (2.5mm)
Panasonic BR2325	0.9" (23mm)	0.1" (2.5mm)

Battery Safety Precautions The following safety precautions must be adhered to.

- Keep batteries away from children. Never permit a child to play with a battery as an ornament or toy.
- Do not disassemble battery or battery pack.
- Do not dispose of battery in fire.
- Dispose of a used battery promptly in accordance with local Environmental Protection Agency (EPA) regulations.

Continued on next page

Memory Card Battery Replacement, Continued

Medidas de seguridad de la batería

Deberán observarse las medidas de seguridad siguientes:

- No deberá mantenerse las baterías al alcance de los niños. No deberá permitirse que un niño juegue con una batería.
 - No deberá desensamblarse ninguna batería ni el compartimiento de la misma.
 - No deberá prenderse fuego a una batería.
 - Toda batería agotada deberá desecharse de manera rápida según las normas locales de la Agencia de protección del medio ambiente (EPA).
-

Mesures de sécurité relatives aux batteries

Il est très important de suivre les mesures de sécurité suivantes.

- Ne pas laisser les batteries à la portée des enfants. Ne jamais laisser un enfant jouer avec une batterie.
 - Ne pas démonter de batterie ou de bloc-batterie.
 - Ne pas jeter de batterie dans le feu.
 - Se débarrasser rapidement des batteries usagées en se conformant aux règlements de l'EPA (Agence américaine pour la protection de l'environnement).
-

Batterie-Sicherheitsvorkehrungen

Die folgenden Sicherheitsvorkehrungen müssen beachtet werden.

- Halten Sie Batterien von Kindern fern. Erlauben Sie einem Kind unter keinen Umständen, eine Batterie als Verzierung oder Spielzeug zu benutzen.
 - Nehmen Sie Batterien oder Batteriepackungen nicht auseinander.
 - Entsorgen Sie Batterien nicht durch Verbrennen.
 - Entsorgen Sie verbrauchte Batterien umgehend nach den gesetzlichen Umweltschutzbestimmungen.
-

Continued on next page

Memory Card Battery Replacement, Continued

Replacement procedure

To remove and replace a memory card battery, proceed with the following steps.

Step	Action
1	Remove memory card from Power Platform.
2	Refer to figure below. Gently press in battery release with pencil point and remove battery holder
3	Remove battery from holder and identify the type battery used. If type is not identified on body of battery refer to preceding page for battery dimensions.
4	Insert the exact type replacement battery in holder with plus (+) terminal facing up.
5	Insert battery holder into memory card and press in until locked in position.
6	Dispose of battery promptly. See safety precautions above.

Battery replacement diagram (typical)

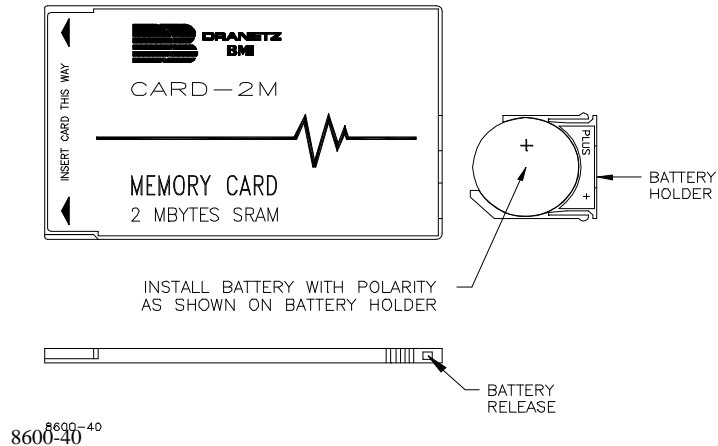

Appendix D

Fuse Replacement

Overview

Introduction Operator replaceable fuses consist of the main power fuses and the battery fuse. One of each type replacement fuse is located in the battery compartment and all fuses are accessible from the rear panel. Both types of replacement are covered in this appendix.

WARNING For continued protection against risk of fire or shock replace only with the same type and rating of fuse.

ADVERTENCIA Para la protección continua contra el peligro de incendio o descarga, cambie sólo por fusibles del mismo tipo y capacidad nominal.

AVERTISSEMENT Pour assurer une protection continue contre les risques d'incendie ou de choc, ne remplacez que par un fusible du même type et de la même valeur nominale.

WARNUNG Zum anhaltenden Schutz gegen Brand oder einen elektrischen Schlag nur gegen eine Sicherung desselben Typs und mit demselben Nennwert austauschen.

In this appendix The following topics are covered in this appendix.

Topic	See Page
Main Power Fuses	D-2
Battery Fuse	D-5

Main Power Fuses

Main Power Fuses

Follow these steps to remove and replace the two main power fuses. Refer to the diagram on the following page.

Step	Action
1	Set the Power Platform's power switch to OFF.
2	Turn off all power to monitoring circuits. Disconnect all Power Platform monitoring cables from power sources.
3	Disconnect the power cord plug from its wall or power receptacle, then remove the power cord from the AC power input module on the rear panel.
4	Place a small screwdriver blade into the notch next to the release arm of the fuse drawer.
5	Push the release to the right and pivot the screwdriver to the left to release the fuse drawer.
6	Remove the fuse drawer by pulling it straight out of the housing.
7	Replace blown fuse(s) with the exact replacement of slow-blow (time-delayed) fuse(s). See Main Power Fuse table.
8	Insert fuse drawer and press in until it snaps into position.
9	Reconnect power cord to the AC power input module, then reconnect power cord plug to its wall or power receptacle.
10	Before powering the unit on, refer to Chapter 4, Section A for operating precautions.
11	Set the Power Platform's power switch to ON.
12	Verify that the unit is operational.

WARNING

Do not replace fuse again if failure is repeated. Repeated failure indicates a defective condition that will not clear with replacement of the fuse. Refer condition to a qualified technician.

ADVERTENCIA

No reemplace el fusible nuevamente si se repite la falla. La repetición de las fallas indica una condición defectuosa que no se subsanará con el cambio del fusible. Acuda a un técnico calificado para evaluar la condición.

Continued on next page

Main Power Fuses, Continued

**AVERTISSE-
MENT**

Ne remplacez pas le fusible une nouvelle fois si la défaillance se répète. Une défaillance répétée indique une condition défectueuse qui ne disparaîtra pas avec le remplacement du fusible. Consultez un technicien qualifié.

WARNUNG

Die Sicherung nicht erneut austauschen, wenn der Fehler noch einmal auftritt. Ein wiederholtes Auftreten des Fehlers weist auf einen Defekt hin, der sich nicht durch Austauschen der Sicherung beheben läßt. Den Defekt einem qualifizierten Techniker mitteilen.

**Main Power
Fuse table**

Use this table to determine the type of fuse required.

	Main Power Fuse	Dranetz-BMI P/N
Model PP1	Slow blow, 250V, T2A, 3AG, glass tube 1/4 x 1 1/4	113204-G2
Model PP1E	Slow blow, 250V, T1.25A glass tube 5 x 20 mm (standard IEC127, type T, sheet III)	900387

Continued on next page

Main Power Fuses, Continued

Diagram

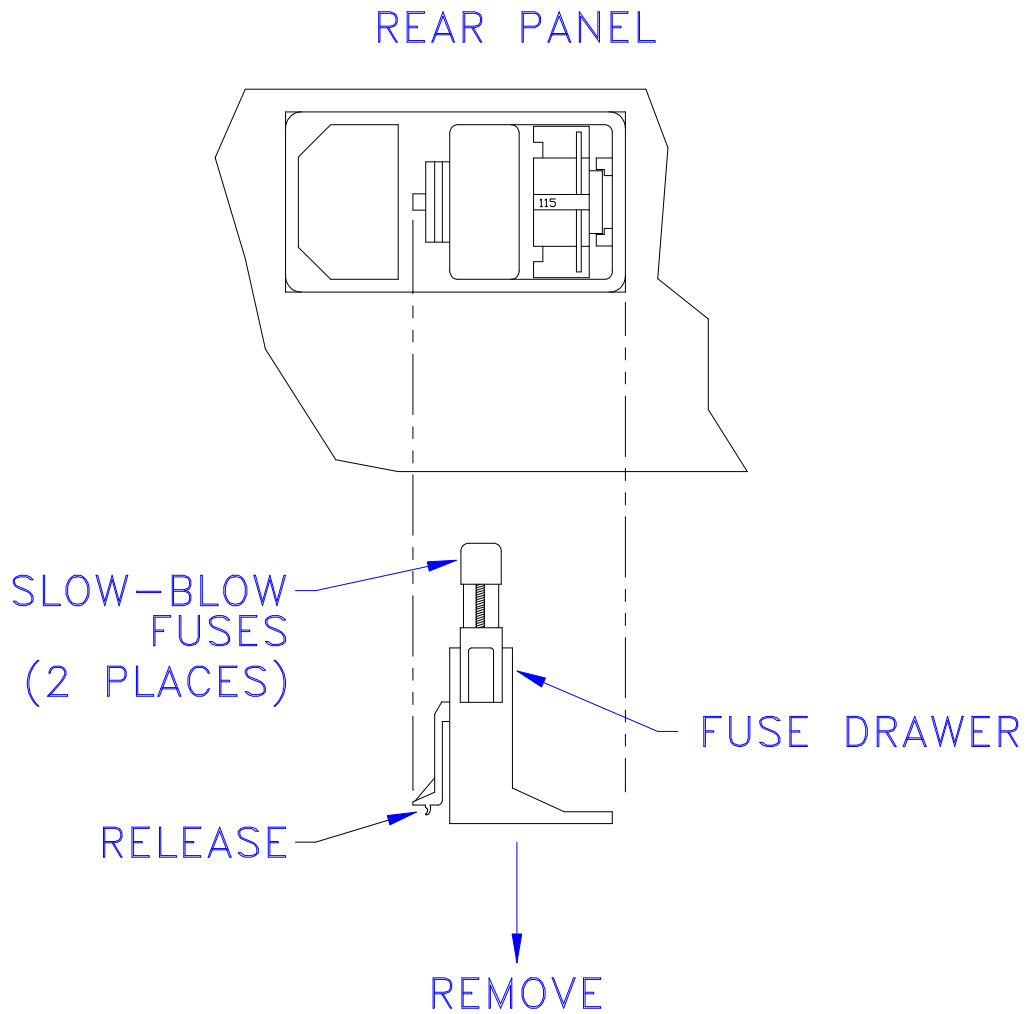

Battery Fuse

Introduction The battery fuse is used for fusing the internal battery pack, as well as an external DC source that is connected to the DC power source jack on the rear of the unit.

Procedure Follow these steps to replace the battery fuse.

Step	Action
1	Set the Power Platform's power switch to OFF.
2	Turn off all power to monitoring circuits. Disconnect all Power Platform monitoring cables from power sources.
3	If external DC source is being used, disconnect it or turn it off. If using an external DC battery, disconnect the negative terminal and then the positive terminal.
4	Disconnect external DC power source plug from external DC power source input jack on the rear panel of the Power Platform.
5	Insert the blade of a small screwdriver into the slot on the fuse cap and rotate a quarter turn counter clockwise.
6	Test fuse for continuity with an ohmmeter and replace fuse if blown. Replace blown fuse with the exact replacement of slow-blow (time delayed) fuse. See Battery Fuse table.
7	Reinsert the fuse cap and tighten securely.
8	Reconnect external DC source (if external DC source is being used).
9	Before powering the unit on, refer to Chapter 4, Section A for correct operating precautions.
10	Set the Power Platform's power switch to ON.

WARNING Do not replace fuse again if failure is repeated. Repeated failure indicates a defective condition that will not clear with replacement of the fuse. Refer condition to a qualified technician.

ADVERTENCIA No reemplace el fusible nuevamente si se repite la falla. La repetición de las fallas indica una condición defectuosa que no se subsanará con el cambio del fusible. Acuda a un técnico calificado para evaluar la condición.

Continued on next page

Battery Fuse, Continued

**AVERTISSE-
MENT**

Ne remplacez pas le fusible une nouvelle fois si la défaillance se répète. Une défaillance répétée indique une condition défectueuse qui ne disparaîtra pas avec le remplacement du fusible. Consultez un technicien qualifié.

WARNUNG

Die Sicherung nicht erneut austauschen, wenn der Fehler noch einmal auftritt. Ein wiederholtes Auftreten des Fehlers weist auf einen Defekt hin, der sich nicht durch Austauschen der Sicherung beheben läßt. Den Defekt einem qualifizierten Techniker mitteilen.

**Battery Fuse
table**

Use this table to determine the type of fuse required.

	Main Power Fuse	Dranetz-BMI P/N
Model PP1	Slow blow, 250V, T10A, 3AB, ceramic tube 1/4 x 1 1/4	113204-G3
Model PP1E	Slow blow, 250V, T6.3A glass tube 5 x 20 mm. (standard IEC127, type T, sheet III)	900396

Appendix E

Operator Replaceable Parts List

Introduction The following parts are listed for those items readily replaceable by the operator and not requiring special tools or access to the interior of the unit.

To order parts Call Dranetz-BMI Customer Service to order any of the following parts, telephone 1-800-372-6832 or 732-287-3680.

Parts List

Part Description	Part Number
Rubber Foot (Rear Panel)	115284-G1
Screw for above, 6-32 x 5/8" Long	113200-G15
Keylock keys (2)	115282-G1
Label, RUN/LOAD	115117-G1
Fuse, Slow blow, 250V, T2A, 3AG, glass tube 1/4 x 1 1/4 (AC power input) for PP1	113204-G2
Fuse, Slow blow, 250V, T1.25A glass tube 5 x 20 mm (standard IEC127, type T, sheet III) (AC power input) for PP1E	900387
Fuse, Slow blow, 250V, T10A, 3AB, ceramic tube 1/4 x 1 1/4 (Internal/External Battery) for PP1	113204-G3
Fuse, Slow blow, 250V, T6.3A glass tube 5 x 20 mm (standard IEC127, type T, sheet III) (Internal/External Battery) for PP1E	900396
Battery Pack	FBP-8
Battery Cover, without latches	115110-G1
Latch for Battery Cover (2 req'd)	115341-G1
Rubber Foot (Display Assembly)	113304-G1
Measurement Cable Set, complete (See next page for separate parts.)	115815-G1

Continued on next page

Parts List, Continued

Measurement Cable Set, Parts List

Part Description	Part Number		
	Domestic	Euro	UK
Measurement Cable Set	115815-G1	115815-G2	115815-G3
Cable Pallet	115816-G1	115816-G1	115816-G1
Interconnecting Cable Assy, Blue, 12 in. (30.5 cm)	114013-G1	114013-G1	114013-G1
Interconnecting Cable Assy, Red, 96 in. (243.8 cm)	114013-G2	114013-G2	114013-G2
Interconnecting Cable Assy, Black, 96 in. (243.8 cm)	114013-G3	114013-G3	114013-G3
Interconnecting Cable Assy, Blue, 96 in. (243.8 cm)	114013-G4	114013-G4	114013-G4
Interconnecting Cable Assy, Yellow, 96 in. (243.8 cm)	114013-G5	114013-G5	114013-G5
Safety Ground Cable Assy	114014-G5	114014-G5	114014-G5
Safety Clip Set Assy (Consists of 1 red and 1 black safety clip with attached caution label)	114890-G1	114890-G1	114890-G1
Power Cord, shielded, 115 VAC (Domestic)	110893-G1		
Power Cord, Shielded, 230 VAC (Euro)		115369-G1	
Power Cord, Shielded, 230 VAC (UK)			115368-G2

Appendix F

Technical Specifications

Overview

In this appendix The following specifications are covered in this appendix.

Topic	See Page
General	F-2
Interfaces	F-3
Measured Parameters	F-5
Computed Parameters	F-7
Current Probes	F-9
Isolated Current Transformer Boxes	F-10

General

Dimensions	<u>Size:</u> 7” Height x 13” Width x 10” Depth (17.8 x 33 x 25.4 cm) <u>Weight:</u> 20.8 pounds (9.4 kg)
Environmental	<u>Operating:</u> 5 to 45° Celsius (41 to 113° F) <u>Storage:</u> -20 to 55° Celsius (-4 to 131° F). <u>Humidity:</u> 10% to 90% non-condensing.
System Time Clock	Crystal controlled. 1 second resolution. Event time clock displays to 10msec resolution time displayed in 24 hour format HH:MM:SS. Accurate to 60 seconds per month.
Memory	750 kbytes of standard non-volatile data RAM (event storage). 256 kbytes of standard volatile data RAM (system memory). 768 kbytes of program RAM. (system memory) 256 kbytes of program EPROM. (system memory)
Memory Card	512Kbytes to 2Mbytes depending on the optional card memory capacity.
Note	A 15 minute warm up period is required to ensure that all performance specifications are met.
Power Requirements	<u>Voltage:</u> Switch selectable 90-130 or 180-250 V RMS. <u>Frequency:</u> 47-450 Hz. <u>Consumption:</u> 100 watts max. Unit will also operate using a 12 Vdc, 10 A external battery with filtering.
Installation Categories	<u>Mains supply:</u> Installation Category II, Pollution Degree 2 <u>Measurement inputs:</u> Installation Category III, Pollution Degree 2

Interfaces

Display

Type: Negative Transmissive Liquid Crystal Display (LCD) with Electroluminescent (EL) backlighting.

Resolution: 240 x 128 dot matrix.

Size: 4.25 x 2.27 inches.

Printer

Type: High resolution thermal graphics printer.

Resolution: 320 dots per line.

Speed: 1 inch per second.

Paper: 2.36 inches by 98 feet thermal paper.

Report size: Approximately 4 inches wide.

Serial Port

One RS232D female 25-pin D-type connector.

Configuration: DCE

Data rate: 300 to 9600 baud

Stop bits: 1

Parity: Odd, even, or none

Internal Modem/Fax:

Compatible with: Bell 103, Bell 212A, V.22, V.22 bis Responds to "AT" command set, FAX is group III compatible.

Modem data rate: 300, 1200, 2400 baud (automatic)

Fax data rate: 9600

Phone jack (USOC): RJ-11C

Continued on next page

Interfaces, Continued

**Internal
Modem/Fax:**
(continued)

FCC registration: B46USA-65156-FA-E

Ringer equivalence: 0.2 A

Relay outputs

One relay for external access rated 120 V AC or 30 V DC at 1 amp max. Rated as pilot relay.

Alarm

Audible alarm of short duration (approximately 0.1 second) indicates an error condition. Audible alarm of long duration (approximately 1 second) indicates an event trigger.

Measured Parameters

Voltage

Four fully differential voltage channels.

Channels A,B,C range: 10-600 Vrms max

Channel D low range: 1-60 Vrms max

Channel D high range: 10-600 Vrms max

Crest factor: Maximum of 2 at full scale

Accuracy: $\pm 0.5\%$ of reading $\pm 0.05\%$ full scale

Voltage transients

Channels A,B,C range: 50-6000 Vpk

Channel D low range: 5-600 Vpk

Channel D high range: 50-6000 Vpk

Frequency response: Typically -4dB at 1 μ s for half sine wave pulse

Accuracy: $\pm 10\%$ of reading $\pm 1\%$ full scale for half sine wave pulses $\geq 10\mu$ s

Transient duration: 1 μ sec minimum

Current

Four independent current input channels.

Channels A,B, C range: 10%-200% of full scale CT rating

Channel D range: 2%-100% of full scale CT rating

Channels A,B,C crest factor: Maximum of 3 at full scale

Channel D crest factor: Maximum of 2 at full scale

Accuracy: $\pm 0.5\%$ of reading $\pm 0.05\%$ of full scale, at fundamental frequency, using Dranetz CT-10, CT-150, CT-300, CT-1000, CT-3000 probes only.

Continued on next page

Measured Parameters, Continued

Current transients

Channels A,B,C range: 10%-300% CT full scale

Channel D range: 2%-200% CT full scale

Frequency Response: Typically -4dB at 1 μ s for half sine wave pulses plus probe.

Accuracy: $\pm 10\%$ of reading $\pm 1\%$ FS for half sine wave pulses $\geq 10\mu$ s plus probe.

Transient Duration: 1 μ sec minimum

Phase

Each voltage/current pair (i.e. Channel A voltage, Channel A current) are sampled simultaneously to preserve phase relationship.

Input resistance

Voltage input: 8 Mohms

Current input: 200 kohms

Frequency

Fundamental range: 30Hz - 450Hz

Accuracy: $\pm 0.2\%$ of reading

Environmental

All specifications are met at 25 degrees Celsius (77° F)

Temperature coefficient for measured parameters is approximately 200 ppm of full scale per degree Celsius.

Computed Parameters

Update rate All parameters (except harmonic) are updated once per second. Harmonic based parameters are updated every 5 seconds.

ABC volts Calculated as the geometric mean of the three phases. See note.

$$V_{ABC} = \sqrt{(V_A^2 + V_B^2 + V_C^2)/3}$$

ABC amps Calculated as the sum of the three phases. See note.

$$I_{ABC} = I_A + I_B + I_C$$

Real power Single Phase: Average of instantaneous power samples taken as the product of voltage and current samples. Includes sign to indicate direction of power flow: + from source to load, - from load to source.

$$W = (1/N) \sum_{n=1}^N V_n I_n$$

Three Phase: Calculated as the sum of the three phases. Includes sign to indicate direction of power flow: + from source to load, - from load to source. See note.

$$W_{ABC} = W_A + W_B + W_C$$

Accuracy: $\pm 2\%$ of reading $\pm 0.2\%$ of full scale at fundamental frequency.

Note All totals (ABC) numbers are not 3 phase. They are based on the wiring configuration, which can have single phase, split phase, wye or delta phase. Totals are based on N phases for calculations.

Continued on next page

Computed Parameters, Continued

Apparent power Single Phase: Calculated as volts RMS times amps RMS.

$$VA = V_{rms} \cdot I_{rms}$$

Three Phase: Calculated as vector sum of VAR_{ABC} and W_{ABC} . Includes sign to indicate direction of power flow: + from source to load, - from load to source.

$$VA_{ABC} = \sqrt{VAR_{ABC}^2 + W_{ABC}^2}$$

Accuracy: $\pm 2\%$ of reading $\pm 0.2\%$ of full scale at fundamental frequency.

Power factor Calculated as real power divided by apparent power. Includes sign to indicate leading or lagging load current.

$$PF = W/VA$$

Accuracy: ± 0.05 typical

Reactive power Single Phase: Calculated as vector difference between VA and W. Includes sign to indicate direction of power flow: + from source to load, - from load to source.

$$VAR = \sqrt{(VA)^2 - W^2}$$

Three Phase: Calculated as the sum of the three phases. Includes sign to indicate direction.

$$VAR_{ABC} = VAR_A + VAR_B + VAR_C$$

Accuracy: $\pm 2\%$ of reading, $\pm 0.2\%$ of full scale at power factor = 1.

Environmental All specifications are met at 25 degrees Celsius.

Temperature coefficient for computed parameters is approximately 400 ppm of full scale per degree Celsius.

Current Probes

Guidelines To achieve the rated accuracies, follow these guidelines:

- The conductor must be at a right angle to the probe
- The conductor must be centered in the probe core
- The jaw contact surfaces must be clean and properly aligned.

Specifications The following table lists the operating specifications for all optional Dranetz current probes.

	CT10	CT150	CT300	CT1000	CT3000
Current Range for Amplitude Accuracy (Arms) of 0.5%	1 to 10	3 to 125	10 to 300	50 to 1000	200 to 3000
Current Range for Phase Accuracy of 0.2° (Arms) at Calibration Point ()	2 to 10 (5)	5 to 125 (30)	15 to 300 (200)	100 to 1000 (200)	300 to 3000 (300)
Frequency Range (Hz)	45 to 10,000	45 to 10,000	15 to 10,000	30 to 50,000	30 to 5000
Impulse Width	Typically -3dB at 1 µsec at one-half sine wave.				
Output Signal of 3 Vrms at	10 Arms	150 Arms	300 Arms	1000 Arms	3000 Arms
Maximum Conductor Size	0.47" (12mm)	0.47" (12mm)	2.13" (54mm)	2.17" (55mm)	2.56" (65mm) or 1.97" x 5.3" (50 x 135 mm) or 2.56" x 3.94" (65 x 100 mm)

Environmental Operation: 5 to 45 degrees Celsius (41 to 113° F)

Storage: -20 to 55 degrees Celsius (-4 to 131° F)

Isolated Current Transformer Boxes

Specifications The following tables list the operating specifications for Dranetz isolated current transformers.

	ISO-1	ISO-1A	ISO-5
Current Range (Arms)	0.02 to 1.0 2.0 Arms max	0.02 to 1.0 2.0 Arms max	0.10 to 5.0 10.0 Arms max
Frequency Response (Hz)	50 to 3000	50 to 3000	50 to 3000
Output signal	3 Vrms @ 1 Arms	2 Vrms @ 1 Arms	3 Vrms @ 5 Arms
Accuracy	±1% 0.2 to 1 Arms	±1% 0.2 to 1 Arms	±1% 0.5 to 5 Arms
Scale Factor	0.333	0.500	1.666

Environmental Operation: 5 to 45 degrees Celsius (41 to 113° F)

Storage: -20 to 55 degrees Celsius (-4 to 131° F)

Appendix G

Predefined Setups

Overview

Introduction This appendix contains the threshold and waveform capture settings for the ten setups on the PQPlus TASKCard.

Description The table for each setup contains the following information

Parameter	Ch A	Ch B	Ch C	Ch D	Wave	All Chan
Parameter Name	xxx	xxx	xxx	xxx	On/Off	On/Off

Parameter:

Ch A, B, C, D: The numeric value or Off

Wave: On means that waveform data will be captured for the triggered channel only.

All Chan: On means that waveform data will be recorded for all channels.

Note: See page 6-12 for more detailed information about waveform capture.

In this appendix The following setups are listed in this appendix.

Setup	See Page
Setup #1: Single-Phase 120 Volt w/Neutral to Ground	G-2
Setup #2: Single-Phase 208 Volt	G-3
Setup #3: Single-Phase 220 Volt	G-4
Setup #4: Split-Phase 120/240 Volt	G-5
Setup #5: 3-Phase Wye 120 Volt	G-6
Setup #6: 3-Phase Wye 120 Volt w/CT-10	G-7
Setup #7: 3-Phase Wye 277 Volt	G-8
Setup #8: 3-Phase Delta 240 Volt	G-9
Setup #9: 3-Phase Delta 480 Volt	G-10
Setup #10: Easy Start	G-11

Setup #1: Single-Phase 120 Volt w/Neutral to Ground

Setup listing

Parameter	Ch A	Ch B	Ch C	Ch D	Wave	All Chan
V HIGH LIM	127.0	Off	Off	5.0	Off	Off
V LOW LIM	105.0	Off	Off	Off	Off	Off
V TRANSIENT	100.0	Off	Off	25.0	On	On
V THD%	5.0	Off	Off	Off	On	On
V FRQ HZ	5.0	Off	Off	Off	Off	Off
I HIGH RMS	Off	Off	Off	Off	Off	Off
I LOW RMS	Off	Off	Off	Off	Off	Off
I PEAK	Off	Off	Off	Off	Off	Off
I THD %	Off	Off	Off	Off	Off	Off
I TRANSIENT	Off	Off	Off	Off	Off	Off
WATTS HIGH LIM	Off	Off	Off	Off	Off	Off
VA HIGH LIM	Off	Off	Off	Off	Off	Off
VAR HIGH LIM	Off	Off	Off	Off	Off	Off
PF LOW LIM	Off	Off	Off	Off	Off	Off
V SENS OUT LIM	3.0	Off	Off	2.0	On	On
V SENS IN LIM	5.0	Off	Off	Off	Off	Off
I SENS OUT LIM	Off	Off	Off	Off	Off	Off
I SENS IN LIM	Off	Off	Off	Off	Off	Off
V TRANS % SENS	150.0	Off	Off	150.0	Off	Off
I TRANS % SENS	Off	Off	Off	Off	Off	Off
#3 V HARM %	5.0	Off	Off	Off	On	Off
#3 I HARM %	10.0	Off	Off	Off	On	Off

Setup #2: Single-Phase 208 Volt

Setup listing

Parameter	Ch A	Ch B	Ch C	Ch D	Wave	All Chan
V HIGH LIM	221.0	Off	Off	Off	Off	Off
V LOW LIM	181.0	Off	Off	Off	Off	Off
V TRANSIENT	150.0	Off	Off	Off	On	On
V THD%	5.0	Off	Off	Off	On	On
V FRQ HZ	0.5	Off	Off	Off	Off	Off
I HIGH RMS	Off	Off	Off	Off	Off	Off
I LOW RMS	Off	Off	Off	Off	Off	Off
I PEAK	Off	Off	Off	Off	Off	Off
I THD %	Off	Off	Off	Off	Off	Off
I TRANSIENT	Off	Off	Off	Off	Off	Off
WATTS HIGH LIM	Off	Off	Off	Off	Off	Off
VA HIGH LIM	Off	Off	Off	Off	Off	Off
VAR HIGH LIM	Off	Off	Off	Off	Off	Off
PF LOW LIM	Off	Off	Off	Off	Off	Off
V SENS OUT LIM	5.0	Off	Off	Off	Off	Off
V SENS IN LIM	5.0	Off	Off	Off	Off	Off
I SENS OUT LIM	Off	Off	Off	Off	Off	Off
I SENS IN LIM	Off	Off	Off	Off	Off	Off
V TRANS % SENS	150.0	Off	Off	Off	Off	Off
I TRANS % SENS	150.0	Off	Off	Off	Off	Off
#3 V HARM %	5.0	Off	Off	Off	On	Off
#3 I HARM %	10.0	Off	Off	Off	On	Off

Setup #3: Single-Phase 220 Volt

Setup listing

Parameter	Ch A	Ch B	Ch C	Ch D	Wave	All Chan
V HIGH LIM	233.0	Off	Off	Off	Off	Off
V LOW LIM	192.0	Off	Off	Off	Off	Off
V TRANSIENT	200.0	Off	Off	Off	On	Off
V THD%	5.0	Off	Off	Off	On	Off
V FRQ HZ	0.5	Off	Off	Off	Off	Off
I HIGH RMS	Off	Off	Off	Off	Off	Off
I LOW RMS	Off	Off	Off	Off	Off	Off
I PEAK	Off	Off	Off	Off	Off	Off
I THD %	Off	Off	Off	Off	Off	Off
I TRANSIENT	Off	Off	Off	Off	Off	Off
WATTS HIGH LIM	Off	Off	Off	Off	Off	Off
VA HIGH LIM	Off	Off	Off	Off	Off	Off
VAR HIGH LIM	Off	Off	Off	Off	Off	Off
PF LOW LIM	Off	Off	Off	Off	Off	Off
V SENS OUT LIM	5.0	Off	Off	Off	Off	Off
V SENS IN LIM	5.0	Off	Off	Off	Off	Off
I SENS OUT LIM	Off	Off	Off	Off	Off	Off
I SENS IN LIM	Off	Off	Off	Off	Off	Off
V TRANS % SENS	150.0	Off	Off	Off	Off	Off
I TRANS % SENS	150.0	Off	Off	Off	Off	Off
#3 V HARM %	5.0	Off	Off	Off	On	Off
#3 I HARM %	10.0	Off	Off	Off	On	Off

Setup #4: Split-Phase 120/240 Volt

Setup listing

Parameter	Ch A	Ch B	Ch C	Ch D	Wave	All Chan
V HIGH LIM	127.0	127	Off	Off	Off	Off
V LOW LIM	105.0	105	Off	Off	Off	Off
V TRANSIENT	100.0	100	Off	Off	On	Off
V THD%	5.0	005	Off	Off	On	Off
V FRQ HZ	0.5	00.5	Off	Off	Off	Off
I HIGH RMS	Off	Off	Off	Off	Off	Off
I LOW RMS	Off	Off	Off	Off	Off	Off
I PEAK	Off	Off	Off	Off	Off	Off
I THD %	Off	Off	Off	Off	Off	Off
I TRANSIENT	Off	Off	Off	Off	Off	Off
WATTS HIGH LIM	Off	Off	Off	Off	Off	Off
VA HIGH LIM	Off	Off	Off	Off	Off	Off
VAR HIGH LIM	Off	Off	Off	Off	Off	Off
PF LOW LIM	Off	Off	Off	Off	Off	Off
V SENS OUT LIM	3.0	3.0	Off	Off	Off	Off
V SENS IN LIM	5.0	5.0	Off	Off	Off	Off
I SENS OUT LIM	Off	Off	Off	Off	Off	Off
I SENS IN LIM	Off	Off	Off	Off	Off	Off
V TRANS % SENS	150.0	150.0	Off	Off	Off	Off
I TRANS % SENS	150.0	150.0	Off	Off	Off	Off
#3 V HARM %	5.0	5.0	Off	Off	On	Off
#3 I HARM %	10.0	10.0	Off	Off	On	Off

Setup #5: 3-Phase Wye 120 Volt

Setup listing

Parameter	Ch A	Ch B	Ch C	Ch D	Wave	All Chan
V HIGH LIM	127.0	127.0	127.0	5.0	Off	Off
V LOW LIM	105.0	105.0	105.0	0.0	Off	Off
V TRANSIENT	100.0	100.0	100.0	25.0	On	On
V THD%	5.0	5.0	5.0	Off	On	On
V FRQ HZ	0.5	0.5	0.5	Off	Off	Off
I HIGH RMS	Off	Off	Off	Off	Off	Off
I LOW RMS	Off	Off	Off	Off	Off	Off
I PEAK	Off	Off	Off	Off	Off	Off
I THD %	010	010	010	Off	On	Off
I TRANSIENT	Off	Off	Off	Off	Off	Off
WATTS HIGH LIM	Off	Off	Off	Off	Off	Off
VA HIGH LIM	Off	Off	Off	Off	Off	Off
VAR HIGH LIM	Off	Off	Off	Off	Off	Off
PF LOW LIM	0.8	0.8	0.80	Off	Off	Off
V SENS OUT LIM	5.0	5.0	5.0	2.0	Off	Off
V SENS IN LIM	5.0	5.0	5.0	Off	Off	Off
I SENS OUT LIM	Off	Off	Off	Off	Off	Off
I SENS IN LIM	Off	Off	Off	Off	Off	Off
V TRANS % SENS	150.0	150.0	150.0	150.0	Off	Off
I TRANS % SENS	150.0	150.0	150.0	150.0	Off	Off
#3 V HARM %	5.0	5.0	5.0	Off	On	On
#3 I HARM %	10.0	10.0	10.0	Off	On	Off

Setup #6: 3-Phase Wye 120 Volt w/CT-10

Setup listing

Parameter	Ch A	Ch B	Ch C	Ch D	Wave	All Chan
V HIGH LIM	127.0	127.0.0	127	5.0	Off	Off
V LOW LIM	105.0	105.0	105.0	0.0	Off	Off
V TRANSIENT	100.0.0	100	100.0	25.0	On	On
V THD%	5.0	5.0	5.0	Off	On	On
V FRQ HZ	0.5	0.5	0.5	Off	Off	Off
I HIGH RMS	5.0	5.0	5.0	5.0	Off	Off
I LOW RMS	0.0	0.0	0.0	0.0	Off	Off
I PEAK	7.0	7.0	7.0	7.0	On	Off
I THD %	10.0	10.0	10.0	Off	On	Off
I TRANSIENT	10.0	10.0	10.0	10.0	On	Off
WATTS HIGH LIM	Off	Off	Off	Off	Off	Off
VA HIGH LIM	Off	Off	Off	Off	Off	Off
VAR HIGH LIM	Off	Off	Off	Off	Off	Off
PF LOW LIM	0.8	0.8	0.8	Off	Off	Off
V SENS OUT LIM	5.0	5.0	5.0	2.0	Off	Off
V SENS IN LIM	5.0	5.0	5.0	Off	Off	Off
I SENS OUT LIM	0.5	0.5	0.5	0.5	Off	Off
I SENS IN LIM	1.0	1.0	1.0	1.0	Off	Off
V TRANS % SENS	150.0	150.0	150.0	150.0	Off	Off
I TRANS % SENS	150.0	150.0	150.0	150.0	Off	Off
#3 V HARM %	5.0	5.0	5.0	Off	On	On
#3 I HARM %	10.0	10.0	10.0	Off	On	Off

Setup #7: 3-Phase Wye 277 Volt

Setup listing

Parameter	Ch A	Ch B	Ch C	Ch D	Wave	All Chan
V HIGH LIM	304.0	304.0	304.0	5.0	Off	Off
V LOW LIM	250.0	250.0	250.0	0.0	Off	Off
V TRANSIENT	250.0	250.0	250.0	25.0	On	On
V THD%	5.0	5.0	5.0	Off	On	On
V FRQ HZ	0.5	0.5	0.5	Off	Off	Off
I HIGH RMS	Off	Off	Off	Off	Off	Off
I LOW RMS	Off	Off	Off	Off	Off	Off
I PEAK	Off	Off	Off	Off	Off	Off
I THD %	10.0	10.0	10.0	Off	On	Off
I TRANSIENT	Off	Off	Off	Off	Off	Off
WATTS HIGH LIM	Off	Off	Off	Off	Off	Off
VA HIGH LIM	Off	Off	Off	Off	Off	Off
VAR HIGH LIM	Off	Off	Off	Off	Off	Off
PF LOW LIM	0.8	0.8	0.8	Off	Off	Off
V SENS OUT LIM	5.0	5.0	5.0	2.0	Off	Off
V SENS IN LIM	5.0	5.0	5.0	Off	Off	Off
I SENS OUT LIM	Off	Off	Off	Off	Off	Off
I SENS IN LIM	Off	Off	Off	Off	Off	Off
V TRANS % SENS	150.0	150.0	150.0	150.0	Off	Off
I TRANS % SENS	150.0	150.0	150.0	150.0	Off	Off
#3 V HARM %	5.0	5.0	5.0	Off	On	On
#3 I HARM %	10.0	10.0	10.0	Off	On	Off

Setup #8: 3-Phase Delta 240 Volt

Setup listing

Parameter	Ch A	Ch B	Ch C	Ch D	Wave	All Chan
V HIGH LIM	264.0	264.0	264.0	Off	Off	Off
V LOW LIM	216.0	216.0	216.0	Off	Off	Off
V TRANSIENT	200.0	200.0	200.0	Off	On	On
V THD%	5.	5.0	5.0	Off	On	On
V FRQ HZ	0.5	0.5	0.5	Off	Off	Off
I HIGH RMS	Off	Off	Off	Off	Off	Off
I LOW RMS	Off	Off	Off	Off	Off	Off
I PEAK	Off	Off	Off	Off	Off	Off
I THD %	010	010	010	Off	On	Off
I TRANSIENT	Off	Off	Off	Off	Off	Off
WATTS HIGH LIM	Off	Off	Off	Off	Off	Off
VA HIGH LIM	Off	Off	Off	Off	Off	Off
VAR HIGH LIM	Off	Off	Off	Off	Off	Off
PF LOW LIM	Off	0.80	0.80	Off	Off	Off
V SENS OUT LIM	5.0	5.0	5.0	Off	Off	Off
V SENS IN LIM	10.0	10.0	10.0	Off	Off	Off
I SENS OUT LIM	Off	Off	Off	Off	Off	Off
I SENS IN LIM	Off	Off	Off	Off	Off	Off
V TRANS % SENS	150.0	150.0	150.0	Off	Off	Off
I TRANS % SENS	150.0	150.0	150.0	Off	Off	Off
#3 V HARM %	5.0	5.0	5.00	Off	On	On
#3 I HARM %	10.0	10.0	10.0	Off	On	Off

Setup #9: 3-Phase Delta 480 Volt

Setup listing

Parameter	Ch A	Ch B	Ch C	Ch D	Wave	All Chan
V HIGH LIM	528.0	528.0	528.0	Off	Off	Off
V LOW LIM	432.0	432.0	432.0	Off	Off	Off
V TRANSIENT	400.0	400.0	400.0	Off	On	On
V THD%	5.0	5.0	5.0	Off	On	On
V FRQ HZ	0.5	0.5	0.5	Off	Off	Off
I HIGH RMS	Off	Off	Off	Off	Off	Off
I LOW RMS	Off	Off	Off	Off	Off	Off
I PEAK	Off	Off	Off	Off	Off	Off
I THD %	10.0	10.0	10.0	Off	On	Off
I TRANSIENT	Off	Off	Off	Off	Off	Off
WATTS HIGH LIM	Off	Off	Off	Off	Off	Off
VA HIGH LIM	Off	Off	Off	Off	Off	Off
VAR HIGH LIM	Off	Off	Off	Off	Off	Off
PF LOW LIM	Off	0.8	0.8	Off	Off	Off
V SENS OUT LIM	10.0	10.0	10.0	Off	Off	Off
V SENS IN LIM	20.0	20.0	20.0	Off	Off	Off
I SENS OUT LIM	Off	Off	Off	Off	Off	Off
I SENS IN LIM	Off	Off	Off	Off	Off	Off
V TRANS % SENS	150.0	150.0	150.0	Off	Off	Off
I TRANS % SENS	150.0	150.0	150.0	Off	Off	Off
#3 V HARM %	5.0	5.0	5.0	Off	On	On
#3 I HARM %	10.0	10.0	10.0	Off	On	Off

Setup #10: Easy Start

Setup listing

Parameter	Ch A	Ch B	Ch C	Ch D	Wave	All Chan
V HIGH LIM	132.0	132.0	132.0	Off	Off	Off
V LOW LIM	108.0	108.0	108.0	Off	On	On
V TRANSIENT	180.0	180.0	180.0	Off	On	On
V THD%	10.0	10.0	10.0	Off	On	Off
V FRQ HZ	2.0	2.0	2.0	Off	Off	Off
I HIGH RMS	33.0	33.0	33.0	Off	Off	Off
I LOW RMS	Off	Off	Off	Off	Off	Off
I PEAK	Off	Off	Off	Off	Off	Off
I THD %	Off	Off	Off	Off	Off	Off
I TRANSIENT	Off	Off	Off	Off	Off	Off
WATTS HIGH LIM	Off	Off	Off	Off	Off	Off
VA HIGH LIM	Off	Off	Off	Off	Off	Off
VAR HIGH LIM	Off	Off	Off	Off	Off	Off
PF LOW LIM	Off	Off	Off	Off	Off	Off
V SENS OUT LIM	Off	Off	Off	Off	Off	Off
V SENS IN LIM	Off	Off	Off	Off	Off	Off
I SENS OUT LIM	Off	Off	Off	Off	Off	Off
I SENS IN LIM	Off	Off	Off	Off	Off	Off
V TRANS % SENS	150.0	150.0	150.0	Off	Off	Off
I TRANS % SENS	150.0	150.0	150.0	Off	Off	Off
#3 V HARM %	Off	Off	Off	Off	On	Off
#3 I HARM %	Off	Off	Off	Off	On	Off

Default settings are set at $\pm 10\%$ of 120 Vac and $+10\%$ of 30 Arms.
Refer to page 2-5 for changing Easy Start settings.

Appendix H

PP1-PQPlus Messages

Overview

Introduction PP1-PQPlus messages provide you with information or tell you about an error. This appendix describes the types of messages that can appear, lists the messages, and gives instructions about what to do next. Self-explanatory messages are not included.

In this appendix The following topics are covered in this appendix.

Topic	See Page
Message Types	H-2
Messages	H-3

Message Types

Introduction There are three types of messages: Normal One-Line, Important One-Line, and Full Screen. When a message is displayed it is automatically saved to memory for recall at a later time.

One-line messages All one-line messages are displayed on the top line of the screen between the time and date, and are a maximum of 21 characters long. They are displayed as long as the condition exists.

Normal one-line messages: Normal one-line messages are displayed in regular text.

Important one-line messages: Important one-line messages are displayed in reverse video.

Full screen messages Full screen messages warn you of potential system problems. You must press a key to remove the screen message.

Priority In general, a more important message will take priority over a less important one, with the exception of full screen messages which are displayed until you to press a key.

When two or more one-line message are active, they are cycled every two seconds. The priority is as follow:

Priority	Description
1	All new one-line messages are displayed immediately, accompanied by a short beep, then normal message cycling is resumed.
2	When there are important one-line messages, only these will be cycled until they are cleared.
3	When there is only one important one-line message displayed, no normal one-line messages will cycle until the displayed message is cleared.
4	No one-line messages are displayed on HELP screens, but full screen messages will operate normally.
5	Full screen messages will always take precedence over any type of one-line display.

Messages

One-line messages

Printer Head Overheat

Internal Bat Low

The charge on the internal battery is low. Plug the unit into an AC power source and turn on. Let charge for eight hours.

Internal Bat Bad

Check the internal battery connection. If the condition continues, the battery may have to be replaced.

External Bat Bad

Check the external battery charge and connections. Call Dranetz-BMI if the condition continues.

Sync Lost Ch A, B, C, or D

The unit cannot synchronize to the specified channel. Either no voltage or a voltage outside the sync range is being applied. If the unit continues to switch between Sync Lost and Sync Acquired, you may have to change to internal sync.

Sync Acquired-Ch A, B, C, or D

The unit has synchronized to the specified voltage channel.

Probe Ch A, B, C, or D-Connect

A current probe has been connected to the specified channel.

Probe Ch A, B, C, or D-Disconnect

The current probe on the specified channel has been disconnected.

Volts Overload Ch-A, B, C, or D

The voltage range for the specified channel has been exceeded.

Amps Overload Ch-A, B, C, or D

The current range for the specified channel has been exceeded. Use a probe with a range appropriate for your measurements.

Volts Overrange Ch A, B, C, or D

The voltage safety limit for the specified channel has been exceeded. Turn off power to the circuit and disconnect the unit.

Continued on next page

Messages, Continued

One-line messages (continued)

Amps Overrange Ch A, B, C, or D

The current safety limit for the specified channel has been exceeded. Turn off power to circuit and disconnect the unit.

AC Power Lost

The unit has now switched to battery power.

AC Power Restored

AC power has been restored and the unit is no longer operating from battery.

Full screen messages

Printer Power Failure

All print operations are currently suspended, please call Dranetz-BMI for service.

AC Power Lost message consists of the following:

WARNING: ERROR MESSAGE

log time= (Date and Time)

AC POWER LOST

The unit has now switched to battery power.

PRESS ANY KEY TO CONTINUE

ACP Self Reset

The ACP processor has reset. If this occurs regularly, please call Dranetz-BMI for service.

Appendix I

Connecting an External DC Power Supply

Overview

Introduction An external DC source of power can be connected to the Power Platform for normal operation without having to rely on local AC power. An external stand-alone automotive battery (installed in or out of the vehicle) or a regulated DC power supply of at least 10 amps capacity may be used. Connection is made to the DC external source jack in the lower left corner of the rear panel.

WARNING **Physical injury or damage to the instrument could result from incorrect connections. Always observe correct polarity. Make connections to the PP1 first and then make connections to the external DC power source.**

ADVERTENCIA **Podrían producirse lesiones físicas o daños al instrumento debido a conexiones incorrectas. Siempre observe la polaridad correcta. Efectúe primero las conexiones al PP1 y luego haga las conexiones a la fuente de energía de corriente continua externa.**

AVERTISSEMENT **Des connexions incorrectes risquent de causer des blessures aux personnes ou l'endommagement du matériel. Observez toujours la polarité correcte. Faites les connexions au PP1 en premier, puis branchez sur la source d'alimentation c.c. externe.**

WARNUNG **Falsche Verbindungen können zu Verletzungen oder Schäden am Gerät führen. Immer auf richtige Polarität achten. Zuerst Anschlüsse mit dem PP1 und dann Anschlüsse mit der externen Gleichspannungsquelle vornehmen.**

CAUTION **The internal battery of the Power Platform must be installed and charged before connecting an external power source to prevent possible damage to the Power Platform and/or the external power source.**

Continued on next page

Overview, Continued

PRECAUTION Debe estar instalada y cargada la batería interna del PP1 antes de conectar a una fuente de energía externa, a fin de prevenir posibles daños al PP1 y a la fuente de energía externa. Si se desconoce la condición cargada de la batería interna, cargue la batería por lo menos durante 16 horas.

MISE EN GARDE La batterie interne du PP1 doit être installée et chargée avant toute connexion à une source d'alimentation externe afin d'éviter tout risque d'endommagement du PP1 et de la source d'alimentation externe. Si l'état de charge de la batterie interne n'est pas connu, chargez la batterie pendant un minimum de 16 heures.

VORSICHT Zur Vermeidung möglicher Schäden am PP1 und der externen Spannungsquelle muß die interne Batterie des PP1 vor dem Anschluß an eine externe Spannungsquelle installiert und aufgeladen werden. Ist der Ladezustand der internen Batterie nicht bekannt, die Batterie mindestens 16 Stunden lang aufladen.

Standard Accessory A DC connector, part number 107506, is supplied with the Power Platform to permit you to make your own external power connecting cable.

Optional Accessories Optional connecting cables and a DC filter are available as accessories to connect external DC sources.

In this appendix The following topics are covered in this appendix.

Topic	See Page
Making and Connecting the DC Input Cable	I-3
External Battery Filter	I-6
Extension Cables	I-7
Installing the Battery Filter	I-8

Making and Connecting the DC Input Cable

Description A connector plug is supplied with the Power Platform for making a cable for connection to a stand alone battery or DC supply.

Connection to Power Platform: External DC power source jack (10-16V) on the rear panel

Maximum cable length: 6 feet

Minimum wire size: 16 AWG

Connector plug Below is the diagram of the connector plug (P/N 107506) supplied as a standard accessory of the Power Platform.

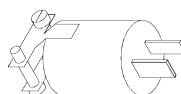

8000-15

Restrictions If the cable will be longer than 6 feet, or if the internal battery is to be connected to any other device (including a charging system), use the optional battery filter (Option XBF-12) and recommended optional cables. See page C-3.

Making the DC cable Follow these guidelines when making the DC cable.

- Connect a 16 AWG black colored wire (6 feet max) to pin 1 (wide prong) of connector plug. This is the negative (-) terminal.
- Connect a 16 AWG red colored wire (6 feet max) to pin 2 of the connector plug. This is the positive (+) terminal.

WARNING **Physical injury, or equipment damage could result if the cable is wired incorrectly. Verify all connections are correct before proceeding.**

ADVERTENCIA **Podrían producirse lesiones físicas o daños al equipo si se conecta incorrectamente el cable. Compruebe que todas las conexiones estén correctas antes de proceder.**

Continued on next page

Making and Connecting the DC Input Cable, Continued

AVERTISSEMENT Une connexion incorrecte du câble risque de causer des blessures aux personnes ou l'endommagement du matériel. Vérifiez que toutes les connexions sont correctes avant de poursuivre.

WARNUNG Bei einem falschen Anschluß des Kabels kann es zu Verletzungen oder Schäden am Gerät kommen. Vor dem Fortfahren überprüfen, ob alle Anschlüsse ordnungsgemäß vorgenommen wurden.

Internal battery check Follow these steps to check the status of the internal battery before connecting an external DC source.

Step	Action
1	From the Main Menu, select item 5, View Status
2	Press ANLYZR STATUS. <u>Result:</u> A screen similar to the following will appear. <div data-bbox="672 995 1295 1331" data-label="Code-Block"><pre>Jan-20-94 13:24:29 ANALYZER STATUS DISPLAY PRINTER: ON CONFIG: V1.0 RS232: OFF BATTERY: GOOD MODEM: OFF INPUT: GOOD MEMORY: 1024k ON HOST CPU: V2.0 GOOD I/O CPU: V1.0 GOOD ACP CPU: V1.0 GOOD DATABASE: V2.0 PRINT EXIT</pre></div>
3	Verify that the Battery=Good statement is displayed.

CAUTION Do not connect an external DC source if the battery statement is other than **GOOD**. Determine cause of battery fault before continuing.

PRECAUCION No conecte una fuente de CC externa si el estado de la batería no es **GOOD (BUENO)**. Determine la causa de la falla de la batería antes de continuar.

Continued on next page

Making and Connecting the DC Input Cable, Continued

MISE EN GARDE

Ne pas connecter une source d'alimentation c.c. si l'état affiché de la batterie n'est pas **GOOD (BON)**. Il est important de déterminer pourquoi la batterie est faible avant de continuer.

VORSICHT

Schließen Sie keine externe DC-Stromversorgungsquelle an, wenn der Zustand der Batterie anders als "GOOD" (Gut) ist. Bestimmen Sie die Ursache des Batteriefehlers, bevor Sie fortfahren.

Connecting the cable

Follow these steps when connecting the DC cable to the Power Platform.

Step	Action
1	Turn off power to Power Platform.
2	Turn off power to the external power source.
3	Disconnect cable wires from battery terminals, if connected.
4	Connect plug of DC cable to Power Platform 10-16V external power input jack on rear panel.
5	Connect DC cable wires to external power source (battery or power supply).
6	Turn on external power supply, if connected.
7	Turn on power to the Power Platform.

External Battery Filter

Introduction

Battery Filter, Model XBF-12, hereinafter referred to as the filter, provides external DC filtering for an external power source connected to the Power Platform. The filter provides a filtered DC input to the external power input jack on the Power Platform. The filter suppresses automotive ignition noise and discriminates against voltage transients greater than 18 VDC peak.

External power source

The external power source can consist of a 12V stand-alone battery or charging circuit of 12-16 VDC. If an automotive battery is used, it is recommended that the automotive engine be operating so that the battery is charging during usage.

If using own cable

If using the battery filter with your own cable, maximum cable length cannot exceed 25 feet. The minimum wire size to use is 16 AWG. Use black colored wire to connect to the negative terminal on the battery filter. Use red colored wire to connect to the positive terminal.

Filter description

The filter, Model XBF-12, shown below, consists of a two-terminal enclosure connected to an eight inch cable assembly, which is terminated by a two-pin plug. The two-pin polarized plug is connected to the rear panel connector jack, labeled 10-16VDC, on the Power Platform. Polarity indicators are provided on the cover for the terminal connections.

Filter diagram

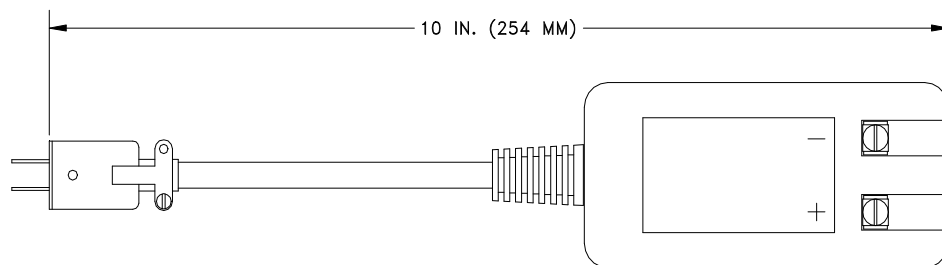

8600-32

Extension Cables

Introduction

Two types of accessory extension cables, shown below, permit connection of the filter to either an automotive cigarette lighter jack (also referred to as an accessory outlet) or to the terminal posts of a stand-alone battery. Both cables are 24 feet (7.3M) long and have spade lugs for connection of the two wires to the filter assembly terminals (+ Red, - Black).

Lighter cable description

The lighter cable assembly plug contains an internal 7 amperes slow blow fuse to protect the automotive circuitry.

Lighter cable diagram

The battery extension lighter cable assembly, P/N 115586-G1, is shown below.

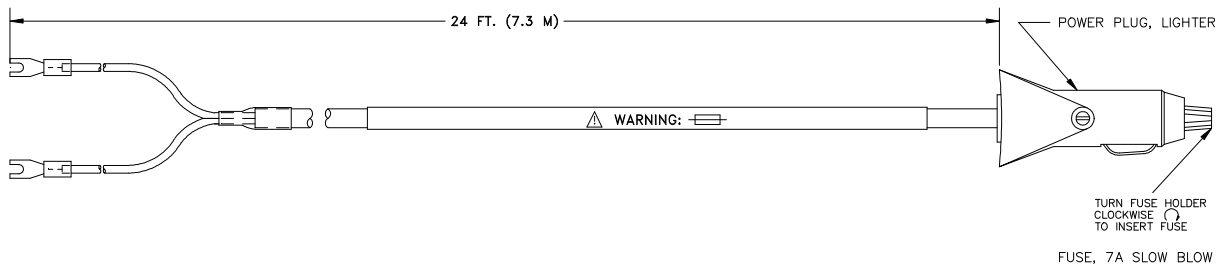

8600-33

Clip cable description

The clip cable assembly provides direct connection to the battery with crocodile clips and contains a 10 amp slow blow fuse in an in-line fuse holder of the red lead.

Clip cable diagram

The battery extension clip cable assembly, P/N 115587-G1, is shown below.

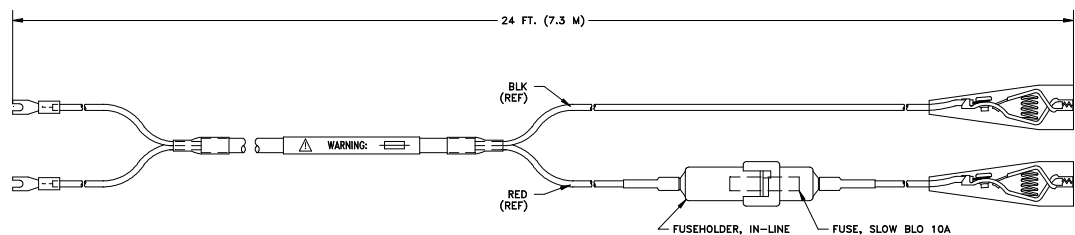

8600-34

Installing the Battery Filter

Before you begin Before you install the filter, perform the internal battery check that is detailed on page I-4.

Connect cable assembly to filter Follow these steps to connect either cable assembly to the filter.

Step	Action
1	Turn off the Power Platform and disconnect the AC input power plug from the rear panel input connector.
2	Select the type of extension cable to use depending on the voltage source. <u>Note:</u> Do not connect extension cable to source at this time.
3	Connect the extension cable spade lugs to the Filter assembly terminal connections. Red wire lug to plus (+) terminal and Black wire lug to negative (-) terminal.

CAUTION **Damage to the Power Platform and/or the external power source may occur if the lugs are reversed. Verify the proper color wires are connected to the correct polarity terminals; red wire to positive (+), black wire to negative (-).**

PRECAUCION **Pueden ocurrir daños a la Plataforma de energía y/o a la fuente de energía externa si se invierten las patas. Verifique si están conectados los alambres de color correcto a los terminales de la polaridad correcta; alambre rojo a positivo (+), alambre negro a negativo (-).**

MISE EN GARDE **L'inversion des languettes peut endommager la plate-forme d'alimentation et/ou la source d'alimentation externe. Assurez-vous que les fils de couleur sont connectés aux bornes appropriées ; le fil rouge sur le positif (+) et le fil noir sur le négatif (-).**

VORSICHT **Beschädigung an der "Power Platform" und/oder der externen Stromversorgungsquelle kann auftreten, wenn die Drähte vertauscht werden. Prüfen Sie die Farben der Drähte und ob diese an den richtigen Polaritäts-Terminals angeschlossen sind; roter Draht an Positiv (+), schwarzer Draht an Negativ (-).**

Continued on next page

Installing the Battery Filter, Continued

Connecting filter to Power Platform

Connect polarized plug of the filter assembly into Power Platform rear panel jack (10-16 VDC).

CAUTION

Before connecting or disconnecting directly to a stand-alone battery, place a damp cloth over the battery cell vent holes.

PRECAUCION

Antes de conectar o desconectar directamente a una batería autónoma, coloque un paño húmedo sobre el agujero de ventilación de la célula de la batería.

MISE EN GARDE

Avant la connexion ou la déconnexion directe d'une batterie autonome, placez un linge humide sur les orifices de ventilation de l'élément de batterie.

VORSICHT

Legen Sie vor dem Anschluß oder Abklemmen direkt an eine "Stand-Alone"-Batterie einen feuchten Lappen über die Batteriezellen-Ventilationslöcher.

Connecting cable to external DC power source

Step	Action
1	If vehicle mounted battery is being used, turn off vehicle ignition.
2	If clip cable is used, go to step 3. If cigarette lighter plug cable is used, go to step 5.
3	Connect the positive (+) red clip to the positive (+) battery terminal.
4	Connect the negative (-) black clip to a negative common connection other than directly to the battery terminal.
5	Connect the cigarette lighter plug to vehicle lighter jack. The external source can be in its normal charging operation after connection (for instance; the automotive engine may be running).
6	(Optional) Replace ac power plug to Power Platform power input jack if ac power is available.
7	Turn on vehicle ignition and start engine, if vehicle battery is being used.

Continued on next page

Installing the Battery Filter, Continued

Disconnecting cables

Follow these steps when disconnecting an external DC power source.

Step	Action
1	Shut off power to Power Platform.
2	Turn off ignition at vehicle or disconnect power source connectors at power source.
3	Disconnect plug from DC input on Power Platform.
4	Return to normal Power Platform operation.

Appendix J

PQPlus Menu Structure

Overview The menu structure for the PQPlus is shown in Figure J-1 on the following page. The menu structure is shown with the Main Menu as being the leading element. This was done for sake of simplicity since the Main Menu is the originating menu for most menus once TASKCard operation begins. All other menus return to the Main Menu upon completion of their tasks. In actuality, following power up, the Scope Mode screen is the first display.

Menu structure aids On the menu structure diagram, numbers are placed above some of the sub-menus to permit you to rapidly advance to that menu by simply selecting that number when originating from the Main Menu. For example: the Other Devices Menu (containing alarm control, printer control, etc.) can be quickly accessed from the Main Menu by pressing keys 3, 8, and 6, in that order.

At the bottom of all screens the function keys, when selected, permit further selection of multiple functions. The Menu Structure contains a listing of the important functions selectable under the function key. Scanning the listing under a major function can help you find a related function and its access.

Appendix K

Internal Modem Commands

General The internal modem of the PP1 (not available in the PP1E) is a Hayes compatible modem used in Bell 212A or CCITT V.22 operation. The internal modem is controlled by default or operator selected serial command sequences entered as the Modem Header String during display of the Modem / Fax Configuration screen. The command line may be as long as 40 characters excluding command AT.

Command codes The Command Codes table, on the next page, lists the command codes with their descriptions.

Note It is not necessary to send the Command ATZ or AT&F because the PP1 automatically sends this command with every configuration.

Register access codes The Register Access Codes table, on page K-5, lists the registers accessed by the modem to execute a variety of operations. The function of each register is explained in the table. The value of each register must be 0-25

Command Codes

Command	Description
AT	: Command line prefix (Attention code); precedes command line except ++++ (escape and A/ (repeat) commands
ATZ	: Loads the modem active configuration area with the stored configuration profile in nonvolatile memory
AT&F	: Loads the modem active configuration area with the factory profile contained in ROM
A	: Go off-hook in answer mode
A/	: Re-execute last command line; (A/ is not followed by a carriage return)
B	: Selects CCITT V.22 operation when communicating at 1200 bps
B1	: Selects Bell 212A operation when communicating at 1200 bps
D	: Dial number which follows D in the command line (See Dial Descriptors at end of table)
E	: Modem does not "echo" commands back to terminal
E1	: Modem "echoes" commands back to terminal
H	: On Hook (Hang up)
H1	: Off Hook
I	: Request product identification Code
I1	: Performs checksum on firmware ROM; returns checksum
I2	: Performs checksum on firmware ROM; returns OK or ERROR
L, L1	: Low speaker volume
L2	: Medium speaker volume
L3	: High Speaker Volume
M	: Speaker off
M1	: Speaker on until carrier detected
M2	: Speaker always on
M3	: Speaker on until carrier detected except during dialing
O	: Return to on-line state
O1	: Return to on-line state and initiate equalizer retrain
Q	: Modem returns result codes
Q1	: Modem does not return result codes
Sr=n	: Set register r to value n

Command Codes, Continued

Command	Description
Sr?	: Request contents of register r
V	: Short form numeric result codes
V1	: Full word result codes
X	: CONNECT result code enabled
X1	: Modem blind dials; all CONNECT XXXX result codes enabled; busy signal not detected
X2	: Modem waits for dial tone before dialing; all CONNECT XXXX result codes enabled; busy signal not detected
X3	: Modem blind dials; all CONNECT XXXX result codes enabled; modem sends BUSY result code if busy signal detected
X4	: Modem waits for dial tone before dialing; all CONNECT XXXX result codes enabled; modem sends BUSY result code if busy signal detected
Y	: Long space disconnect disabled
Y1	: Long space disconnect enabled
+++	: The default escape code
&C	: DCD always ON
&C1	: DEC ON indicates presence of data carrier
&D	: Modem ignores DTR
&D1	: Modem assumes command state when ON-to-OFF transition detected on DTR
&D2	: Modem hangs up, assumes command state and disables auto answer upon detected in ON-to-OFF transition on DTR
&D3	: Modem assumes initialization state upon detecting an ON-to-OFF transition on DTR
&G	: No guard tone
&G1	: 550 Hz guard tone
&G2	: 1800 Hz guard tone
&L	: Selects dialup (switched) line
&L1	: Selects leased line
&M	: Asynchronous mode
&M1	: Synchronous mode 1 (Sync/Async mode)
&M2	: Synchronous mode 2 (Dial Stored Number mode)
&M3	: Synchronous mode 3 (DTR control of Data/Talk)
&P	: Pulse dial make/break ratio = 39/61 (USA)

Command Codes, Continued

Command	Description
&P1	: Pulse dial make/break ratio = 33/67 (UK/HK)
&R	: CTS follows RTS
&R1	: Modem ignores RTS; CTS always ON
&T	: Terminate test in progress
&T1	: Initiate Local Analog Loopback test
&T3	: Initiate digital loopback
&T4	: Modem grants request from remote modem for RDL
&T5	: Modem denies request from remote modem for RDL
&T6	: Remote Digital Loopback test
&T7	: Initiate Remote Digital Loopback with self test
&T8	: Initiate Local Digital Loopback with self test

Register Access Codes

Register	Description
S0	: Number of rings before auto-answering a call. If set to 0, the modem will not auto-answer.
S1	: Counts incoming rings. If no ring occurs for 8 seconds, the counter is cleared to 0. The register only counts when the modem is set to auto-answer (S0 greater than 0).
S2	: Escape code character. Can be ASCII 0-127. Default is +. If S2 is greater than 127 then the escape code is completely disabled and only a call disconnection will return the modem to the command mode.
S3	: End-of-line character. This character is used to both terminate commands and to terminate status messages. Defaults to carriage return. (ASCII 13)
S4	: Line feed character. This character is output following the end-of-line after English status messages. Defaults to line feed (ASCII 10).
S5	: Backspace character. This character is typed to erase one command character and move the cursor back one space on the host screen. To erase a character, the modem first outputs a backspace, then it outputs a space and then another backspace to move over the blank. Default is backspace (ASCII 8).
S6	: Dial tone wait. Defines the pause after going off-hook (in seconds). Can't be less than 2 due to FCC regulations. Default is 2.
S7	: Time in seconds, to wait for carrier before aborting a connection attempt. Default is 30 seconds.
S8	: Length of pause, in seconds, produced by the comma command. Default is 2 seconds.
S9	: Time, in 1/10 seconds, that carrier must be present to be detected. Default is 600 milliseconds.
S10	: Time, in 1/10 seconds, between loss of carrier and disconnect. Default is 700 milliseconds. If S10 is set to 255, then the modem acts as if a carrier is always present.
S12	: Time Delay, in 1/50 seconds, required before and after an escape code. The time between the characters of the escape code must be less than the value of S12. If S12 is 0, then timing is not a factor in recognizing the escape code. Default is 1 second.

Continued on next page

Register Access Codes, Continued

Register	Description
S16	: Test mode. S16, BIT 0: Local Analog Loop - 0-Disable, 1-Enable S16, BIT 1: Not Used S16, BIT 2: Local Digital Loopback - 0-Disable, 1-Enable S16, BIT 3: Remote Digital Loopback initiated by remote modem 0- Loopback off, 1-Loopback in progress S16, BIT 4: Remote Digital Loopback - 0-Disabled, 1-Initiate Enabled S16, BIT 5: Remote Delay Loopback with test message and error count 0-Disable, 1-Enable S16, BIT 6: Local Analog Loopback - 0-Disable, 1-Enable S16, BIT 7: Not Used
S25	: Delay to DTR. Transitions on DTR that occur for less time specified by this register are ignored. DTR will only be examined after S25 has timed out.
S26	: RTS to CTS Delay Interval used in synchronous operation. Upon detection of a transition and RTS the CH1780 will wait the duration specified by this register before returning a CTS.

Note All other Registers not indicated are not used.

Dial descriptors In addition to specifying a number to dial, the following descriptors can be used with the D Command

0-9 # * A B C D	Digits and characters for dialing
@	Wait for quiet answer (no dial tone transmitted)
!	Hookflash
;	Return to command state after dialing
,	Delay processing of next character
P	Pulse dial
R	Reverse mode (for calling an originate-only modem)
S=n	Dial number stored in location "n" (0-7)
T	Tone dial
W	Wait for dial tone

Glossary

Accumulated energy	Total energy consumed since beginning of billing month.
Ampere	A unit of electrical current or rate of flow of electrons. One volt across one ohm of resistance causes a current flow of one ampere. A flow of one coulomb per second equals one ampere.
Apparent power	The product of voltage and current in a circuit in which the two reach their peaks at different times, or, in other words, there is a phase angle between voltage and current. Units are VA or some multiple thereof.
Balanced load	An alternating current power system consisting of more than two current-carrying conductors in which these current-carrying conductors all carry the same current.
Billing date	The first date in the billing monthly.
Billing demand	The demand level which a utility uses to calculate the demand charges on the current month's bill. If the rate schedule includes a ratchet clause or minimum demand charge, billing demand may or may not be the actual peak average demand for the current month.
Capacitor	A device consisting essentially of two conducting surfaces separated by an insulating material or dielectric such as air, paper, mica, plastic film, or oil. A capacitor stores electrical energy, blocks the flow of direct current, and permits the flow of alternating current to a degree dependent upon the capacitance and frequency.
Connected load	The total load which a customer can impose on the electrical system if everything was connected at one time. Connected load can be measured in horse-power, watts, or volt-amperes. Some rate schedules establish a minimum demand charge by imposing a fee per unit of connected load.
Clamp-on CT	A current transformer which clamps around a current-carrying conductor so that the conductor does not have to be opened for insertion of the transformer primary. Particularly suited for making energy surveys where current must be sensed at many points for relatively short periods.
Current transformer (CT)	An instrument transformer, intended for measuring or control purposes, designed to have its primary winding connected in series with a conductor carrying the current to be measured or controlled. Also see clamp-on CT, where the conductor itself acts as the primary. CT's step down high currents to lower values which can be used by measuring instruments. They must be used with caution.

Current transformer ratio	The ratio of primary amperes divided by secondary amperes.
Day (Daily)	Begins at 00:00:00 and ends at 23:59:59.
Demand	A measure of the customer load connected to the electrical power system at any given time. Units are usually watts, volt-amperes, or volt-ampere-reactive.
Demand charge	The charge which utilities apply to the billing demand for the current month. Units are usually dollars per kilowatt or dollars per volt or kilo-volt-ampere.
Demand-hours	The equivalent number of hours in a month during which the peak average demand is fully utilized. In other words, if energy consumption for the current month is X KWH and the peak average demand is Y kw, then the demand hours is equal to X/Y hours. The higher the number of demand hours the better the demand leveling situation and the more efficiently demand is being used. Many rate schedules have demand-hour-based energy breaks with the higher the demand-hour figure the lower the energy consumption rate in dollars per KWH.
Demand interval	Demand charges are based on peak average demand over a utility-specified time interval, not on the instantaneous demand (or connected load) at any given moment. Typical demand intervals are 15, 20, and 30 minutes, although under certain circumstances they can drop to as low as 5 minutes.
Demand-utilization efficiency	Related to demand-hours and really a measure of how successful demand leveling procedures have been. Calculated by dividing demand hours by 720, the number of hours in a 30-day billing period. Although demand-utilization efficiency depends heavily on the type of facility, in general an efficiency of 50 percent is considered average, 40 percent and lower poor, and 60 percent and higher good.
Discretionary loads	Loads which exhibit a “flywheel” effect so that removing them from the line for short periods of time does not affect business or plant operation or personal comfort. Typical are HVAC systems, hot water heaters, and snow-melt systems. These types of load provide the shed/restore capability required in power demand controller systems.
Efficiency	In general, the ratio of output power to input power expressed as a percentage. For electromechanical equipment such as motors it is very difficult to determine true efficiency under plant-floor conditions. Electric input power can be easily measured, but accurately determining mechanical output power is difficult.
Energy consumption charges	The charges a utility imposes for the consumption of real power in watts. Units are usually dollars per kilowatt-hour.

Event	A type of report that is stored in memory when either a Hi/Lo Limits trigger or an external trigger generates a report. Events can be viewed through the VIEW REPORTS option from the MAIN MENU, or they can be sent to one of the other output devices (printer or communication ports) when a certain trigger condition is met.
Event memory	Stores events (which are created when an Hi/Lo Limits trigger or external trigger generate a report).
Fuel-adjustment charges	The charges a utility imposes for changes in the cost of the fuel they use and other utility-cost factors. Frequently these charges are based on complex formulas which include many variables related to the cost of delivering electrical energy. Units are usually dollars per KWH.
Frequency	The number of recurrences of a periodic phenomenon in a unit of time. In electrical terms, frequency is specified as so many Hertz (Hz) where one Hz equals one cycle per second.
Historical memory	Stores data that is automatically saved at the end of each demand interval.
Impedance	The total opposition (i.e., resistance and reactance) a circuit offers to the flow of alternating current at a given frequency. It is measured in ohms.
Induction motor	An alternating current motor in which the primary winding (usually the stator) is connected to the power source and induces a current into a polyphase secondary (usually the rotor). Induction motors are the principal source of poor power factor problems.
Inductor	Also called an inductance or retardation coil. A conductor, wound into a spiral or coil to increase its inductive intensity, is used for introducing inductance into a circuit. An inductor retards the change of current flow through it.
Initiator pulses	Electrical impulses generated by pulse-initiator mechanisms installed in utility revenue meters. Each pulse indicates the consumption of a specific number of watts. These pulses can be used to measure energy consumption and demand.
Installed load	Equivalent to connected load.
Kilowatt-hour (KWH)	A unit of electrical measurement indicating the expenditure of 1,000 watts for one hour. Higher quantities are expressed in megawatt-hours, or the expenditure of one-million watts for one hour.
Lagging current	The current flowing in a circuit which is mostly inductive. If a circuit contains only inductance the current lags the applied voltage by 90°. Lagging current means lagging power factor of less than unity.

Leading current	The current flowing in a circuit which is mostly capacitive. If a circuit contains only capacitance the current leads the applied voltage by 90°. Leading current means leading power factor of less than unity.
Load	Any device or circuit which consumes power in an electrical system.
Load factor	A quantity related to connected load, installed load, and contracted load capacity. Utilities use load factor to establish a minimum billing demand.
Load restoring	The energization of loads that were previously removed from the line to limit load and control demand level.
Load shedding	The removal of loads from the line to limit load and control demand level.
Month (Monthly), (Billing Month or Cycle)	If Billing Dates are programmed: Begins at 00:00:00 of first date in billing month ends at 23:59:59 of last date in billing month. If Billing Dates are NOT programmed: Begins at 00:00:00 of date memory is cleared. Subsequent billing months begin on the same date every calendar month.
Neutral	The conductor used as the return path for the current from the load to the source in power measurement procedures. The neutral is frequently, but not necessarily, grounded.
Ohm	The unit of electrical resistance. One ohm is the value of resistance through which a potential difference of one volt will maintain a current flow of one ampere.
Ohm's Law	The voltage across an element of direct current circuit is equal to the current in amperes through the element multiplied by the resistance of the element in ohms.
Overflow	Type of memory that stops collecting data once the memory is full. Must be cleared to begin data collection again.
Parameter	Refers to different types of characteristic elements. In general, parameter is used to refer to the various units or value types that can be measured by the Power Platform (such as Volts, Amps, frequency, etc.). The term parameter is also used to refer to the different programmable characteristics of the unit (such as time and date, site I.D., billing dates, etc.)
Peak average demand	The highest average load over a utility specified time interval during a billing period. If there is no ratchet clause in the rate schedule then the peak average demand is also the billing demand.
Polyphase	Having or utilizing several phases. A polyphase alternating current power circuit has several phases of alternating current with a fixed phase angle between phases.

Potential transformer (PT)	An instrument transformer, the primary winding of which is connected in parallel with the circuit whose voltage is to be measured or controlled. PT's are normally used to step down high voltage potentials to lower levels acceptable to measuring instruments.
Potential transformer ratio	The ratio of primary voltage divided by secondary voltage.
Power factor	The ratio of real power in watts of an alternating current circuit to the apparent power in volt-amperes. Also the cosine of the phase angle between the voltage applied to a load and the current passing through it.
Power factor correction	Steps taken to raise the power factor by bringing the current more nearly in phase with the applied voltage. Most frequently this consists of adding capacitance to increase the lagging power factor of inductive circuits.
Power factor penalty	The charge utilities impose for operating at power factors below some rate-schedule-specified level. This level ranges from a lagging power factor of 0.80 to unity. There are innumerable different ways by which utilities calculate power factor penalties.
Present demand	Instantaneous demand updated every second.
Projected demand	Average demand for the elapsed time of the demand interval.
Pulse initiator	A device added to a revenue meter which generates pulses proportional to meter disk rotation. Each pulse represents a discrete quantity of energy consumed. Frequently the pulses are generated photoelectrically and output through mercury-wetted relays.
Q	A phantom quantity used by power companies to calculate volt-ampere-reactive (var) when there are both leading and lagging power factors. A Q-hour meter will determine varhr's when the power factors vary from 30° leading to 90° lagging. A Q-hour meter is similar to a watt-hour meter except that the voltage applied to each potential coil lags by 60° the voltage supplied to the respective watt-hour meter potential coil. This can generally be accomplished by cross-phasing, thus eliminating the need for a phase-shifting transformer. The varhr information can be calculated as follows: $\text{varhr} = (2Q \text{ hr -w hr}) / (3^{1/2})$

Ratchet clause	A rate schedule clause which states that billing demand may be based on current month peak average demand or on historical peak average demand, depending on relative magnitude. Usually the historical period is the past eleven months although it can be for the life of the contract. Billing demand is either the current month peak average demand or some percentage (75 percent is typical) of the highest historical peak average demand, depending on which is largest.
Reactance	The opposition to the flow of alternating current. Capacitive reactance is the opposition offered by capacitors and inductive reactance is the opposition offered by an inductive load. Both reactances are measured in ohms.
Reactive power	Also called wattless power and measured in volt-ampere-reactive. Reactive power increases with decreasing power factor and is the component of apparent power which does no real work in a system.
Real Power	The component of apparent power that represents true work in an alternating current circuit. It is expressed in watts and is equal to the apparent power times the power factor.
Report	A unit of information pertaining to one or more channels and parameters. Through the monitoring setups, a report can be programmed to be sent to the memory card, printer, to one of the communication ports, or to the report memory, when a certain trigger condition is met. Present values for all available report types, and any reports stored in memory, can be viewed through MAIN MENU option 2, VIEW REPORTS.
Report Memory	Stores reports that have been programmed in the monitoring setup to be saved in memory.
Resistance	The property of a substance which impedes current flow and results in the dissipation of power in the form of heat. The unit of resistance is the ohm. One ohm is the resistance through which a difference of potential of one volt will produce a current of one ampere.
Revenue meter	A meter used by a utility to generate billing information. Many types of meters fall in this category depending on the rate structure.
Root mean square (RMS)	The effective value of alternating current or voltage. The RMS values of voltage and current can be used for the accurate computation of power in watts. The RMS value is the same value as if continuous direct current were applied to a pure resistance.
Setup	Consists of a number, title, and up to 32 reports. The types of reports programmed, and the conditions that must exist for the report to be generated, are all contained in a setup. A total of 32 setups can be programmed, although only one setup can be active at a given time.

Single-phase	An alternating current circuit in which only one phase of current is available in a two-conductor or three-conductor system where the load lines are 0° or 180° out of phase.
Sliding demand interval	A method of calculating average demand by averaging the average demand over several overlapping intervals. The intervals begin a short time span (step) apart, usually about five minutes. Updating average demand at short time intervals gives the utility a much better measure of true demand and makes it difficult for the customer to obscure high short-term loads.
Time-dependent clauses	Rate schedule provisions which vary rates depending on the time of day or time of year when energy is consumed. Frequently these clauses cover both demand and energy charges. There is money to be saved by operating high loads and consuming high amounts of energy during off-peak periods when rates are lower.
Telephone Influence Factor	Telephone Influence Factor (TIF) is a dimensionless quantity which describes the potential for interference by a power circuit on a communications circuit. TIF weighting factors take into account the relative interfering effects of various frequencies in the voice band. Weighting factors are calculated under the assumption that coupling between the power and communications circuits is directly proportional to the frequency. There is no accounting for the physical orientation of the two systems.
Time-of-use period	Utility company charge rates at different times and/or dates. For example, they may charge lower rates on weekends or holidays. On weekdays, they might charge one rate between 8 am and 5 pm, another rate between 5 pm and 10 pm, and still another rate between 10 pm and 8 am.
Transformer Derating Factor (TDF)	Excessive harmonics can cause premature failure of distribution transformers. This results from high winding “hot spot” temperatures caused by power dissipation due to the presence of harmonic currents in the windings. To maintain operation of a transformer in the presence of harmonic content, a derating factor should be used. TDF is the suggested value to be used.
Trigger	A condition that causes a report to be generated. For example, reports can be programmed to be generated at certain times of the day, when a measured parameter exceeds a certain limit, or when an external impulse is received at the digital inputs.
True power	Same as real power.
Unbalanced loads	A situation existing in an alternating current system using more than two current-carrying conductors where the current is not equal in the current-carrying conductors due to uneven loading of the phases.
Volt-ampere (VA)	The unit of apparent power. It equals volts times amperes regardless of power factor.

Volt-ampere demand	Where peak average demand is measured in volt-amperes rather than watts. In this case the customer is automatically penalized for operating at any power factor less than unity.
Volt-ampere-reactive (var)	The unit of reactive power, as opposed to real power in watts. One var is equal to one reactive volt-ampere.
Volt-ampere-reactive demand	Measuring var demand is a method of penalizing for poor power factor. Multiplying total peak average var demand by some rate (dollars per var) penalizes for operating at any power factor less than unity. Frequently there is a quantity of “free” var which is determined as some percentage of the peak average watt demand. All excess var over this quantity is then billed at this dollars per var rate. Effectively this penalizes for operating below some specified power factor less than unity.
Volt-ampere-reactive-hour	The measure of the number of var's used in one hour. Var-hr and w-hr are frequently used to calculate average power factor during a billing period.
Voltage (v)	The force which causes current to flow through a conductor. One volt equals the force required to produce a current flow of one ampere through a resistance of one ohm.
Watt (w)	A measure of real power. The unit of electric power required to do work at the rate of one joule per second. It is the power expended when one ampere of direct current flows through a resistance of one ohm.
Watt demand	The usual demand billing factor where peak average demand is measured in watts or real power.
Watt-hour (wh)	A unit of electrical work indicating the expenditure of one watt of electrical power for one hour.
Wattmeter	An instrument of measuring the real power in an electric circuit. Its scale is usually graduated in watts, kilowatts, or megawatts.
Week (Weekly)	Begins at 00:00:00 on Sunday, ends at 23:59:59 on Saturday.
Wrap	Type of memory that continues to collect data when full by writing over the earlier (oldest) data it has collected. This process continues with data constantly writing over older data.

Index

A

- AC Power Source 4-5
- Alarm
 - turning on and off 7-9
- All Channels, One Parameter Screen 4-61
- Alphabetic Entry Screen 7-3
- Analyzer Status Screen 7-16
- Apparent Power
 - formula F-8
- Automatic Reports
 - definition 1-8, 8-2
 - output devices 8-3
 - select report types 8-5
 - setting 8-4
 - trigger types 8-3
 - types of 8-2
- Auto-transfer Options 7-19

B

- Battery Pack
 - replacement C-5
 - replacing fuse D-5
 - safety precautions C-3
 - specifications C-2
 - status of I-4
- Battery, Lithium C-2

C

- Calibration 1-8
- Channel Selection Screen 4-58
- Circuit Type
 - selecting 5-4
- Clear Event Memory Screen 7-10
- Communication 1-8
 - configuring local RS232 devices 11-8
 - configuring remote RS232 devices 11-17
 - device test 11-28
 - internal modem/fax 11-20
 - local RS232 11-4

- parallel printer 11-10
- remote RS232 11-14
- types of 11-1
- types of devices 11-1

- Configure I/O Menu Screen 12-5
- Copy Easy Start Thresholds Screen 6-5
- Current
 - ABC totals formula F-7
- Current Channels
 - specifications F-5
- Current Connections
 - current probe 4-22
 - current probe example 4-25
 - current transformer (CT) 4-26, 4-27
 - guidelines 4-25
 - isolated current transformers 4-28, 4-29
 - safety precautions 4-12, 4-22
 - verifying 4-34
- Current Phasors
 - viewing 4-62
- Current Probes
 - connecting 4-22
 - connection example 4-25
 - description A-4
 - specifications F-9
 - types of 4-23
- Current Transformers
 - connecting 4-26, 4-27
 - safety precautions 4-26
 - types of 4-27

D

- Date
 - setting 7-4
- DC Connector Plug
 - description I-3
- DC Power Source, External
 - making cable for I-3
- Default Settings, see factory configuration
- Delta
 - floating, connection diagram 4-42
 - floating, phasor diagram 4-47
 - high-leg, connection diagram 4-45
 - high-leg, phasor diagram 4-47

- monitoring setup for 240 volts G-9
 - monitoring setup for 480 volts G-10
 - one leg grounded, connection diagram 4-43
 - one leg grounded, phasor diagram 4-46
 - open leg, connection diagram 4-44
 - open leg, phasor diagram 4-47
 - red-legged, connection diagram 4-45
 - Digital Inputs
 - description 1-9
 - snapshot enable 6-14
 - snapshot enable configuration 6-18
 - snapshot enable connection diagram 6-16
 - start/stop 6-14
 - start/stop configuration 6-17
 - start/stop connection diagram 6-15
 - Digital Inputs Configuration Screen 6-17
 - Display, see LCD
- E**
- Easy Start
 - automatic report settings 2-8
 - description 1-6, 2-5
 - monitoring combinations 2-6
 - using 2-5, 2-6
 - Easy Start Setup
 - changing percent tolerance 2-3
 - copying 6-4
 - definition 6-4
 - listing G-11
 - parameter thresholds 2-7
 - percent tolerance range 2-3
 - percent tolerance, parameters affected 2-3
 - Edit Setup Menu 6-8
 - Enter Site/File Name Screen 7-2
 - Error Message Output Screen 7-7, 11-28
 - Error Messages
 - descriptions H-3
 - priority H-2
 - selecting output devices for 7-7
 - TASKCard 4-8, 4-9
 - Event Descriptions
 - device configured events 10-6
 - device status events 10-6
 - miscellaneous events 10-7
 - return to normal events 10-6
 - threshold events 10-5
 - Event Details
 - IEEE classifications 10-22
 - viewing 10-21
 - Event Details Screen 10-21
 - Event Monitoring
 - controlling with digital inputs 6-14
 - Event Report Screen 10-10
 - Event Waveform Data Screen 10-20
 - Event Waveform Screen 10-19
 - Event Waveforms
 - 1-cycle waveform definition 10-18
 - 3-cycle waveform definition 10-18
 - analysis of 10-20
 - viewing 10-18
 - Events
 - description 1-7
 - example event report 10-3
 - printing 10-23
 - viewing by channel 10-14
 - viewing by date and time 10-12
 - viewing by type 10-15
 - viewing complete event report 10-9
 - viewing worst case 10-16
 - External Battery Charger A-5
 - External Battery Filter
 - description I-6
 - extension cables I-7
 - installation I-8
 - External Disk Drives A-5
- F**
- Factory Configuration
 - definition 7-11
 - list of settings 7-11
 - resetting unit to 7-14
 - Fax
 - configuration 11-26
 - connection 11-25
 - specifications F-3, F-4
 - Fill and Stop 7-17
 - Format Memory Card Screen 11-30
 - Frequency Events 10-15

Frequency Synchronization
definition 5-9
entering internal frequency 5-11
loss of 5-9

Fuses
replacing battery D-5
replacing main power D-2
types of D-1

H

Handbook for Energy Management A-5
Harmonic Events 10-15
Harmonics
viewing in meter mode 4-63

I

IEEE Classifications 10-22
Input Channel Configuration Screen 5-2
Input Channels
definition 5-2
turning on and off 5-2
Internal Modem
description A-4
ISO Boxes, see isolated current transformers
Isolated Current Transformers
applications 4-29
connecting 4-28, 4-29
connecting to non-Dranetz-BMI current probe 4-32
connecting to permanently installed CT 4-30
description A-4
in-line connection 4-31
safety precautions 4-28
specifications F-10

L

Language
selecting 7-6
LCD
backlight auto-shutoff 7-9

invert mode 7-9
normal mode 7-9

M

Measurement Cable Set 4-15
Memory
clearing 7-10
Memory Card
auto-transfer 7-18
description 1-9, A-4
reading setups from 4-53
writing to 11-31
Memory Card Function Screen 4-53, 11-30, 11-31
Memory Card Readers A-5
Messages
descriptions H-3
priority H-2
Meter Mode
available parameters 4-59
description 1-6
viewing 4-59
viewing harmonics 4-63
Meter Mode Menu Screen 4-60
Modem
configuring internal 11-23
connecting external 11-14
FCC Rules and Regulations 11-20
internal 11-20
internal, specifications F-3, F-4
test 11-28
Modem/Fax Configuration Screen 11-23, 11-26
Monitoring
turning on 4-55
Monitoring Setups
changing setup name 6-10
creating custom 6-3
definition 6-1
description 1-7
predefined G-1
reading from memory card 4-53
selecting and activating 4-50
viewing 6-6

O

- One Channel, All Parameters Screen 4-60
- Optional Accessories
 - current probes A-4
 - extension cables for external battery filter I-7
 - external battery charger A-5
 - external battery filter I-6
 - external disk drives A-5
 - Handbook for Energy Management A-5
 - internal modem A-4
 - isolated current transformers A-4
 - list A-2
 - memory card A-4
 - memory card readers A-5
 - RS232 cables 11-5, A-4
 - TASKCard 8000 A-4
- Other Devices Configuration Screen 7-9, 12-4
- Overwrite 7-17

P

- Parallel Port Configuration Screen 11-13
- Parallel Printer
 - configuring 11-13
 - connection 11-10
- Parameter Thresholds
 - disabling a parameter 6-10
 - editing 6-7
 - editing identical three phase 6-8
 - editing individual channel 6-9
 - entering a harmonic number 6-11
 - ranges 6-7
 - saving 6-11
- Phasor Diagrams
 - for standard power connections 4-46
 - viewing 4-62
- Phasor Screen 4-34
- Potential Transformers
 - connecting 4-20
 - definition 4-20
 - scale factor 4-21
- Power Factor
 - formula F-8

- Power Factor Events 10-15
- Power Measurements
 - delta, one leg grounded 4-43
 - floating delta 4-42
 - four wire wye 4-41
 - high-leg delta 4-45
 - open leg delta 4-44
 - phasor diagrams 4-46
 - single phase 4-39
 - split phase 4-40
- Power Platform
 - connecting to an AC power source 4-5
 - front panel 3-2
 - installing TASKCard 4-6
 - operating on internal battery 4-5
 - operational description 1-6
 - positioning 3-8
 - rear panel 3-4
 - resetting to factory configuration 7-14
 - setting the voltage selector 4-3, 4-4
 - standard accessories 1-4
 - turning on 4-7
 - turning on monitoring 4-55

- Print Event Report Screen 10-23

Printer

- configuring external 11-13
- external, parallel 11-10
- external, serial 11-4
- internal, assembly 12-2
- internal, controls 12-3
- internal, normal operation 12-5
- internal, paper replacement 12-7
- internal, turning on and off 12-4
- specifications F-3

R

- Reactive Power
 - formula F-8
- Read Events From Memory Card Screen 10-29
- Relay Configuration Screen 8-10
- Relays
 - eight-position terminal block 8-8
 - specifications F-4
 - state 8-10

- status 8-10
- Repacking for Return Shipment B-1
- Replaceable Parts List E-1
- Reports, see automatic reports
- Reset to Factory Configuration Screen 7-14
- RS232
 - configuring local devices 11-8
 - configuring remote devices 11-17
 - direct connection diagram 11-7
 - local communication 11-4
 - optional cables 11-5, A-4
 - port description 11-4
 - port specifications F-3
 - remote communication 11-14
 - test 11-28
- RS232D Configuration Screen 11-8, 11-17
- Run Self-Test Screen 7-15

S

- Scale Factors
 - definition 5-6
 - entering 5-7
 - examples 5-6
 - for Dranetz-BMI equipment 5-6
 - range 5-7
 - when to use 5-6
- Scope Mode
 - description 1-7, 4-57
 - saving data 4-57
 - selecting channels for display 4-58
 - viewing 4-57
- Scope Mode Screen 2-2, 4-8, 4-10, 4-57
- Select Event Number Screen 10-10
- Select Events by Type Screen 10-15
- Select Parameter to Plot Screen 8-6, 9-4
- Select Report Type Screen 8-5
- Select Waveform Capture Screen 6-13
- Self-Test
 - running 7-15
- Set Automatic Reports Screen 8-4
- Set Auto-transfer to Memory Card screen 7-18
- Set Easy Start Percent Tolerance Screen 2-3
- Set Identical 3-Phase Thresholds Screen 6-8
- Set Individual Channel Thresholds Screen 6-9

- Set Interval For Timed Readings Screen 9-9
- Set Memory Storage Mode screen 7-17
- Set Scales Screen 4-64
- Set Thresholds Screen 6-6
- Set Time and Date Screen 7-4
- Set Vertical Scale 9-7
- Setup Menu Screen 4-55
- Setup Name Identifier Screen 6-10
- Single Phase
 - connection diagram 4-39
 - monitoring setup for 120 volts G-2
 - monitoring setup for 208 volts G-3
 - monitoring setup for 220 volts G-4
 - phasor diagram 4-46
- Site Name
 - entering 7-2
- Site Status Screen 7-15
- Snapshot Enable
 - configuration 6-18
 - connection diagram 6-16
 - definition 6-14
- Spare Parts E-1
- Specifications
 - computed parameters F-7
 - current probes F-9
 - general F-2
 - interfaces F-3
 - isolated current transformers F-10
 - measured parameters F-5
- Split Phase
 - connection diagram 4-40
 - monitoring setup for 120/240 volts G-5
 - phasor diagram 4-46
- Standard Accessories 1-4
 - DC connector plug I-3
 - measurement cable set 4-15
 - terminal blocks 8-8
- Start/Stop
 - configuration 6-17
 - connection diagram 6-15
 - definition 6-14

T

- TASKCard

- 8000 A-4
- error messages 4-8, 4-9
- installation 4-6
- Terminal Block
 - for relays (eight-position) 8-8
 - wire gauges 6-15
- Time
 - setting 7-4
- Time Plots - Analog Inputs Screen 9-3
- Time Plots - Digital Inputs Screen 9-11
- Transient Events 10-15
- Turn Monitoring On/Off Screen 4-55
- Turn On Procedure 4-7

V

- View Events by Channel Screen 10-14
- View Events by Date and Time Screen 10-12
- View Setups Screen 4-51
- Voltage
 - ABC totals formula F-7
- Voltage & Current Phasors Screen 4-62
- Voltage and Current Harmonics Graph Screen 4-63
- Voltage and Current Harmonics Text Screen 4-65
- Voltage Channels
 - specifications F-5
- Voltage Connections
 - neutral to ground example 4-19
 - potential transformers 4-20
 - safety precautions 4-12
 - single phase example 4-18
 - verifying 4-34
 - voltage probe 4-18
- Voltage Phasors
 - viewing 4-62
- Voltages, Under/Over Events 10-15
- Volt-Amps
 - formula F-8
- Volt-Amps Reactive
 - formula F-8

W

- Watt Events 10-15
- Watts
 - formula F-7
- Waveform Capture
 - changing a setting 6-13
 - combinations 6-12
 - definition 6-12
- Waveforms, see event waveforms
- Wiring Configuration and Scale Factors Screen
 - 5-4, 5-7, 5-11, 5-12
- Worst Case Events 10-16
- Worst Case Events Screen 10-16
- Write Data to Memory Card Screen 11-31
- Wye
 - four wire, connection diagram 4-41
 - monitoring setup for 120 volts G-6
 - monitoring setup for 120 volts w/CT-10 G-7
 - monitoring setup for 277 volts G-8

Z

- Zoom Screen 9-5