

**Anritsu** Advancing beyond

# Field Master Pro™

## High-Performance Handheld Spectrum Analyzer

### MS2090A

9 kHz to 9 GHz, 14 GHz, 20 GHz, 26.5 GHz, 32 GHz, 43.5 GHz, 54 GHz

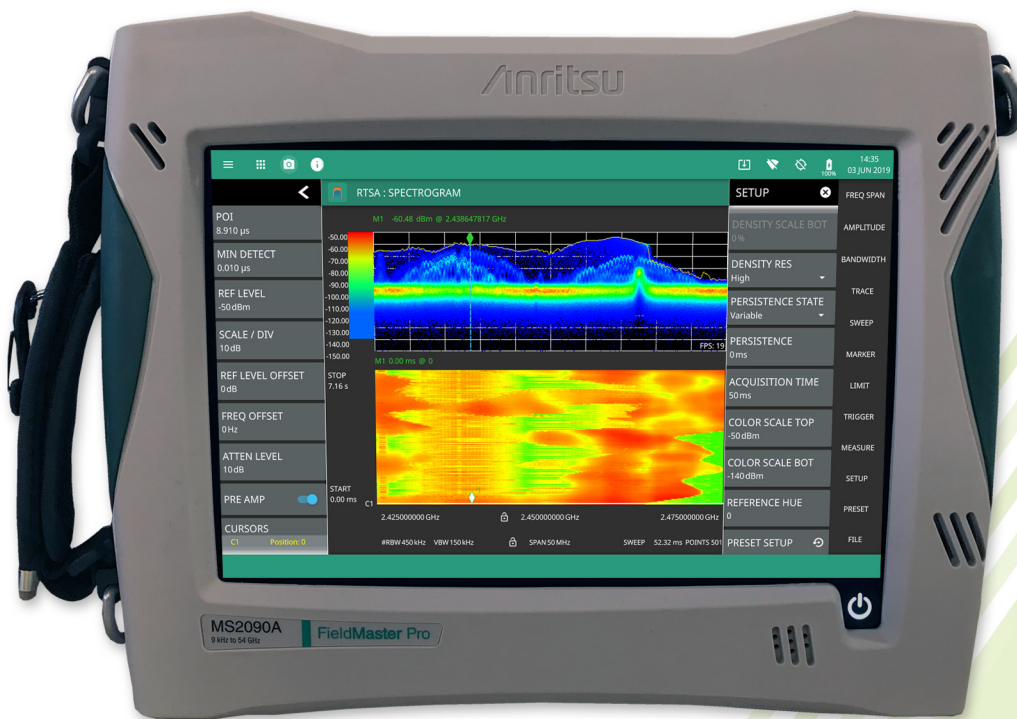

**Introduction**

Anritsu is proud to introduce the world’s most advanced handheld spectrum analyzer with real-time spectrum analysis capability. With frequency coverage up to 54 GHz, the new Field Master Pro™ MS2090A completely redefines the standards for portable handheld analyzers, setting another new industry benchmark for performance and accuracy. The new MS2090A is the culmination of over 60 years of microwave test and measurement equipment development, using the very latest technologies to deliver accuracy and precision in measurements previously reserved only for benchtop instruments.

**Instrument Highlights**

- Modulation Bandwidth: up to 110 MHz
- Dynamic Range: > 106 dB in 1 Hz RBW
- DANL: -164 dBm in 1 Hz RBW
- Phase Noise: -106 dBc/Hz @ 10 kHz offset at 1 GHz
- Resolution Bandwidth (RBW): 1 Hz up to 10 MHz
- RTSA with 2.05 μs POI
- Full-band Preamplifiers
- Operation to +55 °C: Full Performance on AC or Battery
- GNSS (GPS, GLONASS, Galileo)
- USB 3.0
- 10.1" Capacitive Touchscreen
- Two Hour Battery

**Capabilities and Functional Highlights**

Wireless Measurements

- 5G NR FDD and TDD Analyzer
- Real Time Spectrum Analyzer
- LTE FDD and TDD Analyzer
- Spectrogram
- Zero Span IF Output
- Gated Sweep
- IQ Waveform Capture/Streaming
- Pulse Profile Measurements
- AM/FM Audio Demodulation
- Electromagnetic Field (EMF) Measurements
- EIRP
- Field Strength
- Occupied Bandwidth
- Channel Power
- Adjacent Channel Power
- Spectral Emissions Mask
- Signal Strength and RSSI
- Carrier Aggregation
- Signal Mapper (MA8100A)
- Coverage Mapping
- Trace Recording/Playback

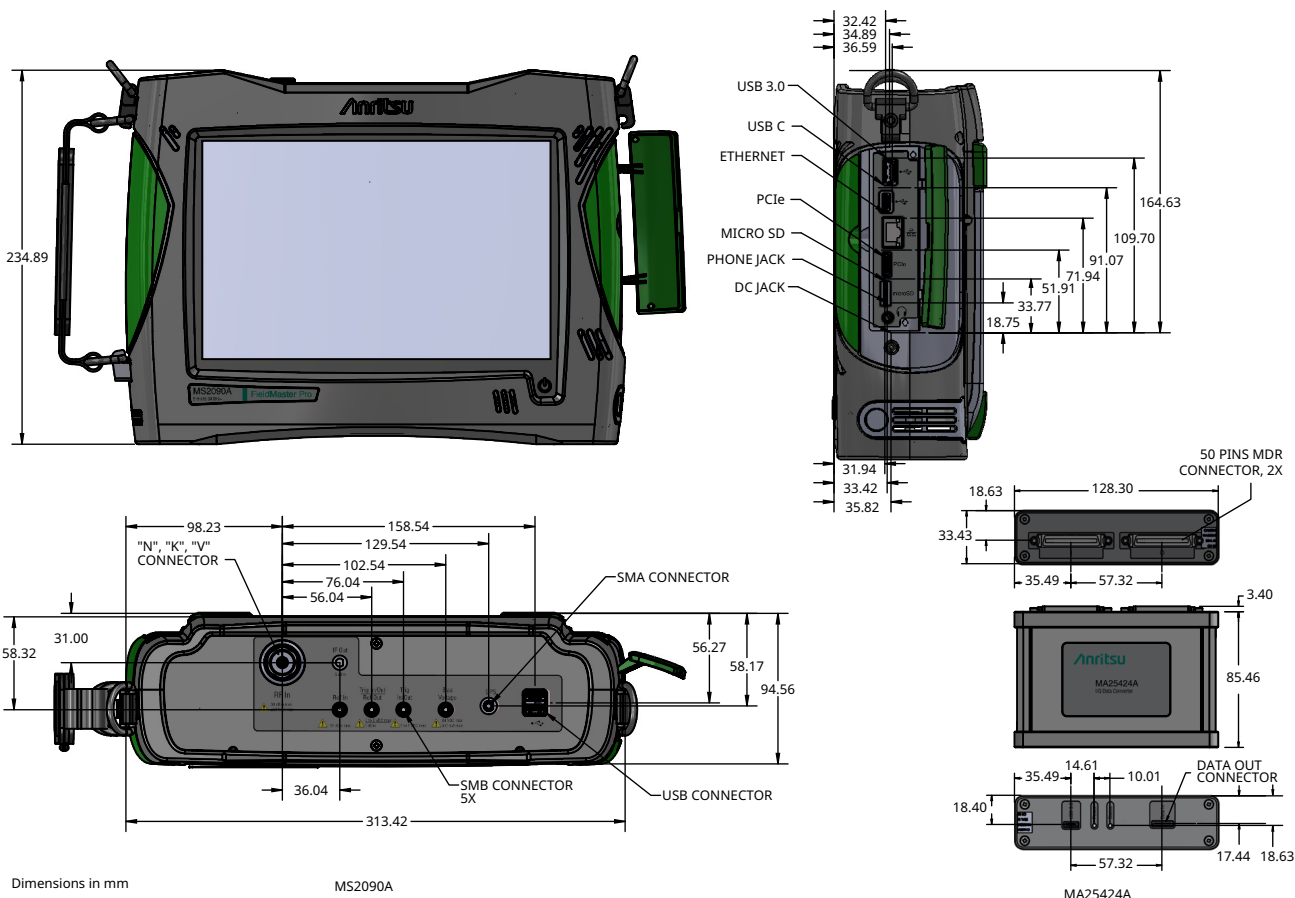

**Table of Contents**

Definitions.....3  
 Standard Spectrum Analyzer.....4  
 Real-Time Spectrum Analyzer (Option 199).....5  
 Spectrum Analyzer Performance .....6  
 Interference Finder and AM/FM Audio Demodulation (Option 24) .....8  
 GPS Receiver (Option 31) .....8  
 Zero Span IF Output (Option 89) .....8  
 Gated Sweep (Option 90) .....8  
 IQ Waveform Capture (Option 124/126) .....9  
 IQ Waveform Streaming (Option 125/127) .....9  
 Pulse Analyzer (Option 421).....10  
 Coverage Mapping (Option 431).....11  
 Electromagnetic Field (EMF) Measurement (Option 444) .....11  
 Electromagnetic Field (EMF) Meter (Option 445) .....11  
 LTE FDD/TDD Signal Analyzer (Option 883).....12  
 5G NR FDD/TDD Signal Analyzer (Option 888).....13  
 General Specifications .....14  
 Remote Interface Software .....15  
 Programmable Remote Control .....15  
 MA25424A IQ Data Converter .....16  
 MA25101A IQ Streaming PCIe Kit.....16  
 Ordering Information – Instrument Options .....17  
 Standard Accessories .....18  
 Optional Accessories.....18

**Definitions**

Specifications	All specifications and characteristics apply under the following conditions, unless otherwise stated:
Warm-Up Time	After 10 minutes of warm-up time, where the instrument is left in the ON state.
Reference Signal	When using internal reference signal.
Typical Performance	Typical specifications are not tested and are not warranted. They are generally representative of characteristic performance.
Nominal Performance	Nominal specifications are design parameters; they are not tested and are not warranted.
Uncertainty	A coverage factor of x1 is applied to the measurement uncertainties to facilitate comparison with other industry handheld analyzers.
Time Base Error	Input Frequency × Frequency Reference Error
Calibration Cycle	Calibration is within the recommended 12 month period

All specifications in this data sheet are subject to change without notice. For the most current data sheet, please visit the Anritsu web site: [www.anritsu.com](http://www.anritsu.com)

Standard Spectrum Analyzer

**Smart Measurements**

Field Strength	Measures field strength (dBm/m <sup>2</sup> , dBW/m <sup>2</sup> , dBV/m, dBmV/m, dBµV/m, V/m, W/m <sup>2</sup> , W/cm <sup>2</sup> , A/m) with antenna gain vs. frequency plot
Channel Power	Measures the total power and power spectral density within a specified bandwidth
Occupied Bandwidth	Measures the 99 % to 1 % power channel of a signal
Adjacent Channel Power	Measures the channel power of the adjacent channel
Spectral Emission Mask	Standards based limits for wireless emissions

**Setup Parameters**

Frequency	Center/Start/Stop, Frequency Step, Frequency Offset
Span	Span (Manual/Increment 1, 2, 5), Full Span, Last Span, Zero Span
Amplitude	Reference Level (Manual/Auto and Offset), Scale/Division, Y-Axis Unit (dBm, dBW, dBV, dBmV, dBµV, V, W, A), Preamp (On/Off), Attenuation (Auto/Manual)
Bandwidth	RBW/VBW (Auto/Manual), VBW Type (Linear/Logarithmic), RBW:VBW Ratio, SPAN:RBW Ratio

**Sweep Functions**

Sweep	Single/Continuous, Restart, Sweep Once, Sweep to N, Gated Sweep (see <a href="#">“Gated Sweep (Option 90)” on page 8</a> )
Sweep Points	10 to 10,001 (1001 in zero span)
Sweep Time	60 ns to 3600 s in zero span
Sweep Time Accuracy	±2 % in zero span

**Spectrogram**

Number of Lines	142
Trace Time/Position Cursor	Up to Six Cursors (display historical trace data by trace position or time)
Color Setup	Set Color Top/Bottom Range, Set Color Reference Hue

**Trace Functions**

Traces	Up to Six Traces
Trace Type	Clear/Write, Average (2 to 1000), Max Hold, Min Hold, Rolling Average, Rolling Max Hold, Rolling Min Hold
Trace Mode	Active, Hold/View, Blank
Detector Type per Trace	Peak, RMS/Avg, Negative
Trace Record	Record live samples with manual tagging to internal or external storage
Trace Playback	Play recorded samples from internal or external storage; set playback interval
CSV Logging	Record live or playback traces in CSV format for post processing

**Trigger Functions** (zero span only)

Sources	Free Run, Video, External 1, External 2, Periodic
Settings	Level, Delay, Holdoff, Slope, Hysteresis

**Marker Functions**

Markers	Up to 12 Markers
Marker Measurements	Power, Frequency, Time (Spectrogram)
Marker Mode	Normal, Delta, Fixed
Delta Marker	Relative to any Normal or Fixed Marker
Marker Function	None, Noise, Counter Marker (1 Hz, 100 mHz, 10 mHz, 1 mHz resolutions)
Marker Trace	Assign Marker to any Trace
Peak Search	Peak Search, Next Peak, Next Peak Left, Next Peak Right, Next Point Left, Next Point Right
Peak Search Setup	Peak Threshold, Peak Excursion
Marker →	Mkr → Center, Mkr → Ref Level
Marker Table	Up to 12 Markers Showing Marker Mode, Function, Trace, Frequency, Amplitude, Delta Frequency & Offset

**Limit Line Functions**

Limit Setup	Upper/Lower, Limit On/Off, Limit Alarm On/Off, Set Default Limit Line, Absolute/Relative, Mirror On/Off, Default Limit
Limit Line Edit	Frequency, Amplitude, Add Point, Add Vertical, Delete Point, Next Point Left/Right
Limit Line Move	To Current Center Frequency, By dB or Hz, To Marker 1, Offset from Marker 1
Limit Line Envelope	Create Envelope, Update Envelope, Points (41 max), Offset, Shape Square/Slope

**Real-Time Spectrum Analyzer (Option 199)**

**Setup Parameters**

Frequency	Center/Start/Stop, Frequency Step, Frequency Offset				
Span	Span, Full Span (max span: 22 MHz standard, 55 MHz with option 103, 110 MHz with option 104)				
Amplitude	Reference Level (Manual/Auto and Offset), Scale/Division, Y-Axis Unit (dBm, dBW, dBV, dBμV, V, W, A), Preamp, Attenuation (Auto/Manual)				
Bandwidth	RBW (span dependent), Auto RBW, Span:RBW Ratio				
Probability of Intercept	Analysis Bandwidth	Density Resolution	Span	RBW	POI
	20 MHz (Standard)	Normal High	22 MHz	10 MHz	2.520 μs 4.420 μs
	55 MHz (Opt. 103)	Normal High	55 MHz	25 MHz	2.210 μs 4.110 μs
	110 MHz (Opt. 104)	Normal High	110 MHz	40 MHz	2.055 μs 3.950 μs
Density Color	Set Color Top/Bottom Range, Auto Scale				
Persistence	Infinite or Variable from 0 to 10 s				
Acquisition Time	50 ms to 5 s				
FFT Rate	527,000 FFT/s (normal resolution), 263,000 FFT/s (high resolution)				
Minimum Detectable Signal	5 ns				

**Sweep Functions**

Sweep Single/Continuous, Sweep Once

**Trace Functions**

Traces	Up to Six Traces
Trace Type	Clear/Write, Average (2 to 1000), Max Hold, Min Hold, Rolling Average, Rolling Max Hold, Rolling Min Hold
Trace Mode	Active, Hold/View, Blank
Detector Type per Trace	Peak, Sample, Negative

**Spectrogram**

Trace Time/Position Cursor	Up to Six Cursors (display historical trace data by trace position or time)
Color Setup	Set Color Top/Bottom Range, Set Color Reference Hue

**Marker Functions**

Markers	Up to 12 Markers
Marker Measurements	Power, Frequency, Time (Spectrogram)
Marker Mode	Normal, Delta, Fixed
Delta Marker	Relative to any Normal or Fixed Marker
Marker Function	None, Noise
Marker Trace	Assign Marker to any Trace
Peak Search	Peak Search, Next Peak, Next Peak Left, Next Peak Right, Next Point Left, Next Point Right
Peak Search Setup	Peak Threshold, Peak Excursion
Marker →	Mkr → Center, Mkr → Ref Level
Marker Table	Up to 12 Markers Showing Marker Mode, Function, Trace, Frequency, Amplitude, Delta Frequency & Offset

**Limit Line Functions**

Limit Setup	Upper/Lower, Limit On/Off, Limit Alarm On/Off, Set Default Limit Line, Absolute/Relative, Mirror On/Off, Default Limit
Limit Line Edit	Frequency, Amplitude, Add Point, Add Vertical, Delete Point, Next Point Left/Right
Limit Line Move	To Current Center Frequency, By dB or Hz, To Marker 1, Offset from Marker 1
Limit Line Envelope	Create Envelope, Update Envelope, Points (41 max), Offset, Shape Square/Slope

**Spectrum Analyzer Performance**

**Frequency** (usable to 0 Hz)

MS2090A-0709	9 kHz to 9 GHz (Option 709)
MS2090A-0714	9 kHz to 14 GHz (Option 714)
MS2090A-0720	9 kHz to 20 GHz (Option 720)
MS2090A-0726	9 kHz to 26.5 GHz (Option 726)
MS2090A-0732	9 kHz to 32 GHz (Option 732)
MS2090A-0743	9 kHz to 43.5 GHz (Option 743)
MS2090A-0754	9 kHz to 54 GHz (Option 754)
Tuning Resolution	1 Hz
Span	10 Hz to max frequency, Zero Span
Frequency Reference	Internal, GPS, External
Internal Frequency Reference	Aging: $\pm 1.0 \times 10^{-6}$ per 10 years Accuracy: $\pm 0.3 \times 10^{-6}$ (-10 °C to 55 °C) plus aging (see "GPS Receiver (Option 31)" on page 8 for improved accuracy)
External Frequency Reference	10 MHz, 0 dBm to +10 dBm

**Bandwidth**

Analysis Bandwidth	20 MHz (standard), 55 MHz (Option 103), or 110 MHz (Option 104)
RTSA Bandwidth	22 MHz (standard), 55 MHz (Option 103), 110 MHz (Option 104)
Resolution Bandwidth (RBW)	1 Hz to 10 MHz (in RTSA, minimum RBW varies by span, max is 40 MHz)
Video Bandwidth (VBW)	0.1 Hz to 10 MHz
VBW/Average Type	Linear/Log

**Spectral Purity – SSB Phase Noise**

Offset from 1 GHz	Maximum	Typical
10 kHz	-102 dBc/Hz	-106 dBc/Hz
100 kHz	-106 dBc/Hz	-110 dBc/Hz
1 MHz	-111 dBc/Hz	-116 dBc/Hz
10 MHz	-123 dBc/Hz	-129 dBc/Hz

**Spurs** (0 dB input attenuation)

Residual Spurs (RF input terminated)	Preamp = Off	Preamp = On
< 14 GHz	-90 dBm, maximum	-100 dBm, maximum
14 to 20 GHz	-85 dBm, maximum	-100 dBm, maximum
> 20 to 32 GHz	-80 dBm, maximum	-100 dBm, maximum
> 32 to 54 GHz	-80 dBm, maximum	-95 dBm, maximum
Input-Related Spurious (-30 dBm input)	Maximum <sup>a</sup> -60 dBc	Typical -70 dBc

a. Instrument centered on single signal, span < 1.7 GHz, 0 dB input attenuation.

**Amplitude Ranges**

Dynamic Range	>106 dB minimum at 2.4 GHz, 2/3 (TOI-DANL) in 1 Hz RBW
Measurement Range	DANL to +30 dBm
Display Range	1 to 15 dB/div in 1 dB steps, ten divisions displayed
Reference Level Range	-150 dBm to +30 dBm
Attenuator Resolution	0 to 65 dB, 5 dB steps
Reference Level Offset	99.9 dB external loss to 99.9 dB external gain
Maximum Continuous Input	+30 dBm peak typical, $\pm 50$ VDC ( $\geq 10$ dB attenuation) +23 dBm peak typical, $\pm 50$ VDC ( $< 10$ dB attenuation) +10 dBm peak typical, $\pm 50$ VDC (preamp = On)

**Amplitude Accuracy** (10 dB attenuation,  $-50$  dBm  $\leq$  input signal  $\leq -10$  dBm, 1 kHz RBW, auto-coupled, excluding effects of VSWR, noise, and spurs)

	20 °C to 30 °C (after 30 minute warm-up)		-10 °C to 55 °C (after 60 minute warm-up)	
	Maximum	Typical	Maximum	Typical
9 GHz to 20 GHz Instruments				
9 kHz to 14 GHz	$\pm 1.3$ dB	$\pm 0.5$ dB	$\pm 2.0$ dB	$\pm 0.5$ dB
> 14 GHz to 18 GHz	$\pm 1.3$ dB	$\pm 0.5$ dB	$\pm 2.0$ dB	$\pm 0.5$ dB
> 18 GHz to 20 GHz	-	$\pm 1.0$ dB	-	$\pm 1.0$ dB
26.5 GHz to 54 GHz Instruments				
9 kHz to 14 GHz	$\pm 1.3$ dB	$\pm 0.5$ dB	$\pm 2.0$ dB	$\pm 0.5$ dB
> 14 GHz to 20 GHz	$\pm 1.3$ dB	$\pm 0.5$ dB	$\pm 2.0$ dB	$\pm 0.5$ dB
> 20 GHz to 43.5 GHz	$\pm 1.8$ dB	$\pm 0.5$ dB	$\pm 2.5$ dB	$\pm 0.5$ dB
> 43.5 GHz to 54 GHz	$\pm 1.8$ dB	$\pm 0.5$ dB	$\pm 2.5$ dB	$\pm 0.5$ dB

**Displayed Average Noise Level (DANL)** (RMS detection, VBW/Avg type = Log, reference level = -20 dBm for preamp Off and -50 dBm for preamp On, auto attenuation On)

	Preamp = Off		Preamp = On	
	Maximum	Typical	Maximum	Typical
9 GHz to 20 GHz Instruments				
10 MHz to 4 GHz	-145 dBm	-148 dBm	-161 dBm	-164 dBm
> 4 GHz to 9 GHz	-142 dBm	-145 dBm	-159 dBm	-162 dBm
> 9 GHz to 14 GHz	-136 dBm	-139 dBm	-156 dBm	-159 dBm
> 14 GHz to 20 GHz	-138 dBm	-144 dBm	-156 dBm	-161 dBm
26.5 GHz to 54 GHz Instruments				
10 MHz to 4 GHz	-145 dBm	-148 dBm	-161 dBm	-164 dBm
> 4 GHz to 9 GHz	-142 dBm	-145 dBm	-159 dBm	-162 dBm
> 9 GHz to 14 GHz	-136 dBm	-139 dBm	-156 dBm	-159 dBm
> 14 GHz to 20 GHz	-138 dBm	-142 dBm	-156 dBm	-159 dBm
> 20 GHz to 32 GHz	-135 dBm	-140 dBm	-154 dBm	-159 dBm
> 32 GHz to 43.5 GHz	-135 dBm	-140 dBm	-152 dBm	-154 dBm
> 43.5 GHz to 54 GHz	-130 dBm	-134 dBm	-147 dBm	-151 dBm

**Third-Order Intercept (TOI)** (-20 dBm tones 2 MHz apart, 0 dB input attenuation, preamp OFF, reference level -20 dBm)

2.4 GHz	+14 dBm minimum
50 MHz to < 9 GHz	+15 dBm typical
9 GHz to 20 GHz	+20 dBm typical
> 20 GHz to 32 GHz	+11 dBm typical
> 32 GHz to 54 GHz	+15 dBm typical

**P1dB** (nominal)

< 4 GHz	+5 dBm
4 GHz to 20 GHz	+12 dBm
> 20 GHz to 32 GHz	+7 dBm
> 32 GHz to 54 GHz	+12 dBm

**Second Harmonic Distortion** (0 dB input attenuation, -30 dBm input)

50 MHz	-75 dBc maximum
< 10 GHz	-80 dBc typical
$\geq 10$ GHz	-75 dBc typical

**VSWR** ( $\geq 10$  dB input attenuation)

< 20 GHz	1.5:1 typical
20 GHz to 54 GHz	2.0:1 typical

## Interference Finder and AM/FM Audio Demodulation (Option 24)

### Interference Finder (for use with directional antennas, sold separately)

Setup	Integration Bandwidth, Power Limit, MAX/MIN Level, Volume
Audio Tone	20 Hz to 20 kHz

### AM/FM Audio Demodulation

Demod Frequency	Full range of instrument
Audio Demodulation	AM, USB, LSB, Wideband FM, Narrowband FM
Markers	Selectable demodulation marker (1 to 12)
Audio	Toggle On/Off
Volume	Set 0% to 25%
Record Audio	Record audio up to 100,000 s (dependent on instrument memory)
Squelch Level	-120 dBm to +30 dBm (set RF level threshold to break audio silence, supports log and linear units)

## GPS Receiver (Option 31) (requires external GPS antenna, sold separately)

Supported Satellite Systems	GPS, GNSS (includes GPS, GLONASS, Galileo)
Setup	On/Off, Antenna Voltage 3.3 V/5.0 V, GPS Info
GPS Time/Location Indicator	UTC Time, Latitude, Longitude, and Altitude on display (UTC Time and Altitude on GPS Info display)
High Frequency Accuracy	< $\pm 2.5 \times 10^{-8}$ with GPS On, 3 minutes after satellite lock in selected mode (GPS antenna connected) < $\pm 5.0 \times 10^{-8}$ 24 hour holdover accuracy, -10 °C to 55 °C ambient temperature (GPS antenna disconnected)
Connector	SMA, female

## Zero Span IF Output (Option 89)

Mode	Spectrum Analyzer/Zero Span only
Center Frequency	325 MHz (nominal, FFT capture BW $\leq$ 32 MHz) 300 MHz (nominal, FFT capture BW > 32 MHz, requires Option 103 or 104)
Output Level	-4 dBm (nominal, -20 dBm input level, 0 dB input attenuation, preamp Off, 10 MHz input frequency) Spectrum is inverted in certain input RF bands.
Reference Level	-57 dBm to +30 dBm (Preamp Off) -87 dBm to -40 dBm (Preamp On)
IF Bandwidth	$\leq$ 32 MHz; $\leq$ 110 MHz with Option 103 or 104
Rise Time	<20 ns
Connector	SMB(m), 50 $\Omega$

## Gated Sweep (Option 90)

Gate Source	GPS
Frame Time	1 s, 20 ms, 10 ms
Gate Delay	up to 200 ms
Gate Length	1 $\mu$ s up to 200 ms
Power vs. Time, Display Length	100 $\mu$ s to 200 ms



**IQ Waveform Capture (Option 124/126)**

(Option 126 is non-export controlled and limits bit depth to 8 or 10 bits when bandwidth is 110 MHz)

**IQ Capture**

Mode	Spectrum Analyzer, RTSA
Capture Mode	Single or Continuous
Trigger	Free Run, External (Rising/Falling), Interval, Level
Trigger Settings	Delay (negative in RTSA mode only)
Maximum Sample Rate <sup>a</sup>	200 MHz
Maximum Signal Bandwidth <sup>a</sup>	110 MHz
Bit Resolution	8, 10, 16, or 32-bit
Total Capture Memory	2 GB

**IQ Capture Time** Typical Maximum

Signal Bandwidth (MHz)	IQ Sample Rate (MSPS)	IQ Bit Resolution				Mode <sup>a</sup>	
		32 bit	16 bit	10 bit	8 bit	SPA	RTSA
110	200	1.34 s	2.68 s	4.29 s	5.37 s	x	x
100	122.88	2.18 s	4.37 s	6.99 s	8.74 s	x	
80	100	2.68 s	5.37 s	8.59 s	10.74 s	x	x
74	92.16	2.91 s	5.83 s	9.32 s	11.65 s	x	
50	61.44	4.37 s	8.74 s	13.98 s	17.48 s	x	
40	50	5.37 s	10.74 s	17.18 s	21.47 s	x	x
36	46.08	5.83 s	11.65 s	18.64 s	23.3 s	x	
25	30.72	8.74 s	17.48 s	27.96 s	34.95 s	x	
20	25	10.74 s	21.47 s	34.36 s	42.95 s	x	x
18	23.04	11.65 s	23.30 s	37.28 s	46.6 s	x	
12	15.36	17.48 s	34.95 s	55.92 s	1.17 min	x	
10	12.5	21.47 s	42.95 s	1.15 min	1.43 min	x	x
6	7.68	34.95 s	1.17 min	1.86 min	2.33 min	x	
5	6.25	42.95 s	1.43 min	2.29 min	2.86 min	x	x
3	3.84	1.17 min	2.33 min	3.73 min	4.66 min	x	
2.5	3.125	1.43 min	2.86 min	4.58 min	5.73 min	x	x
1.5	1.92	2.33 min	4.66 min	7.46 min	9.32 min	x	
1.25	1.5625	2.86 min	5.73 min	9.16 min	11.45 min	x	x
0.28	0.36	12.43 min	24.86 min	39.77 min	49.71 min	x	
0.036	0.045	99.42 min	198.84 min	318.15 min	397.68 min	x	

a. Option Dependent: Standard Analysis Bandwidth up to 20 MHz, Option 103 up to 55 MHz, Option 104 up to 110 MHz.

**IQ Waveform Streaming (Option 125/127)**

(requires Option 124 or 126; Option 127 is non-export controlled and limits streams to 100 MHz BW or less.)

Bit Resolution	8, 10, 16, or 32-bit
Ethernet Port	Maximum gapless bandwidth depends on network transfer speed
USB Port	Requires USB 3.0 solid state drive. Device formatted as external file system (ext4). Maximum gapless streaming bandwidth: 8 bit: 100 MHz BW, 122.88 MSPS sample rate 10 bit: 80 MHz BW, 100 MSPS sample rate 16 bit: 50 MHz BW, 61.44 MSPS 32 bit: 25 MHz BW, 30.72 MSPS Device formatted as extensible file allocation table system (exFAT) with 32 MB allocation unit size. Maximum gapless streaming bandwidth: 8 bit: 80 MHz BW, 100 MSPS sample rate 10 bit: 50 MHz BW, 61.44 MSPS sample rate 16 bit: 40 MHz BW, 50 MSPS sample rate 32 bit: 20 MHz BW, 25 MSPS sample rate
Data Out Port	Gapless streaming of 110 MHz bandwidth at 16-bit resolution or 100 MHz bandwidth at 32-bit resolution (requires MA25101A IQ Streaming PCIe kit and compatible PC) Stream to Bird IQC5000B at 16-bit resolution only, full bandwidth/sample rate (requires MA25424A receiver)

**Pulse Analyzer (Option 421)**

**Pulse Measurements** (in accordance with *IEEE Standard for Transitions, Pulses, and Related Waveforms* (181-2011, section 5.2.1))

Power Measurements	Average, Peak, Wave Average, Peak Wave Average, Pulse Average
Pulse Characteristics	Duration, Center, Tilt, Period, Off Time, Duty Factor, Frequency
First Transition Characteristics	Transition Duration, Duration Instant, Low Reference Instant, High Reference Instant, Pre Transition Overshoot, Post Transition Overshoot, Pre Transition Undershoot, Post Transition Undershoot
Second Transition Characteristics	Transition Duration, Duration Instant, Low Reference Instant, High Reference Instant
Pulse View Settings	Pulse Analyzer (enables pulse analyzer measurements above), Pulse Viewer (removes pulse analyzer measurements and enables standard marker measurements)
Rise Time	(trace averages set to 100; RBW:VBW = 1) 30 ns, 40 MHz RBW (Option 104) 60 ns, 25 MHz RBW (Option 103) 100 ns, 10 MHz RBW (Standard)

DANL and dynamic range are the same as the Spectrum Analyzer Performance.

**Setup Parameters**

Frequency	Center, Step Size, Offset
Amplitude	Reference Level (Manual/Auto and Offset), Sale/Division, Y-Axis Unit (dBm, dBW, dBV, dBmV, dBμV, dBA), Preamp, Attenuation (Auto/Manual)
Bandwidth	RBW/VBW (Auto/Manual), VBW Type (Linear/Logarithmic), RBW:VBW Ratio, SPAN:RBW Ratio
Pulse Setup	Pulse Level Type (Auto/User) User TOP (S2), User BOTTOM (S1), Pulse Reference High (%), Pulse Reference Low (%), Pulse Duration Reference (%)

**Trace Functions**

Traces	Up to Six Traces
Trace Type	Clear/Write, Min Hold, Max Hold, Average, Rolling Max Hold, Rolling Min Hold, Rolling Average
Trace Mode	Active, Hold/View, Blank
Detector Type per Trace	Peak, Negative, Sample

**Sweep Functions**

Sweep	Single/Continuous, Restart, Sweep Once, Sweep to N, Sweep Time
Sweep Points	1001
Sweep Time	60 ns to 3600 s
Sweep Time Accuracy	±2 %

**Marker Functions** (enabled only in Pulse Viewer)

Markers	Up to 12 Markers
Marker Measurements	Power, Time
Marker Mode	Normal, Delta, Fixed
Delta Marker	Relative to any Normal or Fixed Marker
Marker Function	None, Noise
Marker Trace	Assign Marker to any Trace
Peak Search	Peak Search, Next Peak, Next Peak Left, Next Peak Right, Next Point Left, Next Point Right
Peak Search Setup	Peak Threshold, Peak Excursion
Marker →	Mkr → Center, Mkr → Ref Level
Marker Table	Up to 12 Markers Showing Marker Mode, Function, Trace, Time, Amplitude, Delta Time & Offset

**Trigger Functions**

Sources	Free Run, Video, External 1, External 2
Settings	Level, Delay, Holdoff, Periodic, Slope, Hysteresis
Trigger Jitter	20 ns

**Pulse Simulation** Provides visual and measurement data of simulated pulse types.

Waveform Types	Single Positive, Single Negative, Train, Double
Settings	Amplitude (High and Low), Period, Duty Factor

**Coverage Mapping (Option 431)** (Spectrum Analyzer Only)

**Measurements**

Channel Power	Plots channel power in dBm, dBW, dBV, dBmV, dBµV, dBA, V, W, A
Spectral Density	Plots spectral density in dBm/Hz, dBW/Hz, dBV/Hz, dBmV/Hz, dBµV/Hz, dBA/Hz, V/Hz, W/Hz, A/Hz
RSSI	Plots received signal strength indicator in dBm, dBW, dBV, dBmV, dBµV, dBA, V, W, A
Field Strength	Plots field strength in dBm/m <sup>2</sup> , dBW/m <sup>2</sup> , dBV/m, dBmV/m, dBµV/m, dBA/m, V/m, W/m <sup>2</sup> , W/cm <sup>2</sup> , A/m <sup>2</sup>
Power Flux Density	Plots power flux density in dBm/m <sup>2</sup> /Hz, dBW/m <sup>2</sup> /Hz, dBV/m/Hz, dBmV/m/Hz, dBµV/m/Hz, dBA/m/Hz, V/m/Hz, W/m <sup>2</sup> /Hz, W/cm <sup>2</sup> /Hz, A/m/Hz

**Measurement Setup**

Map Type	Indoor: PNG or JPEG Outdoor: OpenStreetMap® (downloaded direct from Internet to instrument or using external PC software)
Frequency (Excluding RSSI)	Center/Start/Stop, Frequency Step, Frequency Offset
Span (Excluding RSSI)	Span (Manual/Increment 1, 2, 5), Full Span, Last Span, Zero Span
Amplitude	Reference Level (Manual/Auto and Offset), Scale/Division, Y-Axis Unit, Preamp, Attenuation (Auto/Manual)
Bandwidth	RBW/VBW (Auto/Manual), VBW Type (Linear/Logarithmic), RBW:VBW Ratio, SPAN:RBW Ratio
Mapping Colors	Customizable Amplitude Range Thresholds for Each Color Blue (Excellent), Green (Very Good), Yellow (Good), Orange (Fair), Red (Poor)
Point Distance or Time Setup	Repeat Type: Time (1 s to 60 s) or Distance (1 m to 10,000 m), Distance Units: Meters or Feet
Save	Setup, KML Points, PNG, Tab Delimited
Recall	Setup, KML Points File

**Electromagnetic Field (EMF) Measurement (Option 444)** (requires a supported antenna)

The Spectrum Analyzer mode provides electromagnetic field strength measurements in three axis (X, Y, Z) with trace displays for each measurement and tabular results.

**Measurements/Settings**

Setup	Limit lines, Axis Dwell Time, Measurement Time, Measurement Count, Measurement Units, Data Logging with storage location
Units	dBm/m <sup>2</sup> , dBW/m <sup>2</sup> , dBV/m, dBmV/m, dBµV/m, V/m, W/m <sup>2</sup> , W/cm <sup>2</sup> , A/m
Results	Maximum, Minimum, and Average of all measurements conducted
Displayed Information	Measurement progress, number of measurements taken, Pass/fail indicators

**Frequency Range**

Supported Antenna	
2000-1800-R	9 kHz to 300 MHz
2000-1792-R	30 MHz to 3 GHz
2000-1791-R	700 MHz to 6 GHz

**Electromagnetic Field (EMF) Meter (Option 445)** (Requires a supported probe)

The EMF Meter mode provides electromagnetic field strength measurements in three axis (X, Y, Z) with bar graph for each measurement and tabular results.

**Measurements/Settings**

Limit	Standard (FCC Public, ICNIRP Public, ICNIRP Worker), Limit Mode (Lowest, Frequency), Alarm, Volume, Mute, Preset Supports the International Commission on Non-Ionizing Radiation Protection limit (ICNIRP)
Measure	Selected sample (1 through 16), start sampling, clear results
Setup	EMF Meter Calibration, Display probe info
Units	mW/cm <sup>2</sup>
Preset	Preset Mode
Setup File	Quick save, Save As, Recall (.stp file type)
Results (%)	Maximum, Minimum, and Average of all samples (1 through 8)
Display	Bar graph of each sample (1 through 16) with Standard Limit Line, Time (mm:ss)

**Frequency Range**

Supported Probe	
2000-1985-R	Isotropic EMF Probe, 20 MHz to 40 GHz (refer to data sheet 11410-01185)

LTE FDD/TDD Signal Analyzer (Option 883)

<b>General</b>		
Frequency Range	10 MHz to 54 GHz (option dependent)	
Channel Bandwidth (MHz)	1.4, 3, 5, 10, 15, 20	
Amplitude	Auto Range, Reference Level, Scale/Division, Reference Level Offset	
Input Signal Range	-76 dBm to +10 dBm (≤20 GHz) -72 dBm to +10 dBm (>20 GHz)	
Sweep	Single/Continuous	
MIMO Antenna Setup	Auto, Antenna 1, 2, 3, or 4	
<b>LTE Demodulation Summary</b>		
PCI Summary Measurements	Physical Cell ID, Sector ID, Cell Group, Frequency Error, Time Offset, Cyclic Prefix, Status of Primary Synchronization Signal (PSS), MIMO Time Alignment Error, Resource Block Power	
Signal Power Measurements (dBm)	Physical Broadcast Channel Power (PBCH), Sync Signal (SS), Reference Signal (RS), OFDM Symbol Transmit Power (OSTP)	
Error Vector Magnitude Measurements (%)	Physical Broadcast Channel (QPSK), Physical Downlink Shared Channel (QPSK), PDSCH (16-QAM/64-QAM/256-QAM)	
Demod Summary View	PCI, Sector ID, Cell Group, Frequency Error, Time Offset, Cyclic Prefix, Sync Status, Power (PBCH, SS, RS), EVM (PBCH(QPSK), PDSCH (QPSK, 16-QAM, 64-QAM, 256-QAM))	
Time Alignment Error (TAE) View	PCI, Sector ID, Cell Group, Frequency Error, Time Offset, Cyclic Prefix, Sync Status, TAE between each antenna pair, Power (RS, SS), EVM (RMS, PEAK)	
Resource Block View	PCI, Sector ID, Cell Group, Frequency Error, Time Offset, Cyclic Prefix, Sync Status, RB (number of active RBs, Utilization, OSTP), EVM (QPSK, 16-QAM, 64-QAM, 256-QAM)	
Setup Parameters	Antenna (Auto/1/2/3/4), Cyclic Prefix (Auto/Normal/Extended), Duplex Type (FDD/TDD), UL/DL Config (TDD only), CFI (Auto/CFI1/CFI2/CFI3)	
RS Power Accuracy	± 1.0 dB typical (RF input -50 dBm to +10 dBm)	
Frequency Error	± 10 Hz + time base error (99 % confidence level)	
Residual EVM (rms)	2.0 % typical (E-UTRA Test Model 3.1, RF Input -50 dBm to +10 dBm)	
<b>LTE Multi PCI</b>		
Measurements	Multiple Physical Cell IDs, Secondary Sync Signal Power (S-SS), Reference Signal Received Power (RSRP), Reference Signal Received Quality (RSRQ), Signal to Interference and Noise Ratio (SINR), Average Error Vector Magnitude (EVM), Peak EVM, Frequency Error (Hz and PPM), Dominance	
Graph Displays	PCI, SINR, RSRP, RSRQ, SS Power	
Setup Parameters	Cyclic Prefix (Auto/Normal/Extended), Duplex Type (FDD/TDD), UL/DL Config (TDD only), CFI (Auto/CFI1/CFI2/CFI3)	
<b>Channel Power</b>		
Measurements	Total Channel Power, Total Power Spectral Density (PSD), Limit Test (Power and PSD)	
Setup Parameters	Integration Bandwidth, PSD Units (Hz/MHz), Power Limit (dBm), PSD Limit (dBm/Hz)	
RF Channel Power Accuracy	± 1 dB typical (-50 dBm to +10 dBm)	
<b>Channel Spectrum</b>		
Measurements	Occupied Bandwidth (OBW), Total Power, Occupied Bandwidth, Limit Test (OBW)	
Setup Parameters	OBW Power (%/dB), OBW Limit (Hz), Method (%/x dB)	
<b>Carrier Aggregation</b>		
PCI Measurements	Physical-layer Cell ID (PCI), RS Power, EVM (% rms), Frequency Error (Hz)	
Setup Parameters	Carrier Count (up to eight), Antenna (Auto/1/2/3/4), Cyclic Prefix (Auto/Normal/Extended), Duplex Type (FDD/TDD)	
<b>Control Channel</b>		
PCI Summary Measurements	Physical Cell ID, Sector ID, Cell Group, Frequency Error, Time Offset, Cyclic Prefix, Status of Primary Synchronization Signal (PSS)	
Power Measurements	Reference Signal (RS), P-Primary Synchronization Signal (P-SS), Secondary Synchronization Signal (S-SS), Physical Broadcast Channel (PBCH), Physical Control Format Indicator Channel (PCFICH), Physical Hybrid Automatic Repeat Request Indicator Channel (PDCCCH), Physical Downlink Control Channel (PDCCH), Total Power per Resource Element and Power (dBm/watts), EVM (%)	
Setup Parameters	Antenna (Auto/1/2/3/4), Cyclic Prefix (Auto/Normal/Extended), Duplex Type (FDD/TDD), UL/DL Config (TDD only), NG (1/6, 1/2, 1, 2)	
<b>Constellation</b>		
Measurements	Constellation Display of PBCH or PDSCH	
Setup Parameters	Antenna (Auto/1/2/3/4), Cyclic Prefix (Auto/Normal/Extended), Duplex Type (FDD/TDD), UL/DL Config (TDD only), CFI (Auto/CFI1/CFI2/CFI3), Modulation (PBCH/PDSCH), Data Format (All/QPSK/16-QAM/64-QAM/256-QAM)	
<b>Frame Power</b>		
Measurements	Power vs. Time Display, Power of Frame, Sub-Frame, Slot (0 and 1), Uplink and Downlink Pilot Time Slots (DwPTS and UpPTS), and Transmit Off Power.	
Setup Parameters	Analysis (Frame/Subframe/Slot), SSF Config (Auto/0-9), Sub-Frame (0-9), Slot (1/2) Antenna (Auto/1/2/3/4), Cyclic Prefix (Auto/Normal/Extended), Duplex Type (FDD/TDD), UL/DL Config (TDD only), NG (1/6, 1/2, 1, 2)	

**5G NR FDD/TDD Signal Analyzer (Option 888)**

**General**

Frequency Range	10 MHz to 54 GHz (option dependent)
Band Configuration	Manual or selectable Band #, Absolute Radio Frequency Channel Number (ARFCN), Global Synchronization Raster Channel (GSCN), Channel Bandwidth (5 MHz to 100 MHz in steps of 5 MHz), SSB Offset, Subcarrier Spacing (15, 30, 60, 120, 240 kHz), Mapping Pattern (Auto, P1, P2), Auto SSB Detect
Auto SSB Detect	Searches 3GPP defined GSCN raster
Amplitude	Auto Range, Reference Level, Scale/Division, Reference Level Offset, Attenuation Level (Auto/Manual), Preamp
Input Signal Range	-76 dBm to +10 dBm (≤20 GHz) -72 dBm to +10 dBm (>20 GHz)
Sweep	Single/Continuous, Sweep Once

**5G NR Demod Summary**

Multi-Beam Measurements	Physical-layer Cell ID, Beam Index, Sector ID, Cell Group, Frequency Error, Time Offset, SS-RSRP (dBm), SS-RSRQ (dB), SS-SINR (dB), Sync and Demod Status Indicators, Beam Power (dBm)
Single-Beam Measurements	Physical Cell ID, Sector ID, Cell Group, Frequency Error, Time Offset, SS-RSRP (dBm), SS-RSRQ (dB), SS-SINR (dB), Sync and Demod Status Indicators, Block Measurements (PSS, SSS, PBCH, PBCH-DMRS), Average EVM, Peak EVM (@ subcarrier/symbol), Beam Power (dBm)
Views	Multi Beam (up to 64), Single Beam
Setup Parameters	SINR Threshold (dB), Duplex Type (FDD/TDD)
RSRP Accuracy	± 1.0 dB typical
Residual EVM (rms)	2.0 % typical
Frequency Error	< ± 2.0E-8 + time base error, typical

**5G NR Multi PCI**

Measurements	Multiple Physical-layer Cell IDs, Beam Index, SS-RSRP (dBm), SS-RSRQ (dB), SS-SINR (dB), SS-EVM (%) Beam Power (dBm)
Views	Multi PCI Beam Scanner (up to 64 beams), Table
Setup Parameters	SINR Threshold (dB), Duplex Type (FDD/TDD)

**5G NR RF EIRP**

Measurements	EIRP (Active, Horizontal/Vertical, Sum), Upper/Lower Limit Test
Views	Normal (RF spectrum), Quick View (summary)
Setup Parameters	Save (Horizontal/Vertical), Reset Sum, RX Antenna Gain, Distance to Antenna, Units (Meters/Feet), Upper/Lower Limit Test, RX Cable Loss

**5G NR RF Occupied Bandwidth**

Measurements	Occupied Bandwidth, Total Power, x dB Bandwidth, Tx Frequency Error, Limit Test
View	Normal (RF Spectrum)
Setup Parameters	Method: OBW Power (% and X dB), OBW Limit Test

**5G NR RF Channel Power**

Measurements	Total Channel Power, Total PSD, Limit Test
View	Normal (RF Spectrum)
Setup Parameters	Integration Bandwidth, PSD Units, Power and PSD Limit Tests
RF Channel Power Accuracy	± 1 dB typical (-76 dBm to +10 dBm)

**5G NR Carrier Aggregation**

Component Carriers	Up to Eight Component Carriers
PCI Measurements	Sync status (PSS), Physical-layer Cell ID (PCI), RSRP Max, EVM (% rms), Frequency Error (Hz), Time Offset
Setup Parameters	Carrier Count (up to 8), Duplex Type (FDD/TDD)

**5G NR Constellation**

Measurements	Constellation Display of PBCH
Setup Parameters	Modulation (QPSK), Data Format (PBCH), Beam Select, Reference Points

## General Specifications

### Setup Parameters

Date and Time	Date and Time settings, Time Zone settings, Time synced to Internet/GPS
Languages	English
Display	Brightness adjustment, Auto screen dimming shutoff timer (on/off), Color schemes (Standard, Inverted)
Screen Shot Settings	Image capture size, Image header/footer
Option Configuration	Enable options using file (USB)
GPS	see <a href="#">"GPS Receiver (Option 31)" on page 8</a>
Ethernet	Ethernet (IP4 & IP6 formats), Type (DHCP, Static)
WLAN (Wi-Fi)	2x2 MIMO, 802.11 a/b/g/n/ac, On/Off, Auto detect wireless networks
Reset	Factory Reset, Delete All User Files, Delete System Files, Master Reset, Diagnostics
Diagnostics	Self Test, Service Tools, exportable event and system error logs
Save/Recall	Measurement Setup, Screenshot Image (.PNG), Export Measurement data (Text, CSV), Location
File Management	Save, Copy, Paste, Delete, Create New Folder, Set File Name and File Type, Rename

### Connectors

RF In	MS2090A-0709, -0714, -0720: Type N(f), 50 Ω MS2090A-0726, -0732, -0743: Ruggedized Type K(m), 50 Ω MS2090A-0754: Ruggedized Type V(m), 50 Ω
GPS	SMA(f)
External Power	5.5 mm barrel connector, 13.5 to 17.5 VDC, 5.0 A max
Ethernet Interface	RJ45 connector for Ethernet 10/100/1000 Mbps (connect to PC or LAN for remote access and IQ streaming)
USB Interface	USB 3 Type A (supports file transfer and IQ capture/streaming) USB 3 Type C (USB-TMC)
Headset Jack	3.5 mm 3-wire headset jack (functionality supported in future software update)
External Reference In	SMB(m), 50 Ω, maximum input +10 dBm
External Reference Out	SMB(m), 50 Ω, 10 MHz
External Trigger	SMB(m), 50 Ω, TTL-compatible levels, maximum input +5 VDC
IF Out	SMB(m), 50 Ω (see <a href="#">"Zero Span IF Output (Option 89)" on page 8</a> )
DC Bias Voltage	SMB(m), Setup: On/Off, Voltage, Trip Reset Voltage Range: +1 V to +34 V, Resolution: 0.1 V Max Current: 1 A, Max Power: 15 W

### Display and Keyboard

Display	10.1 inch capacitive touchscreen, 1280 x 800 resolution
Screen Strength	IK08 (protected against a 5 joule impact)
Keyboard	Common alphanumeric/symbolic keys and customizable EZ keyboard
Touch Gestures	Pinch to zoom x (span), Drag in x (center frequency, markers, limit line points)
Toolbar	System menu, application drawer, shortcuts, screen capture, lock status (touchscreen), notification bar, Wi-Fi status, GPS status, battery status, time and date

### Battery

Type	Li-Ion
Battery Operation	Two hour operation, typical
Charging Temperature Limit	0 °C to +45 °C, relative humidity ≤ 80 %

**Regulatory Compliance**

European Union	EMC 2014/30/EU, EN 61326-1:2013, CISPR 11/EN 55011, IEC/EN 61000-4-3/4/5/6/8/11 Low Voltage Directive 2014/35/EU Safety EN 61010-1:2010 RoHS Directive 2011/65/EU
Australia and New Zealand	RCM AS/NZS 4417:2012
South Korea	KCC-REM-A21-0004
Canada	ICES-3(A)/NMB-3(A) ICES-1(A)/NMB-1(A) with Option 6
United States	FCC ID: SQG-60SIPT

**Environmental**

	MIL-PRF-28800F Class 2
Operating Temperature Range	-10 °C to 55 °C
Storage Temperature Range	-51 °C to 71 °C
Maximum Relative Humidity	95 % RH at 30 °C, non-condensing
Vibration, Sinusoidal	5 Hz to 55 Hz
Vibration, Random	10 Hz to 500 Hz
Half Sine Shock	30 g <sub>n</sub>
Altitude	4600 meters, operating and non-operating
Explosive Atmosphere	MIL-PRF-28800F Section 4.5.6.3 MIL-STD-810G, Method 511.5, Procedure 1

**Warranty**

Duration	Standard three-year warranty One-year warranty on battery
----------	--

**Size and Weight**

Size	314 mm x 235 mm x 95 mm, (12.4 in x 9.25 in x 3.74 in)
Weight	MS2090A-0709, -0714, -0720: 5.06 kg (11.15 lb) MS2090A-0726, -0732, -0743, -0754: 5.4 kg (11.9 lb)

**Remote Interface Software**

Functionality	Free MS2090A software download from <a href="http://www.anritsu.com">www.anritsu.com</a> Full instrument graphical user interface control from a PC with simulated hardware support for on-screen measurement analysis
Interfaces	Ethernet, WLAN

**Programmable Remote Control**

Functionality	Full instrument programming control (except power on/off) via Ethernet and WLAN connectivity. See the Programming Manual for details.
Programming Language	Standard Commands for Programmable Instruments (SCPI)
Interfaces	Ethernet, WLAN, USBTMC (USB C port)

**MA25424A IQ Data Converter** (requires Options 124 and 125 or Options 126 and 127)

**IQ Streaming** (used for streaming IQ data components of a waveform from the MS2090A Data Out port to an IQC5000)

Shipping Contents	MA25424A Module PCIe OCuLink I/O Data Cable USB 3.0 Type A to Type C Cable
Mode	Spectrum Analyzer, RTSA
Input Ports	Data In (PCIe), USB (for power)
Output Port	IEEE 1284-C, 50 pin
Data Throughput	200 MSPS @ 16 bit max
Power Consumption	3.33 W (USB 3.0)

**Warranty**

Duration	Standard three-year warranty
----------	------------------------------

**Size and Weight**

Size	128.3 mm x 33.43 mm x 88.86 mm
Weight	377 g (including cables)

**MA25101A IQ Streaming PCIe Kit** (requires Option 125 or Option 127)

**IQ Streaming** (used for streaming IQ data components of a waveform from the MS2090A Data Out port to a PC)

Shipping Contents	PCIe Computer Card with mounting hardware PCIe OCuLink I/O Data Cable
Software	MX280006A IQ Acquisition Tool (download from <a href="http://www.anritsu.com">www.anritsu.com</a> )
Mode	Spectrum Analyzer and RTSA
Input Ports	Data In (PCIe) (use PC Ethernet for instrument control and low speed IQ data streaming)
Data Rate	>800 MB/s max; 110 MHz @ 16 bits max

**Warranty**

Duration	90 day warranty
----------	-----------------



Ordering Information – Instrument Options

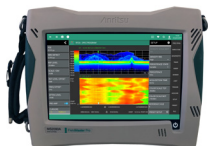





Part Number	Description
MS2090A	Field Master Pro (Requires Option 709, 714, 720, 726, 732, 743, or 754)
<b>Options</b>	
MS2090A-0709	Frequency Range 9 kHz to 9 GHz
MS2090A-0714	Frequency Range 9 kHz to 14 GHz
MS2090A-0720	Frequency Range 9 kHz to 20 GHz
MS2090A-0726	Frequency Range 9 kHz to 26.5 GHz
MS2090A-0732	Frequency Range 9 kHz to 32 GHz
MS2090A-0743	Frequency Range 9 kHz to 43.5 GHz
MS2090A-0754	Frequency Range 9 kHz to 54 GHz
MS2090A-0006	Remove Wi-Fi
MS2090A-0024	Interference Finder (requires directional antenna, sold separately)
MS2090A-0031	GPS Receiver (requires GPS antenna, sold separately)
MS2090A-0089	Zero Span IF Output
MS2090A-0090	Gated Sweep
MS2090A-0103	55 MHz Analysis Bandwidth
MS2090A-0104	110 MHz Analysis Bandwidth
MS2090A-0124	IQ Waveform Capture
MS2090A-0125	IQ Waveform Streaming (requires Option 124, MA25424A recommended)
MS2090A-0126	IQ Waveform Capture (non-export controlled)
MS2090A-0127	IQ Waveform Streaming (non-export controlled, requires Option 126, MA25424A recommended)
MS2090A-0128	Vector Signal Analysis Enabled (requires Option 124 or 126; use with MX280005A software)
MS2090A-0199	Real Time Spectrum Analyzer
MS2090A-0400	Vision Monitor Enabled
MS2090A-0407	Vision High-Speed Port Scanner Enabled
MS2090A-0421	Pulse Analyzer
MS2090A-0431	Coverage Mapping (requires GPS option MS2090A-0031)
MS2090A-0444	EMF Measurement (requires a compatible Anritsu isotropic antenna)
MS2090A-0445	EMF Meter Enabled (requires 2000-1985-R isotropic EMF probe)
MS2090A-0883	LTE FDD/TDD Measurements (requires GPS option MS2090A-0031)
MS2090A-0888	5G NR FDD/TDD Measurements (requires GPS option MS2090A-0031)
MS2090A-xxxx-0097	Accredited Calibration to ISO17025 and ANSI/NCSL Z540-1 (xxxx is the frequency option number)
MS2090A-xxxx-0098	Standard Calibration to ISO17025 and ANSI/NCSL Z540-1 (xxxx is the frequency option number)
MS2090A-xxxx-0099	Premium Calibration to ISO17025 and ANSI/NCSL Z540-1 plus test data (xxxx is the frequency option number)

**Standard Accessories** (included with instrument)

Accessory	Description
	3-2000-1928 Shoulder Strap
	2000-1931-R Stylus with replaceable fiber tip
	633-75 Li-Ion Battery
	40-204-R AC/DC Power Supply (Field Master Series)
Certificate of Calibration and Conformance	

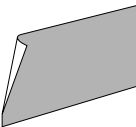

Accessory	Description
	2000-1371-R Ethernet Cable, 2 m
	2000-1859-R USB Cable, USB 3.0 Type-A to Type-C, 1 m
	806-366-R BNC to SMB Cable, 1 m
	2000-1938-R SMB Plug to BNC Jack Adapter (qty 3)

**Optional Accessories**

Miscellaneous Accessories	
Accessory	Description
	2000-1945-R MS2090A Soft Case
	67135 Anritsu Backpack (for Handheld Instrument and PC)
	760-243-R Large Transit Case with Wheels and Handle 56 cm x 45.5 cm x 26.5 cm (22.07" x 17.92" x 10.42")
	40-207-R Automotive DC/DC Power Adapter
	2000-2048-R Screen Protector (Field Master Pro)









Accessory	Description
	MA25401A Atomic Clock External 10 MHz Frequency Reference (see MA25401A Technical Data Sheet, PN: 11410-01134 for details)
	MA25424A I/Q Data Converter Module Includes: 2000-2030-R PCIe OCuLink I/O Data Cable 2000-1859-R USB 3.0 Type A to Type C Cable
	MA25101A IQ Streaming PCIe Kit Includes: PCIe Card with mounting hardware 2000-2030-R PCIe OCuLink I/O Data Cable
	2000-1374-R External Dual Charger for Li-Ion Batteries
	2000-2053-R Shoulder Harness (Field Master Pro)

**GPS Antennas** (active)

Accessory	Description
	2000-1528-R Magnet Mount, SMA(m) with 5 m (16.4 ft) cable, requires 5 VDC
	2000-1652-R Magnet Mount, SMA(m) with 0.3 m (1 ft) cable, requires 3.3 VDC or 5 VDC

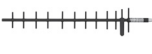

Accessory	Description
	2000-1760-R Miniature Antenna, SMA(m), requires 2.5 VDC to 3.7 VDC

**Directional Antennas**

Accessory	Description
	2000-1411-R 824 MHz to 896 MHz, N(f), 12.3 dBi, Yagi
	2000-1412-R 885 MHz to 975 MHz, N(f), 12.6 dBi, Yagi
	2000-1413-R 1710 MHz to 1880 MHz, N(f), 12.3 dBi, Yagi
	2000-1414-R 1850 MHz to 1990 MHz, N(f), 11.4 dBi, Yagi
	2000-1415-R 2400 MHz to 2500 MHz, N(f), 14.1 dBi, Yagi
	2000-1416-R 1920 MHz to 2170 MHz, N(f), 14.3 dBi, Yagi
	2000-1659-R 698 MHz to 787 MHz, N(f), 10.1 dBi, Yagi
	2000-1660-R 1425 MHz to 1535 MHz, N(f), 14.3 dBi, Yagi
	2000-1715-R Directional Antenna, 698 MHz to 2500 MHz, N(f), gain of 2 dBi to 10 dBi, typical

Accessory	Description
	2000-1726-R Antenna, 2500 MHz to 2700 MHz, N(f), 14.1 dBi, Yagi
	2000-1747-R Antenna, Log Periodic, 300 MHz to 7000 MHz, N(f), 5.1 dBi, typical
	2000-1748-R Antenna, Log Periodic, 1 GHz to 18 GHz, N(f), 6 dBi, typical
	2000-1777-R Portable Directional Antenna, 9 kHz to 20 MHz, N(f) (requires port extender 2000-1798-R when used with MA2700A)
	2000-1778-R Portable Directional Antenna, 20 MHz to 200 MHz, N(f) (requires port extender 2000-1798-R when used with MA2700A)
	2000-1779-R Portable Directional Antenna, 200 MHz to 500 MHz, N(f) (requires port extender 2000-1798-R when used with MA2700A)
	2000-1812-R Portable Yagi Antenna, 450 MHz to 512 MHz, N(f), 7.1 dBi
	2000-1825-R Portable Yagi Antenna, 380 MHz to 430 MHz, N(f), 7.1 dBi
	2000-1798-R Port Extender, DC to 6 GHz

**Mag Mount and Broadband Antennas**

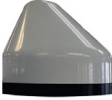
Accessory	Description
	2000-1616-R 20 MHz to 21000 MHz, N(f), 50 Ω
	2000-1645-R 694 MHz to 894 MHz, 3 dBi peak gain 1700 MHz to 2700 MHz, 3 dBi peak gain, N(m), 50 Ω, 10 ft
	2000-1646-R 750 MHz to 1250 MHz, 3 dBi peak gain, 1650 MHz to 2000 MHz, 5 dBi peak gain, 2100 MHz to 2700 MHz, 5 dBi peak gain, N(m), 50 Ω, 10 ft
	2000-1647-R Cable 1: 698 MHz to 1200 MHz, 2 dBi peak gain, 1700 MHz to 2700 MHz, 5 dBi peak gain, N(m), 50 Ω, 10 ft Cable 2: 3000 MHz to 6000 MHz, 5 dBi peak gain, N(m), 50 Ω, 10 ft Cable 3: GPS 26 dB gain, SMA(m), 50 Ω, 10 ft

Accessory	Description
	2000-1648-R 1700 MHz to 6000 MHz, 3 dBi peak gain, N(m), 50 Ω, 10 ft
	2000-1946-R Cable 1: 617 MHz to 960 MHz, 3 dBi peak gain, 1710 MHz to 3700 MHz, 4 dBi peak gain, N(m), 50 Ω, 10 ft Cable 2: 3000 MHz to 6000 MHz, 5 dBi peak gain, N(m), 50 Ω, 10 ft Cable 3: GPS 26 dB gain, SMA(m), 50 Ω, 10 ft
	2000-1940-R Ka Band 26.5 GHz to 40 GHz, K(f) (2.92 mm), 3 dBi gain

**Portable Antennas**

Accessory	Description
	2000-1200-R 806 MHz to 866 MHz, SMA(m), 50 Ω
	2000-1473-R 870 MHz to 960 MHz, SMA(m), 50 Ω
	2000-1035-R 896 MHz to 941 MHz, SMA(m), 50 Ω (1/2 wave)
	2000-1030-R 1710 MHz to 1880 MHz, SMA(m), 50 Ω (1/2 wave)
	2000-1474-R 1710 MHz to 1880 MHz with knuckle elbow (1/2 wave)
	2000-1031-R 1850 MHz to 1990 MHz, SMA(m), 50 Ω (1/2 wave)



Accessory	Description
	2000-1475-R 1920 MHz to 1980 MHz and 2110 MHz to 2170 MHz, SMA(m), 50 Ω
	2000-1032-R 2400 MHz to 2500 MHz, SMA(m), 50 Ω (1/2 wave)
	2000-1751-R 698 MHz to 960 MHz, 1710 MHz to 2100 MHz, 2500 MHz to 2700 MHz, SMA(m), 2 dB, typical, 50 Ω
	2000-1361-R 2400 MHz to 2500 MHz, 5000 MHz to 6000 MHz, SMA(m), 50 Ω
	2000-1636-R Antenna Kit (Consists of: 2000-1030-R, 2000-1031-R, 2000-1032-R, 2000-1200-R, 2000-1035-R, 2000-1361-R, and carrying pouch)

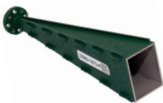

**Directional Horn Antennas**

Accessory	Description
	2000-1867-R 17.6 GHz to 26.7 GHz, WR42, 25 dBi gain
	2000-1868-R 26.4 GHz to 40.1 GHz, WR28, 25 dBi gain
	2000-1869-R 33.0 GHz to 50.1 GHz, WR22, 25 dB gain
	2000-1870-R 39.3 GHz to 59.7 GHz, WR19, 25 dBi gain

Accessory	Description
	2000-2003-R 24 GHz to 40 GHz, WR28, 19 dBi gain (small form factor assembly with K(f) adapter, mounting bracket, and case)

**EMF Antennas/Probes**

Accessory	Description
	2000-1800-R Isotropic Antenna, H-Field, 9 kHz to 300 MHz
	2000-1792-R Isotropic Antenna, E-Field, 30 MHz to 3 GHz

Accessory	Description
	2000-1791-R Isotropic Antenna, E-Field, 0.7 GHz to 6 GHz
	2000-1985-R EMF Probe, 20 MHz to 40 GHz

**Bandpass Filters**

Accessory	Description
	1030-114-R 806 MHz to 869 MHz, N(m) to SMA(f), 50 Ω
	1030-109-R 824 MHz to 849 MHz, N(m) to SMA(f), 50 Ω
	1030-110-R 880 MHz to 915 MHz, N(m) to SMA(f), 50 Ω
	1030-111-R 1850 MHz to 1910 MHz, N(m) to SMA(f), 50 Ω
	1030-112-R 2400 MHz to 2484 MHz, N(m) to SMA(f), 50 Ω
	1030-105-R 890 MHz to 915 MHz, N(m) to N(f), 50 Ω
	1030-106-R 1710 MHz to 1790 MHz, N(m) to N(f), 50 Ω
	1030-107-R 1910 MHz to 1990 MHz, N(m) to N(f), 50 Ω
	1030-149-R High Pass, 150 MHz, N(m) to N(f), 50 Ω
	1030-150-R High Pass, 400 MHz, N(m) to N(f), 50 Ω
	1030-151-R High Pass, 700 MHz, N(m) to N(f), 50 Ω
	1030-152-R Low Pass, 200 MHz, N(m) to N(f), 50 Ω
	1030-153-R Low Pass, 550 MHz, N(m) to N(f), 50 Ω
	1030-155-R 2500 MHz to 2700 MHz, N(m) to N(f), 50 Ω
	1030-178-R 1920 MHz to 1980 MHz, N(m) to N(f), 50 Ω
	1030-179-R 777 MHz to 798 MHz, N(m) to N(f), 50 Ω
	1030-180-R 2500 MHz to 2570 MHz, N(m) to N(f), 50 Ω

Accessory	Description
	2000-1734-R 699 MHz to 715 MHz, N(m) and N(f), 50 Ω
	2000-1735-R 776 MHz to 788 MHz, N(m) and N(f), 50 Ω
	2000-1736-R 815 MHz to 850 MHz, N(m) and N(f), 50 Ω
	2000-1737-R 1711 MHz to 1756 MHz, N(m) and N(f), 50 Ω
	2000-1738-R 1850 MHz to 1910 MHz, N(m) and N(f), 50 Ω
	2000-1739-R 880 MHz to 915 MHz, N(m) and N(f), 50 Ω
	2000-1740-R 1710 MHz to 1785 MHz, N(m) and N(f), 50 Ω
	2000-1741-R 1920 MHz to 1980 MHz, N(m) and N(f), 50 Ω
	2000-1742-R 832 MHz to 862 MHz, N(m) and N(f), 50 Ω
	2000-1743-R 2500 MHz to 2570 MHz, N(m) and N(f), 50 Ω
	2000-1799-R 2305 MHz to 2320 MHz, N(m) and N(f), 50 Ω
	2000-1684-R 791 MHz to 821 MHz, N(m) to N(f), 50 Ω



**Attenuators**

Accessory	Description
	1010-121-R Attenuator, 40 dB, 100 W, DC-18 GHz, N(f) input to N(m) output, Unidirectional
	3-1010-122 20 dB, 5 W, DC to 12.4 GHz, N(m) to N(f)
	3-1010-123 30 dB, 50 W, DC to 8.5 GHz, N(m) to N(f)
	3-1010-124 Attenuator, 40 dB, 100 W, DC-8.5 GHz, N(f) input to N(m) output, Unidirectional

**Accessory Description**

Accessory	Description
	42N50-20 20 dB, 5 W, DC to 18 GHz, N(m) to N(f)
	42N50A-30 30 dB, 50 W, DC to 18 GHz, N(m) to N(f)
	1010-127-R 30 dB, 150 W, DC to 3 GHz, N(m) to N(f)
	1010-128-R 40 dB, 150 W, DC to 3 GHz, N(m) to N(f)



**Fixed Attenuators**

Accessory	Description
	41KB-3 Precision, DC to 26.5 GHz, 1W, 3 dB, K(m) to K(f)
	41KB-6 Precision, DC to 26.5 GHz, 1W, 6 dB, K(m) to K(f)
	41KB-10 Precision, DC to 26.5 GHz, 1W, 10 dB, K(m) to K(f)
	41KB-20 Precision, DC to 26.5 GHz, 1W, 20 dB, K(m) to K(f)
	41KC-3 Precision, DC to 40 GHz, 1W, 3 dB, K(m) to K(f)
	41KC-6 Precision, DC to 40 GHz, 1W, 6 dB, K(m) to K(f)
	41KC-10 Precision, DC to 40 GHz, 1W, 10 dB, K(m) to K(f)
	41KC-20 Precision, DC to 40 GHz, 1W, 20 dB, K(m) to K(f)



**Accessory Description**

Accessory	Description
	41VA-3 Precision, DC to 70 GHz, 1W, 3 dB, V(m) to V(f)
	41VA-6 Precision, DC to 70 GHz, 1W, 6 dB, V(m) to V(f)
	41VA-10 Precision, DC to 70 GHz, 1W, 10 dB, V(m) to V(f)
	41VA-20 Precision, DC to 70 GHz, 1W, 20 dB, V(m) to V(f)
	43KC-3 Precision, DC to 26.5 GHz, 1W, 3 dB, K(m) to K(f)
	43KC-6 Precision, DC to 26.5 GHz, 1W, 6 dB, K(m) to K(f)
	43KC-10 Precision, DC to 26.5 GHz, 1W, 10 dB, K(m) to K(f)
	43KC-20 Precision, DC to 26.5 GHz, 1W, 20 dB, K(m) to K(f)

**Precision Adapters**

Accessory	Description
	34NN50A N(m) to N(m), DC to 18 GHz, 50 Ω
	34NFN50 N(f) to N(f), DC to 18 GHz, 50 Ω

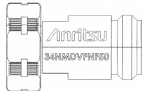
**Accessory Description**

	34NMDVFN50 NMD, V(f) to N(f), DC to 18 GHz, 50 Ω
	71693-R Ruggedized K(f) to N(f), DC to 18 GHz, 50 Ω

**Adapters**

Accessory	Description
	1091-26-R SMA(m) to N(m), DC to 18 GHz, 50 Ω
	1091-27-R SMA(f) to N(m), DC to 18 GHz, 50 Ω
	1091-80-R SMA(m) to N(f), DC to 18 GHz, 50 Ω
	1091-81-R SMA(f) to N(f), DC to 18 GHz, 50 Ω
	1091-172-R BNC(f) to N(m), DC to 1.3 GHz, 50 Ω
	1091-417-R N(m) to QMA(f), DC to 6 GHz, 50 Ω
	1091-418-R N(m) to QMA(m), DC to 18 GHz, 50 Ω
	2000-1938-R SMB Plug to BNC Jack Adapter

**Accessory Description**

	510-102-R N(m) to N(m), DC to 11 GHz, 50 Ω, 90 degrees right angle
	510-90-R 7/16 DIN(f) to N(m), DC to 7.5 GHz, 50 Ω
	510-91-R 7/16 DIN(f) to N(f), DC to 7.5 GHz, 50 Ω
	510-92-R 7/16 DIN(m) to N(m), DC to 7.5 GHz, 50 Ω
	510-93-R 7/16 DIN(m) to N(f), DC to 7.5 GHz, 50 Ω
	510-96-R 7/16 DIN(m) to 7/16 DIN (m), DC to 7.5 GHz, 50 Ω
	510-97-R 7/16 DIN(f) to 7/16 DIN (f), DC to 7.5 GHz, 50 Ω

**Coaxial Adapters**

Accessory	Description
	34VFK50A DC to 43.5 GHz, V(f) to K(m), 50 Ω
	34VFKF50A DC to 43.5 GHz, V(f) to K(f), 50 Ω
	34VV50 DC to 65 GHz, V(m) to V(m), 50 Ω
	34VVF50 DC to 65 GHz, V(f) to V(m), 50 Ω
	34VVF50 DC to 65 GHz, V(f) to V(f), 50 Ω

Accessory	Description
	2000-1880-R DC to 18 GHz, N(m) to V(f), 50 Ω
	2000-1881-R DC to 18 GHz, N(f) to V(f), 50 Ω
	K222B DC to 40 GHz, K(f) to K(f), 50 Ω

**Precision Waveguide Coaxial Adapters (right angle)**

Accessory	Description
	35WR42KF 18 GHz to 26.5 GHz, WR42 to K(f)
	35WR28KF 26.5 GHz to 40 GHz, WR28 to K(f)
	35WR22VF 33 GHz to 50 GHz, WR22 to V(f)

Accessory	Description
	35WR19VF 40 GHz to 60 GHz, WR19 to V(f)
	35WR15VF 50 GHz to 65 GHz, WR15 to V(f)

**Waveguide to Coaxial End Launch Adapters (straight through)**

Accessory	Description
	2000-1889-R 17.6 GHz to 26.7 GHz, WR42 to K(f)
	2000-1890-R 26.4 GHz to 40.1 GHz, WR28 to K(f)
	1091-460-R 17.6 GHz to 26.7 GHz, WR42 to V(f)
	1091-459-R 26.4 GHz to 40.1 GHz, WR28 to V(f)

Accessory	Description
	1091-458-R 33.0 GHz to 50.1 GHz, WR22 to V(f)
	1091-457-R 39.3 GHz to 59.7 GHz, WR19 to V(f)
	1091-456-R 49.9 GHz to 67.0 GHz, WR15 to V(f)

**Test Port Cables (Armored, Semi-rigid)**

Accessory	Description
	3670K50A-1 K(f) to K(m), 30.48 cm
	3670K50A-2 K(f) to K(m), 60.96 cm

Accessory	Description
	3670V50A-1 DC to 70 GHz, V(f) to V(m), 30.5 cm (1 ft)
	3670V50A-2 DC to 70 GHz, V(f) to V(m), 61.0 cm (2 ft)



**NEON® MA8100A Signal Mapper**

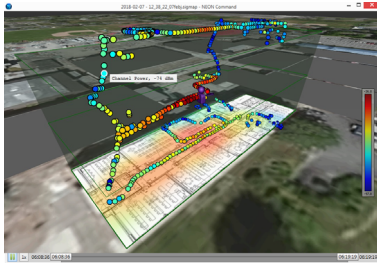

**Accessory Description**

- MA8100A-000 NEON Signal Mapper with Anritsu Integration and Tracking Unit. Includes 1 year NEON Software License with 1 year of maintenance and support and 1 year of Cloud Service (PN: 2300-607).
- MA8100A-001 NEON Signal Mapper with Anritsu Integration and Tracking Unit. Includes 1 year NEON Software License with 1 year of maintenance and support and 1 year of Cloud Service (PN: 2300-574).
- MA8100A-003 NEON Signal Mapper with Anritsu Integration and Tracking Unit. Includes 3 year NEON Software License with 3 years of maintenance and support and 3 years of Cloud Service (PN: 2300-575).
- MA8100A-005 NEON Signal Mapper with Anritsu Integration and Tracking Unit. Includes 5 year NEON Software License with 5 years of maintenance and support and 5 years of Cloud Service (PN: 2300-576).
- MA8100A-100 NEON Signal Mapper with Anritsu Integration and Tracking Unit. Includes Perpetual NEON Software License with 3 years of maintenance and support and 3 years of Cloud Service (PN: 2300-606).
  - 2300-606 Perpetual NEON Software License with 3 years of maintenance and support and 3 years of Cloud Service. Part number can also be used to order a perpetual license after a limited term license has expired.
  - 2300-612 Renewal of 1 year NEON Software License with 1 year of maintenance and support and 1 year of Cloud Service.
  - 2300-613 Renewal of 3 year NEON Software License with 3 years of maintenance and support and 3 years of Cloud Service.
  - 2300-614 Renewal of 5 year NEON Software License with 5 years of maintenance and support and 5 years of Cloud Service.
- 2000-1852-R NEON Tracking Unit (includes USB cable and belt clip, Worldwide version)
- 2000-2015-R NEON Tracking Unit (includes USB cable and belt clip, Japan version)
- 2000-1853-R Belt clip (for NEON Tracking Unit)

## Training at Anritsu

Anritsu has designed courses to help you stay up to date with technologies important to your job. For available training courses, visit: [www.anritsu.com/training](http://www.anritsu.com/training)



### • United States

**Anritsu Americas Sales Company**  
450 Century Parkway, Suite 190,  
Allen, TX 75013, U.S.A.  
Phone: +1-800-Anritsu (1-800-267-4878)

### • Canada

**Anritsu Electronics Ltd.**  
700 Silver Seven Road, Suite 120,  
Kanata, Ontario K2V 1C3, Canada  
Phone: +1-613-591-2003  
Fax: +1-613-591-1006

### • Brazil

**Anritsu Elettronica Ltda.**  
Praça Amadeu Amaral, 27 - 1 Andar  
01327-010 - Bela Vista - Sao Paulo - SP, Brazil  
Phone: +55-11-3283-2511  
Fax: +55-11-3288-6940

### • Mexico

**Anritsu Company, S.A. de C.V.**  
Blvd Miguel de Cervantes Saavedra #169 Piso 1,  
Col. Granada, Mexico, Ciudad de Mexico,  
11520, MEXICO  
Phone: +52-55-4169-7104

### • United Kingdom

**Anritsu EMEA Ltd.**  
200 Capability Green,  
Luton, Bedfordshire, LU1 3LU, U.K.  
Phone: +44-1582-433200  
Fax: +44-1582-731303

### • France

**Anritsu S.A.**  
12 avenue du Québec, Immeuble Goyave,  
91140 VILLEBON SUR YVETTE, France  
Phone: +33-1-60-92-15-50

### • Germany

**Anritsu GmbH**  
Nemetschek Haus, Konrad-Zuse-Platz 1,  
81829 München, Germany  
Phone: +49-89-442308-0  
Fax: +49-89-442308-55

### • Italy

**Anritsu S.r.l.**  
Spaces Eur Arte, Viale dell'Arte 25, 00144 Roma, Italy  
Phone: +39-6-509-9711

### • Sweden

**Anritsu AB**  
Kistagången 20 B, 2 tr, 164 40 Kista, Sweden  
Phone: +46-8-534-707-00

### • Finland

**Anritsu AB**  
Technopolis Aviapolis, Teknobulevardi 3-5 (D208.5),  
FI-01530 Vantaa, Finland  
Phone: +358-20-741-8100

### • Denmark

**Anritsu A/S**  
c/o Regus Winghouse, Ørestads Boulevard 73, 4th floor,  
2300 Copenhagen S, Denmark  
Phone: +45-7211-2200

### • Russia

**Anritsu EMEA Ltd.**  
**Representation Office in Russia**  
Tverskaya str. 16/2, bld. 1, 7th floor,  
Moscow 125009, Russia  
Phone: +7-495-363-1694  
Fax: +7-495-935-8962

### • Spain

**Anritsu EMEA Ltd.**  
**Representation Office in Spain**  
Paseo de la Castellana, 141.  
Planta 5, Edificio Cuzco IV  
28046, Madrid, Spain  
Phone: +34-91-572-6761

### • Austria

**Anritsu EMEA GmbH**  
Am Belvedere 10, A-1100 Vienna, Austria  
Phone: +43-(0)1-717-28-710

### • United Arab Emirates

**Anritsu EMEA Ltd.**  
**Anritsu A/S**  
Office No. 164, Building 17, Dubai Internet City  
P. O. Box - 501901, Dubai, United Arab Emirates  
Phone: +971-4-3758479

### • India

**Anritsu India Private Limited**  
6th Floor, Indiqube ETA, No.38/4, Adjacent to EMC2,  
Doddanekundi, Outer Ring Road,  
Bengaluru - 560048, India  
Phone: +91-80-6728-1300  
Fax: +91-80-6728-1301

### • Singapore

**Anritsu Pte. Ltd.**  
11 Chang Charn Road, #04-01, Shriro House  
Singapore 159640  
Phone: +65-6282-2400  
Fax: +65-6282-2533

### • Vietnam

**Anritsu Company Limited**  
16th Floor, Peakview Tower, 36 Hoang Cau Street,  
O Cho Dua Ward, Dong Da District, Hanoi, Vietnam  
Phone: +84-24-3201-2730

### • P.R. China (Shanghai)

**Anritsu (China) Co., Ltd.**  
Room 2701-2705, Tower A, New Caohejing  
International Business Center No. 391 Gui Ping Road  
Shanghai, 200233, P.R. China  
Phone: +86-21-6237-0898  
Fax: +86-21-6237-0899

### • P.R. China (Hong Kong)

**Anritsu Company Ltd.**  
Unit 1006-7, 10/F., Greenfield Tower, Concordia Plaza,  
No. 1 Science Museum Road, Tsim Sha Tsui East,  
Kowloon, Hong Kong, P.R. China  
Phone: +852-2301-4980  
Fax: +852-2301-3545

### • Japan

**Anritsu Corporation**  
8-5, Tamura-cho, Atsugi-shi, Kanagawa, 243-0016 Japan  
Phone: +81-46-296-6509  
Fax: +81-46-225-8352

### • South Korea

**Anritsu Corporation, Ltd.**  
5FL, 235 Pangyoyeok-ro, Bundang-gu, Seongnam-si,  
Gyeonggi-do 13494, South Korea  
Phone: +82-31-696-7750  
Fax: +82-31-696-7751

### • Australia

**Anritsu Pty. Ltd.**  
Unit 20, 21-35 Ricketts Road,  
Mount Waverley, Victoria 3149, Australia  
Phone: +61-3-9558-8177  
Fax: +61-3-9558-8255

### • Taiwan

**Anritsu Company Inc.**  
7F, No. 316, Sec. 1, NeiHu Rd., Taipei 114, Taiwan  
Phone: +886-2-8751-1816  
Fax: +886-2-8751-1817

List Revision Date: 20210610