

VNA Master™

Handheld Vector Network Analyzer + Spectrum Analyzer

| | | | | |
|----------------|----------------------------------|-----------------|------------------------------------|--|
| MS2026C | MS2036C | MS2028C | MS2038C | |
| 5 kHz to 6 GHz | 5 kHz to 6 GHz 9 kHz to 9 GHz | 5 kHz to 20 GHz | 5 kHz to 20 GHz 9 kHz to 20 GHz | Vector Network Analyzer Spectrum Analyzer |

The Ultimate Handheld Vector Network + Spectrum Analyzer for Cable, Antenna, and Signal Analysis Anytime, Anywhere

Introduction

High Performance Handheld S-Parameters

Anritsu introduces the MS202x/3xC VNA Master + Spectrum Analyzer, the industry's broadest frequency handheld solution to address cable, antenna, component, and signal analysis needs in the field: with frequency coverage from 5 kHz to 6/20 GHz. Equally impressive, this broadband measurement tool offers the industry's first 12-term error correction algorithm in a truly handheld, battery-operated, rugged multi-function instrument. And now the MS2036/38C models include a powerful spectrum analyzer which multiplies user convenience by combining spectrum analysis with the VNA into a single measurement powerhouse for the harsh RF and physical environments of field test. Whether it is for spectrum monitoring, broadcast proofing, interference analysis, RF and microwave measurements, regulatory compliance, or 3G/4G and wireless data network measurements, this VNA/Spectrum Analyzer marriage is the ideal instrument for making fast and reliable measurements in the field.



Performance and Functional Highlights

VNA Master

- Broadband coverage of 5 kHz to 6/20 GHz
- True 2-path, 2-port Vector Network Analyzer
- Ultimate accuracy with 12-term error correction
- User-defined Quad Display for viewing all 4 S-Parameters
- Arbitrary data points up to 4001
- IF Bandwidth selections of 10 Hz to 100 kHz
- > 85 dB Transmission Dynamic Range to 20 GHz
- Supports waveguide measurements
- 350 μ s/data point sweep speed
- USB/Ethernet for PC data transfer and control
- Automate repetitive tasks via Ethernet & USB
- Field upgradable firmware
- Store more than 4000 traces and setups in memory
- Portable: 10.5 lbs (4.8 kg)
- Full Speed USB Memory support
- High resolution daylight viewable TFT color display
- Time Domain option for Distance-to-Fault diagnostics
- Internal Bias Tee option
- Vector Voltmeter option
- High Accuracy Power Meter option
- Differential option (S_{didi} , S_{cici} , S_{dici} , and S_{cidi})
- Secure Data Operation option
- GPS Receiver option
- Power Monitor option
- Polar Format Impedance Display
- 4, 6, 8, 18, 26 GHz USB Power Sensors
- 8.4 in. Display
- Complies with MIL-PRF-28800F Class 2 specification

Block Diagram

As shown in the following block diagram, the VNA Master has a 2-port, 2-path architecture that automatically measures four S-parameters with a single connection.

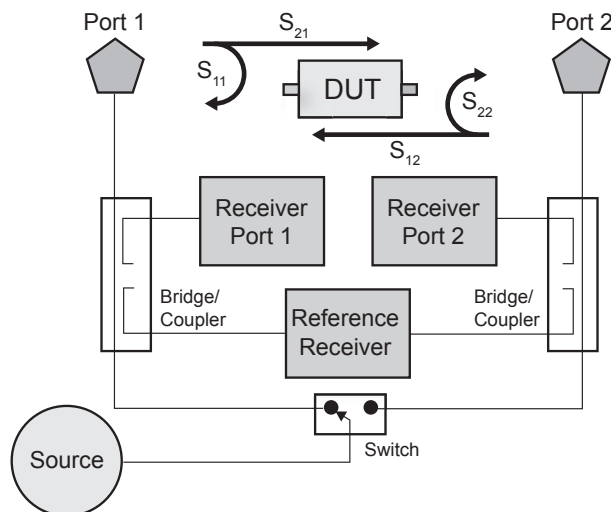

The above illustration is a simplified block diagram of VNA Master's 2-port, 2-path architecture.

VNA Master + Spectrum Analyzer

All of the above VNA features PLUS:

- Measure: Occupied Bandwidth, Channel Power, ACPR, C/I
- Dynamic Range: > 104 dB in 1 Hz RBW
- DANL: -160 dBm in 1 Hz RBW
- Phase Noise: -100 dBc/Hz @ 10 kHz offset at 1 GHz
- Frequency Accuracy: $< \pm 25$ ppb with GPS On
- 1 Hz to 10 MHz Resolution Bandwidth (RBW)
- Traces: Normal, Max Hold, Min Hold, Average, # of Averages
- Detectors: Peak, Negative, Sample, Quasi-peak, and true RMS
- Markers: 6, each with a Delta Marker, or 1 Reference with 6 Deltas
- Limit Lines: up to 40 segments with one-button envelope creation
- Trace Save-on-Event: crossing limit line or sweep complete
- Option to automatically optimize sweep-RBW-VBW tradeoff for best possible display
- Interference Analyzer Option: Spectrogram, Signal Strength, RSSI
- Channel Scanner Option
- Zero-span IF Output
- Gated Sweep
- GPS tagging of stored traces
- Internal Preamplifier standard
- High Accuracy Power Meter Option
- AM/FM/SSB Demodulation (audio only)

VNA Master Functional Specifications

Definitions

All specifications and characteristics apply under the following conditions, unless otherwise stated:

- After 30 minutes of warm-up time, when the instrument is in VNA Mode and left in the ON state.
- Temperature range is $23\text{ }^{\circ}\text{C} \pm 5\text{ }^{\circ}\text{C}$.
- All specifications apply when using internal reference.
- All specifications subject to change without notice. Please visit www.anritsu.com for most current data sheet.
- Typical performance is the measured performance of an average unit.
- Recommended calibration cycle is 12 months.

Frequency

VNA Master Frequency Range: MS2026/36C: 5 kHz to 6 GHz
MS2028/38C: 5 kHz to 20 GHz

Frequency Accuracy: $\pm 1.5\text{ ppm}$

Frequency Resolution: 1 Hz to 375 MHz, 10 Hz to 6 GHz, and 100 Hz to 20 GHz

Test Port Power

VNA Master supports selection of either High (default) or Low test port power. Changing power after calibration can degrade the calibrated performance. Typical power by bands is shown in the following table.

| Frequency Range | High Port Power dBm, typical) | Low Port Power (dBm, typical) |
|------------------------|----------------------------------|----------------------------------|
| 5 kHz to \leq 3 GHz | +3 | -25 |
| 3 GHz to \leq 6 GHz | -3 | -25 |
| 6 GHz to \leq 20 GHz | -3 | -15 |

Transmission Dynamic Range

The transmission dynamic range (the difference between test port power and noise floor) using 10 Hz IF Bandwidth and High Port Power is shown in the following table.

| Frequency Range | Dynamic Range (dB) |
|------------------------|-----------------------|
| 5 kHz to \leq 2 MHz | 85 |
| 2 MHz to \leq 3 GHz | 100 |
| 3 GHz to \leq 6 GHz | 90 |
| 6 GHz to \leq 20 GHz | 85 |

Sweep Speed

The typical sweep speed for IF Bandwidth of 100 kHz, 1001 data points, and single display is shown in the following table. The three receiver architecture will simultaneously collect S_{21} and S_{11} (or S_{12} and S_{22}) in a single sweep.

| Frequency Range | Sweep Speed ($\mu\text{s}/\text{point}$, typical) |
|-----------------|--|
| 5 kHz to 6 GHz | 350 |
| 6 GHz to 20 GHz | 650 |

High-Level Noise (S_{11} or S_{22} , Short, Power = High, IFBW = 200 Hz typical)

| Magnitude | Phase |
|---------------------------------|-----------------------------|
| 0.004 dB(rms) (5 kHz to 6 GHz) | 0.040 deg (5 kHz to 6 GHz) |
| 0.010 dB(rms) (6 GHz to 20 GHz) | 0.050 deg (6 GHz to 20 GHz) |

Noise Floor (Port Power - Dynamic Range)

| Frequency | Noise Floor (dB, typical) |
|-------------------|---------------------------|
| 5 kHz to = 2 MHz | Port Power -85 |
| 2 MHz to = 3 GHz | Port Power -100 |
| 3 GHz to = 6 GHz | Port Power -90 |
| 6 GHz to = 20 GHz | Port Power -85 |

Temperature Stability (S_{11} or S_{22} , Short, $23\text{ }^{\circ}\text{C} \pm 5\text{ }^{\circ}\text{C}$, typical)

| Magnitude | Phase |
|---|--|
| 0.018 dB/ $^{\circ}\text{C}$ (5 kHz to 10 GHz) | 0.160 deg/ $^{\circ}\text{C}$ (5 kHz to 10 GHz) |
| 0.070 dB/ $^{\circ}\text{C}$ (10 GHz to 20 GHz) | 0.800 deg/ $^{\circ}\text{C}$ (10 GHz to 20 GHz) |

Reflection Tracking (S_{11} or S_{22})

| Frequency | Tracking (dB, typical) |
|-------------|------------------------|
| < 3 GHz | 0.05 |
| 3 to 6 GHz | 0.10 |
| 6 to 20 GHz | 0.20 |

Transmission Tracking (S_{21} or S_{12})

| Frequency | Tracking (dB, typical) |
|-------------|------------------------|
| < 3 GHz | 0.02 |
| 3 to 6 GHz | 0.05 |
| 6 to 20 GHz | 0.40 |

Source Match* (Anritsu 3652A Cal Kit)

| Frequency | Match (dB, typical) |
|-----------------|---------------------|
| 5 kHz to 1 GHz | 41 |
| 1 GHz to 5 GHz | 39 |
| 5 GHz to 20 GHz | 31 |

Load Match* (Anritsu 3652A Cal Kit)

| Frequency | Match (dB, typical) |
|------------------|---------------------|
| 5 kHz to 1 GHz | 37 |
| 1 GHz to 15 GHz | 34 |
| 15 GHz to 20 GHz | 30 |

* Valid for MS20xxC, Anritsu 3652 Cal Kit, Port Power = High, No Averaging, IFBW = 1 kHz

VNA Performance Capabilities (MS202x/3xC)

| | |
|-------------------------------------|--|
| Measurement Parameters | $S_{11}, S_{21}, S_{22}, S_{12}, S_{d1d1}, S_{c1c1}, S_{d1c1}, S_{c1d1}$ |
| Number of Traces | Four: TR1, TR2, TR3, TR4 |
| Trace Format | Single, Dual, Tri, Quad. When used with Number of Traces, overlays are possible including a Single Format with Four trace overlays. |
| Graph Types | Log Magnitude SWR Phase Real Imaginary Group Delay Smith Chart Inverted Smith Chart Log Mag / 2 (1-Port Cable Loss) Linear Polar Log Polar Real Impedance Imaginary Impedance |
| Domains | Frequency Domain, Time Domain, Distance Domain |
| Frequency | Start Frequency, Stop Frequency, Center Frequency, Span |
| Distance | Start Distance, Stop Distance |
| Time | Start Time, Stop Time |
| Frequency Sweep Type: Linear | Single Sweep, Continuous |
| Data Points | 2 to 4001 (arbitrary setting); data points can be reduced without recalibration. |
| Limit Lines | Upper, Lower, 10-segmented Upper, 10-segmented Lower |
| Test Limits | Pass/Fail for Upper, Pass/Fail for Lower, Limit Audible Alarm |
| Data Averaging | Sweep-by-sweep |
| Smoothing | 0 to 20% |
| IF Bandwidth | 10, 20, 50, 100, 200, 500, 1 k, 2 k, 5 k, 10 k, 20 k, 50 k, 100 k (Hz) |
| Reference Plane | The reference planes of a calibration (or other normalization) can be changed by entering a line length. Assumes no loss, flat magnitude, linear phase, and constant impedance. |
| Auto Reference Plane Extension | Instead of manually entering a line length, this feature automatically adjusts phase shift from the current calibration (or other normalization) to compensate for external cables (or test fixtures). Assumes no loss, flat magnitude, linear phase, and constant impedance. |
| Frequency Range | Frequency range of the measurement can be narrowed within the calibration range without recalibration. |
| Group Delay Aperture | Defined as the frequency span over which the phase change is computed at a given frequency point. The aperture can be changed without recalibration. The minimum aperture is the frequency range divided by the number of points in calibration and can be increased to 20% of the frequency range. |
| Group Delay Range | < 180° of phase change within the aperture |
| Trace Memory | A separate memory for each trace can be used to store measurement data for later display. The trace data can be saved and recalled. |
| Trace Math | Complex trace math operations of subtraction, addition, multiplication, or division are provided. |
| Number of Markers | Eight, arbitrary assignments to any trace |
| Marker Types | Reference, Delta |
| Marker Readout Styles | Log Mag, Cable Loss (Log Mag / 2), Log Mag and Phase, Phase, Real and Imaginary, SWR, Impedance, Admittance, Normalized Impedance, Normalized Admittance, Polar Impedance, and Group Delay, Linear Mag, Linear Mag and Phase |
| Marker Search | Peak Search, Valley Search, Find Marker Value |
| Correction Models | Full 2-Port, Full S_{11} , Full S_{22} , Full S_{11} & S_{22} , Response S_{21} , Response S_{12} , Response S_{21} & S_{12} , Response S_{11} , Response S_{22} , Response S_{11} & S_{22} , One-Path Two-Port (S_{11}, S_{21}), One-Path Two-Port (S_{22}, S_{12}) |
| Calibration Methods | Short-Open-Load-Through (SOLT), Offset-Short (SSLT), and Triple-Offset-Short (SSST) |
| Calibration Standards' Coefficients | Coax: N-Connector, K-Connector, 7/16, TNC, SMA, and four User Defined Waveguide: WG11A, WG12, WG13, WG14, WG15, WG16, WG17, WG18, WG20, and four User Defined |
| Cal Correction Toggle | On/Off |
| Dispersion Compensation | Waveguide correction that improves accuracy of distance-to-fault data by compensating for different wavelengths propagating at different speeds. |
| Impedance Conversion | Support for 50 Ω and 75 Ω are provided. |
| Units | Meters, Feet |
| Bias Tee Settings | Internal, External, Off |
| Timebase Reference | Internal, External (10 MHz) |
| File Storage Types | Measurement, Setup (with CAL), Setup (without CAL), S2P (Real/Imag), S2P (Lin Mag/Phase), S2P (Log Mag/Phase), JPEG |
| Ethernet Configuration | DHCP or Manual (Static); IP, Gateway, Subnet entries |
| Languages | English, French, German, Spanish, Chinese, Japanese, Korean, Italian, plus two User Defined |

Uncertainty Curves for Round-Trip Cable Loss Measurements (1-Port)

Round-trip cable loss measurements are convenient for field personnel testing installed cable or waveguide runs. This one-port technique provides one-way data after twice traversing the cable. The following two sets of uncertainty curves, less than 6 GHz on the left and greater than 6 GHz on the right, present worst-case uncertainty by DUT Match (i.e., Log Mag) when using VNA Master for one-port cable loss measurements. As a practical tip, consider using a two-port transmission measurement technique to improve upon these one-port cable loss uncertainties.

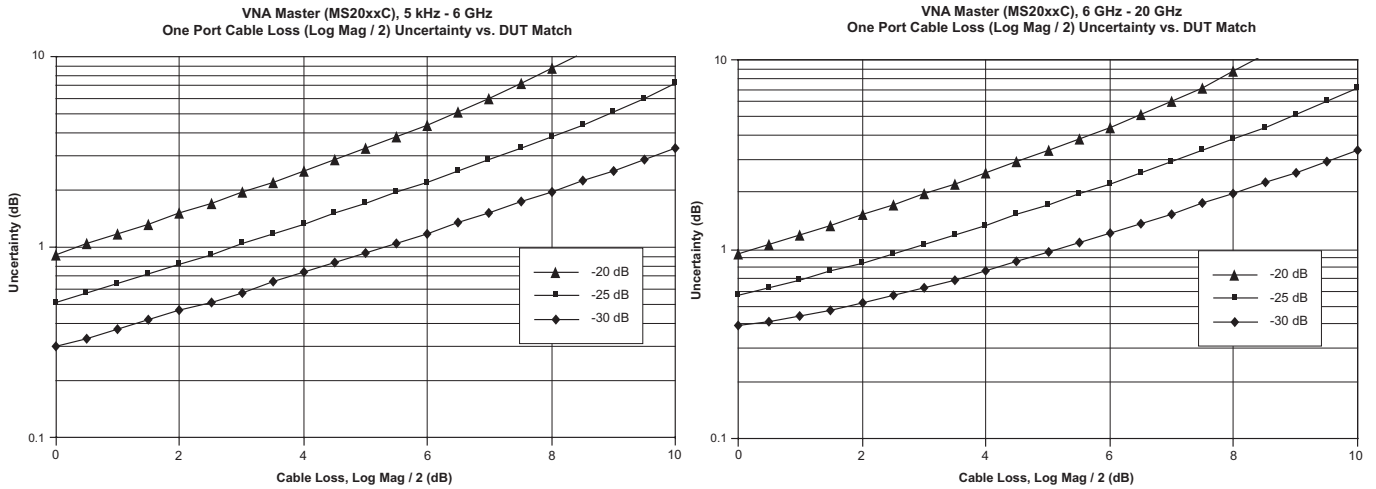

These uncertainty curves show how frequency range, DUT Match, and cable loss impact worst-case uncertainty of round-trip cable loss measurements. The uncertainty curves, separated by frequency range, are shown for DUT Match cable loss conditions of -20 dB, -25 dB, and -30 dB. For DUT Match of 30 dB and cable loss of 4 dB to 5 dB (reflection measurement of 8 dB to 10 dB) the worst-case uncertainties are approximately ± 1 dB.

High Port Power

OSLxx50 Calibration Components (N-Connectors)

Corrected System Performance and Uncertainties:
MS202x/3xC Models with 12-term SOLT calibration including
isolation using either OSLN50 & OSLNF50 or OSLK50 &
OSLKF50 Calibration Kits



Precision calibration standards come in a convenient configuration for field work.

| Frequency Range (GHz) | Directivity (dB) |
|-----------------------|------------------|
| ≤ 5 | > 42 |
| ≤ 15 | > 36 |
| ≤ 20* | > 32 |

* N Connector guaranteed to 18 GHz, typical > 18 GHz

| Frequency Range (GHz) | Typical High Port Power (dBm) |
|-----------------------|-------------------------------|
| ≤ 3 | +3 |
| ≤ 6 | -3 |
| ≤ 20 | -3 |

Measurement Uncertainties

The following graphs provide measurement uncertainty at 23 °C ± 5 °C for the above indicated connector type and calibration. Errors are worst-case contributions of residual directivity, source match, frequency response, network analyzer dynamic range, and connector repeatability. Transmission tracking, crosstalk, and physical load termination were added for two-port measurements. Isolation calibration and an IF Bandwidth of 10 Hz are used.

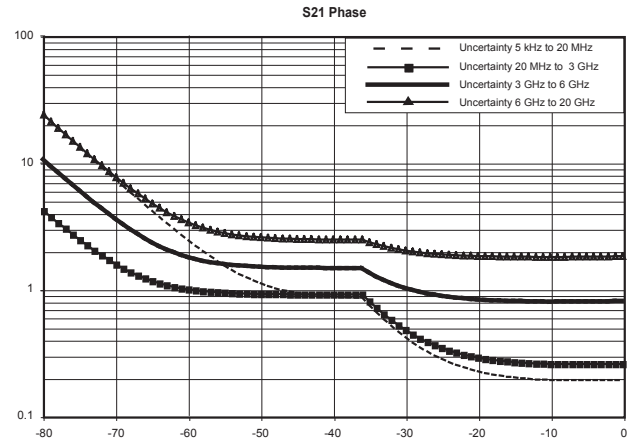
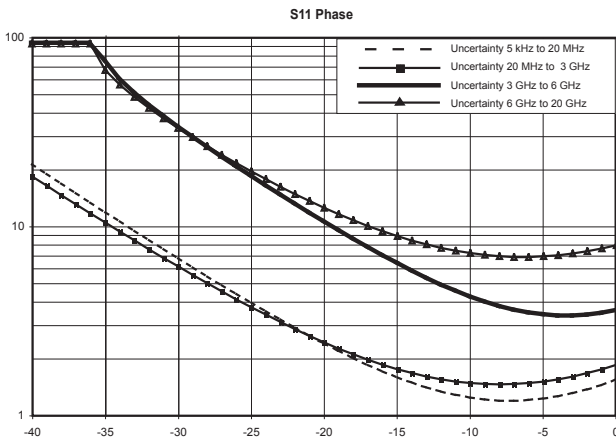
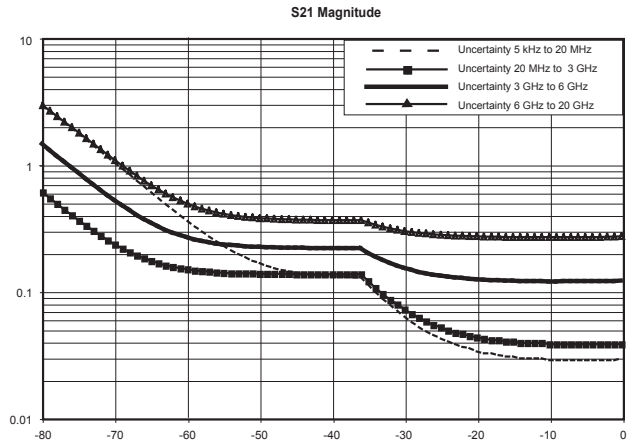
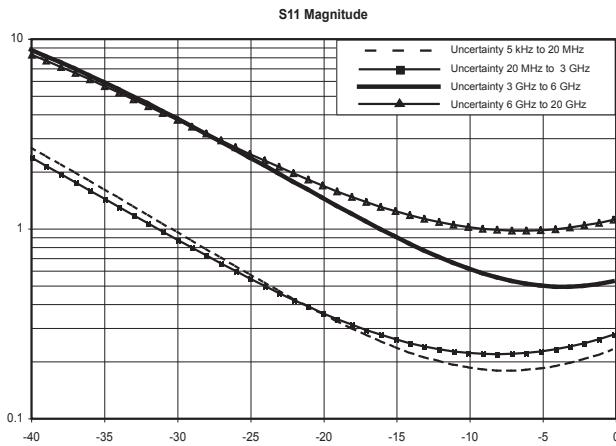

Low Port Power

OSLxx50 Calibration Components

Corrected System Performance and Uncertainties:
MS202x/3xC Models with 12-term SOLT calibration including
isolation using either OSLN50 & OSLNF50 or OSLK50 &
OSLKF50 Calibration Kits



| Frequency Range (GHz) | Directivity (dB) |
|-----------------------|------------------|
| ≤ 5 | > 42 |
| ≤ 15 | > 36 |
| ≤ 20* | > 32 |

* N Connector guaranteed to 18 GHz, typical > 18 GHz

| Frequency Range (GHz) | Typical High Port Power (dBm) |
|-----------------------|-------------------------------|
| ≤ 3 | -25 |
| ≤ 6 | -25 |
| ≤ 20 | -15 |

Measurement Uncertainties

The following graphs provide measurement uncertainty at $23\text{ }^{\circ}\text{C} \pm 5\text{ }^{\circ}\text{C}$ for the above indicated connector type and calibration. Errors are worst-case contributions of residual directivity, source match, frequency response, network analyzer dynamic range, and connector repeatability. Transmission tracking, crosstalk, and physical load termination were added for two-port measurements. Isolation calibration and an IF Bandwidth of 10 Hz are used.

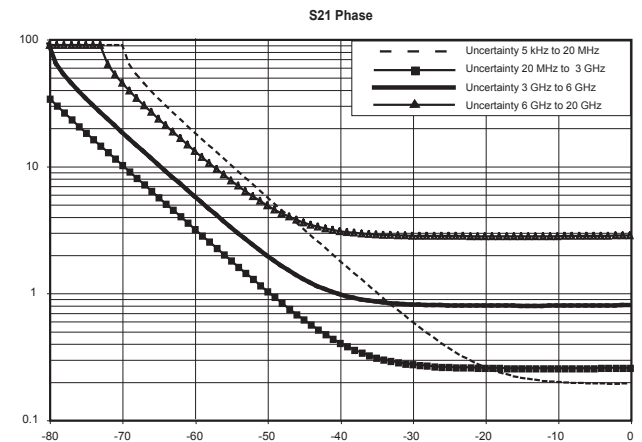
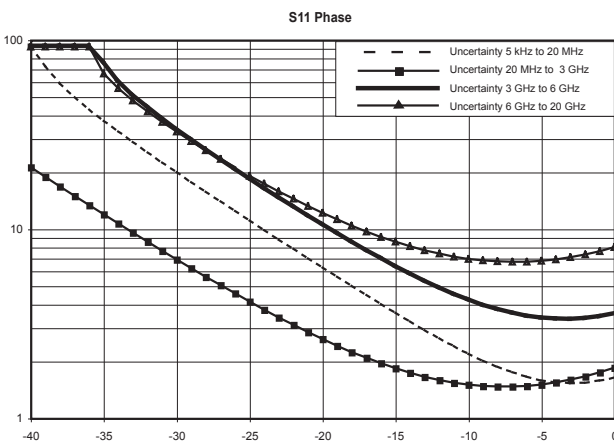
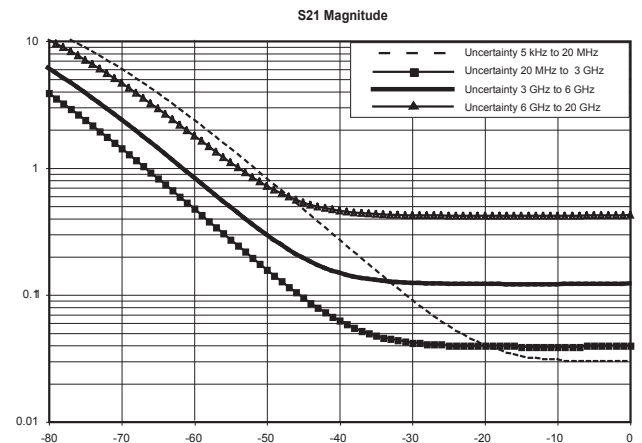
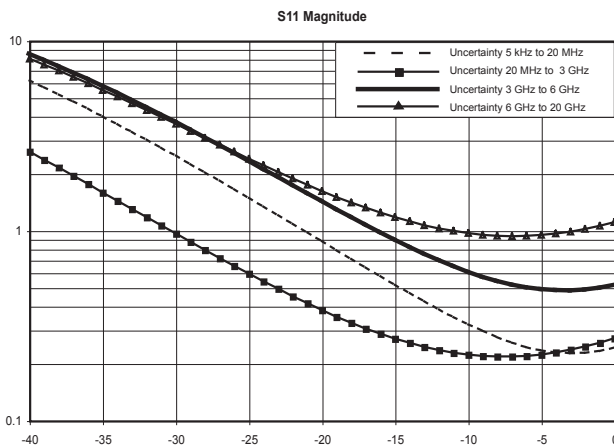

High Port Power

3652A Calibration Kit (K-Connector)

Corrected System Performance and Uncertainties:
MS202x/3xC Models with 12-term SOLT calibration including
isolation using 3652A Calibration Kit



| Frequency Range (GHz) | Directivity (dB) * |
|-----------------------|--------------------|
| ≤ 5 | > 34 |
| ≤ 15 | > 34 |
| ≤ 20 | > 34 |

* Directivity spec is limited to 34 dB by the 3652A Calibration Kit, not by the instrument performance.

| Frequency Range (GHz) | Typical High Port Power (dBm) |
|-----------------------|-------------------------------|
| ≤ 3 | +3 |
| ≤ 6 | -3 |
| ≤ 20 | -3 |

Measurement Uncertainties

The following graphs provide measurement uncertainty at 23 °C ± 5 °C for the above indicated connector type and calibration. Errors are worst-case contributions of residual directivity, source match, frequency response, network analyzer dynamic range, and connector repeatability. Transmission tracking, crosstalk, and physical load termination were added for two-port measurements. Isolation calibration and an IF Bandwidth of 10 Hz are used.

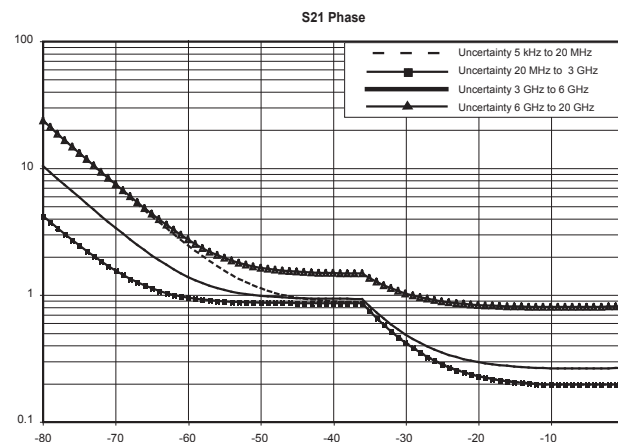
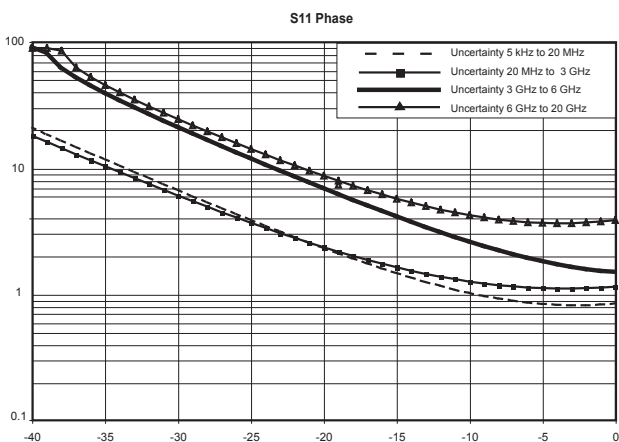
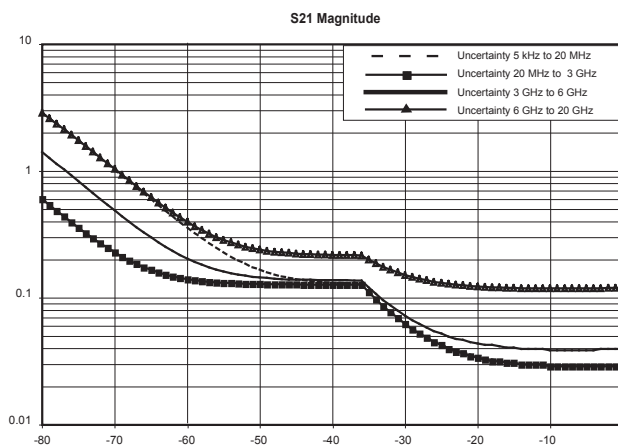
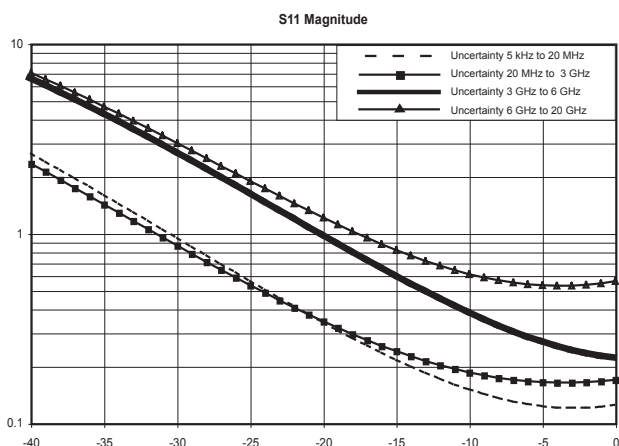

Low Port Power

3652A Calibration Kit (K-Connector)

Corrected System Performance and Uncertainties:
MS202x/3xC Models with 12-term SOLT calibration including
isolation using 3652A Calibration Kit



| Frequency Range (GHz) | Directivity (dB) * |
|-----------------------|--------------------|
| ≤ 5 | > 34 |
| ≤ 15 | > 34 |
| ≤ 20 | > 34 |

* Directivity spec is limited to 34 dB by the 3652A Calibration Kit, not by the instrument performance.

| Frequency Range (GHz) | Typical Low Port Power (dBm) |
|-----------------------|------------------------------|
| ≤ 3 | -25 |
| ≤ 6 | -25 |
| ≤ 20 | -25 |

Measurement Uncertainties

The following graphs provide measurement uncertainty at $23\text{ }^{\circ}\text{C} \pm 5\text{ }^{\circ}\text{C}$ for the above indicated connector type and calibration. Errors are worse-case contributions of residual directivity, source match, frequency response, network analyzer dynamic range, and connector repeatability. Transmission tracking, crosstalk, and physical load termination were added for two-port measurements. Isolation calibration and an IF Bandwidth of 10 Hz are used.

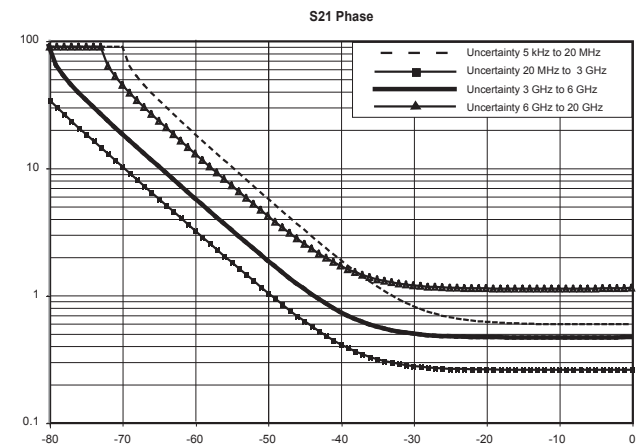
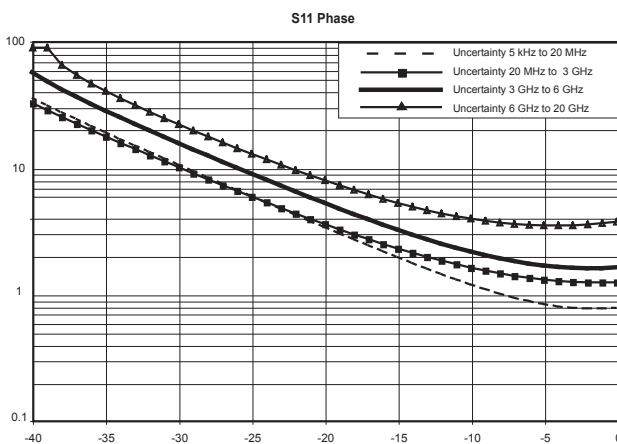
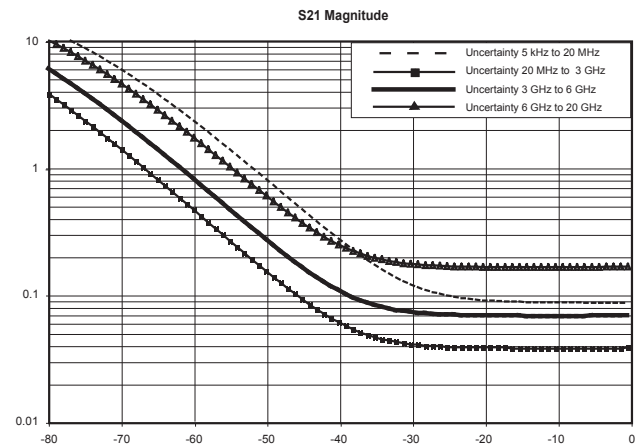
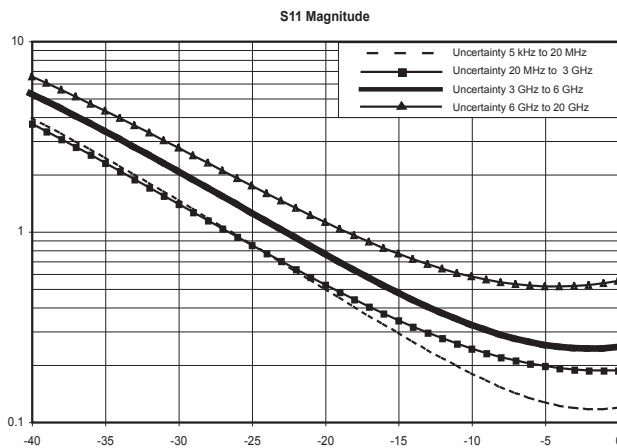

Spectrum Analyzer Functional Specifications (Models MS2036/38C only)

| Frequency | |
|--|--|
| Frequency Range | 9 kHz to 20 GHz (usable to 0 Hz), Preamp 100 kHz to 20 GHz |
| Tuning Resolution | 1 Hz |
| Frequency Reference | Aging: ± 1.0 ppm/10 years Accuracy: ± 0.3 ppm ($25\text{ }^{\circ}\text{C} \pm 25\text{ }^{\circ}\text{C}$) + aging |
| External Reference Frequencies | 1, 1.2288, 1.544, 2.048, 2.4576, 4.8, 4.9152, 5, 9.8304, 10, 13, 19.6608 MHz |
| Frequency Span | 10 Hz to 20 GHz including zero span |
| Sweep Time | 10 μs to 600 seconds in zero span |
| Sweep Time Accuracy | $\pm 2\%$ in zero span |
| Bandwidth | |
| Resolution Bandwidth (RBW) | 1 Hz to 10 MHz in 1–3 sequence $\pm 10\%$ (–3 dB bandwidth) |
| Video Bandwidth (VBW) | 1 Hz to 10 MHz in 1–3 sequence (–3 dB bandwidth) |
| RBW with Quasi-Peak Detection | 200 Hz, 9 KHz, 120 kHz (–6 dB bandwidth) |
| VBW with Quasi-Peak Detection | Auto VBW is On, RBW/VBW = 1 |
| Spectral Purity | |
| SSB Phase Noise at 1 GHz | –100 dBc/Hz @ 10 kHz offset from carrier (–104 dBc/Hz typical) –102 dBc/Hz @ 100 kHz offset from carrier (–107 dBc/Hz typical) –107 dBc/Hz @ 1 MHz offset from carrier (–114 dBc/Hz typical) –120 dBc/Hz @ 10 MHz offset from carrier (–129 dBc/Hz typical) |
| Amplitude Ranges | |
| Dynamic Range | > 104 dB @ 2.4 GHz, 2/3 (TOI-DANL) in 1 Hz RBW |
| Measurement Range | DANL to +30 dBm |
| Display Range | 1 to 15 dB/div in 1 dB steps, ten divisions displayed |
| Reference Level Range | –120 dBm to +30 dBm |
| Attenuator Resolution | 0 to 65 dB, 5 dB steps |
| Amplitude Units | Log Scale Modes: dBm, dBV, dBmV, dB μ V Linear Scale Modes: nV, μ V, mV, V, kV, nW, μ W, mW, W, kW |
| Maximum Continuous Input | +30 dBm Peak, ± 50 VDC (≥ 10 dB Attn) +23 dBm Peak, ± 50 VDC (< 10 dB Attn) +13 dBm Peak, ± 50 VDC (Preamp On) |
| Amplitude Accuracy (single sine wave input < Ref level, and > DANL, auto attenuation), Performance Sweep mode | |
| 20 $^{\circ}\text{C}$ to 30 $^{\circ}\text{C}$ after 30 minute warm-up | Typical: ± 0.5 dB, 100 kHz to 18 GHz Maximum: ± 1.3 dB, 100 kHz to 13 GHz Add ± 1.0 dB, 13 GHz to 18 GHz |
| –10 $^{\circ}\text{C}$ to 50 $^{\circ}\text{C}$ after 60 minute warm-up | Add ± 1.0 dB, 100 kHz to 20 GHz (typical) |
| Displayed Average Noise Level (DANL) (RMS detection, VBW/Avg type = Log., Ref Level = –20 dBm for preamp Off and –50 dBm for preamp On) | |
| (DANL in 1 Hz RBW, 0 dB attenuation) | Preamp Off |
| 10 MHz to 4 GHz | –141 dBm |
| > 4 GHz to 9 GHz | –134 dBm |
| > 9 GHz to 13 GHz | –129 dBm (MS2038C only) |
| > 13 GHz to 20 GHz | –123 dBm (MS2038C only) |
| | Preamp On |
| 10 MHz to 4 GHz | –160 dBm |
| > 4 GHz to 9 GHz | –156 dBm |
| > 9 GHz to 13 GHz | –152 dBm (MS2038C only) |
| > 13 GHz to 20 GHz | –145 dBm (MS2038C only) |
| Spurs | |
| Residual Spurious | Preamp Off (RF input terminated, 0 dB input attenuation) –90 dBm 9 kHz to 13 GHz –85 dBm 13 GHz to 20 GHz |
| | Preamp On (RF input terminated, 0 dB input attenuation) –100 dBm 1 MHz to 20 GHz |
| Input-Related Spurious | Preamp On (RF input terminated, 0 dB input attenuation) –100 dBm 1 MHz to 20 GHz |

Spectrum Analyzer Functional Specifications (Models MS2036/38C only) (continued)

Third-Order Intercept (TOI) (–20 dBm tones 100 kHz apart, –20 dBm Ref level, 0 dB input attenuation, preamp Off)

| | |
|---------------------------------------|-----------------|
| 2.4 GHz | +15 dBm |
| 50 MHz to 20 GHz | +20 dBm typical |
| P1dB | |
| < 4 GHz | +5 dBm typical |
| 4 GHz to 20 GHz | +12 dBm typical |
| Second Harmonic Distortion | |
| 50 MHz | –54 dBc |
| < 4 GHz | –60 dBc typical |
| > 4 GHz | –75 dBc typical |
| VSWR | |
| > 10 dB input attenuation < 20 GHz | 1:5:1 typical |

Measurements

| | |
|--------------------|---|
| Smart Measurements | Field Strength (uses antenna calibration tables to measure dBm/m ² or dBmV/m) Occupied Bandwidth (measures 99% to 1% power channel of a signal) Channel Power (measures the total power in a specified bandwidth) ACPR (adjacent channel power ratio) C/I (carrier-to-interference ratio) Emission Mask (recall limit lines as emission mask) |
|--------------------|---|

Setup Parameters

| | |
|----------------------|---|
| Frequency | Center/Start/Stop, Span, Frequency Step, Signal Standard, Channel # |
| Amplitude | Reference Level (RL), Scale, Attenuation Auto/Level, RL Offset, Pre-Amp On/Off, Detection |
| Span | Span, Span Up/Down (1-2-5), Full Span, Zero Span, Last Span |
| Bandwidth | RBW, Auto RBW, VBW, Auto VBW, RBW/VBW, Span/RBW |
| File | Save, Recall, Copy, Delete, Directory Management |
| Save/Recall | Setups, Measurements, Limit Lines, Screen Shots Jpeg (save only), Save-on-Event |
| Save-on-Event | Crossing Limit Line, Sweep Complete, Save-then-Stop, Clear All |
| Delete | Selected File, All Measurements, All Mode Files, All Content |
| Directory Management | Sort Method (Name/Type/Date), Ascend/Descend, Internal/USB, Copy |
| Application Options | Impedance (50 Ω, 75 Ω, Other) |

Sweep Functions

| | |
|------------|---|
| Sweep | Single/Continuous, Manual Trigger, Reset, Detection, Minimum Sweep Time, Trigger Type |
| Sweep Mode | Fast, Performance, No FFT |
| Detection | Peak, RMS/Avg, Negative, Sample, Quasi-peak |
| Triggers | Free Run, External, Video, Delay, Level, Slope, Hysteresis, Holdoff, Force Trigger Once |

Trace Functions

| | |
|--------------------|--|
| Traces | Up to three Traces (A, B, C), View/Blank, Write/Hold, Trace A/B/C Operations |
| Trace A Operations | Normal, Max Hold, Min Hold, Average, # of Averages, (always the live trace) |
| Trace B Operations | A→B, B↔C, Max Hold, Min Hold |
| Trace C Operations | A→C, B↔C, Max Hold, Min Hold, A – B→C, B – A→C, Relative Reference (dB), Scale |

Marker Functions

| | |
|----------------------|---|
| Markers | Markers 1-6 each with a Delta Marker, or Marker 1 Reference with Six Delta Markers, Marker Table (On/Off/Large), All Markers Off |
| Marker Types | Style (Fixed/Tracking), Noise Marker, Frequency Counter Marker |
| Marker Auto-Position | Peak Search, Next Peak (Right/Left), Peak Threshold %, Set Marker to Channel, Marker Frequency to Center, Delta Marker to Span, Marker to Reference Level |
| Marker Table | 1-6 markers frequency and amplitude plus delta markers frequency offset and amplitude |

Limit Line Functions

| | |
|---------------------|--|
| Limit Lines | Upper/Lower, On/Off, Edit, Move, Envelope, Advanced, Limit Alarm, Default Limit |
| Limit Line Edit | Frequency, Amplitude, Add Point, Add Vertical, Delete Point, Next Point Left/Right |
| Limit Line Move | To Current Center Frequency, By dB or Hz, To Marker 1, Offset from Marker 1 |
| Limit Line Envelope | Create Envelope, Update Amplitude, Number of Points (41), Offset, Shape Square/Slope |
| Limit Line Advanced | Type (Absolute/Relative), Mirror, Save/Recall |

Measurement Options Specifications

Time Domain (Option 0002) (includes Distance Domain Option 0501)

The VNA Master can also display the S-parameter measurements in the time or distance domain using lowpass or bandpass processing analysis modes. The broadband frequency coverage coupled with 4001 data points means you can measure discontinuities both near and far with unprecedented clarity for a handheld tool. With this option, you can simultaneously view S-parameters in frequency, time, and distance domain to quickly identify faults in the field. Advanced features available with this option include step response, phasor impulse, gating, and frequency gated in time. The option includes computational routines that further enhance the Distance Domain results by compensating for cable loss, relative velocity of propagation, and dispersion compensation in waveguide.

| | | |
|-----------------|--|--|
| Distance Domain | Round-Trip (reflection) Fault Resolution (meters): | $(0.5 \times c \times Vp) / \Delta F$; (c is speed of light = 3E8 m/s, ΔF is F2 – F1 in Hz) |
| | One-Way (transmission) Fault Resolution (meters): | $(c \times Vp) / \Delta F$; (c is speed of light = 3E8 m/s, ΔF is F2 – F1 in Hz) |
| | Horizontal Range (meters): | 0 to (data points – 1) x Fault Resolution to a maximum of 3000 m (9843 ft.) |
| | Windowing | Rectangular, Nominal Side Lobe (NSL), Low Side Lobe (LSL), and Minimum Side Lobe (MSL) |

Power Monitor (Option 0005) (Models MS2026/28C only) Requires external detector

Transmitter measurements in the field are possible when using this VNA Master software mode with a separately purchased Anritsu 560 series detector. A variety of detectors are available to 50 GHz, but the popular 560-7N50B covers 10 MHz to 20 GHz with a measurement range of –50 to +20 dBm with better than 0.5 dB flatness to 18 GHz. After zeroing the detector to ensure accuracy at low power levels, the software offers intuitive operation for absolute and relative readouts in dBm or Watts.

| | |
|-------------------|---|
| Display Range | –80 dBm to +80 dBm (10 pW to 100 kW) |
| Measurement Range | –50 dBm to +20 dBm (10 nW to 40 mW) |
| Offset Range | 0 dB to +60 dB |
| Resolution | 0.1 dB, 0.1 xW (x = n, μ , m based on detector power) |
| Accuracy | ± 1 dB maximum for >–40 dBm using 560-7N50B detector |

Power Monitor Detectors* (Ordered separately):

| | | |
|--------------------|---|---|
| Part Numbers | 560-7N50B | 560-7S50B |
| Frequency Range | 0.01 to 20 GHz | 0.01 to 20 GHz |
| Impedance | 50 Ω | 50 Ω |
| Power Range | –55 dBm to +16 dBm | –55 dBm to +16 dBm |
| Return Loss | 15 dB, < 0.04 GHz 22 dB, < 8 GHz 17 dB, < 18 GHz 14 dB, < 20 GHz | 15 dB, < 0.04 GHz 22 dB, < 8 GHz 17 dB, < 18 GHz 14 dB, < 20 GHz |
| Input Connector | N(m) | WSMA(m) |
| Frequency Response | ± 0.5 dB, < 18 GHz ± 1.25 dB, < 20 GHz | ± 0.5 dB, < 18 GHz ± 1.25 dB, < 20 GHz |

*See www.anritsu.com for additional detectors

Secure Data Operation (Option 0007)

For highly secure data handling requirements, this software option prevents the storing of measurement setup or data information onto any internal file storage location. Instead, setup and measurement information is stored ONLY to the external USB memory location. A simple factory preset prepares the VNA Master for transportation while the USB memory remains behind in the secure environment. The VNA Master cannot be switched between secure and non-secure operation by the user once configured for secure data operation. As an additional security measure, with this option enabled, the user can choose to blank the frequency values displayed on the screen.

Bias Tee (Option 0010)

For tower mounted amplifier tests, the MS20x/3xC series with optional internal bias tees can supply both DC and RF signals on the center conductor of the cable during measurements. For frequency sweeps in excess of 2 MHz, the VNA Master can supply internal voltage control from +12 to +32 V in 0.1 V steps up to 450 mA. To extend battery life, an external power supply can substitute for the internal supply by using the external bias inputs instead. Both test ports can be configured to supply voltage via this integrated bias tees option. Bias can be directed to VNA Port 1 or Port 2.

| | |
|--------------------------|---|
| Frequency Range | 2 MHz to 6 GHz (MS20x6C) 2 MHz to 20 GHz (MS20x8C) |
| Internal Voltage/Current | +12V to +32V at 450 ma. Steady rate |
| Internal Resolution | 0.1V |
| External Voltage/Current | ± 50 V at 500 mA steady rate |
| Bias Tee Selections | Internal, External, Off |

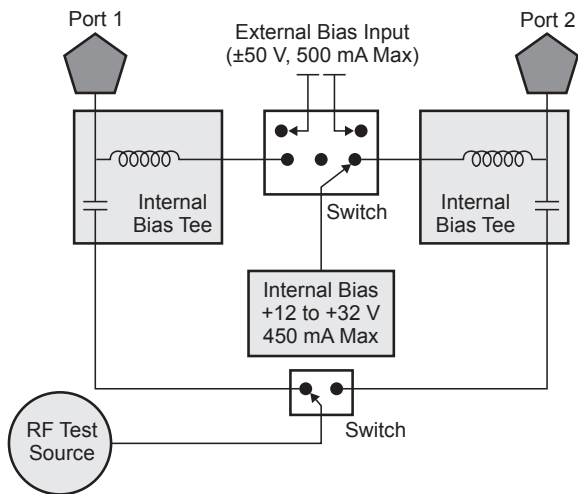

The VNA Master offers optional integrated bias tee for supplying DC plus RF to the DUT as shown in this simplified block diagram. Connectivity is also provided for external supply (instead of internal) to preserve battery consumption.

Vector Voltmeter (Option 0015)

A phased array system relies on phase matched cables for nominal performance. For this class of application, the VNA Master offers this special software mode to simplify phase matching cables at a single frequency. The similarity between the popular vector voltmeter and this software mode ensures minimal training is required to phase match cables. Operation is as simple as configuring the display for absolute or relative measurements. The easy-to-read large fonts show either reflection or transmission measurements using impedance, magnitude, or VSWR readouts. For instrument landing system (ILS) or VHF Omni-directional Range (VOR) applications, a table view improves operator efficiency when phase matching up to twelve cables. The MS202x/3xC solution is superior because the signal source is included internally, precluding the need for an external signal generator.

| | |
|---------------------|--|
| CW Frequency Range | 5 kHz to 20 GHz |
| Measurement Display | CW, Table (Twelve Entries, Plus Reference) |
| Measurement Types | Return Loss, Insertion |
| Measurement Format | dB/VSWR/Impedance |

High Accuracy Power Meter (Option 0019) Requires external USB power sensor.

Conduct precise measurements of CW and digitally modulated transmitters in the field using this VNA Master software mode with a separately purchased Anritsu USB power sensor. After specifying the center frequency and zeroing the sensor to ensure accuracy at low power levels, the software offers intuitive operation for absolute and relative readouts in dBm or Watts. Option 0019 supports the USB Power Sensors in the following table.

| USB Power Sensors (Ordered separately): | | | | | | | |
|--|---|--------------------------------------|--------------------------------------|---------------------------------------|---|---|---|
| | PSN50 | MA24104A | MA24105A | MA24106A | MA24108A | MA24118A | MA24126A |
| Frequency Range | 50 MHz to 6 GHz | 600 MHz to 4 GHz | 350 MHz to 4 GHz | 50 MHz to 6 GHz | 10 MHz to 8 GHz | 10 MHz to 18 GHz | 10 MHz to 26.5 GHz |
| Description | High Accuracy RF Power Sensor | Inline High Power Sensor | Inline Peak Power Sensor | High Accuracy RF Power Sensor | Microwave USB Power Sensor | Microwave USB Power Sensor | Microwave USB Power Sensor |
| Connector | Type N, male, 50 Ω | Type N, female, 50 Ω | Type N, female, 50 Ω | Type N, male, 50 Ω | Type N, male, 50 Ω | Type N, male, 50 Ω | Type N, male, 50 Ω |
| Dynamic Range | -30 dBm to +20 dBm (0.001 mW to 100 mW) | +3 dBm to +51.76 dBm (2 mW to 150 W) | +3 dBm to +51.76 dBm (2 mW to 150 W) | -40 dBm to +23 dBm (0.1 μW to 200 mW) | -40 dBm to +20 dBm (0.1 μW to 100 mW) | -40 dBm to +20 dBm (0.1 μW to 100 mW) | -40 dBm to +20 dBm (0.1 μW to 100 mW) |
| VBW | 100 Hz | 100 Hz | 100 Hz | 100 Hz | 50 kHz | 50 kHz | 50 kHz |
| Measurand | True-RMS | True-RMS | True-RMS | True-RMS | True-RMS, Slot power, Burst Average Power | True-RMS, Slot power, Burst Average power | True-RMS, Slot power, Burst Average power |
| Measurement Uncertainty | ± 0.16 dB ¹ | ± 0.17 dB ² | ± 0.17 dB ² | ± 0.16 dB ¹ | ± 0.18 dB ³ | ± 0.18 dB ³ | ± 0.18 dB ³ |
| Datasheet for Additional Specifications | 11410-00414 | 11410-00483 | 11410-00621 | 11410-00424 | 11410-00504 | 11410-00504 | 11410-00504 |

- Notes:
- 1) Total RSS measurement uncertainty (0 °C to 50 °C) for power measurements of a CW signal greater than -20 dBm with zero mismatch errors
 - 2) Expanded uncertainty with K=2 for power measurements of a CW signal greater than +20 dBm with a matched load. Measurement results referenced to the input side of the sensor.
 - 3) Expanded uncertainty with K=2 for power measurements of a CW signal greater than -20 dBm with zero mismatch errors

Interference Analyzer (Option 0025) (Models MS2036/38C only) (Recommend GPS)

| | |
|----------------------------|---|
| Measurements | Spectrum Field Strength Occupied Bandwidth Channel Power Adjacent Channel Power (ACPR) AM/FM/SSB Demodulation (Wide/Narrow FM, Upper/Lower SSB), (audio out only) Carrier-to-Interference ratio (C/I) Spectrogram (Collect data up to one week) Signal Strength (Gives visual and aural indication of signal strength) Received Signal Strength Indicator (RSSI) (collect data up to one week) Gives visual and aural indication of signal strength Signal ID (up to 12 signals) Center Frequency Bandwidth Signal Type (FM, GSM, W-CDMA, CDMA, Wi-Fi) Closest Channel Number Number of Carriers Signal-to-Noise Ratio (SNR) > 10 dB |
| Application Options | Bias-Tee (On/Off), Impedance (50 Ω, 75 Ω, Other) |

Channel Scanner (Option 0027) (Models MS2036/38C only)

| | |
|----------------------------|--|
| Number of Channels | 1 to 20 Channels (Power Levels) |
| Measurements | Graph/Table, Max Hold (On/5 sec/Off), Frequency/Channel, Current/Maximum, Dual Color |
| Scanner | Scan Channels, Scan Frequencies, Scan Customer List, Scan Script Master™ |
| Amplitude | Reference Level, Scale |
| Custom Scan | Signal Standard, Channel, # of Channels, Channel Step Size, Custom Scan |
| Frequency Range | 150 kHz to 13 GHz |
| Frequency Accuracy | ± 10 Hz + Time base error |
| Measurement Range | -110 dBm to +30 dBm |
| Application Options | Bias-Tee (On/Off), Impedance (50 Ω, 75 Ω, Other) |

GPS (Option 0031) Requires external GPS antenna

Built-in GPS provides location information (latitude, longitude, altitude) and Universal Time (UT) information for storage along with trace data so you can later verify that measurements were taken at the right location. The GPS option requires a separately ordered magnet mount GPS antenna (2000-1528-R or 2000-1652-R), which are configured to mount outside on a metallic surface. Frequency accuracy is enhanced for the Spectrum Analyzer (on MS203xC models) when Options 0025 Interference Analyzer and 0027 Channel Scanner are engaged.

| | |
|--|---|
| Setup | On/Off, Antenna Voltage 3.3/5.0 V, GPS Info |
| GPS Time/Location Indicator | Time, Latitude, Longitude, and Altitude on display Time, Latitude, Longitude, and Altitude with trace storage |
| High Frequency Accuracy | Spectrum Analyzer, Interference Analyzer, CW Signal Generator when GPS Antenna is connected < ± 50 ppb with GPS On, 3 minutes after satellite lock in selected mode |
| GPS Lock – after antenna is disconnected | < ± 50 ppb for 3 days, 0 °C to 50 °C ambient temperature |
| Connector | SMA, female |

Balanced/Differential S-Parameters, 1-port (Option 0077)

As an alternative to a sampling oscilloscope, verifying the performance and identifying discontinuities in high-data-rate differential cables is now possible with the VNA Master. After a full two-port calibration, connect your differential cable directly to the two test ports and reveal the S_{didi} performance, which is essentially differential return loss, or any of the other differential S-Parameters, S_{cici} , S_{dici} , or S_{cidi} . With optional time domain, you can convert frequency sweeps to distance. This capability is especially valuable for applications in high data rate cables where balanced data formats are used to isolate noise and interference.

Distance Domain (Option 0501) (included in Time Domain Option 0002)

Distance Domain Analysis is a powerful field test tool to analyze cables for faults, including minor discontinuities that may occur due to a loose connection, corrosion, or other aging effects. By using Frequency Domain Reflectometry (FDR), the VNA Master exploits a user-specified band of full power operational frequencies (instead of DC pulses from TDR approaches) to more precisely identify cable discontinuities. The VNA Master converts S-parameters from frequency domain into distance domain on the horizontal display axis, using a mathematical computation called Inverse Fourier Transform. Connect a reflection at the opposite end of the cable and the discontinuities appear versus distance to reveal any potential maintenance issues. When access to both ends of the cable is convenient, a similar distance domain analysis is available on transmission measurements.

Option 0501 Distance Domain will improve your productivity with displays of the cable in terms of discontinuities versus distance. This readout can then be compared against previous measurements (from stored data) to determine whether any degradations have occurred since installation (or the last maintenance activity). More importantly, you will know precisely where to go to fix the problem and so minimize or prevent downtime of the system.

AM/FM/PM Demodulation Analyzer (Option 0509) (Models MS2036C/38C only)

The VNA Master + Spectrum Analyzer models comes with AM/FM/SSB audio demodulation standard. By adding Option 0509, the instrument becomes capable of measuring, analyzing, and displaying key modulation parameters of RF Spectrum, Audio Spectrum, Audio Waveform and Demodulation Summary. The RF Spectrum View displays the spectrum analyzer with carrier power, frequency, and occupied BW. Audio Spectrum shows the demodulated audio spectrum along with the Rate, RMS deviation, Pk-Pk/2 deviation, SINAD, Total Harmonic Distortion (THD), and Distortion/Total. Each demodulation also includes an Audio Waveform oscilloscope display that shows the time-domain demodulated waveform. There is a summary display that provides a display of all the RF and demodulation parameters.

VNA Master General Specifications (MS202x/3xC)

Setup Parameters

| | |
|------------------------------------|--|
| System | Status (Temperature, Battery Info, S/N, Firmware Ver, IP Address, Options Installed) Self Test, Application Self Test GPS (see Option 0031) |
| System Options | Name, Date and Time, Ethernet Configuration, Brightness, Volume Language (English, French, German, Spanish, Chinese, Japanese, Korean, Italian, User defined) Reset (Factory Defaults, Master Reset, Update Firmware) |
| File | Save, Recall, Delete, Directory Management |
| Save/Recall | Setups, Measurements, Screen Shots Jpeg (save only) |
| Delete | Selected File, All Measurements, All Mode Files, All Content |
| Directory Management | Sort Method (Name/Type/Date), Ascend/Descend, Internal/USB, Copy |
| Internal Trace/Setup Memory | > 13,000 traces |
| External Trace/Setup Memory | Limited by size of USB Flash drive |
| Mode Switching | Auto-Stores/Recalls most recently used Setup Parameters in the Mode |

Connectors

| | |
|--|--|
| Maximum Input (Damage Level) into Vector Network Analyzer | +23 dBm, ± 50 VDC (MS202x/3xC) |
| Maximum Input (Damage Level) into Spectrum Analyzer | +30 dBm, ± 50 VDC (MS203xC) |
| VNA Connectors | Type N female (or K female with opt 0011, MS20x8C only) VNA port (x2) |
| | Type BNC female Bias Tee port (enabled with opt 0010) (x2) |
| | Type BNC female External Reference In port |
| Spectrum Analyzer Connectors | Type N, female (or K female with opt 0011) (MS203xC) |
| GPS | SMA female (Available with opt 0031 GPS) |
| External Power | 5.5 mm barrel connector, 12 to 15 VDC, < 5.0 Amps |
| LAN Connection | RJ48C, 10/100 Mbps, Connect to PC or LAN for Remote Access |
| USB Interface (2) | Type A, Connect Flash Drive and Power Sensor |
| USB Interface | 5-pin mini-B, Connect to PC for data transfer |
| Headset Jack | 3.5 mm barrel connector |
| External Trigger | BNC, female, 50 Ω, Maximum Input ± 5 VDC |
| 10 MHz Out | SMA, female, 50 Ω |

Display

| | |
|-------------------|-------------------------------------|
| Size | 8.4 in, daylight viewable color LCD |
| Resolution | 800 x 600 |

Power

| | |
|--|---|
| Field replaceable Li-Ion Battery (633-44: 6600 mAh, 4.5 Amps) | 40 Watts on battery power only |
| DC power from Universal 110/220V AC/DC Adapter | 55 Watts running off AC/DC adaptor while charging battery |
| Life time charging cycles (Li-Ion Battery, 633-44) | > 300 (80% of initial capacity) |
| Battery Operation | 2.5 hours, typical |

Size and Weight

| | | |
|----------------------------------|-------------------|--|
| Dimensions | Height | 211 mm (8.3 in) |
| | Width | 315 mm (12.4 in) |
| | Depth | 78 mm (3.1 in) (MS202xC) 97 mm (3.8 in) (MS203xC) |
| Weight, Including Battery | 4.5 kg (9.9 lbs) | (MS202xC) |
| | 4.8 kg (10.5 lbs) | (MS203xC) |

Safety

| | |
|-----------------------|--|
| Safety Class | EN 61010-1 Class 1 |
| Product Safety | IEC 60950-1 when used with Anritsu supplied Power Supply |

Environmental

| MIL-PRF-28800F, Class 2 Environmental Conditions | MS202x/3xC |
|---|---------------------------------------|
| Temperature, operating (°C) (3.8.2.1 & 4.5.5.14) | Passed, -10 °C to 55 °C, Humidity 85% |
| Temperature, not operating (°C) (3.8.2.2 & 4.5.5.1) | Passed, -51 °C to 71 °C |
| Relative humidity (3.8.2.3 & 4.5.5.1) | Passed |
| Altitude, not operating (3.8.3 & 4.5.5.2) | Passed*, 4600 m |
| Altitude, operating (3.8.3 & 4.5.5.2) | Passed*, 4600 m |
| Vibration limits (3.8.4.1 & 4.5.5.3.1) | Passed |
| Shock, functional (3.8.5.1 & 4.5.5.4.1) | Passed |
| Transit Drop (3.8.5.2 & 4.5.5.4.2) | Passed |
| Bench handling (3.8.5.3 & 4.5.5.4.3) | Passed |
| Shock, high impact (3.8.5.4 & 4.5.5.4.4) | Not Required** |
| Salt exposure structural parts (3.8.8.2 & 4.5.6.2.2) | Not Required*** |

* Qualified by similarity (tested on a similar product)

** Not defined in standard; must be invoked and defined by purchase description

*** Not required for Class 2 equipment

Electromagnetic Compatibility

| | |
|----------------------------------|--|
| European Union | CE Mark, EMC Directive 89/336/EEC, 92/31/EEC, 93/68/EEC and Low Voltage Directive 73/23/EEC, 93/68/EEC |
| Australia and New Zealand | C-tick N274 |
| Interference | EN 61326-1 |
| Emissions | EN 55011 |
| Immunity | EN 61000-4-2/-4-3/-4-4/-4-5/-4-6/-4-11 |

Ordering Information

| MS2026C ¹ | MS2028C ¹ | MS2036C ¹ | MS2038C ¹ | |
|--|---|--|---|--|
| VNA Master, 2-port, VNA 5 kHz to 6 GHz | VNA Master, 2-port, VNA 5 kHz to 20 GHz | VNA Master + Spectrum Analyzer, S/A 9 kHz to 9 GHz | VNA Master + Spectrum Analyzer, S/A 9 kHz to 20 GHz | |
| Options | | | | Description |
| MS2026C-0002 | MS2028C-0002 | MS2036C-0002 | MS2038C-0002 | Time Domain (includes DTF capability) |
| MS2026C-0005 | MS2028C-0005 | – | – | Power Monitor (requires external detector) |
| MS2026C-0007 | MS2028C-0007 | MS2036C-0007 | MS2038C-0007 | Secure Data Operation |
| MS2026C-0010 | MS2028C-0010 | MS2036C-0010 | MS2038C-0010 | Built-in Bias-Tee |
| – | MS2028C-0011 | – | MS2038C-0011 | K(f) Test Port Connectors |
| MS2026C-0015 | MS2028C-0015 | MS2036C-0015 | MS2038C-0015 | Vector Voltmeter |
| MS2026C-0019 | MS2028C-0019 | MS2036C-0019 | MS2038C-0019 | High Accuracy Power Meter (requires external USB sensor) |
| – | – | MS2036C-0025 | MS2038C-0025 | Interference Analysis, 9 kHz to 9/20 GHz ² |
| – | – | MS2036C-0027 | MS2038C-0027 | Channel Scanner, 9 kHz to 9/20 GHz ² |
| MS2026C-0031 | MS2028C-0031 | MS2036C-0031 | MS2038C-0031 | GPS Receiver (requires GPS antenna, 2000-1528-R or 2000-1652-R) |
| MS2026C-0077 | MS2028C-0077 | MS2036C-0077 | MS2038C-0077 | Balanced/Differential S-Parameters, 1-port |
| MS2026C-0098 | MS2028C-0098 | MS2036C-0098 | MS2038C-0098 | Z-540 Calibration |
| MS2026C-0099 | MS2028C-0099 | MS2036C-0099 | MS2038C-0099 | Premium Calibration |
| MS2026C-0501 | MS2028C-0501 | MS2036C-0501 | MS2038C-0501 | Distance Domain (included in Option 0002) |
| – | – | MS2036C-0509 | MS2038C-0509 | AM/FM/PM Analyzer |

Notes:

1) Includes standard one-year warranty and Certificate of Calibration and Conformance.

2) Requires external antenna (Series 2000-xxxx Antenna, or 61532 Antenna Kit), Recommend Option 0031 GPS.

MS202x/3xC Standard Accessories

| | |
|-------------|--|
| 10920-00060 | Handheld Instruments Documentation Disc |
| 10580-00220 | VNA Master User's Guide |
| 65729 | Soft Carrying Case |
| 2300-498 | Master Software Tools CD ROM |
| 633-44 | Rechargeable Battery, Li-Ion, 6.6 Ah |
| 40-168-R | AC-DC Adapter |
| 806-141-R | Automotive Cigarette Lighter 12 V DC adapter |
| 3-2000-1498 | USB A-type to Mini USB B-type cable, 3.05 m (10 ft.) |
| 2000-1371-R | Ethernet cable, 2.13 m (7 ft.) |
| 3-806-152 | Ethernet Crossover Cable, 2.13 m (7 ft.) |

Optional Accessories

Ancillary Equipment

| | |
|-------------|--|
| 2000-1528-R | GPS Antenna – Magnet Mount (active 3-5V) with SMA connector and 4.6 m (15 ft) extension cable |
| 2000-1652-R | GPS Antenna – Magnet mount (active 3-5V) with SMA connector and 1 foot cable |
| ODTF-1 | Optical Time Domain Module |
| 2000-1653 | Protective Screen Cover (Package of 2) |
| 2300-517 | Phase Noise Measurement Software |
| 66864 | Rack Mount Kit, Master Platform |

High Accuracy Power Sensor

| | |
|----------|---|
| PSN50 | High Accuracy Power Sensor, 50 MHz to 6 GHz |
| MA24104A | Inline High Power Sensor, 600 MHz to 4 GHz, True RMS |
| MA24105A | Inline Peak Power Sensor, 350 MHz to 4 GHz, True RMS |
| MA24106A | High Accuracy Power Sensor, 50 MHz to 6 GHz, True RMS |
| MA24108A | High Accuracy Power Sensor, 10 MHz to 8 GHz, True RMS |
| MA24118A | High Accuracy Power Sensor, 10 MHz to 18 GHz, True RMS |
| MA24126A | High Accuracy Power Sensor, 10 MHz to 26 GHz, True RMS |

Power Monitor Detectors

| | |
|-----------|--|
| 560-7N50B | RF Detector, 0.01 to 20 GHz, Type-N(m) |
| 560-7S50B | RF Detector, 0.01 to 20 GHz, W-SMA(m) |

Detector Extender Cables

| | |
|---------|---|
| 800-109 | Detector Extender Cable, 7.6 m (25 ft) |
| 800-111 | Detector Extender Cable, 30.5 m (100 ft.) |

K Connector Components

| | |
|---------|--|
| OSLK50 | Precision integrated Open/Short/Load K(m), DC to 20 GHz, 50 Ω |
| OSLKF50 | Precision integrated Open/Short/Load K(f), DC to 20 GHz, 50 Ω |
| 22K50 | Precision K(m) Short/Open, 40 GHz |
| 22KF50 | Precision K(f) Short/Open, 40 GHz |
| 28K50 | Precision Termination, DC to 40 GHz, 50 Ω, K(m) |
| 28KF50 | Precision Termination, DC to 40 GHz, 50 Ω, K(f) |
| 3652A | K Calibration Kit, DC to 40 GHz |

N-Type Connectors

| | |
|-----------|--|
| OSLN50 | Precision Integrated Open/Short/Load N(m), DC to 18 GHz, 50 Ω |
| OSLNF50 | Precision Integrated Open/Short/Load N(f), DC to 18 GHz, 50 Ω |
| 22N50 | Precision N(m) Short/Open, 18 GHz |
| 22NF50 | Precision N(f) Short/Open, 18 GHz |
| 28N50-2 | Precision Termination, DC to 18 GHz, 50 Ω, N(m) |
| 28NF50-2 | Precision Termination, DC to 18 GHz, 50 Ω, N(f) |
| OSLN50-1 | Precision N(m) Open/Short/Load, 42 dB, 6 GHz |
| OSLNF50-1 | Precision N(f) Open/Short/Load, 42 dB, 6 GHz |
| SM/PL-1 | Precision N(m) Load, 42 dB, 6 GHz |
| SM/PLNF-1 | Precision N(f) Load, 42 dB, 6 GHz |

continued on next page...

Ordering Information (continued)

Phase-Stable Test Port Cables, Armored

| | |
|--------------|--|
| 15NNF50-1.5C | 1.5 m, DC to 6 GHz, N(m) to N(f), 50 Ω |
| 15NN50-1.5C | 1.5 m, DC to 6 GHz, N(m) to N(m), 50 Ω |
| 15NDF50-1.5C | 1.5 m, DC to 6 GHz, N(m) to 7/16 DIN(f), 50 Ω |
| 15ND50-1.5C | 1.5 m, DC to 6 GHz, N(m) to 7/16 DIN(m), 50 Ω |
| 15NNF50-3.0C | 3.0 m, DC to 6 GHz, N(m) to N(f), 50 Ω |
| 15NN50-3.0C | 3.0 m, DC to 6 GHz, N(m) to N(m), 50 Ω |

Directional Antennas

| | |
|-------------|--|
| 2000-1411-R | 824 MHz to 896 MHz, N(f), 10 dBd, Yagi |
| 2000-1412-R | 885 MHz to 975 MHz, N(f), 10 dBd, Yagi |
| 2000-1413-R | 1710 MHz to 1880 MHz, N(f), 10 dBd, Yagi |
| 2000-1414-R | 1850 MHz to 1990 MHz, N(f), 9.3 dBd, Yagi |
| 2000-1415-R | 2400 MHz to 2500 MHz, N(f), 10 dBd, Yagi |
| 2000-1416-R | 1920 MHz to 2170 MHz, N(f), 10 dBd, Yagi |
| 2000-1519-R | 500 MHz to 3000 MHz, log periodic |
| 2000-1617 | 600 MHz to 21000 MHz, N(f), 5-8 dBi to 12 GHz, 0-6 dBi to 21 GHz, log periodic |

Portable Antennas

| | |
|-------------|---|
| 2000-1200-R | 806 MHz to 866 MHz, SMA(m), 50 Ω |
| 2000-1473-R | 870 MHz to 960 MHz, SMA(m), 50 Ω |
| 2000-1035-R | 896 MHz to 941 MHz, SMA (m), 50 Ω (1/4 wave) |
| 2000-1030-R | 1710 MHz to 1880 MHz, SMA(m), 50 Ω (1/2 wave) |
| 2000-1474-R | 1710 MHz to 1880 MHz with knuckle elbow (1/2 wave) |
| 2000-1031-R | 1850 MHz to 1990 MHz, SMA(m), 50 Ω (1/2 wave) |
| 2000-1475-R | 1920 MHz to 1980 MHz and 2110 MHz to 2170 MHz, SMA(m), 50 Ω |
| 2000-1032 | 2400 MHz to 2500 MHz, SMA(m), 50 Ω (1/2 wave) |
| 2000-1361-R | 2400 MHz to 2500 MHz, 5000 MHz to 6000 MHz, SMA(m), 50 Ω |
| 2000-1616 | 20 MHz to 21000 MHz, N(f), 50 Ω |
| 2000-1636-R | Antenna Kit (Consists of: 2000-1030-R, 2000-1031-R, 2000-1032-R, 2000-1200-R, 2000-1035-R, 2000-1361-R, and carrying pouch) |
| 2000-1487 | Telescopic Whip Antenna |

Bandpass Filters

| | |
|------------|--|
| 1030-114-R | 806 MHz to 869 MHz, N(m) to SMA(f), 50 Ω |
| 1030-109-R | 824 MHz to 849 MHz, N(m) to SMA (f), 50 Ω |
| 1030-110-R | 880 MHz to 915 MHz, N(m) to SMA (f), 50 Ω |
| 1030-105-R | 890 MHz to 915 MHz, N(m) to N(f), 50 Ω |
| 1030-111-R | 1850 MHz to 1910 MHz, N(m) to SMA (f), 50 Ω |
| 1030-106-R | 1710 MHz to 1790 MHz, N(m) to N(f), 50 Ω |
| 1030-107-R | 1910 MHz to 1990 MHz, N(m) to N(f), 50 Ω |
| 1030-112-R | 2400 MHz to 2484 MHz, N(m) to SMA (f), 50 Ω |
| 1030-155-R | 2500 MHz to 2700 MHz, N(m) to N(f), 50 Ω |

Adapters

| | |
|-----------|---|
| 1091-26-R | SMA(m) to N(m), DC to 18 GHz, 50 Ω |
| 1091-27-R | SMA(f) to N(m), DC to 18 GHz, 50 Ω |
| 1091-80-R | SMA(m) to N(f), DC to 18 GHz, 50 Ω |
| 1091-81-R | SMA(f) to N(f), DC to 18 GHz, 50 Ω |
| 1091-172 | BNC(f) to N(m), DC to 1.3 GHz, 50 Ω |
| 510-90 | 7/16 DIN(f) to N(m), DC to 7.5 GHz, 50 Ω |
| 510-91 | 7/16 DIN(f) to N(f), DC to 7.5 GHz, 50 Ω |
| 510-92 | 7/16 DIN(m) to N(m), DC to 7.5 GHz, 50 Ω |
| 510-93 | 7/16 DIN(m) to N(f), DC to 7.5 GHz, 50 Ω |
| 510-96 | 7/16 DIN(m) to 7/16 DIN (m), DC to 7.5 GHz, 50 Ω |

| | |
|------------|---|
| 510-97 | 7/16 DIN(f) to 7/16 DIN(f), DC to 7.5 GHz, 50 Ω |
| 1091-379-R | 7/16 DIN(f) to 7/16 DIN(f), DC to 6 GHz, 50 Ω , with Reinforced Grip |
| 510-102-R | N(m) to N(m), DC to 11 GHz, 50 Ω , 90 degrees right angle |

Precision Adapters

| | |
|---------|--|
| 34NN50A | Precision Adapter, N(m) to N(m), DC to 18 GHz, 50 Ω |
| 34NFN50 | Precision Adapter, N(f) to N(f), DC to 18 GHz, 50 Ω |
| 34NK50 | Precision Adapter, DC to 18 GHz, N(m) to K(m), 50 Ω |
| 34NKF50 | Precision Adapter, DC to 18 GHz, N(m) to K(f), 50 Ω |

Attenuators

| | |
|------------|--|
| 3-1010-122 | 20 dB, 5 W, DC to 12.4 GHz, N(m) to N(f) |
| 42N50-20 | 20 dB, 5 W, DC to 18 GHz, N(m) to N(f) |
| 42N50A-30 | 30 dB, 50 W, DC to 18 GHz, N(m) to N(f) |
| 3-1010-123 | 30 dB, 50 W, DC to 8.5 GHz, N(m) to N(f) |
| 1010-127-R | 30 dB, 150 W, DC to 3 GHz, N(m) to N(f) |
| 3-1010-124 | 40 dB, 100 W, DC to 8.5 GHz, N(m) to N(f), Uni-directional |
| 1010-121 | 40 dB, 100 W, DC to 18 GHz, N(m) to N(f), Uni-directional |
| 1010-128-R | 40 dB, 150 W, DC to 3 GHz, N(m) to N(f) |

Backpack and Transit Case

| | |
|-----------|---|
| 67135 | Anritsu Backpack (For Handheld Instrument and PC) |
| 760-243-R | Large Transit Case with Wheels and Handle |

Manuals

| | |
|-------------|---|
| 10580-00215 | ODTF-1 Optical Distance-to-Fault Module – Quick Start Guide |
| 10580-00240 | Power Meter Measurement Guide |
| 10580-00244 | Spectrum Analyzer Measurement Guide |
| 10580-00289 | VNA Measurement Guide |
| 10580-00305 | VNA Master User's Guide |
| 10580-00306 | VNA Master Programming Manual |
| 10580-00307 | VNA Master Maintenance Manual |

Related Literature, Application Notes, Books

| | |
|-------------|---|
| 11410-00206 | Time Domain for Vector Network Analyzers |
| 11410-00214 | Reflectometer Measurements – Revisited |
| 11410-00270 | What is Your Measurement Accuracy? |
| 11410-00373 | Distance-to-Fault |
| 11410-00387 | Primer on Vector Network Analysis |
| 11410-00414 | High Accuracy Power Meter, PSN50 |
| 11410-00424 | USB Power Sensor MA24106A |
| 11410-00472 | Measuring Interference |
| 11410-00476 | Essentials of Vector Network Analysis |
| 11410-00483 | Inline High Power Sensor MA24104A |
| 11410-00504 | Microwave USB Power Sensor MA241x8A |
| 11410-00531 | Practical Tips on Making “Vector Voltmeter (VVM)” Phase Measurements using VNA Master (Opt. 15) |
| 11410-00544 | VNA Master + Spectrum Analyzer Brochure |
| 11410-00548 | VNA Master + Spectrum Analyzer Technical Data Sheet |
| 11410-00565 | Troubleshoot Wire Cable Assemblies with Frequency-Domain Reflectometry |

Waveguide Calibration Components and WG/Coaxial Adapters

Recommended waveguide calibration procedure requires two offset shorts and a precision load. The waveguide/coax adapter, shown attached to test port #1, adapts the VNA Master test ports to the waveguide under test.

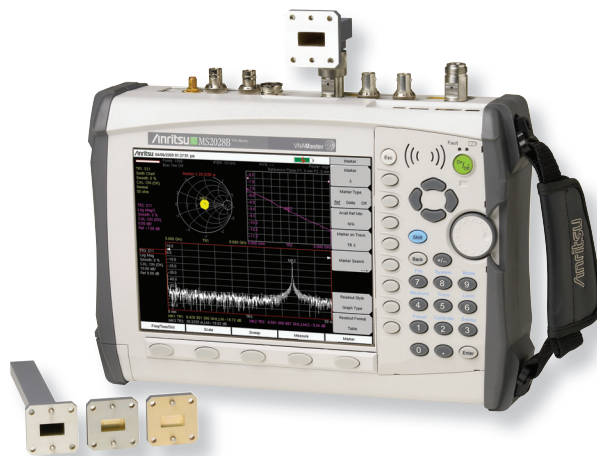

| Part Number | | | | Frequency Range | Waveguide Type | Compatible Flanges |
|------------------|------------------|----------------|---|--------------------|----------------|--|
| 1/8 Offset Short | 3/8 Offset Short | Precision Load | Coaxial to Universal Waveguide Adapter ^[1] | | | |
| 23UM70 | 24UM70 | 26UM70 | 35UM70N | 5.85 to 8.20 GHz | WR137, WG14 | CAR70, PAR70, UAR 70, PDR70 |
| 23UM84 | 24UM84 | 26UM84 | 35UM84N | 7.05 to 10.00 GHz | WR112, WG15 | CBR84, UBR84, PBR84, PDR84 |
| 23UM100 | 24UM100 | 26UM100 | 35UM100N | 8.20 to 12.40 GHz | WR90, WG16 | CBR100, UBR100, PBR100, PDR100 |
| 23UM120 | 24UM120 | 26UM120 | 35UM120N | 10.00 to 15.00 GHz | WR75, WG17 | CBR120, UBR120, PBR120, PDR120 |
| 23UA187 | 24UA187 | 26UA187 | 35UA187N | 3.95 to 5.85 GHz | WR187, WG12 | CPR187F, CPR187G, UG-1352/U, UG-1353/U, UG-1728/U, UG-1729/U, UG-148/U, UG-149A/U |
| 23UA137 | 24UA137 | 26UA137 | 35UA137N | 5.85 to 8.20 GHz | WR137, WG14 | CPR137F, CPR137G, UG-1356/U, UG-1357/U, UG-1732/U, UG-1733/U, UG-343B/U, UG-344/U, UG-440B/U, UG-441/U |
| 23UA112 | 24UA112 | 26UA112 | 35UA112N | 7.05 to 10.00 GHz | WR112, WG15 | CPR112F, CPR112G, UG-1358/U, UG-1359/U, UG-1734/U, UG-1735/U, UG-52B/U, UG-51/U, UG-137B/U, UG-138/U |
| 23UA90 | 24UA90 | 26UA90 | 35UA90N | 8.20 to 12.40 GHz | WR90, WG16 | CPR90F, CPR90G, UG-1360/U, UG-1361/U, UG-1736/U, UG-1737/U, UG-40B/U, UG-39/U, UG-135/U, UG-136B/U |
| 23UA62 | 24UA62 | 26UA62 | 35UA62N | 12.40 to 18.00 GHz | WR62, WG18 | UG-541A/U, UG-419/U, UG-1665/U, UG1666/U |
| 23UA42 | 24UA42 | 26UA42 | 35UA42K | 17.00 to 26.50 GHz | WR42, WG20 | UG-596A/U, UG-595/U, UG-597/U, UG-598A/U |

[1] For Coaxial/Waveguide Adapter part numbers, N designates Type N and K designates K-Connector

The Master Users Group is an organization dedicated to providing training, technical support, networking opportunities and links to Master product development teams. As a member you will receive the Insite Quarterly Newsletter with user stories, measurement tips, new product news and more.

Visit us to register today: www.anritsu.com/MUG



To receive a quote to purchase a product or order accessories visit our online ordering site: www.ShopAnritsu.com

Training at Anritsu

Anritsu has designed courses to help you stay up to date with technologies important to your job. For available training courses visit: www.anritsu.com/training

Anritsu

• United States

Anritsu Company

1155 East Collins Boulevard, Suite 100,
Richardson, TX, 75081 U.S.A.
Toll Free: 1-800-ANRITSU (267-4878)
Phone: +1-972-644-1777
Fax: +1-972-671-1877

• Canada

Anritsu Electronics Ltd.

700 Silver Seven Road, Suite 120,
Kanata, Ontario K2V 1C3, Canada
Phone: +1-613-591-2003
Fax: +1-613-591-1006

• Brazil

Anritsu Eletrônica Ltda.

Praça Amadeu Amaral, 27 - 1 Andar
01327-010 - Bela Vista - São Paulo - SP - Brazil
Phone: +55-11-3283-2511
Fax: +55-11-3288-6940

• Mexico

Anritsu Company, S.A. de C.V.

Av. Ejército Nacional No. 579 Piso 9, Col. Granada
11520 México, D.F., México
Phone: +52-55-1101-2370
Fax: +52-55-5254-3147

• United Kingdom

Anritsu EMEA Ltd.

200 Capability Green, Luton, Bedfordshire LU1 3LU, U.K.
Phone: +44-1582-433280
Fax: +44-1582-731303

• France

Anritsu S.A.

12 avenue du Québec, Batiment Iris 1-Silic 612,
91140 VILLEBON SUR YVETTE, France
Phone: +33-1-60-92-15-50
Fax: +33-1-64-46-10-65

• Germany

Anritsu GmbH

Nemetschek Haus, Konrad-Zuse-Platz 1
81829 München, Germany
Phone: +49 (0) 89 442308-0
Fax: +49 (0) 89 442308-55

• Italy

Anritsu S.r.l.

Via Elio Vittorini 129 00144 Roma Italy
Phone: +39-06-509-9711
Fax: +39-06-502-2425

• Sweden

Anritsu AB

Borgafjordsgatan 13, 164 40 KISTA, Sweden
Phone: +46-8-534-707-00
Fax: +46-8-534-707-30

• Finland

Anritsu AB

Teknobulevardi 3-5, FI-01530 Vantaa, Finland
Phone: +358-20-741-8100
Fax: +358-20-741-8111

• Denmark

Anritsu A/S (for Service Assurance) Anritsu AB (for Test & Measurement)

Kay Fiskers Plads 9, 2300 Copenhagen S, Denmark
Phone: +45-7211-2200
Fax: +45-7211-2210

• Russia

Anritsu EMEA Ltd.

Representation Office in Russia

Tverskaya str. 16/2, bld. 1, 7th floor.
Russia, 125009, Moscow
Phone: +7-495-363-1694
Fax: +7-495-935-8962

• United Arab Emirates

Anritsu EMEA Ltd.

Dubai Liaison Office

P O Box 500413 - Dubai Internet City
Al Thuraya Building, Tower 1, Suite 701, 7th Floor
Dubai, United Arab Emirates
Phone: +971-4-3670352
Fax: +971-4-3688460

• Singapore

Anritsu Pte. Ltd.

60 Alexandra Terrace, #02-08, The Comtech (Lobby A)
Singapore 118502
Phone: +65-6282-2400
Fax: +65-6282-2533

• India

Anritsu Pte. Ltd.

India Branch Office

3rd Floor, Shri Lakshminarayan Niwas, #2726, 80 ft Road,
HAL 3rd Stage, Bangalore - 560 075, India
Phone: +91-80-4058-1300
Fax: +91-80-4058-1301

• P. R. China (Shanghai)

Anritsu (China) Co., Ltd.

Room 1715, Tower A CITY CENTER of Shanghai,
Shanghai 200051, P.R. China
Phone: +86-21-6237-0898
Fax: +86-21-6237-0899

• P. R. China (Hong Kong)

Anritsu Company Ltd.

Unit 1006-7, 10/F., Greenfield Tower, Concordia Plaza,
No. 1 Science Museum Road, Tsim Sha Tsui East,
Kowloon, Hong Kong, P. R. China
Phone: +852-2301-4980
Fax: +852-2301-3545

• Japan

Anritsu Corporation

8-5, Tamura-cho, Atsugi-shi,
Kanagawa, 243-0016 Japan
Phone: +81-46-296-1221
Fax: +81-46-296-1238

• Korea

Anritsu Corporation, Ltd.

502, 5FL H-Square N B/D, 681,
Sampyeong-dong, Bundang-gu, Seongnam-si,
Gyeonggi-do, 463-400 Korea
Phone: +82-31-696-7750
Fax: +82-31-696-7751

• Australia

Anritsu Pty Ltd.

Unit 21/270 Ferntree Gully Road,
Notting Hill, Victoria 3168, Australia
Phone: +61-3-9558-8177
Fax: +61-3-9558-8255

• Taiwan

Anritsu Company Inc.

7F, No. 316, Sec. 1, Neihu Rd., Taipei 114, Taiwan
Phone: +886-2-8751-1816
Fax: +886-2-8751-1817



Anritsu prints on recycled paper with vegetable soybean oil ink.



©Anritsu All trademarks are registered trademarks of their respective companies. Data subject to change without notice. For the most recent specifications visit: www.anritsu.com

MS20xxC VNA Master TDS
©2012 Anritsu Company, USA
All Rights Reserved



11410-00548



F