

Infiniium UXR-B Series Oscilloscopes

Experience A New Level of Speed with The Most Advanced Oscilloscope on the Planet: Infiniium UXR-B

Introduction

The UXR-B Runs Faster. Reduce test time by up to 70% for compliance applications and general measurements.

The UXR-B Has More Accurate Analysis. Accurate measurement of PAMn signals, including SNDR, can be achieved with the help of new noise reduction waveform features and noise compensation technology.

The UXR-B Has More Features. The standard 500 Mpts feature enables capturing waveforms that are 2.5 times longer than previous models. Additionally, wider DDC and RTSA bandwidths facilitate faster analysis and debugging of wireless signals. Furthermore, InfiniiSim Basic de-embedding, Precision Cable, and Precision Probe are now included as standard, which allows for the removal of channel loss in high-speed digital designs.



Key Features

- Up to 110 GHz of real-time oscilloscope bandwidth
- High-definition 10-bit analog-to-digital converter (ADC)
- Full bandwidth and channel upgradability
- The industry's lowest noise and jitter measurement floor
- The industry's highest ENOB at all supported bandwidth

Table of Contents

- Key Features 1
- Model Overview 3
- Meet the 1 mm Ruggedized Input Models 6
- Meet the 1.85 mm Ruggedized Input Models 7
- Meet the 3.5 mm Ruggedized Input Models 8
- Groundbreaking Oscilloscope Technology 9
- Industry's Most Advanced and Flexible Probing System 20
- Infiniium User Interface - Ultimate Acquisition and Visibility 23
- Advanced Capabilities & Applications 24
- Infiniium UXR-Series Analysis Tools 30
- More Information 45

NOTE:

For ordering infirmation, see the [Infiniium UXR-B Series Oscilloscopes Configuration Guide](#).

For a detail of specification, see the [Infiniium UXR-B Series Oscilloscopes Data Sheet](#).

Do What Has Never Done

The world's insatiable demand for better performance, shorter design cycles and faster systems with ever more bandwidth has driven the need for a new class of modular ultra-high-performance oscilloscopes with upgradable bandwidths from 5 GHz to 110 GHz, extremely low noise floors, 10-bit high-definition vertical resolution, femtoseconds of intrinsic jitter, deep memory and hardware accelerated waveform processing. That's the promise of Keysight Technologies Infiniium UXR-Series oscilloscopes. They are undeniably the fastest, lowest noise, highest signal fidelity and most powerful oscilloscopes in the world – with the features and performance necessary to enable and accelerate the next generation of electronic research and design.

Model Overview

The UXR is available in three different model categories based on available bandwidth, sample rate and input connector size. Infiniium UXR-Series models offer bandwidths from 5 GHz to 110 GHz with various 1-channel, 2-channel, or 4-channel configurations available. The 3.5mm models are equipped with Keysight AutoProbe II interfaces while 1mm and 1.85 mm models incorporate an advanced high-performance high-bandwidth Keysight AutoProbe III interface.



1 mm input models



1.85 mm input models



3.5 mm input models

Model	Bandwidth (Maximum)		Connector	Power Required		Sample Rate (Maximum)
	4-Channel	2-channel		4-channel	2-channel	
UXR1104B	UXR1102B	110 GHz	1 mm	200 to 240 V _{ac} 2615 VA(Max)	110 to 240 V _{ac} 1350 VA (Max)	256 GSa/s
UXR1004B	UXR1002B	100 GHz				
UXR0804B	UXR0802B	80 GHz				
UXR0704BP	UXR0702BP	70 GHz				
UXR0594BP	UXR0592BP	59 GHz				
UXR0404BP	UXR0402BP	40 GHz				
UXR0254BP	UXR0252BP	25 GHz				
N/A	UXR0051BP ¹	5 GHz	1.85 mm			
UXR0704B	UXR0702B	70 GHz				
UXR0594B	UXR0592B	59 GHz				
UXR0504B	UXR0502B	50 GHz				
UXR0404B	UXR0402B	40 GHz				
UXR0334B	N/A	33 GHz	3.5 mm	100 to 240 V _{ac} 1350 VA (Max)	N/A	128 GSa/s
UXR0254B		25 GHz				
UXR0204B		20 GHz				
UXR0164B		16 GHz				
UXR0134B		13 GHz				
UXR0104B		10 GHz				

¹ The UXR0051BP includes two channels, but only one channel is licensed for use. The 2nd channel may be activated with purchase of an upgrade license – N2166A Upgrade 1 channel UXR0051BP to 2 channel UXR0254BP.

Superior Signal Fidelity from an Ultra-High-Performance Real-Time Oscilloscope

The Industry's Best Signal Integrity

- Up to 4 channels of true 110 GHz analog bandwidth
World's first high-performance oscilloscope series with a high-definition 10-bit Analog-to-Digital Converter (ADC)
- Low-noise analog front ends for precision signal acquisition
A mere 129 μV (rms) noise with 10 GHz of bandwidth, 500 μV (rms) at 70 GHz and only 860 μV (rms) at 110 GHz
- The industry's highest ENOB for supported bandwidths
 - 6.8 bits at 13 GHz over 3.5 mm inputs
 - 5.4 bits at 70 GHz over 1.85 mm inputs
 - 5.0 bits at 110 GHz over 1 mm inputs
- Down to 4 mV/div vertical scaling supported in hardware
- Hardware bandwidth limit filters enable accurate scalability
- Correction filters ensure flat frequency magnitude and phase response
- 25 fs (typical) of intrinsic jitter produce excellent jitter characterizations
- MultiScope support for up to 40 channels of synchronized acquisition



Modular Design and Upgradable Platform

The world's insatiable demand for faster data throughputs and better performance are driving current digital and RF technologies to their limits. At the same time, new technologies are emerging every 2 to 3 years, instead of the traditional 4-to-5-year innovation cycle, to meet this accelerating demand. Engineers and scientists can't afford to replace their research and development infrastructure investments to keep pace with these accelerating technology waves. Keysight recognized this shift and designed the UXR-Series to be a modular and fully upgradable platform – offering upgradable bandwidths ranging from 5 GHz to 110 GHz, with expandable 1-, 2- and 4-channel UXR-Series model configurations. Now, you can purchase an oscilloscope that meets your measurement and analysis requirements today and rest easy knowing it has the power, features, signal integrity, and upgradability to meet your most demanding future requirements, while preserving your investment.

- Sequentially upgradable between supported bandwidths
 - Starting from 5 GHz up to 110 GHz
 - Most accomplished onsite via simple license keys
- Grow from 1 to 2 to 4 channel full bandwidth configurations
- Upgrade to 1 Gpt and 2 Gpts of memory via license keys
- Full Infiniium software and compliance application support
- Widest range of probing and connectivity options
- Optional self-calibration module to perform full factory quality frame calibration adjustments

Meet the 1 mm Ruggedized Input Models

- Models from 5 GHz to 110 GHz of fully sampled real-time analog bandwidth – simultaneously on up to four channels per scope
- Unrestricted 256 GSa/s per channel sample rate – with a real-time resolution of 3.9 ps per sample
- High-definition 10-bit analog-to-digital converter (ADC) for unrivaled vertical resolution
- Ruggedized 1 mm analog input connectors with a new AutoProbe III interface
- Up to 2 Gpts per channel of deep memory capable of capturing over 10 Tb/s
- Up to 100x faster performance for some measurements – enabled by a powerful new measurement acceleration ASIC and memory controller capable of 5 trillion integer operations per second (IOPS)
- Keysight Indium Phosphide ASIC technology enables the lowest noise and highest signal integrity through full bandwidth time-interleaved sampling (TIS)
- 64 GB RAM with 2.6 GHz octa-core processor and hardware acceleration enable fast processing
- See your signal more clearly with a large 15.4-inch capacitive touch screen display
- Ability to measure edges as fast as 2.8 ps combined with the industry's lowest noise and 20 fsrms of intrinsic jitter enables even the most demanding multi-channel applications



Meet the 1.85 mm Ruggedized Input Models

- Models from 40 GHz to 70 GHz of fully sampled real-time analog bandwidth – simultaneously on up to four channels per scope
- Unrestricted 256 GSa/s per channel sample rate – with a real-time resolution of 3.9 ps per sample
- High-definition 10-bit analog-to-digital converter (ADC) for unrivaled vertical resolution
- Standard 1.85 mm analog input connectors with a new AutoProbe III interface
- Up to 2 Gpts per channel of deep memory capable of capturing over 10 Tb/s
- Calibration edge with a rise time of less than 4 ps enables TDT calibration with PrecisionProbe. Use the N2126A calibration module as part of PrecisionCable Advanced to extend calibration to an unmatched 70 GHz.
- USB and LAN provide remote measurements. Infiniium application remote program interface allows application/compliance software automation
- The horizontal and vertical knobs can be changed to control functions and waveform memories. Simply right click the channel control in the GUI to change these controls
- Measure section, including a toggling marker button and a dedicated marker knob, provides quick access to your marker control
- Infiniium UXR-Series oscilloscopes are the world's only 4-channel oscilloscopes capable of bandwidths over 40 GHz on all 4 channels simultaneously. UXR-Series oscilloscopes feature InfiniiMax 30-GHz probes, making debugging your system easier and ensuring you aren't missing valuable harmonic content.



Meet the 3.5 mm Ruggedized Input Models

- Models ranging from 10 GHz to 33 GHz of fully sampled real-time analog bandwidth – simultaneously on up to four channels per scope
- Unrestricted 128 GSa/s per channel sample rate – with a real-time sample resolution of 7.8125 ps per sample
- High-definition 10-bit analog-to-digital converter (ADC) provides 1,024 quantization levels, enabling more accurate digitization of signals – 4x more vertical resolution than traditional 256 level, 8-bit systems
- 500 Mpts standard, with up to 2 Gpts per channel of optional deep memory
- Threaded 3.5 mm RF connectors with convenient auto torque mechanism ensures the most reliable signal integrity and consistent 8 in-lbs. connection. The AutoProbe II interface provides a robust interface and instant compatibility with the InfiniiMax Ultra RC, III and III+ probing system.
- Ultra-quiet analog multi-chip front-end module optimized for 33 GHz and lower bandwidths provides the lowest noise and highest signal integrity available in its class along with the advantage of full bandwidth time-interleaved sampling (TIS).
- Enterprise grade 960GB removable solid-state drive improves processing speed and enhances data security
- Customizable multipurpose key allows you to customize its function to make your favorite measurements, execute a script, save waveforms, or load a setup
- Industry best ENOB and less than 10 fsrms of inter-channel intrinsic jitter enables precise capture of multi-channel applications and measurements



Groundbreaking Oscilloscope Technology

The Infiniium UXR-Series is the 7th generation in Keysight Technologies' Infiniium portfolio of high-performance real-time oscilloscopes. It is undeniably the world's most technologically advanced and powerful oscilloscope. A single 110 GHz 4-channel Infiniium UXR incorporates over 80 custom Application-Specific Integrated Circuits (ASICs), 13 Field-Programmable Gate Arrays (FPGAs), 9 unique Monolithic Microwave Integrated Circuits (MMICs), and 38 thin films. These revolutionary chipsets are the basis for the building blocks used within the UXR-Series to realize an upgradable and modular design that delivers superior measurements, with the highest fidelity and signal integrity, in a platform that has the power you need today and the ability to conquer even your most demanding future needs.

Whether you are deploying emerging high-speed bus technology, identifying spectral content of wideband RF signals, or analyzing transient physical phenomena, you need the truest representation of your signal under test. Keysight invests in advanced leading-edge technology to bring you the highest real-time oscilloscope measurement accuracy available today.

Indium Phosphide (InP) Integrated Circuits

Keysight utilizes a proprietary Indium Phosphide (InP) integrated circuit process to design the key technology blocks necessary to deliver high-bandwidth performance, ultra-low noise, and high-voltage signal input. This process is used in the pre-amplifier, trigger, sampling, and probe amplifier integrated circuit designs. Not only does this mean you are purchasing the best oscilloscope on the market today, but you can also count on technology leadership from Keysight in the future.

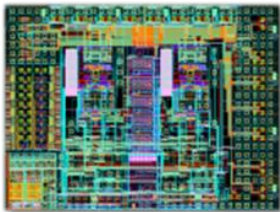

InP HB2C 110 GHz pre-amp and
256 GSa/s sampler MMICs

10-bit Analog-to-Digital Converter (ADC)

The Infiniium UXR is the world's first high-performance real-time oscilloscope, with offered bandwidths over 8 GHz, to come equipped with a high-definition 10-bit ADC architecture. Every UXR-Series acquisition board multiplexes four of the same 4-lane 10-bit ADCs as used in the award-winning Keysight S-Series oscilloscope. This industry-fastest high-fidelity ADC enables the UXR to offer industry leading-sample rates as high as 256 GSa/s per channel across up to 4 channels simultaneously.

- 4x more vertical resolution than legacy 8-bit oscilloscopes
- Hardware ADC Effective Number of Bits (ENOB) up to 8.7 contributes to high system ENOB values
- 12+ bits of resolution with high-resolution mode
- Achieves SNR better than historical 8-bit ADC architectures
- Vertical scaling as low as 4 mV/div supported in hardware and 1 mV/div with software-assisted magnification



High-fidelity 10-bit ADC

- 65 nm CMOS (9 mm x 14 mm)
- 130 nm BiCMOS buffer IC
- Custom 33 mm BGA package

Faraday Cage Shielded Analog Front-End Multi-Chip Modules (MCMs)

Any oscilloscope is only as good as its analog front-end bandwidth and noise. Infiniium UXR-Series oscilloscopes incorporate 100% full bandwidth time interleave sampling (TIS) on up to 110 GHz of analog bandwidth – coupled with the most advanced front-end noise reducing technology available to ensure ultra-low noise high bandwidth acquisition. This Keysight technology ensures the scopes advanced 10-bit ADC provides high-definition quantization of the test signals, not the oscilloscope's noise. Additionally, MCMs are instantly upgradable to higher bandwidths with a simple software license, adding more value and future proofing your investment.

TIS Analog Front-End Module for 1mm and 1.85mm Input Models

- Integrated pre-amplifier, trigger and sampling technology blocks using proprietary noise-shielding faraday cage packaging technology
- Leverages Keysight's proven packaging technologies developed for network analyzers and spectrum analyzers
- InP ICs enable full bandwidth DC to 110 GHz pre-amplifiers
- 256 GSa/s primary InP sampler synchronized with (4) 64 GSa/s SiGe samplers provide TIS aligned signals to (16) 10-bit ADCs
- 7.5 mV/div vertical sensitivity in hardware and 1 mV/div with software assisted magnification
- Analog and DSP bandwidth limit filters reduce unwanted noise
- Electro-mechanical attenuators for decreased noise and high reliability
- Industry lowest 500 μV (rms) of noise at 70 GHz of bandwidth allows accurate viewing of small signal details

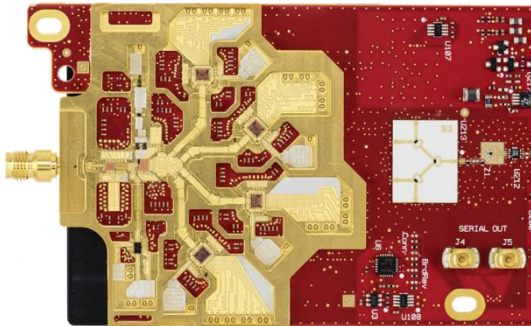

Single Channel 110 GHz MCM: Thin film multi-chip module packaging with faraday cage technology protects incoming signals from external noise and degradation – enabling you to see your signals the way your design experiences them

TIS Analog Front-End Module for 3.5mm Input Models

- Ultra-quiet design optimized for DC to 33 GHz bandwidths
- Low noise pre-amplifier synchronized with (2) 64 GSa/s SiGe samplers provide TIS aligned signals to (8) 10-bit ADCs
- 4 mV/div vertical sensitivity in hardware and 1 mV/div with software assisted magnification
- Analog and DSP bandwidth limit filters reduce unwanted noise
- Broad maximum input voltage ranging 32 mV to 8 V full scale
- Industry best 150 μ V (rms) noise at 32 mV full scale with 13 GHz of bandwidth
- 2 channels per acquisition board

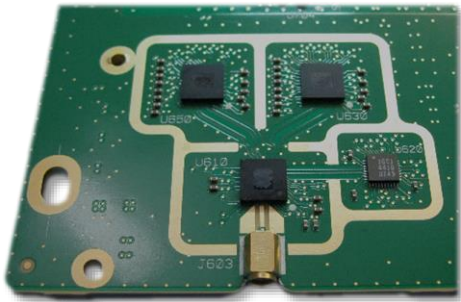

One channel of dual channel 33 GHz MCM - Optimized chipsets and processes, mixed with faraday cage technology, enable the lowest noise analog front end in the world for bandwidths from 10 GHz to 33 GHz

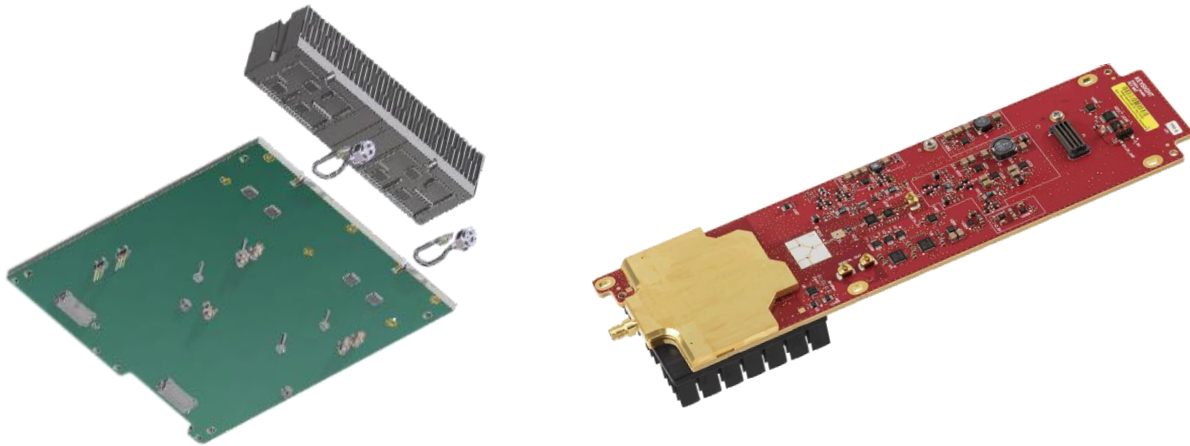

Dual-channel 33 GHz MCM and single-channel 110 GHz MCM with integrated faraday cage heat sink

World's Most Powerful Acquisition and Analysis System

To harness the power of a 256 GS/a per second analog front-end and provide 10 bits of high-definition vertical resolution, Keysight needed to develop an acquisition and analysis system capable of quantizing and capturing 2.56 Tb per second of data per channel.

The heart of the Infiniium UXR-Series oscilloscope is a powerful 24-layer acquisition board consisting of 3 sub-laminations and over 1,000 high-speed traces that won the Mentor Graphic Design of the Year award for industrial design. Each 5 GHz to 110 GHz MCM feeds a single acquisition board, while every dual-channel 10 GHz to 33 GHz MCM shares one across each of its channels. At 256 GSa/s, a 4-channel UXR-Series oscilloscope can capture 10.24 Tb/s of data across 4 acquisition boards – time synchronized to within 10 fs (rms) of inter-channel intrinsic jitter.

Award Winning Acquisition board

- (4) 10-bit high-definition ADCs
- (4) 100m gate memory controllers
- 2.56 Tb/s of real-time acquisition bandwidth
- (2) signal processing FPGAs
- From 500 Mpts to 2 Gpts of ultra-high-speed memory
- Frequency response correction filters produce flat responses for both magnitude and phase for more accurate waveforms
- User-selectable hardware bandwidth-limiting correction filters from 1 GHz up to the oscilloscope's bandwidth reduce unwanted noise, plus additional front-end filters for even more bandwidth-limiting options
- Fast update rates mean your oscilloscope will stay responsive with deep memory on to ensure precise representation of analog signals

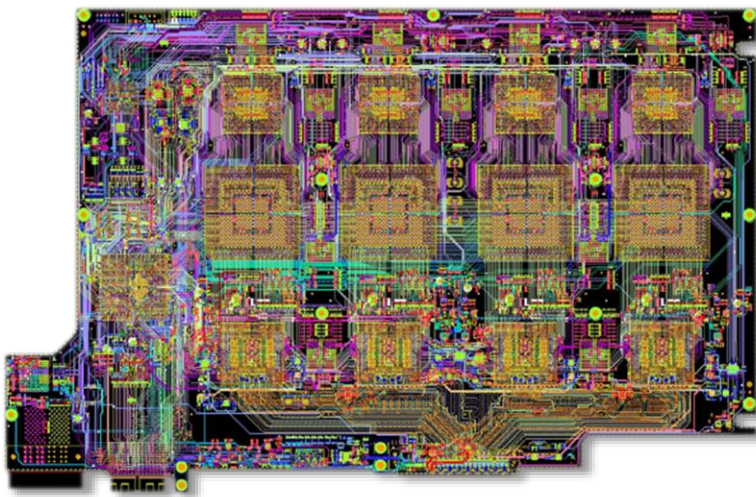

Advanced Signal Processing Memory Controller

- CMOS ASIC with 100M+ gates
- Capable of 5 trillion integer operations per second
- Improves performance of some features by 100x
- Keysight proprietary DSP technology blocks support rapid optional de-embedding technologies such as InfiniiSim, Precision Probe, and equalization
- Available hardware-based acceleration speeds:
 - Waveform plotting
 - Averaging
 - Equalization (CTLE, FFE, TIE)
 - Jitter measurements (TIE)
 - InfiniiSim

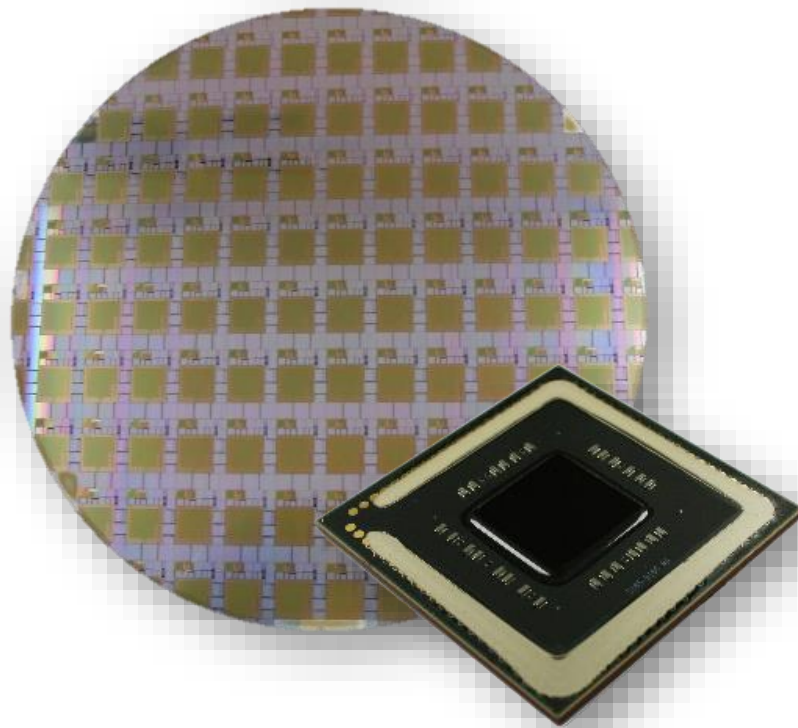

Time-Interleaved Sampling (TIS) vs. Frequency Interleaving Technologies

Traditional digital storage oscilloscopes used full bandwidth time-interleaved sampling and high-speed 8-bit analog-to-digital converters (ADCs) to capture signals with low noise and the highest levels of signal integrity. Unfortunately, the traditional IC technologies used to power the amplifiers and samplers used in TIS oscilloscopes maxed out below 40 GHz.

To bridge this performance gap, sophisticated frequency, and interleaving processes like Asynchronous Time Interleaving (ATI), Digital Bandwidth Interleave (DBI), and RealEdge were developed. These complicated technologies split an incoming high-bandwidth signal into two or more lower bandwidth paths – allowing multiple slower ASICs to amplify, sample, acquire and process pieces of faster bandwidth signals. Frequency interleaving consequently comes with the cost of less available simultaneous channels and/or reduced sample rates, which requires multiple scopes for some applications. Consequentially, these innovations come with the disadvantage of increased noise, higher jitter, and lower signal fidelity, impacting an engineer or researcher's ability to measure and analyze today's ultra-fast, low-voltage signals.

Keysight recognized the need for a better solution and, after 5 years of development, has perfected new TIS technologies capable of meeting the needs of today's most demanding technologies. Powered by advanced Keysight Indium Phosphide ASIC processes, the UXR can acquire, amplify, and sample an incoming analog signal at a blazing fast 256 GSa/s across a full 110 GHz of bandwidth. This is accomplished without legacy signal degrading frequency interleaving technologies. UXR-Series of oscilloscopes return to the industry-proven, low noise, high signal integrity time-interleaved sampling (TIS) method used in traditional high-definition lower bandwidth oscilloscopes.

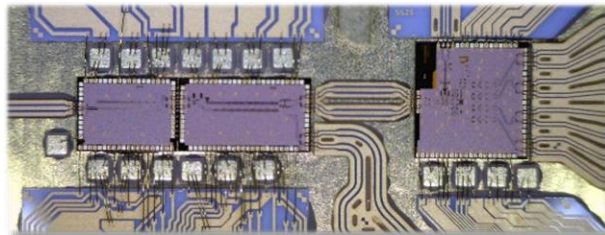

High-Performance Indium Phosphide MMICs - 110 GHz pre-amplifier and 256 GSa/s sampler incorporated in thin film multi-chip module

See Your Signal – Not Oscilloscope Noise

Infiniium UXR incorporates the most powerful and technologically advanced analog front end ever imagined in a real-time oscilloscope. Its leading-edge Indium Phosphide chip technology, custom thin film multi-chip module packaging and integrated faraday cage architecture ultimately guarantees the speed, low noise, and high fidelity needed to capture and measure today's and the future's high-bandwidth low-voltage signals - where picoseconds and microvolts matter.

These revolutionary capabilities ensure signals are clearer, eye diagrams are more open, and test results are truly accurate – empowering leading-edge researchers to see their signals the way they really operate in their designs and ultimately accelerate time to market for next generation and advanced technologies such as PAM4, 5G, NRZ, optical solutions and RF signal bursts.

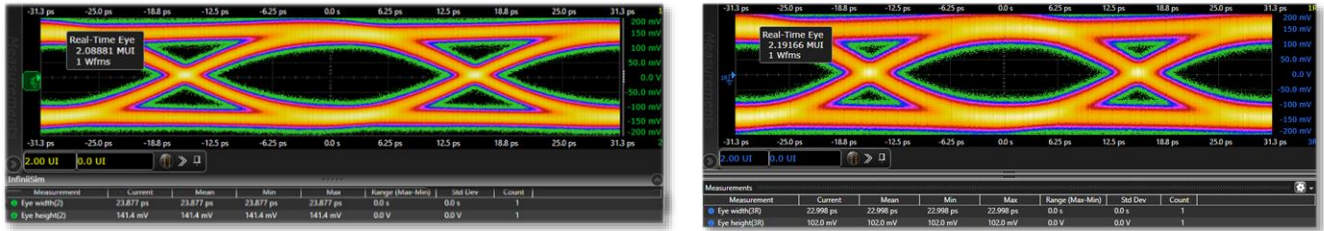

Comparison of 32 Gbps NRZ Eye diagram with ~24 dBm of loss – Measurements after equalization, captured with 40 GHz bandwidth

UXR-Series – TIS Channel

- 141.4 mV eye height
- 23.877 ps eye width
- 38.6% more eye height
- 4% more eye width
- Results in more margin for de-embedding / equalization

Z-Series – RealEdge Channel

- 102.0 mV eye height
- 22.998 ps eye width

Rugged Analog Bulkhead Connectors

To economically support bandwidths ranging from 5 GHz to 110 GHz, the various UXR-Series models come equipped with standard and ruggedized male inputs that best support the specified maximum bandwidths. Ruggedized male connectors (also known as outside-thread connectors or NMD connectors) have threads on the inside of the connector nut that are used when making a standard connection, and threads on the outside of the connector nut that are used when making a ruggedized connection.

- 10 GHz to 33 GHz models are equipped with ruggedized male 3.5 mm NMD analog bulkhead connectors
 - Allows the use of standard female SMA, 3.5 mm and 2.92 mm cables and adapters
 - Integrated outer clutch acts as an attached 8 in-lb. torque wrench
 - 2 sets of threads for connector diversity
 - Internal – use for standard connections
 - External – use for ruggedized connections
 - AutoProbe II interface ensures compatibility with existing InfiniiMax Ultra RC, III and III+ probing technologies

- 40 GHz to 70 GHz models are equipped with standard male 1.85 mm analog bulkhead connectors
 - Allows the use of standard female 1.85 mm and 2.4 mm cables and adapters
 - Housing is knurled for easy finger tightening
 - Includes a hex front end for use with 8 in-lb. torque wrenches
 - Advanced AutoProbe III interface enables next-generation high-speed probing technology
- 80GHz to 110 GHz B models and 5 GHz to 70 GHz BP models are equipped with ruggedized male 1 mm analog bulkhead connectors
 - Allows the use of standard female 1 mm cables and adapters
 - Housing is knurled for easy finger tightening
 - Includes a 14 mm hex front end for use with 10 in-lb. and 14 in-lb. torque wrenches
 - 2 sets of threads for connector diversity
 - Internal – use for standard connections
 - External – use for ruggedized connections
 - Advanced AutoProbe III interface enables next generation high-speed probing technology



Ruggedized 1 mm Male Bulkhead Connector with AutoProbe III Interface



Standard 1.85 mm Male Bulkhead Connector with AutoProbe III Interface



Ruggedized 3.5 mm Male Bulkhead Connector with AutoProbe II Interface

Every UXR-Series includes female-to-female connector savers to help protect the unit's primary bulkhead connector from damage. Additional adapters are also available.

Adapter Type	Part Number
1 mm F Ruggedized to 1 mm F	Y1900B
1 mm F Ruggedized to 1 mm M	Y1900C
1 mm F Ruggedized to 1.85 mm F	Y1901B
1 mm F Ruggedized to 2.92 mm F	Y1903B
1.85 mm F to F Adapter Assembly	N5520B
2.4 mm M to 2.92 M	11904A
2.4 mm F to 2.92 mm F	11904B
2.4 mm M to 2.92 F	11904C
2.4 mm F to 2.92 mm M	11904D
3.5 mm F to 3.5 mm F	5061-5311



Y1900B



Y1903B



Y1901B



11904D



11904B



3.5 mm F to 3.5 mm F

First Ever Factory-Quality Self-Calibration Modules

Regular calibrations are required to ensure your investment in a high-performance oscilloscope is protected and your equipment is operating to its specified performance. However, annual calibration cycles can come up at inconvenient times and encroach on project schedules or impact productivity. With design cycles shortening and greater emphasis on equipment ROI, reducing downtime and improving capital asset utilization is more important than ever.

The Infiniium UXR-Series is the first real-time oscilloscope to offer an optional self-calibration module – capable of performing the frame adjustments when performing a full factory-quality frame calibration under site environmental conditions. No longer do you have to lose productivity or time associated with returning your Infiniium UXR-Series oscilloscope back to the factory or a certified calibration center for calibration. Calibration modules are available for all UXR-Series bulkhead connector types and supported bandwidths.

Infiniium UXR Real-Time Oscilloscope Calibration Module

- Calibrate all channels on one or more UXR-Series Oscilloscopes
- Performs an automated full factory-quality frame calibration¹
- Support for calibrating models with bandwidths up to 110 GHz
- 1-1/2 hours to calibrate the first channel
 - About an hour per each additional channel
- Enables frame calibration adjustments to be performed under site environmental conditions
- High-speed Indium Phosphide (InP) step generator
 - Calibrated and traceable to National Institute of Standards and Technology (NIST) standards
- 3-year Performance Verification cycle (does not require calibration)
- Time scale calibration optionally supported with additional equipment

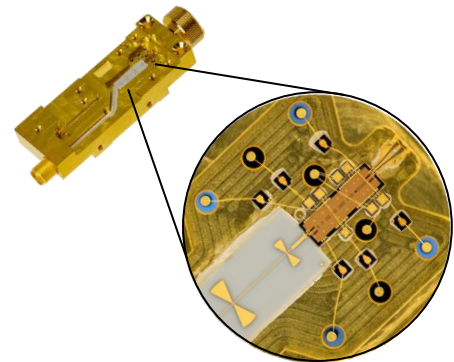

An Indium Phosphide enabled high-speed step generator lies at the heart of every Infiniium calibration module

1. A full factory certified calibration consists of frame calibration adjustments, and subsequent testing and performance verification to ensure the oscilloscope is performing to its documented specifications. The calibration module performs only the factory-quality frame adjustment calibration steps. Additional instruments and components are necessary to perform the required horizontal adjustments and vertical performance verification procedures to achieve a full self-verified calibration. If an accredited certified calibration certificate is required, the UXR must be returned to a qualified Keysight service center.

Model number	Description	Interface type	Max bandwidth
N2125A	Infiniium UXR Real-Time Oscilloscope Calibration Module, 1.0 mm	AutoProbe III	110 GHz
N2126A	Infiniium UXR Real-Time Oscilloscope Calibration Module, 1.85 mm	AutoProbe III	70 GHz
N2127A	Infiniium UXR Real-Time Oscilloscope Calibration Module, 3.5 mm	AutoProbe II	33 GHz



N2127A – 33 GHz max,
3.5 mm calibration module



N2126A – 70 GHz max,
1.85 mm calibration module



N2125A – 110 GHz max,
1.0 mm calibration module

Industry's Most Advanced and Flexible Probing System

To take advantage of your investment in a high-bandwidth oscilloscope, you must have a diverse probing system that delivers high-performance measurements. The InfiniiMax Ultra, III and III+ probing system is unmatched by any product in the market for measuring differential and single-ended signals – with flexible connectivity solutions for today's high-density ICs and circuit boards. It uses a proprietary indium phosphide IC process and advanced thick-film technology to accommodate even your highest-performance needs.

InfiniiMax probe amplifiers ranging from 1.5 GHz to 30 GHz of low noise bandwidth, deliver unrivaled performance and real-world usability for a completely new level of signal fidelity and accuracy.

The new InfiniiMax Ultra probe delivers up to 25 GHz bandwidth with an RC input impedance profile, providing the extremely low mid-band loading necessary to address modern high-speed probing requirements. It also supports InfiniiMode and has a user-defined AC calibration mode, a wider input voltage range, more accuracy with unique S-parameter characterization, lower capacitive loading, a wider input voltage range, micro / socketed probe heads for smaller density probing, and more bandwidths.

InfiniiMax Ultra probes have three attenuation ranges — 1:1, 4:1, and 8:1 — giving you superior noise performance and large voltage ranges, all while maintaining maximum bandwidth. The input range automatically configures depending on the size of the input signal and vertical scale of your oscilloscope. Choose from the three flexible input dynamic ranges from 600 mVpp at 1:1, 2.5 Vpp at 4:1, and 5 Vpp at 8:1. Clearly see and know when your design is satisfactory, keep up with standards, easily probe small devices, and reduce test complexity with the InfiniiMax Ultra Series probes.



MX002xA InfiniiMax Ultra Probe System

- 25 GHz bandwidth – when used with MX0100A
- “RC” input impedance architecture – 25 k Ω SE, 50 k Ω diff @DC, 170 fF with MX0100A micro probe head
- Attenuation range: 1:1, 4:1 or 8:1, auto switchable
- ± 16 V offset range
- Probe amp specific S parameter correction filter ensures flat frequency response
- Compatible with new probe heads and most of InfiniiMax I/II probe heads
- Easier to choose probe response correction method - True View (Vout/Vin) or Source Estimate (Vout/Vsource)



N700xA Optical-to electrical converters

The **N7005A** and **N7004A optical-to-electrical converters** are high-sensitivity photo-detector modules designed for direct optical-to-electrical conversion of telecom or datacom signals into an Infiniium real-time oscilloscope. Each N7004A or N7005A adapter contains its unique S-parameter correction filter, which is used to flatten the frequency response for more accurate measurements.



N7005A & N7004A GHz Optical-to-Electrical Converters

- DC to 33 GHz typical (-3 dBe, electrical, N7004A) and 60 GHz typical (-3 dBe, electrical, N7005A) 4th order Bessel Thomson response to 70 GHz
- Single-mode and multimode inputs (N7004A) Single-mode only (N7005A)
- 50/125 μ m, 750 nm - 1650 nm (N7004A)
- 9/125 μ m, 1200 nm –1650 nm (N7005A)

- Perform reference receiver testing of industry optical standards, including 56 GBd PAM4, or characterize raw response of an optical transmitter
- Optional FlexDCA SW v 06.70 or higher supports PAM4 measurement capabilities such as TDECQ with the N7005A and a UXR-Series oscilloscope



AutoProbe II to AutoProbe III interface adapter - Easily adapt your UXR-Series scope to accept InfiniiMax III and III+ probes with the N2852A AutoProbe II to AutoProbe III interface adapter

Model Number	Description	Note
MX0020A	10 GHz InfiniiMax Ultra probe amplifier	(RC architecture) Need adaptor N2852A for 1.85- and 1-mm models
MX0021A	13 GHz InfiniiMax Ultra probe amplifier	(RC architecture) Need adaptor N2852A for 1.85- and 1-mm models
MX0022A	16 GHz InfiniiMax Ultra probe amplifier	(RC architecture) Need adaptor N2852A for 1.85- and 1-mm models
MX0024A	20 GHz InfiniiMax Ultra probe amplifier	(RC architecture) Need adaptor N2852A for 1.85- and 1-mm models
MX0025A	25 GHz InfiniiMax Ultra probe amplifier	(RC architecture) Need adaptor N2852A for 1.85- and 1-mm models
N2803A	30 GHz InfiniiMax III probe amplifier	(RCRC architecture) Need adaptor N2852A for 1.85- and 1-mm models
N2802A	25 GHz InfiniiMax III probe amplifier	(RCRC architecture) Need adaptor N2852A for 1.85- and 1-mm models
N2801A	20 GHz InfiniiMax III probe amplifier	(RCRC architecture) Need adaptor N2852A for 1.85- and 1-mm models
N7003A	20 GHz InfiniiMax III+ probe amplifier	(RCRC architecture) Need adaptor N2852A for 1.85- and 1-mm models
N7002A	16 GHz InfiniiMax III+ probe amplifier	(RCRC architecture) Need adaptor N2852A for 1.85- and 1-mm models
N7001A	13 GHz InfiniiMax III+ probe amplifier	(RCRC architecture) Need adaptor N2852A for 1.85- and 1-mm models
N7004A	33 GHz optical to electrical converter	Need adaptor N2852A for 1.85- and 1-mm models
N7005A	60 GHz optical to electrical converter	Auto Probe III Interface
MX0100A-001	25 GHz micro probe head (set of 5)	(RC architecture) InfiniiMax I/II/RC/Ultra probe heads and tips
MX0100A-002	25 GHz micro probe head (set of 25)	(RC architecture) InfiniiMax I/II/RC/Ultra probe heads and tips
MX0100A-003	25 GHz micro probe head (set of 50)	(RC architecture) InfiniiMax I/II/RC/Ultra probe heads and tips
MX0105A	20 GHz SMA probe head	(RC architecture) InfiniiMax I/II/RC/Ultra probe heads and tips
MX0106A	23 GHz solder-in probe head	(RC architecture) InfiniiMax I/II/RC/Ultra probe heads and tips
N2839A	21 GHz browser head	(RC architecture) InfiniiMax I/II/RC/Ultra probe heads and tips
N2837A	21 GHz browser head replace tip (set of 40)	(RC architecture) InfiniiMax I/II/RC/Ultra probe heads and tips
N5425B	18 GHz ZIF probe head	(RC architecture) InfiniiMax I/II/RC/Ultra probe heads and tips
N5426A	18 GHz ZIF tip (set of 10)	(RC architecture) InfiniiMax I/II/RC/Ultra probe heads and tips
N5451A	4 GHz long-wired ZIF tip kit	(RC architecture) InfiniiMax I/II/RC/Ultra probe heads and tips
N2884A	5 & 9.9 GHz fine wire tip	(RC architecture) InfiniiMax I/II/RC/Ultra probe heads and tips
E2675B	6 GHz Differential browser head	(RC architecture) InfiniiMax I/II/RC/Ultra probe heads and tips
E2677B	12 GHz solder-in head	(RC architecture) InfiniiMax I/II/RC/Ultra probe heads and tips
E2678B	12 GHz socketed probe head	(RC architecture) InfiniiMax I/II/RC/Ultra probe heads and tips
N2880A	Coaxial attenuators	(RC architecture) InfiniiMax I/II/RC/Ultra probe heads and tips
N2881A	DC blocking caps (set of 2)	(RC architecture) InfiniiMax I/II/RC/Ultra probe heads and tips
N2851A	16 GHz QuickTip probe head	(RC architecture) InfiniiMax I/II/RC/Ultra probe heads and tips
N2884A	Fine wire probing tips	(RC architecture) InfiniiMax I/II/RC/Ultra probe heads and tips
MX0104A	Performance verification and deskew fixture	

For more information, see the [Infiniium Oscilloscopes Probes Accessories](#) or visit [Keysight Probe Resource Center](#).

Infiniium User Interface - Ultimate Acquisition and Visibility

The Infiniium user interface features:

- Full offline viewer
- Up to 16 functions
- Up to 16 horizontal gates
- Up to 9 jitter analysis charts
- Up to 9 noise analysis charts
- Up to 4 InfiniiSim charts
- Up to 16 FFTs at once
- Up to 16 grids in each window
- Peak annotation
- Composite files for easy file sharing
- On-screen marker measurements
- Up to 20 measurements displayed at once
- Multiple display support
- Drag and drop measurements
- My Infiniium menu customization
- Up to 16 user-defined functions
- Full spectral window
- Spectral analysis controls
- Quick save
- Multi-touch for touch capacitive screen
- Function overviews/window
- Up to 16 measurement trends
- Up to 16 histograms
- Nearly unlimited real-time eyes
- Tail fit versus spectral analysis chart
- Hardware acceleration
- Plus, much more ...

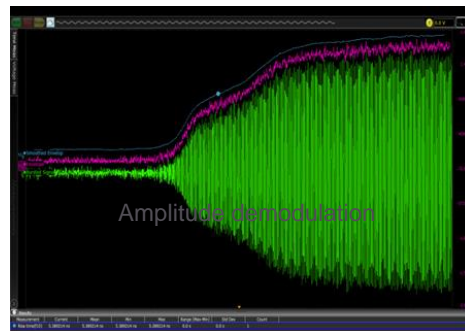

Advanced Capabilities & Applications

Digital Measurement and Analysis

With 110 GHz of bandwidth to capture rise times as fast as 2.8 ps and recover clocks on NRZ data rates as fast as 220 Gb/s, the UXR-Series is the world's fastest real-time oscilloscope. Its four channels each capable of simultaneous 110 GHz acquisition make it ideal for even the most bandwidth intensive SERDES designs. In addition to providing leading-edge bandwidth, the UXR-Series helps you see what's really happening in your design, by featuring the industry's lowest noise and jitter measurement floor, which means less scope noise in your measurements and a truer depiction of your signal.

UXR-Series features the following to enable ultimate digital analysis:

- Full offline analysis
- All New Fault Hunter help evaluate you signal characteristics
- 2 unique jitter separation algorithms, including bounded uncorrelated jitter (BUJ) breakdown
- Clock recovery on NRZ data rates as fast as 220 Gb/s
- Memory depth that captures milliseconds of data at 256 GSa/s

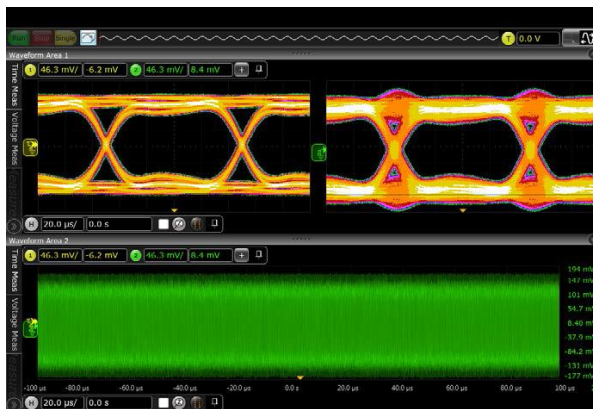

Capture, display, and measure multiple real-time eyes simultaneously with the UXR-Series.

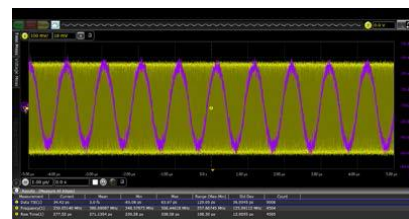
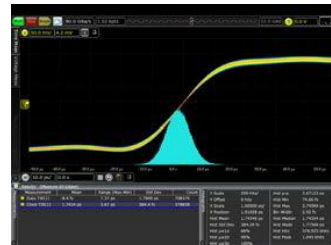

With 110 GHz bandwidth and a 256 GS/s sample rate, the UXR-Series can effectively characterize the time interval error trend of high-speed signals as well as fast rising edges, down to 2.8 ps.



With its flat frequency response and low noise, the UXR-Series can measure jitter components such as ISI.

Spectrum Analyzer Capabilities — RTSA, RF, Radar and Satellite Communications

See more in the frequency domain with RTSA

The RTSA view in the Infiniium UXR-Series provides spans from 40 MHz to 320 MHz, with a frequency range up to the oscilloscope bandwidth. RTSA does real-time FFT processing (up to 400,000 FFT plots per second) and uses spectral density plots to show all the data. The frequency mask trigger feature can selectively include or omit FFT waveforms from the plot. For a single channel, you can define up to eight frequency zones that the FFT waveform “must intersect” or “must not intersect” in order to be plotted.

The integrated FFT offers an alternative to a dedicated spectrum analyzer. Use the FFT to compute both magnitude and phase and take advantage of several useful features to assist in spectral analysis. Automatic measurements and markers measure spectral peak frequencies and magnitudes as well as deltas between peaks. Use the amplitude demodulation (envelope mode) to measure rise and fall times on the entire envelope.

UXR-Series features the following to enable ultimate RF analysis:

- Real-Time Spectrum Analysis (Spectrum Density Plot)
- Frequency Mask Trigger (Selective Plotting)
- Amplitude modulation (envelope mode) — create radar envelopes
- Gated FFT measurement

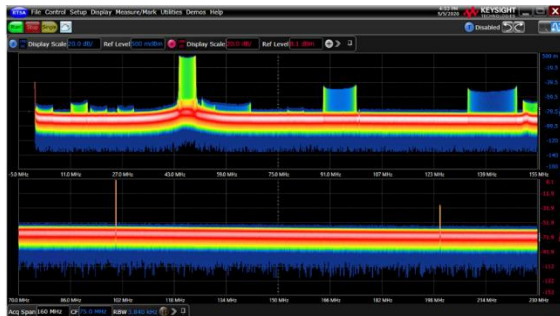

When RTSA mode is selected, each displayed channel is shown in its own grid as a spectral density plot with a frequency span on the horizontal X axis and dBm on the vertical Y axis. Multiple overlapping, color-graded FFTs (using the "temperature" color scheme) are shown per plot.



Use Frequency Mask Trigger to do selective plotting

Millimeter Wave (mmWave) Applications

The Infiniium UXR is the first real-time oscilloscope to provide flexible bandwidth allocation options, hardware accelerated acquisition and the signal integrity necessary to enable affordable wideband multi-channel mmWave signal analysis. Available N2163A mmWave Wideband Analysis Acceleration and Frequency Extension options, coupled with 1 mm input UXR-Series models, enable users to dynamically allocate up to 30 GHz wide frequency analysis bandwidth windows from DC to 110 GHz, regardless of the oscilloscope's maximum licensed native time-based bandwidth. These windows can be placed at unique center frequencies on different input channels, enabling easy RF vs. IF analysis. Additionally, all new Infiniium UXR-B Series models come standard with 160 MHz of hardware-accelerated real-time Digital Down Conversion¹ (DDC) – with the option to expand to 2.16 GHz of analysis bandwidth. With the Infiniium UXR-B, you get world-leading digital and mmWave performance in a single instrument with up to four phase coherent channels – enabling you to more quickly deliver next generation mmWave technologies, pulsed radar, integrated mixed signal designs, spread spectrum clocking (SSC), and advanced wideband research & development.

- Available mmWave Extension options– enable frequency analysis ranges up to the hardware's maximum supportable bandwidth²
 - DC to 110 GHz of dynamically configurable analysis windows
 - 5 GHz, 10 GHz, 20 GHz, and 30 GHz wide options are available
- Up to 256 GSa/s real-time or 3,200 MSa/s complex sample rates
- Industry best -158 dBm/Hz DANL from 50 GHz to 85 GHz
- Optional 2.16 GHz hardware accelerated DDC I/Q demodulation bandwidth
 - Up to 50x faster analysis performance with DDC
- Easy MIMO support with independently configurable phase coherent channels
- The industry's highest ENOB
 - 5.0 bits for 110 GHz analysis bandwidth
 - 9.0 bits for 1 GHz analysis bandwidth (67 GHz CF)
- World class EVM performance
 - 1.23% (two-channel bonded 802.11ay)
 - 0.60% (5G NR measured at 28 GHz)
- Largest phase noise offset frequency range from 1 kHz to 100% carrier frequency
- Full integration with Keysight VSA Software for advanced spectral & vector signal analysis

¹ DDC mode cannot be used concurrently with time-based mode

² Regardless of the oscilloscope's licensed time-domain bandwidth. Maximum available frequency range (typical) determined by input hardware: 1mm Ruggedized: DC to 113 GHz, 1.85mm: DC to 70 GHz and 3.5mm: DC to 33 GHz



Keysight Infiniium UXR-B Series - 4 channel 1 mm input model using 89600 VSA Software to perform a 5G NR measurement



The UXR0051AP provides a 110 GHz frequency range on one channel, but includes hardware for an optional second channel – activated with purchase of an N2166A license, enabling easy upgradability for MIMO operation

PathWave Vector Signal Analysis (89600 VSA) With the UXR-Series

Tools to Demodulate and Analyze Your Most Complex Signals

Development becomes more complex when faster data rates intersect with today's crowded spectral environment. Finding a signal problem is essential when developing next-generation mmWave technologies but achieving the clarity to pinpoint the answer is the crucial challenge. PathWave Vector Signal Analysis (VSA) software is a comprehensive set of tools for demodulation and vector signal analysis. These tools enable you to explore virtually every facet of a signal and optimize your most advanced designs. As you assess the tradeoffs, the PathWave Vector Signal Analysis (VSA) helps you see through the complexity and accelerate your next innovations.

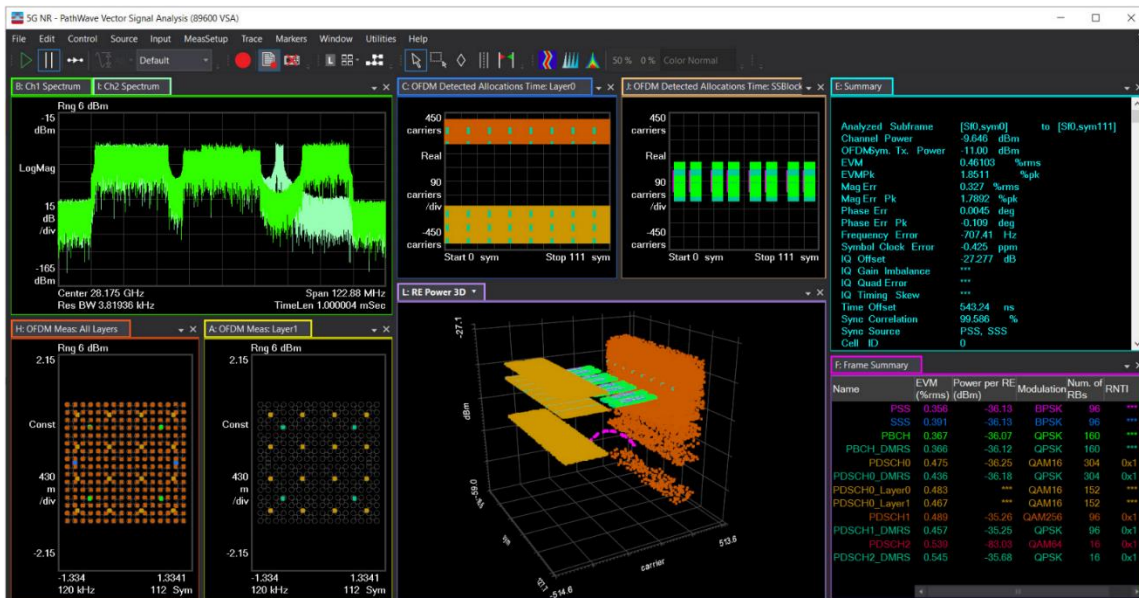

Using PathWave Vector Signal Analysis (VSA) with the Infiniium UXR-Series enables you to characterize the complex modulation of evolving cellular communications standards like 5G NR (New Radio) and enables easy MIMO analysis.

Network Analyzer Capabilities — Time-Domain Transmission (TDT)

You need to be able to maximize your margins by removing the effects of cables and fixtures

As bandwidths continue to increase and cable loss becomes more and more of a problem, the UXR-B Series has the technology to solve this issue. UXR-B Series oscilloscopes offer award-winning PrecisionProbe Advanced technology. You no longer need to ignore cable loss because you are short on time or budget. Using PrecisionProbe Advanced technology, you can characterize cables as fast as 110 GHz and remove the loss they create. PrecisionProbe Advanced technology with the N2125A gives you one of the world's fastest edges at less than 4 ps and uses this edge to perform a TDT on your cable. Based on the loss of your cable, PrecisionProbe Advanced then compensates your measurement system, gaining back valuable margin typically lost in cables.

You need to test multiple lanes automatically and still maximize margins

The UXR-B Series features many compliance applications, which provide full automation of any switch connected to your system. The software is fully compatible with PrecisionProbe Advanced compensation, which allows you to characterize every input using only your UXR-Series oscilloscope and then seamlessly automate every measurement in your compliance application. Save valuable time and resources in such technologies as DisplayPort and PCI Express® Gen5.

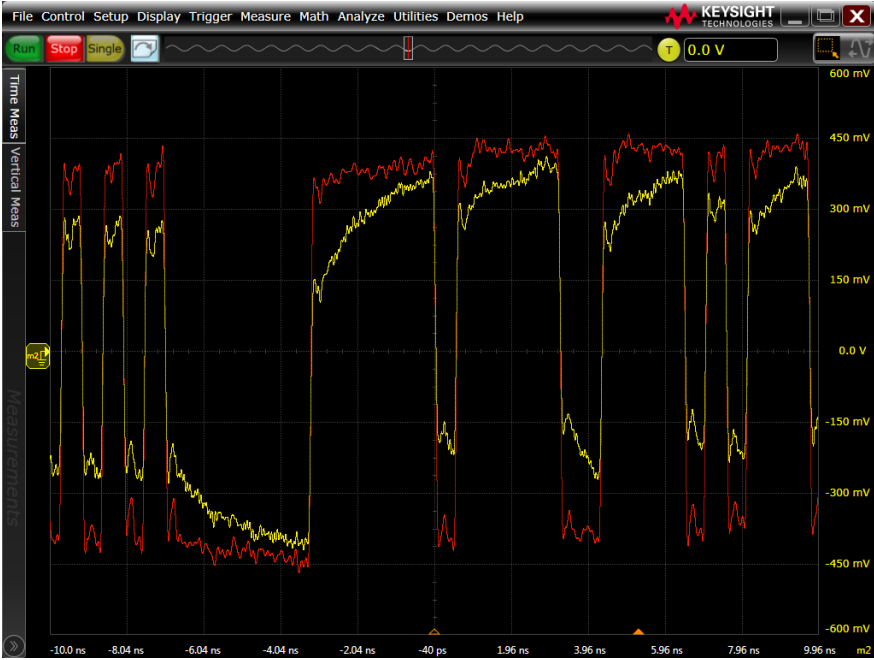

By analyzing cables, you can increase your margins by removing insertion loss caused by cables

Optical Modulation Analyzer — Research, Development, & Coherent Modulation

The ever-growing demand for higher transmission capability is driving advanced symbol rates from 64 GBaud today to 112 GBaud and higher ranges in the longer term. To keep up with continual symbol rate increases, a test instrument is required that can handle baud rate classes of transceivers from 400 Gb/s to 1.2 Tb/s and beyond – from the first day of advanced research through the development phase.

Not only are today's baud rates more challenging, but modulation formats are getting more demanding due to higher-order Quadrature Amplitude Modulation (QAM) and probabilistic shaping, which requires significantly better noise performance.

Infiniium UXR-Series oscilloscopes achieves these requirements and are available in combination with a powerful optical coherent receiver as the N4391B, capable of 160 to 210 Gbaud symbol rates – providing a fully specified turnkey instrument. This compact solution offers the highest real-time bandwidth options and is the most advanced test solution available for research on 400G to terabit and beyond transmission. By providing four channels of up to 110 GHz bandwidth, the UXR-Series saves you the expense of a second instrument to analyze dual polarization. Even for the lower 20 GHz bandwidth range, this easy-to-use solution, with the best EVM and highest ENOB, is a preferred reference system for 100G transmission and beyond.

If you prefer to operate with your own optical receivers but want to benefit from the solutions enormous analysis capability, you can get the N4391B's analysis software as a standalone package.

- Up to 220 Gbaud symbol rate analysis
- Four times better EVM noise floor than typical QPSK transmitters
- Four channels of 256 GSa/s real-time sampling for optimal phase tracking
- Include your own MATLAB algorithms
- Configurable APSK and OFDM decoders
- Reliable and flexible vector signal analysis (VSA) software

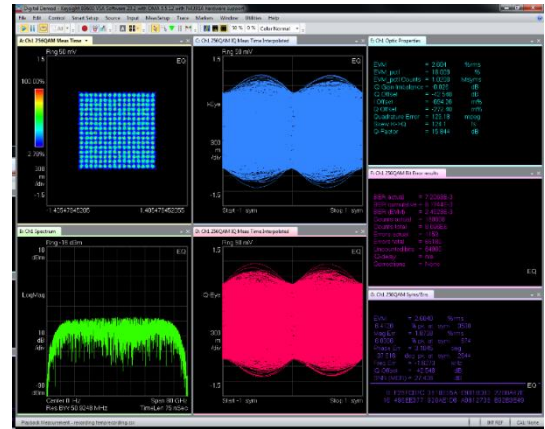

Never before seen 64 Gbaud 256 QAM 1-Tb/s coherent modulation analysis with 2.6% EVM – made possible by the Infiniium UXR-Series real-time oscilloscope and its world's lowest



Integrated N4391B Coherent Optical Solution - Compact fully calibrated turn-key solution for 400Gb/s to 1.2 Tb/s and beyond

Infiniium UXR-Series Analysis Tools

EZJIT Complete D9020JITA

Gain insight into the causes of signal jitter to ensure high reliability of your design

With faster edge speeds and shrinking margins in today's high-speed digital designs, insight into the causes of jitter has become critical for success. Using EZJIT Complete analysis software, the UXR-Series oscilloscopes help you identify and quantify jitter margins that affect the reliability of your design. Time correlation of jitter to the real-time signal makes it easy to trace jitter components to their sources. Additional compliance views and a measurement setup wizard simplify and automate RJ/DJ separation for testing against industry standards. EZJIT Complete automatically detects embedded clock frequencies and repetitive data patterns on the oscilloscope inputs and calculates the level of data-dependent jitter (DDJ) that is contributed to the total jitter (TJ) PDF by each transition in the pattern, a feature not available on any other real-time oscilloscope today.

Measurement trends and jitter spectrum. EZJIT's simple tools help you quickly analyze the causes of jitter. Measurement trends allow you to see deeper views of factors affecting measurements. Jitter spectrum is a fast method to find the causes of jitter.

Two ways to separate jitter. EZJIT comes with two ways to separate jitter: the spectral method and the emerging tail fit method. Both methods allow for simple separation of RJ and DJ, but the tail fit method provides proper jitter separation in the unique case of bounded uncorrelated jitter.

Unique RJ/DJ threshold view. EZJIT Complete also provides a unique threshold view of the jitter spectrum with the threshold drawn on the chart. The spectral view provides insight into the decision point of the separation and works with both narrow and wide spectral separation.

Real-time eye and clock recovery. Serial data analysis (SDA) software provides flexible clock recovery including 1st and 2nd-order PLL and constant algorithms. With a stable clock, you can look at real-time eyes of transition and non-transition bits. UXR-Series scopes with SDA software also provide a new unique view of bits preceding an eye.

Flexible charts. EZJIT Complete displays up to 10 graphs with unique information. Use them all to maximize your jitter analysis



More than your standard jitter package

To efficiently determine root cause for any type of signal degradation in the amplitude domain, you must first determine whether the problem is caused by random or deterministic sources. To help you accomplish this task, EZJIT Complete takes analysis techniques used in the time domain (jitter analysis) and extends them into the amplitude domain.



With EZJIT Complete you can discover signal anomalies in the noise of the waveform

More than just an eye contour

EZJIT Complete is an in-depth view into impairments related to signal levels – either logic ones or logic zeroes – deviating from their ideal positions. Some tools simply provide a view of an eye contour but provide no real measurement data other than nice graphics.

EZJIT Complete uses separation techniques to allow each bit to be examined to determine correlated effects and to make multiple measurements on individual bits to determine uncorrelated effects. Use FFTs to analyze the frequency domain and extract random components. Dual-Dirac modeling techniques are also carried from the jitter domain and used in the interference domain.

Key Measurements and Features

- Decomposition of Vertical Noise into constituent components:
 - Random Noise (RN)
 - Periodic Interference (PI)
 - Deterministic Interference (dual dirac model) (DI)
 - Data Dependent Interference, or Intersymbol Interference (ISI)
 - RIN (dBm or dB/Hz)
 - Q-factor
 - Aperiodic Bounded Uncorrelated Interference
- Total Interference (TI) to a specified Bit Error Ratio
- Cumulative Average of High (One) and Low (Zero)
- Tabular Results of all measured quantities
- Graphical Results of:
 - InterSymbol Interference per bit
 - RN / PI Histogram
 - Total (Composite) Interference Histogram
 - Bathtub curve (Measured and Extrapolated)
 - Interference Frequency Spectrum
- Settable location in the UI for vertical analysis
- Scope noise compensation
- Arbitrary or Periodic Data patterns
- Advanced spectral and tail fit algorithms for accurate RN, ABUI extraction in crosstalk environments
- Setup Wizard for robust setups

Advanced phase noise analysis

With D9020JITA, Keysight Infiniium UXR-Series oscilloscopes are the first to offer a dedicated phase noise measurement application. Phase noise is related to clock TIE and is generally used to measure change in an oscillator's frequency, either in the long term or short term. When you look at the spectrum of an imperfect clock or oscillator, there will be energy radiated slightly off the nominal clock frequency (or carrier), called sidebands. Phase noise is generally measured as a ratio of the spectral power in the carrier vs. the phase noise in the sidebands, normalized to 1 Hz of bandwidth.



With EZJIT Complete you can measure large offset phase noise on a variety of signals

Phase noise analysis results from D9020JITA are presented in a log frequency plot, here the amplitude units are dBc/Hz (decibels relative to the carrier power, normalized to a 1 Hz bandwidth). The X-axis is the frequency offset from the nominal signal, or “carrier” frequency. Resulting spurs can be normalized, omitted, or be represented separately to better show their energy levels. Multiple UXR-Series channels can be combined to perform cross-correlated phase noise analysis, effectively reducing oscilloscope noise by about -5 dB per 10X increase in accumulated acquisitions (x-correlations).

Key Measurements and Features

- Phase jitter measurement (rms) (pn) over a configurable frequency range
- Support for very large offsets
- Multiple acquisition methods and signal types:
 - Spread spectrum clocking (SSC)
 - Differential
 - Probed signals
 - Square waves
 - After PLLs
- Graphical Results of:
 - Phase Noise (dBc/Hz)
 - Frequency offset up to the carrier
- Cross-correlated oscilloscope noise reduction: -5 dB noise reduction per 10X increase in cross-correlations

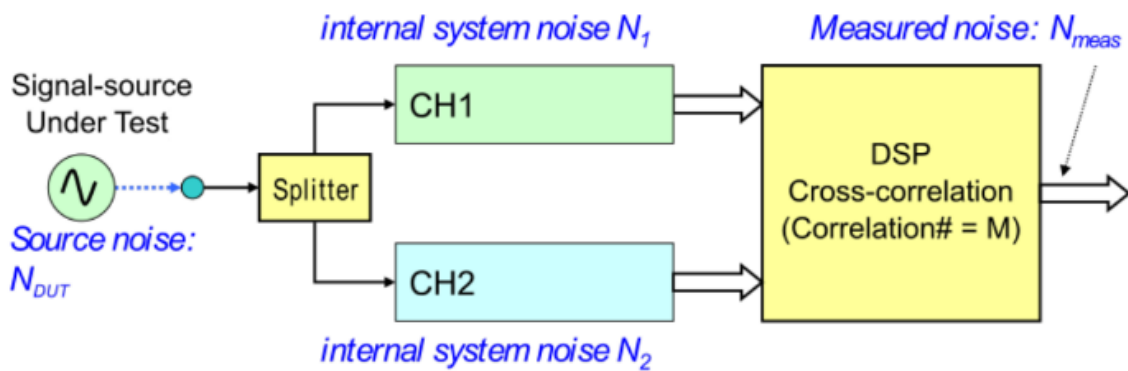

$$N_{meas} = N_{DUT} + (N_1 + N_2) / \sqrt{M} \quad \text{Assuming } N_1 \text{ and } N_2 \text{ are uncorrelated.}$$

M (number of correlation)	10	100	1,000	10,000
Noise reduction on (N_1+N_2)	-5dB	-10dB	-15dB	-20dB

InfiniiSim D9020ASIA

The most advanced waveform transformation software helps you render waveforms anywhere in a digital serial data link

InfiniiSim waveform transformation toolset provides the most flexible and accurate means to render waveforms anywhere in a digital serial data link. The highly configurable system modeling enables you to remove the deleterious effects of unwanted channel elements, simulate waveforms with channel models inserted, view waveforms in physically improbable locations, compensate for loading of probes and other circuit elements, and do so simply and quickly on your tool of choice, the UXR-Series, with up to 110 GHz of bandwidth.

Circuit models to define your setup

The InfiniiSim waveform transformation toolset provides a graphical user interface for you to define your system as you understand it and even make it arbitrarily complex. You do this by selecting topologies and defining circuit blocks.

Model reflections

With the InfiniiSim waveform transformation toolset, you can transform signals with confidence, whether you are inserting or removing channel elements or relocating the measurement plane. InfiniiSim's advanced toolset lets you model up to 27 different elements at once and model the interaction between elements. Only toolsets with the ability to model more than one element will properly reflect a model including the oscilloscope's input.

Model your system with as much detail as you need

InfiniiSim features the model setup that best matches your design. Whether it is a simple single-element model or an advanced general-purpose model with up to 27 elements in the link, you can perfectly model your design and simulate the exact probing point you want.



InfiniiSim renders the waveform through hardware acceleration

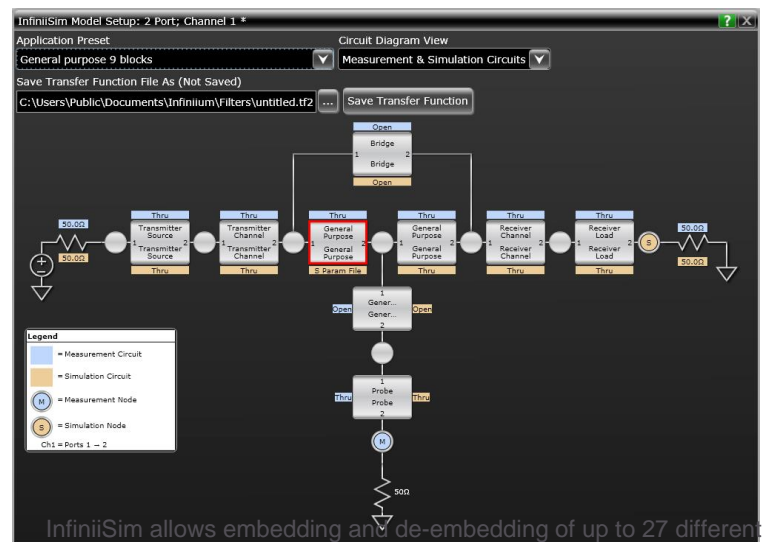

InfiniiSim allows embedding and de-embedding of up to 27 different

Elements or S-parameter models at once to meet your most demanding requirements.

Serial Data Equalization D9020ASIA

Significantly reduce receiver errors by opening even tightly shut eyes through equalization emulation

Serial data equalization (SDE) for the UXR-Series provides fast and accurate equalization using decision feedback equalization (DFE), feed-forward equalization (FFE), and continuous-time linear equalization (CTLE) modeling in real-time. The UXR's hardware acceleration options further improve equalization performance and real-time usability. Serial data equalization software allows you to input your own self-designated tap values to verify your design. If you prefer, the software will find the optimal tap values for you. CTLE allows DC gain and two-pole modeling.



InfiniiScan D9020SCNA

Quickly and easily identify waveform anomalies

Today's digital signals are increasingly complex. Designers of serial links and parallel buses want to quickly identify signal anomalies in their designs. Engineers have traditionally relied on hardware triggering and deep memory to capture such illusive events. However, these classic methods fall short in some key areas.

Trigger on events that hardware triggers can't handle

InfiniiScan software allows you to use an oscilloscope to identify signal integrity issues that hardware triggering is unable to find in your electronic designs. This innovative software scans through thousands of acquired waveforms per second to help you isolate signal anomalies, saving you time and improving designs.

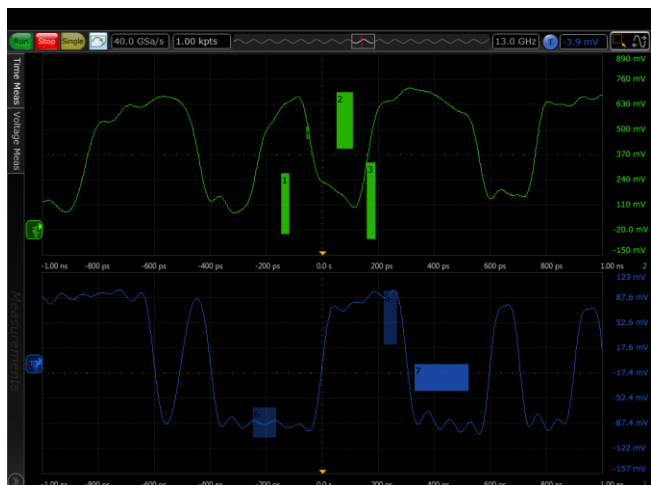

Draw zones on your screen for a unique triggering experience

Innovative triggers

The zone qualify finder allows you to draw a “must intersect” or “must not intersect” zone on the oscilloscope screen to visually determine the event identify condition. If you can see the event of interest on the screen, you can create a trigger that will isolate it, saving significant time over some complicated hardware triggers. Other triggers include non-monotonic edge, measurement limit search, runt, and pulse width.

PAM-N Analysis D9020PAMA

The Infiniium UXR-Series with its industry-leading signal integrity is the best instrument to perform PAMn measurements. The UXR scope owns the best ENOB (effective number of bits) in the current real-time oscilloscope market with the lowest jitter and the lowest noise. For PAMn analysis, oscilloscope needs to determine the PAM levels and the thresholds that separate them. To display a PAM real-time eye, make eye measurements, and perform jitter/noise measurements, the oscilloscope needs to recover the clock from the PAM signal. The Keysight PAM-N analysis software extends the ease-of-use advantages of the Infiniium oscilloscopes to the analysis of PAM-3, PAM-4, PAM-6 and PAM-8 signals. A wizard walks you quickly through the steps required to setup measurements for a PAM encoded signal, to select methods for clock recovery, and then the measurements you wish to have performed on your PAM signal. Our PAM software is also able to accurately set the individual threshold levels of your PAM signal and render each individual eye.

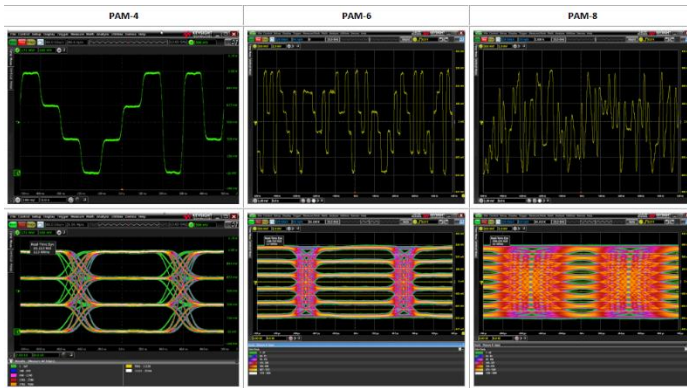

PAM-4 12 Edge Jitter Measurements

PAM-4 J3u, J4u, J6u, Jrms, and even-odd jitter (EOJ) measurements can be made on PRBS13Q, PRBS9Q, PCIe Gen6 (52 symbols), and other data patterns. These measurements are based on the IEEE 802.3bs and other standards for Output Jitter measurements. During these measurements, an RJ/PJ histogram is measured for each of 12 specific waveform transitions that are called out in the standard as well as for the combined effect of all edge transitions. On PAM-4 signals that are derived from two NRZ signals, these measurements let you observe the effect of different uncorrelated jitter on each stream based on the transitioning bits. For Jrms/Jnu report count, the IEEE 802.3bs standard (and other standards) can specify these measurements be made up to 1,000,000 times. However, you can use this field to change the count that is actually used.

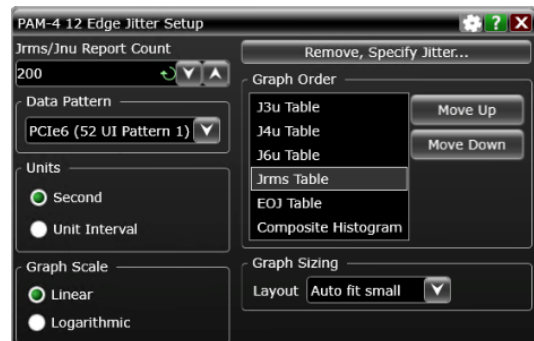

PAM-4 SNDR (Signal to Noise and Distortion Ratio) Measurements

Assuming ISI jitter and noise is 100% compensable by equalizers and is of no consequence to system performance, you can project a system's performance (when equalizers are used) by determining the ratio between the signal from linear fit pulse response and distortion-plus-noise. This ratio is called Signal to Noise and Distortion Ratio (SNDR). Some technology standard documents publish SNDR specifications. The SNDR measurement is arrived at by performing linear fit pulse response and linear fit error (matrix) math functions on the input waveform and then by making calculations based on the results.

Signal to Noise and Distortion Ratio (SNDR) is defined by the equation:

$$SNDR(in\ dB) = 10 \times \log_{10}\left(\frac{P_{max}^2}{(\sigma_e^2 + \sigma_n^2)}\right)$$

The PAM-4 SNDR measurements include Siga-n, Sigma-e, Pmax, and SNDR. You can also view the math waveforms created during the measurement process: the SNDR Input waveform (with the averaging and pts-per-UI linear fit parameters applied), the linear fit Pulse Corrected waveform, the Error waveform, e(k), and the Linear Fit Pulse Response, p(k).



PAM-4 SNDR Setup

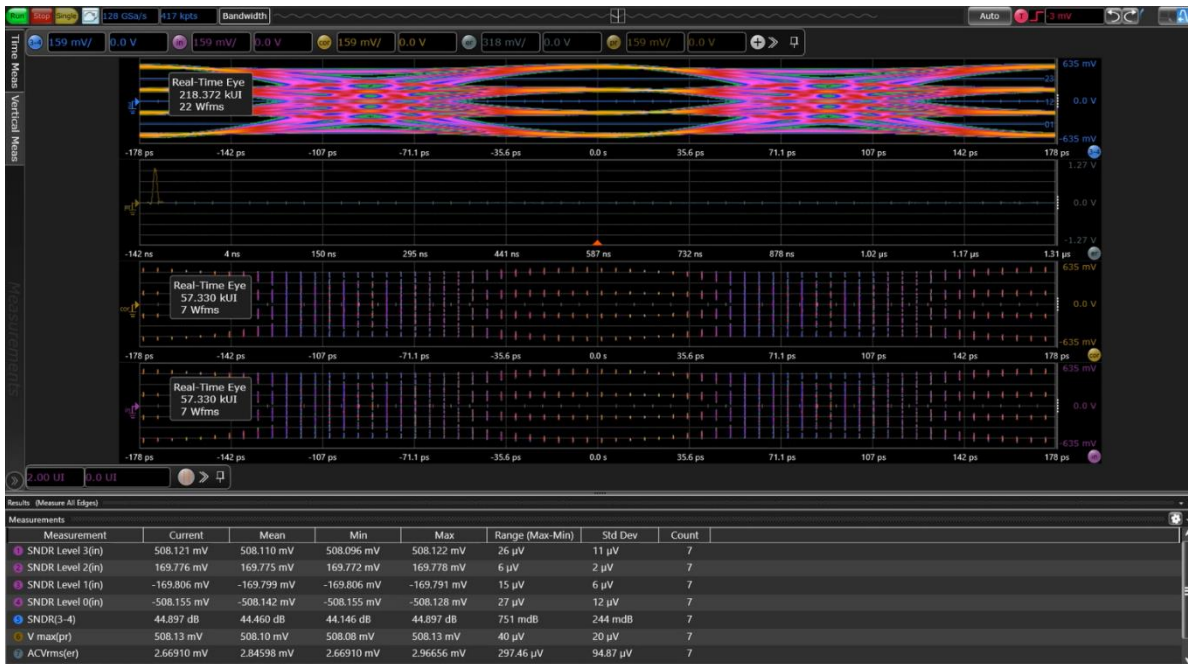

PAM-4 SNDR measurements result

PrecisionProbe & PrecisionCable Standard

Quickly characterize and compensate any input into your scope

PrecisionProbe technology turns your high-performance oscilloscope into the ultimate characterization tool. Not only can you do the normal waveform transformations such as de-embedding through InfiniiSim, PrecisionProbe allows quick characterization of your entire probe system (including cables and switches) without the need for extra equipment. PrecisionProbe takes advantage of the fast “cal output” signal built into the UXR-Series to characterize and compensate insertion loss on the measurement system.

PrecisionProbe technology:

- Properly creates custom probe transfer function = V_{Out} / V_{In}
- Properly characterizes probed system transfer function such that $V_{Out} / V_{In} = V_{Out} / V_{Src}$
- Removes unwanted S21 cable loss
- Ensures every probe has the same frequency response and phase for consistent measurements across multiple probes
- Compatible with UXR-Series N2126A and N2127A Calibration Modules – capable producing of sub-4 ps rise times



Now every probe and cable in the system can have the exact same response — probe to probe or cable to cable — without the inaccuracies that using one model can produce. You can properly characterize custom probes and remove unwanted responses. In addition to characterizing the cables, PrecisionProbe allows for immediate use on the same instrument. PrecisionProbe saves you time and money while increasing your measurement accuracy.



Characterize probes and cables in five minutes or less and characterize and remove insertion loss up to 110 GHz.

When you combine InfiniiMax probes with switches between the amplifier and the probe head, PrecisionProbe allows for full correction and automation of each probe’s path. Full automation is then available to allow for quick swapping of the inputs via the Infiniium software’s compliance framework.

PrecisionProbe characterization of a 1.85 mm cable to 70 GHz using the N2126A calibration module

Infiniium Offline Oscilloscope Analysis Software D9010BSEO

View and analyze away from your oscilloscope and target system

Ever wish you could do additional signal viewing and analysis away from your scope and target system? Now you can. Capture waveforms on your scope, save to a file, and recall into Keysight's Infiniium Offline application.

It goes anywhere your PC goes

Take advantage of large high-resolution and multiple displays found in your office. Use familiar scope controls to quickly navigate and zoom in to any event of interest. Use auto measurements and functions for additional insight.

Share scope measurements more easily across your team

You can share entire data records instead of being limited exclusively to static screen shots.

Create more useful documentation

Use features such as right-click cut-and-paste to move screen images between applications, without ever having to save the image to a file. Add up to 100 bookmark annotations and up to 20 simultaneous measurements.

Need advanced analysis capability?

Infiniium Offline includes a variety of upgrade options including serial decode upgrades for a variety of serial buses, jitter analysis, and serial data analysis.



Infiniium Offline software works with all Infiniium applications

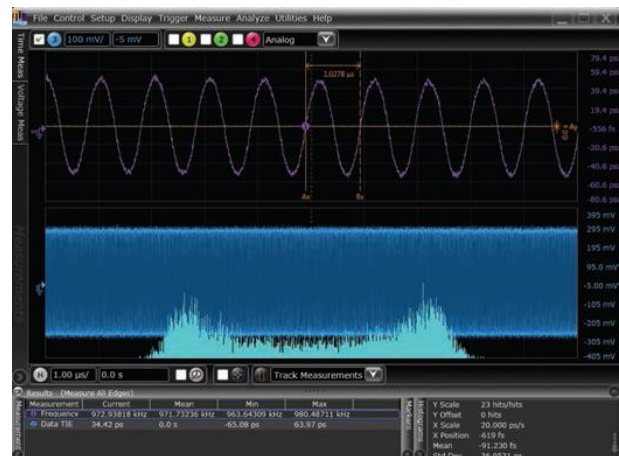

Find signal anomalies, such as power supply coupling



Peak search capability makes Infiniium Offline a frequency domain tool

User-Defined Function Software (Standard)

Combine Infiniium and MATLAB for even more analysis

Enhance the UXR-Series with a seamless gateway to powerful MATLAB analysis functionality. User-defined function software adds new analysis capabilities to the UXR-Series, beyond traditional math/analysis features. Now you have the freedom to develop your own math functions or filters using MATLAB and its Signal Processing Toolbox. With a seamless integration to MATLAB, Infiniium oscilloscopes allow you to display your math and analysis functions live on the oscilloscope screen, just like any other scope's standard functions.

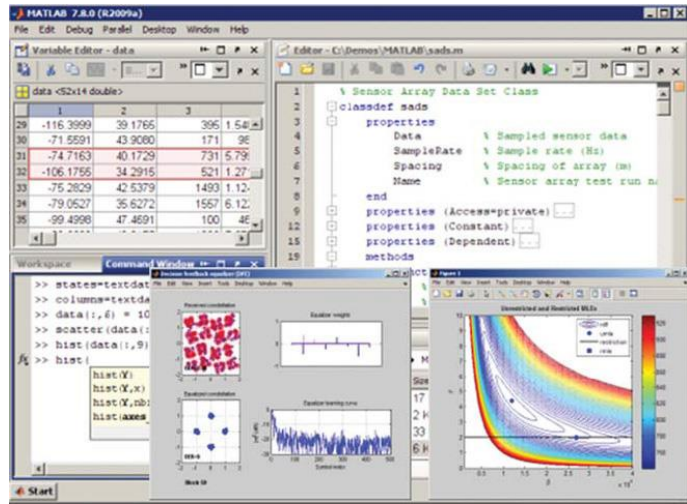

Automation Testing: Switch Matrix Support

Comprehensive testing, easily achieved

Compliance applications on the UXR-Series support a switch matrix, making testing simple by automating tests for each lane of a multi-lane bus. Typical testing requires reconnecting the oscilloscope each time you switch a lane, which causes wasted time and inaccuracies. The UXR-Series solves this problem by supporting switch matrix through its compliance test. Simply connect the switch to the oscilloscope and all the lanes, and then click Run to complete full testing of your entire device.

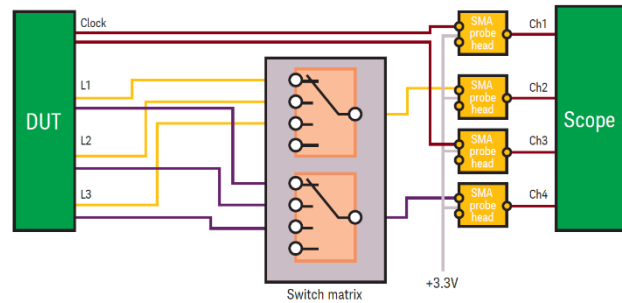

Typical switch configuration for HDMI testing

Maintain accuracy

The framework fully supports Keysight's D9010DMBA De-embedding Software (PrecisionProbe, InfiiniSim Basic, standard in UXR-B). This gives you the ability to characterize every switch path to the device under test (both magnitude and skew) and ensure that all of them maintain the same level of accuracy.

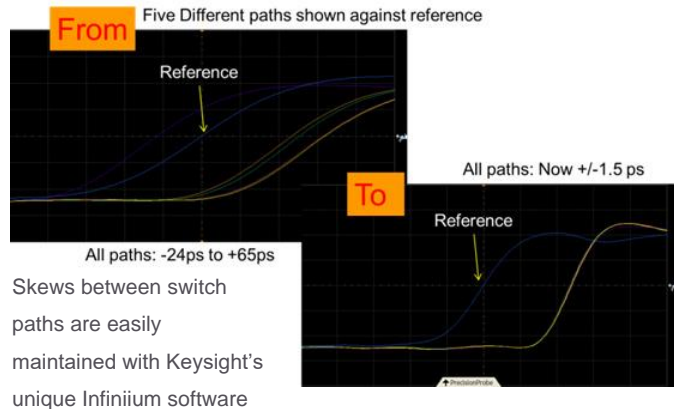

Customize your testing

Use the remote programming interface (standard feature on the UXR-Series) and D9010UDAA User-defined Application for device control, instrument control and test customization.

Compliance and Automated Testing

Today's demanding environment means you have much less time to understand the intricacies of the technologies you are testing. You also have less time to develop and test automation software that is designed to increase measurement throughput and decrease time to market. Compliance applications save you time and money with measurement automation built into the compliance application. No longer do valuable resources need to be exclusively tied to writing automation software. Instead they can be deployed to designing the next big project.

Infiniium's compliance applications are fully functional with design tools such as ADS. Imagine running your waveforms at design through the entire suite of compliance tests, giving more insight earlier than was previously possible. As the design moves to silicon and then to validation, the same suite of tests can be run live on your device.

Compliance applications that run on UXR-Series oscilloscopes are certified to test to the exact specifications of each technology standard. If a test passes on the UXR-Series scope in your lab, you can be assured that it will pass in test labs and at plug fests worldwide. Keysight experts on technology boards and industry standards committees help define compliance requirements. As a result, you can be sure that UXR-Series oscilloscope tools deliver to critical specifications. Setup wizards combined with intelligent test filtering give you confidence you're running the right tests. Comprehensive HTML reports with visual documentation and pass/fail results guarantee that critical information is retained on each test.

Quick and easy automated switching

Only Keysight's UXR-Series oscilloscopes feature compliance applications with both the user-defined application's add-in capability and integrated PrecisionProbe compensation. Switch paths can vary in their characteristics and have unwanted loss. By enabling PrecisionProbe in its compliance applications, UXR-Series scopes allow you to characterize and compensate for every path in the switch, making every path's frequency response identical in both magnitude and phase. These tools make switch automation quick and painless. The UXR-Series and its compliance applications make automation more automated than ever. Your technicians no longer need to spend valuable time physically changing connections.



Compliance applications make testing technologies standards easy

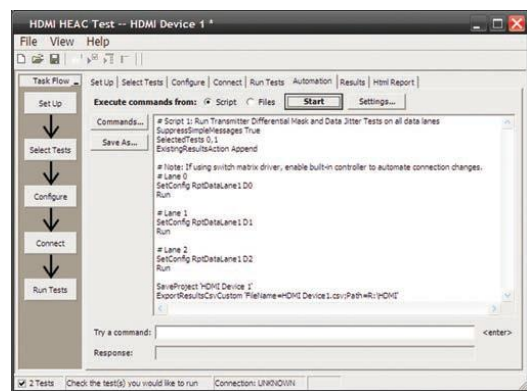

Remote interface makes it easy to control automation



PrecisionProbe is integrated in automation

User-Defined Application D9010UDAA

Custom automation for your UXR-Series oscilloscope

The user-defined application is the only fully customizable automated environment made for an oscilloscope by an oscilloscope designer. It provides full automation, including the ability to control other Keysight instruments, external applications such as MATLAB and your DUT software.

Simplify your automation

The user-defined application (UDA) makes automation simple. The application takes the Infiniium compliance application framework and gives you full access to its interface. UDA allows for automation testing in as little as one minute. Use UDA to control other Keysight instruments such as signal generators and network analyzers to create a full suite of measurements.

Full measurement report

No automation would be complete without a simple-to-view and easy-to-understand report. UDA provides a full report of the pass/fail criteria you have provided.

Add-in capability

Ever wanted to add testing to your compliance applications? All Infiniium compliance applications support the industry's most flexible testing mechanism with UDA add-in capability. Create the custom testing you need and then plug it into your compliance application to expand the application to your testing needs. UDA add-in capability is available only on Infiniium oscilloscopes.

PrecisionProbe and switch compatibility

UDA makes automation of switches in your system simple and accurate. Use PrecisionProbe to characterize the path of the switch and then let UDA's unique GUI switch between every input in your switch system. Every input can look identical in its frequency response thanks to this advanced technology.

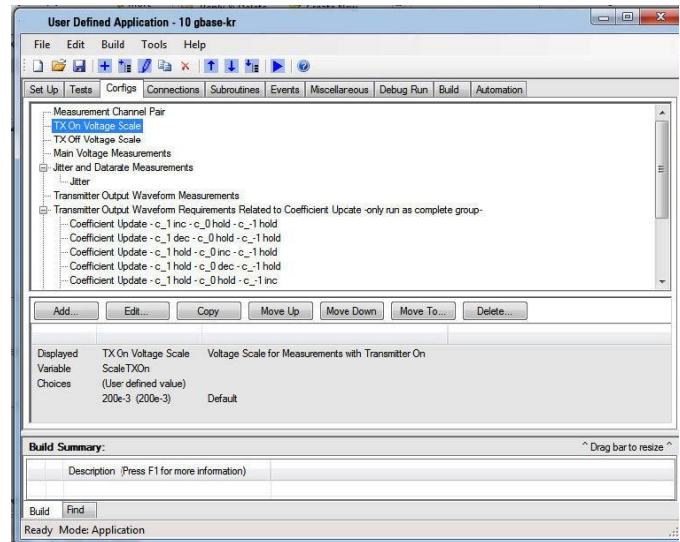

Customize your own tests and requirements with user-defined application in the familiar Keysight framework

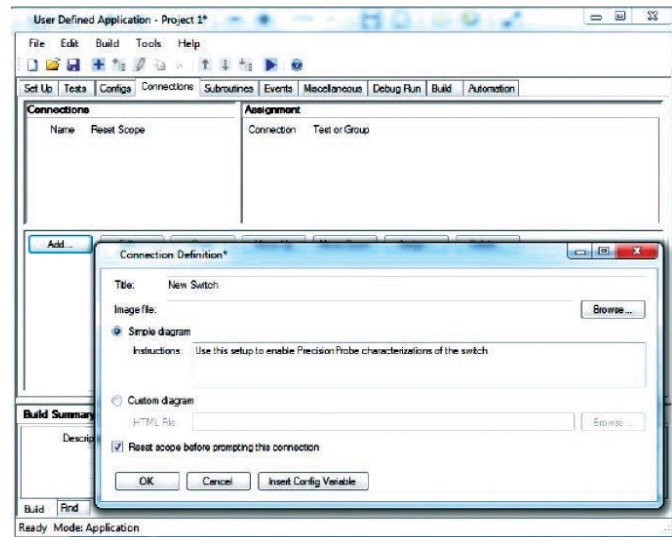

Add a switch when testing your multi-lane signals to automate tedious test requirements

Protocol Analysis

Infiniium UXR-Series oscilloscopes supports more than 20 different advanced protocol decoders, including the industry's first 64/66b decoder. The UXR-Series protocol tools feature time-correlated markers that let you easily move between the listing window and the waveform. Protocol tools can be used on up to four lanes simultaneously.

These unique tools feature search and trigger capability that lets you scan through the waveform to find the trigger condition that interests you. Protocol tools are fully compatible with Infiniium's serial data analysis and are also available on the Infiniium offline tool.



UXR-Series 25 GHz 4-channel model decoding PCI Express Gen 3 packets.

More Information

Thank you for choosing a Keysight UXR-Series Oscilloscope. The Keysight Infiniium UXR-Series oscilloscopes set a new standard for real-time oscilloscope accuracy, with models ranging from 5 to 110 GHz. Extreme signal integrity, 10-bits of vertical resolution and ultra-low noise floor specifications allow for the truest representation of signals. Invest with confidence today, knowing you have the ability to meet the needs of technology advancements tomorrow. For more information on the UXR, check out the following:

- [UXR Datasheet](#)
- [UXR Product Fact Sheet](#)
- [UXR Configuration Guide](#)
- [UXR mmWave and Frequency Extension Datasheet](#)



Keysight enables innovators to push the boundaries of engineering by quickly solving design, emulation, and test challenges to create the best product experiences. Start your innovation journey at www.keysight.com.

This information is subject to change without notice. © Keysight Technologies, 2023, Published in USA, June 12, 2023, 3123-1371.EN